

HANDCRAFT
IN WOOD &
METAL



HOOPER & SHIRLEY



HANDCRAFT

IN WOOD AND METAL

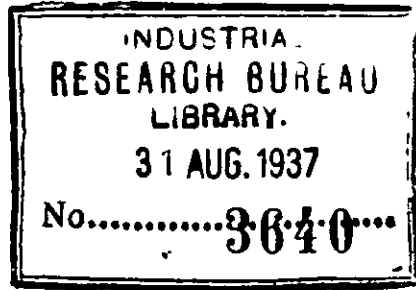

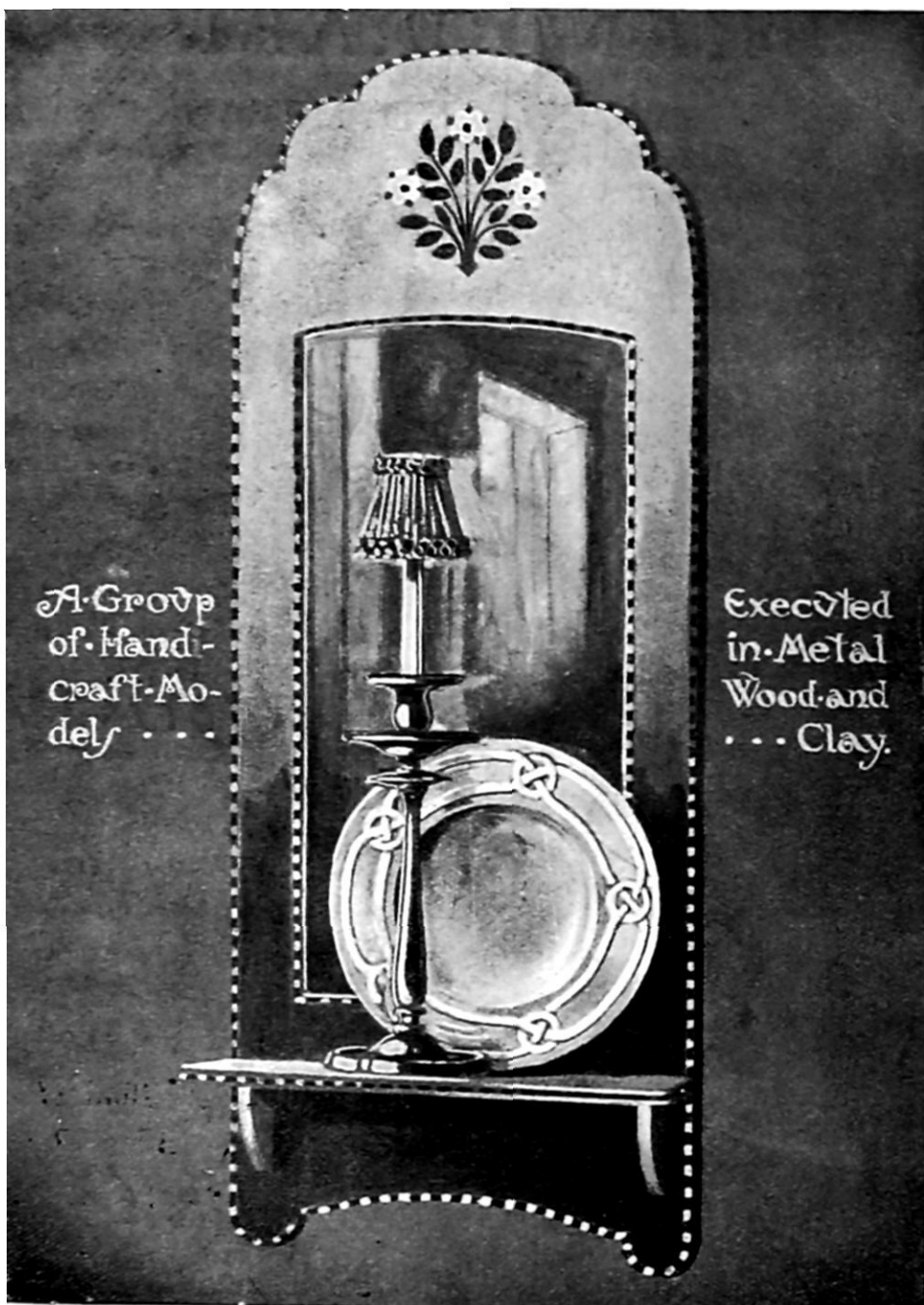

A Group
of Hand-
craft Mo-
dels . . .

Executed
in Metal
Wood and
. . . Clay.

HANDCRAFT IN WOOD AND METAL

A handbook of training in their practical
working for Teachers, Students, and Craftsmen

By

JOHN HOOPER, O.B.E.

*Late Lecturer and Instructor to the London County Council
Joint Author of "Modern Cabinet Work"
Honours Silver Medallist (City and Guilds of London Institute)*

-and

ALFRED J. SHIRLEY

*Technical Inspector and Lecturer on Metal Work to the
London County Council*

With over 300 Illustrations from the Authors'
Drawings and from Photographs, including the
Working Drawings of a Progressive Series of
Decorative Objects

Fifth Edition Revised and Enlarged

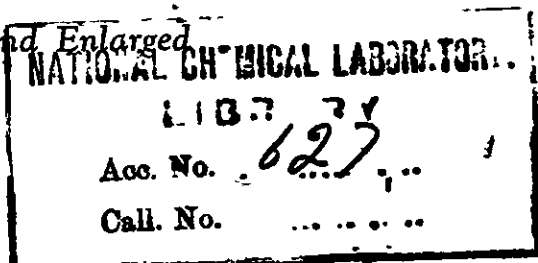

LONDON

B. T. BATSFORD LTD.
15 NORTH AUDLEY STREET, W.1

First Published in 1913
Second Edition, 1925
Third Edition, 1928
Fourth Edition, 1931
Fifth Edition, 1936

THIS WORK IS PUBLISHED IN GREAT
BRITAIN BY B. T. BATSFORD, LTD.,
15 NORTH AUDLEY STREET, LONDON,
AND IN THE UNITED STATES OF AMERICA
BY THE MANUAL ARTS PRESS, PEORIA,
ILLINOIS

MADE AND PRINTED IN GREAT BRITAIN BY
THE ABERDEEN UNIVERSITY PRESS, ABERDEEN

PREFACE TO FIFTH EDITION

THE opportunity has been taken of revising some of the illustrations in the fourth edition, and of adding supplementary chapters in Woodwork, Metalwork, and Woodwork Finishes.

The new examples illustrated in the supplementary chapters should be of value in educational work where examples embodying comparatively simple technique are required. These examples aim at good proportion and simple construction. Various alternatives are indicated, embodying more difficult technique, in the hope that they will be of value to students, teachers, and craftsmen who are interested in fine craftsmanship.

J. H.

A. J. S.

September, 1936.

PREFACE

IN preparing this work the authors have endeavoured to show the possibilities of craftwork as an educational subject, and briefly to indicate its cultural aspects.

One of the prejudices against handcraft or so-called "manual work" has been that it had more value from a physical than an educational or cultural standpoint, with the result that "handcraft" in schools has too frequently been classed as "carpentry".

The authors think that lessons based upon the historical phases of craftwork, particularly in the development of types of construction in furniture and metalwork, and the growth of tools from prehistoric times, together with the study of simple applied art as displayed in historic work, will do much to increase the value of handcraft in schools.

Whilst the work has been prepared primarily for the teacher, the aim has been to render treatment of the subject such as to make the work of value and interest to the craftsman, and a useful guide for the pupil or student. As an aid to class teachers in helping on a technical side in central schools, they hope it will find a place among the books pertaining to craft and general education.

It is hoped further that the work will be regarded as a collection of suggestions and data, rather than an attempt to produce a series of models. The authors believe that at least one aspect of handcraft has been almost entirely neglected in the past, i.e. the artistic side; and, whilst not claiming any special merit for the design of the models dealt with, they have endeavoured to embody some artistic merit in the designs, and have tabooed the meaningless joints and collection of joints which have only a limited mechanical value.

In the early stages, accuracy—whilst being encouraged—should not be too strictly insisted upon. It is a phase which should progress proportionately to the skill of the pupil.

The general impression in the past has been that any attempt at a “freehand” curves or decoration in models necessarily means neglect of the mechanical side, but this does not follow according to the authors experience, and they would deplore the acceptance of this idea.

The main feature of handcraft work after the early stages is individual effort on the part of the pupil, which adds to the interest and value of the subject as a whole.

Much has been said upon “correlation” in handcraft. In well-directed handcraft “correlation” is inevitable. Thinking and doing must perforce be linked together, and when this is done in the class or craft-room it must work toward a better general education.

In elementary handcraft the tendency has always been to depart from traditional methods of construction and processes, but in the authors opinion even the simplest models can be based upon traditional lines, and whether the object of the teacher be vocation or education, due regard to tradition and right methods is essential.

JOHN HOOPER
A. J. SHIRLEY

LONDON,
June, 1913.

NOTE

MANY of the models and lessons in the book were prepared in connection with the authors' duties at the L.C.C. Shoreditch Technical Institute, and they wish to acknowledge the kind assistance of Mr. A. Rowan, of the Teachers' Training Department, in overlooking the text and proofs.

Many of the examples of decorative craftwork shown in the book are due to the excellent facilities afforded by the authorities of the Victoria and Albert Museum, South Kensington: the source of these examples is indicated in the text. The authors also desire to record their appreciation of their publisher's ungrudging help and consideration during the preparation of the original volume and later editions.

Thanks are also extended, in connection with the examples of Swiss peasant art, to Monsieur Henri Martin, of the Swiss Legation; Herren Orell Fusli, Publishers, Zurich, who issue the German Edition of "Swiss Peasant Art," and "The Studio," London. The illustrations of Scandinavian art have been contributed through the kindness of Dr. G. Upmark, the Northern Museum, Stockholm.

In the present edition the authors gratefully acknowledge the permission received from T. Reed, Esq., M.B.E., Principal, to reproduce examples produced at the L.C.C. Shoreditch Training College for Handicraft Teachers, and also the kindness of Dr. Conzelman of the Deutsches Museum in providing photographs of historic German woodworking tools. Our thanks are also due to Messrs. Arthur Balfour & Co., Ltd., of Sheffield, for allowing us to reproduce the Colour Chart on page 217, and to Messrs. Cecil Ern of London for the iron fire screen and panel on pages 169, 173.

The Director of Education for Kent has kindly supplied the plan and photograph of the metalwork shop at the Harvey Grammar School, Folkestone.

CONTENTS

	PAGE
PREFACES	v
NOTE	vii
<small>CHAP.</small>	
I. HISTORICAL NOTES ON WOOD AND METAL	1
II. FIRST YEAR MODELS (WOODWORK)	13
III. SECOND " " "	21
IV. THIRD " " "	34
V. SPECIAL MODELS (WOOD) FOR EVENING STUDENTS AND OTHERS	48
VI. FIRST YEAR MODELS (METAL WORK)	60
VII. SECOND " " "	78
VIII. THIRD " " "	95
IX. SPECIAL MODELS (METAL) FOR EVENING STUDENTS AND OTHERS	107
X. HISTORIC CRAFTWORK AND ITS APPLICATION TO CLASSWORK	129
XI. MATERIAL USED IN HANDCRAFT WORK	138
XII. DRAWING, DESIGN, LETTERING, ETC.	159
XIII. DECORATIVE PROCESSES IN WOOD AND METAL WORK	175
XIV. TOOLS: THEIR EARLY FORMS AND HISTORICAL DEVELOPMENT	201
XV. SUPPLEMENTARY PROCESSES AND DATA FOR OBJECT LESSONS	215
XVI. BUILDINGS, EQUIPMENT, AND TOOLS FOR TECHNICAL AND HANDCRAFT CENTRES	232
XVII. THEORY OF CUTTING ACTIONS OF TOOLS	270
XVIII. WOODWORK FINISHES	283
XIX. SUPPLEMENTARY WOODWORK FOR TEACHERS AND CRAFTS- MEN	290
.GLOSSARY OF WOODWORKING TERMS	305
GLOSSARY OF METALWORKING TERMS	312
INDEX TO TEXT AND ILLUSTRATIONS (WOODWORK SECTION)	319
INDEX TO TEXT AND ILLUSTRATIONS (METALWORK SECTION)	324

HANDCRAFT

CHAPTER I

HISTORICAL NOTES ON CRAFTWORK

NOTE.—The illustrations are numbered consecutively through each chapter, and the numbering of each chapter is independent of the rest. The pages of collected illustrations have one figure number, the separate diagrams being described as *number* one onwards on each page. Thus references to illustrations are as follows (e.g.)—Ch. XIV, f. 12 (8). Diagrams on the figure under discussion are simply referred to by their own numbers on the illustrations thus (6).

I. WOOD.

“I do not think that any man but one of the highest genius could do anything in these days without much study of ancient art, and even he would be much hindered if he lacked it.”—WILLIAM MORRIS.

THE purpose of this chapter is to indicate the extreme antiquity of general craftwork, the very beginning of which can fairly be stated to have commenced when prehistoric man fashioned his primitive weapons and implements for defence, attack, and sustenance.

A study of prehistoric examples of craftsmanship in the various national museums will show their manipulative and artistic skill advanced to a considerable degree. Progress in decoration and manipulation proceeded simultaneously, as is evident from existing examples of their production. The Palæolithic—or Early Stone Age—dates back roughly some 7000 years according to authorities on this subject, although with them the dates of periods can only be conjectured. Following this Age or period are the Copper, Bronze, and Iron Ages, so named because of the materials chiefly employed during these periods. Although the general growth of constructive and decorative craftwork did not proceed simultaneously in all countries, authorities agree that stone preceded the use of metal in practically every part of the world, including all parts of Europe, Egypt, China, Japan, and America, the growth of prehistoric work in each of those countries having definite national characteristics, and worthy of close study by students of

modern handcraft. Space forbids more than a very rapid survey of this aspect of our subject.

The artistic treatment of animal forms during the Early Stone Age is shown in Fig. 1, an engraved bone or mammoth ivory from Trou des Forges, Bruniquel, France, of exceptional artistic interest. It belongs to the Palæolithic Age and is now in the British Museum. Flint and bone appear to have been the chief media employed, but it should be remembered that the perishable nature of wood has naturally acted against the preservation of objects fashioned from this material.

During the Neolithic or later Stone Age we find more instances of wood-working. Actual examples preserved in collections show that wood was used to some extent for handles of flint knives and axes, generally as a supplementary material to the common use of flint. The Bronze Age marks the introduction of a new material and an increased degree of workmanship and artistic skill, due in



FIG. 1.—Examples of animal forms in prehistoric art.

some measure to the use of a more sympathetic material, having less limitations than the preceding media. fine examples of this work being exhibited in the gold room of the British Museum. Canoes and the lake dwellings of the Swiss also point to an extended use of timber. The Iron Age is especially rich in artistic examples, especially of metal decorated with highly coloured enamels.

An interesting feature of this age is the number of bronze celts, which were attached or "hafted" to wooden handles or hafts, and secured by binding with thongs. At the end of this period gold is introduced as a material, The first historical records on which reliance can be safely placed are those of Ancient Egypt, and they provide a fertile source of study. One of the earliest specimens of Egyptian art in wood is that illustrated in Fig. 2, a wood statue of the so-called Shekh el Beled, found in a tomb at Sakkara. Prof. Flinders Petrie, in his "Art and Crafts of Ancient Egypt," says, "the eyes are excellent in form, but affected by the technical detail of inserting the eyeball of stone and crystal in a copper frame," thus indicating an amount of technical skill combined with artistic appreciation, though the latter is not in accordance with modern ideas. Prof. Flinders Petrie also states that the original figure was covered with a coat of

coloured stucco. Of ancient Egyptian furniture there are numerous examples in the British Museum, including workmen's stools, vase stands, a folding stool, and a seat of ebony inlaid with ivory. These display remarkable artistic merit, and show due appreciation of the important factor in modern handcraft, viz. fitness for a given purpose. Technically also these examples are interesting, showing mortise and tenon joints, evidences of the use of glue, and turned work, indicating no small degree of manipulative skill in this branch of handcraft. Two examples are illustrated in Fig. 3. Ebony, acacia, cedar, and sycamore woods were all employed, whilst ivory obtained from the hippopotamus and elephant was utilized for inlaying. Mummy cases, chairs with side arms, caskets, and beds were executed in wood and decorated with inlaying, carving, and painted or stucco decoration. In Greek literature we find considerable evidences of craftwork. Homer's "Odyssey" is especially rich in references, some of which are quoted in later parts of this book. Craftwork was regarded as of importance, as is evident from the following quotation from Book XXIII of the "Odyssey".

Odysseus describing the bride bed to Penelope: "Next I sheared off all the light wood of the long leaved olive, and rough hewed the trunk upwards from the root, and smoothed it round with the adze, well and skilfully, and made straight the line thereto and so fashioned it into the bedpost. And I bored it all with the auger. Beginning at this headpost, I wrought at the bedstead until I had finished it, and made it fair with inlaid work of gold, and of silver and of ivory." The Bible also affords

us numerous evidences of woodworking, the description of the building of King Solomon's temple being noteworthy, as is also the description of his throne. The ark, according to James Napier in his "Manufacturing Arts in Ancient Times," took twenty-five thousand loads of timber in its construction, and the



FIG. 2.—One of the earliest examples of sculpture in wood.

instructions to Noah, "make thee an ark of gopher wood," etc indicates the material employed. In Eastern countries, notably India, craftwork is possessed also of ancient traditions; fine carvings, inlay, and other decoration applied to wood and metal have been for centuries produced in abundance. Omitting prehistoric work in England, and much work produced by the Romans here, craftwork in wood and metal does not appear to have made much headway until the sixteenth century, although previous to that date some noteworthy work in stone, chiefly ecclesiastical, had been produced. Wood and metalwork developed almost simultaneously, most early pieces of British craftwork exhibiting a combination of these materials, characterized by crude craftsmanship and of but little artistic merit. Gothic work is the exception, and following that period the English Renaissance, beginning in the reign of Henry VII, saw English woodwork developed through the rich periods of Elizabeth, James, and Cromwell to the early Georgian era which began with William and Mary and Queen Anne. (These and successive periods cannot be better studied than by personal observation in our museums, or from the numerous excellent treatises devoted to historic English furniture and decorative objects.) Great architects such as Inigo Jones, Sir Christopher Wren, the Brothers Adam, and designer-craftsmen including Grinling Gibbons, Sheraton, Chippendale, and Heppelwhite each contributed to the general development of artistic woodwork in England, and nearly all of them have left writings and drawings of their own, which can be studied in our national libraries and museums.

II. METALS AND METAL-WORKING.

While history has always a sentimental value, it has also an indirect, and at the same time through tradition a very direct, bearing on workshop practice. It is besides very interesting, and no apology is necessary for its introduction here. The study of the development of metal-working, and of the many apparently divergent points of view, adds interest to the story of the origin of many processes common to the jeweller and the decorative metal-worker. Only practical workers in each craft can properly appreciate the wide gap that separates them, but many operations are common to all branches dealing with metal. Filing, drilling, turning, hammering, the use of chisels and punches, etc., are as essential to the jeweller as to the decorative or architectural metal-worker, to the watchmaker as to the shipbuilder. A student capable of performing these operations efficiently and so possessing that proficiency which places him in the class of "skilled" labourers has the chance of entering any industry in which metal plays a part. The knowledge of metal-working, as the many specimens in our museums show, dates back to very early historic times; according to various authorities probably as far back as 4500 B.C., or even earlier.

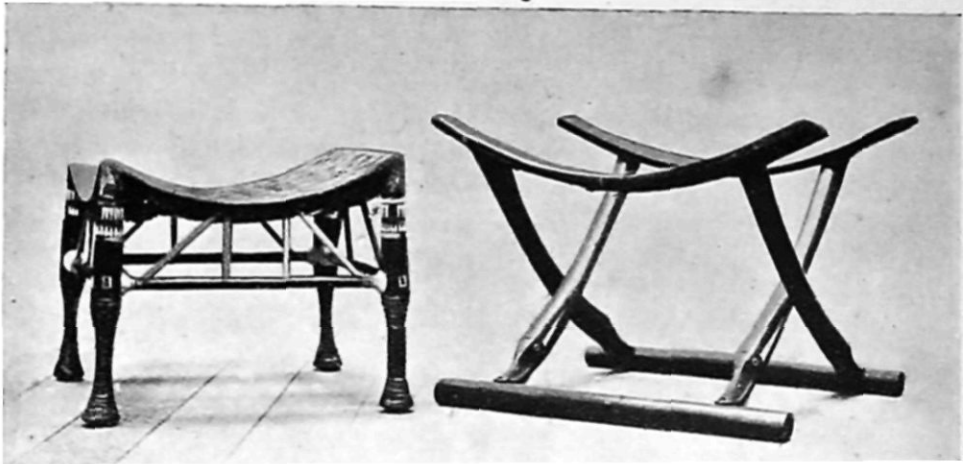

FIG. 3.—Ancient Egyptian stools, one with hide seat, made of inlaid wood.

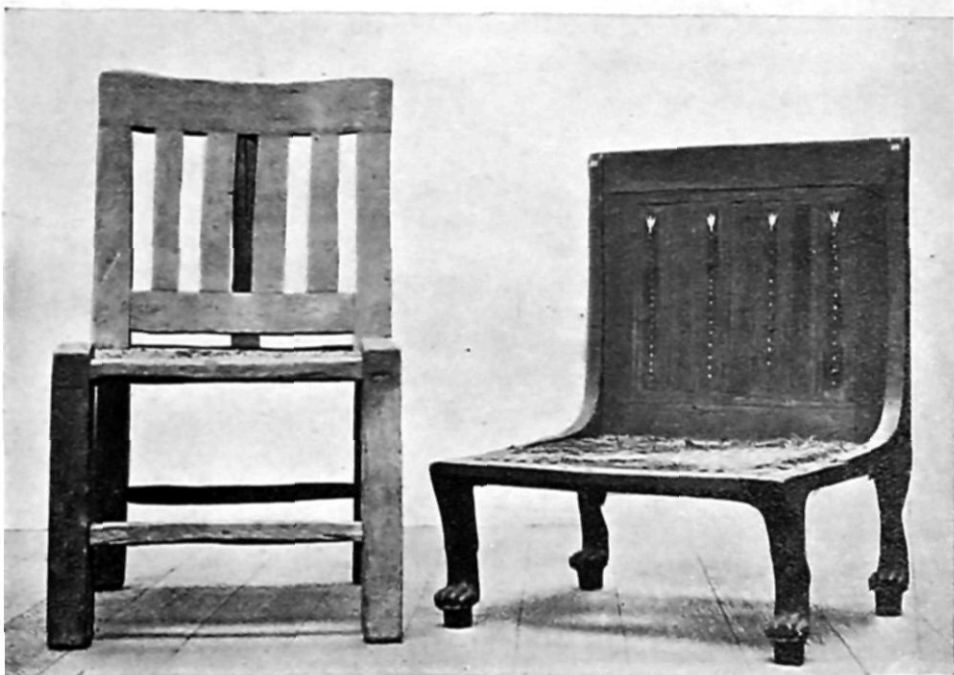

FIG. 4.— Early Egyptian chair and settle, British Museum, showing mortise and tenon joints.

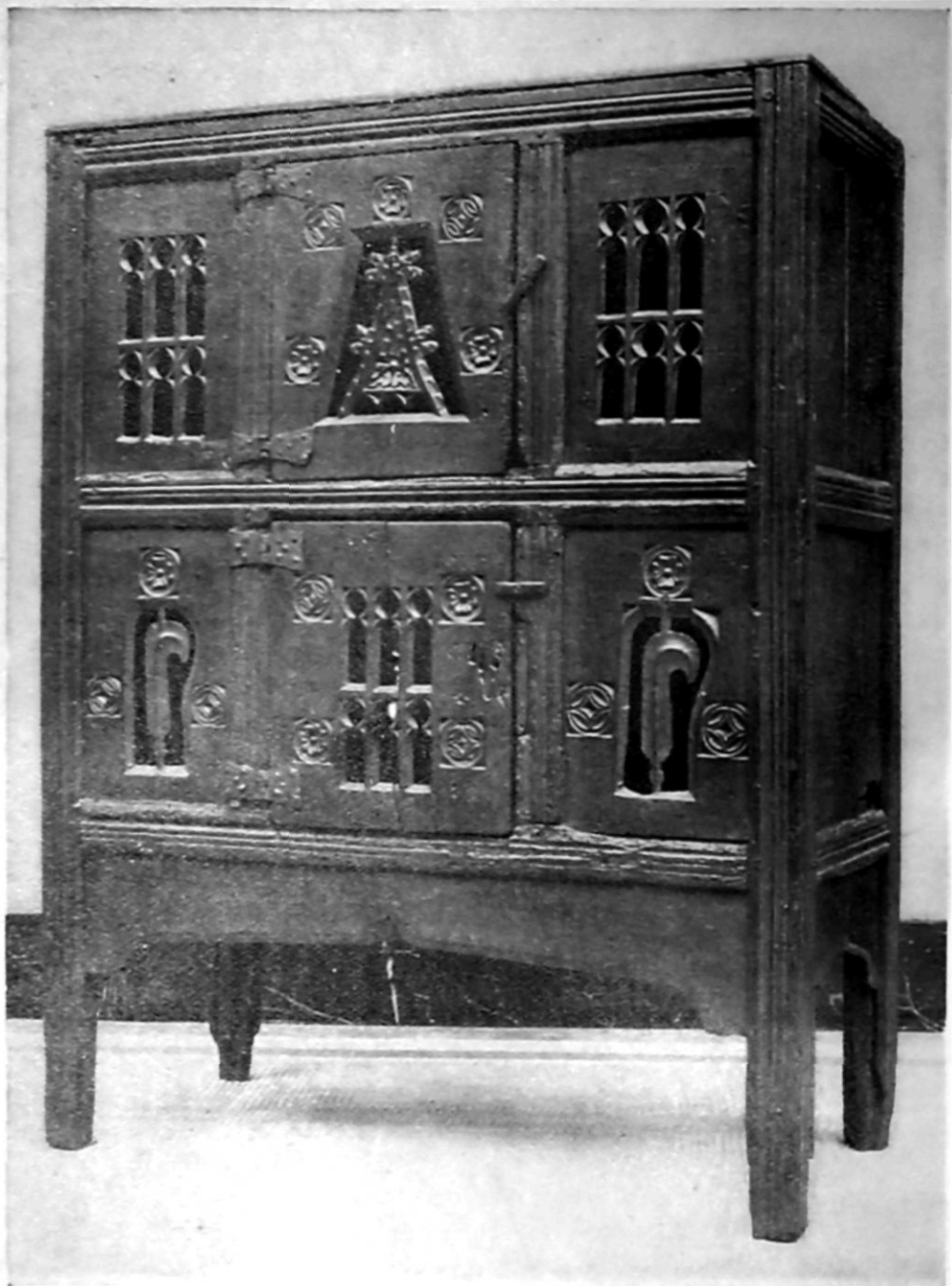

FIG. 5.—English oak livery cupboard, about 1500.

Copper and Gold.—Copper appears to be the first metal generally known and used, although there are evidences that gold was in use in Egypt in 5400 B.C., but the beginning of the uses of metals is known as the Age of Copper.

Copper Age.—How copper was first discovered can only be conjectured, but it was evidently known as a malleable stone, and beaten into shape by stone hammers or pounders.

An inspection of the implement now in the Pitt-Rivers collection at Oxford proves this. It was made from a piece of copper ore, and has, as far as one can judge, not been smelted, but it is evidence of the appreciation and use of metal by a race of people living in the Stone Age.

Following this the search for metals would naturally be developed by slow stages; the uses and methods of shaping this new material would increase until the time arrived when metals could be extracted from their ores, and the art of metallurgy be evolved. The discovery of the various metals marks one of the greatest steps in advancement made by the human race, but it is obvious that all the people in the world would not be equally acquainted with these discoveries at the same time. Nevertheless, the efforts of the early workers who made such advances possible deserve attention.

Mrs. Wooley, wife of the famous archeologist, L. C. Wooley, found a tomb at Ur, approximate date 3,200 B.C., of Prince (?) Mes-kalam-dug, of the first dynasty of the kings of Ur, containing copper tools, plates, silver jugs, an oval bowl of gold with lapis-lazuli handles, copper-bladed dagger with the handle of gold. The name of the owner was engraved on the bowls.

Bronze Age.—During the later part of the time known as the "Copper Age," gold, silver, copper, and tin seem to have been in general use, and this brings us to the period known as the "Bronze Age," which lasted roughly about a thousand years.

During this time the works in metal are remarkable for their excellence, being suitable for their purpose, beautiful in design, and skilfully executed. Many objects were cast as well as wrought, and many pieces were made combining the two processes, as for example, a vase with a beaten body and cast handles which can be seen in the bronze room in the British Museum. The bronze mirrors of the Greeks are artistic examples of skill. Statues of large size were not cast in one piece, but were made by shaping or embossing plates of metal and nailing them on to a wooden core, casting the hands and feet or other small portions separately, then attaching them by cramps and nails.

The face and hands were often carved from ivory and attached in the same way. Statues made in this way, plated with sheet gold and portions of carved ivory added, were known as Chryselephantine work.

Phidias, the sculptor of the Parthénon, was specially famous for statues of this kind.

Metals of many kinds were early very plentiful, and the following verses taken from Homer's "Odyssey," which is supposed to have been written about

eleven hundred years before our era, point to a high degree of skill among metal-workers.

The verses refer to the Palace of Alcinous —

Meanwhile Ulysses at the palace waits
 There stops, and anxious with his soul debates,
 Fixed in amaze before the royal gates.
 The front appeared with radiant splendid gay,
 Bright as the lamp of night or orb of day.
 The walls were massy brass, the cornice high,
 Blue metals crowned, in colours of the sky;
 Rich plates of gold the folding doors encase,
 The pillars silver, on a brazen base;
 Silver the lintels deep projecting o'er,
 And gold the ringlets that command the door;
 Two rows of stately dogs on either hand,
 In sculptured gold and laboured silver stand;
 These Vulcan formed with art divine, to wait
 Immortal guardians at Alcinous' gate.

The description of the arms and shield made by Vulcan for Achilles is full of names of metals and processes.

Among the many objects of bronze in the British Museum are some finely modelled handles with iron cores, a bronze belt-plate inlaid with iron, a bronze handle inlaid with silver, some pale bronze mounts probably from a wooden chest and of very thin material embossed with many kinds of fantastic animals, some simple borderings and bosses mainly worked from the back and in low relief; all these objects are dated about 600 to 400 B.C., and can be seen in the bronze room

The remains of the bronze gates of Shalmaneser II, which are in the basement of the British Museum, are quite an object lesson on the teaching of history by pictorial means carried out in repoussé work on bronze, and these date back to 824 B.C.

There are also some examples of work in wood, bronze, ivory, bone, marble, and alabaster that have been turned in a lathe and are dated about 400-300 B.C., all in the room of Greek and Roman life at the same museum; some enamelled bronze ornaments and many vases, figures, etc., which were cast by the lost wax process, and have never been surpassed for beauty of form or executive ability.

Iron Age.—Iron was now gradually coming into use, but it did not displace bronze to any extent, so that the early "Iron Age" overlapped the later "Bronze Age" in the same way as with the Stone, Copper, and Bronze Ages.

Iron was used largely during the later period of Greek history for strengthening objects, such as bronze castings, handles of bronze shields, and as cramps in buildings, in the partial construction of ships, chariots, and agricultural implements; in fact it was put to much the same uses as at the present day.

Iron was also known to have been in use in Assyria about the ninth century B.C. and in India even earlier. The celebrated wootz, a species of iron and the

material from which the famous Damascus swords were made, is of very great antiquity.

In these early ages its rarity made iron of great value, and in accounts of the battles of the Egyptians, mention is made of its being taken as spoils of war; it was in long, wedge-shaped pieces with holes through to facilitate transport. Uzziah is spoken of in the Bible (2 Chron xxvi. 14) as making shields, spears, helmets, and habergeons (coats of mail or breastplates). Also in Genesis (iv. 22) we read of Tubal-cain the son of Lamech and Zillah, who was an instructor in brass and iron; "brass was probably bronze of a light brown or yellow colour, the metal now called brass was not then known"

Tubal-cain was probably the mythological God known to Homer as Vulcan. There are many references to metals and metal-working in the Old Testament of the Bible, and these portions were written at least as early as 455 B.C.

Lead and Zinc.—At the beginning of the Christian era lead was used largely by the Romans, and zinc first appears in Roman alloys, but it was also known as calamine to the Greeks who used it in the manufacture of brass by simply fusing the calamine with copper. It was not until about A.D. 1720 that zinc was procured in a metallic state by J. Henkle, a German chemist.

Steel.—Steel of some kind was also known and used, being obtained from wootz. As it contained a large percentage of carbon it was very difficult to work. Gold, silver, and bronze were used largely for decorative purposes, and silver was known to the alchemists as luna. In their writings it was represented by the figure of a crescent moon.

The Gauls were very skilful in the manipulation of metals, but the industry was only carried on by "Freemen," and when they died the implements of their craft were often buried with them. The skill of the Britons was evidently as great as that of the Gauls, and if we examine the objects in the British Museum, which were made between the years 250 B.C. and the third century A.D., we can realize the degree of excellence craftsmanship had reached. Byzantium, or Constantinople as it is now called, was noted for its artistic metal-work.

Enamel.—Enamelling on metal is of very ancient origin, and is said to have been first practised by the early Egyptians. Many articles decorated in this manner have been found in Britain, in tombs and what are known as chariot burials, for with the warrior were often buried his chariot, horse trappings, weapons, jewellery, and some vessels of pottery. The work done in Britain at this period by the Gauls or Kelts, known as Keltic work, may be recognized by its graceful flowing curves, rounded surfaces, and "interlacing," as well as by a form of scroll believed to have been derived from the palmette of the Greeks.

First Century A.D.—In the National Museum in Naples there is a remarkable two handled silver cup of the first century A.D., of Greco-Roman workmanship. It has a turned stem with mouldings on the base. This shows that some kind of lathe must have been in use. Iron was in general use in Britain during this century.

Second and Third Centuries A.D.—Copper mines were worked by the Romans in Britain during the second and third centuries A.D., when they made water pipes and coffins from lead, often richly cast in relief, and used iron grilles or cancelli in their churches to separate the choir from the body of the church. In the Victoria and Albert Museum, London, there is a copy of a silver bowl, parcel gilt, Persian, third century A.D.

Fourth Century A.D.—In the British Museum there are some cakes or ingots of pewter stamped with the early Christian symbol of the fourth century, also many lamps of bronze with the symbols worked into the design. These were used for lighting the Catacombs, and there are some finger rings of bronze gilt of the same period. In the Victoria and Albert Museum, London, there are a number of objects of Roman craftsmanship, one a silver salver showing the Emperor Theodosius with his sons Arcadius and Honarius; it was found in 1847 in Estremadura.

During the reign of Constantine altars were made for use in the many churches then being built. They were made of wood covered with silver plates elaborately worked in relief.

Fifth and Sixth Centuries A.D.—Silver spoons inlaid with niello were used during the fifth century, and Byzantine weights of bronze, with their denominations inlaid with silver, were in use during the sixth century. Dagobert King of the Franks possessed a throne of gilt bronze 628-638, a copy of which is now in the Victoria and Albert Museum.

Eighth and Ninth Centuries A.D.—Inlaying of gold with niello was characteristic of the eighth and ninth centuries, and during the tenth century cloisonné enamelling on gold reached a high degree of excellence.

Tenth and Eleventh Centuries A.D.—The tenth and eleventh centuries were the great age of bronze founding, and many of the doors for various cathedrals were made about this time in Constantinople, and exported to various countries. Some were inlaid with silver or niello. Dunstan, Archbishop of Canterbury, 925-988, was an English metal-worker of great skill. It is interesting to note that the sculptors were usually their own founders. Theophilus wrote "Diversarum Artium Schedula" in the early part of the eleventh century.

Twelfth Century A.D.—The Pala d' Ora or altar front at St. Mark's Cathedral in Venice was made in the above city during the twelfth century, and is of gold and silver plate, embossed, enamelled, and encrusted with precious stones. A fine example of English craftsmanship where metal is used to special advantage is the beautiful monument to Queen Eleanor in Westminster Abbey, made by Thomas of Leighton Buzzard in 1294. It consists of a finely modelled bronze figure, with a wrought-iron cresting above, the cresting being an early example of decorative punch-work. It was during the twelfth century that machines, some of which were worked by water-power, were first used, and there are still in existence drawings of drilling, sawing, and stamping machines, screw-cutting lathes, and many jigs, that were drawn by Leonardo da Vinci, the Italian craftsman of the fifteenth century.

Lead has been largely in use since the twelfth century for roofs, spires, statues, fonts, gargoyles, cisterns, etc., but to realize the highest possibilities of lead as a decorative as well as a utilitarian medium many towns in France should be visited, where this material has been utilized to a greater extent than in other countries. In some instances lead was decorated by applying a pattern in pure tin, which, because of its brilliancy, forms an agreeable contrast with the dull lead, and it is not affected by the weather.

Thirteenth Century A.D.—During this century was cast the great bronze Buddha at Kamakura, Japan. It is unique amongst Japanese works of art. It was cast in bronze by Ono Goroemon in 1252, its height is 50 ft., and circumference 98 ft., length of face 8 ft. 5 ins., eye 3 ft. 11 ins., nose 3 ft. 9 ins. Eyes of pure gold. It was cast in pieces and the parts brazed together. Inside there is a small shrine, and visitors can ascend into the head.

Fourteenth Century A.D.—This was a great age for memorial brasses, many of which are still in existence. Flemish work was the best. The use of lettering as a decorative feature should be noted.

Fifteenth and Sixteenth Centuries A.D.—Cast Iron.—Between the twelfth and sixteenth centuries Spain produced some exceedingly rich iron-work in the form of *rejās* or screens; but very little decorative iron-work was done in England owing to the scarcity of skilled smiths. About the fourteenth century cast iron came into use, and was smelted with charcoal in Sussex, a large quantity of cast iron being produced in that county. Cast-iron fire backs were produced largely from furnaces in Sussex, Kent, and Hampshire. Some exceedingly fine silver work was made during this period, and can be seen in exhibitions that are held occasionally by private owners.

Seventeenth and Eighteenth Centuries.—Wood becoming scarce, owing to being used (in the form of charcoal) for the production of cast iron, an Act of Parliament was passed during the reign of Elizabeth limiting the erection of furnaces and the use of wood above a certain size for this purpose; consequently the production decreased until the end of the seventeenth century, when the use of pit, or sea coal as it was called, became more general. Even then the quantity produced was very small, and it was not until the method of making coke from coal was invented, about the middle of the eighteenth century, by Abraham Darby, that the commencement of the manufacture of cast iron on a large scale began. The art of tinning iron plate was introduced from Germany by Andrew Yarranton. Rolling and puddling of iron did not come into use until the eighteenth century. These processes were invented by Cort in 1783. Watt's steam engine was invented in 1769.

It was during this century that a method of making cast steel of a uniform texture was invented by Mr. Huntsman of Sheffield, in 1770, and the process was soon in use in various parts of England for the manufacture of steel for cutting tools. Previous to this many cutting tools were imported from the continent.

Nineteenth Century.—The commencement of the nineteenth century was remarkable for the great number of inventions in connexion with metals, but that of H. Bessemer, afterwards Sir H. Bessemer, for producing steel from cast iron by means of the converter invented by himself was the most notable, and at the present time steel made by his process has largely superseded wrought iron. However, the Bessemer process has seen its best days and its place taken by the process known as the Siemens-Martin process in which a regenerative furnace is used. This was followed by the Gilchrist-Thomas basic steel process. Modern developments now tend towards the use of the electric furnace, and with the production of cheap current the blast furnace will no doubt pass into the list of obsolete and antique methods of producing iron.

Aluminium.—The discovery by Wöhler, a German chemist, in 1828, of aluminium has had far-reaching results, although it is only of late years that this metal has been usefully applied. This is due largely to the improvement in electric furnaces, consequent increased production, and lower working costs.

Alloy Steels.—Attention should be drawn also to the pioneer work of Michael Faraday—the inventor of these steels—who experimented with them from 1819 to 1824, although at the time they were not used commercially.

Aluminium.—The discovery by Wohler, a German chemist, in 1828, of aluminium has had far-reaching results, although it is only of late years that this metal has been usefully applied. This is due largely to the improvement in electric furnaces, consequent increased production, and lower working costs.

Twentieth Century.—This century is remarkable for the large number of inventions relating to metals and metal working.

The process of air hardening and the use of alloy steels were introduced. Stainless steel was produced by Thomas Firth & Sons of Sheffield. There was a great advance in the use of nickel and chromium alloys and alloys of aluminium for internal combustion engines, motors and aircraft. Dr. Hans Goldsmidt invented the Thermit welding process (see p. 225).

Gas and gas-fired furnaces were employed for the cutting, melting and heat treatment of metals. We find an oxy-coal gas cutting machine which will cut iron up to 8 ins. thick at a speed hitherto unknown except in wood cutting. Oxygen and acetylene gas were used for a new process known as "blowpipe welding".

A feature of the century is the development of stamping, cutting and folding presses, drop forging hammers, and moulding machines for producing large quantities of moulds of the same pattern used in casting metals. The centrifugal casting of iron pipes by the De Lavaud process was first practised in this century at the Stanton ironworks near Nottingham, England (see p. 231). This method of casting iron pipes is preferable to other methods in that stronger, thinner and more uniform pipes can be produced cheaply. The increase in the use of oil has created a large demand for iron pipes to transport oil long distances at low costs.

CHAPTER II

FIRST YEAR MODELS (WOOD)

RULER, FLOWER-STICK, AND KEY RACK (Fig. 1).

Object.—Models designed chiefly to introduce exercises in planing and sawing.

The Process.—Round Ruler.—For class work, one piece of wood $12 \times \frac{7}{8}$ in. square should be issued to each student. A finely set jack plane should be used for the planing process.

1. Plane up face side and edge. 1a. Pencil face marks on material (straight edge to be employed for testing the above planing).

2. Set marking gauge, and gauge the material for width and thickness.

3. Set out octagon on each end, as per diagram (second step).

4. Plane to octagonal shape (see diagram, second stage).

5. With smoothing plane complete the planing to circular section.

6. Finish with glass paper and saw off ends to finished length.

Flower Stick.—1. Plane to width and thickness one piece yellow deal, $15 \times \frac{3}{4} \times \frac{1}{4}$ in.

2. Set out pointed end, also semicircular top.

3. Saw bottom and corners off top, compare latter by paring.

4. Execute notches by cutting with firmer chisel.

Key Rack.—1. Prepare one piece of American whitewood, $10\frac{1}{2} \times 2\frac{1}{4} \times \frac{1}{2}$ in. = $26 \times 6 \times 1.2$ cm.

2. Plane up face, side, and edge. 2a. Plane and gauge to width and thickness.

3. Mark out the semicircular ends. 3a. Cut same with dovetail saw (see Fig. 1).

4. Pare down to lines with firmer chisel. 4a. Prepare a specimen of chamfering.

5. Set out and execute chamfering on key rack with file.

Note.—In the second and third examples dealt with above, chamfering is employed as the simplest kind of ornament, and permits of individual effort in designing same. For class work an extra piece of wood can be issued and the pupils encouraged to suggest treatments, limiting them to the use of a file and small chisel. A demonstration showing one or two different types should precede their efforts. The hooks can be placed vertically as shown or horizontal for large keys, when the rack is, of course, also fixed in a horizontal position.

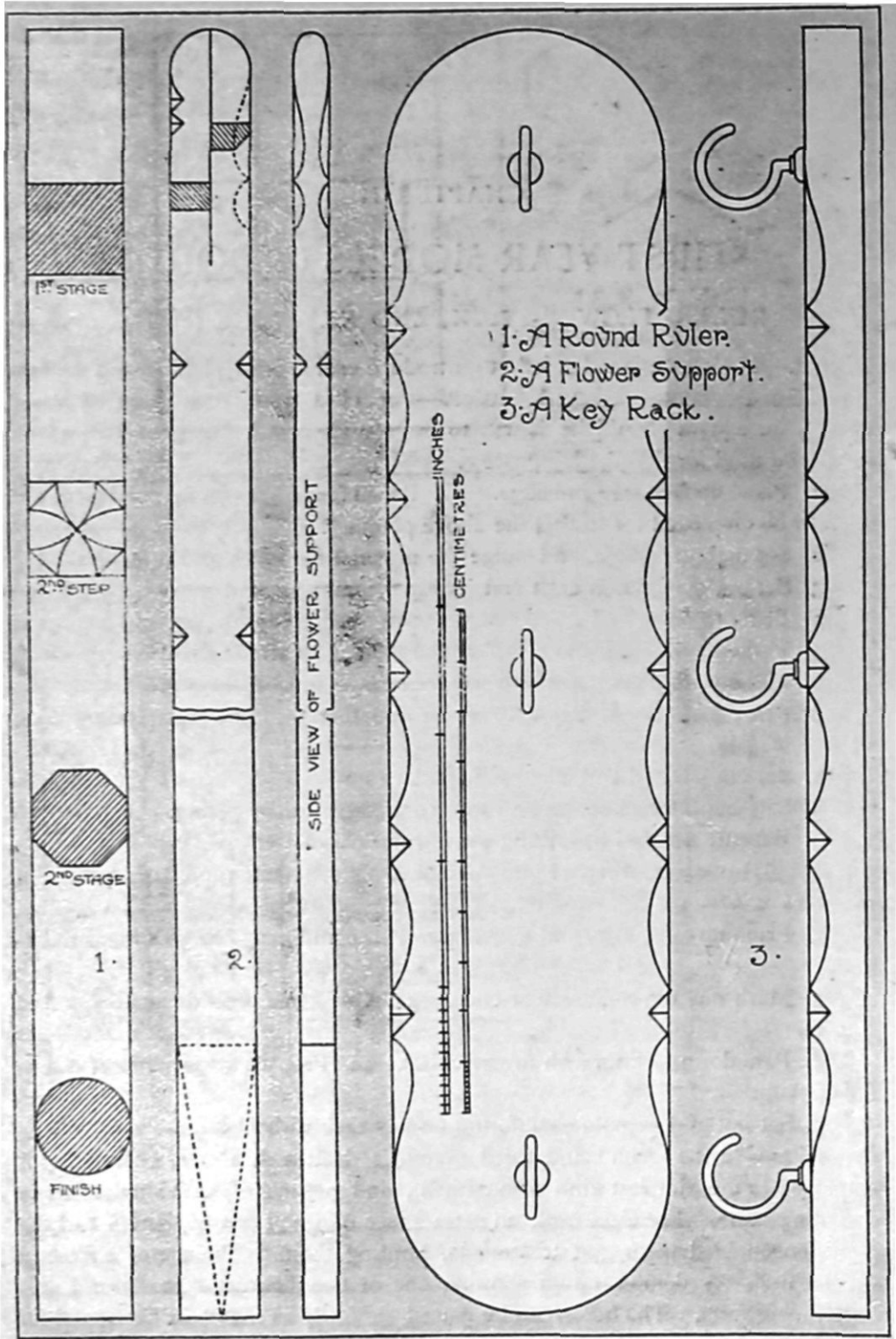

FIG. 1.

A HALF-LAPPED FRAME (Figs. 2, 3, and 4).

Object.—To illustrate the application of a previously constructed joint, i.e. half-lapped joint, to a simple woodworking model. The decoration provides

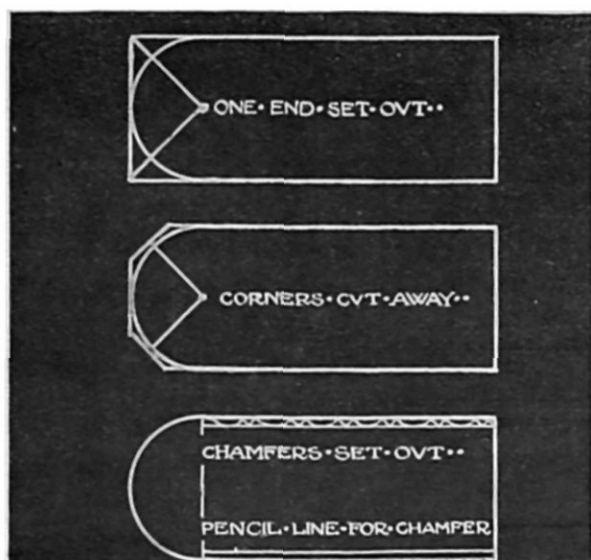

FIG. 2.

an opportunity for tasteful treatment, and can be of various kinds, viz. gouged, chiselled, in'aid, or stencilled.

The Joint should be made first as an exercise, the procedure for which is as follows:—

1. Plane up one piece American whitewood, $12\frac{1}{2} \times 2\frac{1}{4} \times \frac{7}{8}$ in. = $31.5 \times 5.7 \times 2.2$ cm.

2. Mark face edge, shoot same, gauge and plane to width and thickness.

3. Pencil cross centre line in wood. Saw across.

4. Fix one piece in stops,

mark width of the other piece at centre square lines across with marking knife. Repeat with second piece.

5. Square lines on edges, and gauge half-thickness on edges (gauge lines must be made from face side).

6. Cut lines with dovetail saw, and remove waste of each piece.

The Frame.—1. Cut out 4 pieces of American whitewood, $12\frac{1}{2} \times 1\frac{3}{4} \times \frac{7}{8}$ in. = $31.5 \times 4.5 \times 2.2$ cm.

2. Plane up face, side, and edge of each piece.

3. Gauge and plane up all pieces to width and thickness.

4. Fix all pieces in bench stop. Set out lines (A, B, C, D, E, F, Fig 4) on edges with marking knife.

5. Separate pieces. Square lines on two pieces on face side. Square lines on two pieces on back side.

6. Gauge half-thickness on edges for joints from face side.

7. Cut inside line with dovetail saw, remove waste with firmer chisel.

8. Fit together and glue up. When dry level off on both sides.

9. Mark rebate on inside of frame on back, cut same with chisel.

10. Proceed with decorative work (see alternate treatments on page 16).

The Decoration must at such an early stage be easy of execution. The first kind shown is single gouge cuts on the edge of the frame; this is best executed by holding the gouge in position with the left hand, striking

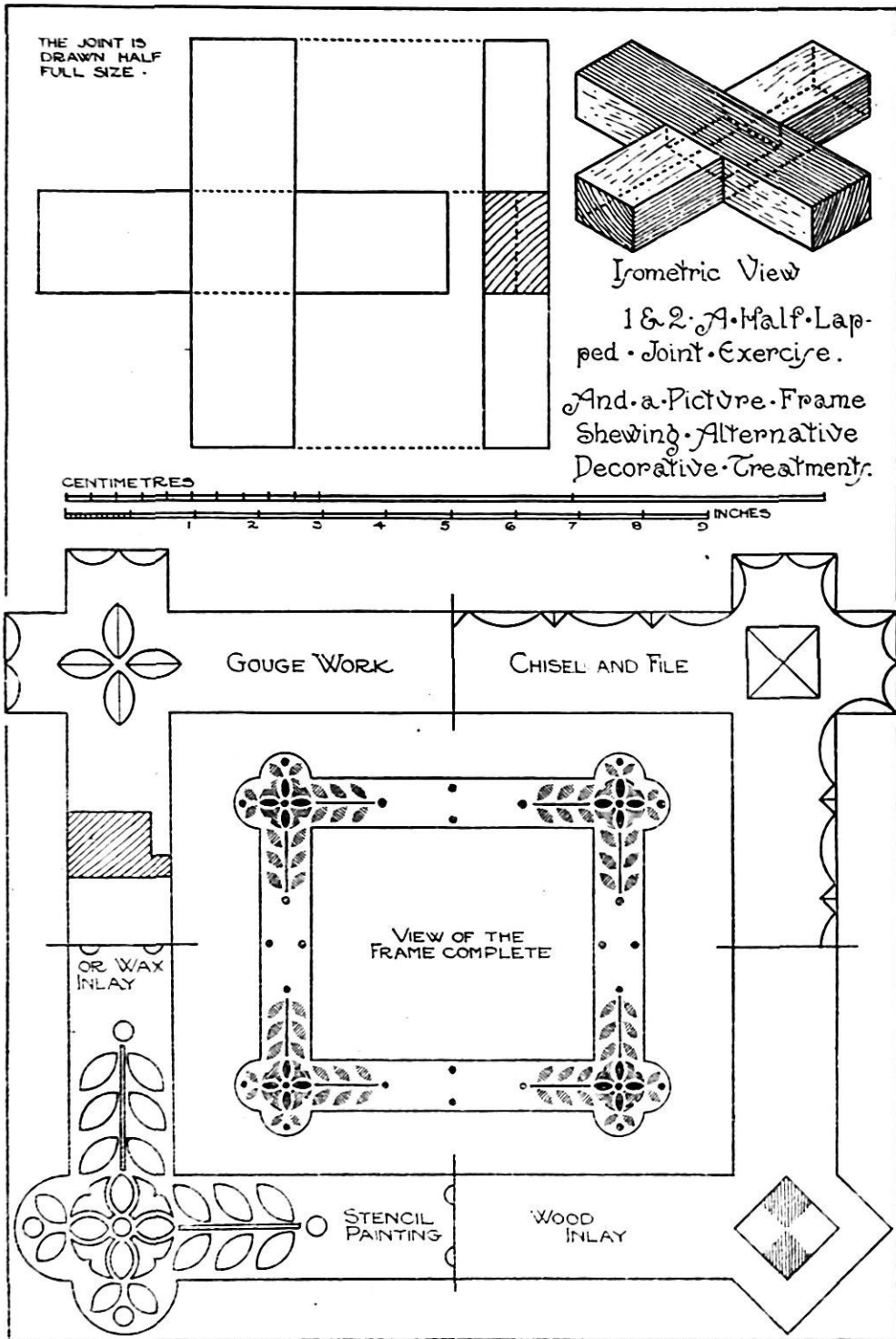

FIG. 2.

it smartly with the palm of the right hand. Eight cuts are then made in each corner to form the device shown.

The second treatment shown is executed on the edges with gouge and chisel; the corners have a simple recessed device.

The third treatment illustrates a stencilled pattern, which can be executed by drawing the design on paper, cutting the required portions away by means of gouge cuts (for stencilling refer also to bottom of this page).

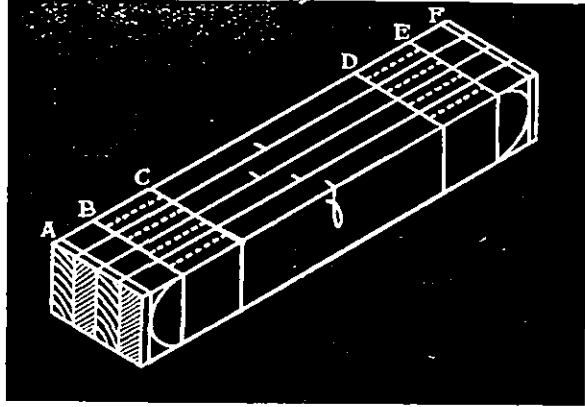

FIG. 4.

The fourth treatment consists of two differently coloured woods arranged our in a square. These should be cut from $\frac{1}{8}$ in. wood and glued—like mosaic—into the groundwork.

The Outlines of the third and fourth examples vary; these should be set out geometrically and finished by paring with a firmer chisel.

WATCH STAND (Fig. 5).

Object.—A model to introduce simple sawing, planing, chiselling, and filing (if curve of back is considered undesirable a straight line can be substituted), also as an exercise in stencilling.

Material.—

	<i>English.</i>	<i>Metric.</i>
1 piece American whitewood,	$8\frac{1}{4} \times 3\frac{5}{8} \times \frac{1}{2}$ in.	$20\cdot3 \times 9\cdot1 \times 1$ cm.
1 piece " " "	$3\frac{3}{4} \times 2\frac{3}{4} \times \frac{1}{2}$ in.	$9\cdot5 \times 7 \times 1$ cm.

The Process.—1. Saw out and *smooth* up material as above.

2. Plane one edge of front, gauge, and plane to width.

3. Mark out semicircular head of front piece.

4. Mark bevel at bottom, cut same with dovetail saw.

5. Set out the support as per Fig. 5.

6. Cut head to shape, removing corners with saw; pare away to line with firmer chisel.

7. Cut *straight* back with dovetail saw, finish bottom with gouge.

8. Nail together, holding back in bench vice.

The Decoration, as illustrated, is simple stencilling; the design should be executed on stiff cartridge paper, then cut out with a sharp penknife. The paper is then placed upon the front and held perfectly flat whilst the colour is dabbed upon it with a brush.

Notes.—For class work, simple vee tooling could be substituted for the stencilled design. Painting the whole stand would improve the model; dark green with white or red stencilling are suitable treatments.

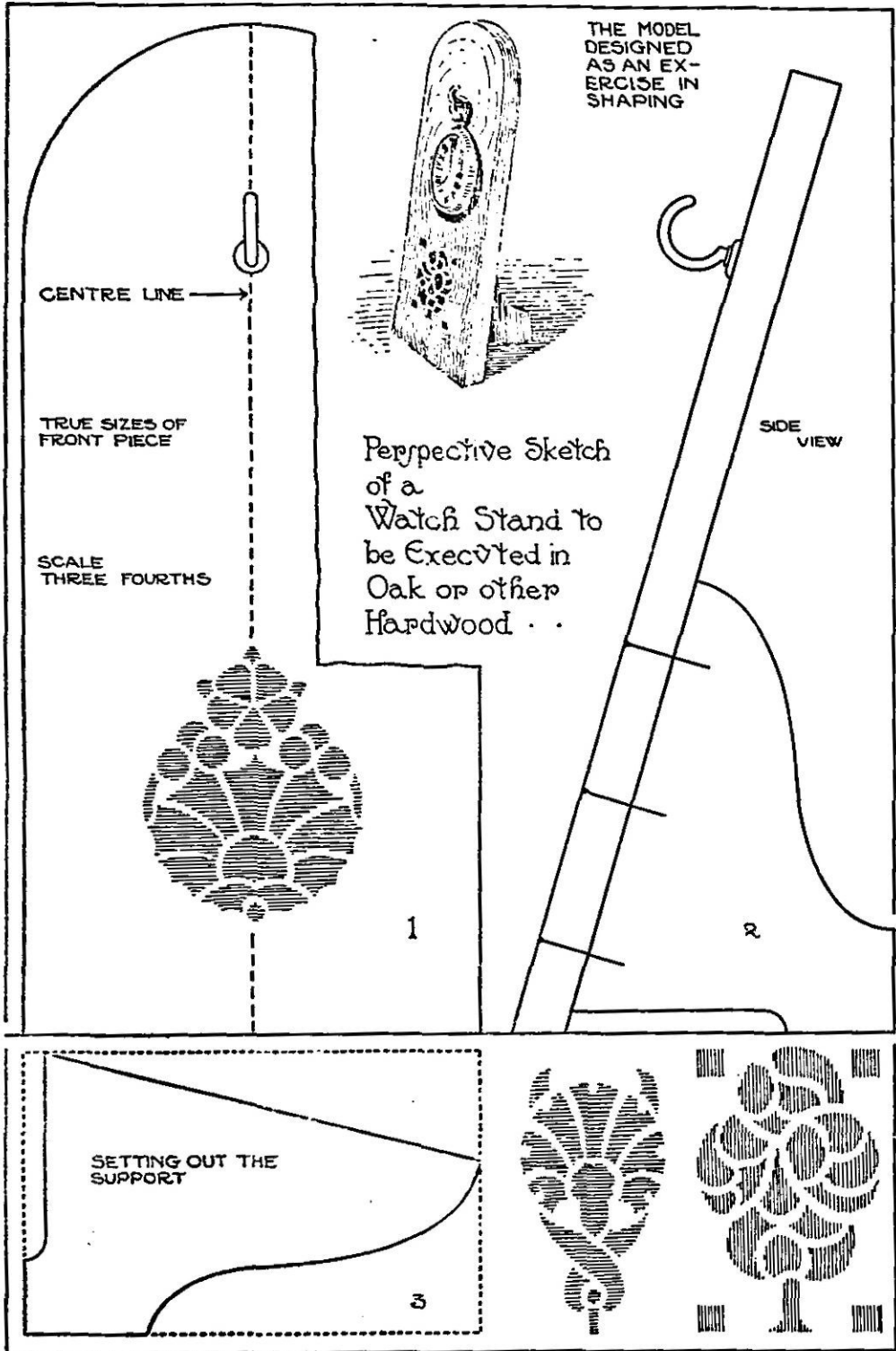

FIG. 5.

A simple geometrical arrangement of spots is also effective; this could be done by boring $\frac{1}{8}$ in. holes about $\frac{1}{8}$ in. deep, filling in with coloured wax. (This process is further described on pp. 130 and 182.)

PIN AND PEN TRAYS (Fig. 6).

Note.—Nos. 1 and 2, and the perspective sketch on p. 20, illustrate a pen tray, to be executed in American whitewood, and designed in order to introduce sawing, planing, and gouging. No. 3 is the sectional view of a more advanced type, involving the addition of bevelling and a thin moulded base. A cavetto or hollow moulding is a suitable alternative detail for this model. No. 4 is a further development of the above types. Mahogany is suggested for the pen tray proper with ebony feet. A mosaic edging should be worked round the top edges, which is further illustrated and described on p. 180. Satinwood and ebony is a suitable colour combination when mahogany is used for the groundwork. Nos. 5 and 6 illustrate an alternative model for the first year, introducing processes similar to the first example. The further development of this type could proceed upon the lines indicated above in connexion with the pen tray.

Material required for the four models (cutting sizes):—

Nos. 1 and 2 :	<i>English</i>	<i>Metric.</i>
1 piece American whitewood,	$10\frac{1}{2} \times 2\frac{1}{2} \times \frac{7}{8}$ in.	26·6 × 6·4 × 2·25 cm
No. 3 :		
1 piece American whitewood,	$10\frac{1}{2} \times 2\frac{1}{2} \times \frac{7}{8}$ in.	26·6 × 6·4 × 2·25 cm
1 piece „ „	$11 \times 2\frac{7}{8} \times \frac{1}{4}$ in.	28 × 7·3 × ·6 cm
No. 4 :		
1 piece American whitewood	$4\frac{1}{2} \times 3\frac{1}{4} \times \frac{7}{8}$ in.	11·4 × 8·2 × 2·25 cm
Nos. 5 and 6 :		
1 piece Cuba mahogany	$10\frac{1}{2} \times 2\frac{1}{2} \times \frac{7}{8}$ in.	26·6 × 6·4 × 2·25 cm.
1 piece Ebony	$4\frac{1}{2} \times 1\frac{1}{4} \times \frac{1}{4}$ in.	11·4 × 3·2 × ·6 cm

The Process (for pen tray. Nos. 1 and 2).

1. Saw out, and plane material to finished thickness, length, and width.
2. Square across pencil lines corresponding to semicircle centres.
3. Describe the semicircles as shown in No. 1.
4. Prepare a $\frac{1}{8}$ in. cardboard templet as shown in No. 2.
5. Gouge away the centre part, testing frequently with templet.
6. Finish inside with glass paper, plane and finish the round edges.

Process (for pin tray. Nos. 5 and 6).

1. Saw out, and plane material to finished thickness, length, and width.
2. Draw centre lines on face side, mark axes of ellipse.
3. Prepare a paper trammel and describe ellipse.
4. Gouge away the inside part and finish with glass paper.
5. Round edges and finish.

The use of glass paper in connexion with the above models may in the first year be considered undesirable and omitted.

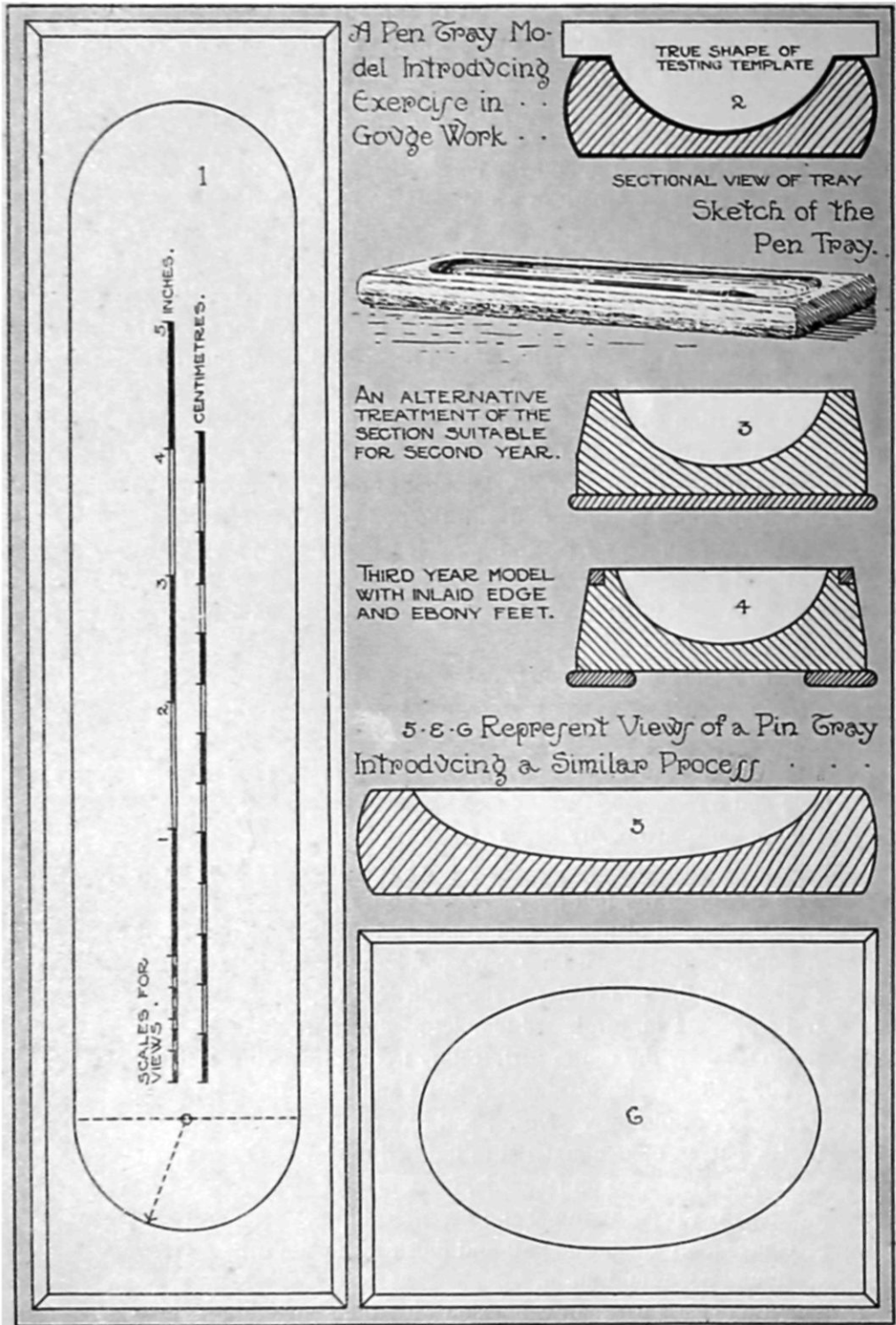

FIG. 6.

CHAPTER III
SECOND YEAR MODELS (WOOD)

KNIFE BOX (Fig. 1).

NOTE.—The knife box, detail drawings of which are shown in Fig. 1, perspective

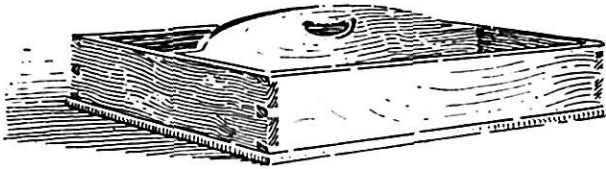

FIG. 2.

sketch in Fig. 2, should be made of American white-wood or yellow pine. If used for spoons, forks, etc., mahogany would be a more suitable material, the inside lined with green baize.

The Joints at the corners, viz. through dovetails, are illustrated opposite. It is recommended that one corner be taken as an exercise before proceeding with the complete model. A housed joint is used to connect the centre piece with the ends. The procedure for this is as follows:—

1. Plane up to thickness and square to size two pieces American whitewood, $6 \times 2\frac{1}{2} \times \frac{1}{2}$ in.

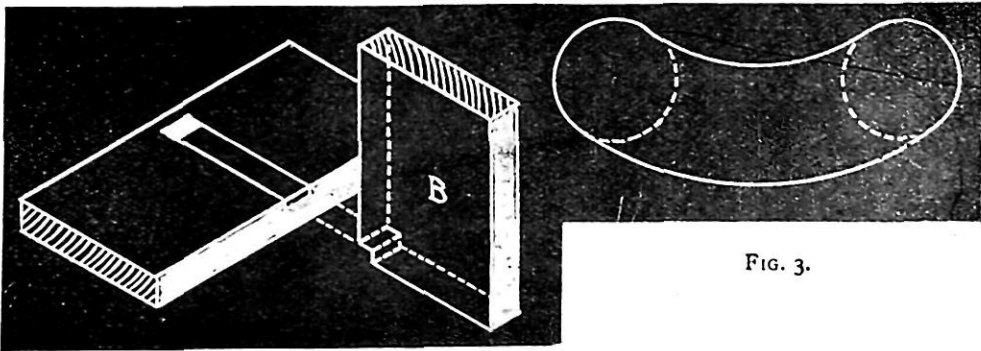

FIG. 3.

2. Square two lines across piece A, gauge $\frac{1}{4}$ in. deep on edge.
3. Cut away blackened part of diagram $\frac{1}{4}$ deep with firmer chisel. This permits the entrance of a dovetail saw and allows saw cuts to be made the required depth.
4. Remove waste, cut shoulder on piece B, and fit together.

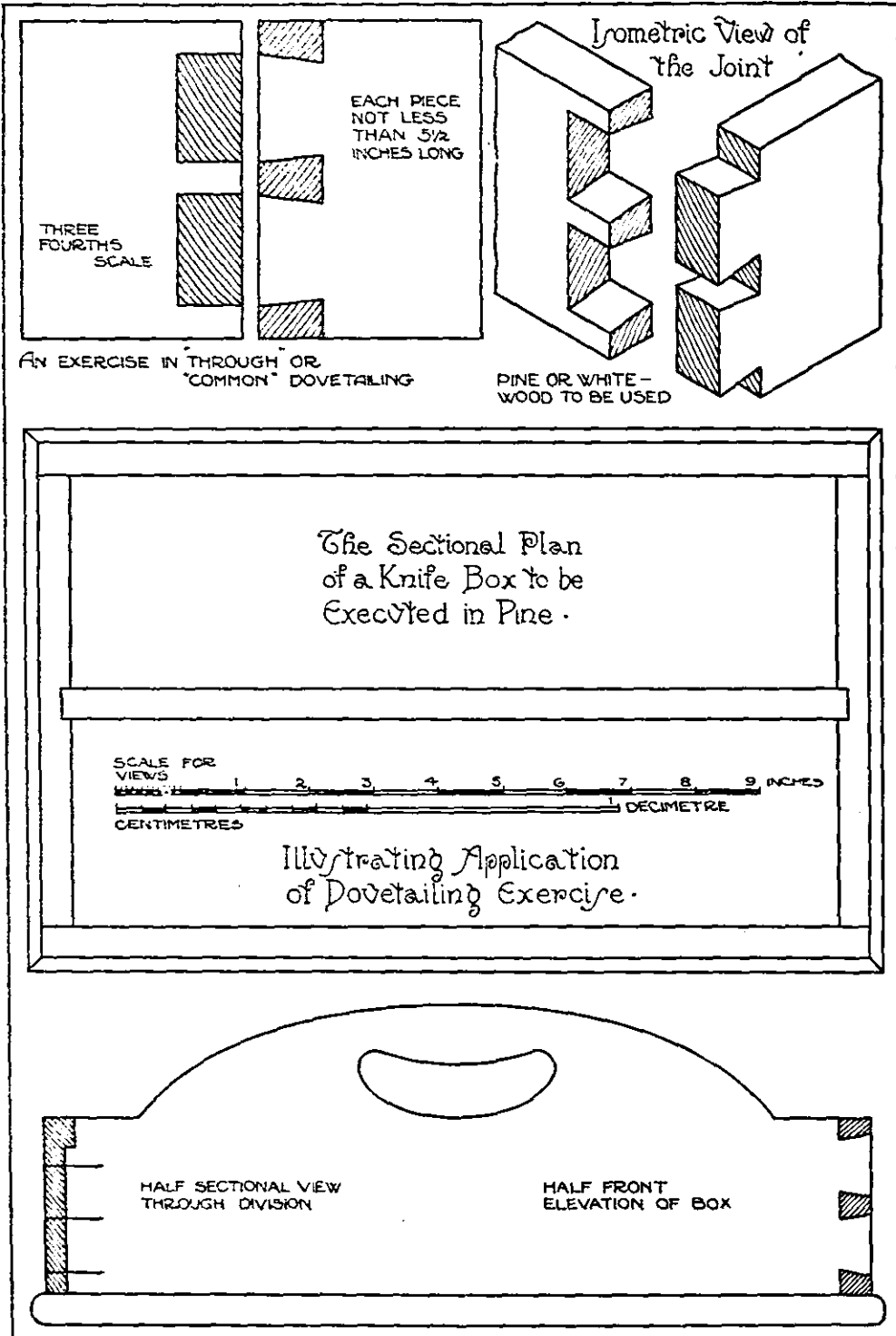

FIG. 1.

Description of Fig. 1 (continued).

The Process.—1. Saw out and plane to thickness the following material :—

	<i>English.</i>	<i>Metric.</i>
1 Bottom	1 ft. $1\frac{1}{2} \times 8\frac{1}{2} \times \frac{7}{16}$ in. yellow pine	$34.5 \times 21.5 \times 1.2$ cm.
2 Ends	$8\frac{1}{2} \times 3 \times \frac{7}{16}$ in. „	$21 \times 7.5 \times 1.2$ cm.
2 Sides	1 ft. $1\frac{1}{4} \times 3 \times \frac{7}{16}$ in. „	$33.5 \times 7.5 \times 1.2$ cm.
1 Division	1 ft. $0\frac{1}{2} \times 4\frac{3}{4} \times \frac{7}{16}$ in. „	$31.5 \times 12 \times 1.2$ cm.

2. Shoot face edges of all pieces, plane to length and width.
3. Gauge for dovetailing, mark and cut same.
4. Set out and cut housed joints in division as per above.
5. Set out division, also hand hole as per Fig. 2 ; and work same.
6. Glue up model ; when dry, level off and fix in division.
7. Round edges of bottom and screw same to box.

A CLOCK CASE (Fig. 4).

Object.—To produce a useful model embodying very elementary processes, viz. sawing, smoothing, shooting, grooving, and nailing. An American clock is utilized for the movement. This must have three small ears or flanges soldered to the sides (see sectional and back view) which provides for the necessary fixing. The bottom curve may be dispensed with if necessary.

The Process.—1. Prepare a working drawing of the model upon a $\frac{1}{4}$ imperial sheet of cartridge paper, viz. full front elevation and a sectional view.

2. Prepare also a cutting list or timber sheet from the drawing.
3. Saw out and plane up smooth the following material :—

	<i>English.</i>	<i>Metric.</i>
1 Front	whitewood, $10\frac{1}{2} \times 5\frac{1}{2} \times \frac{3}{8}$ in.	$27 \times 14.5 \times 1$ cm.
2 Sides	„ $10\frac{1}{2} \times 3\frac{3}{4} \times \frac{3}{8}$ in.	$27 \times 9.5 \times 1$ cm.
1 Back	„ $10\frac{1}{2} \times 5\frac{1}{2} \times \frac{3}{8}$ in.	$27 \times 14.5 \times 1$ cm.
1 Top	„ $6\frac{3}{4} \times 4 \times \frac{3}{8}$ in.	$17 \times 10 \times 1$ cm.
1 Bottom	„ $5\frac{3}{4} \times 2\frac{3}{4} \times \frac{3}{8}$ in.	$15 \times 7 \times 1$ cm.

Shoot face edges of all.

4. Shoot face side of each piece on shooting board. Square also one end of each piece.
5. Place sides, back, and bottom together, and mark length across the three edges, also position of grooves (to receive bottom).
6. Mark bottom and top to finished length.
7. Saw and shoot all pieces to length ; gauge and plane all pieces to width.
8. Round three edges of top, cut grooves and circular hole for face in front and back.
9. Nail sides on to bottom, then front between sides. Follow by nailing top down.
10. Fix the clock movement, and complete by nailing in the back.

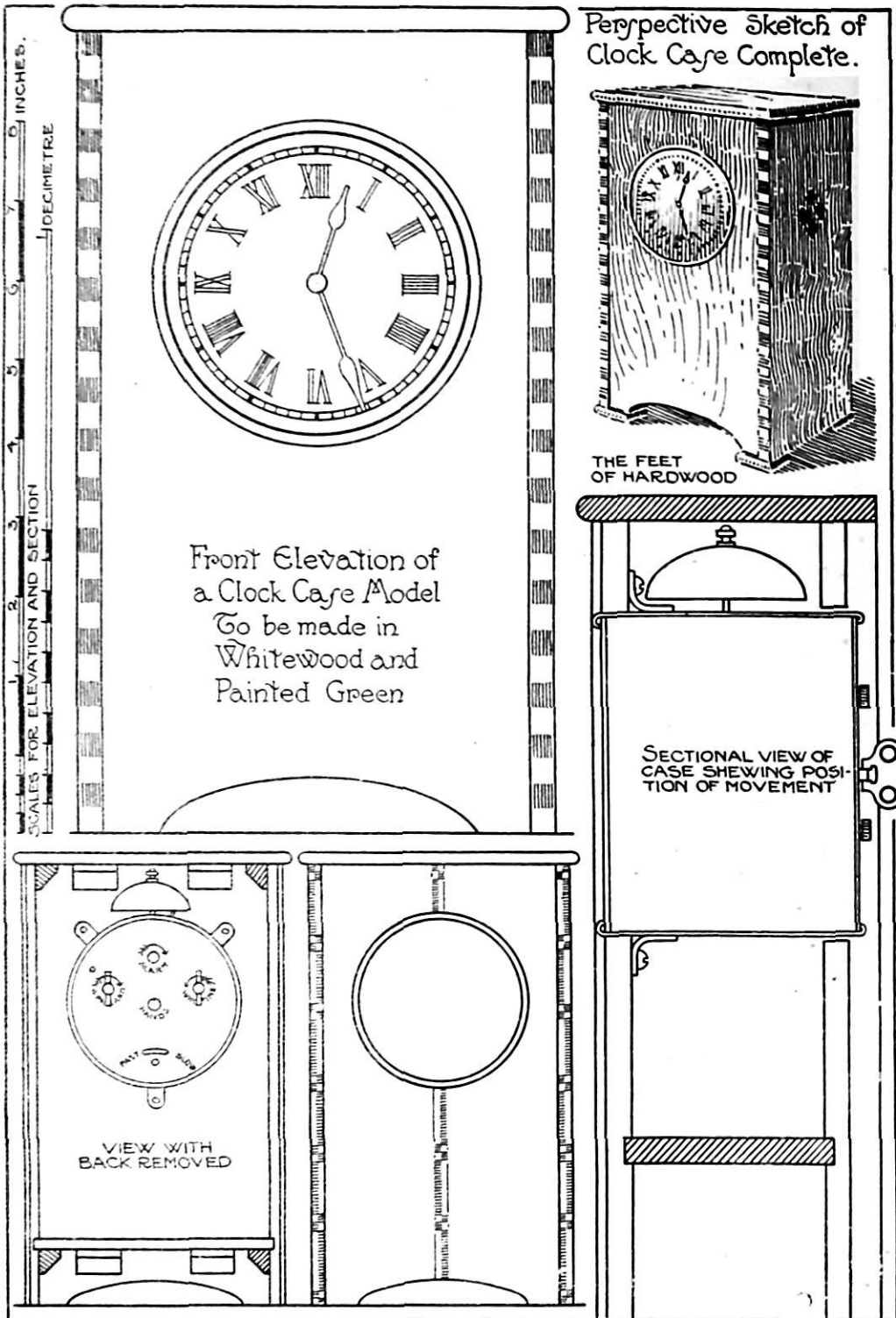

FIG. 4.

GLOVE OR HANDKERCHIEF BOX (Fig. 5).

Object.—To embody elementary processes in a simple model. The first year example is whitewood nailed together with stencil decoration.

The second year example shows the application of through dovetailing, and introduces a simple form of decoration, viz vee tooling with wax inlay.

The Joints of the first example are simply nailed or secured with panel pins; small pins or screws are fixed through the ends into the lid, acting as a pivot (see also plan of back corner shown); when the lid is raised the back edge rests against the box, and slopes slightly backwards.

The Processes for the first year model.

	<i>English</i>	<i>Metric.</i>
1. Cut out 2 Ends	Whitewood, 6 × 4½ × ⅜ in.	15.5 × 11 cm.
" " 1 Front and Back	" 13 × 3½ × ⅜ in.	34 × 8 cm.
" " 1 Bottom	" 14 × 6¼ × ⅜ in.	36.5 × 15.75 cm.
" " 1 Top	" 12½ × 5¼ × ⅜ in.	31.5 × 14.75 cm.

2. Smooth up all material on both sides.
3. Square up to width and thickness back, front, top, and bottom.
4. Draw centre line on end, and draw half complete outline, duplicate on other side as follows —

(a) Trace half outline into a piece of stiff tracing paper.

(b) Turn tracing paper over and go over the outline with a hard pencil; this will leave a mark on the wood, which should be lined in.

5. Repeat the outline on other side. Place both pieces together in bench vice, cut with fine bow-saw and finish with file.

6. Round the edges of bottom and front and back edges of the top.

7. Nail up the box as follows: Nail the ends on to the front, insert back and fix same. Fix the bottom, finally fit the top, mark centres as per diagram, and screw or pin.

The Decoration is based upon a simple natural growth. Pupils should prepare an outline from a specimen, then convert to a suitable stencil, this can be cut in ordinary cartridge paper with a sharp-pointed knife, and when placed in position on the box, the colour is dabbed on the wood through the cut-out portion; the paper is then removed and the paint allowed to dry.

The Second Year Example illustrates a slightly more difficult ornament. This should be drawn on cartridge paper first, then transferred to the box in the manner previously described. A vee tool is used to cut pattern, which can then be coloured or filled with coloured wax (see also p. 182).

Other suitable decorative patterns for use with this model are illustrated on pages 18 and 32.

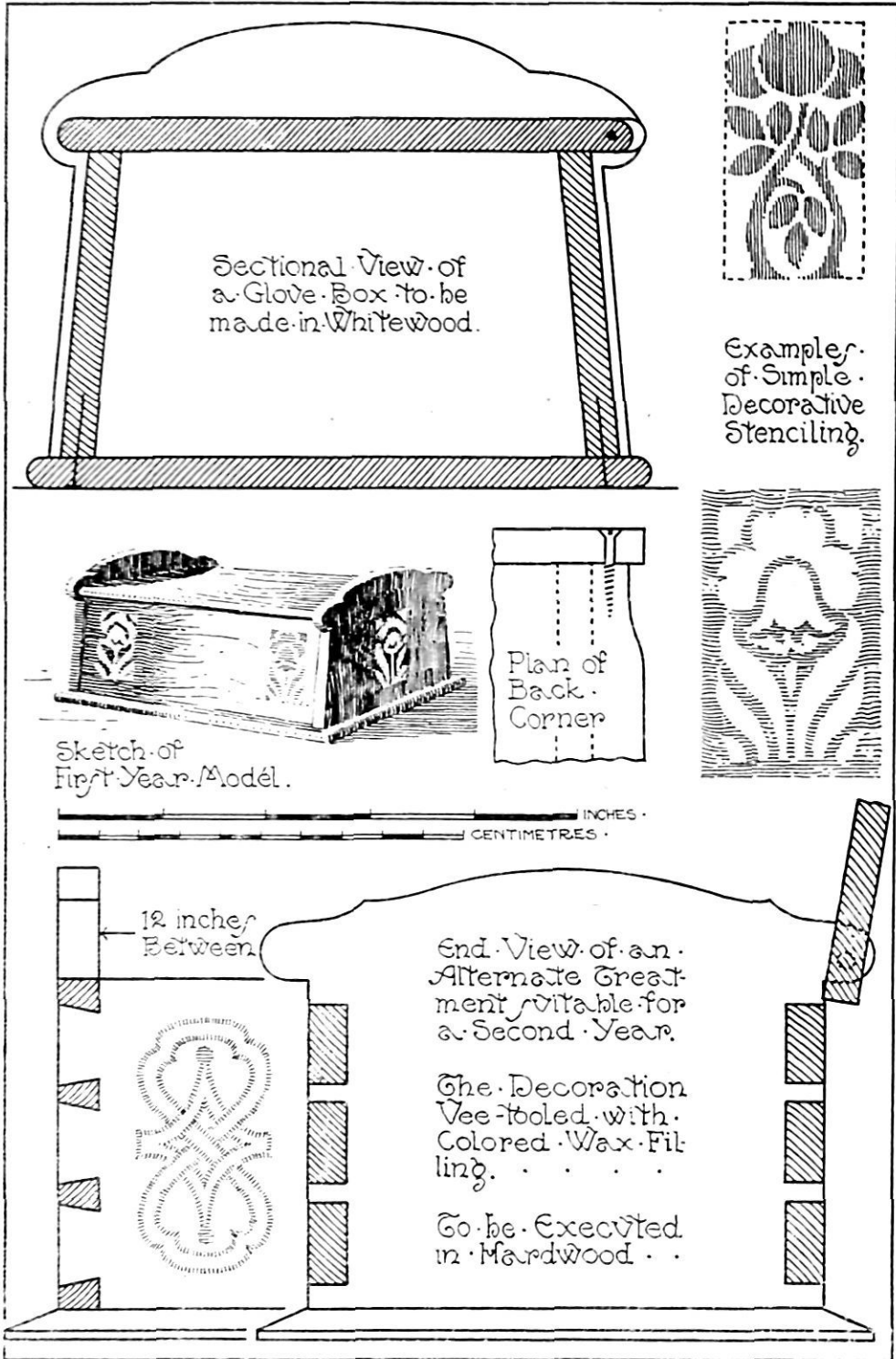

FIG. 5.

KNOCKER AND NAME PLATE (Fig. 7).

Note.—Though wood is not generally used for door knockers, some excellent specimens have been executed in this material, notably those at Gwydir Castle, Wales. In one a conventional rendering of a lion's head is the outstanding feature, while another example shows a pleasing application of chiselled work. An iron button is fixed below the actual knocker, which strikes against an iron plate cut into the door.

Name Plates, such as the example illustrated, can well be executed in wood. The lettering can be either recessed, or left in relief by gouging the outline (see examples, Fig. 6).



FIG. 6.

Oak is suitable material, left in natural condition with high parts coloured. Lime wood is an easier material to use, but should be painted. Necessary boldness is given to the lettering, etc., by painting with a contrasting colour.

Processes.—The Name Plate.—The lettering is best executed by drawing upon cartridge paper. Good examples in various styles are given in Lewis F. Day's "Alphabets Old and New". Geometrical constructions are recommended. When a satisfactory design has been prepared, it can be transferred to the planed surface of the wood by the insertion of carbon paper between the design and the wood. A hard pencil is used to trace the outline, which leaves corresponding marks on the groundwork.

The letter R illustrated is cut round (as shown in section in Fig. 6) with a sharp gouge; the outside part of the gouge cuts is then pared down, producing the bottom section shown, the letter standing up in relief.

The letter Q illustrated should be gouged $\frac{1}{2}$ in. deep, square with groundwork, then gouged down as shown in section, leaving a V shape. In P a similar preliminary process is effected, then the back parts are removed with a "grounding-out" tool.

The letter B is the simplest to execute. Vee cuts are made, the sharp edge of the outside part being removed with a chisel.

For **The Knocker** the following procedure is satisfactory:—

1. Plane up material to thickness of $\frac{3}{4}$ in.
2. Draw centre line on wood, freehand strapwork design on one side, com-

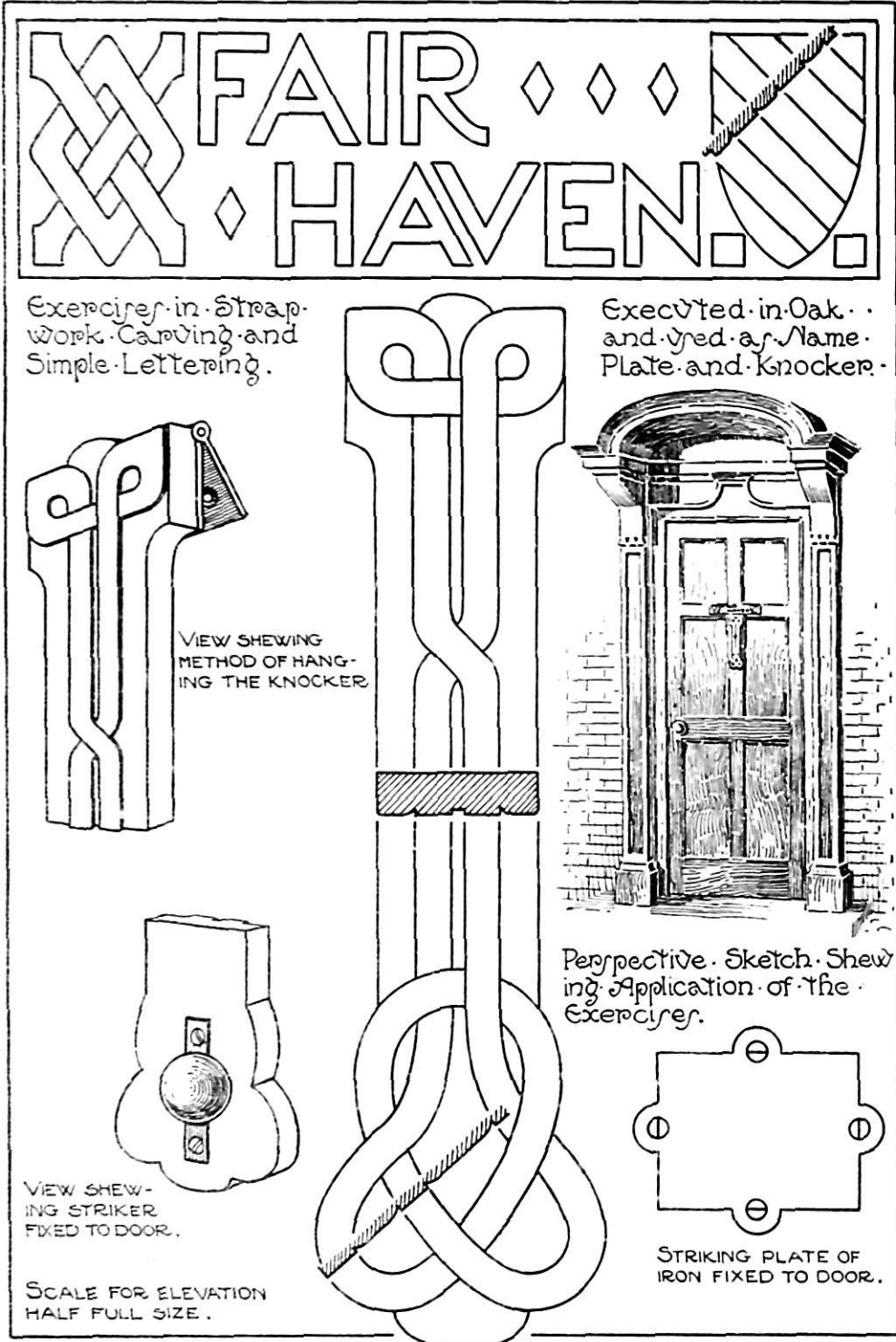

FIG. 7.

Description of Fig. 7 (continued).

plete the other half with tracing paper, or draw on cartridge paper and transfer with carbon paper.

3. Outline the inside part of the design with chisels and gouges and cut down back parts as shown in the section.

4. Cut outside of shape with bow-saw and finish with file.

5. Fix hinge, button, and striking plate.

Object.—To introduce simple carved exercises—involving good training of hand and eye—as a complete model.

A TABLE BOOK-STAND (Figs. 8 and 9).

Object.—To show an application of lapped dovetailing to a simple model. Also to introduce simple chamfered moulding, shaping, and inlaying. The length of the model can conveniently range from 11 in. over all size (as per example) to 2 ft. over all size.

The Joints.—Mitreing is used for the base moulding; and lapped dovetailing is a variation of through or common dovetailing illustrated on p. 21.

The best angle for dovetailing, either through or lapped, is 1 in 6; the carcass and secret dovetails 1 in 6. The best method of obtaining the correct angle is to draw a line CD in Fig. 8 $4\frac{1}{2}$ in. long. Then to divide it into six equal parts; one of these divisions should be drawn at right angles to D and a sliding bevel can then be adjusted. One-eighth the length of D can be substituted for the divisions if desired.

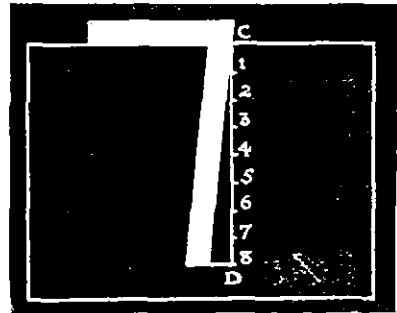

FIG. 8.

Procedure.—For the exercise No. 1, Fig. 9:—

1. Plane up pieces to width and thickness.
2. Square one end of each piece.
3. Decide length of dovetail, rather more than two-thirds thickness of socket piece, gauge same on both pieces.

4. Space out dovetails, marking same with the bevel.

5. Cut dovetails, and then fix the thick piece in the bench chop. The end of the thin piece should then be lined up with the gauge mark of the cap, and held firmly in position. This can best be effected by placing the end of the dovetailed piece upon a plane or block. Press firmly down; place saw in cut, and draw forward. A mark will result in each instance. The guide piece can then be removed, and the socket piece reversed, then cuts are made with dovetail saw, *leaving the mark upon* the wood. Complete by chiselling out sockets and waste, cut shoulders with dovetail saw.

The Process.—1. Plane up to width and length:—

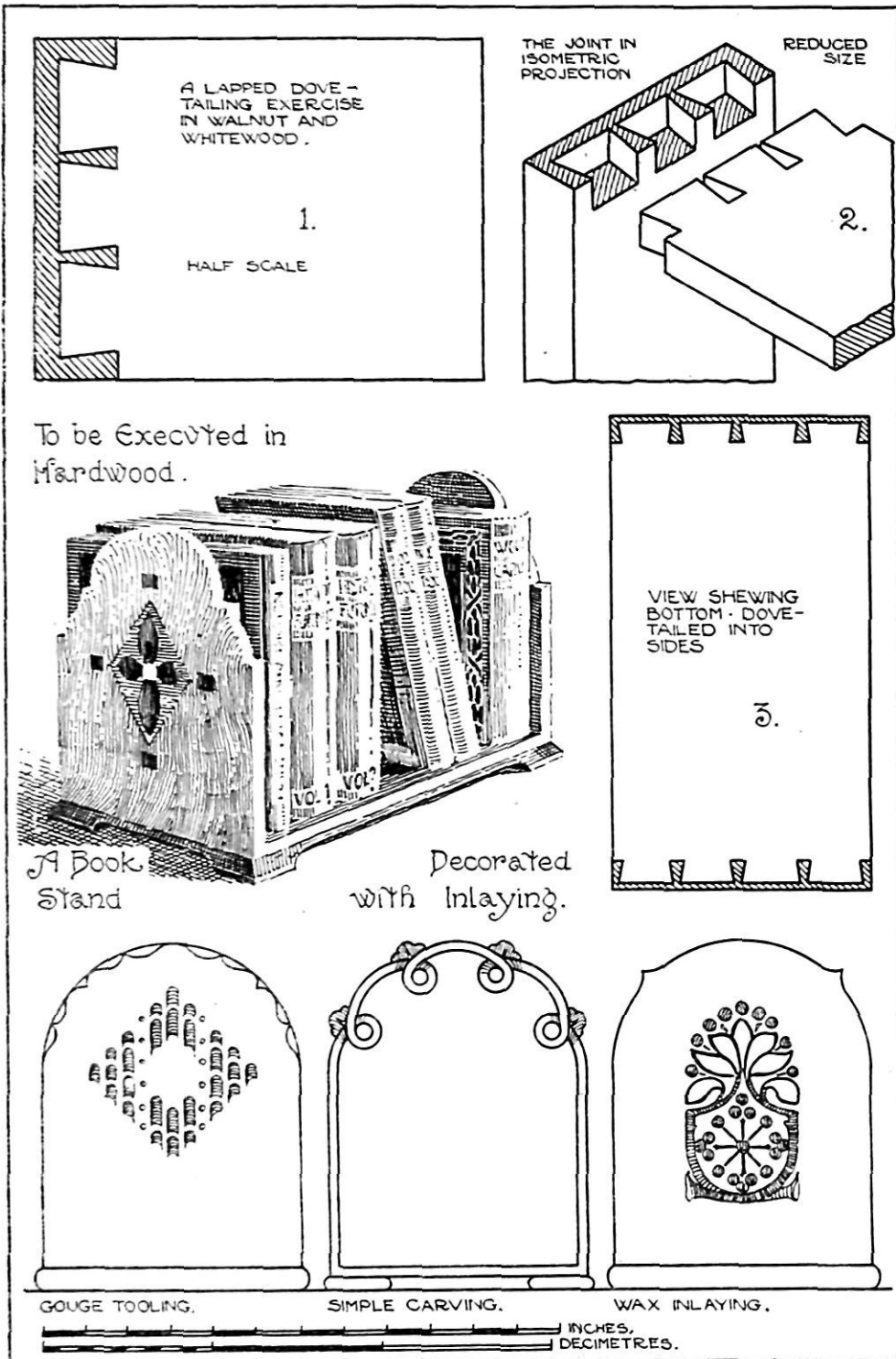

FIG. 9.

Description of Fig. 9 (continued).

<i>English.</i>	<i>Metric.</i>
2 pieces for Ends $7\frac{3}{4} \times 6\frac{1}{4}$ in.	$19\cdot5 \times 15\cdot5$ cm.
2. Saw out and plane up to thickness:—	
1 piece for Bottom $11 \times 6\frac{1}{4}$ in.	$28 \times 15\cdot5$ cm.
Moulding, 1 length 3 ft. $2 \times 2\frac{1}{4}$ in.	97×6 cm.
3. Shoot bottom to length and width, plane ends to width, and square one end.	
4. Plane moulding to width and thickness.	
5. Dovetail bottom into ends (as per preceding detail).	
6. Mark centre lines on ends, draw shape on half, and duplicate with tracing paper and templet.	
7. Cut and regulate shapes, paper up same.	
8. Set out inlaying as per perspective sketch, or carving, tooling, or stencilled decoration (see bottom diagrams).	
9. Sandpaper up all parts; glue together; when dry level off bottom and edges, and mitre round the moulding.	

TEA TRAYS (Fig. 10).

Object.—A useful model showing the application of a simple angle joint, viz. tonguing. In the case of the alternate constructive detail shown, viz. diminished and housed dovetailing, this is more suitable for second and third year work, when a greater degree of proficiency has been attained.

The Process (for main elevation and sectional view).—First year model. Prepare and plane up to thickness the following material:—

<i>English.</i>	<i>Metric.</i>
1. Bottom 1 ft. $4 \times 11\frac{1}{2} \times \frac{1}{2}$ in.	$40 \times 29 \times 1$ cm.
2. Sides 1 ft. $3\frac{1}{2} \times 1\frac{1}{4} \times \frac{1}{2}$ in.	$39 \times 3\cdot2 \times 1$ cm.
3. Ends $11 \times 1\frac{3}{4} \times \frac{1}{2}$ in.	$26\cdot5 \times 4\cdot5 \times 1$ cm.

A scale of one-fifth full size could be adopted with advantage in some cases; the cutting sizes would then be as follows:—

1. Bottom 1 ft. $8 \times 13\frac{3}{8} \times \frac{1}{2}$ in.	$50 \times 36\cdot25 \times 1\cdot25$ cm.
2. Sides 1 ft. $5 \times 1\frac{5}{8} \times \frac{1}{2}$ in.	$48\cdot75 \times 4 \times 1\cdot25$ cm.
3. Ends 1 ft. $1\frac{3}{4} \times 2\frac{1}{8} \times \frac{1}{2}$ in.	$33\cdot1 \times 5\cdot6 \times 1\cdot25$ cm.

1. Plane sides to width, place same together in bench vice, mark finished length on edges, and also the grooves to receive tongue.

2. Place ends in bench vice, set out finished length on edges, also shoulder line.

3. Gauge on thickness of tongue, cut same with dovetail saw. Cut grooves on sides and fit the frame together.

4. Set out shape of end, as per diagram on this page.

5. Bore holes for handles, finish with keyhole saw and files.

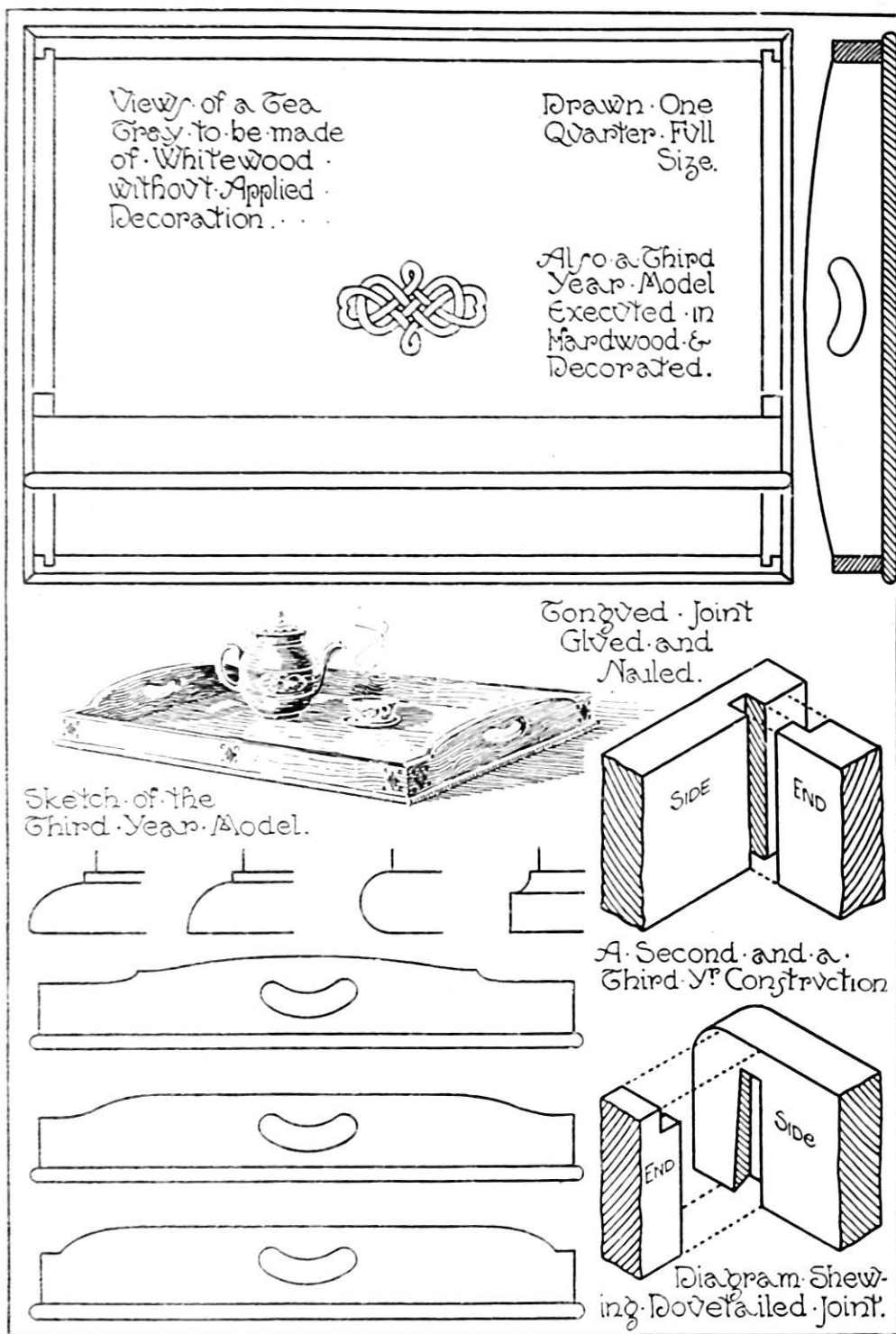

FIG. 10.

6. Cut top curve, finish with spokeshave, glue together, and when dry plane up framing all round.

The Decoration of a first or second year model should be restricted to a simple arrangement of gouge cuts or vee tooling. For the third year a strap-work design is shown which is executed by cutting the groundwork away slightly so as to leave the design in relief. Its effect is enhanced if the surface of the strap-work is cut slightly hollow.

Simple decoration could also be introduced round framing, as suggested in the perspective sketch.

Alternate Shapes for the ends are illustrated; these could be supplemented indefinitely. For class work it is recommended that pupils be given definite data for the hand holes, and be allowed to express their own ideas for the outline, subject of course to criticism and guidance. Alternate details are also shown suitable for a moulded bottom.

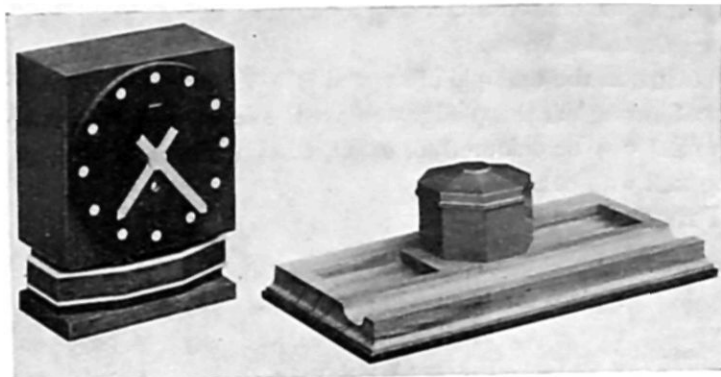

A clock case and inkstand.
(L.C.C. Shoreditch Training College.)

CHAPTER IV

THIRD YEAR MODELS (WOOD)

A HANGING LAMP BRACKET (Fig. 1).

Object.—A model designed chiefly to introduce shaping, cutting with bow saw, and working with spokeshave and file. Also as an exercise in simple recessing.

The **Joints** introduced are a simple mortise and tenon joint, and secret screwed fixing described below.

Decoration in the example illustrated is a simple outline vee tooled, one side of the cut having the sharp edge removed (see section on front elevation). The background can be coloured for effect, certain shades of blue, green, or red harmonizing well with oak.

The Process.—

1. Prepare:	<i>English.</i>	<i>Metric.</i>
1 piece for Back	14 × 6 in.	35·5 × 15·25 cm.
1 „ „ Shelf	9 × 8 in.	23 × 20·5 cm.
1 „ „ Bracket	6½ × 2½ in.	16 × 6·5 cm.

2. Plane up each piece to thickness, reduce back only to width.
3. Mark a centre line on back, freehand the curve on left side, duplicate right-hand side with tracing paper.
4. Plane one edge of shelf, set out shape with compasses.
5. Plane one edge of bracket, set out shape with compasses.
6. Gauge mortise on back (both sides) and tenon on bracket. Bore $\frac{3}{8}$ in. hole and finish mortise with firmer chisel.
7. Slot screw the bracket on to the shelf (see later).
8. Fix back in bench vice, and saw curves ($\frac{1}{16}$ in. outside line) with bow saw. Repeat process with bracket and shelf.
9. Finish each piece with spokeshave, file, and glass-paper.
10. Draw design on back, and outline with vee tool.
11. With a small firmer chisel merge one line of the cut on to the background.
12. Clean up all surfaces, and screw the model together.
13. Paint in background of recessing.

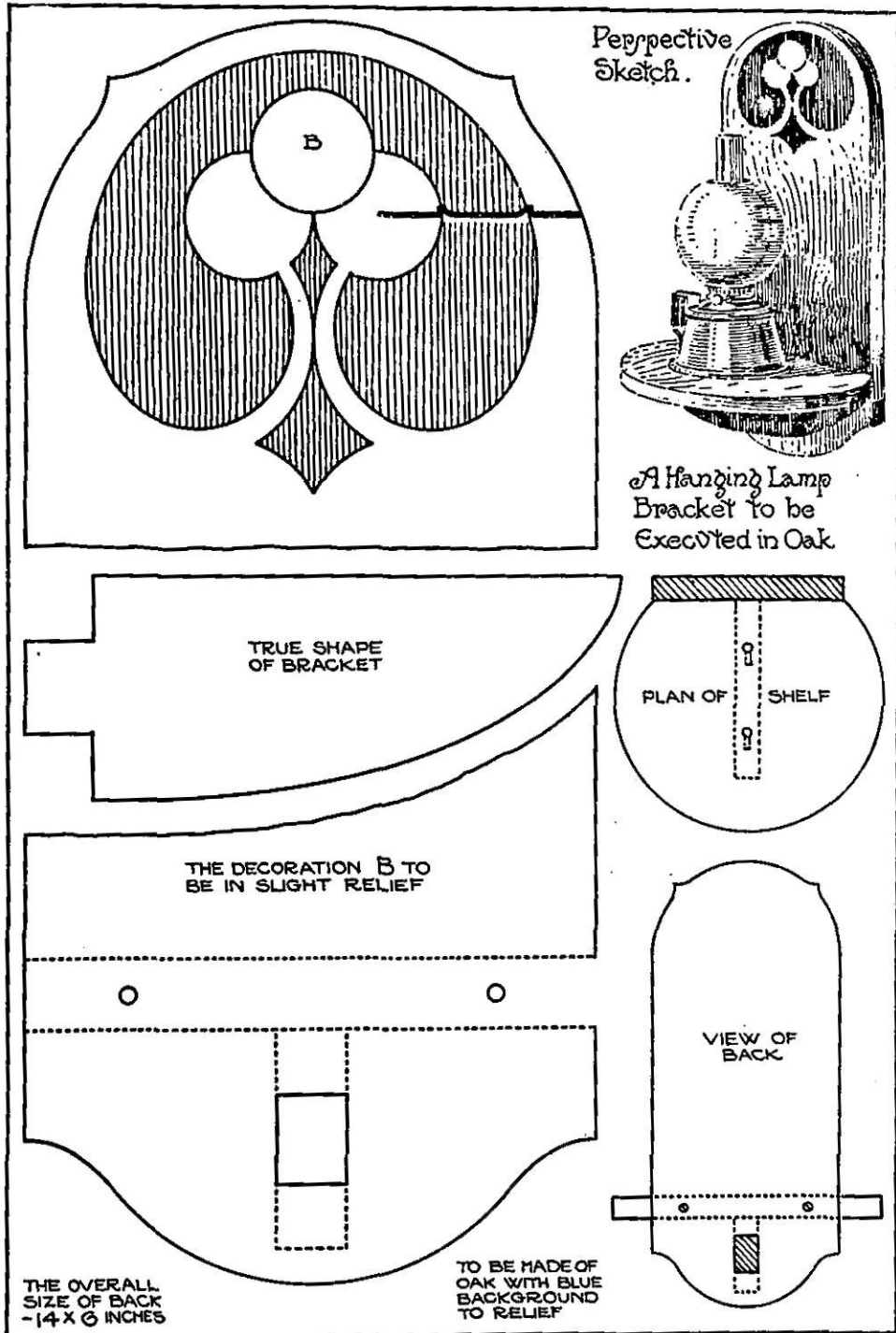

FIG. 1.

Slot Screwing.

1. The bracket piece (A in diagram) should have two $\frac{3}{4}$ in. \times 6 in. screws driven in until a projection of $\frac{1}{4}$ in. is obtained.

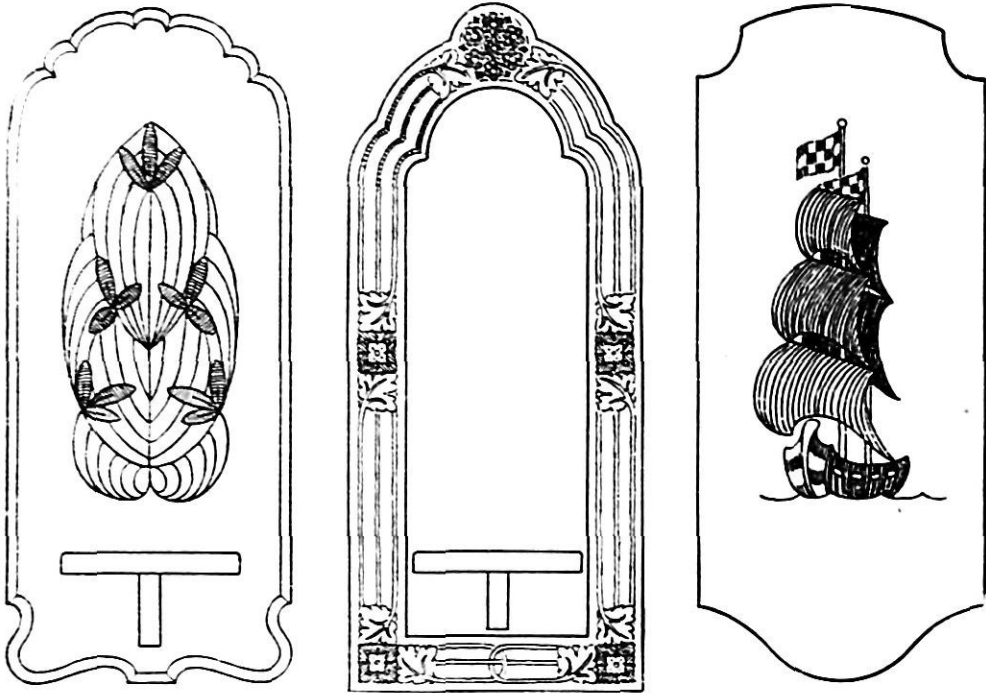

FIG. 2.—Alternate decorative treatments for back of lamp bracket—vee tooled, painted and inlaid.

2. The centre of these screws should be marked on the underside of shelf, then holes are bored exactly the size of the screw head $\frac{1}{4}$ in. deep.

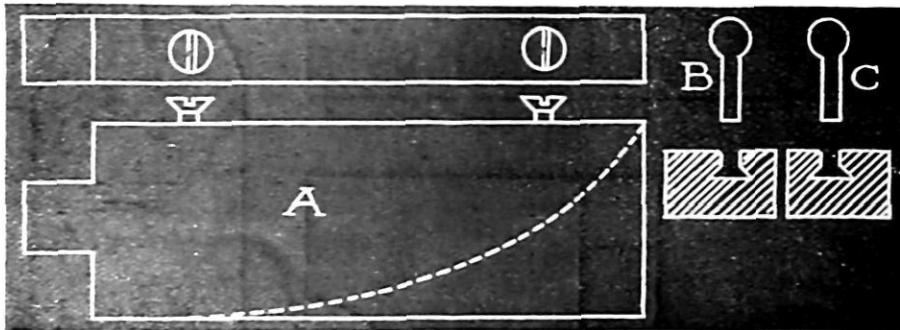

FIG. 3.

3. Slots are cut in the shelf (see plan in Fig. 1) coinciding with the thickness of the screw shaft. See B in diagram.

4. With a small firmer chisel bevel the inside of slot to coincide with the bevel of screw head underneath. The screw heads can then be entered in the bored holes, the bracket pressed down, and tapped along the grooves with a hammer, thus forming a secret screwed joint.

MIRROR OR PICTURE FRAMES (Figs. 4-6).

Tooled, Inlayed, and Stencilled.

Object.—To show applications of a long and short shouldered mortise and tenon joint to a tenoned-up frame. Three shapes are illustrated, embodying similar constructive features. The ornament is varied; the first type shows an arrangement of simple gouge cuts, the second—without shaping—shows a simple inlaid treatment, and the third example illustrates the application of stencilled ornament.

The Joint (see diagram) as an exercise is best cut from two pieces of pine or whitewood $8 \times 2 \times \frac{7}{8}$ in. These are planed to width and thickness, and then set out as illustrated in Fig. 4, below.

1. Square across lines on stile piece to width of rail AB.
2. Square across rebate line and haunch line CD.
3. Square shoulder lines across on rail piece EF $1\frac{1}{4}$ in. from end.
4. Return E on face side, F on back side.
5. Set gauge to mortise chisel ($\frac{1}{3}$ rd approx.).
6. Mark mortise on stile and tenons on rails (see dotted lines).
7. Mortise stile, cut tenons, and then fit together.

The Process for Frame (first example).—1. Saw out, and plane up to width and thickness:—

	<i>English.</i>	<i>Metric.</i>
2 Stiles	1 ft. 1 × $1\frac{3}{4}$ in.	2 pieces 3·3 cm.
1 Top rail	1 ft. 4 × $3\frac{1}{4}$ in.	1 piece 4·1 cm.
1 Bottom rail	1 ft. 4 × $1\frac{3}{4}$ in.	1 piece 4 cm.

2. Place stiles together in bench vice and square across sight lines of rails, then haunch and rebate lines, gauge rebate lines on face, edges, and backs.

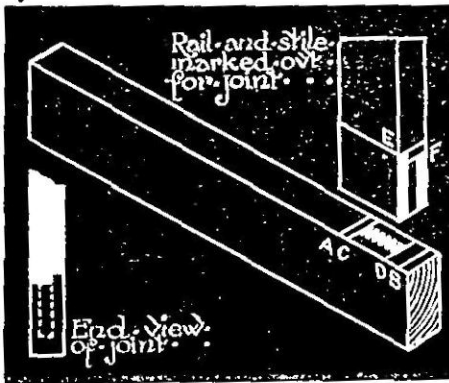

FIG. 4.

3. Mark mortise and tenons, cut same, then shoulders, work the rebates with plane (see p. 238, Fig. 10).

4. Firmly secure one stile in bench, then reduce tenon to width; test same in mortise and fit same until both shoulders are tight, and rail lies in the same plane as the stile.

5. Repeat this process with each remaining corner of the frame.

6. Glass-paper inside edges and glue frame together. (Iron stops of bench used for one end, with light iron cramp across the other rail.)



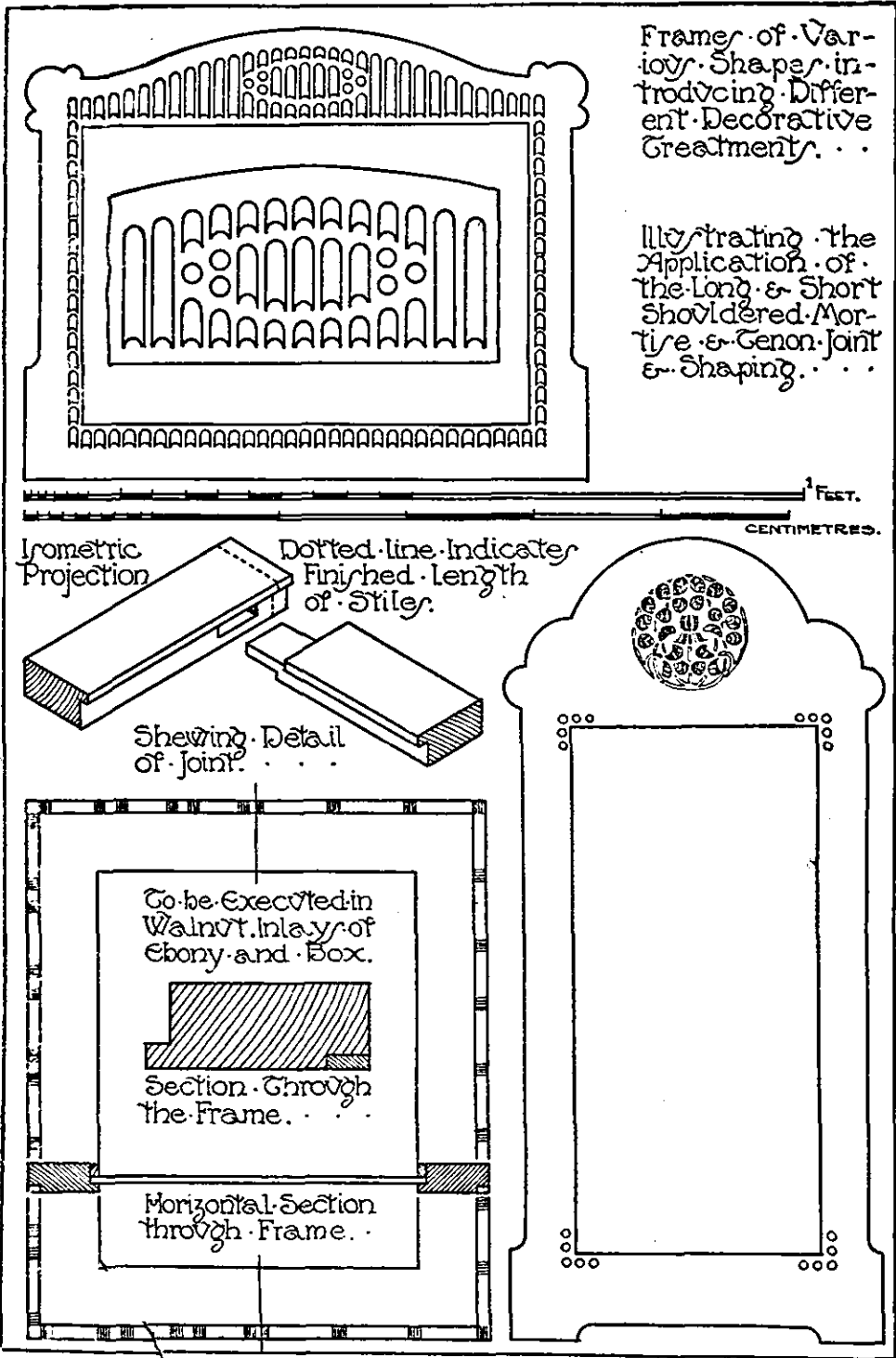

FIG. 5.—Frames.

7. When dry, the frame is planed down level on both sides, and a centre line drawn on face side; the curves are then traced on paper from the full-size drawing and transferred half at a time each side of centre line.

8. Frame is placed in bench vice, shape cut just outside the line with a bow saw, then filed and regulated, viz. freed from lumps and irregularities, and finally papered up.

9. Tooling is spaced out with dividers and drawn upon the wood, then a scribing gouge is used to tool the surface. Papering concludes this part, and the addition of a back from $\frac{1}{4}$ in. pine completes the model.

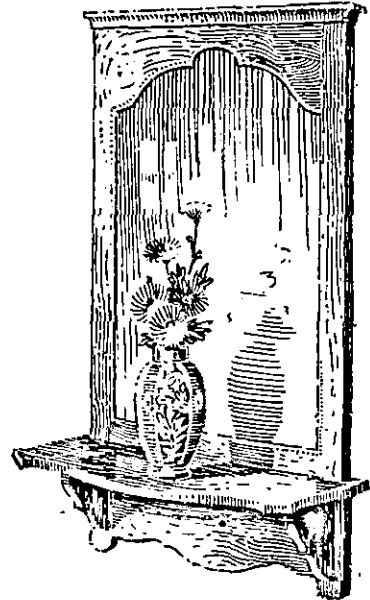

FIG. 6.—A shaving mirror to hang upon a wall. Executed in white-wood and painted.

CANDLE BRACKET (Fig. 7).

Object.—To show the possibility of combining metal and woodworking processes in one model.

The Joints employed in the woodworking portion are a double mortise and tenon joint, with single ditto on bracket, and secret screwing to secure bracket to shelf. The candle sconce is intended to be screwed down to the bracket.

The Process.—1. The model to be drawn on cartridge paper, full size.

2. Saw out and plane to width and thickness:—

	<i>English.</i>	<i>Metric.</i>
1 piece Back	$10\frac{1}{2} \times 4\frac{1}{2} \times \frac{5}{8}$ in.	$27.5 \times 14.5 \times 1.6$ cm.
1 „ Bracket	$6 \times 1\frac{1}{2} \times \frac{1}{2}$ in.	$15.5 \times 3.5 \times 1.3$ cm.
1 „ Shelf	$6\frac{1}{2} \times 3\frac{1}{4} \times \frac{1}{2}$ in.	$8 \times 8.25 \times 1.3$ cm.

3. Draw centre line on back. Square across lines for mortise, and mark outline with tracing paper.

4. Set out shoulder and tenons on bracket, cut same, also mortise and tenon in back and fit together.

5. Execute the secret screwing in bracket and shelf (see p. 36).

6. Set out true shape of bracket and shelf, cut same, also the back; spoke-shave, file and glass-paper to line.

7. Execute inlaying as per below, then clean up all surfaces and glue together. Fit sconce and fix.

The Decoration of the example under review is wood inlaying; this can, alternately, be entirely omitted, or simple carving, strapwork, stencilling, or

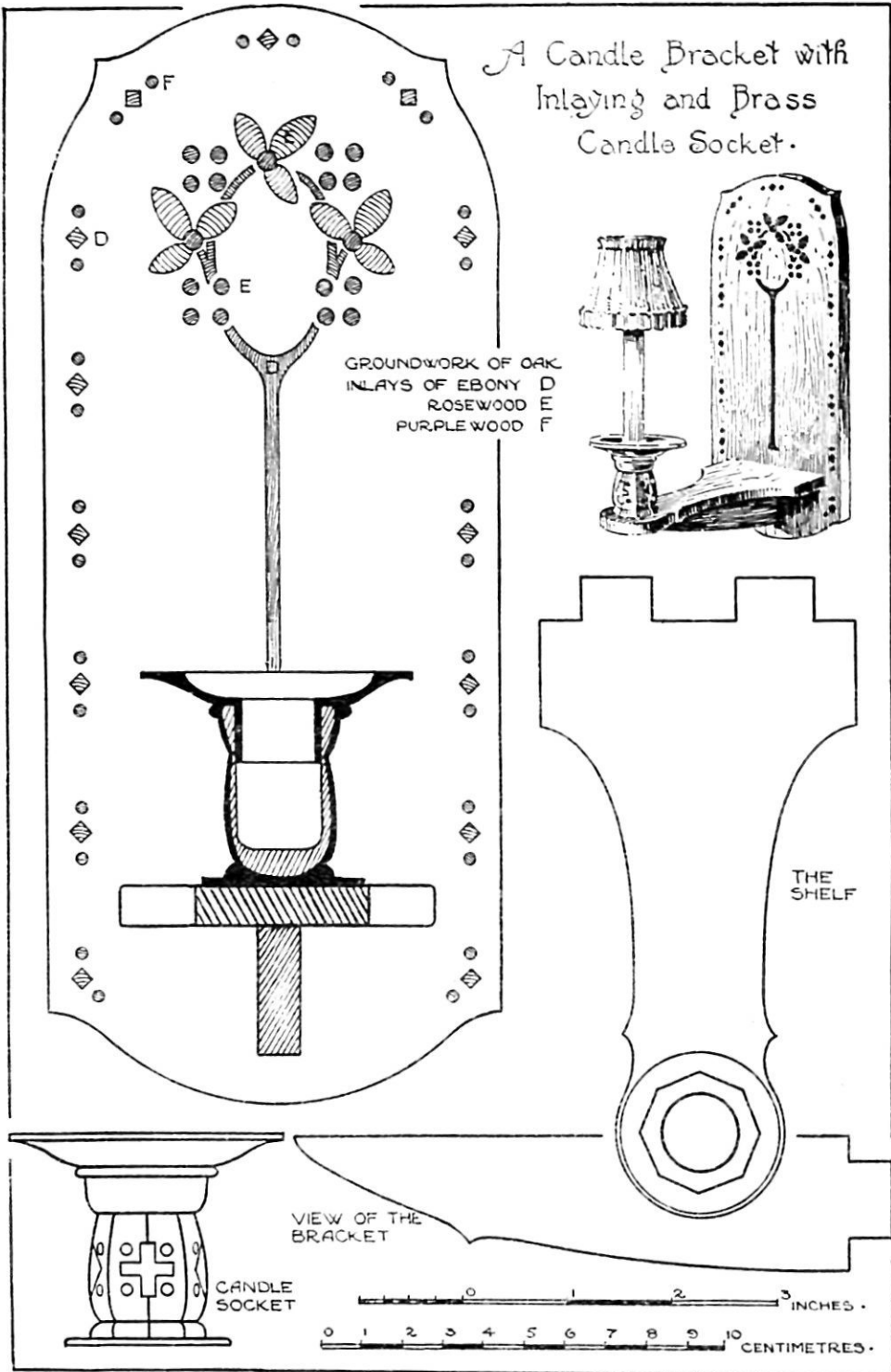

FIG. 7.

tooling can be substituted. (References to the latter with suitable ideas will be found on next page and on p. 176.)

Procedure for Inlaying.—It is assumed that the ornament is drawn full size on cartridge paper.

1. Trace the pattern on to tracing paper. Gum or paste this down to the back in correct position.
2. Prepare another tracing of the inlay; cut up into small pieces, each containing one unit of the design (or alternately), as described on p. 179. Glue these tracings of units down to veneer, taking care to have the grain running from heel to point of each leaf.
3. Cut leaves and stems with fret saw or gouge, keeping just *outside the line*.
4. Gouge groundwork, cutting just inside the line; remove cores, and glue units in position.
5. Bore the spot units, and glue in previously prepared sticks.
6. The square units are cut with $\frac{1}{8}$ in. chisel.

FINGER PLATES (Fig. 8).

Object.—To introduce various exercises in a complete model, involving manipulation of gouges and grounding tools as special practice for hand and eye.

Note.—The third, fourth and fifth examples represent those placed beneath the handle and lock of a door, and the length can readily be extended for upper plates. Many alternate arrangements can be effected, such as carving on top of upper plate, and vice versa. When extra length is desired, the ornament is such as to be readily adaptable.

The Process.—A full-size drawing of a plate should first be made on cartridge paper, then the wood selected. The following woods are suitable, and range in difficulty of working in the order given, viz. Mahogany, walnut, oak, sycamore, boxwood, ebony, and satinwood.

First Example.—1. Cut out and plane to width and thickness:—

<i>English.</i>	<i>Metric.</i>
Top plate 1 piece hardwood 11 × 3 × $\frac{1}{4}$ in. base	28 × 7.6 × .6 cm.
Bottom plate 1 piece „ 8 × 3 × $\frac{1}{4}$ in. „	20.3 × 7.6 × .6 cm.

2. Draw centre line on each piece. Trace half the outline on plate and ornament from drawing.
3. Transfer this on both sides of centre lines with tracing paper.
4. Clamp wood on bench, and outline design with carving gouges.
5. With a grounding-out tool remove interior parts to a uniform depth, keeping corners sharp.
6. Cut the face of the ornament to give an interlacing effect.
7. Complete the model by cutting outline, rounding of same on face side, and sandpaper up the flat surface.

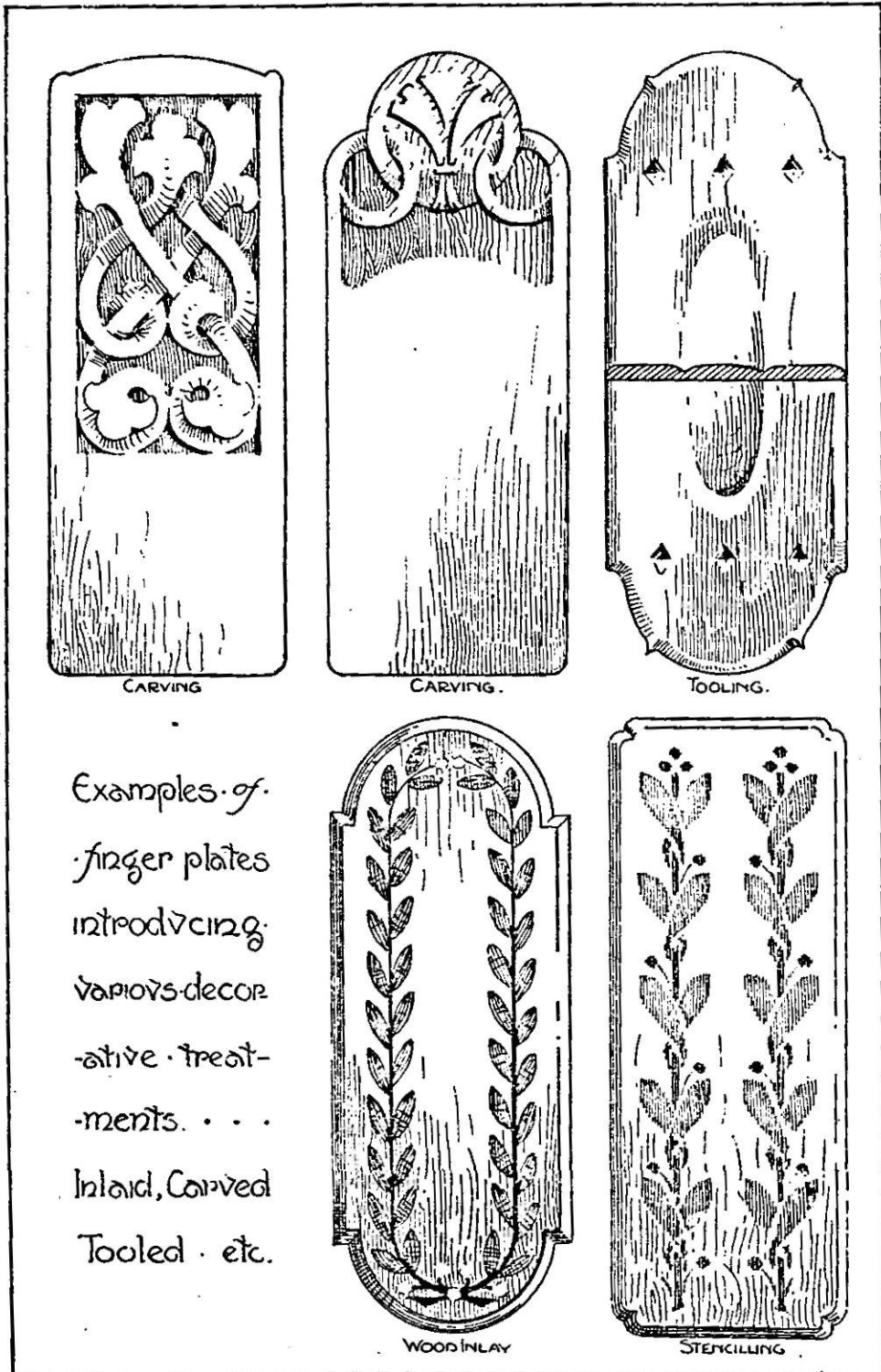

FIG. 8.

Fourth Example.—1. Prepare material (as per above) and transfer detail from drawing with tracing paper.

2. The stems should be cut from veneer, and cut into the groundwork and glued.

3. The leaf units are next cut. They are best made by two gouge cuts in a leaf of veneer, and may be cut into the groundwork in a similar manner. Two gouge cuts are made the required depth, and a slight turn of the tool usually suffices to remove the core.

4. Units are glued in position, holes are bored for the berries with a small

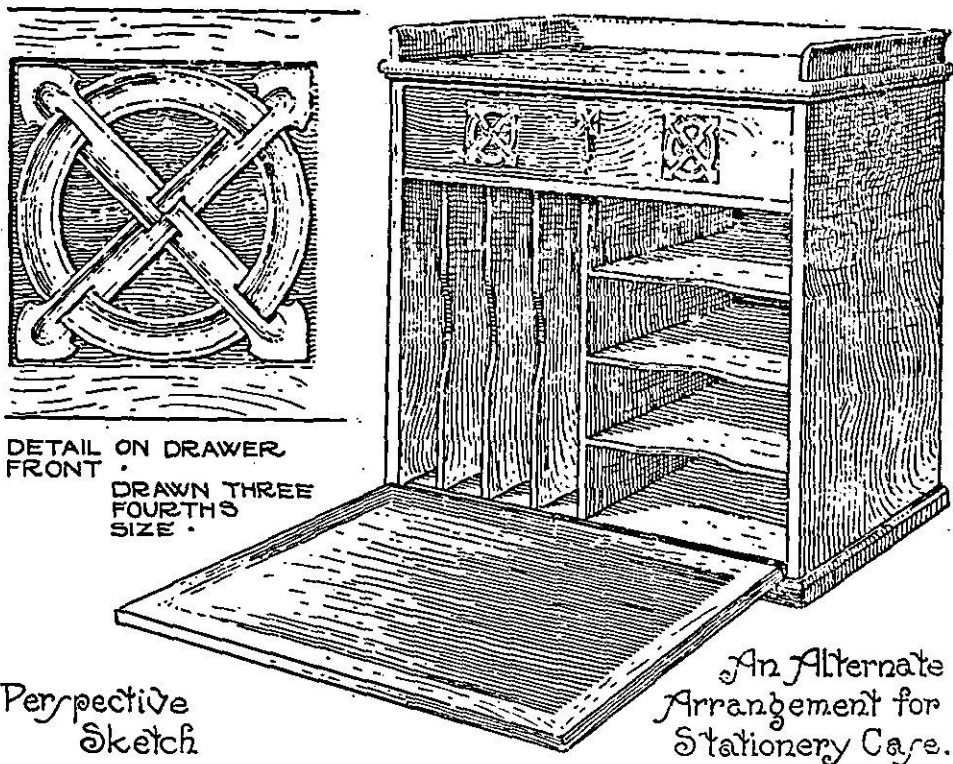

FIG. 9.—A design for a simple carcass model. A stationery case.

twist or centre bit, and a cylindrical stick, equal in diameter to the berry, is prepared, and can be glued into a hole and cut off level with a dovetail saw.

Inlaying is further described in chapter on "Decorative Processes".

The ornament shown in the second example should be executed by first outlining the ellipse with gouges, and then bevelling as indicated with flat carving tools.

BREAD PLATTERS (Fig. 10).

Object.—To introduce bow sawing and filing exercises. These models are specially valuable for good hand and eye training. Whilst general features are followed, there is ample scope for individual taste on the part of pupils.

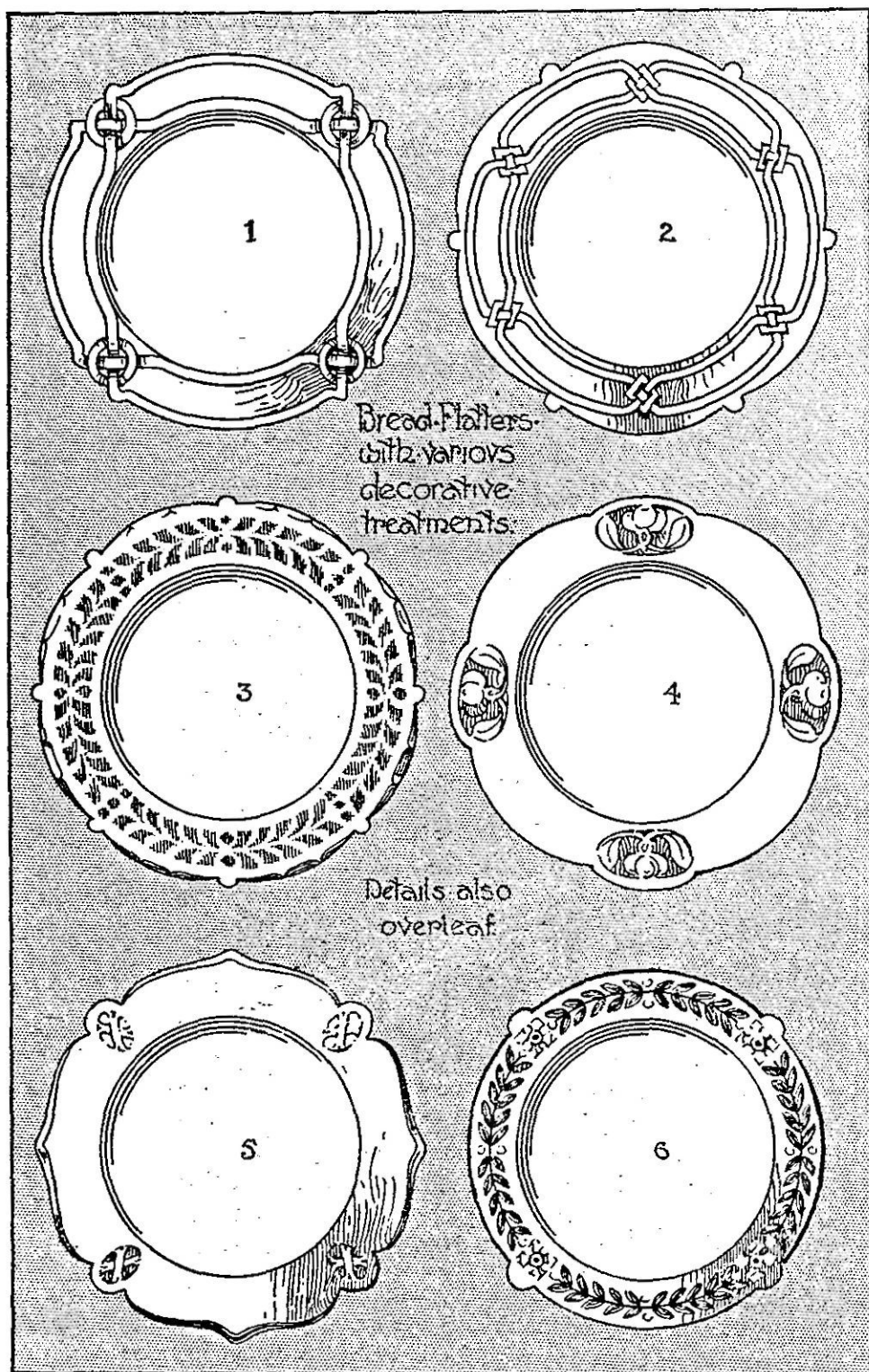
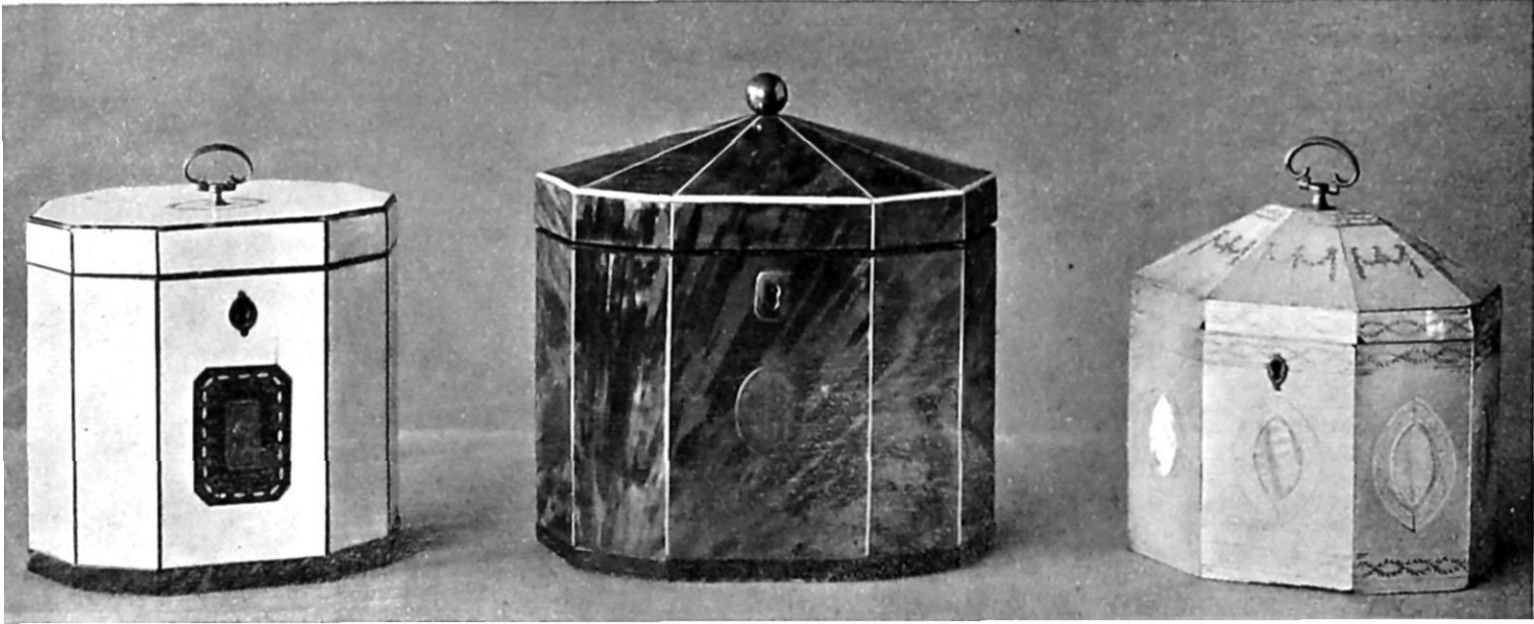
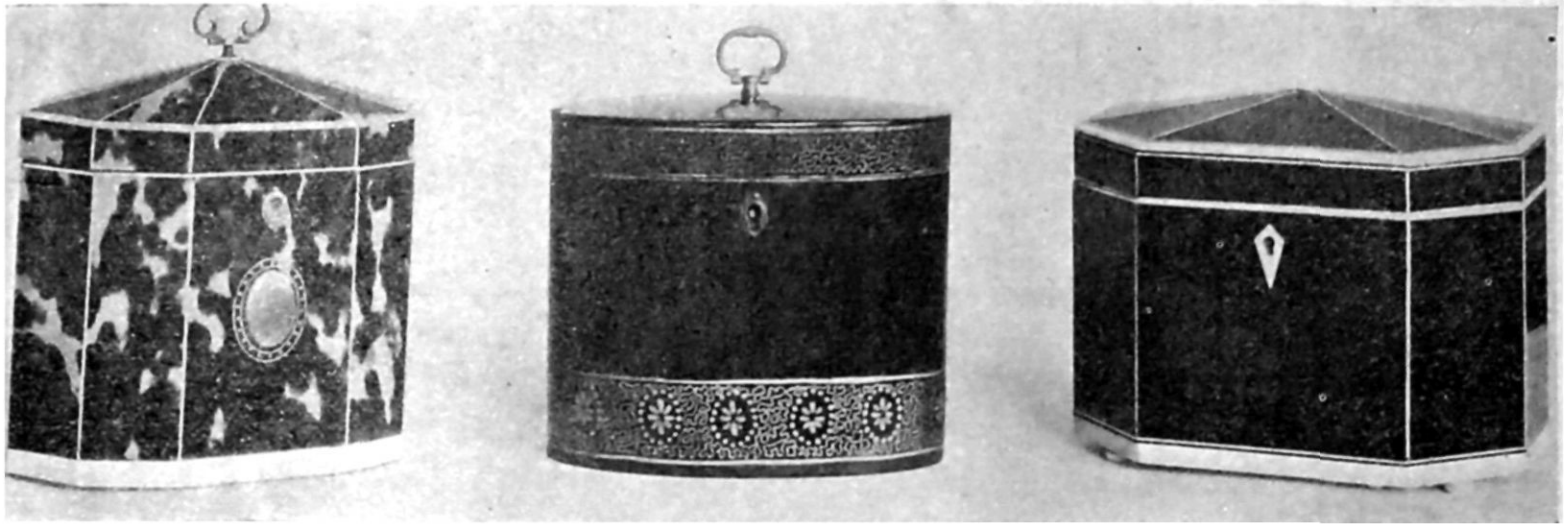

FIG. 10.



Eighteenth-century tea caddies.

(Victoria and Albert Museum.)



Eighteenth-century tea caddies.

(Victoria and Albert Museum.)

Commencing with the drawing of a plain circle for outline and an inner circle for the recessing, individual effort can be encouraged in developing the outline, chamfering, and ornament of rim.

Material.—Sycamore is an excellent wood for this model ; limewood may be considered the next best ; it is both softer and easier to work than the former. American whitewood is least satisfactory for class work owing to its liability to cast and twist. An average overall size of 12 in. is recommended.

The Process (example No. 1, Fig. 10).—1. Prepare a drawing of the platter, full size, on cartridge paper.

2. Plane up the material on both sides and strike diagonal lines.

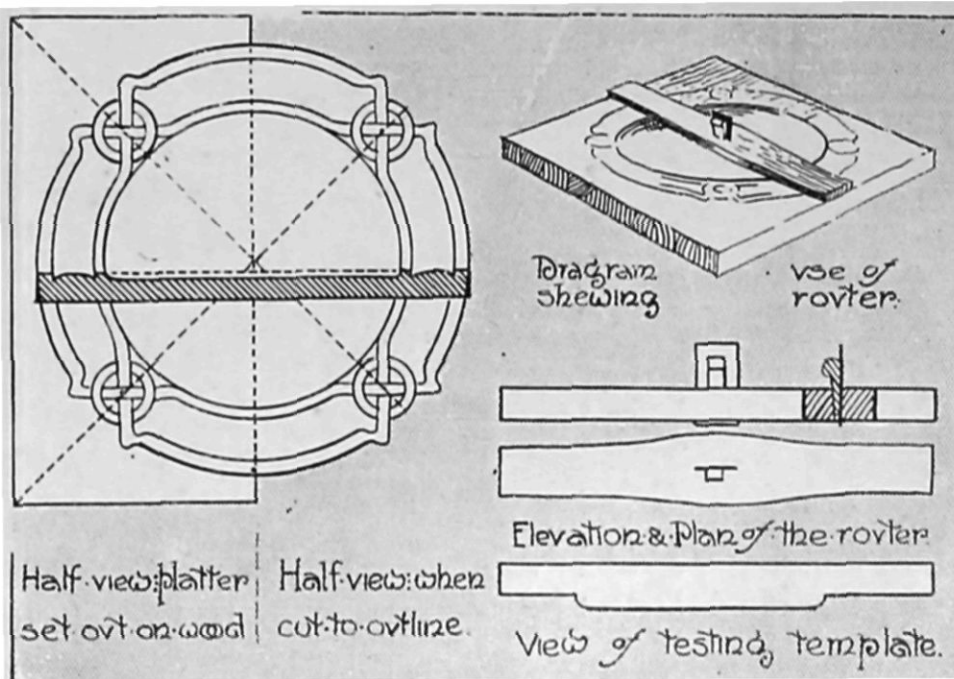

FIG. 11.

3. Transfer the design on to the material.
4. Execute the recessing ; this should be done with a flat gouge. (Occasionally it should be tested for correct depth with the templet (see diagram). A router is used to finish the recessing to a uniform depth (see sketch above). Glass-paper can be used to finally smooth up.)
5. Cut outline to shape with bow saw, and finish with file.
6. Execute carving with gouge cuts square to face side ; the groundwork is then levelled (see section above), leaving the strapwork or leaves, etc., in relief.
7. Complete the model by spacing and pencilling the chamfer decoration, file this part, and finish with sandpaper.

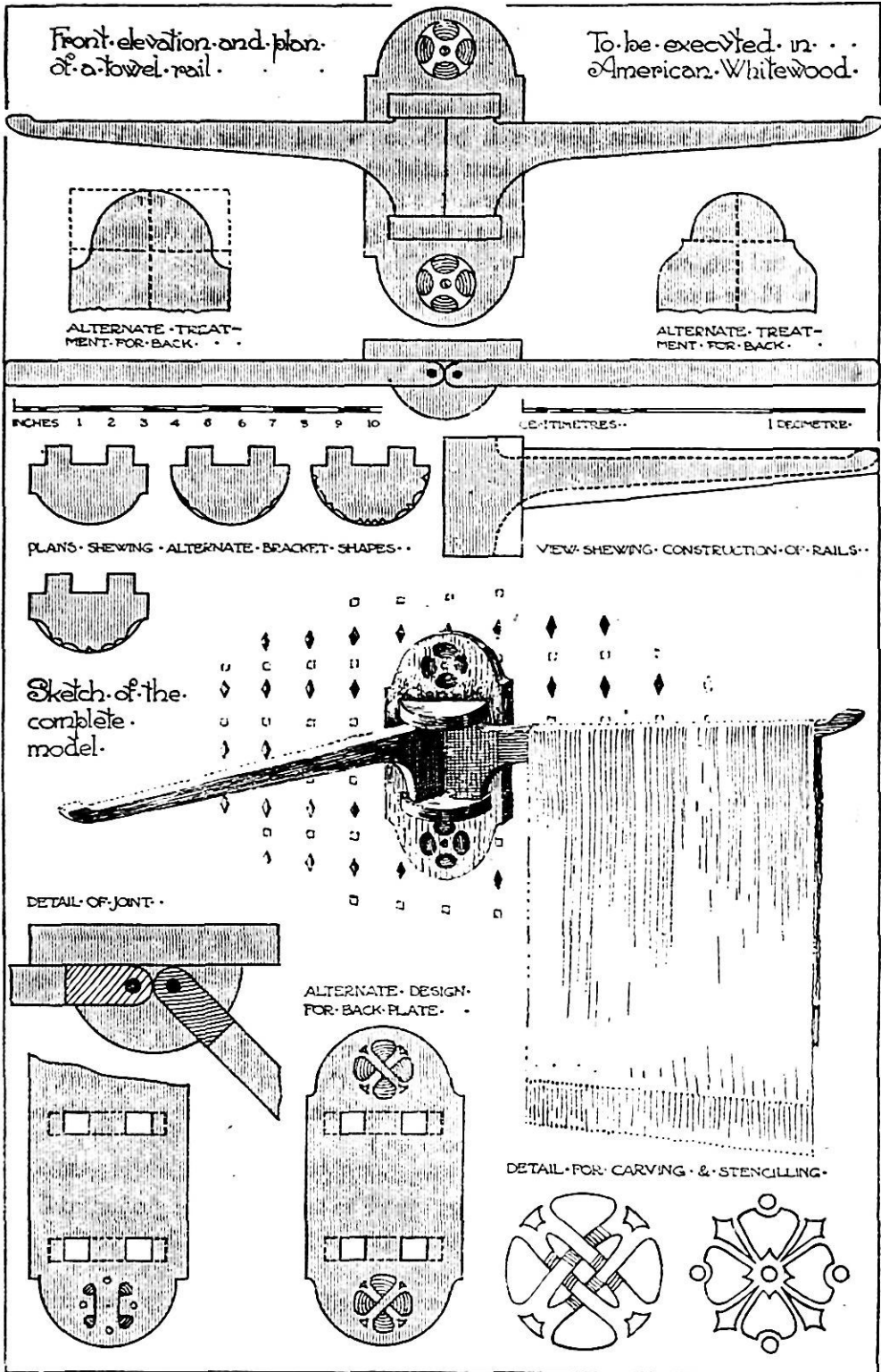

FIG. 12.—An adjustable towel rail to be made in teak, sycamore, or American whitewood,

Description of Fig. 10 (continued).

Notes.—The first example, described above, is worked upon a circular geometrical basis, the decoration is centred upon diagonal lines. The second specimen has a hexagonal form, the sides being converted into curves with small intervening detail. The main elements of the strapwork decoration are spaced in between the diagonals. The third example is based upon an octagon, and the leaf decoration is intended to be slightly recessed.

No. 4 is based upon a circular outline, with simple conventional floral ornament at the ends of the diameters.

No. 5 shows an example worked upon a circle and diagonal lines, as does also the last specimen, the decoration in this case being in slight relief from the rim or groundwork.

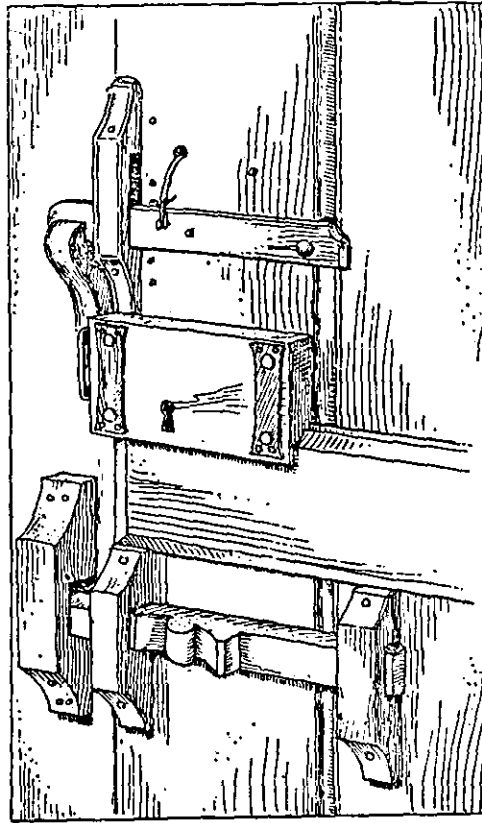

Wooden Latch and Bolt from a house at Brockhampton, Herefordshire.

CHAPTER V

SPECIAL MODELS IN WOOD

FOR EVENING PUPILS AND OTHERS

SWING TOILET MIRROR (Fig. 1).

Object.—A model designed chiefly upon the use of mortise and tenon joints, and to show the application of simple geometrical painted decoration, strapwork carving, or recessing and chamfered ornament.

The Joints.—All of the joints connecting the various parts are similar, i.e. mortise and tenon.

The Procedure for complete example illustrated is as follows:—

Mark and saw out the following pieces:—

	<i>English.</i>		<i>Metric.</i>	
1. Standards	2 pieces	1 ft. 5 $\frac{3}{4}$ in. × 3 × 3 $\frac{3}{4}$ in.	45 × 7 × 2 cm.	
2. Feet	2 „	7 in × 1 $\frac{3}{4}$ × 3 $\frac{3}{4}$ in.	17.5 × 3 × 2 cm.	
3. Cross Rail	1 piece	1 ft. 7 in. × 3 $\frac{1}{4}$ × 3 $\frac{3}{4}$ in.	48 × 7.5 × 2 cm.	
4. Capping	1 „	7 in. × 1 × 1 $\frac{1}{2}$ in.	17 × 3 × 5 cm.	
5. Stiles	2 pieces	1 ft. 1 $\frac{1}{2}$ in. × 1 × 7 $\frac{7}{8}$ in.	34 × 2.5 × 2 cm.	
6. Rails	2 „	1 ft. 5 in. × 1 × 7 $\frac{7}{8}$ in.	41.5 × 2.5 × 2 cm.	
7. Glass Back	1 piece	1 ft. 4 in. × 11 $\frac{1}{2}$ × 1 $\frac{5}{8}$ in.	40 × 29 × 8 cm.	

8. Plane up face, side, and edge of all material.

9. Gauge and plane all pieces to width and thickness as per drawing (with exception of back).

10. Tenon standards into feet (as per diagram Fig. 1) and glue up.

11. Set out shoulder on cross rail and mortises on standards. Cut these and fit together.

12. Work cappings, clean up all pieces for stand. Fix cappings, and when dry cramp in cross rail, testing carefully for squareness before leaving to dry (see Fig. 2).

13. Set out stile and rails for glass frame (details as for a door frame illustrated on p. 38).

14. When the glass frame is dry, plane up square and clean up; $\frac{3}{16}$ in. each side to be allowed for screw movements.

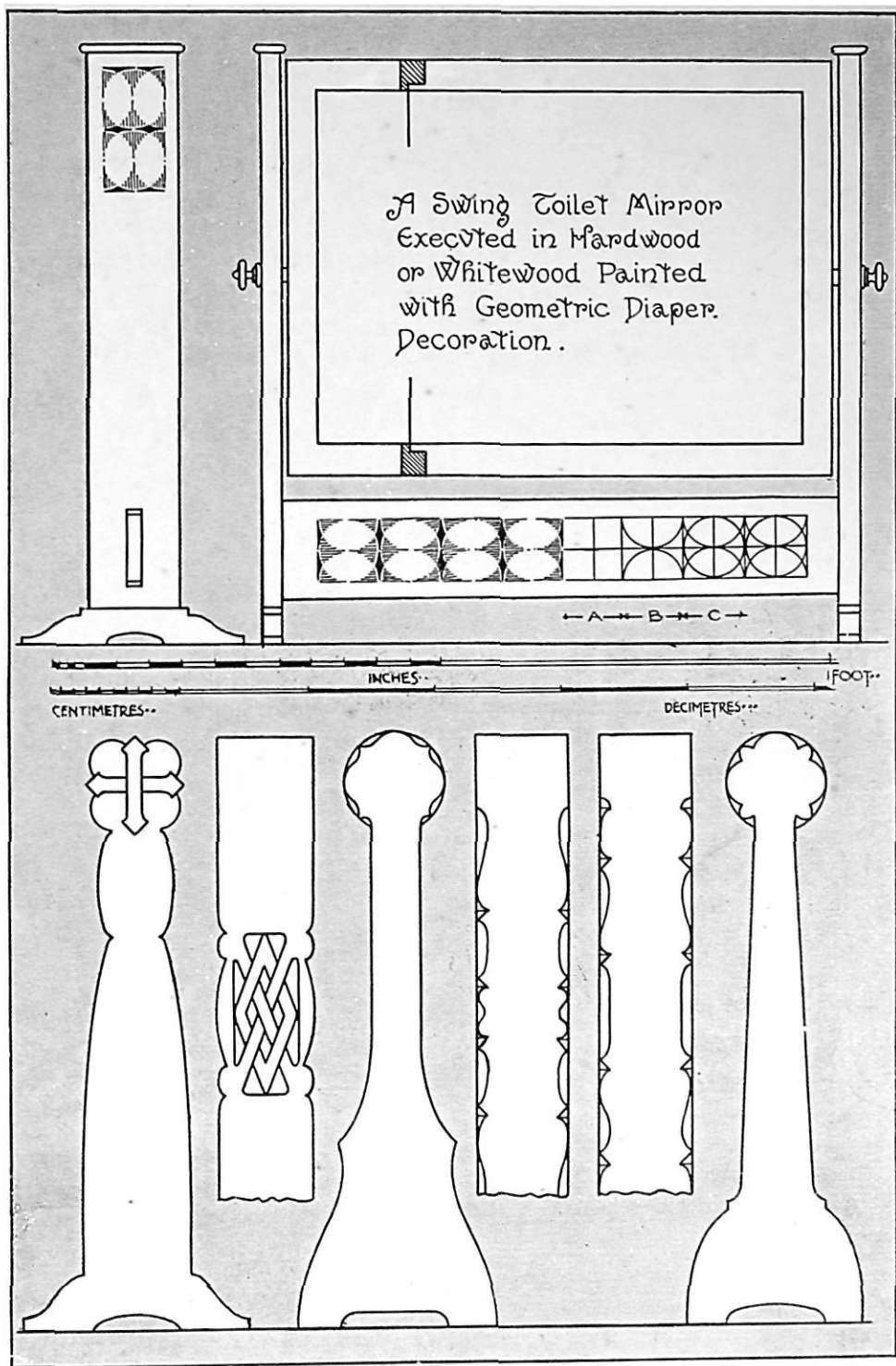

FIG. 1.

15. Cut plates in stiles of frame and bore standards.

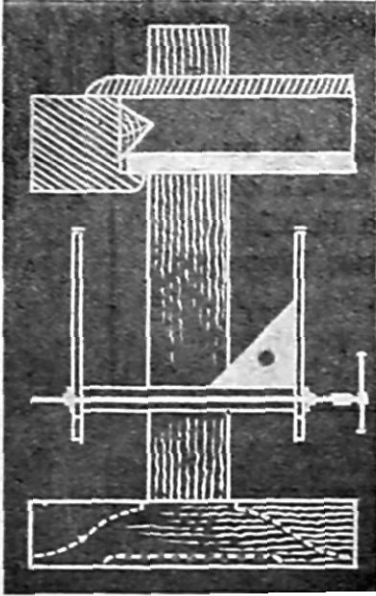

FIG. 2.

16. Fix glass in frame, as in diagram Fig. 2, by glueing blocks 1 in. long in the position shown. Complete by screwing on back as per section.

The Decoration of the complete specimen shown is based upon a simple geometrical pattern. This should be set out as shown in front elevation. Squares are first drawn, then each is divided into four parts (see A). Semi-circles are then described (see B) and finally a circle in each original square touching the sides (refer to C). A simple diaper is thus formed, which should be coloured in with various paints and sable hair brushes. A similar procedure is followed for the standards.

Alternate Treatments for the standards and cross rail are also illustrated opposite. The first and second examples represent simple recessing forming strapwork, whilst the four last examples show variation of outline ornamented with easy chamfering.

AN UPHOLSTERED STOOL (Fig. 4).

Note.—The model is based upon stools of the Queen Anne period so far as general outline is concerned. The treatment of the under-railing is essentially modern. Turning for work of this character is best studied from old examples, the first and third examples are adapted from Queen Anne detail. The method of connecting the under-railing is described on p. 56 in connexion with occasional tables. Wainscot oak may be used for models of this type, but Italian walnut is preferable. Various methods of building up the turning are illustrated in the diagram Fig 5 on p. 52.

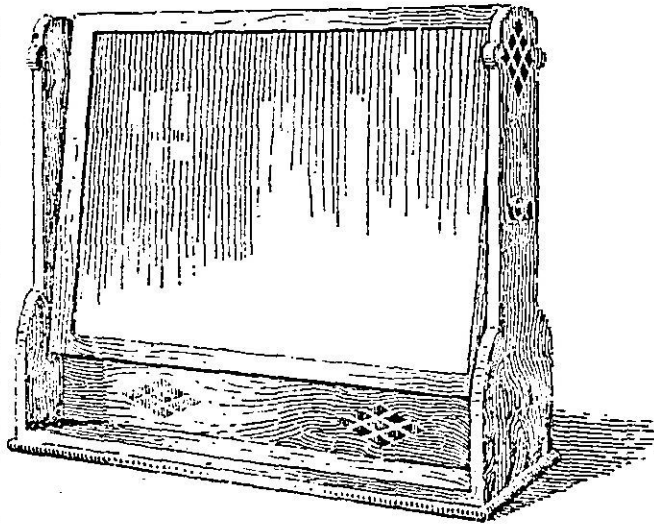

FIG. 3.—A swing toilet mirror.

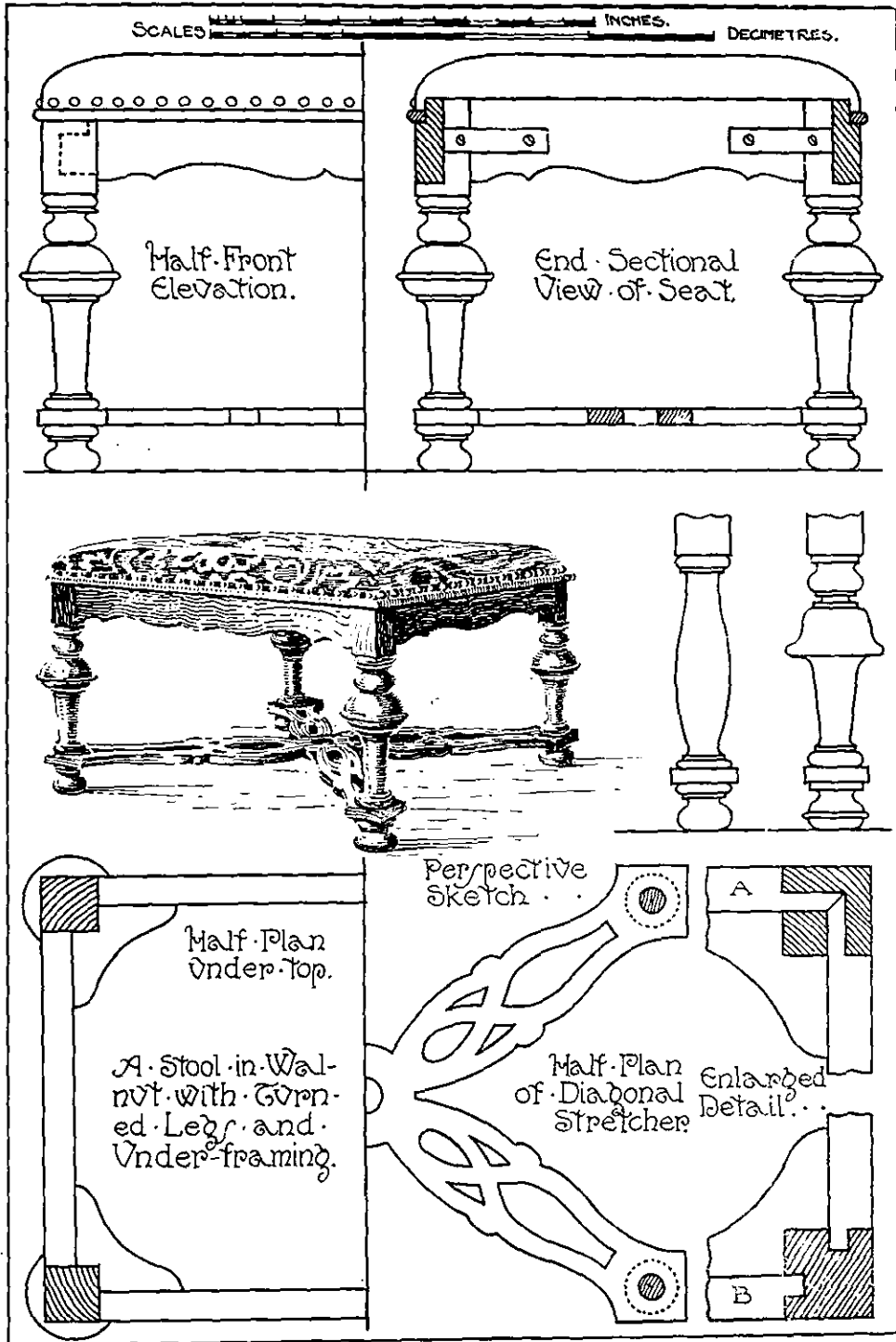

FIG. 4.—An upholstered stool of Queen Anne style.

The Process.—Saw out and plane up to width and thickness the following material:—

	<i>English.</i>		<i>Metric.</i>
4 Legs	10½ in. × 2 × 2 in.	<i>Ital.</i> walnut	26 × 4·5 × 4·5 cm.
4 Feet	3½ in. × 2 × 2 in.	„	8 × 4·5 × 4·5 cm.
2 Long Rails	1 ft. 7 in. × 2¼ × 7⁄8 in.		48 × 7 × 2·25 cm.
2 Short „	1 ft. 1½ in. × 2¼ × 7⁄8 in.		34 × 7 × 2·25 cm.
2 Under „	2 ft. 2 in. × 3¼ × 5⁄8 in.		66 × 8 × 1·5 cm.
1 Moulding	6 ft. 3 in. × ¾ × 3⁄8 in.		165 × 1·75 × 1 cm.
For Brackets	1 ft. 8 in. × 4 × 7⁄8 in.	beech	50 × 10 × 2·25 cm.

1. Set out tenons on rails and mortises on legs, cut same. (Bare-faced tenon is employed, see detail A in sectional plan.)

2. Halve together the under-rails, glue together and level off.

3. Execute turning on legs and glue up rails and legs.

4. Level off top, gauge for rebates (see sectional view), and execute same.

5. Set out with templet the shaping on under rails, cut same, and finish with files and glass-paper, bore for pins.

6. Glue feet through rail into legs, clean up framing, and mitre moulding round rebate.

7. Cut and fix the angle brackets.

A, Fig. 5. Shows leg turned with groove to receive a separate bulb part, foot pinned through under-frame into leg.

B, Fig. 5. Shows an alternate design with similar constructive detail.

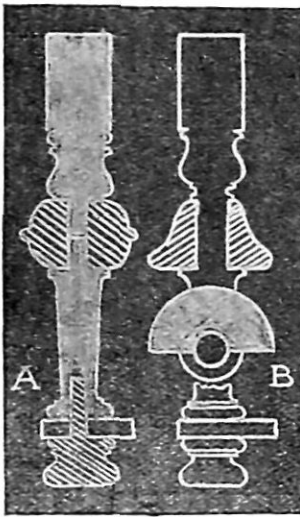

FIG. 5.—Diagrams showing construction of turned legs.

STATIONERY CASE (Fig. 6).

Note.—An advanced model introducing secret mitred and lapped dovetailing in carcase, with decoration based upon veneer inlaid and incised, with vee tool cuts filled with wax composition.

The Process.—Cut out and plane up to thickness the following material:—

	<i>English.</i>		<i>Metric.</i>
Top	1 ft. 5¾ in. × 7 × ½ in.	oak	46 × 18 × 1·3 cm.
Bottom	1 ft. 5¾ in. × 6½ × ½ in.	„	46 × 17 × 1·3 cm.
2 Ends	1 ft. 0¾ in. × 7 × ½ in.	„	31·5 × 18 × 1·3 cm.
Back	1 ft. 5¼ in. × 12½ × 7⁄16 in.	„	44·5 × 31 × 1 cm.
Front	10 in. × 11½ × 9⁄16 in.	„	28 × 30 × 1·5 cm.
Clamps	1 ft. 0 in. × 3½ × 9⁄16 in.	„	30 × 9 × 1·5 cm.
4 Feet	4¼ in. × 1¾ × ¼ in.	rosewood	11 × 5 × 75 cm.

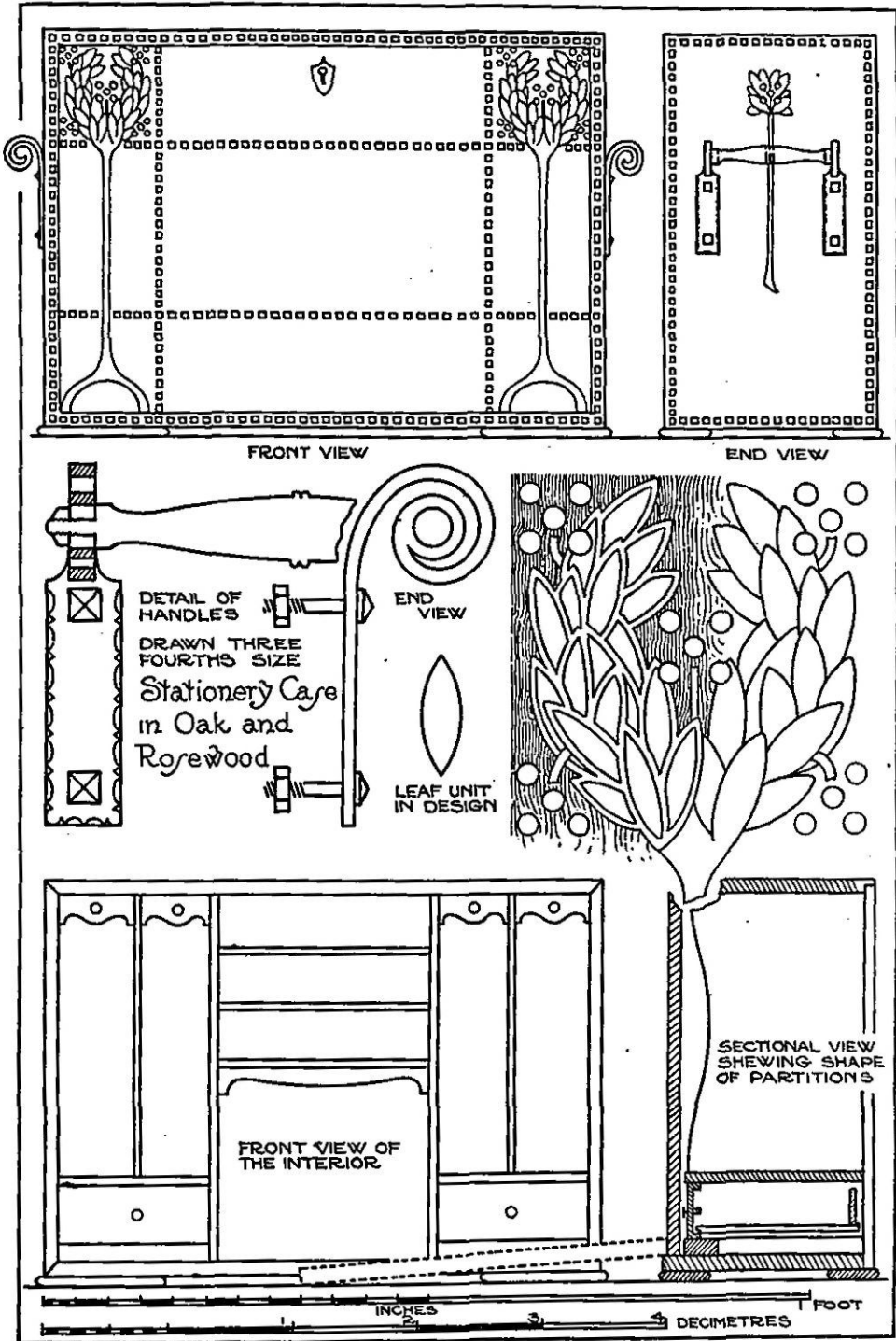

FIG. 6.

Interior.—

2 Vertical Divisions	1 ft. 0½ in. × 6 × ¼ in.	holly	31·5 × 15 × 75 cm.
2 Central "	9½ in. × 6 × ¼ in.	"	23·5 × 15 × 75 cm.
3 „ Horizontal Divisions	7 in. × 6 × ¼ in.	"	18 × 15 × 75 cm.
2 Side „ „	5¼ in. × 6 × ¼ in.	"	13·5 × 15 × 75 cm.
4 Arches	2½ in. × 1 × ¼ in.	"	7 × 2·5 × 75 cm.
1 Central Arch	7 in. × 1 × ¼ in.	"	18 × 2·5 × 75 cm.

1. Plane up top, bottom, and ends to length and width.
2. Set out mitred dovetail joints at corners per exercise following on A and B.

An Exercise in Mitred Dovetailing.

(a) Mark mitre lines as shown in Fig. 7.

(b) Gauge lines across inside of both pieces.

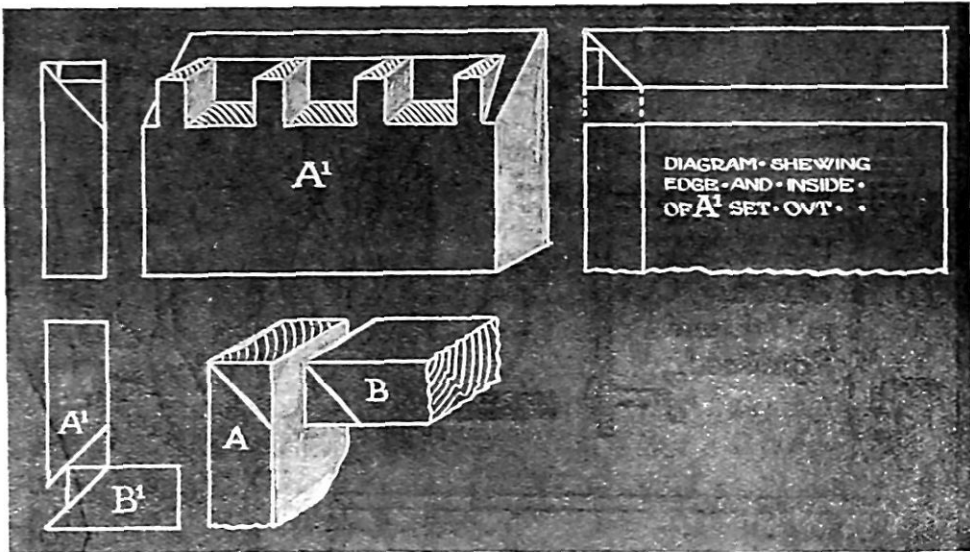

FIG. 7.—Diagrams showing method of setting out, etc.

- (c) Gauge and rebate lap.
 - (d) Mark out pins on A', cut same and remove waste.
 - (e) Place A' on B' in position shown, and with a marking awl mark position of sockets.
 - (f) Cut sockets and chisel out same, cut mitres and fit together.
3. Fit carcase together, take apart and rebate same to receive back.
 4. Mark and cut the grooves in carcase to receive the interior divisions.
 5. Clean up inside surfaces and glue together, fit and screw back in position.
 6. Clamp together the front (tongue worked on centre part, fitting into grooves on clamps).
 7. Glue together, level off when dry, and fit in opening.
 8. Fit up the interior, all pieces are housed ¼ in. deep into top divisions.

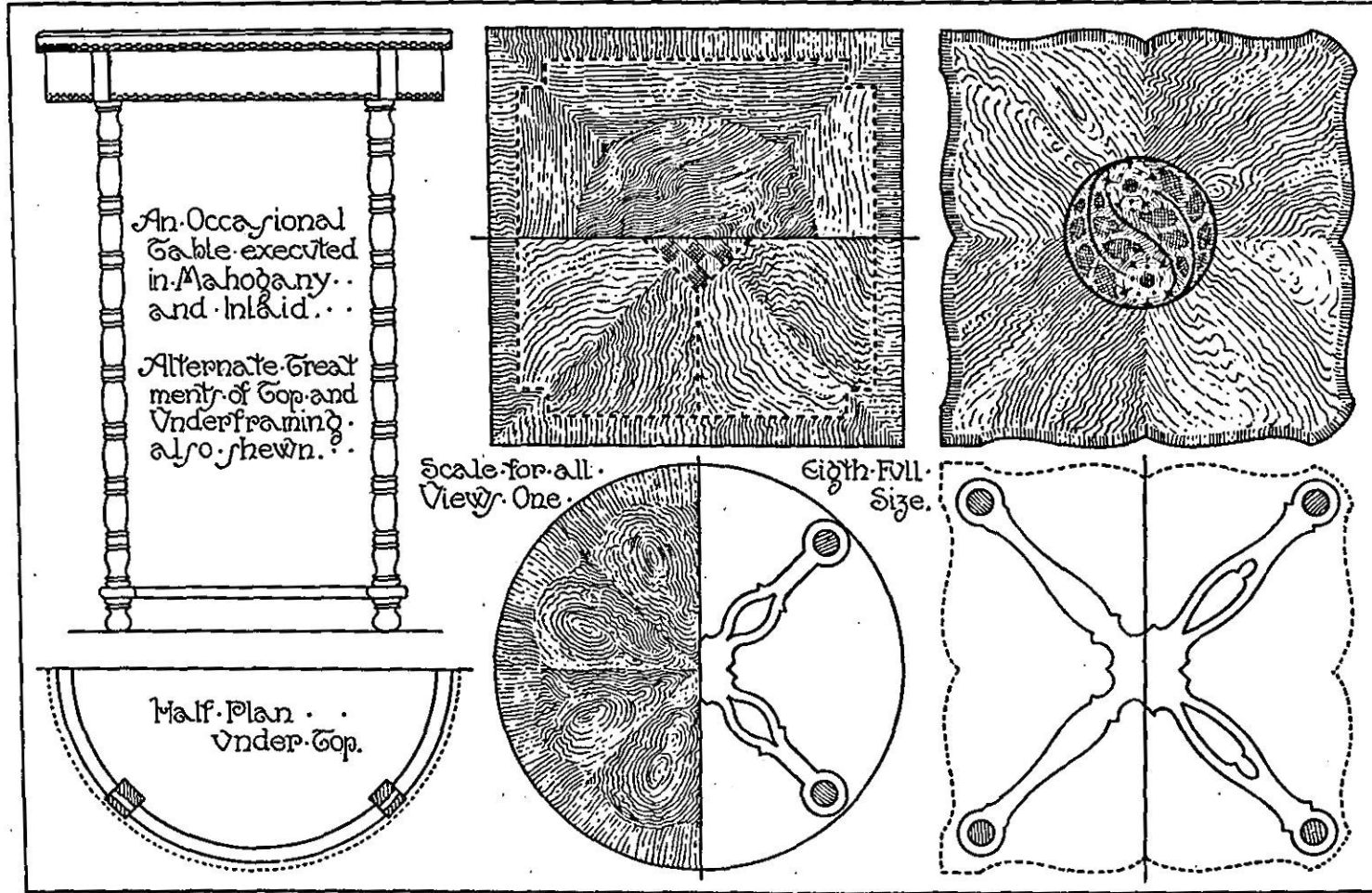

FIG. 8.

The Decoration.—Method of inlaying the mosaic stringing is described on p. 180. Veneers are used for the ornamental device; these should be cut to outline and inlaid level with the surface of the wood. When dry the leaves are indicated or outlined with vee tool cuts, and filled with composition (see also p. 182); the spots are executed with a drill and filled in with composition. The whole is then allowed to stand by and is then scraped and sandpapered. The inside of the fall should be lipped with veneer $\frac{3}{4}$ in. wide, the groundwork covered with morocco leather or skiver.

OCCASIONAL TABLES (Figs. 10 and 11).

The Rim.—The elevation and plan shows a suitable treatment for this type of furniture; a half-plan shows the method of forking the legs into the rim, a general constructive feature of circular and elliptical work. When building up the rim, a board of $\frac{3}{4}$ in. pine should first be planed up true, and the true shape of rim set out upon it. This is divided into four parts, one of which is duplicated in $\frac{1}{4}$ in. mahogany and constitutes the templet. The templet is used to mark out twelve pieces or segments, four for each layer, and each segment can then be spokeshaved exactly to the templet size. Next, one piece is fitted to the board and pinned in position, then the remaining three segments are fitted in and secured with pins, glueing the joints as one proceeds. This completes one layer, which is then planed true and toothed; the next layer is spaced so that the joints fall midway between those of the bottom layer, usually called brickwork fashion. As these are fitted, they are glued down and pressure applied with handscrews. When dry this layer is also planed and toothed, and the third layer fitted in the same relative position as the first (see diagram below).

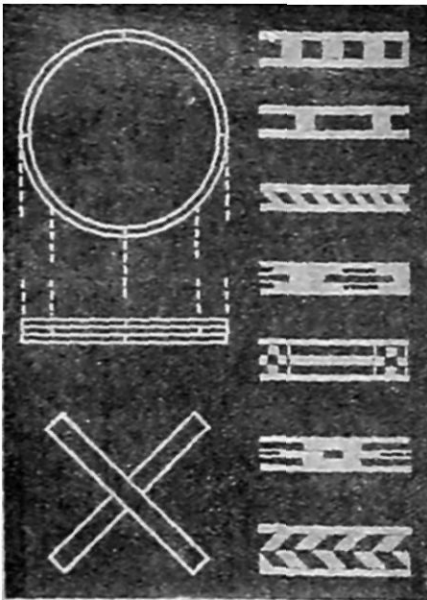

FIG. 9.—Plan and elevation of rim and various mosaic stringings.

The Legs should be planed up perfectly square to size, then marked for turning. A detail of the foot is shown in Fig. 8, from which it will be seen that the under-framing is secured by introducing a pinned foot which glues through the under-framing into the legs.

The Under-framing should be prepared in the form of an X. One piece is mortised right through to receive two short rails (see diagram, Fig. 2) tenoned into same. When this is fitted and glued together the design is traced to the wood, or as an alternative, a pattern of one-quarter

the shape is cut in cardboard, the remaining three parts being marked from this.

The Top can either be cut from solid material and veneered on both sides or laminated, viz. five-ply material can be adopted, in which case it is only necessary to veneer the top side. The veneer of the circular top shown on p. 55 is intended to be of the curl variety; eight pieces are used to form the centre part. These should be secured between two thin V-shaped pieces of wood during the process of cutting; the curved edge is finished with a fine file and the V shape is planed. They may then be separated and glued down to a sheet of damp stretched paper; the top is completed by fitting round the curved cross banding, glueing each segment down as they are fitted. The top is then veneered with this built-up work and the paper is removed with a toothing plane after the glue has dried. Cross banding on edge of top is best laid with a hammer.

Square Tables.—Various treatments are shown in Fig. 8 for the tops of square tables, the only different constructive feature of these types.

being the connexion of straight rails to the knee parts of legs. This is dealt with in reference to the table illustrated on p. 58 and described on p. 59.

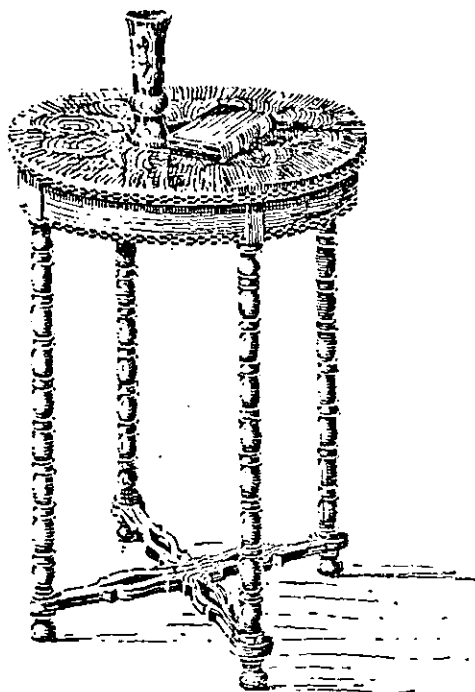

FIG. 10.—Sketch of circular table.

OCCASIONAL TABLE (Fig. 11).

Object.—A model to introduce simple general principles of table construction, the principles being similar to those necessary for hall, draught, chess, and writing tables, etc.

The Joints are all mortises and tenons, the “stubbed” type being utilized for the wide rails and connexion of under rails with the legs. In the case of the second example, showing two rails near the centre of the side-rails, small through mortises and tenons should be used, or the long rails can be shouldered and lap dovetailed into the short ones from underneath. The latter is very effective and prevents the shoulders opening; it has also the advantage of not showing the construction under ordinary circumstances.

The Process.—1. First saw out the wood, either mahogany or walnut, to the following sizes :—

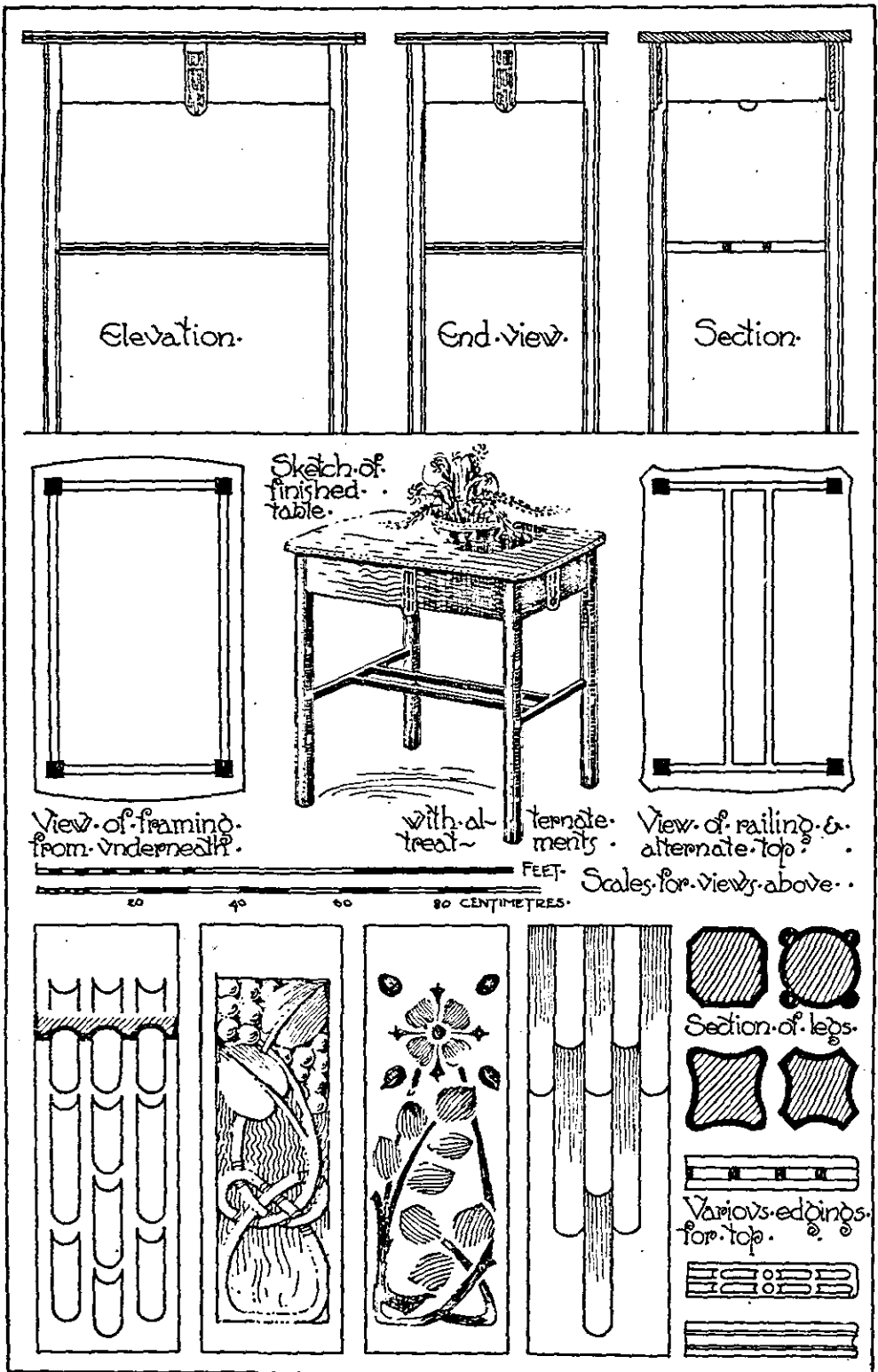

FIG. 11.—An occasional table.

	<i>English.</i>	<i>Metric.</i>
4 pieces legs	2 ft. 6 in. × 1 $\frac{3}{8}$ × 1 $\frac{3}{8}$ in.	79.5 × 3.5 × 3.5 cm.
2 long rails	1 ft. 10 in. × 4 $\frac{3}{4}$ × $\frac{7}{8}$ in.	58 × 12.5 × 2.2 cm.
2 short „	1 ft. 2 in. × 4 $\frac{3}{4}$ × $\frac{7}{8}$ in.	36.5 × 12.5 × 2.2 cm.
1 top	2 ft. 2 $\frac{1}{2}$ in. × 16 $\frac{1}{2}$ × $\frac{5}{8}$ in.	69 × 42.5 × 1.6 cm.
2 short bottom rails	1 ft. 1 $\frac{1}{2}$ in. × $\frac{7}{8}$ × $\frac{1}{2}$ in.	35 × 2.2 × 1.3 cm.
2 long „ „	1 ft. 9 $\frac{1}{2}$ in. × $\frac{7}{8}$ × $\frac{1}{2}$ in.	58.5 × 2.2 × 1.3 cm.
4 tablets	6 in. × 1 $\frac{3}{4}$ × $\frac{1}{8}$ in.	16 × 4.4 × 1 cm.

2. Plane up all material on face, side, and face edge, then to thickness.
3. Gauge and plane legs, top, and bottom rails and tablets to width.
4. Square up top to required size, or cut to shape if curved.
5. Place the four legs together and handscrew same together, then square across all required lines, viz. total length, and top and bottom mortise lines.
6. Separate the legs and square lines on adjoining inside faces.
7. Place rails together, two top and two bottom rails in each set and set off shoulder lines.
8. Separate the pieces, and return shoulder lines on all wide faces, back and front. Then mark mortise and tenon lines on all pieces.
9. Cut out the mortise and saw the tenon lines and shoulders; fit two long sides together, and when adjusted satisfactorily, clean up all parts and glue up.
10. When the latter are dry fit in all short rails, clean up the various pieces and glue between the long sides. It should be measured on the diagonals of plan and elevation to ensure the whole being properly square.
11. Cut and glue in tablets, then saw off spare wood of legs at top and bottom and plane top side true. Prepare pockets for screwing through rails into top.
12. Shape and inlay top if required, clean up and fix by pocket screwing from inside the rails.

The Decoration.—Various treatments for the decoration of the tablet are shown. The first consists of simple gouge tooling. The second shows a design for carving, which would first be cut to outline and grounded out, then modelled on leaves, stem, berries, etc., with gouges. The third example shows inlaying in various woods, and the last an alternate arrangement of slips of mother of pearl, three in top row, two in the second, with a single terminal piece. This decoration is fairly simple, and very effective when used in combination with brown oak, American or Italian walnut.

Four details of moulded legs are shown. The introduction of either of these would involve more difficult construction; generally, the rails would have to be set farther back from the face sides, those below being spaced exactly in the centre of the moulded side. The chamfered example should be stopped just below the rail, as is shown in the elevations.

CHAPTER VI

FIRST YEAR MODELS (METAL)

ESCUTCHEONS.

Their Use.—Used to protect the keyholes cut in doors so that the holes do not get broken away by continually putting the key into the lock. When made with a cover they prevent dust getting into the lock.

The Process.—1. To be cut out of 14 or 16 I.S.W.G. brass and outline filed to shape with bastard and smooth files.

2. Drill holes for screws and keyhole.

3. Trim off the burr and file keyhole to shape.

4. Hold the escutcheon on a flat piece of wood by means of pins round the edges.

5. Face up with bastard and smooth files.

6. Chamfer where necessary, then add the decorative features.

7. Polish, stam, or lacquer, as required.

The Decoration.—The top line on page 61 shows decoration by means of an outline of pleasing form.

The bottom line shows how chamfering may be used as a decorative feature, additional to the outline.

The top line on page 62 is where simple lines, dots, and curved chisel marks are utilized as decorative motifs.

The bottom line on the same page gives a more difficult example of piercing with a fret saw; the second one shows a simple form applied and fixed by small rivets; this form is also shown on page 73; the third one is a covered escutcheon. A pattern would be made of this cover, and a casting obtained, then filed up and riveted together, so that the weight of the cover would allow it to drop into its correct position after the key was removed from the lock.

With regard to setting out the keyhole, a line should be drawn down the centre of the escutcheon, and the centre dots for marking the holes to be drilled should be placed on this line. This keyhole could also be punched out, or cut out with a fret saw (see page 104 for fret saw and method of using it).

The decorative screw heads, with one exception, are ordinary screws filed to the shapes suggested. The last one, with the row of pearling round the edge, would be cast and the pearls chased up by hand.

Special Features.—Although the escutcheon is taken as an example of how it is possible to add difficulty and a new tool operation in successive steps to a simple form, there are many other objects that can be treated in a similar manner.

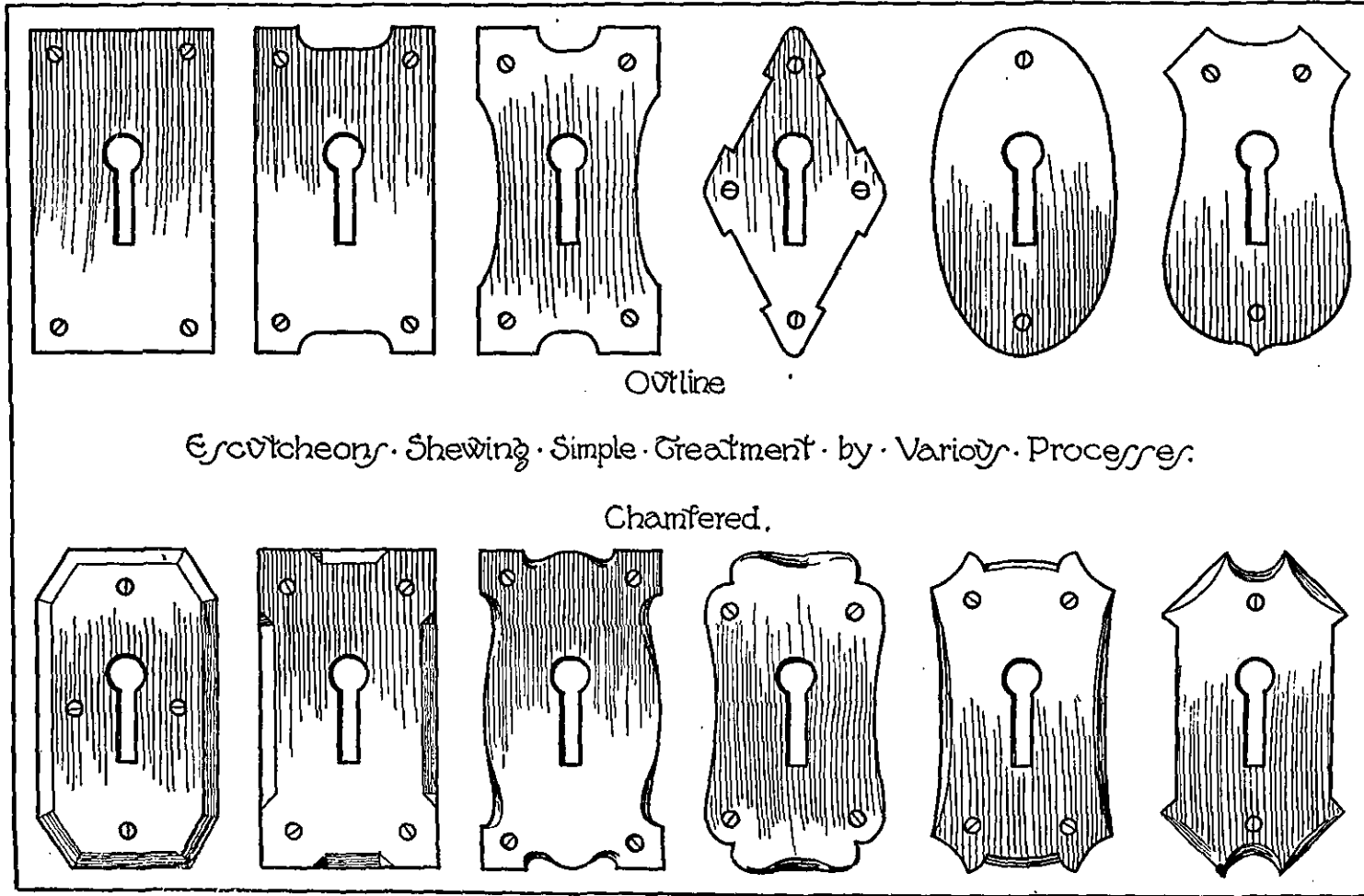

Outline

Escutcheons. Showing Simple Treatment by Various Processes.

Chamfered.

FIG. 1.—Examples of simple escutcheons.

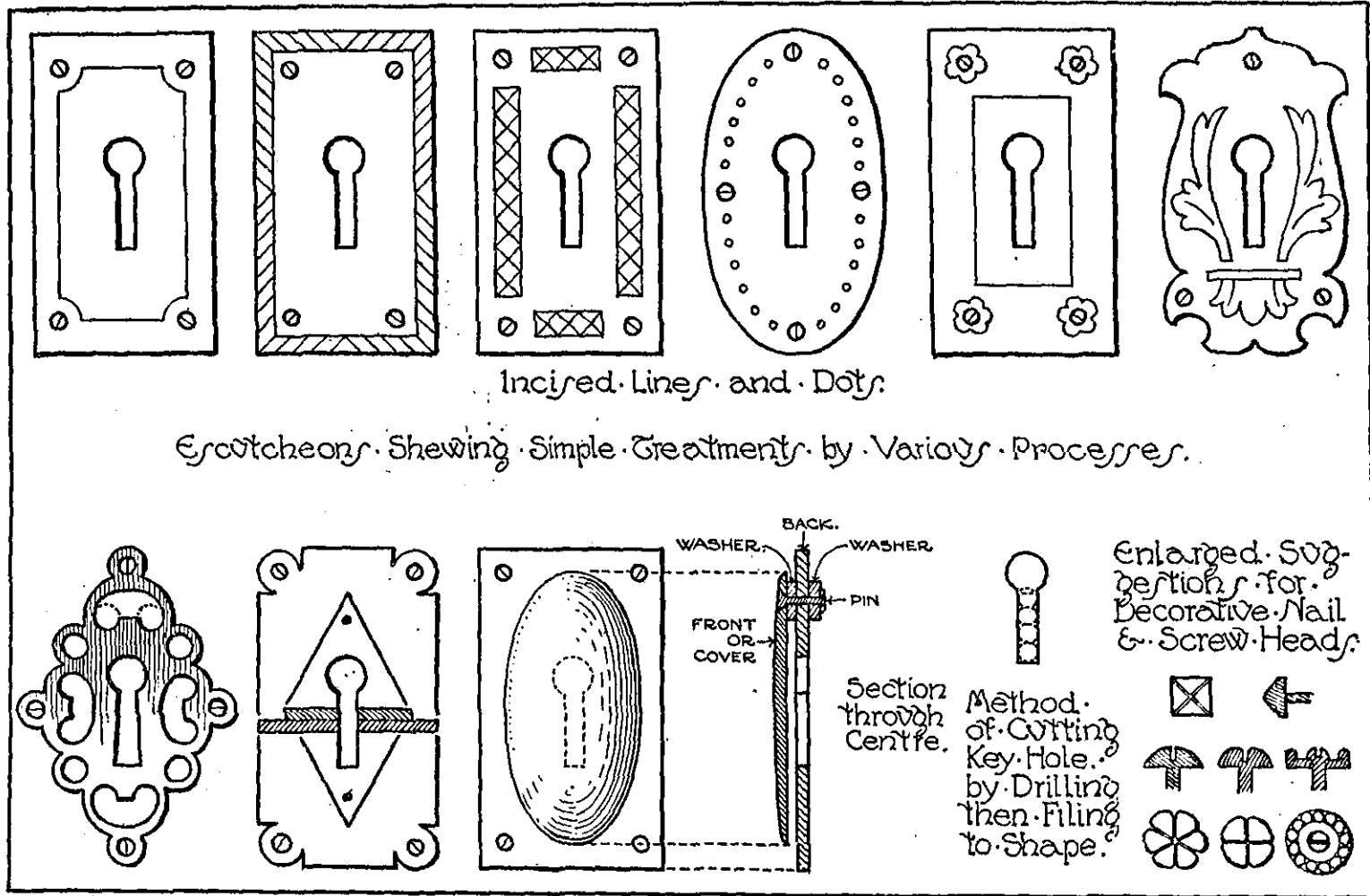

Incised Lines and Dots.

Escutcheons Showing Simple Treatments by Various Processes.

Enlarged Suggestions for Decorative Nail & Screw Heads:

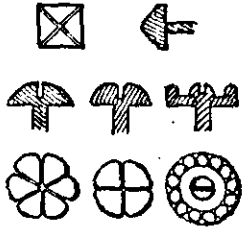

Method of Cutting Key-Hole by Drilling then Filing to Shape.

FIG. 2.—Examples of decorated escutcheons.

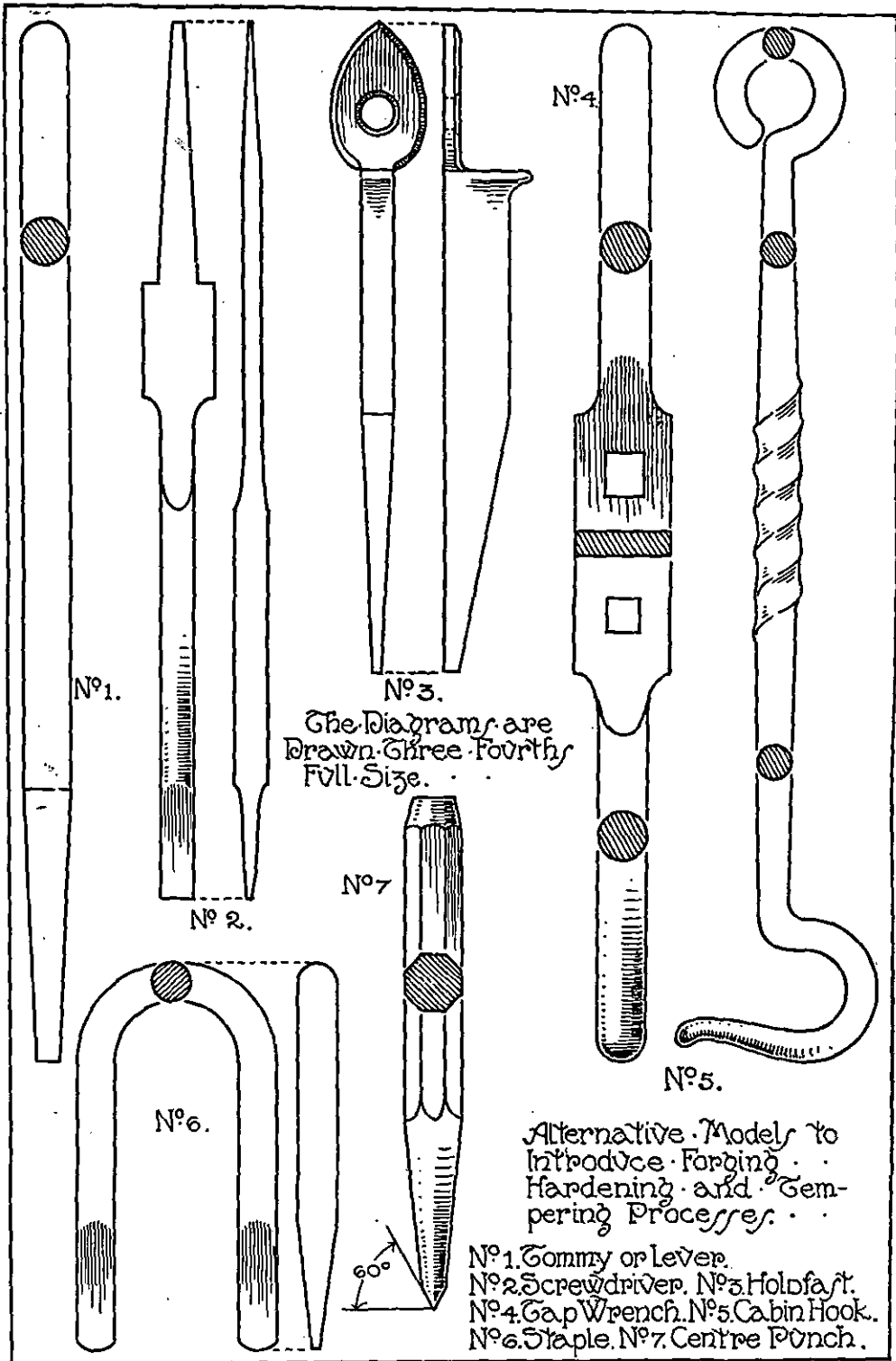

FIG. 3.—Models for forge practice.

METAL MODELS: TOOLS, ETC. (Fig. 3).

Object and Uses.—A collection of easy models suitable as exercises in forging. Their various names convey their uses.

No. 1. Tommy or Lever.

This should be made from steel and not cut off until it has been drawn down. $\frac{3}{8}$ in. round tool steel about 2 ft. 6 in. long, suitable for holding without the use of tongs, is a convenient size. Should be left from the hammer and not filed up.

No. 2. Screwdriver.—Made in the same way as No. 1, but for spreading the wide part, a fuller, placed lengthwise down the rod, should be used. $\frac{3}{8}$ in. square tool steel would be suitable. Draw the round portion down first, then fuller out to width, cut off, and draw down tang. Shape with hammer as much as possible, trim up with bastard and smooth files, finish off on emery bob, then harden and temper point to a dark brown.

No. 3. Holdfast.—This is a forging exercise, and a file should not be used on it.

Have a suitable piece of $\frac{1}{2}$ in. \times $\frac{1}{4}$ in. iron, heat to a welding heat and slightly up-set the end, then place end on anvil and flatten. Shape up with a set hammer and work up projecting piece (this is the difficult part); draw away and roughly point, and punch the hole while hot. Cut off, and finish, drawing down the point. If preferred the processes could be reversed, that is, the point drawn out first.

No. 4. Tap Wrench.—According to the size of the holes required, so choose the iron. Draw down and round up one end, repeat for other end, then cut off to length; round up ends and punch the holes, driving a parallel drift through to finish. Should not be touched with a file.

No. 5. Cabin Hook.—Use $\frac{3}{8}$ in. square iron. Draw down and round the end, bend up the eye as shown on page 73, Fig. 8, to the size required. Cut off the length required, draw down and round end for hook. Bend up the hook and cool out. Heat in centre and twist as shown on page 85.

No. 6. Staple.—Cut off to correct length, then draw down the ends and bend to shape. To make this a little more difficult, weld two pieces together and see that the weld comes in the middle of the bend, then draw out the ends and bend to shape while cold.

No. 7. Centre Punch.—This should be made from $\frac{7}{8}$ in. square tool steel and drawn down to shape and cut off to the length required. Trim up with bastard and smooth files, harden and temper point to a dark brown. This should not be put in the lathe to make the end circular, it should be done by hand.

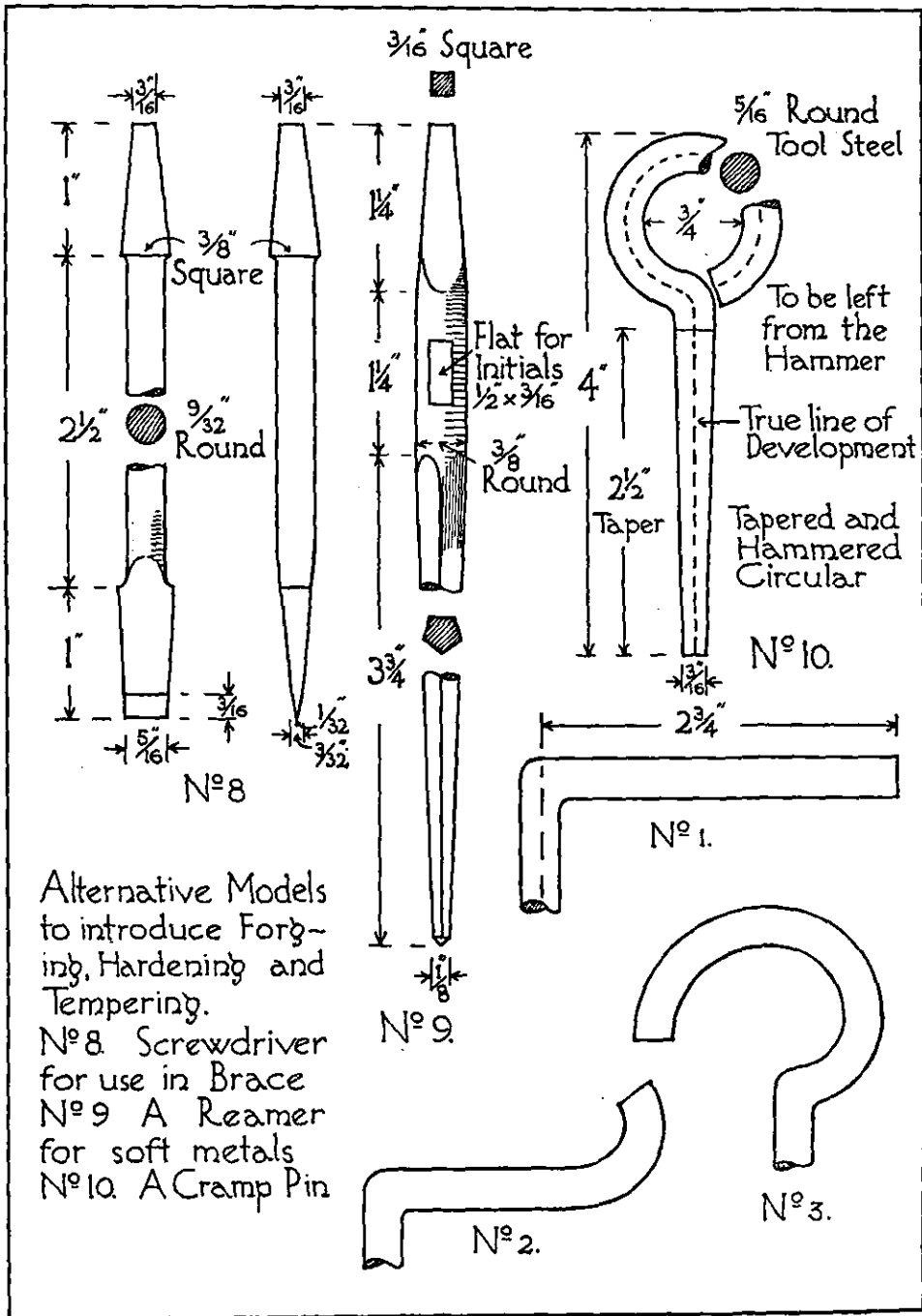

FIG. 4.—Models for forge practice.

SMALL TOOLS, ETC. (Fig. 4).

No. 8. **Screwdriver Bit.**—This should be made from $\frac{3}{8}$ in. square tool steel, the blade should be drawn down to shape, then the centre-piece rounded with the hammer, finishing off with top and bottom swages. Cut off to length, hold blade in the tongs, and hammer down the square end to the sizes drawn. File up all over and to size, using bastard and smooth files, harden and temper blade to a purple colour.

No. 9. **Reamer.**—Use $\frac{3}{8}$ in. round tool steel. Draw down the tapered end and cut off to length. Hold tapered end in tongs and hammer end square to the sizes drawn. File up to shape and sizes as drawn, using bastard and smooth files. See that it is straight. Finish off as smooth as possible and keep faces of reamer perfectly flat. Harden and temper reamer to a dark brown colour, then “blue” the squared end. When hardening, dip reamer vertically into water to avoid warping. - Temper by means of the sand-bath method. See p. 216.

No. 10 **A Cramp Pin.**—This is purely a forging exercise, and only the extreme ends should be filed.

Obtain a convenient length of $\frac{5}{16}$ in. round tool steel and draw down the tapered portion, measure off length and bend portion of metal for eye to a sharp right angle, now measure off material for eye, and cut off to length. Bend up the eye as illustrated on page 73. Anneal all over, and cool off slowly by burying it in ashes or lime.

The preceding models involve all the elementary forging exercises, and give good practice in the use of a hammer; the file should be used as little as possible.

The illustrations in Fig 5 show the correct position to take when performing various operations. The position of the feet for instance in (1), (2), (3) being most important, for unless the operator is standing correctly the work cannot be done efficiently.

(1) Illustrates a piece of square iron being held in the tongs while the end is being upset or thickened. This operation frequently occurs in working iron, and it should be noticed that the tongs fit and grip the work so that it cannot slip. The same position applies when holding a bar of iron.

(2) This shows the position to be taken when bending iron. The fork fits into the square hole in the anvil and the operator is holding a scroll in the left hand and a scroll wrench in his right hand. By this means plenty of power is obtained, and a large amount of curved work can be done cold.

(3) This illustration shows the method of standing, and using a top and bottom swage and a sledge hammer. The operation being performed is “rounding up a tenon on a piece of $\frac{3}{4}$ in. square iron”. It should be noticed that in using all kind of top tools, hot setts, etc., the top tool should be at right angles to the work.

(4) Shows the correct method of holding a hammer and chisel when chopping out. The usual fault in the use of a hammer is that it is not lifted up high enough to do its proper work. The reproduction shows the natural position assumed when the hammer is used by a skilled craftsman.



(1) Upsetting.



(2) Bending.



(3) Swaging.



(4) Chopping out.

FIG. 5.

METAL MOUNTINGS FOR A CHEST (Fig. 6).

ANGLE AND CORNER PLATES.

Object and Uses.—Used for the strengthening of chests and also form an ornamental feature. Introducing development of surfaces.

The Joints.—When the corner plates are bent up they form what is known as a "close joint".

The Process.—As a number of plates would be necessary to furnish a chest a template would be required. This could be made from some thin sheet metal, and should be arranged so that the bending lines could be scribed through.

1. These should be made from 16 or 14 I.S.W.G. metal. Lay the templet on and hold with a hand vice and mark round it with a scriber.
2. Cut out to shape, either chisel or saw pierce.
3. Punch or drill holes for screws and punch or engrave ornament.
4. Anneal so that material is soft, and dress up.
5. Bend up to shape and test with a set square.
6. Polish and lacquer if necessary.

The Decoration is either by punched holes, raised ornaments of simple form, piercing, and engraved lines which can be done with a chisel, a graver, or a tracer.

Special Features.—A very simple model which gives good practice in simple setting out and development of surfaces. If only one was being made, a templet would not be necessary, but the whole thing could be set right out on to the metal. This model admits of many variations.

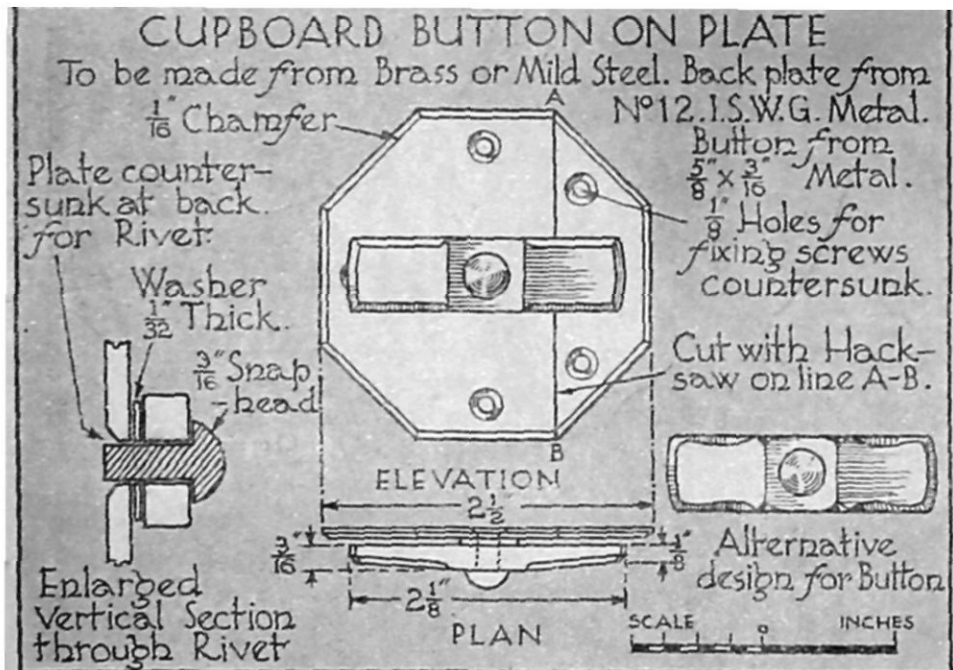

FIG. 5A.—A model introducing setting out, filing, drilling, and riveting.

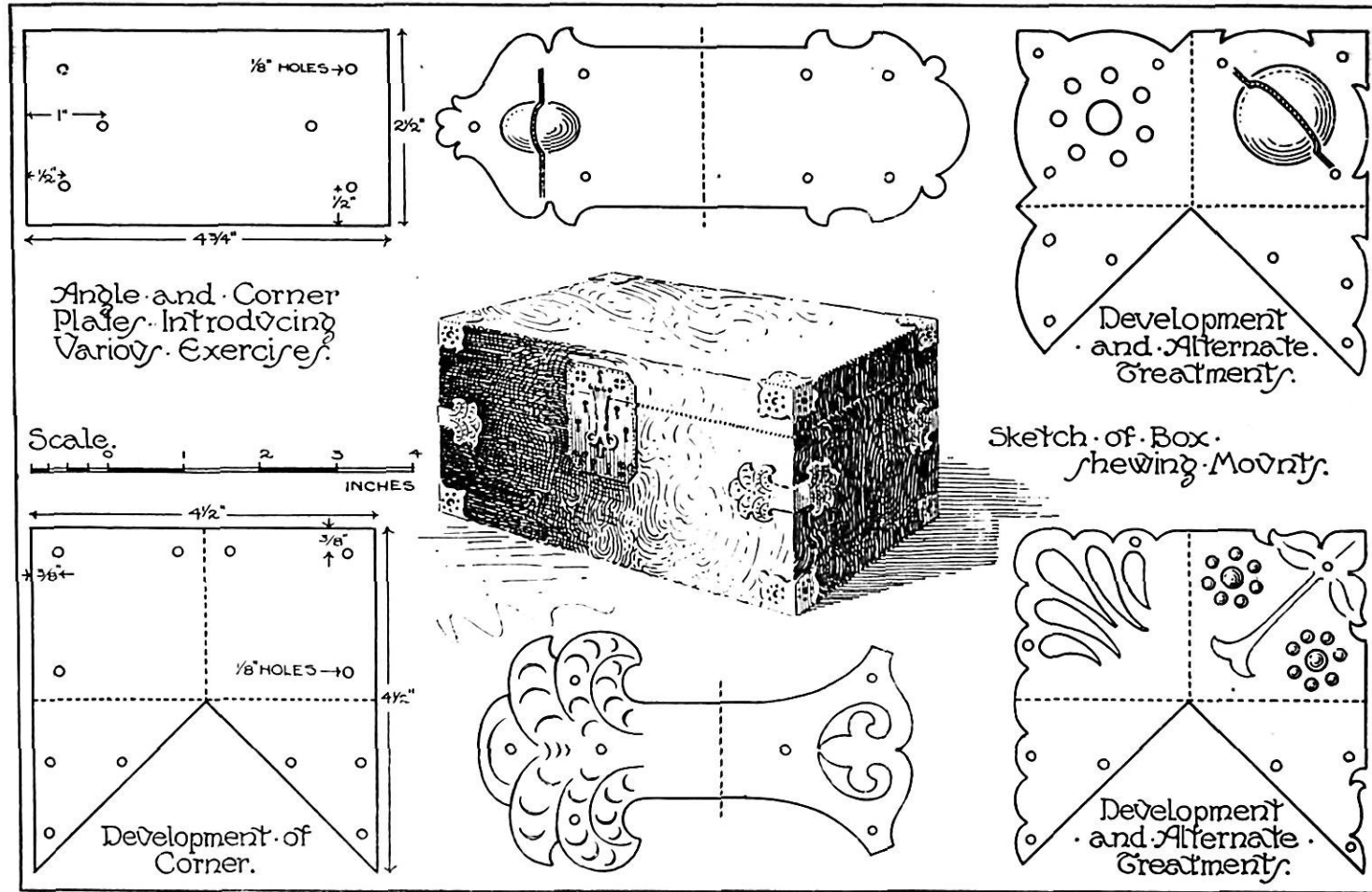

FIG. 6.—Suggestions for straps, angle plates, or corner plates, also development.

A SCHEME OF WORK: METAL APPLIANCES (Fig. 7).

Object and Uses.—A course of graduated models; introducing many processes and arranged in order of difficulty.

The Joints.—The methods of joining metals involved in the various models are as follows: Nos. 3 and 4 riveted joints; No. 8 plain lap and soft-soldered joints; No. 10 brazed lap joint; No. 11 tenoned and riveted, halved and riveted joints; No. 12 butt and clipped joint.

The Processes.—No. 1. **A Grinding Gauge.**—Is used for testing the angles of tools, 110° and 60° for drills, 60° for chisels and centre punches, 70° and 80° for turning tools.

It should be made as follows: Use No. 12 I.S.W.G. iron; mark out with a brass scribe, cut out with a chisel, leaving the lines just showing, file down to the lines, using bastard files. Test with try square, protractor, and bevel, or with a bevel protractor. Face up on both sides with bastard and smooth files. Centre punch and drill hole, fine finish face and edges with emery cloth held or glued on a flat piece of wood. Lay gauge on a polished iron surface and punch figures to indicate size of angle with figure punches.

No. 2. **A Diamond-pointed Drill.**—Draw out, cut off to length, file up to shape, harden and temper to a dark brown; grind cutting edges up on grindstone.

No. 3. Outside Calipers.—

1. Make a drawing of the calipers to the size required.
2. Make a tracing of one leg and transfer to a piece of thin metal for a templet by means of carbon paper, or chalking the back of the tracing, laying on the metal, and going over the lines with a bone point
3. Go over the lines on the metal with a scribe.
4. Centre punch the centre of joint and describe the circle with compasses, then cut out the templet, working to the drawing as accurately as possible.
5. Mark out with a brass scribe on No. 12 I.S.W.G. iron the two legs, using the templet just made.
6. Cut out with a chisel, leaving the line in.
7. Drill a small hole in the centre of each joint of the legs and slip them on a pin.
8. File up both legs while they are together on the pin.
9. Flatten the legs and face them up both sides with bastard and smooth files.
10. If right sized washers cannot be obtained make them from the same material as that used for the legs.

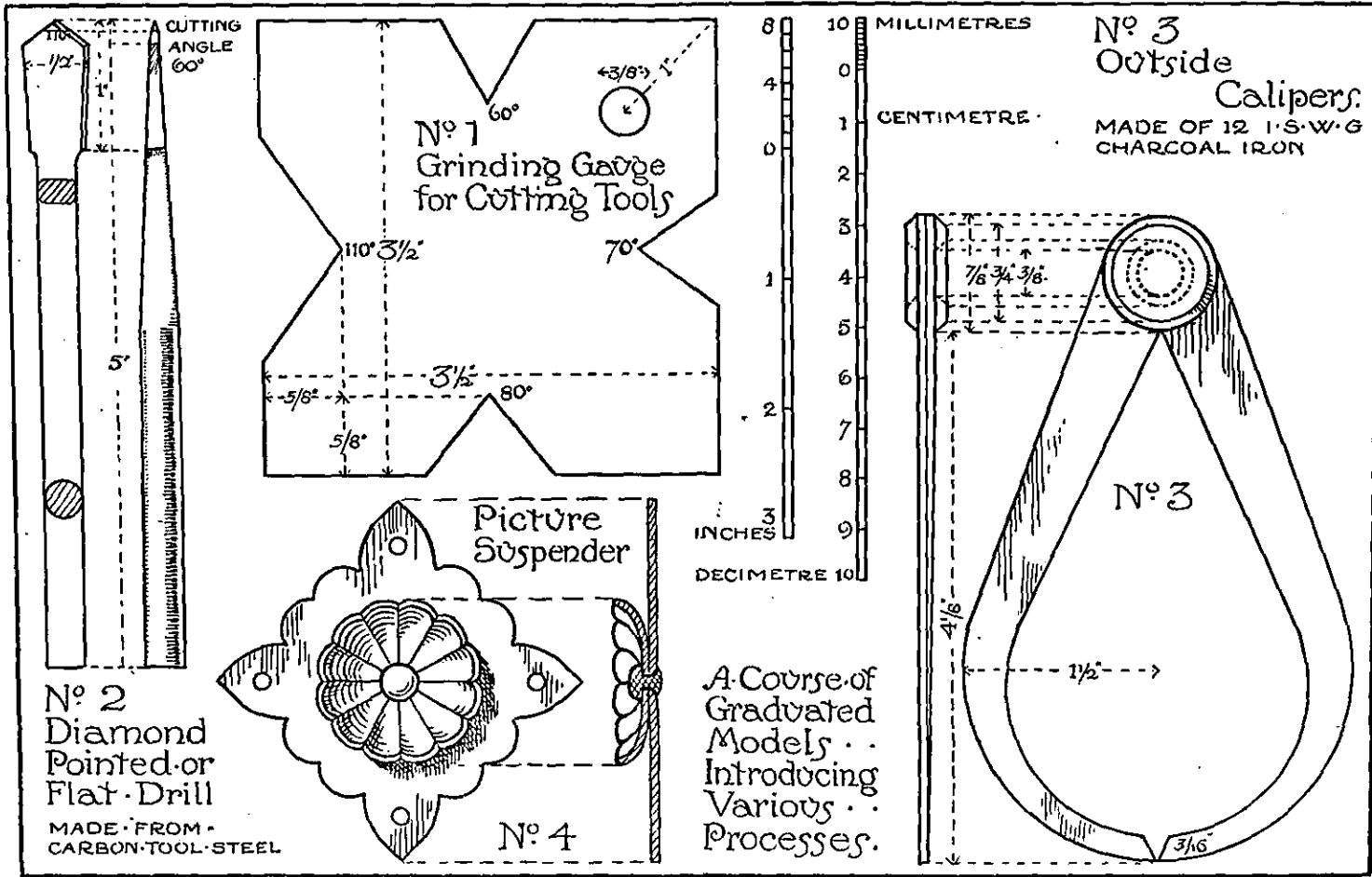

FIG. 7.—A suggested course of models.

Fig. 7, No. 3 (continued).

11. Cut off a piece of $\frac{3}{8}$ in. round iron for the rivet, square the ends and anneal it.

12. Drill the holes in the legs, and the washers to fit the rivet, and countersink the holes on the sides that will be outwards.

13. Put rivet in position and burr over with a light hammer completely filling the countersinking.

14. Face off the outside of rivets and fine finish the calipers with emery cloth.

No. 4. Picture Suspender.—The back should be made from 16 I.S.W.G. and the rose from 18 or 20 I.S.W.G. metal. The fluting of the rose could be left out if necessary.

1. Make templets for back and rose.

2. Mark out the back, using templet.

3. Cut out and file up to shape.

4. Mark rose out on metal, place on the pitch, and work it up from the back and front with punches.

5. Cut rose out and drill holes in back and rose, and anneal the rivet.

6. Polish, stain, and lacquer as required, including the rivet.

7. Rivet together by placing rivet in a hollow tool which is held in the vice.

Fig. 8, No. 1. Cold Hand Chisel.—Should be made from hexagonal tool steel.

1. Take a convenient length of steel and draw out the point.

2. Cut off to length.

3. Trim up the end, and file cutting edge to correct angle, using the grinding gauge.

4. Harden and temper cutting end to a dark brown.

5. Finish off on emery bob.

No. 2. Finger Plate.—Could be made from 12, 14, or 16 I.S.W.G. material.

1. Cut off the material to the correct size.

2. Engrave the line, face up, then go over line again.

3. Set out the ornamental top, raise it on a lead block, cut it out, drill the holes.

4. Fit ornamental top to the plate mark off the holes and drill the plate, slightly countersinking the holes at the back, drill fixing holes.

5. Polish, colour, or lacquer as required.

6. Put top on to plate; put rivets in, one at a time, holding rivets in cup tool and lightly burring over at the back.

No. 3. Steel Scriber.—Should be made from $\frac{1}{4}$ in. square tool steel.

1. Cut off material and draw down both ends as shown in Fig. 2.

2. Cut off to correct length. Bend one end at right angles (Fig. 3).

3. Make eye, Figs. 4 and 5.

4. Twist centre as shown in Fig. 2, p. 85.

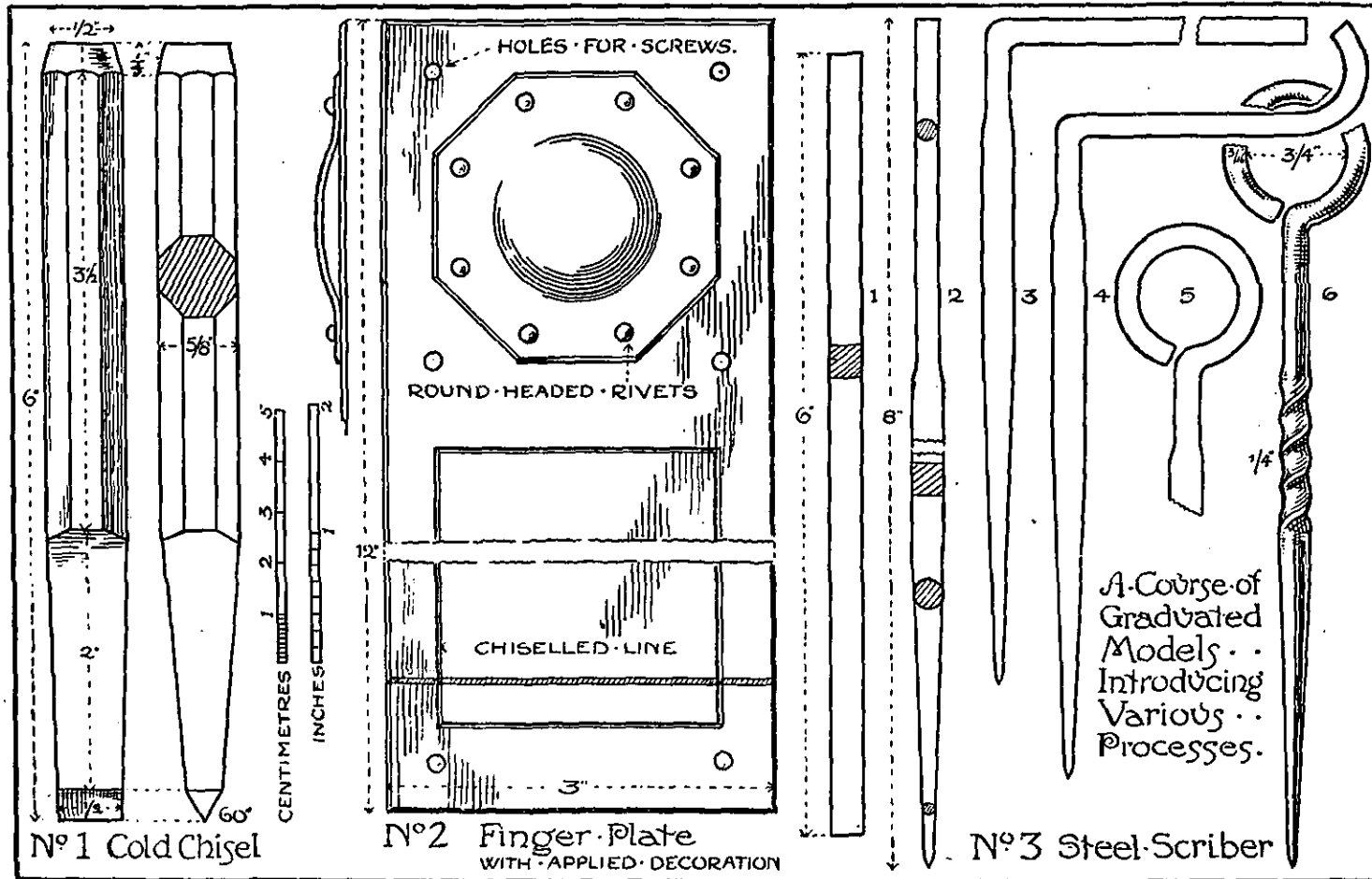

FIG. 8.—A suggested course of models.

5. Clean up, harden and temper point to a dark brown, if for use on soft metals to a light brown.

Fig. 9, No. 1. A Rectangular Box.—No. 22, 24, 26, 28 I.S.W.G. sheet metal should be used for this.

1. Set out the development of the body and the lid on the metal.
2. Cut them out clean with the shears.
3. Bend up to shape, using a folding machine, bending clamps, or a hatchet stake.
4. Tack the bottom part in a few places with solder and soldering iron, examine it for squareness, etc., then solder the seams neatly together.
5. See the lid fits true, then solder the seams neatly.
6. Wash well in potash and hot water and dry out in sawdust.
7. Polish if required.

No. 2. A Pin Cutter.—Size of material to be used depends on the size of the cutter; the one illustrated could be made from $\frac{3}{8}$ in. square tool steel.

1. Spread end for cutter with top fuller.
2. Round the shank and cut off to length.
3. Draw down the taper square.
4. File the cutting end to the correct shape.
5. Harden and temper the cutting end to a dark brown.
6. Finish cutting end on grindstone and gloss up on emery bob.

Fig. 10, No. 1. A Corner Clamp.—No. 18 I.S.W.G. metal would be suitable for this.

1. Set out development on metal.
2. Punch the holes.
3. Cut out to shape.
4. Bend to correct angles, and see the corners where they overlap lie close together.
5. Braze the corner and clean off with a file.
6. Finish as required.

No. 2. An Iron Grille.—Used for protecting windows.

1. Make a drawing to the size required.
2. Cut off all the material a little longer than is actually required.
3. Make the frame by setting out all the necessary holes and drilling them.
4. Make the tenons on the various bars by sawing down and filing, and fit them tightly to the holes, seeing that the shoulders come up square. Check sizes.
5. Twist the centre bars. Note, two right handed and one left handed.
6. Mark off and make the halved joints; see they fit together neatly.
7. Drill the holes in the halved joints for the rivets, anneal them, and rivet all centre part together.
8. Put on the frame, riveting corners up first.
9. Rivet up other tenons, and trim off excess metal.

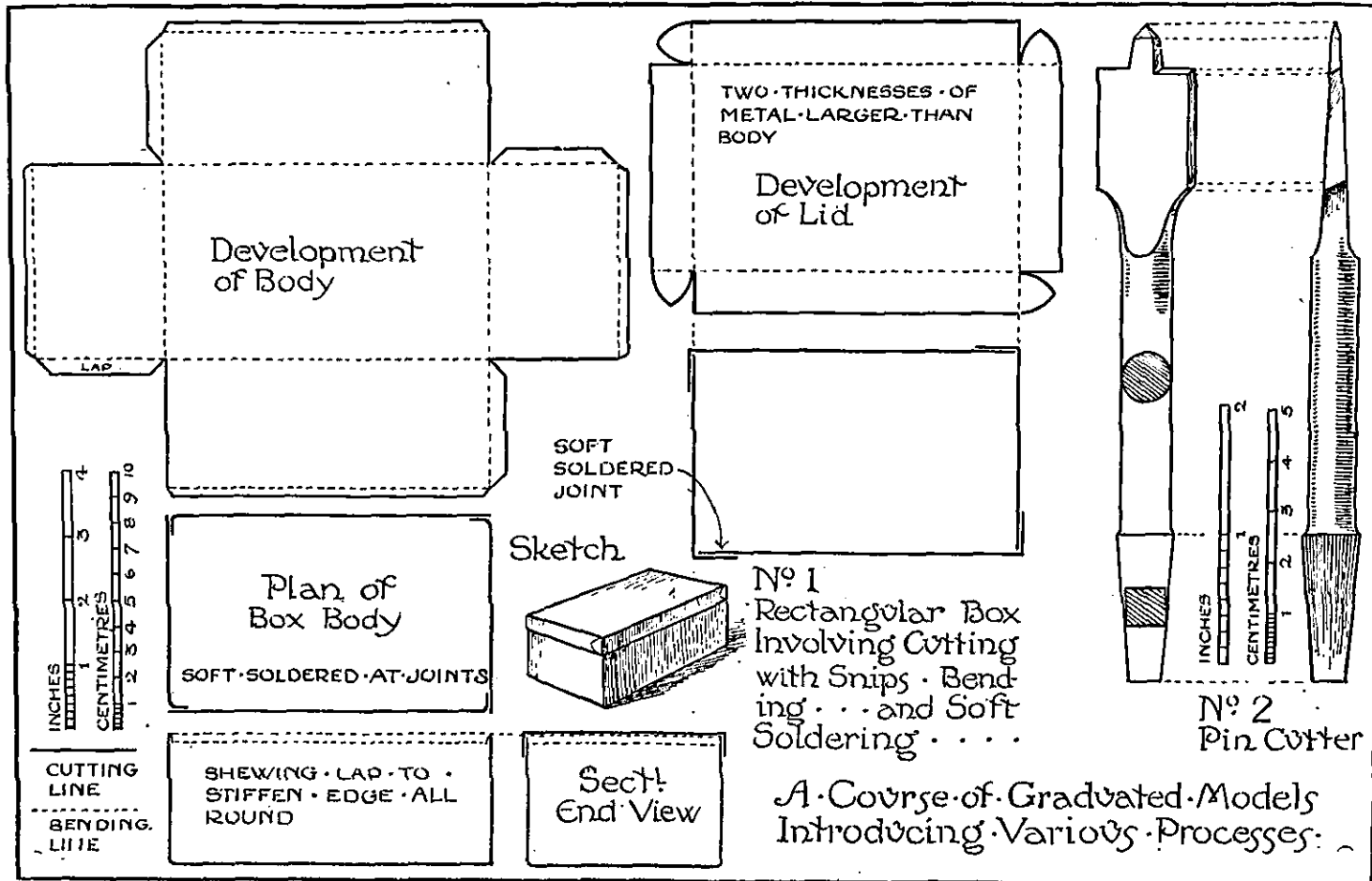

FIG. 9.—A suggested course of models.

Fig. 10, No. 2 (continued).

10. Coat with boiled oil, which should be applied boiling hot and allowed to set hard.

11. Paint the colour desired.

No. 3. A Ring Drop Handle.

1. Make a drawing to the required shape and size.

2. Make templet of back-plate.

3. For the handle shown $\frac{1}{4}$ in. round for the ring and No. 14 I.S.W.G. for the back-plate would be suitable.

4. Raise centre of back-plate, punch slot hole for the clip, then cut out to shape, marking this off the templet.

5. Bend ring, file the pin, and make the clip as illustrated on p. 74.

6. Fit clip and ring to slot-hole, and see that it hangs square and at an equal distance from the back-plate.

7. Drill screw holes, in back-plate and smooth it up if necessary.

8. Chamfer back-plate.

9. Polish, colour, and lacquer back-plate and ring.

10. Put together, and tightly bend over the clip.

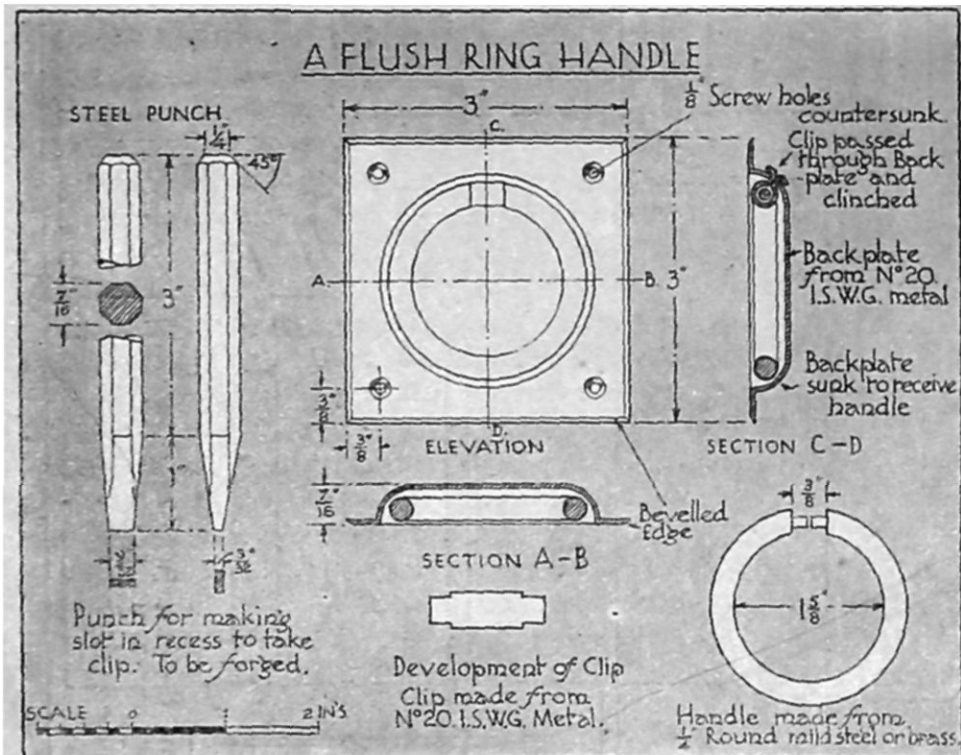

FIG. 9A.—A suggested alternative to model No. 3 on page 77.
This introduces simple raising in brass.

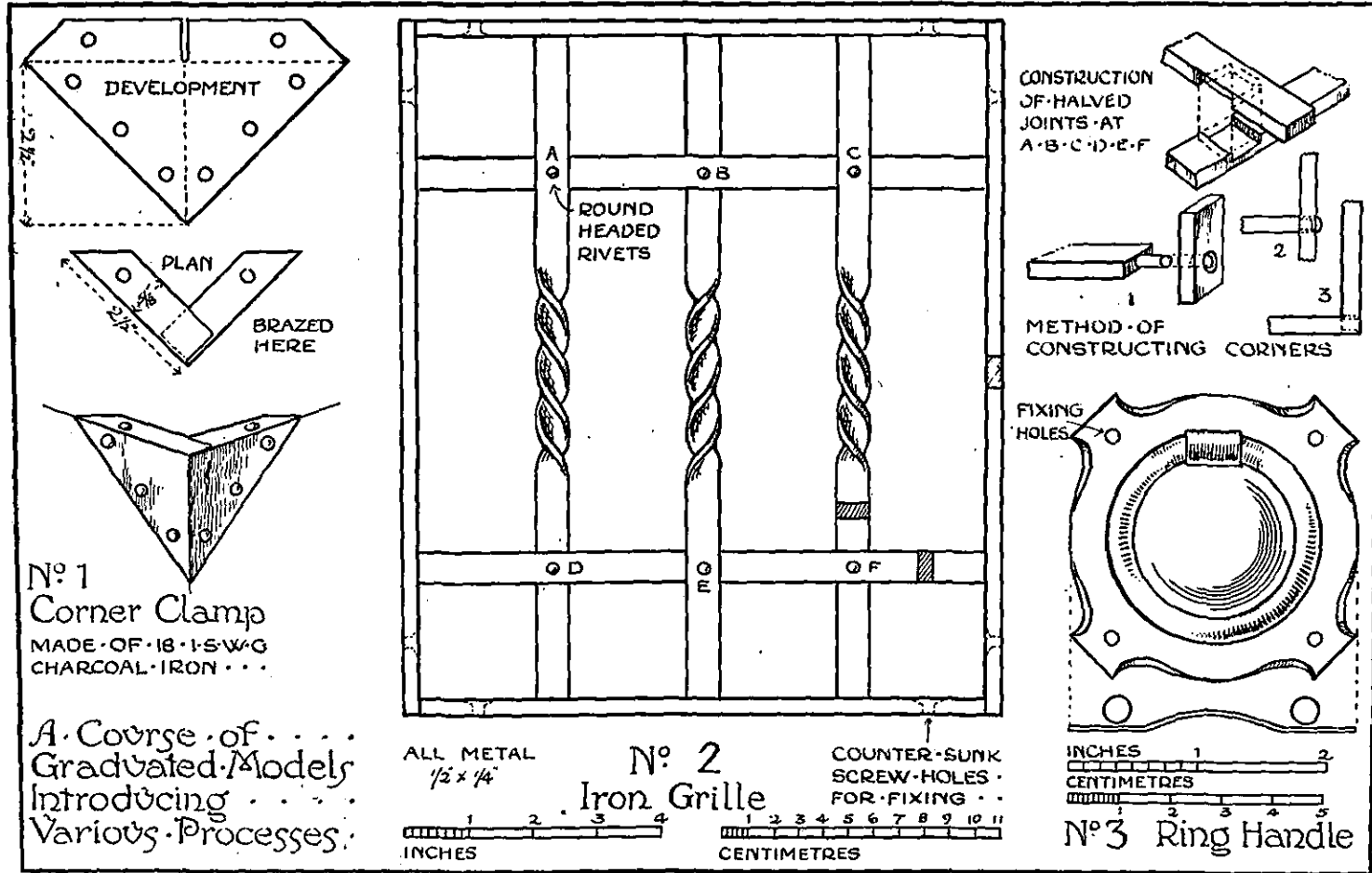

FIG. 10.—A suggested course of models.

CHAPTER VII

SECOND YEAR MODELS (METAL)

ASH TRAYS AND PIN BOWLS (Fig. 1).

Object and Uses.—A collection of simple models introducing raising, silver soldering, brazing, soft soldering, and twisting wire for edging.

The inventing of a simple border ornament, and making the tool for doing it. An elementary lesson on wood turning, and the use of templets.

No. 1. AN ASH TRAY.

Method of Procedure.—

1. Mark out the ash tray on a piece of No. 20 I S W G. Metal.
2. Make a templet of thin metal for the shape and depth of hollow in the wood block.
3. Make a wood block about 7 in. square by $1\frac{1}{4}$ in. thick and sink a hollow in the centre by turning or with a gouge, working to the templet.
4. Slowly revolve the metal and gradually hammer the metal into the hollow of the wood block.
5. Place the tray on a smooth piece of iron or wood and flatten the flange from both sides of tray. Using wood and iron punches
6. Planish the raised part of tray smooth and true on a round stake with a flat-faced hammer.
See that the face of the hammer is polished and has no marks on it.
7. Cut down the tray to the correct size and round off the edges with a smooth file and emery cloth.
8. Set out the design for the border decoration on a piece of paper, then make the punch from tool steel, harden and temper it.
9. Clean up the border of the tray with emery cloth and set out the design.
10. Rest the border of the tray on a smooth piece of iron and stamp in the design.
11. Reverse the tray and flatten the border.
12. Clean up all over with emery cloth and oil. Finish off with polishing paste and whiting.

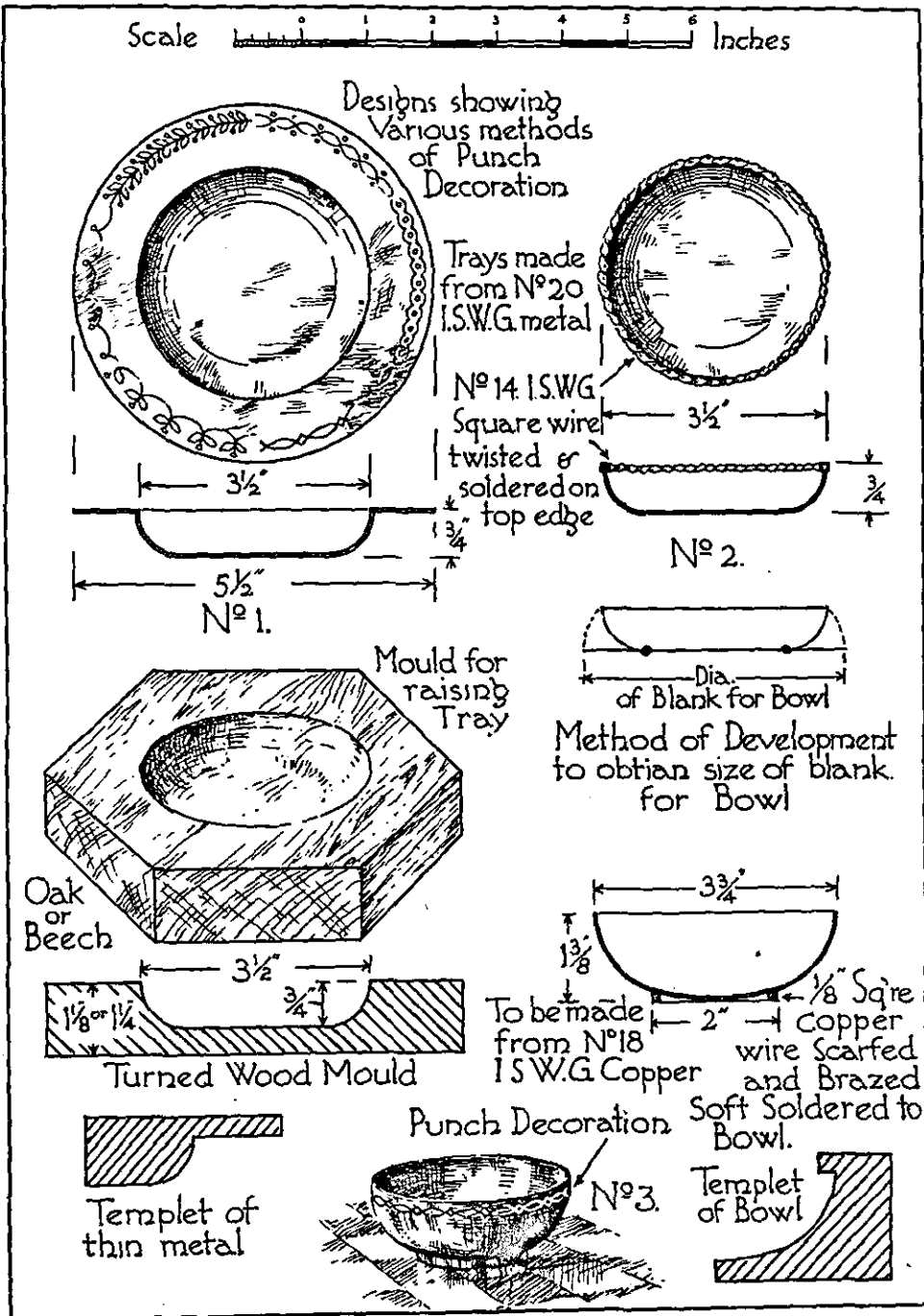

FIG. 1.—Ash trays and pin bowls with simple punch decoration.

No. 2. A PIN BOWL.

Method of Procedure.—

1. Develop blank for bowl as indicated on drawing, cut it out and smooth up the edge.
2. Hammer up the bowl as described for the ash tray, No. 1, Fig. 1.
3. Planish up smoothly on a ball head stake.
4. File the top edge level with a smooth file.
5. Obtain a length of No. 14 I.S.W.G. square copper wire, anneal it, and twist it.
6. Bend it into a circle, to fit top edge of bowl, scarf the ends and silver solder them together. Clean up the joint with a small round file.
7. See that the ring is circular and that it lies flat, then file a slight flat on one side of ring with a smooth file.
8. Place the ring with the flat side uppermost on a flat piece of wood, then place the edge of bowl on the ring and soft solder the two together, use a small iron and a small amount of solder.
9. Scrape off excess solder and emery cloth the bowl all over, finish off with polishing paste and whiting.

No. 3. A SMALL BOWL.

Method of Procedure.—

1. Develop blank for bowl by taking a straight line from the centre of the bowl to the edge, and using that distance as the radius for the circle.
2. Cut out the blank and file it up true, and smooth up the edge.
3. Hammer it up to shape, in the same block as used for the ash tray, No. 1, check the shape with the templet.
4. Planish up smoothly on a ball-head stake.
5. File the top edge level with a smooth file. Then round it off and finish with emery cloth.
6. Obtain a piece of $\frac{1}{8}$ in. square copper wire, bend it round a piece of $1\frac{1}{4}$ in. tubing, cut it off to length, allow $\frac{3}{16}$ for scarf, file the scarf to fit, and braze the ends together.
7. File up the joint, hammer the ring circular, and flat, file a slight bevel on one face so that it fits the bowl.
8. Soft solder the ring to the bowl and scrape off the excess solder.
9. Clean up all over with emery cloth and oil, and finish off with polishing paste and whiting.
10. Mark off the edge of bowl into a number of equal parts and design a simple pattern that can be punched into the metal.
11. Make the punch to the design chosen, and resting the bowl on a ball-head stake stamp in the design.
12. Rub down the punch decoration with fine emery cloth and oil and re-polish as before.

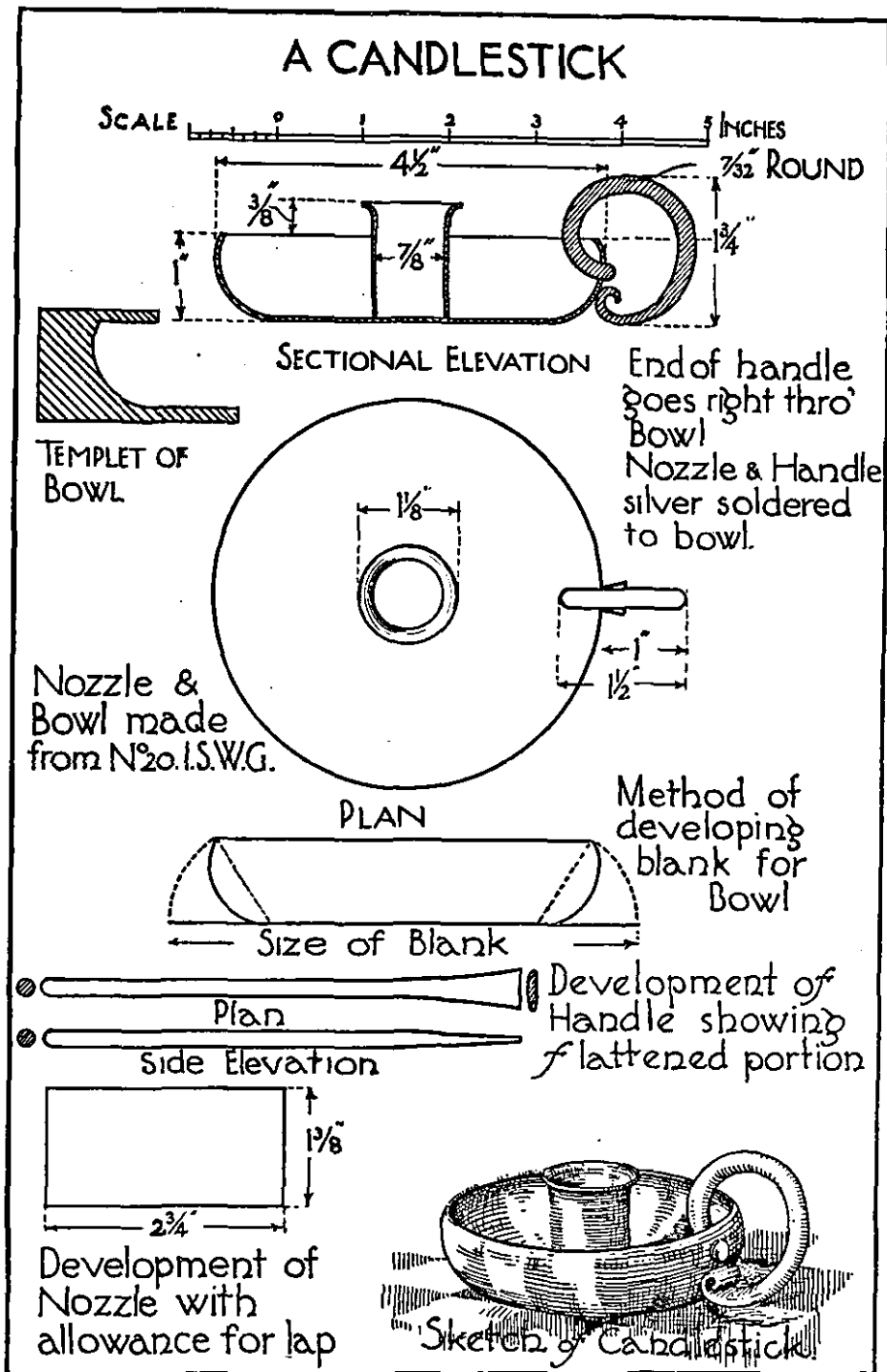

FIG. 2 — A copper candlestick.

This very simple model is based on the work done in the previous chapter and involves similar processes with the addition of working up the handle from a piece of rod. A most suitable model for young students.

A CANDLESTICK (Fig. 2).

These can be made in copper, brass, gilding metal or No. 22 I.S.W.C. German silver.

The Process.—

1. Cut out blank for bowl, and hammer it up to shape as described for the ash tray in Chapter VII, p. 78.

2. Now planish the bowl on a ball stake with a polished face hammer.

3. Cut off a piece of 1 in. copper tube to correct length for nozzle, true up the ends, and splay out one end with a stretching hammer holding nozzle on the point of an extinguisher stake, or develop nozzle and make as shown in sketch.

4. Obtain a piece of rod for the handle and spread one end as drawn. Then take off with a piece of string or wire the correct length of handle needed, working from the drawing. Mark the length lightly with a file. Bend up the scrolled end first, then cut off where marked, round up the end with a file and finish bending handle to shape.

5. Punch hole in bowl for handle, from the inside holding bowl on a lead block.

6. Tie handle securely in position and silver solder it from the outside.

7. Tie nozzle securely in position, place some small pieces of silver solder inside the nozzle along with some borax and heat the nozzle until the solder melts. Place in pickle until all borax has dissolved.

8. Polish up all over with emery cloth and oil and finish off with whiting.

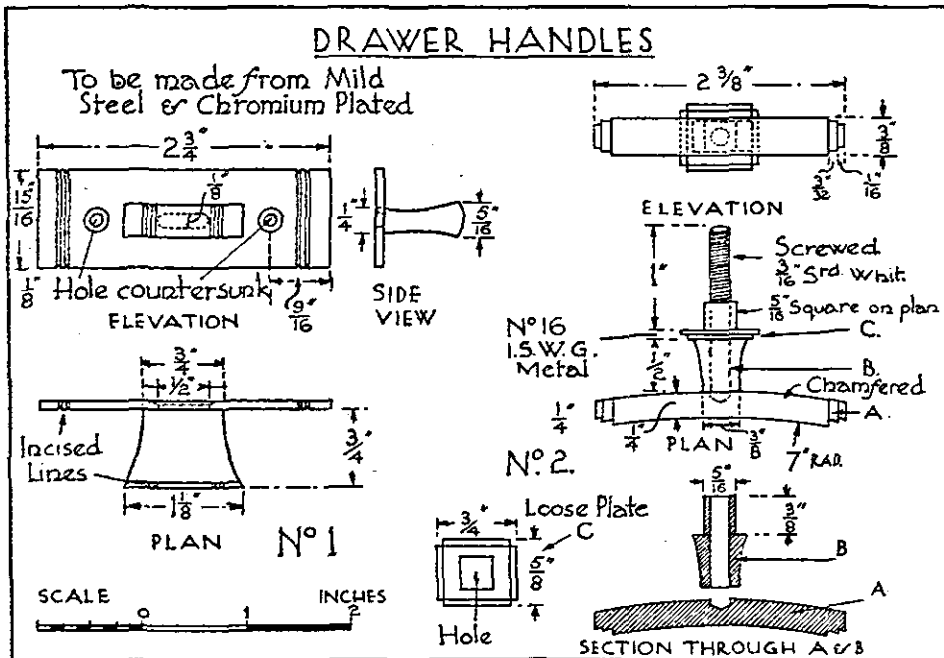

FIG. 2A.—Alternative suggestions for handles involving fitting, filing, drilling and brazing.

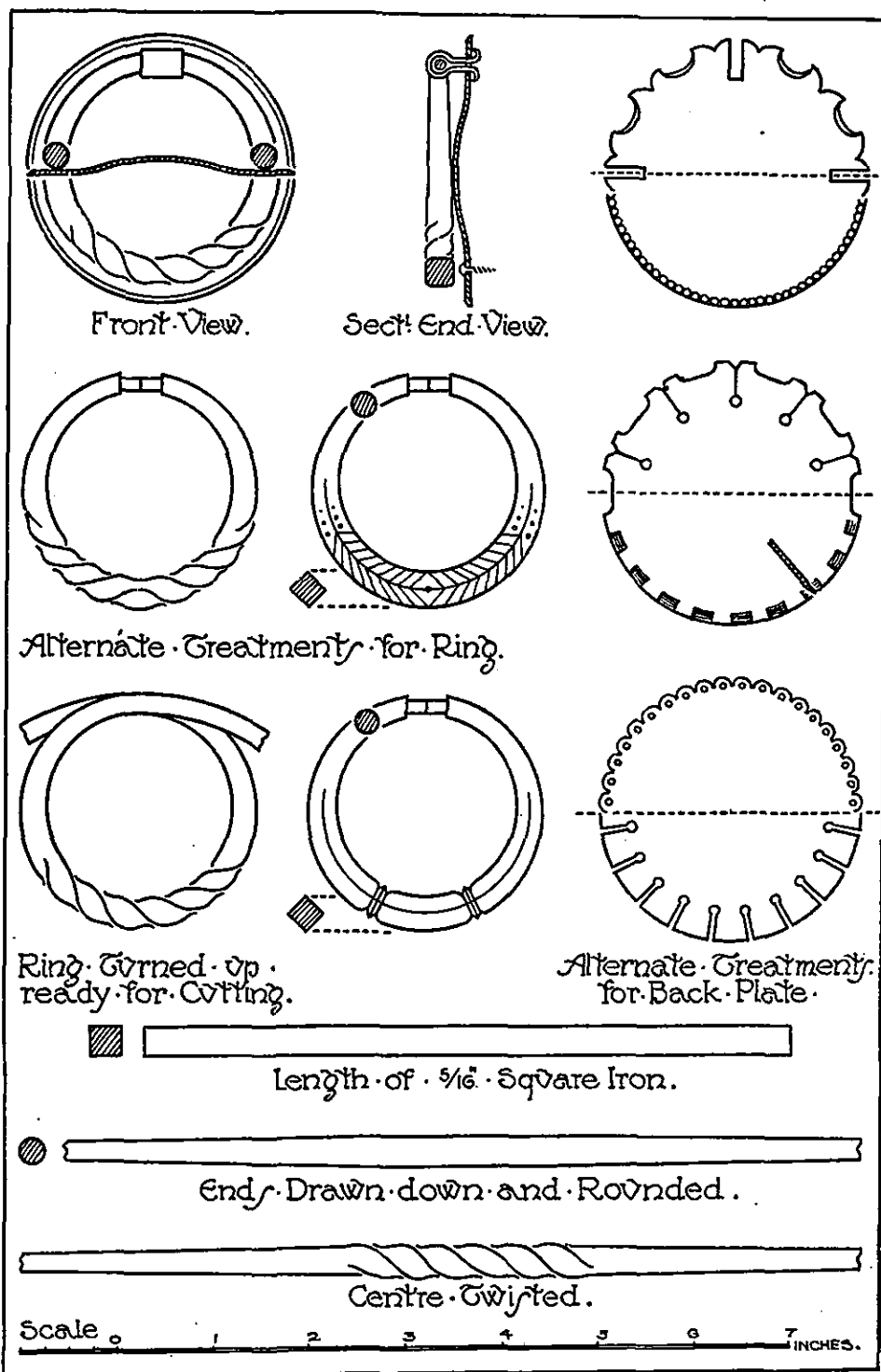

FIG. 3.—Suggestions for handles and their development.

Drawer Handles.—Fig. 3. These are most suitable if made in iron and finished armour bright.

The Process.—The back-plate should now be made first from 14 or 16 I.S.W.G. metal, and the rectangular hole punched for the reception of the clip. The ring made next by the methods illustrated in Fig. 4.

The ring should now be cut and sprung together, and the pin filed ready for the clip.

The handle could now be laid on the back-plate and the holes for screws marked and drilled.

The clip should now be made from 16 or 18 I.S.W.G. metal, as illustrated in Fig. 4, and bent round the pin.

The handle and back-plate should now be polished and lacquered, then put together and the clip clinched.

Note.—The screws should come underneath the handle when it is hanging down, but of course the position of screw holes is frequently governed by the place where the handle is to be fixed.

The Decoration.—There is practically no limit to the methods that could be adopted for the decoration of the handle and plate, but the designs shown are easily executed and are very effective, though they are obtained by the use of quite elementary tools. The back-plate could be, if preferred, marked all over with a hammer or punch, so obtaining a kind of texture.

Special Features.—These are the bending and twisting of metals, either in the hot or cold state, and a small amount of fitting.

IRON GRILLES (Fig. 5), p. 86.

Uses.—For protecting small windows. These provide excellent practice in bending and riveting.

Joints.—Halved, tenoned, and riveted.

The Processes consist of making a full-size drawing on strong paper, for the work to be laid on while working it into shape; the frame must be made first of all in the manner illustrated in Fig. 10, p. 77, but not riveted together. The interior work is then bent to shape; this can be done cold, leaving the ends an inch longer than necessary. The corners should be heated to bend them, and the cross-overs filed to fit neatly together. The frame should now be put together temporarily, and the interior work laid on the frame, and the tenons marked. The tenons

should now be made, the whole thing put together, and the corners of the frame riveted together, then the other parts riveted to the frame. The grille could now be painted. Fig. 2, p. 67, shows the method for bending iron, cold or hot.

The Decoration.—This consists of straight lines, curved lines, geometrical designs, etc., according to the skill of the craftsman who is going to make it.

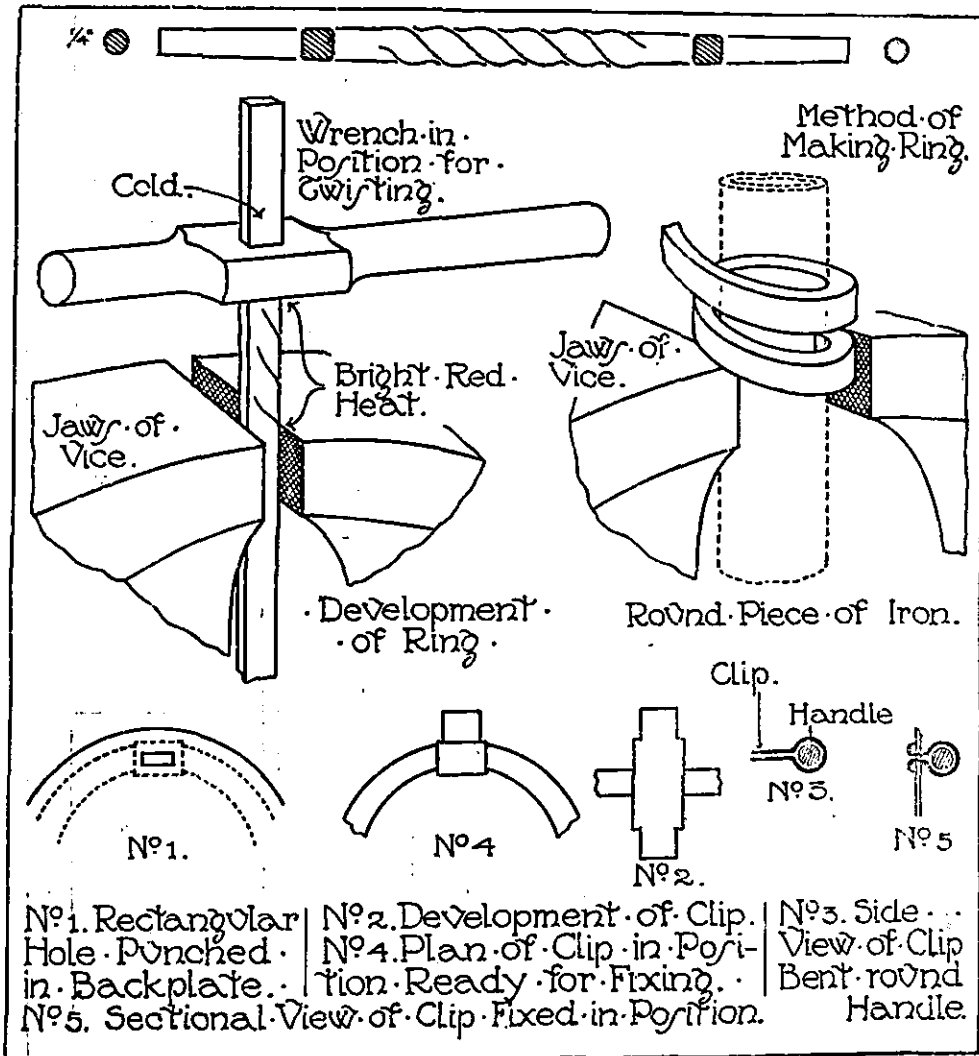

FIG. 4.—Processes in making a handle.

Also twisting the metal, using metal of different thicknesses and sections, all adds to the variety.

Special Features of these grilles are the bending and fitting. It is also good practice for simple designing and drawing of easy forms. For one method of bending see Fig. 2, p. 67.

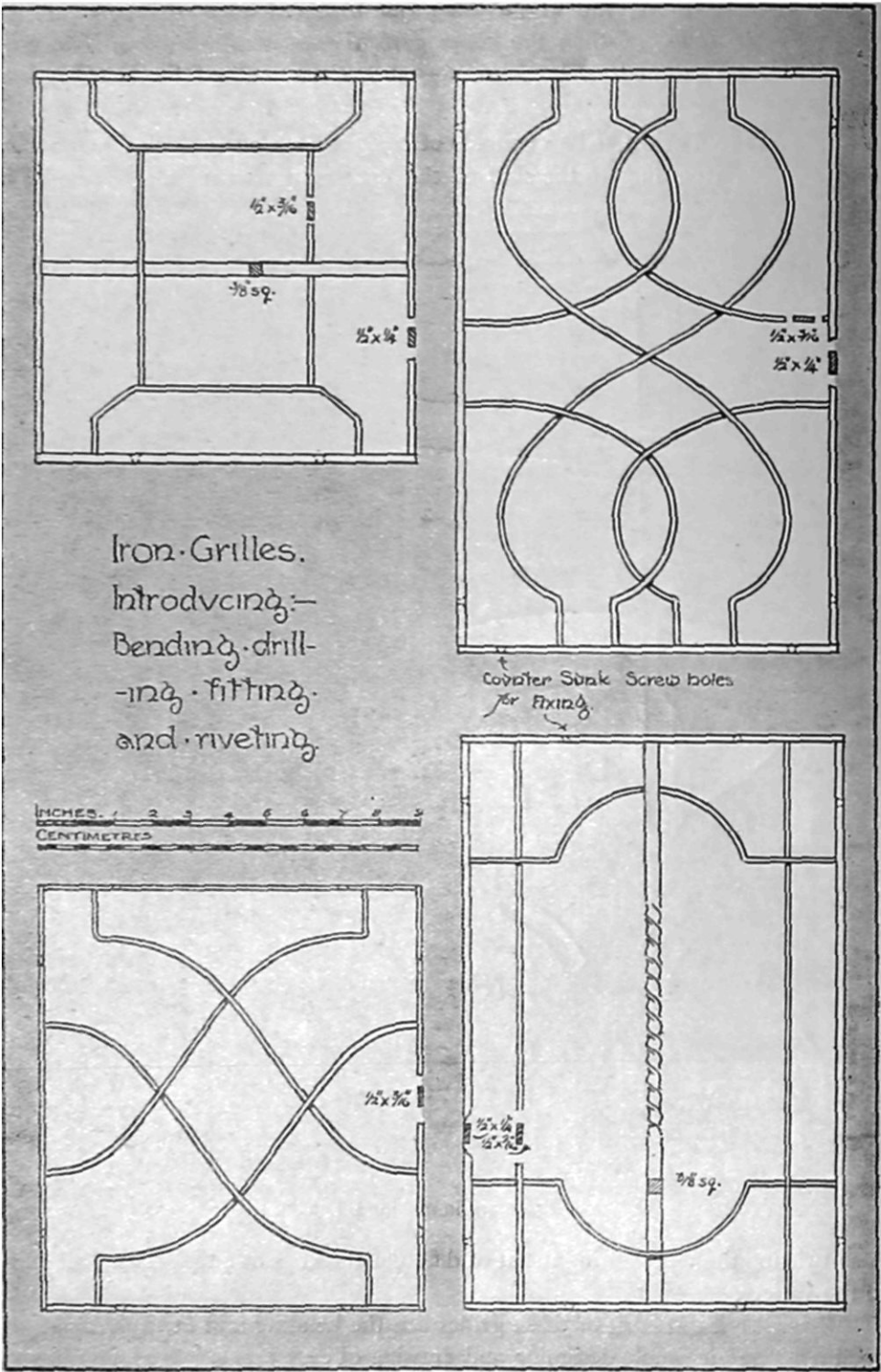

FIG. 5.—Suggestions for grilles.

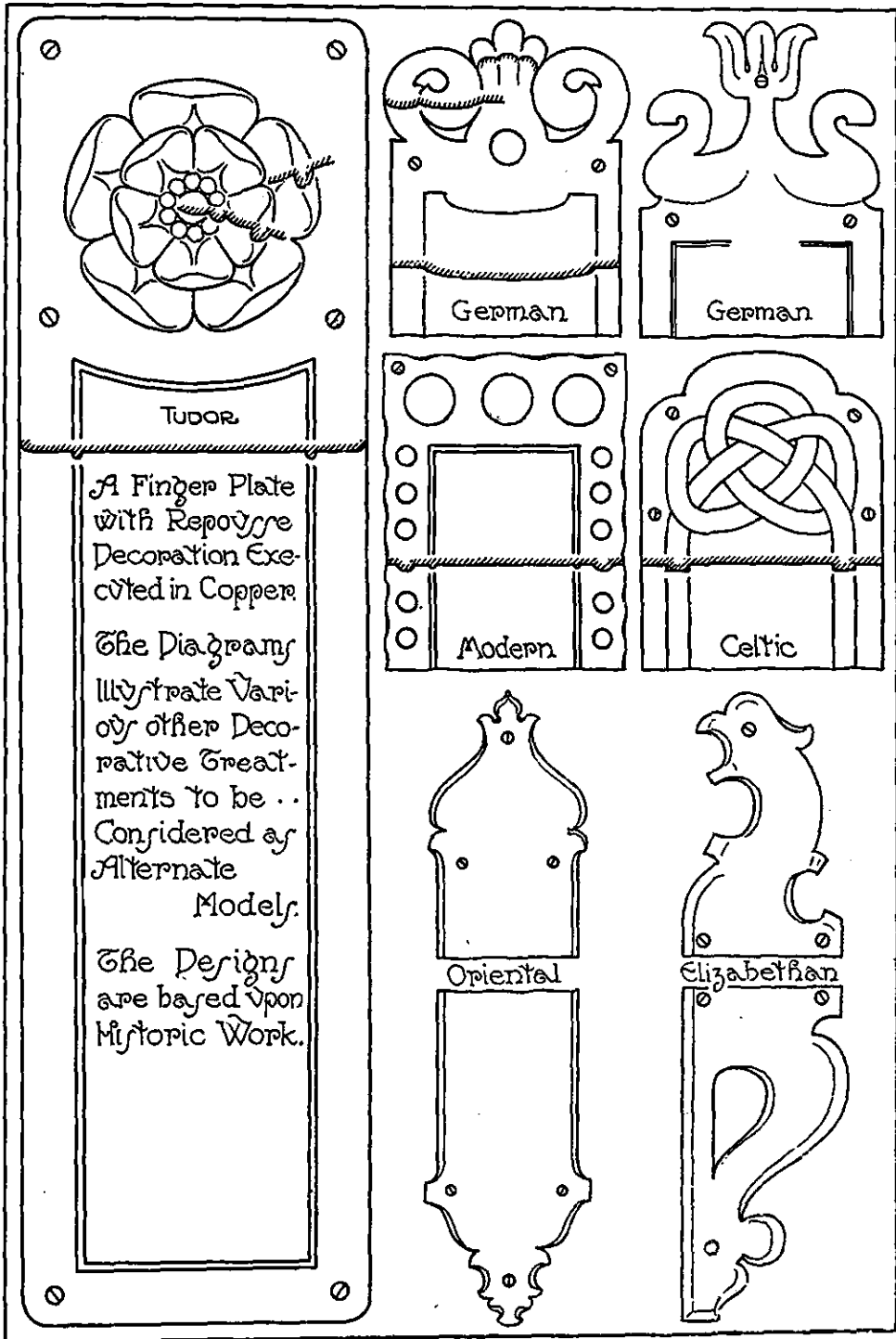

FIG. 6.—Finger plates based on historical styles.

FINGER PLATES (Fig. 6).

Object and Uses.—Finger plates serve a dual purpose. Not only do they save the paint from disfiguration by handling, but they provide a decoration based on historical style. They provide excellent practice in drawing, repoussé work, and punch work. The Oriental and Elizabethan examples give practice in chiselling and decorative filing and ornamental hammer work. See p. 169.

CENTRE SQUARES (Fig. 7).

Object and Uses.—Simple models introducing accurate filing, fitting, brazing, silver soldering, elementary turning of iron, and accurate riveting.

Method of Working.—No. 1.

1. Cut out material, file it to the correct size and shape.
2. File and fit angle pieces ready for brazing.
3. Tie angle piece to a piece of light iron rod with iron binding wire, and braze the joint, using brass wire, and borax as a flux.
4. Pickle stock in dilute sulphuric acid to clean the joint and remove borax.
5. File up joint, test for accuracy, and finish off.
6. Finish off the blade, mark position of hole, and drill it, then fit blade to stock and tie it in position.
7. Place wet borax along the joint and silver solder blade to stock.
8. Place in pickle and when the borax has dissolved, wash and dry, and finish off the job with fine emery cloth.
9. Give a coating of grease to avoid rusting.

Method of Procedure.—No. 2.

1. Obtain a piece of bright drawn mild steel, No. 14 I.S.W.G., a little larger than the finished blade, face one side and wipe over with a solution of sulphate of copper.
2. Set out the blade and position of holes very carefully, marking all lines and centres with a fine pointed scriber and centre punch.
3. Drill and countersink holes, and cut down to the lines with a hack saw.
4. File down to the lines, and finish off the blade back and front. Bevel front edge.
5. Turn the two small studs or rivets in a screw-cutting lathe from $\frac{5}{16}$ -in. round, bright, mild steel.
6. Fit the studs carefully to the blade, then anneal them, clean them, place them in position and burr over the ends, and file off flush, taking care that they are upright.
7. Finish off ends of studs and give the face of blade a final finish with fine emery cloth, taking care not to bend it.

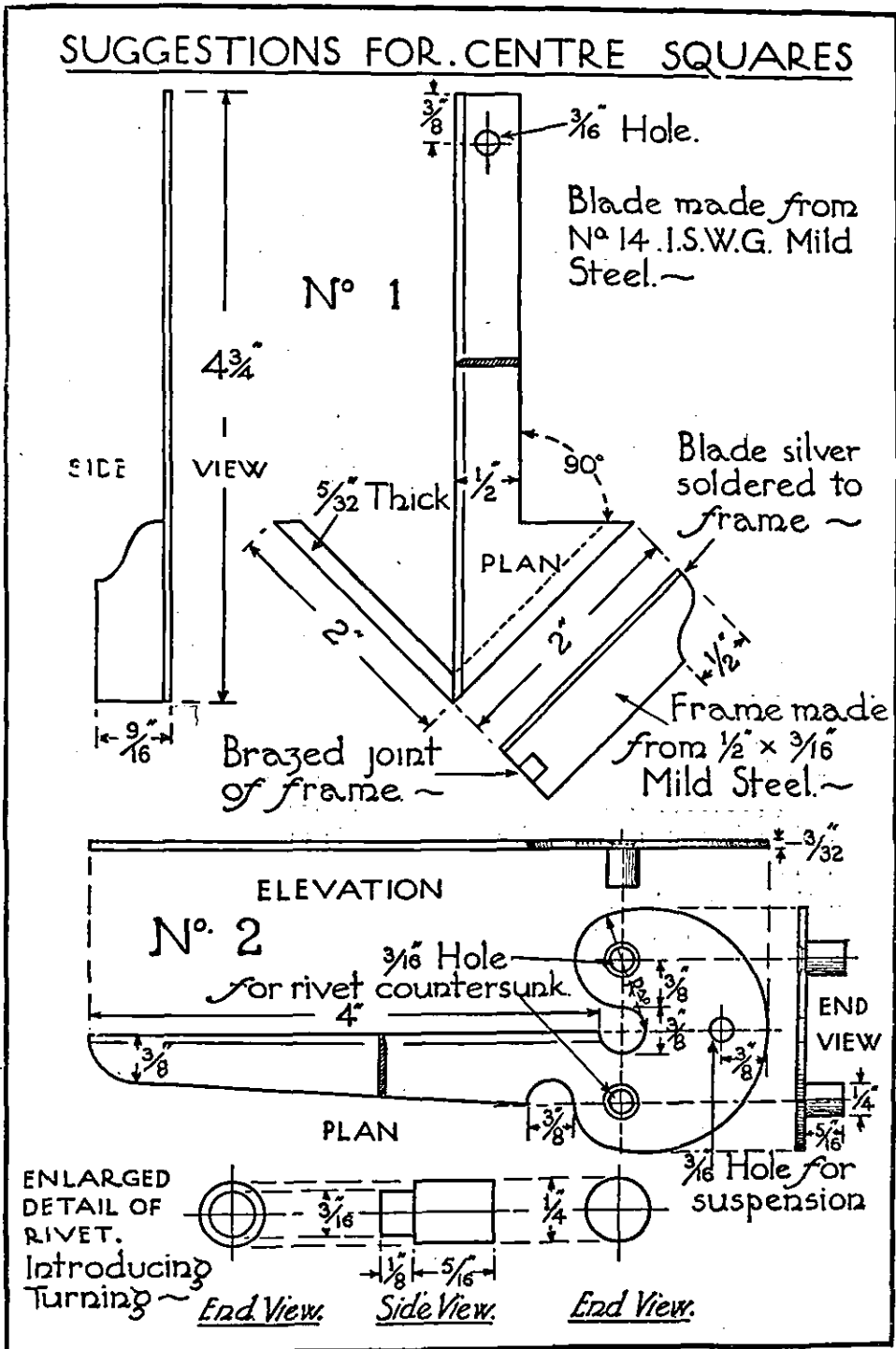

FIG. 7.—Centre squares introducing more advanced setting out, filing, fitting, single turning and silver soldering.

TURNED WORK.

Object and Uses.—In Fig. 8 there are drawn a number of objects suitable for elementary exercises in turning and allied operations. They comprise a **Main or Master Chuck**, for fitting to the nose-piece of a lathe headstock; an **Auxiliary Chuck**, for screwing on to the master chuck. There are usually a number of these small chucks, which are all fitted to the master chuck, ready to be fitted to any job that comes along. The next drawing shows a **Loose Centre**, which is fitted into the sliding barrel of the tailstock, or in a carrier chuck; this should be made of steel, hardened and tempered. The next drawing is of a **Drilling Plug** which is also fitted to the tailstock. This is used for holding circular objects while they are being worked on or drilled, and it is an excellent model, introducing taper turning, taper fitting, sawing, and accurate filing. The next is a **Hammer Head**, which is a more difficult exercise, and involves turning by hand as well as with the aid of a slide rest, difficult drilling, filing, and hardening and tempering. The next is a **Balanced Handle or Swape**. This involves turning as above, drilling and tapping a stopped hole, screwing and fitting, and making a true square hole.

There are also the patterns to be made, and these should be of boxwood. This is more simple turning and patternmaking, but the easiest pattern to turn is the auxiliary chuck.

The Joints.—The two projecting lugs on the wood pattern of the master chuck are simple dowelled joints; all the chucks are screwed joints, and the loose centre and the drilling plug are taper fitting or friction joints.

The Processes for the main or master chuck :—

1. Turn the pattern from a piece of hardwood; turn and fit the studs, and glue them in.
2. Cast the chucks in brass or gunmetal.
3. Pickle it to loosen the sand.
4. Turn it out to size for the female thread; face it, screw it, and cut away the first thread as shown by dotted line. Take care that it fits the nose-piece of lathe without any shake, and that it does not wobble when being screwed on.
5. Fit the chuck on to the headstock of lathe, turn the nose-piece, face it, and screw it with outside comb chaser—Ch. XVI, Fig. 18 (13)—to the size that is convenient for the auxiliary chucks.

The two studs are cast on, so that they can be tapped lightly with a hammer to tighten the chuck on to the spindle, and also to loosen it. If the stud farthest from the headstock is not wanted it could be sawn off.

Auxiliary Chuck.—1. Turn pattern in wood.

2. Obtain casting.
3. Hold in a chuck, bore out, and screw to fit without any shake on to nose-piece of master chuck. A number of these should be fitted and then left so that they could be fitted to any work that comes along.

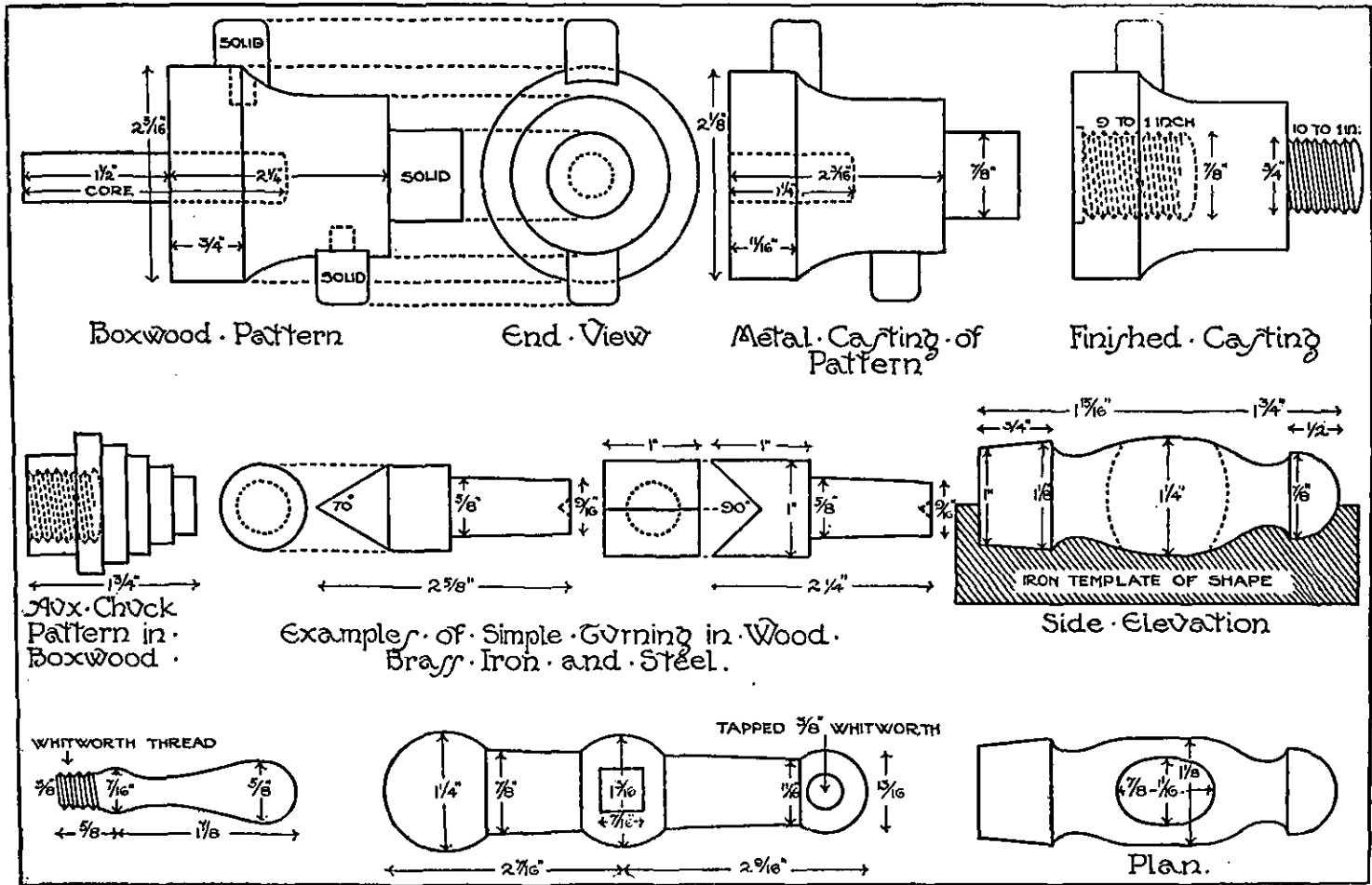

FIG. 8.—Top row—Pattern, casting, and finished casting of master chuck.
 Second row—Aux. chuck-steel centre, vee block centre, hammer head.
 Bottom row—Small handle and cross bar for a balanced handle, plan of hammer head.

A Loose Centre.—1. Cut off a piece of steel 1 in. longer than the finished length.

2. Anneal, square the ends, centre them.

3. Drill $\frac{1}{8}$ in. or $\frac{5}{32}$ in. holes $\frac{3}{8}$ in. deep in both ends.

4. Countersink both ends, angle of countersink to be the same as that of the centres being used.

5. Fix a lathe dog on one end, and screw a carrier chuck on the nose-piece of lathe headstock and hold it between the centre, seeing that it runs freely without shake; oil centre and tighten up bolts and set screws on lathe so that the work cannot jump out while being turned.

6. Turn to correct size and shape, using the slide rest, and note that the cutting edge of tool is at the centre of the work.

Vee Block or Drilling Plug.—1. Cut off a piece of $1\frac{1}{8} \times 1\frac{1}{8}$ in. iron 1 in. longer than the length of the plug. This could be turned from the square stock, or the taper end could be brought to a welding heat and swaged down.

2. Anneal it, square the ends, centre them.

3. Drill $\frac{1}{8}$ in. or $\frac{5}{32}$ in. holes $\frac{3}{8}$ in. deep in both ends.

4. Countersink both ends, angle of countersink to be the same as that of the centres being used.

5. Fix a lathe dog on one end, and run between the lathe centres so that it turns freely but does not shake.

6. Turn accurately to shape, taking a light cut only over the corners of the square.

7. Cut out vee piece with a hack saw.

8. File up accurately, and see that the centre of the angle is in the centre of the plug.

9. Finish off with a piece of fine emery cloth wrapped once round a flat file, taking care not to rock the file.

Hammer Head.—1. Cut a templet out of thin metal to exact shape of hammer head. Proceed as instructed in Nos. 2, 3, 4, 5 of a loose centre.

6. Turn to exact size and shape, using hand tools for the curved portions. For method of holding hand tools when turning iron or steel, see Fig. 10, p. 94, Ch. VII.

7. File the two flat surfaces as shown on plan.

8. Mark centres on both sides of hammer head for two $\frac{7}{16}$ in. holes.

9. Chip a small level surface on sides of centre marks so that drill can start without running off.

10. Drill $\frac{1}{4}$ in. or $\frac{3}{16}$ in. holes right through by drilling from each side alternately.

11. Drill the $\frac{7}{16}$ in. holes, plugging the first hole drilled with a piece of iron or brass before commencing to drill the second hole.

12. Chip and file out the oval hole to the correct size, tapering it slightly from each side.

13. Finish off hammer head with smooth files and emery cloth.
 14. Bring hammer head slowly to a red heat and quench out in oil or paraffin.
 15. Fit the end of a piece of iron about 2 ft. long to the hole for the shaft which is called the eye and polish up the hammer head ready for tempering.
 16. Heat the end of the piece of iron which has been fitted to the eye in the hammer head to a white heat and place quickly in the hole; keep reversing the hammer head, this draws the temper of the centre portion, and as the face or pane are tempered to the correct hardness quench out in oil.
 17. Fit with a hickory or ash shaft and a wrought-iron wedge.
- Balanced Handle or Swape.**—1. Cut off a piece of $1\frac{3}{8}$ in. round iron 1 in. longer than the finished length, also a piece for the handle proper.
2. Anneal them, square the ends, centre them.
 3. Drill the holes and countersink them as described in previous paragraphs.
 4. Hold them as previously described and turn to the correct sizes.
 5. Drill a $\frac{3}{8}$ in. hole in centre of cross bar, file it square with a square file.
 6. Drive a $\frac{1}{16}$ in. parallel drift through.
 7. Drill and tap the smaller end of cross bar, but the hole must not go right through.
 8. Screw with the adjustable stocks and dies the small handle and fit into cross bar.
 9. Finish off with fine emery cloth and oil.

Notes on Turning.—As all these objects involve various kinds of turning and in different materials, the methods of holding the turning tools shown in Figs. 9 and 10 will no doubt be useful, and the very different methods of holding the turning tool when turning iron or steel, and when turning brass or similar metals, should be noticed. When turning iron or steel, owing to its tenacity and the danger of the tool "running in," it is necessary that the tool should be held with the utmost solidity; hence a large handle, giving a good firm grip, which enables the user to govern the pressure on the work being turned, is necessary. The illustration (Fig. 10) shows the turning down of a mandrel with a graver. A graver is a piece of square steel ground off diagonally at about an angle of 35° to 40° , hardened and tempered to a straw colour for turning iron and steel. It will be noticed that the tool rest is as close as possible to the work, in order to provide the fulcrum for the opposite corners of the graver.

When turning brass (see Fig. 9, p. 94) the rest should be placed so that the turning tool has free play, thus enabling the turner to feel the cut, and also sufficient space for working around the curves, shoulders, etc. Ch. XVI, Fig. 22, Nos. 14, 15, 16, 17, illustrate the shapes of tools for turning brass and similar metals. Another point when turning is that the rest should be arranged so that the cutting edge of the tool will be at the centre line

of the work. This also applies when screw cutting by hand. When roughing

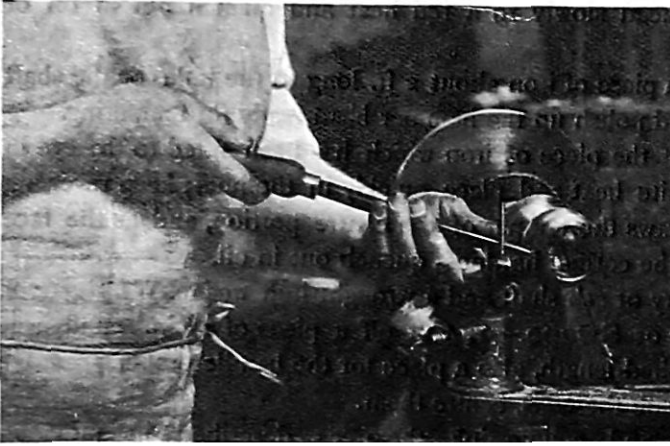

FIG. 9.—Turning brass with a ripper.

down iron or steel and using the slide rest the tool No. 6 on p. 260 should be used. No. 8 is for shoulders or angles, and No. 19 for finishing off.

Lubrication.—

This is a most important factor in all cutting operations, and it varies considerably under different conditions. The following

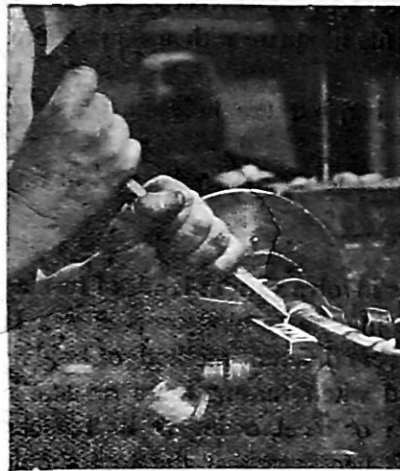

FIG. 10.—Turning iron with a graver.

table will be found useful, as it gives the various metals and the lubricant to use while they are being worked. A mixture of water 100 parts, soft soap 2 parts, soda 7 parts, and oil 30 parts, forms a good lubricant for general purposes. The water carries away the heat, and prevents the work from warping, the soda and soap prevent rusting of the work and the machine, and the soap and oil lubricates the cutting edge. This should be boiled for three hours thoroughly before use. The oil referred to here is commonly known as machine oil.

<i>Material.</i>	<i>Lubricant.</i>
Tool steel . . .	The mixture as above, or oil.
Soft steel . . .	" " "
Wrought iron . . .	" " "
Cast iron . . .	Dry, no lubricant at all.
Brass . . .	" " "
Gunmetal . . .	" " "
Bronze, etc. . .	" " "
Copper . . .	The mixture or oil.
Aluminium . . .	Paraffin or turpentine.
Lead . . .	Candle wax.

CHAPTER VIII

THIRD YEAR MODELS (METAL)

HAMMERED DISHES OR PATERÆ AND BOWLS (Fig. 1).

THESE models can be used for a variety of purposes; the flat dishes for card trays, standing glasses on, etc.; the simple bowls if tinned or silvered inside make nice sugar bowls, etc. They could be made of brass, gilding metal, copper, aluminium, German silver, or silver.

The Joints.—In the plain hammered plates and bowls there are not any joints, as they are worked up from the flat material, but those with a foot have the joints silver soldered, fixed with very small rivets, or soft soldered.

The Method of Procedure for making the dishes or plates (Fig. 1, Nos. 1, 2) :—

1. Make a full-sized drawing.
2. Cut a metal templet to exact shape of raising, depth, and width of rim.
3. Cut the metal out, allowing about $\frac{1}{4}$ in. over all extra for Fig. 1, Nos. 1, 2, 3, 4.
4. Cut out a piece of wood like that shown in Fig. 2 and fix to the bench.
5. Fig. 1, Nos. 1, 2, would be raised or hammered up with a double ball-ended hammer on the wood, as shown in Fig. 2. The nails shown act as guides so that if the edge is cut true, the hammered part must be raised true and circular, as you drive the metal down against the edge of the piece of wood a little at a time.
6. After taking one or two courses round the dish you flatten it with a mallet on a flat surface of wood or metal, and anneal it.
7. Repeat operation No. 5 until the plate is of the required depth.
8. Now planish it smooth and true on a round stake with a flat-faced planishing hammer, Ch. xvi, f. 21 (8).
9. The rim is now made flat and the edge trued up, and the plate annealed again.



FIG. 2.—Raising a dish on a wood mould.

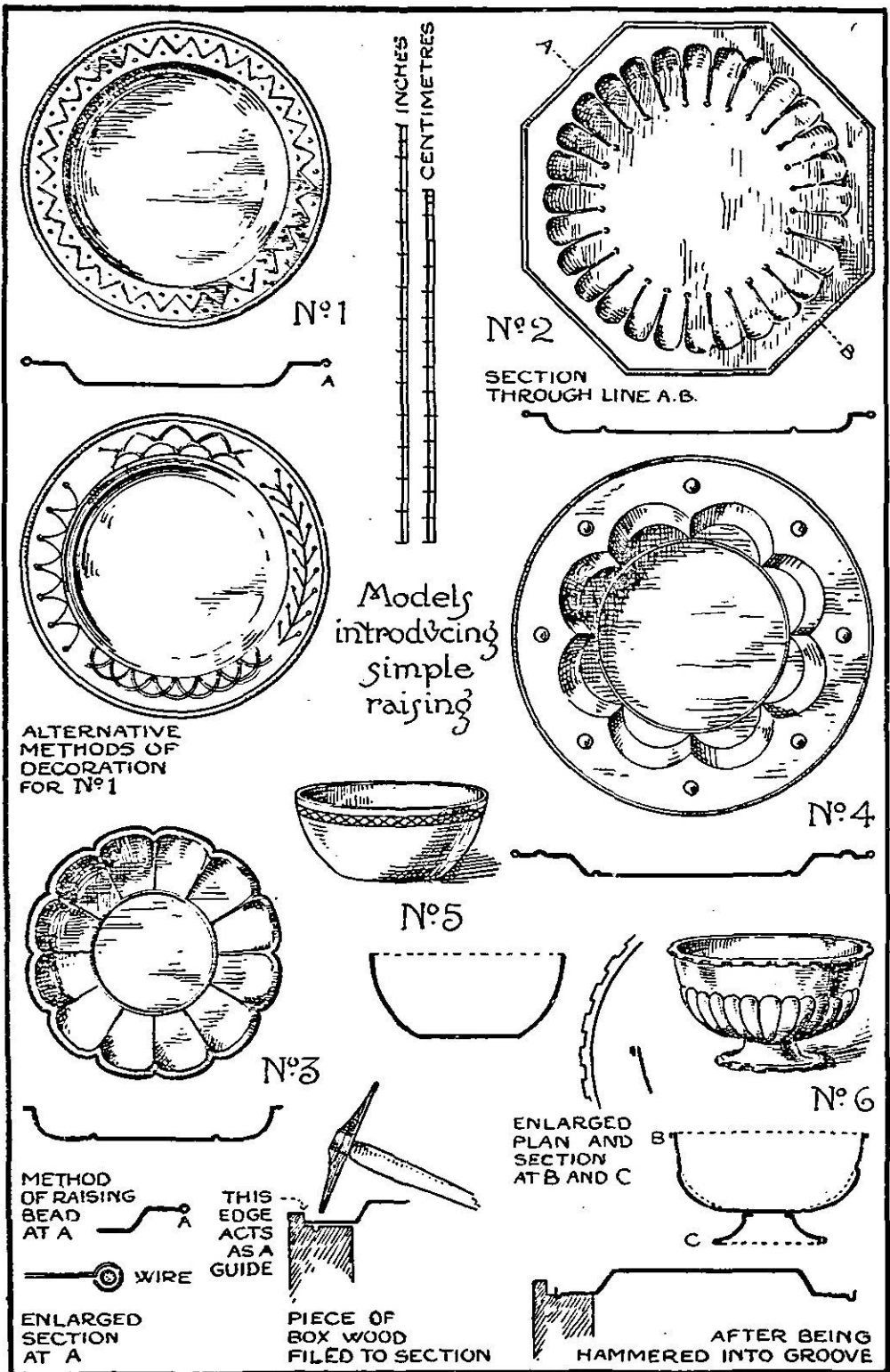

FIG. 1.—Examples of simple raised work.

10. Make up a bed of pitch, consisting of a thick wood base about 2 or 3 in. larger all round than the plate, and mix some common plaster of Paris and tallow with the pitch. The plaster is to harden and toughen, the tallow is to make it flow and soften it. Lay on the board a bed of this about 2 in. thick. Wait until it sets, then prepare some more pitch, pour some on the pitch block, grease the plate, pour some pitch on it, then put it on the block and weight it down, so that the warm pitch is pressed out from underneath the plate; this prevents the formation of air bubbles underneath the metal.

11. Clean the plate on the pitch when cold, and mark out the design.

12. Now trace in the design with the tracers (Ch. xvi, f. 21, Nos. 10 and 11) and the hammer (Ch. xvi, f. 21, No. 9), holding them in the manner shown in Fig. 3. Plate No. 1, Fig. 1, would only be worked on back, but plates Nos. 2, 3, 4, Fig. 1, would have to be worked up on both sides.

13. After the embossing of plate No. 2, Fig. 1, the edge would be trued up and wired as shown at the bottom of the page, but Nos. 1 and 4, Fig. 1, would, when the centre part was finished, have the edges wired and the designs on the rims embossed last.

14. These would now be cleaned up and polished and lacquered if required.



FIG. 3.—METHOD OF HOLDING A CHASING TOOL.

Fig. 1, No. 3.—1. This would be raised up by beating it into a hollow, carved out of a solid piece of wood, usually a piece of a tree trunk, with a ball-headed hammer, then smoothed up and planished on a round stake.

2. Now place it, bottom upwards, on the pitch, clean it, draw the design, and line it in, as described for plates Nos. 1, 2, Fig. 1.

3. Take it off the pitch, clean it, and bed it in the pitch again, the hollow side upwards.

4. Work it up to shape and finish it off.

5. Flatten it, cut out the edge and smooth it up with a half-round smooth file.

6. Clean it up and polish, lacquer it if desired.

Fig. 1, No. 4.—This would be made in a different way to the others owing to the design.

1. Draw the design on the metal by cleaning the metal with emery cloth and placing a piece of blue transfer paper between the drawing and the metal, then go over the design with an ivory scribe.

2. Scratch the design on the metal with a steel scribe, working carefully over the existing lines.

3. Lay the metal on a sand bag and work the design up with the punches

(Ch. xvi, f. 21, Nos. 10, 11, 12, 13, 14), working on both sides of the metal until it is roughly beaten into shape, then anneal it, and repeat.

4. Now place on the pitch, hollow side up, as previously described, and work the bottom down with boxwood punches. The pitch must be slightly warmed for this latter operation.

5. Now take it off the pitch, anneal it, put it on the pitch again, the bottom side up.

6. Work on it with boxwood punches and finally with steel punches.

7. Take it off the pitch, reverse it, and put it on again, always greasing the side that goes on the pitch.

8. Finish off with steel punches making it as smooth as possible.

9. Take it off the pitch, clean it, flatten it, and square up the rim.

10. Wire the edge as shown, that is, trim the edge of the plate true, then file a piece of boxwood to the size required, as drawn, and hammer the metal into the groove with a peining or grooving hammer, then lay the wire in the groove, and hammer the edge down and over it while the bead rests in the grooving tool (Ch. xvi, f. 21, No. 28).

11. Flatten the rim.

12. Lay the plate on a cake of lead and punch the small bosses up with a round punch of the correct size (see Ch. xvi, f. 21, No. 16).

13. Clean up and polish. It could be lacquered if desired.

Fig. 1, Bowl No. 5.—This is a little more difficult than the plates, but still comparatively simple.

1. Set out a full-size elevation of the bowl and make a templet of one side and along the bottom to the centre, so that when the templet is laid on the elevation the edge of the templet is on the outside of the line from the top edge to the centre of the bottom. This must be an outside templet, similar to that on p. 86.

2. To obtain the size of the blank required to make this bowl, and as the bowl is part of a sphere, draw a straight line from the extreme outer edge to a point that would be the centre of the half ball if the curved sides were carried round. This would be the radius required. For example, as the bowl drawn is 6 in. in diameter and $2\frac{1}{2}$ in. deep, and we made it into a half circle instead of a flat bottom, it would measure 6 in. in diameter and 3 in. deep, and a line drawn from the centre to the edge would measure $4\frac{1}{2}$ in., so that the diameter of the blank required would be $8\frac{1}{2}$ in. This is the method often adopted for finding the diameters of the blanks required for bowls or segments of circles, but there are many other methods.

3. The blank should now be hollowed up as described for the plate No. 3, Fig. 1, taking care to keep any wrinkles out.

4. Anneal it and hollow it up a bit deeper.

5. Now put a round stake (Ch. xvi, f. 21, No. 26) in the vice, or in a square hole in the hollowing block, and holding the bowl on the stake as shown in Fig. 4,



(1) Silver jug, eighteenth century, V. and A. Museum.



(2) Silver dish chased and repoussé, V. and A. Museum, English, 1650.



(3) Silver "mazer" cup, second half fourteenth century, V. and A. Museum, lent by J. C. Robinson.

FIG. 5.

take a course round it, driving the metal away from you and in a downward direction, using a boxwood mallet as illustrated. These courses must be done evenly, gradually working round and round towards the edge, and the same weight of blow being given. The blows must slightly overlap one another, and two should not be given in the same place.



FIG. 4.—Raising a bowl on a stake.

6. The bottom of the bowl should now be flattened on a polished stake (Ch. xvi, f. 21, No. 22) and the edge trimmed off smooth, then annealed, pickled, and dipped up bright.

7. It should now be planished all over on a suitable stake, with the planishing hammer (Ch. xvi, f. 21, No. 3) seeing the hammer and stake are both well polished, and keep the hammer marks very even and do not let the edge of the hammer mark the bowl, as these marks are very difficult to remove.

8. Grease the interior of the bowl, and fill with pitch.

9. When the pitch is set, rest it on a sand bag and draw on the design for the banding, and line it in with a thin tracer (Ch. xvi, f. 21, No. 10). Then warm and remove pitch, and clean with paraffin and sawdust.

10. Polish it with rouge.

11. If required to be tinned, scour the inside with sand and water or emery cloth, paint over the parts that are not wanted to be tinned with whiting, heat the bowl, rub it over with sal ammoniac, pour in some melted tin, swish it round, pour it out again, heat the bowl, and wipe the surplus tin off with some tow dipped in silver sand and powdered sal ammoniac.

Bowl with Foot, No. 6, Fig. 1.—This is a little more difficult than No. 5, Fig. 1, and involves silver soldering and brazing.

1. Raise the bowl and the foot as described previously for No. 5, Fig. 1.

2. Fill the bowl with pitch, and when cold draw on the design to be raised.

3. Trace the design in as described for the bowl No. 5, Fig. 1.

4. Remove the pitch, and clean the bowl as described for the bowl No. 5, Fig. 1.

5. Rest the bowl on the sand bag and slightly raise the ornament from the inside with the embossing tools (Ch. xvi, f. 21, Nos. 13, 16).

6. Obtain some half-round material, the same that the bowl is made of. If not, make some from round wire by filing one side flat, or hammering one side flat while the wire is in a grooving tool (Ch. xvi, f. 21, No. 28).

7. Bend it up into a circle and braze the ends together so that it fits on to the bowl tight.

8. Repeat this for the foot.

9. File the notches in the rings as illustrated.

10. Place the rings in their correct position and silver solder them on.



(1) Hammered bowl with cast and hand-turned foot.
Silver finish—enlarged scale.



(2) Hammered bowl with modelled feet.
Finished in natural colour—silver lined.

FIG. 6.—Examples of students' work.

11. Pickle, dip, and clean the bowl up all over.

12. Polish with rouge, and tin or silver the inside as required.

The Decoration.—This is all on simple lines, and involves only simple processes. The decoration on plate No. 1, Fig. 1, could be omitted, thus simplifying it, and the number of flutes in plate No. 2, Fig. 1, could be reduced, and the ornamental band on plate No. 5, Fig. 1, could be left out without affecting them to any great extent.

Special Features.—They are the introduction of simple raising, the combination of raising and embossing, and methods of stiffening the edges of pateræ, bowls, etc.

The illustrations in Fig. 5 are from objects in the Victoria and Albert Museum. They are shown as examples of more advanced work but of the same kind as the plates and bowls shown in Fig. 1.

The Jug (1), which is of silver, is of very simple construction and involves only simple processes. One could be designed on similar lines, and made as follows: The body made in two halves and silver soldered together, the junction being hidden by a piece of beading, the neck piece being decorated while in the flat, then bent up and joined together; the foot hammered up and decorated; the handle modelled on an iron core, and cast in plaster and then in metal. Repeat this process for the thumb piece and hinge, which appear as if in one piece. Hammer up the lid. Now join the neck piece on to the body, load with pitch and touch up or finish the ornamental details. Unload the pitch, clean up and fix the foot. Fit up the lid and handle together, then take apart, and fix the handle to the body. Now finish off, clean up, and polish. Lastly fix the lid on, and give it a final polish.

The Silver Plate, Fig. 5 (2), needs no comment. It is of English workmanship of the date 1650, and is an example of punch decoration.

The Silver Cup, Fig. 5 (3), is a prize cup of the second half of the fourteenth century, and was lent to the Museum by J. C. Robinson, Esq. It is very graceful in form, and the style of decoration very simple and pleasing.

The Oxidised Silver Bowl (Fig. 6 (1)).—This is a well-proportioned bowl, the foot is hand-turned gun-metal. The moulding at top edge is machine made and soft soldered to the edge, the foot is soft soldered to the bowl and the whole has been silver oxidised and lacquered.

The Bronze Bowl (Fig. 6 (2)).—This bowl is made from gilding metal. The feet are cast in gun-metal, from a wood pattern. They are filed up with various shaped files and ruffles, then soft soldered to bowl. The outside of bowl and feet are polished, the inside is silver plated and finished bright. This is a successful design.

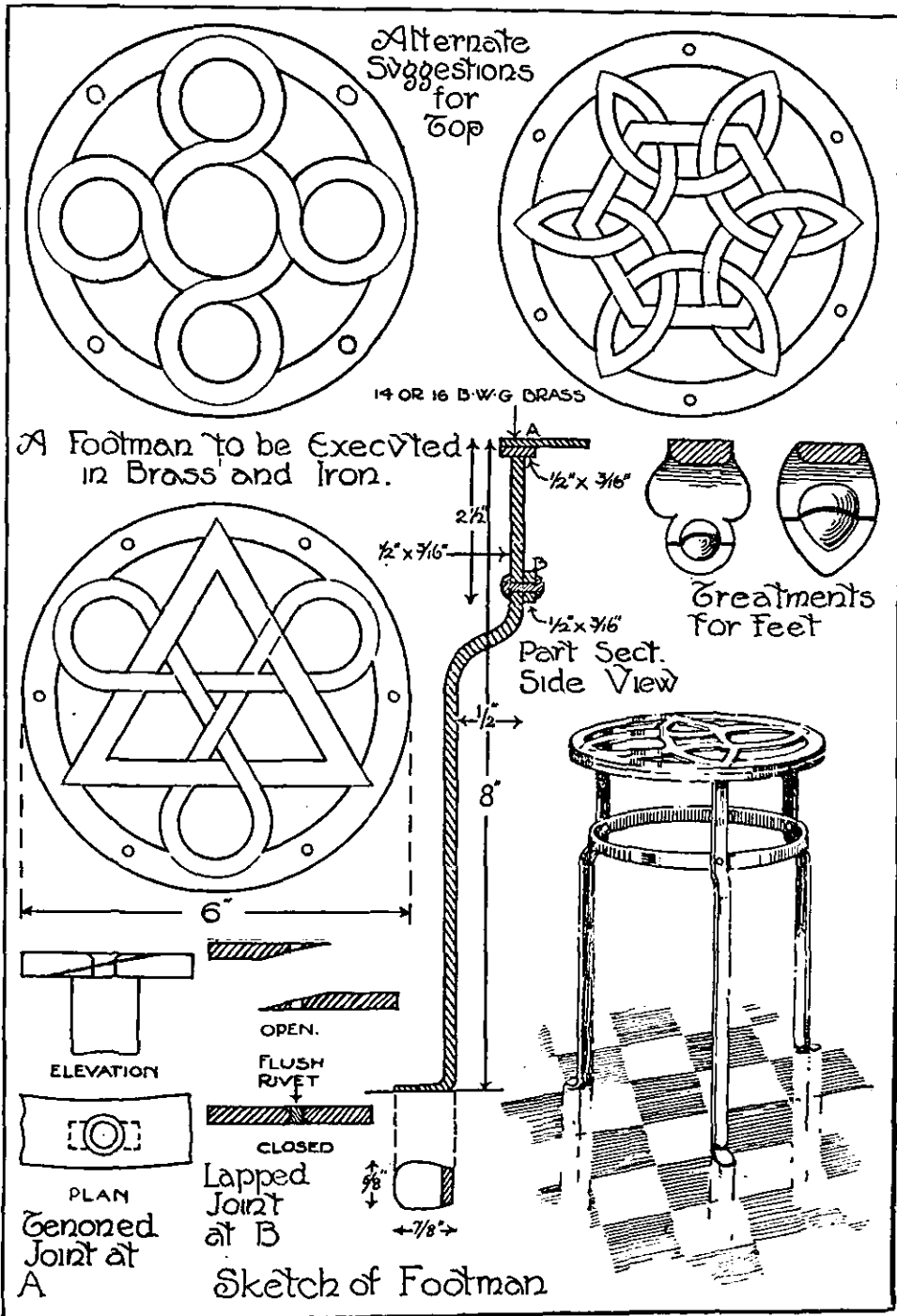

FIG. 7.—A footman or tripod, with alternate suggestions for the top, 3 or 4 legs.

TRIPODS.

Subject and Uses.—The footman or tripod illustrated in Fig. 7 is a most useful article for standing on the hearth, as kettles, plates, etc., can thus be kept warm. The top lends itself to a great variety of geometrical designs, and could be cast or pierced.

The Joints.—These are riveted joints of three kinds, namely, tenoned and riveted, flush or secret riveting, simple riveting.

The Processes.—Make a drawing full size of the stand, from this make separate drawings on strong paper of the side view of leg as shown in Fig. 7, also plan of the top ring A, plan of the supporting ring B, and a tracing of the top. If a number of the same pattern are being made, a quarter templet of thin sheet metal would be advisable. The next step would be to make the legs; only the foot would require to be forged, the bending could be done cold, and the tenon at A cut down between two cutters in the lathe, or cut down with a hack saw and filed. The top ring should now be bent into shape while hot over the beak of the anvil or on a sugar-loaf mandril, then fitted and riveted together as illustrated, then the legs fitted to the top ring but not fixed. The ring B should be bent up cold round a former, fitted and riveted together as shown. The next step would be to drill the holes in the legs and in the ring B. Now rivet the legs to the ring at A, then rivet them to the ring B. The tracing of the top should now be transferred by means of carbon transfer paper to the sheet brass, or the tracing might be gummed on direct. Small holes should be drilled now where necessary



FIG. 8.—Saw piercing in metal

for the insertion of the saw blade, and then, holding the fret saw as illustrated in Fig. 8, cut out the design. The ornament should be trimmed up with small files, mark and drill the holes for riveting to ring A and anneal the rivets. The ironwork of the stand should now be cleaned up or painted, and the top plate polished; the top plate can now be riveted to the stand and given a final polish. It should not be lacquered.

Decoration.—This is mainly in the top plate, but a great variation could be made by putting a pierced band where ring B is, or the legs could be shaped, twisted, or even turned, but it all adds to the amount of work. The brass top plate could be without piercing if preferred, and a design could be engraved very strongly or even other metals might be inlaid.

Special Feature.—This is the top, as it gives such a fine opportunity for the introduction of an original geometrical design.

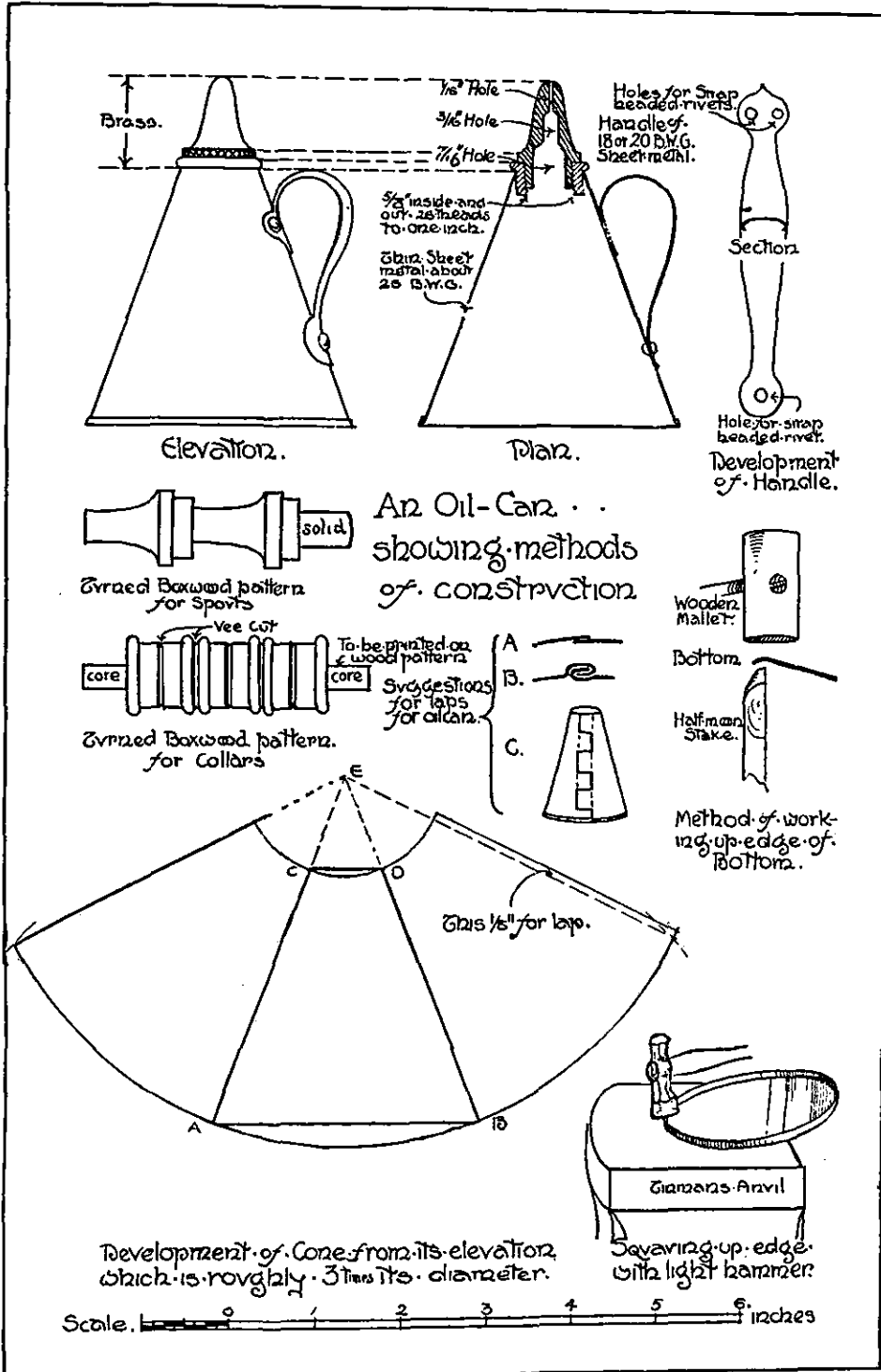

FIG. 9.—An oil-can, showing methods of construction.

AN OIL-CAN (Fig. 9).

Subject.—An oil-can, a most necessary and useful object in a metal workshop, and in making this a large variety of processes have to be gone through.

The Joints.—They are lap, folded, cramped, riveted, soft soldered, and screwed.

The Processes.—The full-size elevation should be set out, and from this the development of the body and the handle. The drawings of the two patterns, allowing for shrinkage and turning, should be made full size. Then the two patterns could be turned out of boxwood, working accurately to the drawings. These patterns should be sent to the foundry to be cast in brass or gunmetal, while the other parts are being proceeded with. The next step is to cut out the development of the body and use it as a templet, or develop the body on to the metal being used, which should be 26 or 24 I.S.W.G., and cut it out with the snips; the burr should be rubbed off with a file, and the body bent up to shape on the funnel stake (Ch. xvi, f. 21, No. 24). If the joint in this is going to be the folded joint B or the cramped joint C, the edges should be prepared before bending the body into shape. When the body has been bent to shape the seam should be set down, so obtaining a neat and close joint, and the body measured and compared with the drawing. The circle for the bottom could now be cut out with the straight snips and trimmed up, a line drawn on it to correspond with the outside diameter of body, and the edge turned up as illustrated. The handle should now be cut out, the holes punched, and worked up to the shape required, and the spout and collar turned and screwed. The screwing could either be done with the taps and dies, or on the lathe with the inside and outside chasers as shown on p. 251. For method of holding turning tool for brass or gunmetal see Fig. 9, Ch. vii. The handle should now be fitted to the body and riveted on, and the collar soft soldered in position from the inside, also the inside ends of the rivets to prevent leakage. The bottom should now be fitted to the body and popped, that is, it should be placed on a polished stake and struck a few blows with a light planishing hammer, thus making it springy. This allows the oil to be squirted out by pressing the bottom in. The edge, or lag as it is sometimes called, should be worked down on to the sides of the body and soft soldered, only a very small amount of solder to be used. It could now be washed clean, and polished with dry rouge.

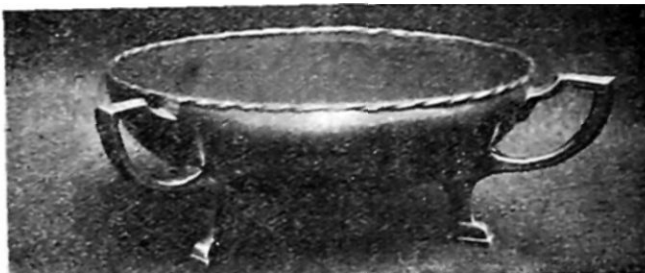

A hammered bowl in bronze.

CHAPTER IX

SPECIAL MODELS IN METAL FOR EVENING PUPILS AND OTHERS

TURNED BRASS CANDLESTICK (Fig. 1).

Object.—Useful model suitable for a second or third-year student; shows application of pattern and core box making, turning in wood and metal, screwing and drilling.

Material Required:—

- Boxwood for patterns.
- Sheet iron or zinc for templets.
- Fine plaster of Paris for core box.
- Iron rod for strengthening core box.

Method of Procedure.—1. Make templet of pillar, Fig. 1 (1), for example see Fig. 8, Ch. VII.

2. Make templet for base, Fig. 1 (5), and nozzle, Fig. 1 (3).
3. Turn pattern of pillar, Fig. 1 (1), including projections shown by dotted lines.
4. Turn core print to inside line, Fig. 1 (1), including projections shown by dotted lines.
5. See that pattern and core print are both the same length and that the projections shown by dotted lines are the same size on pattern and core print.
6. Lay pattern on some moulding sand, and pack sand all round it and level with the centre, and see that surface of sand is flat so that when the pattern is removed a sharp outline is seen.
7. Remove pattern and lay core print in, and see if there is sufficient space all round for the metal to run. If not, correct it and test again.
8. Turn the nozzle, Fig. 1 (3), to the outside line, including the dotted line.
9. Turn the base, Fig. 1 (5), inside first, then the outside and cut off.
10. Turn pan, Fig. 1 (4), and save-all, Fig. 1 (2).
11. Make core box in plaster with iron stays as shown on p. 110; where the method of making this is also described.

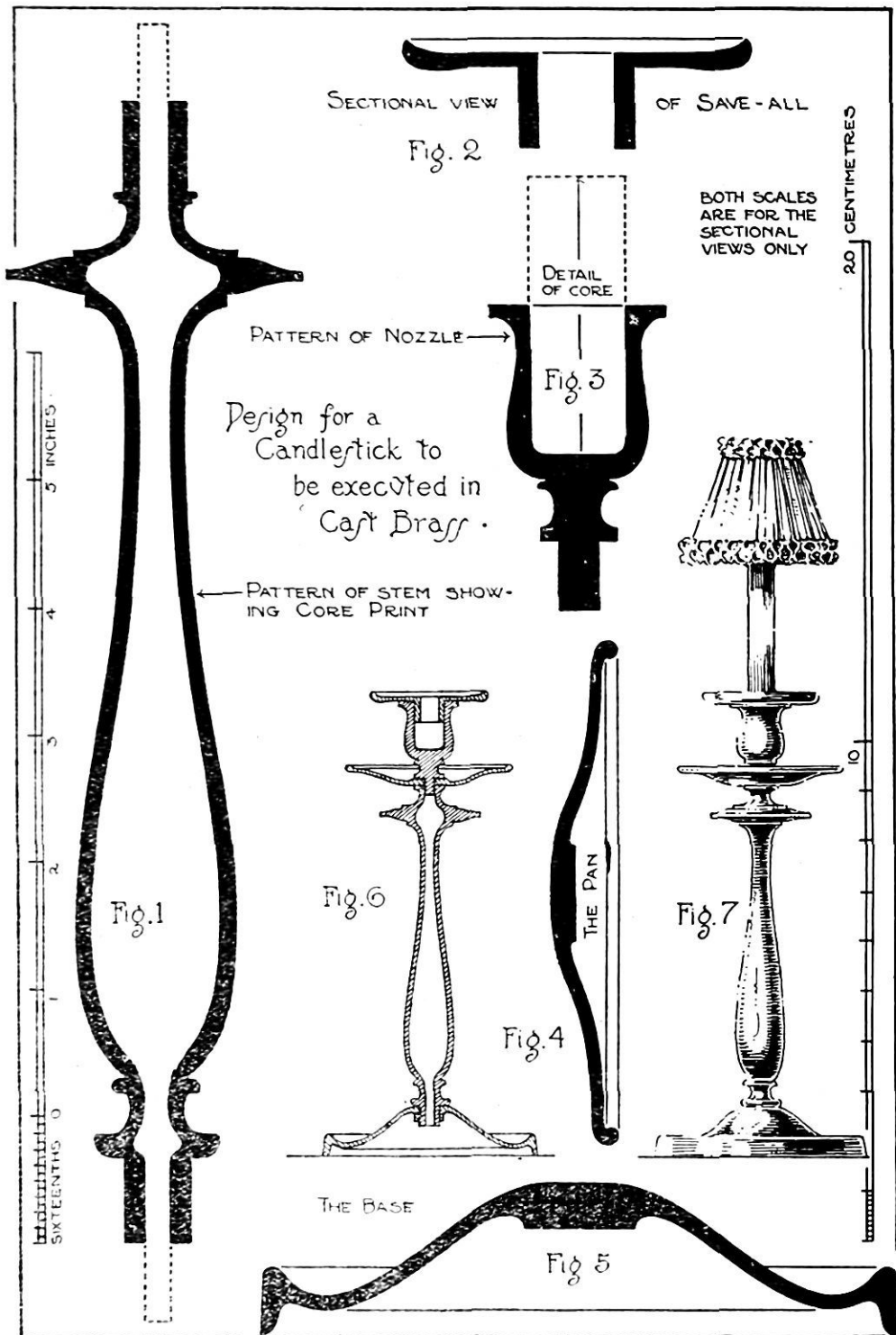

FIG. 1.—A candlestick in turned brass. Shaded section shows method of construction, thick black lines being sections of castings.



FIG. 1A.—Candlesticks of hand-turned brass. Students' work.

12. Get castings of these parts in brass or bronze as required.
13. Trim the rough lumps off the castings and immerse in weak pickle for about two hours.
14. Turn them to the correct shape, and screw the various parts so that they fit together. For method of holding turning tools see Fig. 9, Ch. VII. For turning tools suitable for this work see Figs. 22 (14-17), Ch. XVI.
15. Polish and colour down to whatever shade of colour is desired.

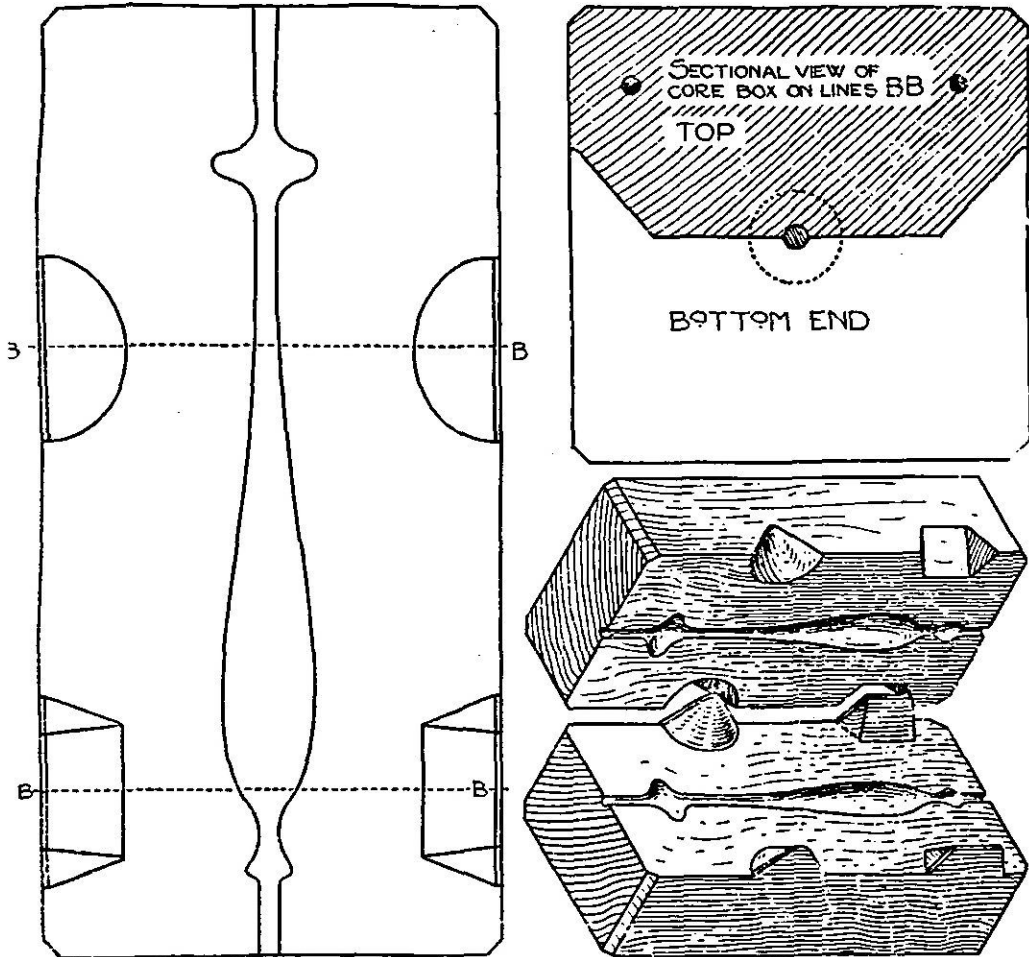

FIG. 2.—A core box.

16. Coat with lacquer and put together.

Decoration.—This article is decorative in itself, but it could be bronzed or gilt if required. If this candlestick was made of brass, then well polished and lacquered, this is all that would be necessary.

Method of Making Plaster Core Box.—

1. Have a box of moulding sand and level off the top.
2. Bury core print in to a depth of one-third or a little more, but not half.

3. Cut some pieces of flat thin metal the length, breadth, and about 3 in. deeper than you require.
4. Stick these in the sand, forming a box round the core print.
5. Take core print out of sand, well grease, and replace.
6. Mix up plaster of Paris with water to the consistency of cream and pour over core print to a depth of about 1 in. or a little more; let it set a bit, then put in iron wire stays and fill up with plaster.
7. When set, take off the sand and cut face down so that core print is embedded in the plaster exactly half-way; cut hollows for guides.
8. Do not take core print out of plaster but well grease core print, and face of plaster.
9. Place this half of core box on the sand, face uppermost; put pieces of tin round the sides as before, mix and pour plaster on this as before.
10. When set take off sand and trim off rough edges and square up to shape.
11. Wait until the whole box is thoroughly hard, then give a gentle tap and it will come apart in two halves, then remove core print.

WROUGHT-IRON CANDLESTICK (Fig. 3).

Object.—To embody various processes in a simple model, suitable for a second-year student.

Shows the application of chopping out, filing, drilling, turning, embossing, bending, brazing, screwing, fitting, and riveting.

Materials Required.—

- 7 in. of $1\frac{1}{2}$ in. round iron for pillar.
- 6 in. of $1\frac{1}{4}$ in. round iron for feet.
- $5\frac{1}{2} \times 4$ in. of No. 12 I.S.W.G. iron for base.
- 14 in. of $\frac{1}{4}$ in. square steel for spear.
- $1\frac{1}{2}$ in. of $1 \times \frac{3}{8}$ in. for base of spear.
- 6×6 in. of No. 22 I.S.W.G. iron for shield.
- $2\frac{1}{2}$ in. of $\frac{3}{8}$ in. \times No. 14 I.S.W.G. iron for chp.
- $2\frac{1}{2}$ in. of $\frac{3}{8}$ in. \times No. 14 I.S.W.G. steel for spring
- 2 in. of $\frac{1}{2} \times \frac{1}{4}$ in. iron for filling.
- $3 \times 4\frac{1}{2}$ in. of No. 22 I.S.W.G. for save-all.
- 1 in. of $\frac{1}{8}$ in. wire (iron or steel) for taper pin.
- 2 No. 4 B.A. iron round-headed screws.
- 1 iron washer $\frac{7}{16}$ in. hole.

Method of Procedure.—

1. Make thin metal templet of pillar, as shown in Fig. of Hammer Head, f. 8, Ch. VII, p. 91: also half templet of base and shield.
2. Dress up end; of iron for pillar, centre, drill small hole and countersink to fit centres of lathe

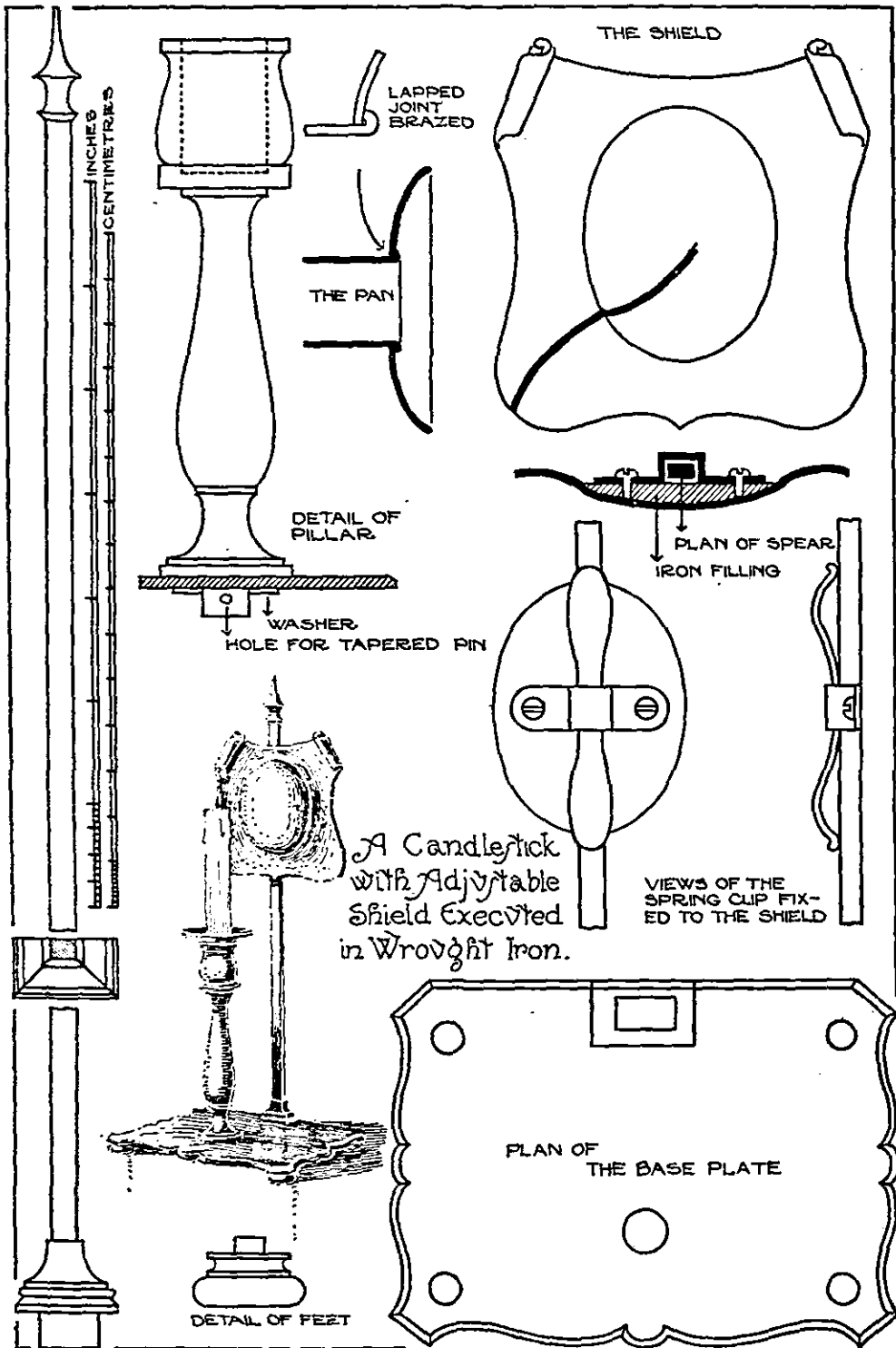

FIG. 3.—A candlestick with adjustable shield reflector.

3. Drill a hole as a guide in one end to the depth required for the socket, then drill a hole $\frac{7}{8}$ in. diameter.
4. Put the iron in the lathe and turn to fit the templet. For method of turning iron by hand, see Ch. vii, f. 10. For turning tools, see Ch. xvi, f. 22.
5. Dress up ends of round iron for the feet. Centre, drill small hole, and countersink as before.
6. Turn feet to templet, cutting them nearly off but not quite, then finish cutting them off with hack saw.
7. Mark out base on No. 12 I.S.W.G., using templet. Cut out, file up, and chamfer.
8. Upset and spread end of $\frac{1}{2}$ in. square steel for spear head and file to shape.
9. File base of spear out of the piece of $1 \times \frac{3}{4}$ in. and fit spear to same, then braze together.
10. Cut shield out of No. 22 I.S.W.G. and trim up edges. Emboss centre and bend up the scrolls.
11. Take the 2 in. of $\frac{1}{2} \times \frac{1}{4}$ in. and fit to hollow of shield, and braze in position.
12. Make spring and clip for pinching spear to shield and fit them.
13. Drill clip with holes to clear screws, drill tapping holes in filling of shield and tap with No. 4 B.A. Taper and plug tap, trying the screws when finished.
14. Make socket of save-all by rolling piece of No. 22 I.S.W.G. iron round a piece of tube or iron rod to fit the socket in pillar, and make simple lap joint and braze together.
15. Emboss pan of save-all. Cut out hole to fit socket just made and roll edge of socket over on to pan and braze from the underside.
16. Mark holes on base plate for feet, spear, and pillar, using templet, filing hole for spear rectangular with a square file.
17. Fit pillar to base plate and washer underneath, then mark hole for pin and drill.
18. Fit feet and rivet them on to base plate, leaving heads semicircular.
19. Put the whole thing together, and see if it looks square and upright.
20. Take apart, clean up thoroughly, dull polish, and lacquer with a colourless lacquer, and put together.

Decoration.—The decoration is obtained by forming the outlines of pleasing and simple curves, also by using the construction such as the raised rivet heads on the base to form a decorative feature. The chamfering is also a simple form of decoration as well as the shield, which is based on an Elizabethan example and is ornamented by the scrolled ears and raised centre which was characteristic of that period.

HINGES (Figs. 4 and 5).

Subject.—The hinges which are illustrated in Fig. 4 are Elizabethan in character, but the large one is distinctly Dutch.

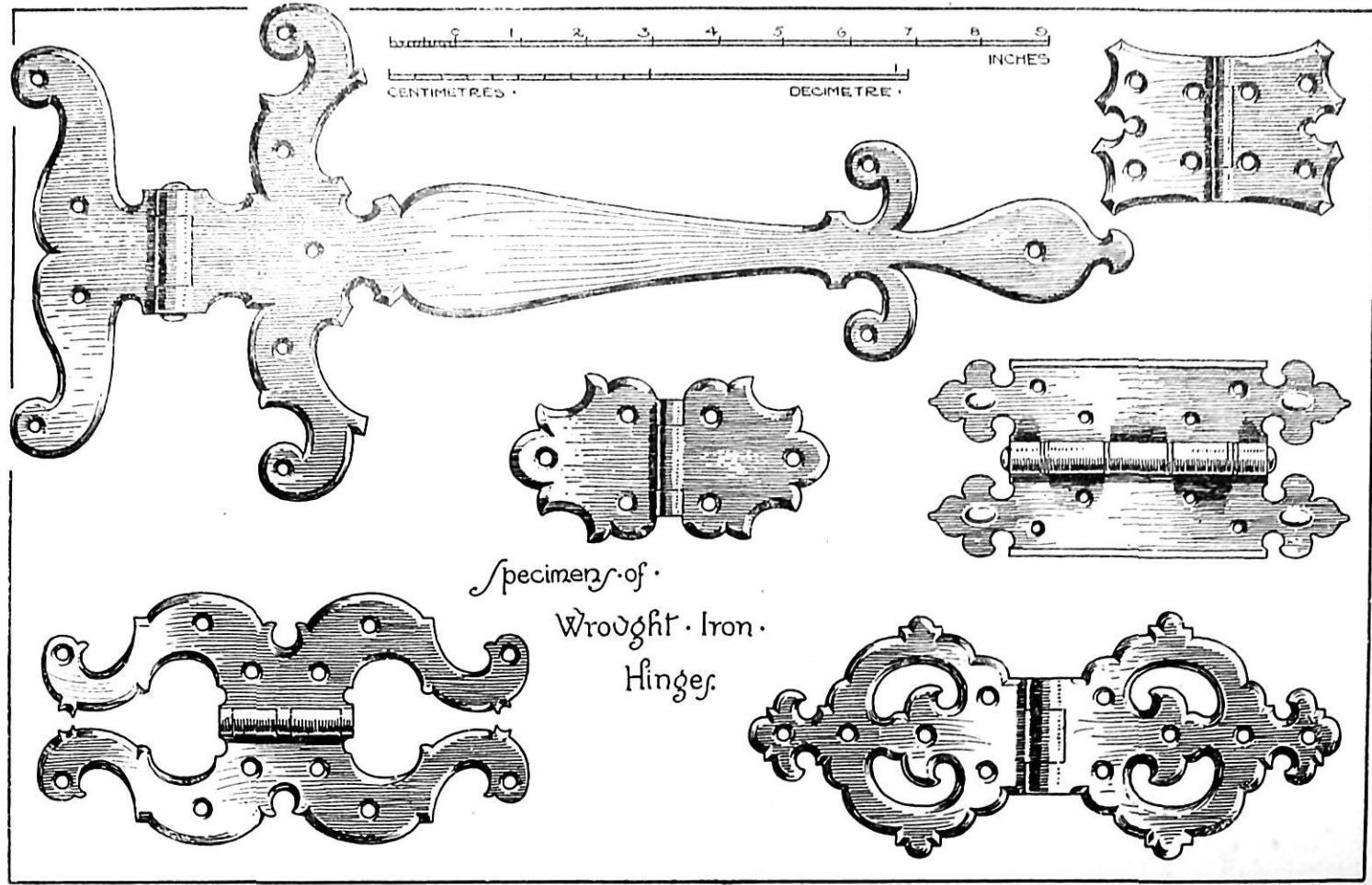

FIG. 4.—Examples of Jacobean hinges.

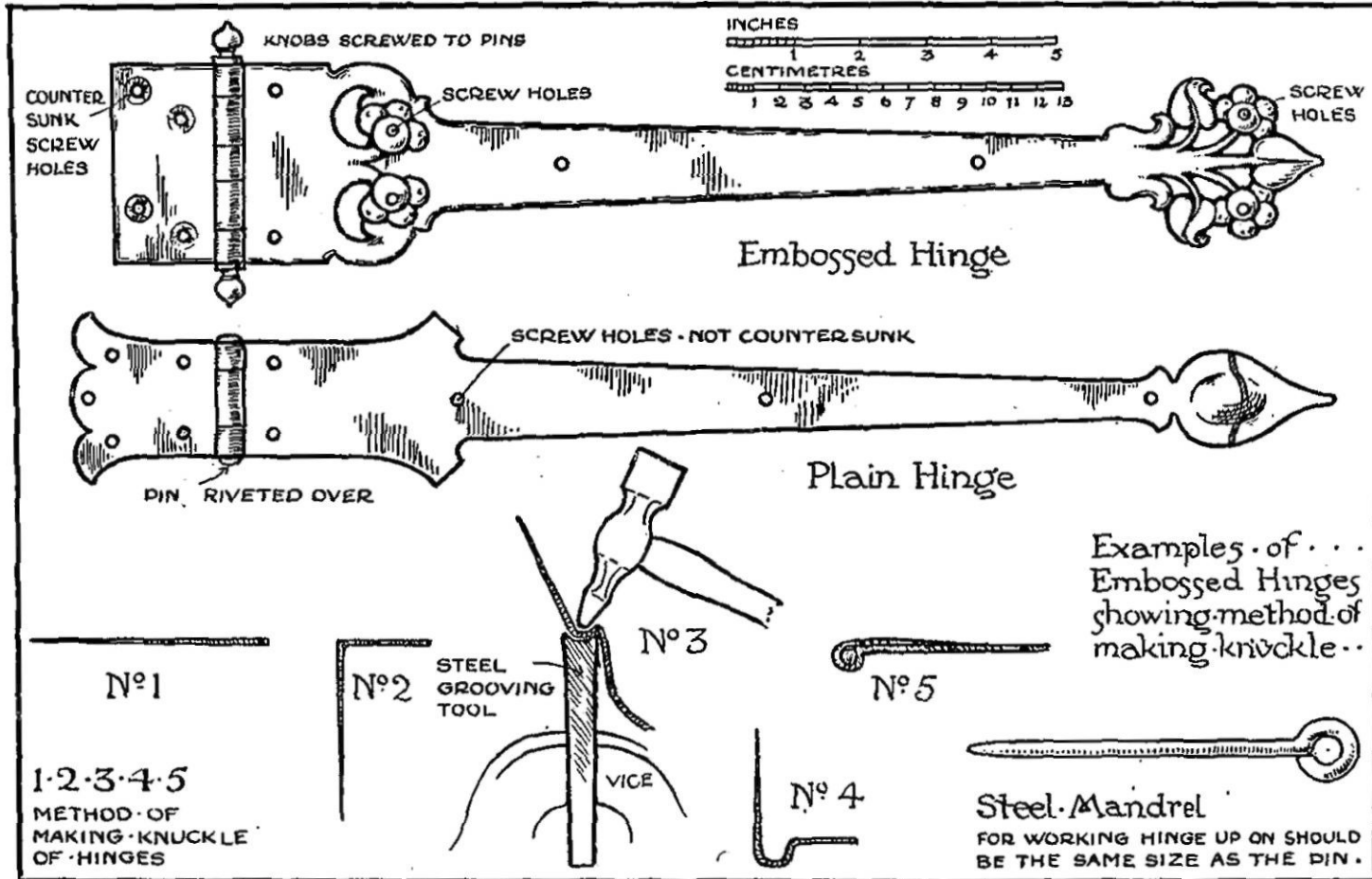

FIG. 5.—Strap hinges and a method for making the knuckle.

Those illustrated in Fig. 5 are modern, and any of these could be modified to suit existing conditions.

The Processes.—1. Make a full-size drawing of the hinge selected.

2. Make a tracing of the ornamental side, and transfer or gum on to thin sheet metal.

3. Cut the temp'et out, allowing it to butt up against the outside of knuckle.

4. Cut out the metal roughly to shape for the hinge and the flap, allowing for the knuckle.

5. Roll up the metal for the knuckles using the steel mandril, as illustrated in Fig. 5, Nos. 1, 2, 3, 4, 5.

6. Set out the knuckles for cutting, and notice should be taken that in a three-knuckle hinge the centre ones equal the other two, in a five-jointed one the two equal the three.

7. Cut the knuckles, file and fit them together neatly.

8. Lay the templet on the hinge and mark it out.

9. Raise or cut it out to the shape, and trim it up with files.

10. Drill the fixing holes, and file off the burrs.

11. Cut and fit the pin for the knuckle; if knobs are going to be used, the pin should be screwed, and the knobs drilled, tapped, and turned. For shapes of turning tools for brass set see Ch. XVI, f. 22, and for method of holding them see Ch. VII, f. 9.

12. The parts should now be polished, coloured, and lacquered.

13. Put it together, taking care not to scratch it; re-lacquer if necessary. See that the knobs do not bear on to the knuckle, they must screw down tight on to the pin.

The Decoration.—This is obtained by embossing, piercing, shaping of the outline and chamfering, while the iron hinges should be hammered all over the face and chamfers with a polished face hammer, which gives them a kind of texture, like those shown in Ch. XII, f. 9, but it must be done carefully and with judgment or a pitted appearance will be the result.

Note.—These models introduce knuckling and consequently careful fitting. As hinges are made in many different forms, to suit varied conditions, these could be modified, so giving an opportunity for adapting, or designing to suit the particular purpose for which they are required.

LANTERNS (Figs. 6 and 7).

Object and Use.—A lighting fixture which can be arranged for electric light, gas or oil.

(a) Useful model, suitable for a third year student, could be modified to suit a second year student; shows the application of designing for pierced work. The knobs form useful exercises in simple hand turning. The knobs could all be made exactly alike (repetition work) by using a form tool to finish with. The canopy introduces simple raising.

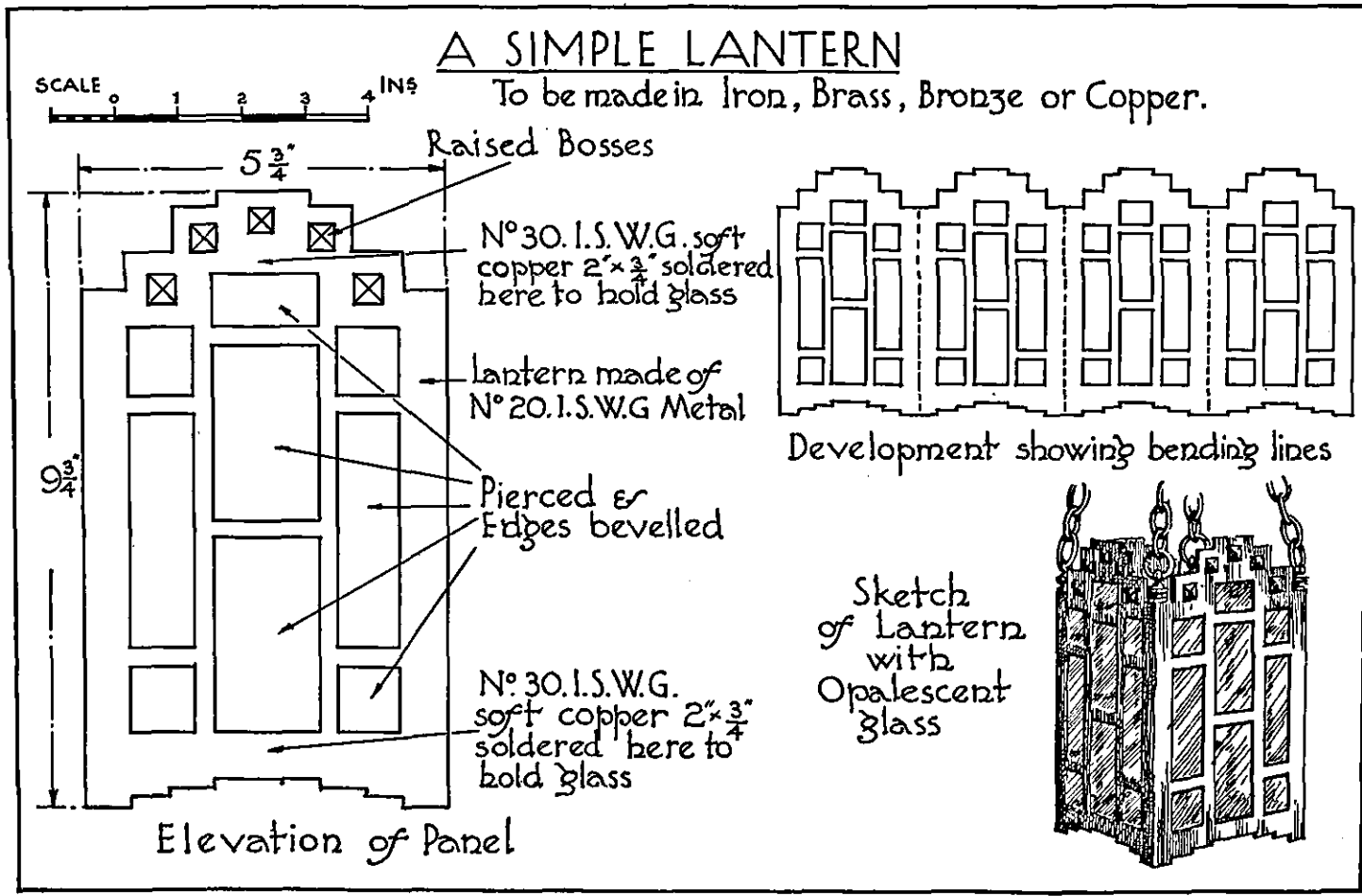

FIG. 6.—Lanterns, and a method of development.

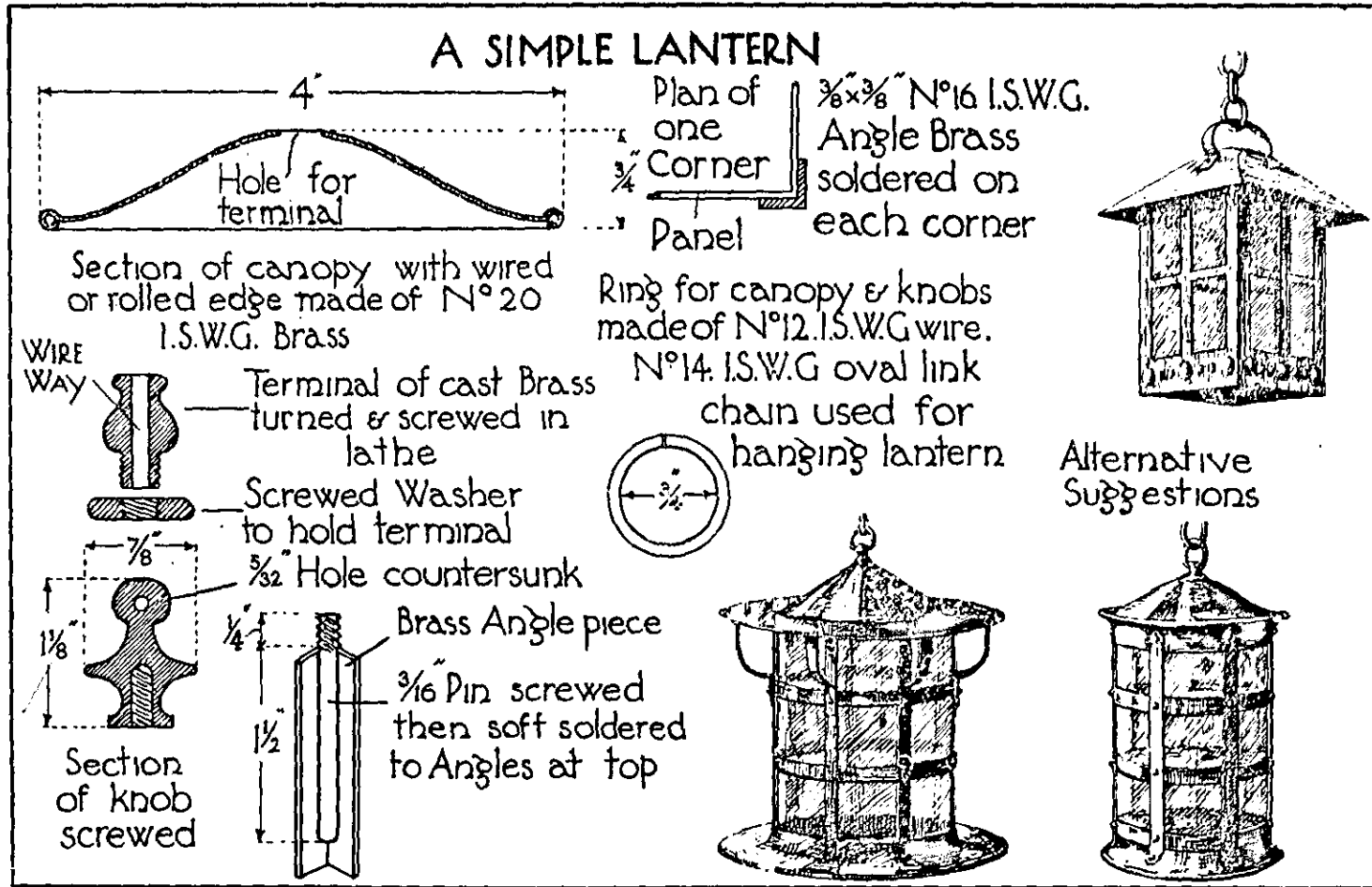

FIG. 7.—Lanterns, alternate designs.

Material Required—

Tinned plate or No 9 sheet zinc for templates.

No 22 or 20 I.S.W.G. brass, copper or gilding metal for body of lantern.

Boxwood for making patterns of knobs which should be cast, they could also be turned out of solid brass rod.

$\frac{3}{8}$ " \times $\frac{3}{8}$ " \times No. 16 I S W.G. angle brass .

No. 12 I.S.W.G brass wire.

Oval link brass chain. $\frac{3}{4}$ "

Method of Procedure.—

1. Make a half template of one side of lantern from some thin metal.
2. Set out the development of lantern as shown in the drawing, using the template and scribe in the design with a steel scriber.
3. Centre dot in a corner of each place to be pierced. Drill $\frac{1}{8}$ " holes where marked with dot punch.
4. Saw pierce out the lantern, using No. 3 saw blades (for metal).
5. Trim up to shape all edges, using a smooth file, and holding the work between two pieces of wood in the vice (this prevents chatter whilst filing).
6. Line the bending lines with a thin tracing tool, resting job on a clean piece of wood.
7. Bend up the scrolls, hammering them round a very small bick iron and finishing them off with small round-nosed pliers.
8. Bend up the lantern to shape using the hatchet stake.
9. Tack the ends together with soft solder on the inside and make the body all true and square.
10. Cut off and square angle brass to correct lengths.
11. Cut off 4 pieces of $\frac{3}{8}$ " round brass wire $1\frac{3}{4}$ " long, and screw the ends $\frac{3}{16}$ " Standard Whitworth. File bottom portions of wire to fit brass angle pieces and soft solder them in position.
12. Trim off top corners of lantern with a file to allow angle pieces to fit snugly to body of lantern, then soft solder angle pieces in position.
13. Turn out of boxwood the patterns for the terminal, the washer, and the knobs. Four knobs could be turned in one length and get them cast in brass or gun-metal. Another method is to turn them from the solid rod. With regard to the knobs, a forming tool made out of an old flat file could be used in finishing, so making the knobs all alike. The terminal should be drilled first then turned and screwed by hand to fit the washer. The washer should be drilled and then tapped $\frac{1}{8}$ " Fine thread for brass, 26 to 1".
14. The knobs should be drilled with $\frac{9}{32}$ " drill and tapped $\frac{3}{16}$ " Whit. whilst in the lathe and cut off last.
15. The ball end of knobs should now be centre marked each side of ball and drilled from each side, then countersink each side of hole.

16. Obtain about 12 inches of $\frac{5}{8}$ " round rod, drill a $\frac{1}{8}$ " hole $\frac{3}{8}$ " deep in it about 3" from the end; get some No. 12 L.S.W.G. brass wire, put one end in the hole and wind the wire closely round the rod until you have a dozen rings; now hold rings in the vice and saw them right across and they will drop apart. Trim the sawn edges of rings with a smooth file and anneal the rings.

17. Cut out a $4\frac{1}{2}$ " circle from No. 20 or 22 L.S.W.G. metal, marking a line $\frac{3}{8}$ " from edge.

18. Hammer up the canopy in a wood mould and check the shape with a template.

19. Rest edge of canopy on a lead block and trace a groove on the line marked. Hold tracing tool in the vice and hammer the edges of canopy over the tracing tool. True up the edges and make the groove so formed regular and true on a flat surface.

20. Bend up a wire circle to fit the groove, using No. 12 L.S.W.G. wire; file the ends neatly to butt together. Place wire circle in groove and hammer the metal over the wire, finishing off smoothly with a grooving tool.

21. Drill $\frac{1}{2}$ " hole in top of canopy for terminal, and 4 $\frac{5}{8}$ " hole spaced evenly around the edge just inside the wired edge to take the rings.

22. Obtain some No. 30 L.S.W.G. soft copper and cut out 8 pieces $2" \times \frac{3}{4}"$ and soft solder these in position inside the lantern body ready to receive the glass.

23. Obtain some oval link brass chain and cut it off to length, seeing all the pieces are the same length. Squeeze the links of the chain with a pair of pliers to get exact adjustment of length.

Decoration.—The lantern is decorative in itself, but it must be finished off in some way. It could be: (1) polished and lacquered; (2) scratch-brushed and lacquered; (3) bronzed and lacquered; (4) silver oxidised and lacquered; (5) copper oxidised and lacquered.

After the lantern is finished the rings and chains should all be assembled and adjusted, the glass fitted and the copper clips pinched up tightly against the glass.

HANDLES (Fig. 8).

Subject and Uses.—In Fig. 8 are illustrated a number of handles of various types, involving many processes, and the use of many metals. With very little alteration they could be used for many other purposes besides fire implements. They are suggestions showing what is really practical, and are placed in order of difficulty. No. 1 is the easiest to make, while No. 12 is the most difficult. Before making any of these a working drawing must be made giving the various sections through the different parts. The drawings should be finished in ink.

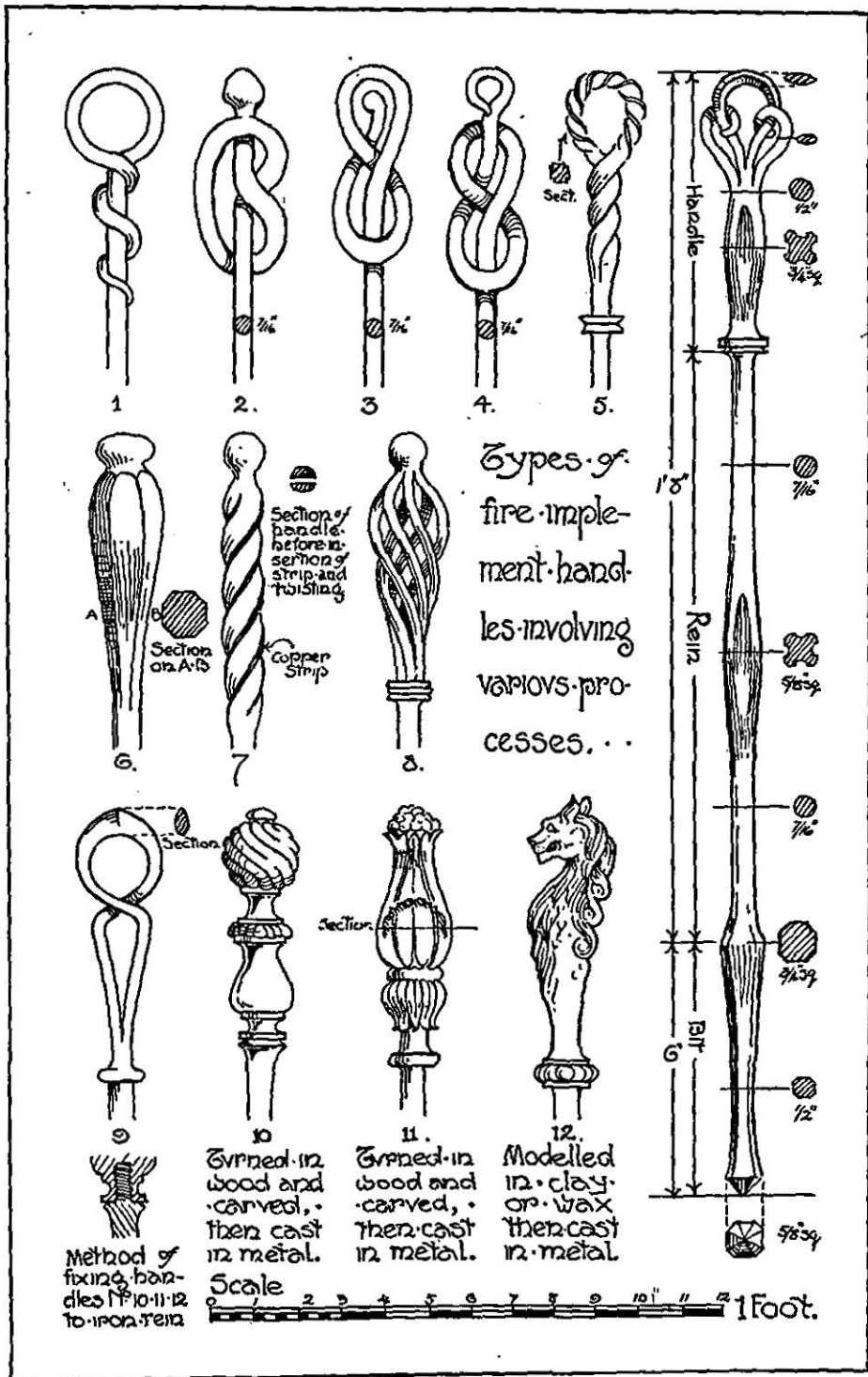

Fig. 8.—Suggestions for handles in various metals.

The Processes.—No. 1. This is made of iron.

1. Draw down a piece of $\frac{7}{16}$ in. or $\frac{3}{8}$ in. round to the required length.
2. Bend it as illustrated in Fig. 8 (3), Ch. vi, and twist it round the stem.
This would have to be done while at a red heat.
3. Clean it up and finish it armour bright.

No. 2. This is made of iron.

1. Heat a piece of $\frac{7}{16}$ in. or $\frac{1}{2}$ in. round iron and tie a knot as you would with a piece of cord (experiment with the cord first), and only the hammer and anvil is necessary.
2. On the piece that projects shut a collar as illustrated in Fig. 9, No. 3.
3. After the collar has been shut on raise to a welding heat and shape it with a hammer.

4. Clean up with files and emery cloth, and finish it armour bright.

No. 3. This is also made of iron.

1. Practise with a piece of cord before commencing this.
2. Draw out a piece of $\frac{1}{2}$ in. or $\frac{7}{16}$ in. round until you have the required length, then roll up the end tightly and weld together to form the flat solid scroll end.
3. Bend up to shape.
4. Clean up and finish armour bright.

No. 4. This is also made of iron.

1. Experiment with piece of cord first.

2. Draw out a piece of $\frac{1}{2}$ in. or $\frac{7}{16}$ in. round to the required length.
3. Bend to shape.
4. Clean up and finish off.

No. 5. This is also made of iron.

1. Measure the exact size of loop and mark it off, then allow sufficient for drawing down and welding together.
2. Flatten the four corners slightly of the length marked off for the loop, and just past the marks.

3. Put a deep chisel cut down the centre of the flat on each corner.

4. Draw down each end from the square to the round.

5. Now heat and twist this centre portion.

6. Bend round a piece of round iron and bring ends together.

7. Weld ends together, scarf, and weld on to a piece of $\frac{1}{2}$ in. $\frac{7}{16}$ in. rod.

8. Heat between loop and end, cool and hold end in the vice, place a piece of round iron in the loop and twist.

9. Weld a collar on as illustrated in Fig. 9, No. 3. Before actually welding on the collar it would be better to thicken the stem by upsetting it, just where the collar is going to be. This prevents the stem wasting just where the collar is.

10. Shape the collar with a top and bottom tool or with a file.

11. Clean up and finish armour bright.

No. 6. This could be made of iron, or a wood pattern could be turned and filed up, then a casting could be made in brass or bronze, and this could be

brazed to a rein of similar metal, and then filed up. If it was made of iron and used as an exercise in forging it would be made as follows:—

1. Have a convenient length of $\frac{7}{8}$ in. round and upset it where the thickest part is.

2. Draw the lower part away with top and bottom fullers until nearly to size.

3. Put neck in with top and bottom collar tools or with thin top and bottom fullers and shape up the knob with the hammer only.

4. Cut off excess material at bottom and scarf and weld on to the proper size rein.

5. Finish shaping up the flats on the handle and work the flats into the round gradually.

6. True the flat surfaces up with a file.

7. Finish off and polish.

No. 7. This is made of iron with a strip of copper inlaid. Yellow metal that will stand forging could also be used.

1. Get two pieces of $\frac{3}{8}$ in. square iron and make them half-round with a $\frac{1}{2}$ in. top swage.

2. Place them with the flat sides together and weld them at the top and bottom.

3. Weld a collar on at the top end to form the knob as illustrated in Fig. 9, No. 3.

4. Scarf the bottom end and weld on the rein.

5. Get the piece of metal you wish to inlay; thin the ends down and leave it a little wider than the half-round pieces.

6. Heat the handle and separate the two pieces of half-round with a thin chisel; insert the metal strip and close it all up tight.

7. Now heat it carefully all over; place one end in the vice, and holding the other end with the tongs or pliers twist it.

8. If the handle has got a little out of shape straighten it while hot with a wooden mallet.

9. Finish off and polish.

No. 8. The method of making this is shown in Fig. 9, and explained on p. 126.

No. 9. This should be made of iron and is a more difficult piece of forging. The shaping is done with the hammer. When finished it could be used as a pattern for casting from, by cutting one side just where they cross over, and bending it clear of the other side, so leaving it. If they are cast from this in copper, bronze, or brass, after they have been annealed and filed up it can be bent back again to its original shape and brazed together. If neatly done the joint hardly shows. If made of iron the method of procedure is as follows:—

1. Take a piece of $\frac{1}{2} \times \frac{1}{4}$ -in., roughly mark off the length required and draw down the ends and round them, working away from the centre.

2. Shape and bend the ring at top simultaneously.

3. Finish bending and working it to shape, trim off the ends to the right length, close them together and scarf them.

4. Take the piece of iron for the rein, upset the end and shut a collar on as illustrated in Fig. 9, No. 3, leaving a piece projecting through.

5. Shape up the collar and scarf the piece projecting at end.

6. Weld the handle on to the piece projecting beyond the collar.

7. Clean up and polish.

No. 10. This would be most suitable if made in bronze, but it could also be made in any similar metal, and it is a pattern suitable for casting.

1. Turn exactly to the outline in some hard wood, such as boxwood.

2. Carve the ornament.

3. Cast in bronze.

4. Pickle it to remove the sand.

5. Turn all the plain parts in the lathe.

6. Chisel, riddle, and chase up the carved portions.

7. Polish with sand and crocus in the lathe.

8. Stain a dark brown as explained on p. 193.

9. Lacquer with transparent lacquer as described on p. 223.

No. 11. This one could be made exactly as described for No. 10, but as an alternative it could be modelled on a core, say an iron rod, in some plastic material, then cast in three parts in plaster; this would be the mould; this should be well greased, or soft soaped, then the pattern could be cast in this, but it should be strengthened with an iron core. The finish would be the same as No. 10 or varied according to taste.

No. 12. This would also look well in bronze, but it would have to be modelled as described above, and finished as No. 10. An excellent exercise in modelling in the round.

THE COMPLETE POKER.

This would be most suitable if all in iron, and it would be made in three pieces, namely, the handle, the rein, and the bit; these when finished would all be welded together.

The Handle.—1. Make the loop from $\frac{5}{8} \times \frac{1}{4}$ in.; shape and bend it, and scarf the two ends together.

2. Shape the grip part of the handle from a piece of $\frac{5}{8}$ in. square, thicken it up where the collar is and work up the collar, and draw away for the rein.

3. Scarf the end of the grip, and weld on the loop piece.

4. Draw down the two tail pieces from $\frac{3}{8}$ in. round iron, cut them off, and scarf the bottom ends where they are thickest.

5. Weld the two tail pieces on to the handle.

6. Dress up the handle, and put the grooves in with top and bottom fullers.

7. Curl the tails round the loop of the handle and see they set nicely.

8. Cut handle off where it has been drawn away for the rein, and scarf it just below the collar.

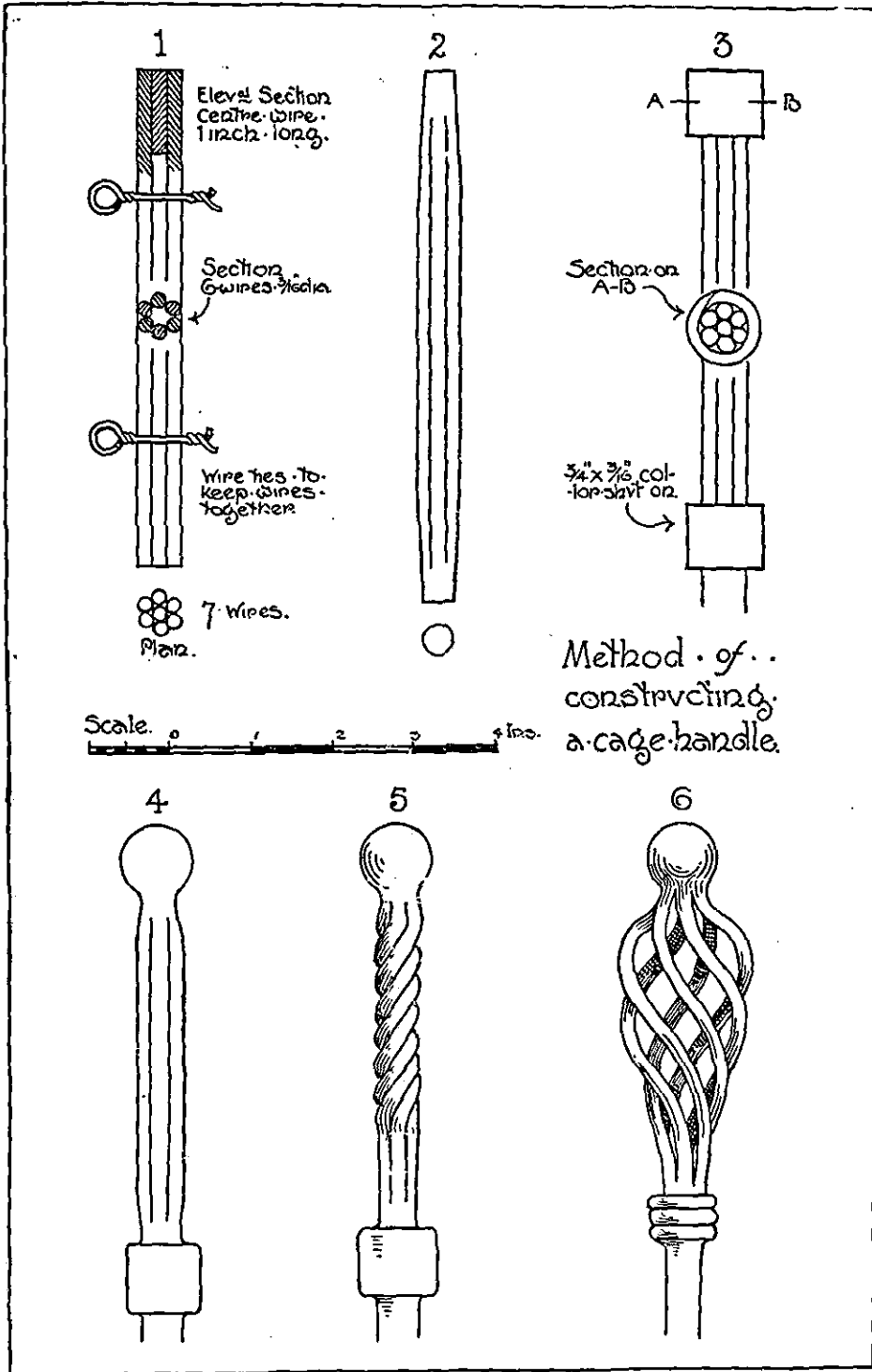

FIG. 9.—Processes in making a cage handle.

The Rein.—1. Get a piece of $\frac{5}{8}$ in. square, draw away each end, round up with top and bottom swages.

2. Shape up the centre boss and groove with top and bottom fullers.

3. Scarf each end. The ends of the centre rein should have been left a little thicker ready for scarfing.

The Bit.—1. Get a piece of $\frac{5}{8}$ in. square, work the bit roughly to shape, draw down the end and scarf ready for welding on to the rein.

2. Weld the rein on to the bit.

3. Cut the surplus material off.

4. Hold it by the rein and work the bit into shape and finish off.

5. Weld the handle on to the other end of the rein seeing that the overall length is correct.

6. Examine it all over, clean it up and finish off armour bright.

METHOD OF MAKING A CAGE HANDLE.

Subject and Uses.—The drawings in Fig. 9 illustrate the method of making a cage handle, which is very suitable for fire implements. This is excellent practice in light smithing.

The Joints.—These are all welded joints.

The Process.—1. Cut off six pieces of rod the length required, also two short pieces, and tie together with iron binding wire as shown in No. 1.

2. Weld the ends together at the top and bottom as No. 2, holding them in the hollow bit tongs.

3. Upset and scarf a piece of $\frac{7}{16}$ in. round, scarf one end of the handle and weld together. This gives you something to hold it by.

4. Shut a collar on top and bottom as drawn in No. 3

5. Heat the end to a welding heat and form the knob as in No. 4, then slightly round up bottom collar.

6. Heat evenly in the required place (see No. 5) and carefully twist it. The heating is important, or it will not twist evenly.

7. Carefully heat and unwind slowly, slightly tapping the knob, thus shortening the handle a little.

8. Regulate the cage so formed with flat and round-nosed pliers.

9. Shape bottom collar with half-round files.

10. Clean up with files and emery cloth, seeing that the wires are kept circular.

The Decoration.—The handle itself is decorative, but it could be enriched by shaping the knob or engraving it. The handle need not be made from round wire, but it could be made from $\frac{3}{16}$ in. square that has been twisted in opposite directions, so that as there are six wires you could have one twisted to the right and the next to the left and so on. When finished three wires would have a very gradual or slow twist.

Special Features.—This is the welding; and the ball knob should be done with a hammer, not filed. It is a good test for the appreciation of line and form, as a templet or guide is not used.

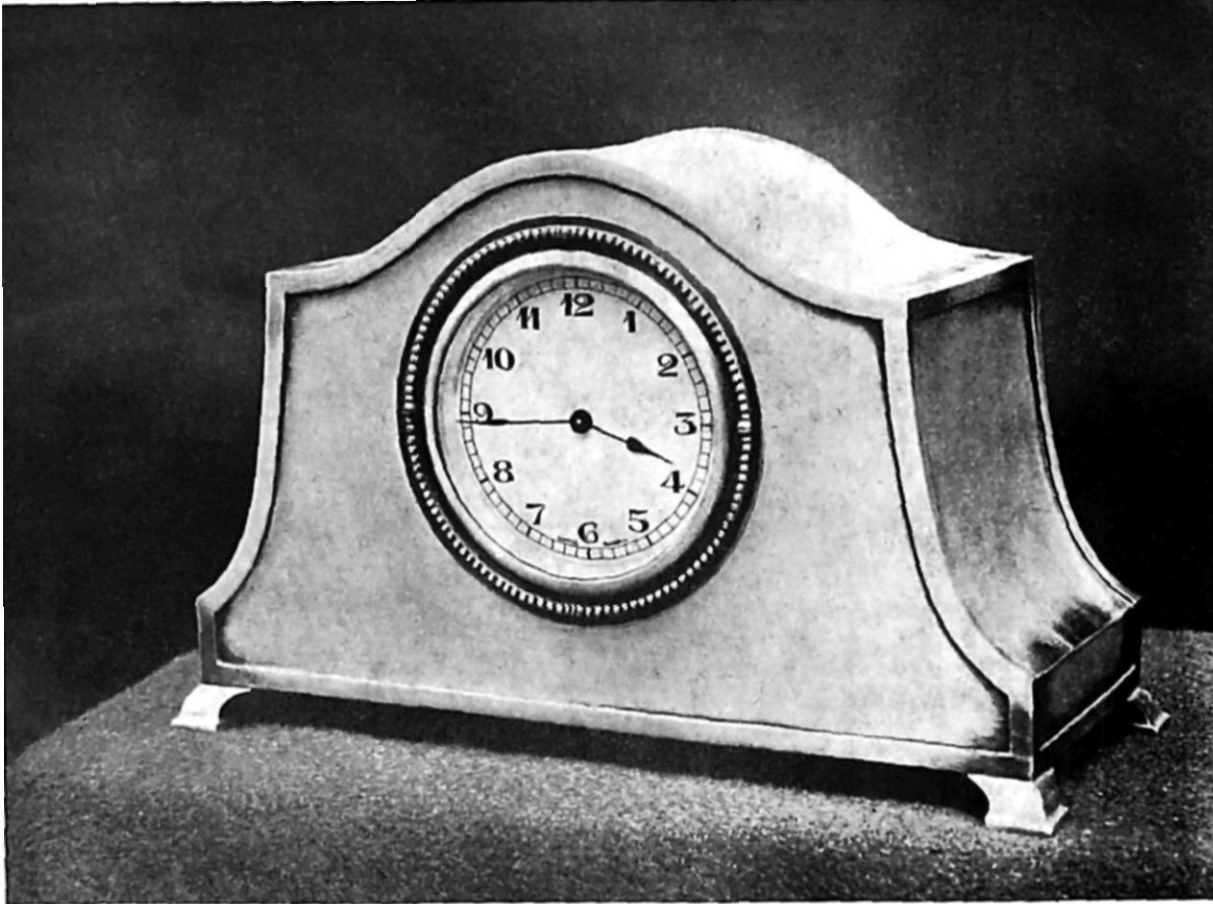

FIG. 10.—A clock case in brass-finished oxydised silver.
Students' work.

CLOCKCASE (Fig. 10).

This is a useful and interesting model for a student in the advanced stage.

It is excellent practice to design a simple shape to suit the clock movement. As the frame is made from angle brass, the shape is limited to the possibilities of angle brass.

The frame is made up on a piece of hardwood that is cut to the outline of the clockcase, and all joints are silver soldered. The panels are of thin hard rolled sheet brass and are soft soldered to the frame. The clock movement is held in position by small screws which are screwed into small blocks of brass that are soft soldered to the inside of the front panel. The feet have been cast in brass from a wood pattern. The door made in the back panel is so that the clock can be wound up. The case has been polished, silver oxidised, and lacquered.



FIG. 11.—Tazza, silver gilt, engraved, the centre chased and repoussé. English; London Hall-mark for 1564-5.

(Victoria and Albert Museum.)

CHAPTER X

HISTORIC CRAFTWORK AND ITS APPLICATION TO CLASSWORK

HANDCRAFT or manual training should—as has been previously indicated—not be restricted to mere hand training or dexterity, but should aim in the widest sense at a general understanding and appreciation of handwork, in fine pieces of craftwork and buildings. Whilst many pupils of handcraft classes must inevitably enter trades, it does not necessarily follow that the instruction should be in any sense vocational. The authors favour traditional methods because of their proved value and of their educational possibilities, but in the early years of handcraft training, the training is necessarily educational and cultural. The writers think it will be granted that those pupils who are later to enter the various artistic and mechanical trades, and who take up a regular course of technical work would, after a good handcraft course, be sure to profit by the more advanced training, and would also be able to proceed directly to technical courses.

The United Kingdom teems with fine entrances and doorways belonging to bygone periods, churches, cathedrals, castles, public buildings, colleges, and town and country houses presenting many splendid features. Fig. 1 represents a fine example of a doorway at Southgate Street, Winchester. The Brothers Adam designed many fine doorways of this type which may be recognized by their refined treatment of classic detail. "Adam" doorways are always composed of classic elements such as fluted columns and pilasters, cornices with dentils and "guttac," and the design of "Adam" doorways clearly indicates the source and inspiration of their work. They frequently designed doorways such as the one illustrated with overhanging "porticoes," and their designs for doorways are also characterized by finely designed "traceries" in the "fanlights." Portico is an interesting architectural term derived from the Latin word "porta" (a gate), and this root can also be traced in other interesting terms such as porch, portière, and portcullis. Portico means, literally, a range of columns or colonnade in front of a building. The entrance is set back from the columns as in the case of the West Front of St. Paul's Cathedral, and the Royal Exchange, London. The front of the portico is characterized by two fluted columns, classic in character but not copies of any of the columns belonging to the classic orders. The column itself would provide ample material for one object lesson, if an instructor treated this from earliest times and dealt briefly with the general growth and

development to the time of the famous Greek buildings. The German archæologists, Von Reber and Winkelstein, in their various works deal at great length with early columns. Von Reber gives an interesting account of the primitive square pier in the rock-hewn chambers along the Nile. These were carved from solid rock, and the necessary support for the roof or ceiling was provided by leaving a square pier at intervals. To facilitate moving about these chambers, he considers that the corners were chamfered away, thus forming an eight-sided or octagonal column. The second stage appears to have been similar to an irregular octagon in sectional plan, and the third indicated above was an improvement on the octagon, for all the sides were equal in size or regular. A desire to improve upon this type is believed to have led to the sixteen-sided column by the simple process of doubling. The last development would naturally lead to a column almost circular in sectional plan, for Von Reber thinks that the Egyptians rejected the sleek rotundity of a circular column, in favour of one displaying greater preponderance of vertical line, which suggests greater strength and rigidity. A desire for ornament appears to have suggested channelling each side, and this would also accentuate the vertical line effect. Some authorities consider that the last stage represents the "proto-Greek" form which was later to develop into the columns of the Ionic, Corinthian, Doric, Tuscan, and Composite orders. The parts of a column are variously named shaft, neck, capping, base, frieze moulding, flutes, fillets, scrolls. The terms "entasis" and "module" are also introduced. If the column with corresponding parts of the order are dealt with, then the following terms would also be dealt with, viz. cornice or entablature, cornice moulding, frieze, frieze moulding, modillion, guttæ, dentil, pedestal, base, surbase, plinth, and abacus. It would be difficult to find a building which did not have parts corresponding to those mentioned above, and as each term has a distinct and separate evolutionary interest, and many are derived from the same roots as more commonplace words, it will be seen that a unique opportunity is afforded for linking up learning or culture with real things. Above the columns of the portico is the cornice, adaptations of which are seen in commonplace things in every home. Thus the "frieze" of the cornice applies also to the cornice of a wardrobe or bookcase, whilst the moulding of the portico cornice has its parallels in a plaster ceiling cornice, sideboard, cupboard, etc. It could be pointed out in another lesson that all mouldings are made up of various elements found in the classic orders of architecture, such as "cyma recta" or right ogee, "cyma reversa" or reversed ogee, "corona" or drip, "trochilus" or scotia, "cavetto" or hollow, "ovolo" and fillet, "astragal" or bead, "fillet" or square, "torus" and "fascia". Some of these elements occur in the cornice illustrated, whilst the frieze part introduces such terms as "swag," "husk," and "patera". To further illustrate the application of architectural terms to domestic features, one has only to quote "skirting," the moulded board round a room, or "plinth," a moulded base to a piece of furniture, the "architrave" of a door, and the frieze or picture-rail of a room. Ordinary room doors have "stiles," "muntings,"

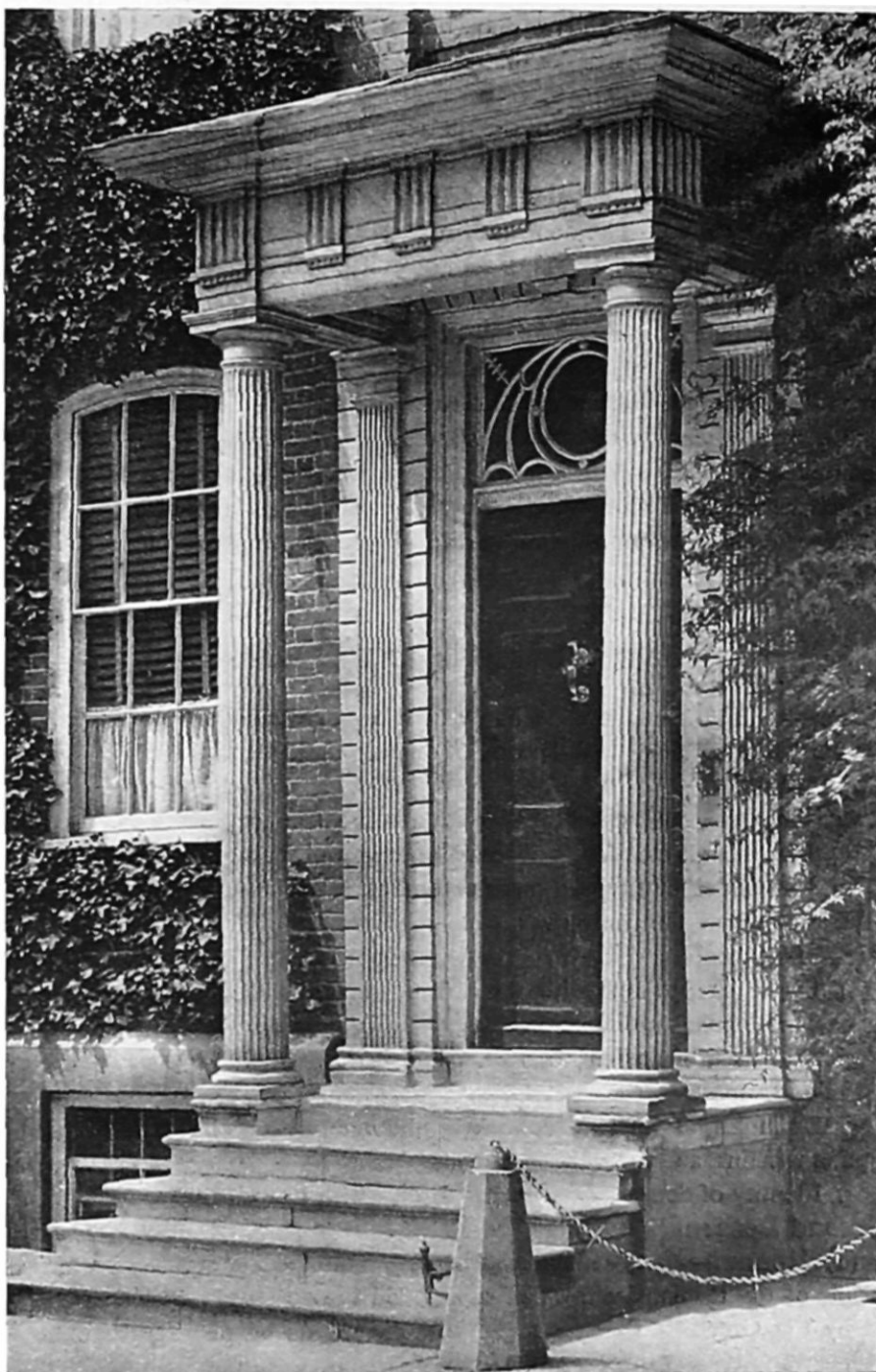

FIG. 1.—Doorway at Southgate Street, Winchester.

rails, and panels; Gothic windows have tracery, quatrefoils, trefoils, cinquefoils, lancet shapes, etc. An analysis of the terms is valuable, as indicating a common root origin with other common terms or words. It will be seen upon reference to the photograph that the back of the portico has two supporting "pilasters". The parts of these are named very similarly to the parts of the column, and the connexion between "pilaster" and the Latin word "pila," a column, pillar, and pylon, should be noted. The door itself in Fig. 1 gives another fine opportunity for the discussion and comparison of terms, and the fanlight above the door is a feature of the period. Whilst upon the subject of doorways, mention should be made of others than the one directly dealt with, such as those with semicircular arched tops, a feature of Roman construction, and usually made with tiles. Norman doorways in churches and monastic buildings are also semicircular, and massively built of stone with carved decoration. Gothic doorways usually have the pointed arch as a distinguishing feature, whilst those built during Tudor times have a characteristic Tudor arch, like a flat lancet shape. Below are given a few notes and suggestions in connexion with object lessons based upon the foregoing matter.

OBJECT LESSONS ON DOORWAY.

It is suggested that the class has visited a doorway, similar to the example shown, or has a large charcoal drawing of one displayed upon the wall.

Apparatus.

- (a) Large charcoal sketch of doorway about 4 feet to 5 feet high.
- (b) Blackboard, etc., for sketches, diagrams, and notes.
- (c) Plaster cast of a typical piece of ornament (such as for example part of the frieze shown in photograph).

First Lesson.

1. The teacher to deal with the earliest known doorways, giving as an example a simple hole with stone or block rolled in position for security.
2. Evidences of ancient doorways and gates, as shown by Biblical and classical quotations.
3. Examples of ancient doorways, photographs or diagrams of ancient Egyptian remains, and museum specimens.
4. Identity of doorways. Teacher to deal with historical examples.

Second Lesson.

(a) **Roman.**—With semicircular head. Noting characteristics such as the principle of the Roman arch, which superseded the post and lintel construction used by the Greeks. Teacher to indicate by means of photos, diagrams, or slides, existing remains of Roman work showing these features.

(b) **Norman.**—With semicircular head, but built up with sections of stone. Note the decoration of these types and deal with examples in old churches, etc. Deal also with term "Norman" and historic matter.



FIG. 2.—Ironwork at No. 44 Great Ormond Street, Bloomsbury (1708).

Third Lesson.

(c) **Gothic.**—Pointed arch construction, class to note development from semicircular; with brief historical notes of the time. Illustrate by means of large diagrams the difference between Norman and Gothic moulded doorways.

(d) **Tudor.**—With flat-pointed arch construction. The open fireplace of Tudor times with arch corresponding to doorways.

Fourth Lesson.

A Georgian Doorway as per photograph (Fig. 1).

(a) Characteristics of the Georgian doorway.

1. Entrance door with fanlight above.
2. Portico with cornice supported by classical columns.
3. Without portico, but with pilasters and consoles supporting pediment.
4. Names and outstanding work of some eighteenth-century architects.
5. Customs of the Georgian period, and use of link extinguishers attached to doorways, etc.

6. Description of terms applied to the various parts of the Georgian doorway, column, pilaster, etc.

7. Indicate application of terms to domestic objects.

Fifth Lesson.

(a) Simple outline diagrams to be drawn of the Roman, Norman, or Gothic and Tudor arched doorways.

or

(b) Simple outline diagram of the Georgian doorway with names of parts indicated, such as

pediment	cornice	column
capping	frieze	pilaster

It will be seen from the above that quite a number of object lessons can be devised with the doorway as a basis. There is quite as much interest and scope when dealing with the fireplace and the window, whilst working backwards from a piece of furniture, with a discussion of the technical terms applied, will afford opportunities for introducing craft history as well as political history. From the ironwork side there is the gate, railings, and lighting structures, all of which have passed through definite developments and cannot properly be separated from the literary side of history.

OBJECT LESSON (METAL): EIGHTEENTH-CENTURY GATES.

The photograph reproduced in Fig. 2 of eighteenth-century ironwork is typical of the period, and like much more of our older work is fully understood only when we know something of the life of the time. Indeed such pieces of work can be used to illustrate and to help us to understand a phase of London life now past.

Life and property are now more secure, and the consequent feeling of comparative safety is reflected in the way our houses are built. The doors of our



FIG. 3.—The Main Gates, Belton House, Grantham, Lincolnshire.

modern houses and mansions do not require the iron bindings we find on the castle doors. Very frequently these bindings were elaborations of the hinges on which the door was hung. Elaborations of the hinges are to-day put on church doors, but the only aim is adornment. When the moats with the drawbridges and portcullises disappeared large and very strong entrance gates of iron were made in the walls of the castles. These gates often had, in one of the leaves or panels, a small wicket-gate large enough to admit only one person at a time. Round the smaller but higher houses which became necessary because of the increased population, the walls were replaced by railings nearer the house, and these shut in the house and its forecourt as shown in the illustration. That the necessities and social conditions of the times account for the differences between the castle with its walls, moat, and drawbridge and the house shown is obvious, and whenever possible such connexions between historical facts and practical work should be pointed out.

Though around houses iron railings followed walls, it must not be supposed that their origin was merely replacing stone walls. Between the chancel and the body of Early Christian churches were iron lattice screens; inside the entrance gates of castles were strong lattice-work gates; and these with the rows of serried pikes in the hands of soldiers probably suggested iron railings. Defensive railings of plain lattice work were used by the Romans. Originally outside railings being for defence would be high, strong, and plain; inside ironwork, e.g. that in the *Rejas* or screens of the Spanish cathedrals made in the reign of Charles V., a noble and generous patron of the arts, was highly decorated. When railings were no longer merely defensive the inside decorations might have suggested decorations for outside ironwork. The actual work shown (Fig. 2) is good smiths' work, and is an advance on that of the earlier years where the smiths in their construction often copied woodworkers. Instead of punching holes in the horizontal bars which held the uprights, thus swelling the bar and in no way weakening it, they fastened the uprights with flat horizontal straps riveted through. It may be remarked that this punching was done when the iron was hot. Modern punching in the cold usually carries away the piece and leaves the bar weaker.

The large gate was lighted with oil lamps held by the rings shown on top of the lamp holders or lamp-irons, and these in turn were fixed to the lamp standards which are the tall panels on each side of the gate. The hook shown in front of the lamp-irons was for the ladder of the lamplighter. Such lamp-irons, though now common only on the houses of doctors showing their red lanterns, were then a feature of all houses of any size. A law was passed by the Mayor of London commanding all whose houses fronted any street, lane, or public passage, to hang out a lamp or lantern during the winter evenings from Hallowtide to Candlemasse (October to February). Sufficient cotton wick had to be provided for a light lasting from six to eleven o'clock. Public lamps were supplied where absence of these privately owned lamps rendered them necessary, and were provided for by fines of one shilling a head levied on those who failed to

hang out a lantern. The work of the municipal authorities, the organization of the police, and education, have provided lamps, lessened dangers to citizens, and diminished brutal crimes; but on some old houses are still to be seen interesting examples of the old lamp standards.

Another interesting feature on some old houses reminiscent of dark unlighted thoroughfares are the link extinguishers, which can be seen one on each side of the lamp standards. These curious looking horns or trumpets, into which the link-boy thrust his torch to extinguish it, are made of sheet iron. Some of them had lids. Actual examples still remain on the fine lamp standards in Berkeley and Grosvenor Squares, the mansions in which date from 1700. The links or torches of tow and resin or of pitch-pine were kept in rings driven into the walls inside the entrance. In Florence cemented into the walls of the Strozzi Palace are some magnificent torch or link holders. These are of wrought and chiselled iron in the form of a winged dragon with a human face. The mouth holds a pin with a chiselled ring into which the torch fits, and on a bracket supporting the body is a carved and studded ring for the reins of the horses of visitors. There are many specimens of these torch brackets in the Albert and Victoria Museum. The man who loves his craft must now and again mourn the fact that gas and electricity, with their often ugly cast-iron standards, have made such fine examples of good work unnecessary.

The small spikes in the bottom bar of the centre gate are known as dogbars. Necessary as such bars might be to-day in some of our London suburbs, they were still more necessary in the city where, before the days of the dustmen and bins, the offal thrown into the streets provided rich repasts for hundreds of stray dogs. They are reminders of the less pleasant and less heroic things of old days.

Dropping now the historical aspect we shall remark on some features of the photograph that may be interesting to craftsmen. The pilasters which follow the ramps are of good proportion and are of the form usually known as the lyre form. This is obvious. The C scrolls in the centre are held in position by a collar made in two pieces and riveted through. The tops of the pilasters are finished off with cast-iron knobs. The tops of the railings (usually called railings—a rail is a horizontal bar, not a vertical one) have been forged separately and screwed on to the tenons forged on the uprights. The lower ends of these uprights have been left rough and leaded into the stone base. The appearance of the work is greatly improved by moulded spikes and leafy arrows alternately placed along the tops. As J. de Wolf Addison says: "Craft may be practised without art and still serve its purpose, but an alliance of the two is a means of giving pleasure as well as serving utility." The photograph shown proves the truth of Addison's statement.

The fine pair of gates illustrated in Fig. 3, at Belton House, Grantham, Lincolnshire, are also typical of early eighteenth-century iron work. It should be noticed how the family coat of arms is embodied and forms an interesting portion of the design.

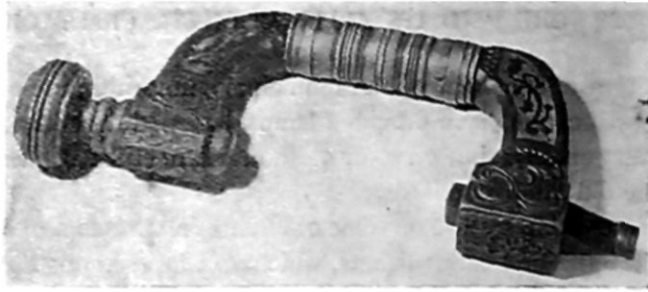

Seventeenth-century woodworker's brace.

(*Deutsches Museum, Munich.*)

CHAPTER XI

MATERIALS USED IN HANDCRAFT WORK

CLASSIFICATION, DISTRIBUTION, DESCRIPTION.

Timbers—Mother of Pearl—Blue Pearl—Japanese Pearl—Ivory—Tortoise-shell.

“After all the trees have been cut down, it will be necessary for the arts to cease.”—PALISSY (16th cent.).

TIMBER.

TIMBER is the product of “exogenous” (outward growing) trees, as distinct from the “endogenous” varieties (in which are included palms), growing or forming wood of inward growth. Practically the only exception to the general use of exogenous timber in woodworking is the use of palm, known more commonly as partridge and lacewood from its peculiar markings. Exogenous trees are again divided into two classes, hardwood and softwood trees respectively, broad and needle-leaved trees. This classification is botanical rather than commercial, for some woods of a hard texture, such as the yew, belong to the needle-leaved class. On the other hand, whitewood and poplar are soft in texture though belonging to the hardwood class botanically.

Chart I on the next page indicates the commercial and botanical classification of some timbers, which are, with the exception of yew, beech, and poplar, used in handcraft work.

Reference to Chart I will show the rather misleading classification of timbers, and this list could of course be extended indefinitely.

Effect of Climatic Conditions.—One of the most important factors in the growth of timber is climate. This accounts for the wide distribution of many types, for instance, pines, firs, and spruces are almost universally distributed, and it will be found upon examination of general conditions that differences in zones are compensated by altitude. Thus the northern pine is generally regarded as belonging to North Europe; in Northern Norway it grows at a height of 700 ft. above sea-level and 6500 ft. on the Sierra Nevada of Southern Spain. This feature of timber growth is further dealt with in Chart II.

CHART I SHOWING BOTANICAL AND COMMERCIAL CLASSIFICATION OF SOME TIMBERS.

Botanical Order	Common Name	Commercial Classification	Botanical Classification	Geographical Distribution
Meliaceæ	Mahogany Cuba, Spanish, Honduras.	Hardwood.	Hardwood, Broad leaf.	British Honduras, West Indies, Nicaragua.
Taxineæ	Yew.	Hardwood.	Softwood, Needle leaf.	Europe generally, Northern and Western Asia, and North Africa, California, and Japan.
Cupuliferæ	Beech.	Hardwood.	Hardwood, Broad leaf.	Europe generally, America, Canada.
Populus	Poplar.	Softwood.	Softwood, Broad leaf.	Europe generally, North America, Northern Asia, Northern Africa.
Pinus	Yellow Pine.	Softwood.	Softwood, Needle leaf.	North America.
Magnoliaceæ	American Whitewood.	Softwood.	Hardwood, Broad leaf.	Eastern North America.
Juglandaceæ	Black Walnut.	Hardwood.	Hardwood, Broad leaf.	Eastern North America.
Cupuliferæ	Oak.	Hardwood.	Hardwood Broad leaf.	Europe and the world generally.

CHART II ILLUSTRATING EFFECT OF CLIMATIC CONDITIONS ON THE GROWTH OF TIMBER TREES.

Order	Range of Temperature between Isotherms	Common Name	Botanical Term	Geographical Location. (Range N to S.)	Approx. Altitude above Sea-level.	Zone.
Coniferæ.	40° 30°	Northern Pine.	Pinus Sylvestris.	Northern Norway. Southern Spain. Etna.	3000 ft. 5600 ft. 7000 ft.	North Temperate.
Cupuliferæ	40° 20°	Beech.	Fagus Sylvatica.	64° N., Northern Europe. Balkans, 42° N. America.	Plains. 2000 ft. —	North Temperate.
Meliaceæ.	10°	Mahogany.	Swietenia Mahagoni.	Central America. Antilles. West Indies.	— — 1500 ft.	Sub-Tropical.
Salicaneæ.	40° 30°	Poplar.	Populus Nigra.	Central to Southern Europe. In Scotland.	— 1500 ft.	North Temperate.

Reference to the above chart will show graphically the general distribution of some timbers, and illustrate the fact that most timbers are largely affected by particular climatic conditions. The quality of the soil is another important factor, the rich soils and humid atmosphere of tropical countries producing very hard, slow-growing, and well-figured and marked woods, whilst the temperate climates are favourable to the growth of moderately rapid-growing timber trees, which are, however, not so richly marked—with the exception of the oak—nor so hard in texture as the former. The situation of timber trees is another important factor affecting the quality of the wood, swampy land generally producing softer material, whilst rich soils, and especially those of tropical and sub-tropical countries, produce hard, close grained and richly grained woods. This general principle is especially applicable to trees belonging to the same order, as, for instance, Honduras mahogany, which ranges from very soft to moderately hard material. The tall, slender, and straight growth of trees in closely wooded land is a familiar feature, favouring an upward growth, and acting against a proper development of the branches. Those grown in open situations display the full characteristics of the tree to best advantage, as seen in our oaks, ashes, and elms. The quality of timber and its value from a commercial standpoint is also directly affected by its situation. If exposed to high winds an erratic growth is characteristic, and the wood exhibits considerably twisted grain, affecting its strength when submitted to tensile strain or compression. For this reason also branch-wood is not favourably regarded from a woodworker's standpoint. Australian timbers afford an interesting study relative to the effect of situation upon quality and growth. The sub-tropical jungle forests with heavy undergrowth and humid atmosphere favour the growth of numerous grasses and palms in addition to trees of exceptional hardness, richness of colouring, and beauty of grain, including silky oak and Australian tulip-wood; whilst the ironstone ridge belts in Western Australia favour the growth of a remarkably strong, though coarse timber, i.e. jarrah. The more temperate climate of New Zealand conduces to the growth of moderately hard timber, such as New Zealand or kauri pine.

Identification of Hard and Soft Woods: (1) By Transverse Section.—*Coniferous timbers*, such as the pines, exhibit clearly defined annual rings, the autumn growth being darker in colour than the inner ring or spring growth. There are no visible pores on a transverse section of the wood, but pith rays can be discerned under a good glass, very fine and numerous. Hard woods have distinct pores visible to the naked eye. When examined on transverse section, viewed under a microscope, these pores show definite groupings and geometrical arrangements in various timbers, the spring group showing best. Oak and beech afford interesting studies of this feature and of the pith and medullary rays which show as lines radiating from the medulla or pith. This is a general characteristic of many hard woods, and when cut, they constitute the silver grain, or figure, so valued in oak, and apparent in beech, although less conspicuous. Generally, botanical soft woods have no pronounced figure or markings, but there are excep-

tions, such as the yew, especially the burrs of this tree. For further study of this absorbing subject, the reader is recommended to various standard works on timber and trees given in the Bibliography at the end of the book.

(2) **By Leaves.**—Soft woods, such as the pines, firs, spruces, larches, and cedars, have needle-pointed leaves growing in small bunches or groups. Botanically also all coniferous trees are classed as soft woods, the cones being the medium of reproduction.

The leaf of the elm—a hardwood tree—has the edge serrated, and the leaves are arranged five upon a stem. The ash has a more pointed leaf, growing thirteen upon a stem, whilst the lime, alder, sycamore, beech, oak, cherry, etc., have each distinctive leaves, varying in shape and in their growth from a stem or twig. Some are spaced exactly opposite each other on the stem with a terminal leaflet as in the ash, whilst the birch, for example, exhibits an alternate spacing of the leaves on the stem at equal distances one from the other.

The study of flowers and seeds is also a fascinating pursuit. Flowers, male and female, fruit and seeds, ranging from the complicated reproductive process of coniferous trees to the simpler process of germination from seeds contained in an edible fruit, such as the apple, cherry, almond, etc., and the seeds contained in husks and shells, such as the horse-chestnut, acorn, and walnut, are from the instructor's standpoint at least, of especial interest for object lessons, introduced at intervals alternating with object lessons on familiar objects, tools, and processes. A few are suggested at the end of this chapter.

As is shown in the preceding chart, differences of latitude are compensated for by differences of altitude, countries near the equator frequently growing species of trees and other botanical growths at certain altitudes characteristic of northern latitudes. A typical example is the northern pine, which flourishes in Norway, Sweden, and Northern Europe generally, and also on the Sierra Nevada, Spain, the mean temperature for the year being almost identical in both cases. It does not, of course, necessarily follow that exactly similar growths will be found in places far apart with a similar mean yearly temperature, but the number of examples is at least striking.

With regard to differences of location, Mr. Dryer says: "The distance to which any species of plant may extend towards the poles, up a mountain side, or into any relatively cold region, depends upon the length and average temperature of the growing season. The distance to which any species of plant may extend towards the equator, or into any relatively hot region, depends upon the average temperature of a period about six weeks at the hottest time of the year."

Trees adapt themselves to conditions partly by variations of leaf surfaces; thus "deciduous" or leaf-shedding trees, including the beech, oak, plane, and sycamore, have broad horizontal leaves with a thin epidermis or skin which permits the maximum working power, viz. sustaining and nourishing the tree—whilst the growing season lasts, by exposure to the air.

Pines, on the other hand, with their spiky, needle-pointed leaves are

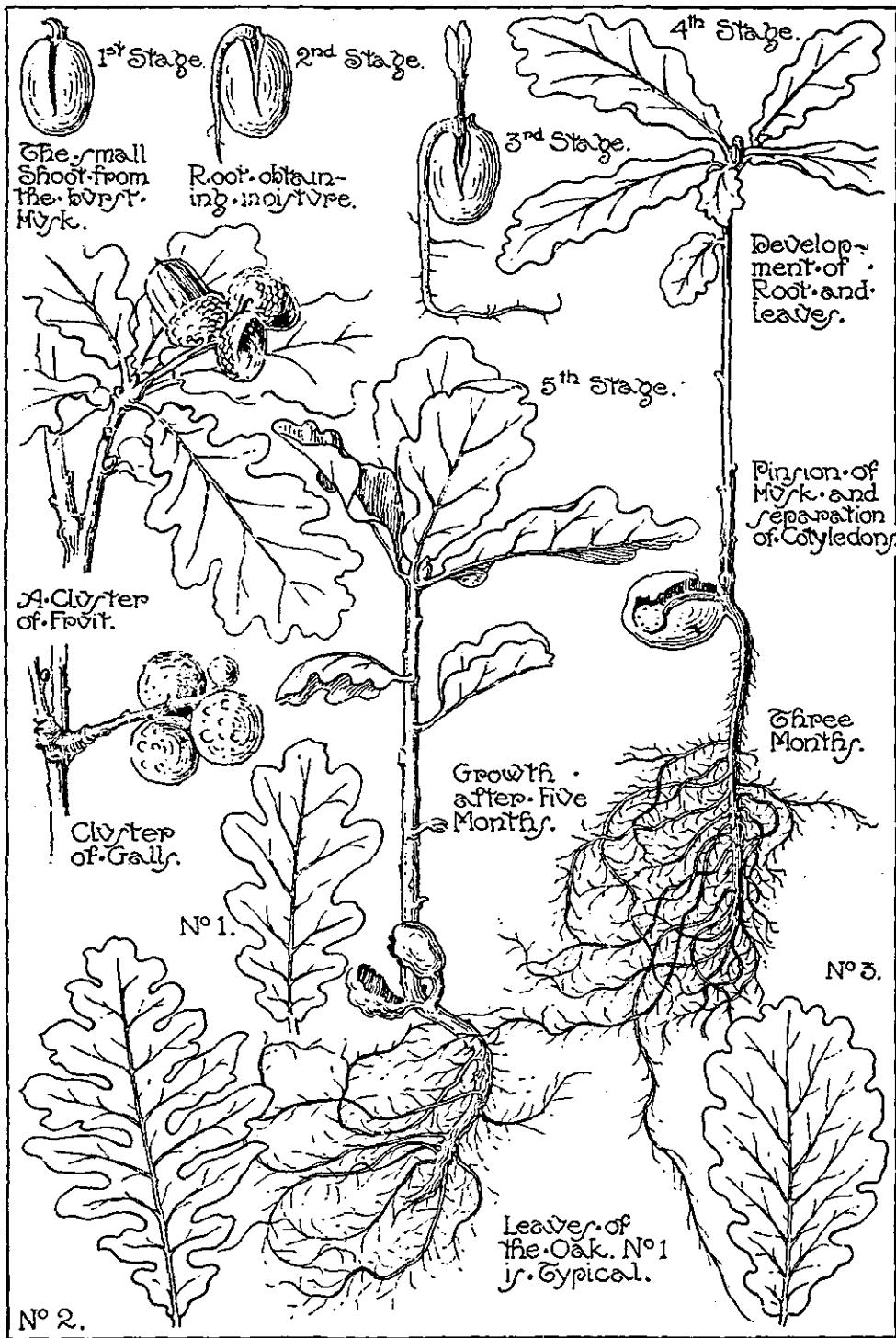

FIG. 1.

peculiarly adapted to resist drought, by virtue of the small aggregate leaf surface exposed. In tropical countries atmospheric evaporation is a considerable factor; the majority of the growths are evergreen, and new leaves appear before the old ones are shed in order to sustain the supply of nourishment to the tree.

The Growth of an Oak-tree.—An object lesson on the growth of an oak-tree could be given with the aid of large charcoal diagrams made preferably from the actual tree, leaves, etc., or from the drawings in Figs. 1 and 2 of this chapter. It will be readily seen that any number of familiar trees could be dealt with in this way, the oak, ash, plane, apple, and walnut-trees readily lending themselves to effective demonstration. For the purpose of object lessons, too much scientific data is not advisable, the chief aim is to arouse interest in botanical growths by indicating the main features of timber growth. The following data are suggested for a specimen object lesson, lasting some twenty or thirty minutes, the illustrations being prepared, as previously suggested, with charcoal on large sheets of white paper. To preserve these drawings for future use, they should be sprayed with a fixative and mounted upon millboards.

On Fig. 1 are shown various drawings illustrating some of the main characteristics of growth in oak-trees. An acorn is shown just after bursting with the small shoot coming towards the light, this of course occurring in the spring of the year. The next diagram shows the second stage with the shoot turned downwards in search of moisture and nourishment. In the third diagram the leaf shoot is illustrated, and coincident with this, the root has increased in size and also in the number of small or secondary roots, which act as feeders to the main root. The fourth stage, drawn from an actual specimen, shows main roots secondary and hair roots, each one of the latter feeding the secondary roots and by means of them the parent root. As the tree increases in age and size, the roots spread over a much larger surface in order to satisfy the increasing demands of the small tree. The woody substance is formed by the ascending juices in the spring growth, some of these being deposited upon the stem. The rising sap, or natural juices, finally reaches the branches and twigs, causing the buds to appear and finally burst into leaf, and in some cases flower. During the summer season the roots are constantly extending themselves in search of natural salts and elements, which are in turn conveyed through the various parts of the tree to the flowers and later to the fruit. The oak, it should be noted, has no bright definite flower—unlike most other seed-bearing trees. During the autumn after the fruit or seeds are mature a return of the sap and natural juices in a different form takes place; those have changed in some degree by atmospheric conditions and return in a less liquid form, forming a thick autumn layer of wood in their downward course. This can be clearly seen in most woods, darker in colour than the spring layer of the annual ring. Characteristic of the oak is "its system of extension," otherwise known as "ramification". New growths appear at right angles to existing twigs, hence the oak branches, practically at right angles to the parent growth, as shown in various diagrams in Fig. 2. The oak is

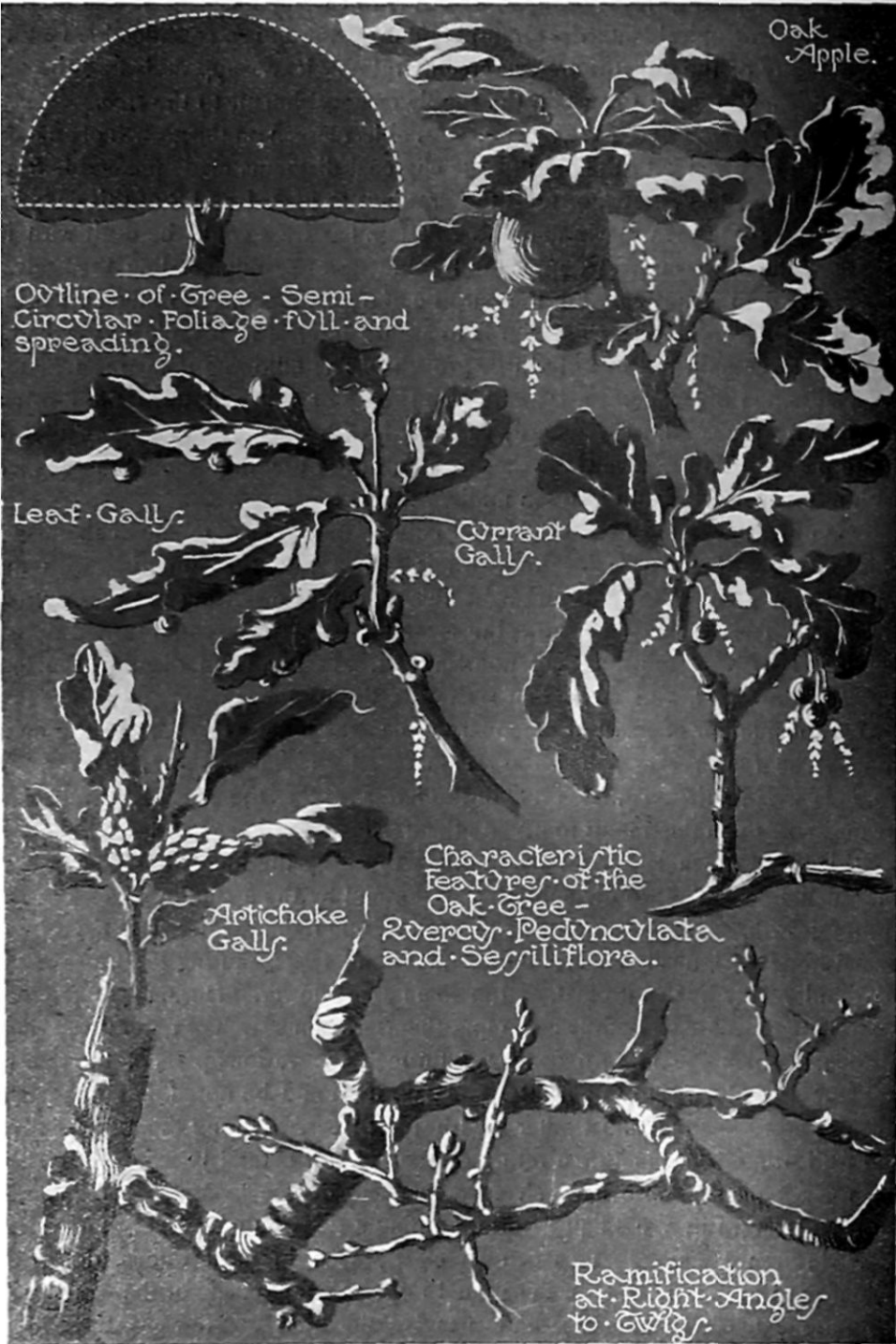

FIG. 2.—Characteristic detail of growth of the oak-tree.

peculiarly liable to foreign growths, such as "cluster galls," shown in Fig. 2, oak apples, and currant galls, these being illustrated in Fig. 2.

Suggestions for object lessons on trees, etc. :—

1. General characteristics of timber trees :—
Soft woods and hard woods. Introducing needle-pointed and broad leaves.
2. The growth of a tree from a seed —
(a) Pine.
(b) Oak (see also Figs. 1 and 2).
3. Identification of trees from their barks.
4. " " " leaves.
5. " " " fruits.
6. " " " general outlines $\left\{ \begin{array}{l} (a) \text{ in summer.} \\ (b) \text{ in winter} \end{array} \right.$
7. Commercial value and uses of some English trees —
(a) The oak.
(b) The beech.
(c) The apple.
(d) The cherry.
8. The seasoning of timber :—
(a) Water seasoning.
(b) Natural seasoning.
(c) Second seasoning.
(d) Desiccation or kiln drying.
9. The conversion of timber :—
(a) Felling
(b) Lumbering.
(c) Shipment of timber.
(d) Cutting mill, machine and hand.
10. By-products of timber :—
(a) Charcoal.
(b) Tanning bark.
(c) Natural oils—turpentine, resins, etc. —
(d) Paper pulp from timber.
(e) Gum, rubber, etc., extraction of.
11. The formation of wood illustrated by the growth of :—
(a) The plant.
(b) The sapling.
(c) The tree.
12. Geographical distribution of timber :—
(a) Australia.
(b) Russia.
(c) United States.
(d) England.

Shown by graph or chart illustrating ratio.

13. Trees as decorative media :—
Box, holly, etc.
14. Afforestation and re-afforestation. Need for, and statistics of colonies and foreign countries.
15. Effect of climatic conditions upon the growth of timber.
Timbers peculiar to certain zones.
" " " countries.
16. Leaves and their function.
The pine needle leaf.
Deciduous timber.
Tropical growths.

Mother of Pearl, Japanese, and Blue Pearl are materials obtained from the shell of the pearl oyster, the former kind being so named because of its relation to the "pearl" which forms inside the shell and is almost detached from it. Pearl shell is composed of numerous layers of a crystalline carbonate of lime with but little animal matter. It is exceedingly hard and of a peculiarly lustrous colour. The best kinds of pearl oysters are found in the Indian Ocean, Red Sea, Gulf of California, etc., and Ceylon, where pearl fishing has been carried on for centuries. According to authorities on this subject, the pearl is produced by a small piece of grit or irritant entering the shell, which in time becomes covered with a secretion, forming a beautifully coloured stone-like gem of an oval shape. It was not until recent years that pearl shells were dealt in to any extent commercially; they were usually discarded after being opened, and the shores of some parts were strewn with these many feet deep. Now, however, they are an important branch of pearl fishing owing to the demand for pearl buttons, fancy articles, and inlaying material. For commercial purposes thick, good-coloured shells are much sought after. Important pearl fisheries lie to the North of Australia, the shells in that part being particularly suitable for commercial needs.

Ivory, the product of elephant tusks, is a beautiful material of peculiar milky colour used extensively for decorative purposes and especially for knife handles. An inferior substitute is walrus tusk, much used in place of the better and more costly material. Ivory in decorative woodwork is used chiefly in veneers, these being sawn by machinery. It can be rendered plastic by immersion in diluted acids which makes it transparent. The original colour can, however, be restored by a similar process. Old Italian craftwork shows fine examples of ivory inlay; it is most successful when used in small pieces with some woods as mosaic patterns. It can be fairly easily worked by means of saws, files, and glasspaper.

Tortoise-shell is a beautifully marked and coloured material from the shell of the tortoise. It is extensively used in fancy and ornamental turnery and cabinet work. Boule work of the Louis XV period is especially notable for the

ornamental use of tortoise-shell. Added decorative effect is produced by painting the underside a vermilion colour, this showing through the lighter parts. The underside may also be gilded, by which means added brilliance of effect is obtained. Tortoise-shell can be advantageously employed in large masses, which is not the case with ivory and pearl. It should not be joined with square butt joints when connecting thin pieces, but spliced together, which effects a neater junction.

METALS.¹

The word "metal" is derived from the Greek word "metallon" which means a pit or a mine, whence we get "metal". Technically it is a term applied to a number of elementary substances which possess, generally, certain well-defined characteristics, such as lustre, malleability, ductility, and fusibility.

The broad definition of a "metal" is as follows: A solid opaque body, possessing a peculiar lustre, fusibility, and conductivity.

Those which are most frequently employed in commerce and the arts are as follows:—

<i>Common Name.</i>	<i>Latin Name.</i>	<i>Symbol.</i>
Aluminium.		Al
Antimony.	Stibium.	Sb.
Bismuth.		Bi.
Cadmium.		Cd.
Chromium.		Cr.
Cobalt.		Co.
Copper.	Cuprum.	Cu.
Gold.	Aurum.	Au.
Iridium.		Ir.
Iron.	Ferrum.	Fe.
Lead.	Plumbum.	Pb.
Magnesium.		Mg.
Manganese		Mn.
Mercury.	Hydrargyrum	Hg.
Nickel.		Ni.
Osmium.		Os.
Palladium.		Pd.
Platinum.		Pt.
Silver.	Argentum.	Ag.
Tantalum.		Ta.
Tin.	Stannum	Sn.
Tungsten.	Wolframium	W.
Vanadium.		V.
Zinc.		Zn.

¹ In the workshop the name "metal" is applied to both the pure metals and the alloys, and it is so used in these pages.

ALLOYS.

When two or more metals are caused permanently to unite the resulting mixture is called an *Alloy*. The term is also used for similar mixtures of metals and non-metals, such as iron and carbon = steel. The melting-point of an alloy is usually below that of the most easily fusible constituent.

Amalgam.—When mercury is one of the metals the mixture is generally known as an amalgam.

It is not necessary in this work to give the names of all the known alloys, as many of them are made for a special purpose or industry, and as these purposes are as varied as the number of alloys it is possible to make, and new combinations of metals are continually being invented, only the more common ones will be dealt with.

The following table gives the alloy and its composition:—

Alloys ¹ : Their Names and Composition.	Copper.	Antimony.	Aluminium.	Tin.	Zinc.	Lead.	Silver.	Manganese.	Nickel.	Phosphorus.	Iron.	Gold.	Carbon.	Tungsten.	Magnesium.	Chromium.
Aluminium bronze	95		5													
Brass	65				35											
Britannia metal	2	8		90												
Bronze	90			10												
Delta metal	56				41·61	·72		·81		·013	·87					
Duralumin	3½		95					½								
	to							to								
	5½							10								
Dutch metal	80				20											
German silver	46				20				34							
Gilding metal	83				17											
Gold (standard)	8·33											91·66				
„ solder (best)	15						22½					62½				
Gunmetal	9			—												
Manganese bronze	60				15			25								
„ steel								14			86					
Muntz metal	62			1	37											
Nickel steel								·85	25		74		·27			
Ormolu	58			17	25											
Pewter				82		18										
Phosphor bronze	90			9½												
Silver (standard)	7·5						92·5									
„ solder (best)	22				14		64									
Spelter (for brazing)	50				50											
Stainless steel											86		·1			12
											to		to			to
											88		2			14
											98½		1½			
											99·85		·15			
Steel (for tools)																
„ (mild, for forging)																
Tinman's solder				2		1										
Tungsten steel								2½								
Type metal		3		12	16	64					91½		1½	4½		
White metal (for bearings)	8	8		84												

THE CHARACTERISTICS OF METALS AND ALLOYS.

It is their weight, lustre, malleability, conductivity, tenacity, ductility, fusibility, power of solidifying, hardness, and softness that make the metals so extremely useful. A short account of their properties is given below.

Weight.—It is not necessary to explain what is meant by the weight of a

¹ All alloys vary within certain limits, but the above may be taken as typical.

PROPERTIES OF METALS.
RELATIVE POSITIONS IN DESCENDING ORDER.

Density or Specific Gravity.	Fusibility.	Tenacity.	Conductivity for Electricity.	Conductivity for Heat.	Malleability	Albedo or Lustre.	Ductility	Hardness	Shrinkage
Osmium 22.4	Tungsten	Platinum	Silver	Silver	Gold	Silver	Iron	Iridium	See pages 151, 152
Iridium 22.1	Tantalum	Nickel steel	Copper	Copper	Silver	Tin	Copper	Cast iron	
Platinum 21.2	Osmium	Phosphor bronze	Gold	Aluminium	Aluminium	Nickel	Platinum	Osmium	
Gold 19.4	Iridium	Delta metal	Brass	Gold	Platinum	Steel	Silver	Wrought iron	
Tungsten 18.5	Chromium	Aluminium bronze	Aluminium	Brass	Copper	Antimony	Gold	Zinc	
Tantalum 16.5	Manganese	Manganese "	Cast steel	Zinc	Tin	Bismuth	Palladium	Phosphor bronze	
Mercury 13.6	Platinum	Nickel	Zinc	Tin	Lead'	Iron	Nickel	Copper	
Palladium 11.3	Cobalt	Cast steel	Tin, pure	Wrought iron	Zinc	Zinc	Zinc	Silver	
Lead 11.3	Iron	Mild steel	Palladium	Lead	Iron	Lead	Tin	Gunmetal	
Silver 10.5	Palladium	Copper	Platinum	Platinum	Nickel	Brass	Aluminium	Brass	
Bismuth 9.8	Nickel	Muntz metal	Iron	Antimony	Antimony	Copper	Lead	Gold	
Nickel 8.9	Cast steel	Iron forged	Nickel	Bismuth				Lead	
Copper 8.8	Cast iron	Brass	Lead	Mercury				Tin	
Cadmium 8.6	Copper	Gunmetal	Aluminium bronze						
Cobalt 8.6	Gold	Gold	German silver						
Bronze 8.6	Brass	Silver	Antimony						
Brass 8.5	Silver	Aluminium forged	Manganese steel						
German silver 8.5	Magnesium	Copper cast	Mercury						
Manganese 8.1	Aluminium	Iron "	Bismuth						
Wrought iron 7.8	Antimony	Aluminium cast							
Cast steel 7.6	Zinc	Zinc cast							
Cast iron 7.4	Lead	Tin							
Tin 7.3	Cadmium	Lead							
Zinc 7.2	Bismuth	Bismuth							
Antimony 6.8	Tin	Antimony							
Chromium 6.7									
Aluminium 2.6									
Magnesium 1.75									

By courtesy of the "Metal Industry".

metal. But a useful figure in connexion with calculation of weights is the "Specific Gravity" or "Relative Density". This figure expresses the number of times any given volume of metal is heavier than an equal volume of water. For the exact conditions under which the comparison is made the reader is referred to a textbook of physics. Suffice it here to point out that when we say the relative density of iron or lead is 7.4 or 11.3 we mean iron is 7.4 and lead 11.3 times as heavy as water. An example is given of the use of this figure in calculating weight. It must be remembered that a cubic foot of water weighs 1000 oz. or 62½ lb. (nearly). An iron plate 6 × 4 ft. × 1 in. has in it $72 \times 48 \times 1$ cub. in., i.e. $\frac{72 \times 48 \times 1}{1728} = 2$ cub. ft. This would weigh 2000 oz. or 125 lb.

if it were water, and therefore since it is iron $125 \times 7.4 = 925$ lb.

If it had been lead the weight would have been 125×11.3 . The same plate of cast steel would have weighed 125×7.8 . See table on p. 149.

Lustre.—The power of reflecting the rays of light is possessed in a much higher degree by metals than by non-metallic substances. The metals and alloys which exhibit the greatest lustre for the longest time are those which are not quickly attacked by the oxygen and carbonic acid in the air and are sufficiently hard to receive a high polish. Gold and platinum have considerable lustre, because though not very hard they are not affected by the constituents of the atmosphere. Metals when highly polished are less easily tarnished because gases have then less tendency to condense on their surfaces.

Malleability is the property of being able to be beaten out by hammering, or the possessing of an internal mobility by which the shape may be altered by pressure without cracking or breaking. The malleability of a metal is affected by the temperature of the metal at the time of the hammering or working, also by the structure of the metal itself, or what is termed its "molecular condition". For example, a piece of gold or copper which has been hammered a great deal becomes hard or brittle, and if the hammering is continued it will eventually crack. But it will, however, regain its malleability on being heated to a certain degree; this heating is called annealing. The method of cooling is also important, as copper may be cooled from a red heat by being plunged into water, but steel by this method would become very hard, and to be softened steel must be heated to a red heat and then cooled very gradually. The crystalline or non-crystalline structure of the metal is also a factor to be considered. When crystalline a metal is not very malleable, but all malleable metals become hardened by hammering or working, so that they have to be annealed during the process of manufacture. A fibrous metal is generally very malleable and tenacious.

Some metals undergo changes of structure in process of time. Brass wire becomes brittle when kept in a state of tension, or in a damp storeroom; wrought-iron chains used in carrying loads have occasionally to be annealed to restore their malleability, as by the constant strain they become crystalline. Gold when hammered out into the form known as gold leaf is $\frac{1}{280000}$ part of an

inch in thickness, and is semi-transparent, showing a green colour by transmitted light.

Conductivity is a power that metals possess of conducting heat and electricity. Metals that are the best conductors of heat are also the best conductors of electricity, and in both cases the conductivity is seriously impaired by the presence of even small quantities of other metals or impurities.

Tenacity is the property which enables a metal to withstand rupture by pulling. The influence of impurities in metals upon their tenacity is very variable. The enormous increase in tenacity produced by combining a small proportion of carbon with iron is well known, and may be contrasted with the relatively greater reduction in strength caused by a trace of bismuth in gold.

Ductility is the property of being able to be drawn out into fine wire or tubing. The ductility of metals is not in the exact ratio of their malleability; thus iron is very ductile and can be drawn into very fine wire, but it cannot, except in a very pure state, be rolled into such thin sheets as either copper or tin.

Fusibility is the property of becoming liquid when heated. Although the property of becoming liquid at high temperatures is not confined to the metals, it is one of those qualities which contribute very largely to their utility, for it enables the founder to produce a large number of objects from a given pattern, with only a small expenditure of time and labour. It also offers to the worker in metals a ready means of joining together in a durable manner the separate pieces of his work.

Solidification.—All metals solidify after fusion, and the temperature at which they change from the liquid to the solid state is known as the “freezing-point”. Alloys in solidifying very often alter, as the heavier constituent separates, and consequently a metal is obtained which is not uniform in structure. It may be taken as a general rule that the melting-point of an alloy is below that of its most fusible constituent.

Contraction.—Nearly all metals contract in cooling. So when making patterns for articles that have to be cast, allowance must be made for the contraction or shrinkage; this depends to a large extent on their form and the distribution of the metal. Sand cores have a tendency to retard shrinkage; cylindrical or box-shaped articles shrink more in their length than in their diameter. The approximate contraction of various metals is as follows:—

Aluminium	.	.	.	$\frac{17}{84}$	in. per foot
Bismuth	.	.	.	$\frac{6}{32}$	” ”
Brass, “heavy”	.	.	.	$\frac{5}{32}$	” ”
Brass, “light”	.	.	.	$\frac{1}{16}$	” ”
Bronze	.	.	.	$\frac{7}{32}$	” ”
Copper	.	.	.	$\frac{1}{16}$	” ”

Iron, cast	.	.	.	$\frac{3}{32}$	in. per foot
¹ Iron, wrought	.	.	.	$\frac{1}{32}$	" "
Lead	.	.	.	$\frac{5}{16}$	" "
Steel "castings"	.	.	.	$\frac{3}{16}$	" "
Tin	.	.	.	$\frac{1}{4}$	" "
Zinc	.	.	.	$\frac{5}{16}$	" "

Hardness.—This is a relative term, and is the resistance offered by the molecules of a metal to their separation by the penetrating action of another body, and is affected considerably by the presence of impurities. The presence of another metal often tends to increase both the brittleness and hardness.

Softness.—This is also a relative term, but in many instances is a test of purity.

Aluminium.—A bluish-white but somewhat soft metal, very malleable, and takes a good polish. Can be cleaned by immersion in caustic potash and soda; unaffected by exposure to the atmosphere. Annealed only at a low temperature. Difficult to solder owing to insolubility of oxide, but can be welded by means of the oxy-acetylene blow pipe. There are many patent solders for soldering this metal.

Aluminium Bronze.—An alloy the colour of gold, is fairly malleable, and can be forged at a red heat; takes a beautiful polish if burnished. Cleaned by immersion in dipping acid; goes a rich brown when exposed to the atmosphere. Annealed by bringing to a bright red heat, cooling in air to a red, then plunging into water. Can be soft soldered after joint has been coppered by dipping in copper sulphate and touched with an iron rod, silver soldered, or brazed.

Antimony.—A bluish-white metal, very brittle; expands on solidifying. Used largely for type metal and alloying with other metals to give fine and sharp castings. A slight tap with a hammer will break an ingot of antimony, and the broken surface exhibits large shining facets.

Bismuth.—A pinkish-white metal, brittle, very diamagnetic; expands on solidifying. Used for alloying with other metals to lower the melting-point. Pewterer's solder, which is very fusible, is composed of lead, tin, and bismuth.

Brass.—A yellow metal, very malleable; takes a fine polish. Cleaned by immersion in dipping acid; turns black and green on exposure to atmosphere. Can be annealed by bringing slowly to a red heat and leaving to cool slowly in air; will break if moved when at a red heat. Can be soft soldered, silver soldered, brazed, and welded by the oxy-acetylene blowpipe.

Britannia Metal.—A nearly white metal, very malleable; takes a fine polish, and can be cleaned by immersion in strong soda or potash; darkens a very little on exposure to the atmosphere. Annealed by bringing to a temperature just above boiling water. Can only be soft soldered.

¹ Although wrought iron is not cast, it contracts to about this extent after having been heated to a bright red. Some metals expand on cooling, and some nickel steel alloys neither contract nor expand by heating.

Bronze.—An alloy of a rich brown colour, malleable ; takes a high polish. Can be cleaned by immersion in dipping acid ; goes a dark brown and eventually green on exposure to atmosphere. Can be annealed by bringing carefully to a red heat and cooling slowly in air. Can be soft soldered, silver soldered, and brazed

Cadmium.—A white metal with bluish tinge, soft. Not used largely for manufacturing purposes. Forms a component of one of the most fusible alloys, i.e. Wood's alloys ; it is also alloyed with silver for electroplating.

Chromium.—A very hard white metal very difficult to fuse. Used for electroplating, and alloying with steel. Does not tarnish readily in the atmosphere.

Cobalt.—A bluish-white metal, malleable, ductile, and tenacious ; takes a high polish ; unaffected by the atmosphere. Used in electroplating, and for alloying with steel.

Copper.—A red metal, very malleable ; takes a high polish, and can be cleaned by immersion in dipping acid ; turns black and eventually green on exposure to the atmosphere. Can be annealed by bringing to a red heat and quenching in water, and can be soft soldered, silver soldered, brazed, and welded by the oxy-acetylene blowpipe.

Delta Metal.—A yellow malleable alloy ; takes a fine polish. Can be cleaned by immersion in dipping acid ; does not tarnish in moist air. Can be annealed by bringing to a red heat and cooling in air. Can be soft soldered, silver soldered, and brazed ; can be forged at a red heat and is non-magnetic. Used largely in shipbuilding and marine engineering. Can be extruded.

Dutch Metal.—A bright yellow very malleable alloy ; takes a high polish, and can be cleaned by immersion in dipping acid ; turns black by exposure to the atmosphere. Can be annealed by bringing to a red heat and cooling in air. Can be soft soldered, silver soldered, and brazed. Used largely for imitation gilding, either in leaf or powder. Can be easily distinguished from real gold, as it is readily soluble in nitric acid.

German Silver.—A white or yellowish-white malleable alloy ; takes a high polish. Can be cleaned by immersion in nitric acid and water and then in dipping acid, but tarnishes on exposure to the atmosphere. Can be annealed by bringing to a red heat and cooling in air. Can be soft soldered, silver soldered, and brazed. Has a high electrical resistance. Silveroid a similar metal.

Gilding Metal.—A light brown alloy. Used largely for articles that are afterwards gilt. Similar in properties to Dutch metal but not quite so malleable.

Gold.—A bright yellow metal extremely malleable ; takes a bright polish, and is cleaned by immersion in a dip consisting of 2 parts by weight of hydrochloric acid and 1 part of nitric acid ; this is called "aqua regia". Gold is not affected by the atmosphere. Can be annealed by bringing to a red heat and cooling in the air ; must not be moved when at a red heat as it is liable to break. Can be soft soldered, and silver or gold soldered

Gunmetal.—A light brown alloy. Generally used in the form of castings ;

takes a high polish. Can be cleaned by immersion in dipping acid; turns black by exposure to air. Is annealed by bringing to a red heat and cooling in air. May be soft soldered, silver soldered, and brazed. Used largely for engineering purposes. Gilding metal matches this in colour, and can be bought in sheets, rods, etc.

Iridium.—A very hard, white, brittle metal, is very rare and difficult to fuse. Used mostly for scientific apparatus, and for objects to withstand very high temperatures. Cannot be crushed.

Iron, Wrought.—A greyish-white metal, malleable at all temperatures; takes a good polish. The scale can be removed by immersion in sulphuric acid 1 part, water 15 parts; rusts on exposure to the atmosphere and is eventually destroyed. Is annealed by bringing to a red heat and cooling in water. May be soft soldered, silver soldered, brazed, and welded either by the blacksmith's method or by the oxy-acetylene method; the former is the stronger.

Iron, Cast.—A grey metal very brittle and hard. Used only in the form of castings, is really the crude iron used largely for machinery. When cast iron is deprived of some of its carbon, thereby leaving it much softer and less brittle, it is called "malleable cast iron," and in this form it is often used instead of forgings, as it is cheaper.

Lead.—A grey malleable metal, very soft, marks paper; can only be brought to a dull polish. Should be cleaned by scraping or caustic soda; darkens slightly on exposure to the atmosphere, but after this it is permanent and no further change takes place. Is annealed by raising to the temperature of boiling water. May be soft soldered; is often joined by what is known as autogenous soldering or burning, especially for vessels used in chemical work. Wire and pipes can be made of lead by extrusion, squirting, or pressure.

Magnesium.—A silvery white metal. Burns with a very bright flame when heated. Used largely in pyrotechny and photography in the form of powder or ribbon; in the latter form it will light by the aid of a match. It is readily soluble in dilute hydrochloric acid and in dilute sulphuric acid.

Manganese.—A grey metal with a reddish tinge, very brittle. Used mostly for alloying with iron, copper, and nickel in the manufacture of very hard steel and mild steel; has the effect of toughening and generally improves the quality. Manganese is not usually used pure but in the form known as ferro-manganese.

Manganese Bronze.—A light brown alloy which takes a high polish and is malleable; sometimes called white bronze. Is cleaned by immersion in dipping acid; is not corroded by the action of sea-water. May be soft soldered, silver soldered, and brazed. Used largely for screw propellers and marine engineering owing to its great transverse strength, toughness, hardness, and the facility with which it can be cast sound. It is equal in strength to mild steel, and can be worked either hot or cold, but should be forged at a cherry-red heat.

Manganese Steel.—A greyish white metal; takes a good polish. Very strong and tough; toughness is improved by quenching in water from a white

heat. Cannot be hardened like tool steel or welded; all shaping should be done while hot. Makes sound castings but contracts considerably.

Mercury or Quicksilver.—A silvery white metal, liquid at ordinary temperatures. Used in making amalgams and in scientific instruments.

Mild Steel.—A greyish-white metal, very malleable hot or cold, easily welded and forged into shape while hot; takes a good polish. Cannot be hardened or tempered like tool steel. Stronger than wrought iron, which it is gradually superseding for constructional purposes. Can be soft soldered, silver soldered, brazed, and welded either by the blacksmith's method or by the oxy-acetylene method; the former is the stronger.

Muntz Metal.—So called after the patentee, Sir G. F. Muntz of Birmingham. Really it is a malleable brass; takes a high polish. May be cleaned by immersion in dipping acid, and can be annealed and soldered like brass. It is sometimes called yellow metal sheathing, as it was used largely for covering the bottoms of wooden ships; it is now used for condenser tubes and marine work, as it is not affected by sea-water to any great extent. Can be forged at a red heat.

Nickel Steel.—A special steel of a white colour; has a fibrous structure; takes a high polish. Very strong, tough, has great power of resisting shocks, and has a higher elastic limit than carbon steel, and is not corroded so quickly by sea water. Can be welded if the proportion of nickel is not more than three per cent. Used largely for armour plates and crank shafts.

Nickel.—A brilliant white metal, malleable, ductile, tenacious, and can be welded; takes a high polish. Does not readily discolour on exposure to the atmosphere. Is cleaned by immersion in dilute nitric acid. Used largely as an alloy to produce a number of varieties of white metals which go under different names, but are mostly similar to German silver. It is also used largely in electroplating.

Ormolu.—The same as brass in all respects.

Osmium.—A bluish-white metal, very rare. Infusible except in the electric furnace. Used for filaments of electric lamps and alloyed with iridium for the points of gold pens.

Pewter.—A grey metal, very soft and malleable; takes a dull polish. Cleaned by polishing with some abrasive substance; turns a trifle darker but otherwise unaffected by the atmosphere. Can be soldered with a special solder which has a low fusing-point.

Phosphor Bronze.—A light brown metal; takes a high polish. Can be cleaned by immersion in dipping acid. Can be soft soldered, silver soldered, and brazed. Used largely for engineering purposes, mostly cast work; does not become crystalline under repeated shocks or jars; resists corrosion by sea-water, and it is difficult to obtain a spark from it, consequently it is used in the factories where explosives are made.

Palladium.—A white metal, very rare, untarnishable. Used in the manufacture of scientific instruments.

Platinum.—A white metal, very malleable; takes a high polish, unaffected by the atmosphere; coefficient of expansion the same as that of glass. It can only be dissolved in aqua regia; unaffected by single acids. It is used for the filaments in incandescent lamps and high temperature work in chemical processes. Can be welded at a red heat.

Silver.—The most perfect white of any metal; takes a high polish, very malleable. Cleaned by immersion in dilute sulphuric acid or in a solution of potassium cyanide and water; turns blue-black on exposure to the atmosphere, but is not corroded. Can be annealed by bringing to a dull red heat and cooling in air. May be soft soldered and silver soldered.

Silver Solder.—A white metal with a yellowish tinge. Used only for joining metals. Different grades have different melting-points, and vary in colour.

Solder (tinman's).—A white alloy. Used only for joining metals. By altering the proportions or adding bismuth or cadmium it can be made fusible at various temperatures. Used largely by tinsmiths and fused with the aid of a soldering iron, blow-lamp, bunsen burner, etc. Made in many qualities.

Spelter (used in brazing).—Zinc is often called spelter. A yellow or white metal, usually in the form of grains of various sizes. Used for joining metals, fused with the aid of a blowpipe.

Steels.—See pp. 215-219.

Tantalum.—A white metal, very rare, malleable. Used mostly for the filaments of electric lamps.

Tin.—A white metal, with a yellowish tinge, very malleable; takes a good polish. Can be cleaned by immersion in hydrochloric acid and water. With care it may be soft soldered. It is little affected by air at ordinary temperatures, and is therefore used largely for coating sheet iron to protect it from rust, as in culinary vessels.

Tin Plate.—This is small thin sheets of wrought iron or mild steel, which have been annealed, pickled, scoured bright, and dipped in molten tin on the top of which there is a quantity of melted tallow so that the sheets of metal pass through the melted tallow before entering the molten tin. The tallow is a flux and causes the tin to adhere to the metal sheets. The metal is then passed through rollers which squeeze off the excess tin, and they are then dried in clean sawdust.

Block tin, as it is called, or doubles, are iron or steel sheets that have been dipped twice, so having a thicker coat of tin on them, then planished with a polished hammer on a polished anvil. They are usually from 20-25 I.S.W.G.

Terne plates, which are duller in appearance than tinned plates, are plates dipped in a mixture of lead and tin.

The commercial names of tinned plates are very confusing, and the sizes vary. They are named by the size of the sheet, the quality, and thickness. For example, Common No. 1 is marked I.C. and the size is 14 × 10 in., and there are 225 sheets in a box weighing 108 lb.; the thickness is No. 30 I.S.W.G. Another

DXXXX, called four cross doubles, is No. 22 I.S.W.G.; size of sheet is $17 \times 12\frac{1}{2}$ in., or 17×25 in.

Tool Steel.—A greyish white metal, malleable, very strong and tough; takes a high polish. Can be cleaned by immersion in a mixture of nitric acid and lamp black. Oxidizes on exposure to the atmosphere. Is annealed by heating slowly to a dull red and cooling in hot sand or lime very gradually. May be soft soldered, silver soldered, and brazed. With care can be welded. Sometimes called crucible steel, cast steel, carbon tool steel.

Tungsten.—A grey metal, very rare, very hard. Used for alloying with steel to produce what are known as self-hardening steels.

Tungsten Steel.—A very hard steel. Used for cutting tools in engineering shops. Can be forged at a red heat and is hardened by bringing cutting edges to a white melting heat and cooling in a cold blast of air. Cutting edges last much longer and do more work than carbon tool steels.

Type Metal.—A grey metal, fairly soft. Used only for casting type for printing; expands on solidifying.

Vanadium.—A greyish white metal, rare, very difficult to fuse. Used in the form of ferro-vanadium for alloying with steel.

Zinc.—Sometimes called spelter. A bluish metal, fairly malleable at certain temperatures; takes a fair polish. May be cleaned by immersion in equal parts of nitric and sulphuric acids. Is annealed by warming with a bunsen burner, and can be soft soldered. Used largely for alloying with other metals and for the protection of iron from rust as in galvanizing.

THE EXTRACTION OF METALS.

The extraction of metals from their ores is usually described as metallurgy, and metallurgical chemistry is a special branch of chemical science which is usually conducted on a large scale at high temperatures.

Ores are generally mixed with earthy matters and often contain two or more metals in various forms up to a certain stage; they are all treated in a similar manner, that is, the ores have to go through some preliminary processes such as crushing, washing, dressing, and roasting, before being smelted. Advantage is also taken of the properties which are inherent in each particular metal to assist in the extraction. The methods used are broadly classified under the following headings:—

Smelting.—By mixing the ore with a flux and sometimes with fuel in various kinds of furnaces, and raising it to a high temperature by means of a heated blast of air sufficient to reduce the ore to a liquid condition and then pouring it into moulds.

The following metals can be extracted from their ores in this manner: copper, chromium, cobalt, lead, nickel, iron, magnesium, manganese, silver, tantalum, tin, tungsten.

Liquation.—In this process a metal that liquefies at a low temperature is separated from a more infusible one by taking advantage of their different melting or fusing-points, and the following metals can be obtained in this way: antimony, bismuth, lead, silver.

Distillation.—By heating certain ores the solid metals are driven off in the form of vapour; this is then condensed to a liquid or solid state. The following metals can be distilled from their ores: mercury, cadmium, zinc.

Amalgamation.—This is accomplished by bringing the ores into contact with mercury, which has an affinity for some metals. The resulting amalgam is then heated, which drives off the mercury in the form of vapour, leaving the metal behind. The following metals can be extracted in this way: gold, silver.

Electrolytic Methods.—This is where the metals are produced by fusing the ores in an electric furnace; this is owing to the great heat required to bring the metal to a fluid condition. The following metals are extracted in this way: aluminium, magnesium, tantalum, tungsten, chromium.

Wet Methods.—The ores in this process are dissolved in various acids or salts and are then precipitated by the addition of another acid, salt, or gas. The following metals can be extracted by this method: nickel, cobalt, gold, palladium, platinum, silver.

Lead and Zinc Method.—By fusing the ore with lead or zinc, with which they combine, then heating the alloys so that the lead and zinc are either liquated or volatilized, leaving the metal behind in a spongy mass which is then smelted in a special furnace to refine it. It is then poured into a mould. The following are treated in this manner: iridium, osmium, platinum.

The Extraction of Iron from the Ore.—The iron ore mixed with limestone (a flux) and coke (a fuel) are conveyed to the top of a blast furnace, where they are tipped in through a cone shaped flap. A second cone is kept closed while this is going on, and then the top flap is closed and the bottom one opened, allowing the mixture to fall into the furnace. The double flap prevents the hot gases from escaping while loading. The ore is subjected to a temperature of about 1500 degrees Centigrade by means of a blast of hot air and gas from a blast stove. Molten iron runs to the bottom of the furnace and is drawn off as required. To create the blast the hot gases from the furnace are conveyed to the blast stove and also to gas engines, thereby driving the air compressors which supply the blast. The interior fire bricks of the blast stove are made white hot by the passage of hot gas through them, and when certain valves are reversed air is pumped through, and compressed air is made hot ready to enter the blast furnace. There are two stoves to each blast furnace, one working air and the other gas, and they are reversed each half hour. The slag in the blast furnace floats on the molten iron and is drawn off.

It takes about 24 hours burning to turn 7000 tons of raw material into 2000 tons of iron. There are two grades of cast iron, one known as grey iron, in which the molten metal has been allowed to cool slowly, and white iron, produced by rapid cooling.

CHAPTER XII

DRAWING, DESIGN, LETTERING, ETC.

APPLIED TO WOOD AND METAL WORK.

THIS chapter is intended to deal chiefly with the special application of drawing to the practice of wood and metal work, and as an aid to the effective teaching and demonstrating of the above subjects. It is presumed that a knowledge of elementary practical plane and solid geometry, drawing from the cast (light and shade), freehand and model drawing has been acquired. The special kinds of drawing necessary to pupils when dealing with the subject of handcraft are as illustrated on plate on p. 160. Fig. 1 shows a tee joint in orthographic projection, meaning right projection, from *orthos* (right) and *gonia* (an angle), or the geometrical representation of solids upon a plane surface in front and side elevation, and plan. The representation may be full size, as in the case of a working drawing, as to scale. The procedure is exactly the same as in solid geometry. An elevation (see Fig. 1) is first drawn on an XY line, each point being numbered as *a*, *b* and *a'*, *b'*. Projectors are then dropped from these points below the XY line into the horizontal plane. The line *ab* is next drawn, then the thickness lines *aa* and *bb*. A side view is projected as shown, thus completing the three views required of the object. The next system—called pictorial projection (see Fig. 2)—is a simple method of obtaining an approximately correct pictorial view of a given object. An elevation is first drawn as for orthographic projection, then lines are projected from the elevation at any convenient angle (30° or 45° are most suitable), the real thickness of the object is divided, and one-half is transferred to the thickness lines. The points obtained are then joined up and the back surface is represented. It should be noted that the latter lines are always parallel to their corresponding lines in the face side. Fig. 3 represents oblique projection; it differs from the former method only in one particular, viz. real lengths are marked on the projected lines instead of half-lengths. Angles of 30° and 45° are also suitable for this system. Compass lines and curves can be represented also when occurring in a model, involving the use of ordinates or guide lines. It is a satisfactory method for representing joints, small models, and constructive detail, and has the added advantage of showing three dimensions in a drawing, viz. length, width, and thickness. The use of the latter system is not recommended for large ob-

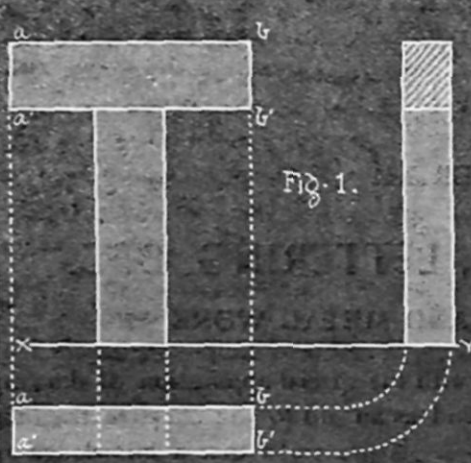
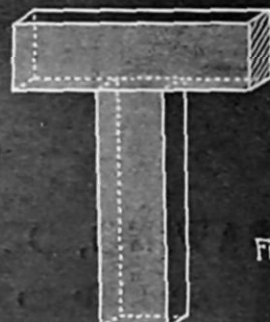
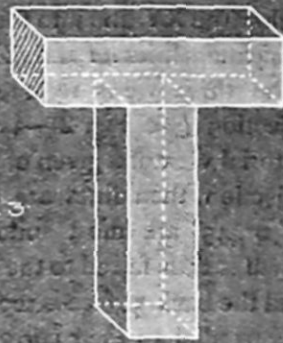
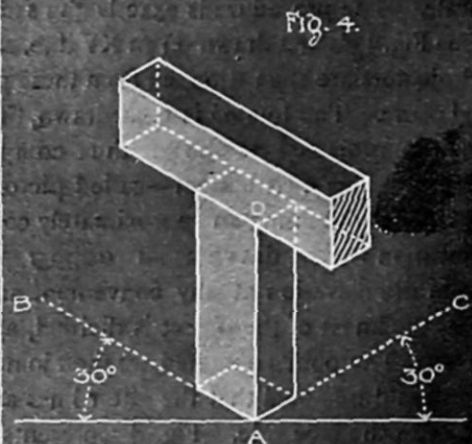
<p>Orthographic Projection.</p>  <p>Fig. 1.</p> <p>Definition - Plan, Elevation and Section in Geometrical or Right Projection.</p>	<p>Pictorial Projection.</p>  <p>Fig. 2.</p> <p>Definition. - A True Front Elevation with Thickness Lines Projected at a Convenient Angle Drawn Half Full Length.</p>
<p>Oblique Projection.</p>  <p>Fig. 3.</p> <p>Definition. - A True Front Elevation with Thickness Lines Projected Full Length at a Convenient Angle.</p>	<p>Isometric Projection.</p>  <p>Fig. 4.</p> <p>Definition. - Length, Breadth and Thickness Lines Drawn Parallel to Isometric Axes AB - AD and AC.</p>

Figs. 1, 2, 3, and 4.—Illustrations of various systems of projection.

jects, having the disadvantage of giving an unpleasant tilted-up effect to the drawing. Various details are shown in this work, drawn as described. Isometric projection, from *isos* and *metric*, meaning equal measure, is particularly well suited for the representation of architectural and woodworking objects, these usually being composed of right-angled solids, or with their adjacent planes at right angles. This system was invented by Professor Farish. The lines BA, DA, and CA constitute the isometric *axes*, and all lines coincident with a parallel to these axes are drawn true length upon the picture. To represent the front elevation of the tee piece in isometric projection, the width of the stem should be marked from the *regulating point* A. A perpendicular is then erected parallel to the axis DA; the lines of the head are then drawn parallel to BA and DA respectively; thickness lines of the object illustrated are drawn parallel to AC, then true lengths are marked upon them, and when connected they are of course parallel to the axis DA. Curves, simple mouldings, and bevels may also be represented. The uses and limitations of the latter system are similar to those of oblique projection. **Working Drawings** constitute an important part of handcraft subjects; they are really an extended application of the principles embodied in the first example, and reference to the drawings in this book will suggest suitable arrangements of the views. **Perspective** is a branch of drawing knowledge based upon geometry, and it demands much study and practice in theoretical perspective shadow projection in order to become a proficient draughtsman. From the standpoint of teacher or student requiring perspective as an aid to effective expression of ideas or for purposes of graphic demonstration, a strictly accurate method is not absolutely essential. Architects' perspective is a much simpler system, and, although only approximately correct, it suffices for practical purposes. It may be divided into three kinds, of which the first is illustrated in Fig. 5, which also shows the key to the system. The scale is first decided upon, and then the elevation, side view, and plan may be drawn. Next a ground line is drawn (see key diagram), then the height or eye line at a distance of 5 ft. above the ground line, this representing the average height of a spectator's eye. The plan should then be transferred, the front corner touching the eye line, with the front line making an angle of 40° with it, the adjacent side of course subtending an angle of 50° . A station point is next decided, its distance from the GL depends upon the size of the object to be projected; it may be immediately below the nearest corner of the object, but not necessarily. Vanishing points must next be decided, the large diagram showing a suitable method of obtaining same; one line is drawn at an angle of 40° with the SP and another at 50° as shown. These are produced until they cut the HL. Angles of 30° and 60° may also be adopted, but the angle subtended by the vanishing lines should in all cases be 90° . The position of the legs is shown in the plan; a set square is placed on the drawing, touching one point of the plan and also the SP, then short projectors can be drawn until they cut the HL. From these points of intersection perpendiculars are dropped. The first to be so drawn is the

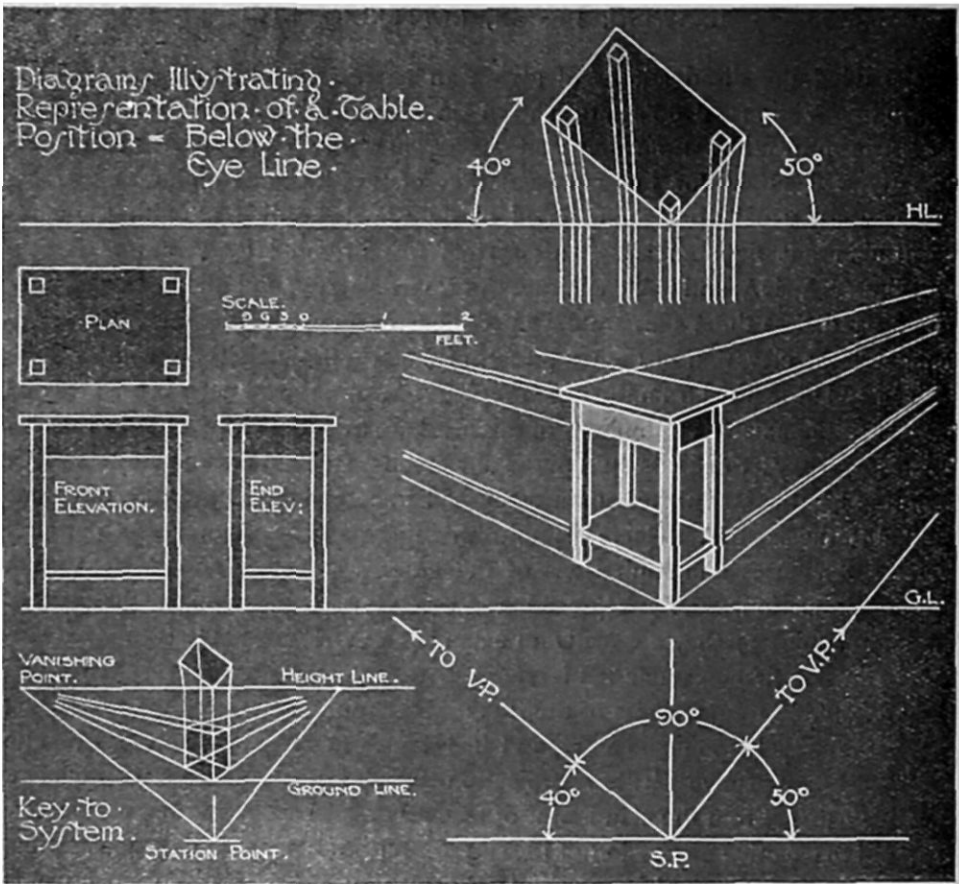

FIG. 5.—Diagrams illustrating method of showing objects in perspective when placed below the eye line.

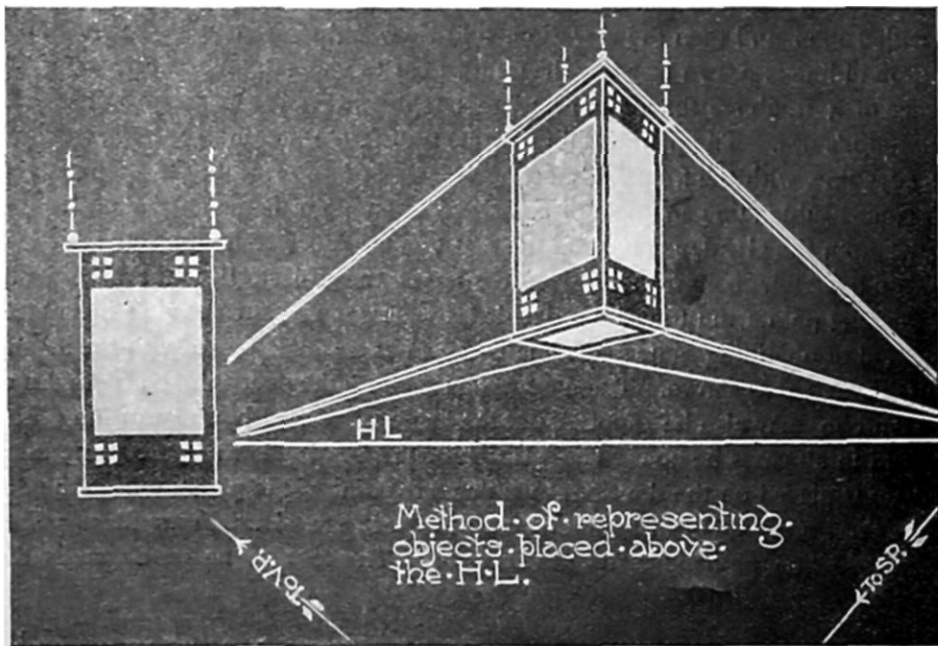

FIG. 6.

nearest line of the leg in plan; this must equal in length the elevation, and upon this *line* all heights for horizontal lines are measured. Both diagrams show the method of completing the drawing. Decorative features are added freehand; in the case of large curves ordinates may be employed for greater accuracy. It will be noticed from the views that all lines below the eye run in an upward direction, whilst those above the eye, as in Fig. 6, run downwards. A lantern is shown as an example in the latter diagram. The preparatory system is the same as that employed for the table. In both cases it is assumed that the distance of the spectator from the object is similar, therefore the nearest point in the plan coincides with a point on the HL. Projectors are drawn as before, and the necessary perpendiculars are drawn above instead of below the HL. The nearest point of the lantern should be about 7 ft. 6 in. from the SP, and a perpendicular raised from this provides the necessary line for preliminary measurements, which should also in this case be transferred from the elevation. If shading the completed line-drawing is desired, a good effect can be obtained by shading certain parts. The light has been considered in the diagrams to proceed from a position coincident with the left-hand VP. Those parts of the object farthest from the light are therefore strongly shaded, whilst the top receives a full measure of lighting and is left clear. The front of the table receives about half the light and is shaded as half-tone. Various media can be employed for this part of the work. With wash or colour drawings the washes should be made up in various depths of tone value; with pen and ink work the distance of the lines one from another is increased or decreased according as light or dark tones are required, as is also the case if pencils are used. The rendering of small objects in perspective is facilitated if a large scale is employed, as for example, the book-rest shown in Fig. 7. The real height is approximately 8 in.; this has been multiplied by 8, giving an assumed height of 3 ft. 4 in., which enables the object to be drawn by the method previously described. This is particularly well suited for the representation of small handcraft models, including handles, finger plates, bread platters, etc.

Design.—It is a matter of extreme difficulty to lay down certain formula for this elusive subject. Certain sizes of objects have been decided by custom, tradition, and fitness for a definite purpose, but proportion can be varied, and in itself is an important element of design. Models or objects with a bold, decided outline demand a corresponding boldness of decorative detail, whilst the lighter forms of craftwork are best suited to a dainty rendering of detail. This guiding principle is well exemplified by a comparison of Elizabethan wood or metal work with Sheraton's work of the eighteenth century. In the former, heavy proportions demand the use of large mouldings and carving with a peculiar freedom of treatment, whilst Sheraton's elegant proportions have mouldings and projections reduced to a minimum, with decorative inlaid work, light and dainty in design, or painted ornament of a similar character. Another important factor in design is the material employed. Oak, a strong grained wood of coarse texture, requires

a heavier treatment than satinwood; fine moulded detail in the former is obscured by the character of the material, and conversely, satinwood or ebony, having an even tone or colour, readily lends itself to lighter proportions and ornament. Colour values have again a material bearing upon the success of a design; rosewood, ebony, holly, and oak harmonize well in most combinations, as do also Italian or American walnut and purplewood, ebony, snakewood, and satinwood. There are numerous pleasing colour combinations possible in the use of natur-

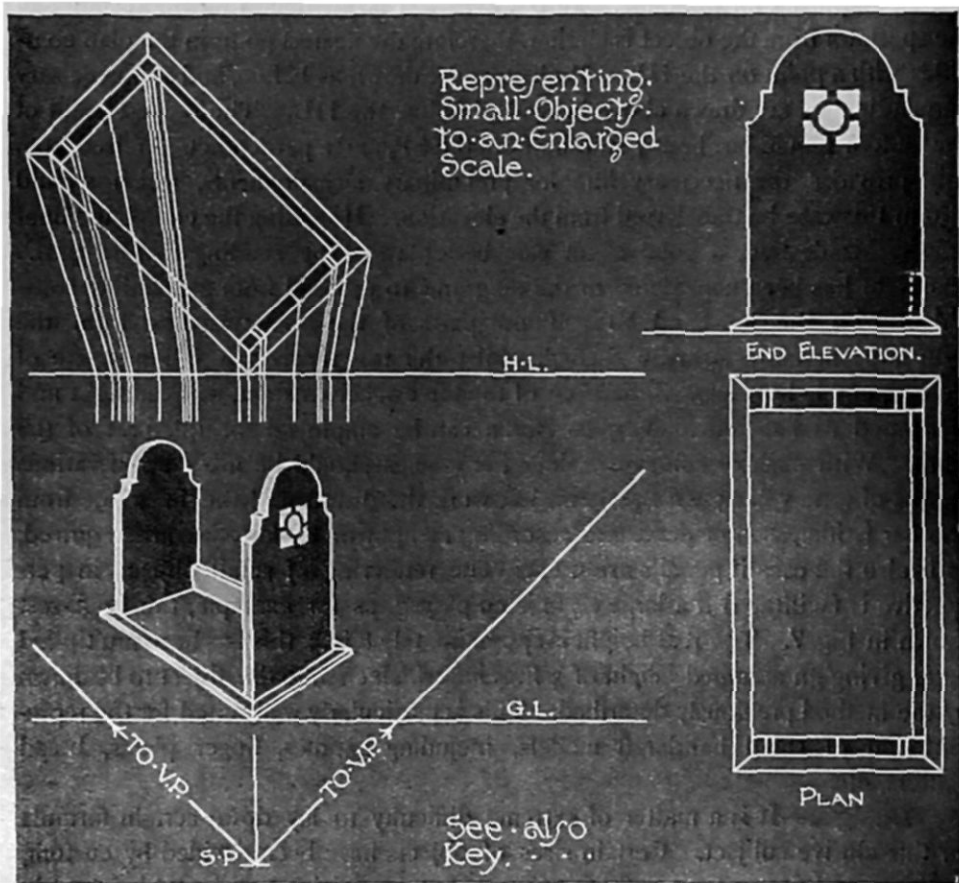
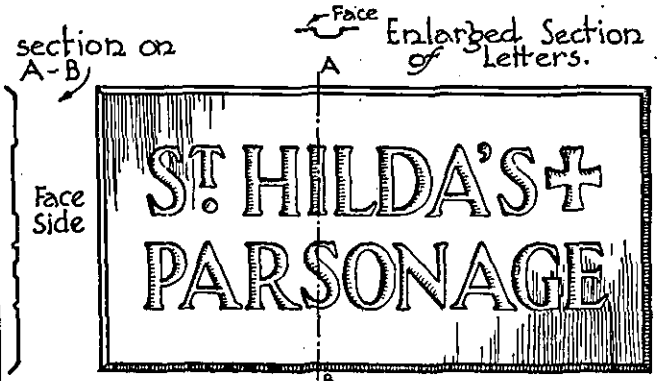

FIG. 7.—Method of representing small objects in perspective.

ally coloured woods alone, and the surest way to success is by experiment and careful observation with reference to harmony of colour. Ivory, tortoise-shell, and mother of pearl can be employed to advantage; the first material looks best when utilized in a dark groundwork for stencil effects. Tortoise-shell should be used in mass, and relieved by the use of silver or ebony, is very rich. The various varieties of pearl look best also in masses, with due regard to the beautiful colouring and lustre of the material. A study of historic work, and even pre-historic, cannot be too strongly urged; and to understand decorative craftwork,

SUGGESTIONS FOR NAME TABLETS

Scale 0 1 2 3 4 5 6 7 8 9 10 11 12 Inches



N°1 Ground raised & all letters recessed



N°2. Shield raised first then the letters raised on shield



N°3 letters raised from flat ground & border raised

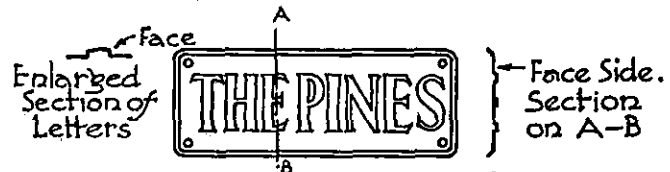

N°4 Ground raised & letters raised on ground

FIG. 7A.—Name tablets.

Illustrates various forms of lettering that are suitable for NAME TABLET in hammered or repoussé metal, and how various effects are obtained by different treatment. These should be studied in conjunction with Fig. 11 and Fig 8 (1).

a study of history, customs, fashions, and politics is essential. The examples illustrated in various parts of the work show in some measure how traditional craftwork can be adapted to modern handcraft.

Lettering.—First reference to handcraft deals chiefly with suitable imitation of printed characters on drawings. There are many excellent books published on this subject specially suited for students and teachers. Albrecht Durer type is well proportioned and tasteful in appearance; it has the added advantage of lending itself readily to geometrical construction, although this is not recommended unless a large exercise letter is being drawn. In one well-known antique book in the Victoria and Albert Museum at South Kensington, Albrecht Durer shows the constructions employed by him for the whole alphabet. Ancient Roman and mediæval Italian is particularly good, and well repay study; this can be effected through the medium of old pictures, tablets, inlaid woodwork, and books.

For general handcraft purposes a square kind of lettering is best. Applied to working and scale drawings, headings in notebook and incidental descriptions, it is easy to space, and can with some little practice be quickly drawn. A good plan is to draw two lines parallel and about $\frac{1}{4}$ in. apart. These are then converted into squares with a space of $\frac{1}{16}$ in. between them. Such squares neatly filled with the letter (with the exception of I, which can be drawn with one stroke) give a precise and pleasing effect. Letters are then drawn in each square, and when spaced in this way completed words and sentences give a pleasing idea of good spacing and proportion. For class work, not more than one style should be adopted. The square lettering used upon many of the plates in this work can be reduced or enlarged in size according to the relative importance of the references, and have been found by the authors quite satisfactory for class work.

Fig. 7A illustrates a few methods of making name plates, and shows different styles of lettering, but they apply only to hammered work; other good examples are the memorial tablets Fig. 8 (1), p. 168, and Fig. 11, p. 171.

Large metal letters, as used for facias, are usually cast from a wood pattern, then filed up, polished, and fixed with bolts.

Many tablets with letters in relief are made by drawing the letters on a plate of thick metal, and cutting away the ground-work with small revolving cutters fixed in a machine. This is called an engraving machine. Some tablets are cast all in one piece. One method of making the pattern necessary for this is to draw the design on a thin board and model the design and letters in relief with "Gesso."

Figs 8 to 13 of this chapter are some reproductions of artistic metalwork that have been made for various purposes and in different metals, and which in some cases are based on traditional styles. It will at once be seen how important are drawing, design, and lettering, in conjunction with mechanical processes and the knowledge of materials. They are examples of work that can be done by good craftsmen, and are modern. They show how material must govern design, and if this kind of work is to be maintained, it is evident that design drawing and



(1) Embossed and chased copper memorial tablet.

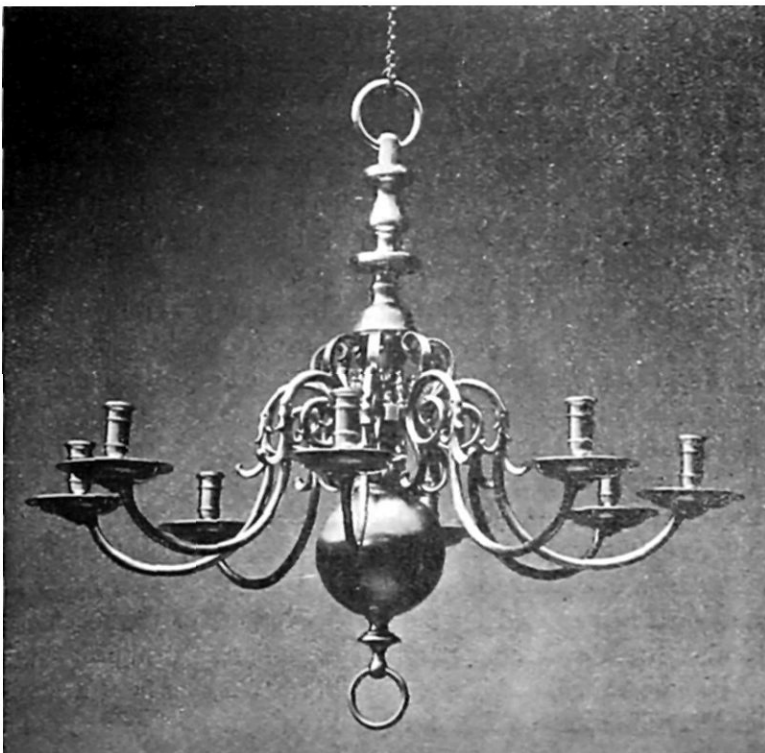

(2) Reproduction of a Dutch chandelier in brass.

lettering should be practised in conjunction with the actual work. In many cases the craftsman must be an artist. Teaching design in the abstract is of little use. It is useless to make a fine design for a wrought-iron entrance gate, and when the working drawing is made, and the work comes to be executed, it is found that it cannot be made owing to its prohibitive cost (caused by the length of time required to make it), or its faulty construction, or the impossibility of making and fixing in the metal required the forms as designed. The designer of metalwork must have knowledge of materials and technical processes, as well as of symbolical and conventional ornament. Many kinds of drawing, such as the drawing and colouring of plants, geometrical drawing, including development of surfaces, drawing with chalk, crayons, or charcoal on brown paper, or with charcoal, blue or red pencil on white paper, especially if of a large size or to a large scale, are useful in metalwork. The working out of workshop drawings from small coloured sketches is excellent practice, as it brings forward many points often overlooked in the small sketches. The working drawings should consist of full-sized drawings (where practicable) of each particular part and detail with the sizes in figures, as well as the constructive details (joints, etc.), which are most suitable for that particular part, and should show the name of the material to be used. If cast and turned work enter into the design, there would be the necessary patterns, core prints, core boxes, etc., to be drawn, showing the necessary allowances for shrinkage, turning, and fitting together, and the pieces that sometimes have to be added (and afterwards removed) for holding the work. Often during the manufacture, patterns or designs arise which in themselves can be utilized as decorative features, e.g. the rivets which hold the raised piece of metal on the finger plate (p. 73); only three are necessary, the rest could be dummies, but they form a decorative feature. The laps on the tin box on p. 75 are decorative as well as necessary.

All the articles shown in these pages have the names of the various metals of which they should be made; and on examination it will be found that there is a wide difference between what should be cast and what should be wrought, as a model that is designed for, and made in, wrought iron would not be suitable if made in cast iron. For instance, the cage handle illustrated on p. 121, though correct for wrought iron, would be wrong made of cast iron or wrought copper, and would cost a great deal more, because more difficult to make in these latter metals. It is not what is possible but what is proper and most suitable for the particular purpose. It is for many workers and students much easier to model a design for metalwork than to draw it, and it gives a better appreciation of form, bulk, and relief, than drawing ever can. It enters largely into the processes of blacksmithing (see p. 121), coppersmithing (see p. 96), silversmithing (see p. 100), casting, chasing, and embossing. A design that has been modelled, and is going to be made in metal, can be measured and gauged for the various heights of the relief, etc., which cannot be done with a drawing. It is thus more realistic, but it applies more particularly to cast, raised, and hammered work. Working from a model, there is less possibility of mistakes being made and consequently less waste of material

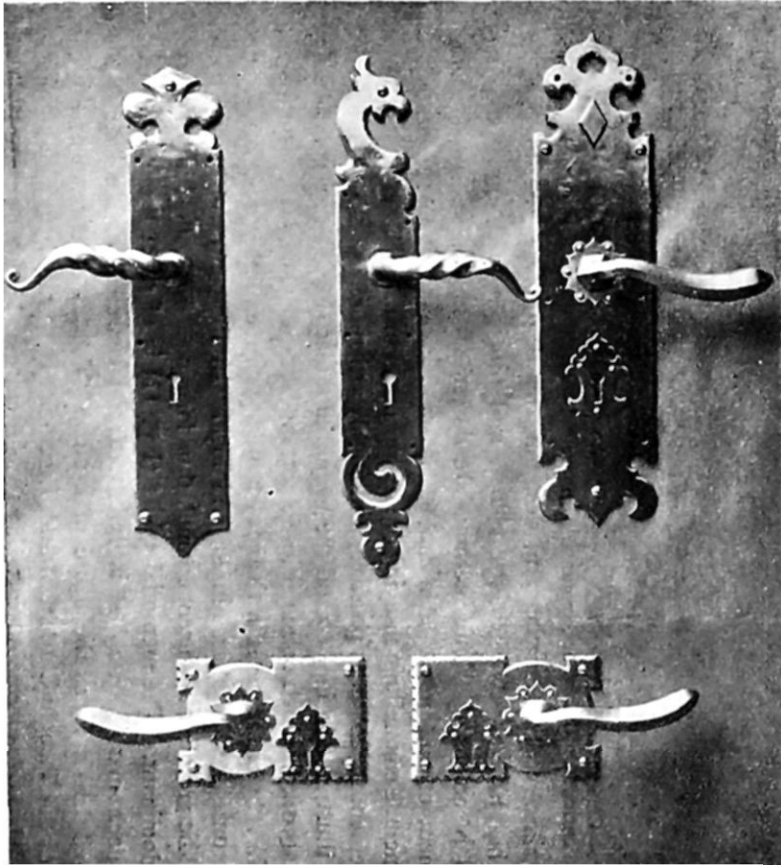

(1) Lock plates and handles of polished steel.

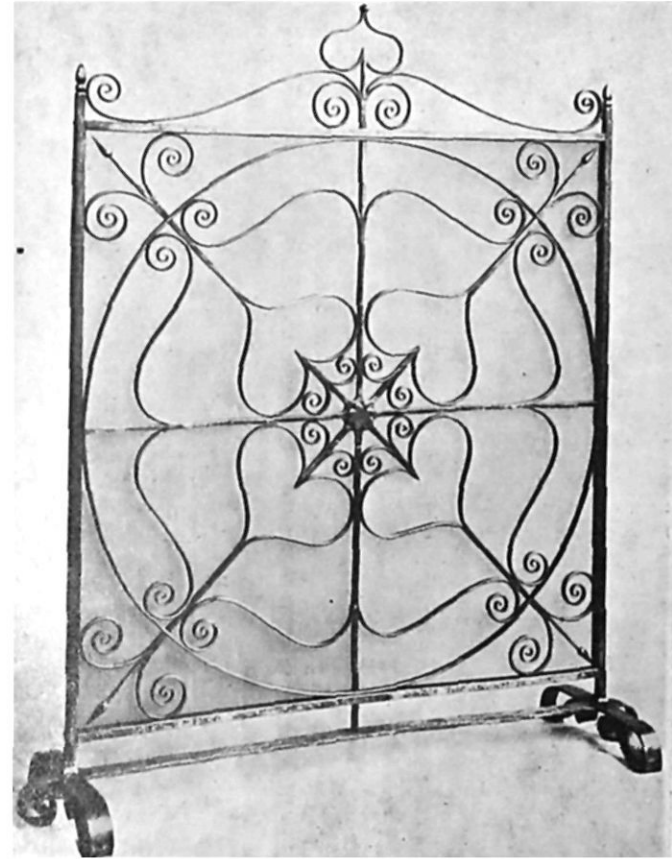

(2) A fire Screen of wrought iron (modern).

FIG. 9.

Many of the objects shown could be easily modelled the correct size, and the work made from the model without a drawing at all. The models Nos. 10, 11, 12 on p. 121, and No. 2 on Fig. 9, p. 169, would have to be modelled, but in various ways and materials, as described on p. 124. Models Nos. 6, 7, 8, 9, 10 on p. 89 could be modelled in a plastic material, then a plaster cast taken of them, and when suitable, such as Ch. IX, Fig. 8, Nos. 6, 10, 11, 12 on p. 121, they could be cast in brass or bronze. Letters could be treated in the same way, as letters are used largely for signs, shields, nameplates, etc., but good examples should be copied in the early stages. They could also be raised from thin sheet metal, as shown in Fig. 7A, p. 165, or sunk and filled with coloured wax, as shown in Fig. 11, p. 171. A good practical exercise would be to draw a letter about 4, 5, or 6 inches high, transfer it by means of a tracing and pricking through with a pin to the modelling medium, model it and take a plaster cast from it, and from this to



FIG. 10.—Casket covered with tooled painted and gilt leather and enriched with bronze mounts and enamelled crest.

take a cast of the letter, strengthening it by means of galvanized iron wire. This would be a pattern from which a casting in metal could be made. This in turn could be filed up and finished, thus completing the letter from the drawing to the finished articles. Patterns for letters could also be made in wood.

Colours should also be considered when drawing and designing for decorative metalwork, as each metal has its own characteristic colour, and this can often be modified and altered by colouring. The methods are described on pp. 224-225. The arrangement of one metal with another is often dependent on the colour, and if we include enamelling, inlaying of another metal or of precious stones, etc., any arrangement of colour is possible, and highly artistic effects are obtained. The casket illustrated in Fig. 10 and the memorial tablet (Fig. 11) are good examples of metalwork in which colour is an important feature. The casket itself is made of mahogany and covered with richly tooled, painted, and gilt leather, mounted with bronze feet, handles, hinges, and lock. In the centre of the lid there is a heraldic crest in translucent enamel, thus forming a work of art in which colour is predominant. The memorial tablet (Fig. 11) is of sheet bronze mounted on a Purbeck marble base. It is embossed and chased, and the lettering is so arranged that it forms the figure of a cross. The tablet is fixed in the choir-room of the Temple Church, Strand, London. It was designed by the father of W. M. Hastwell in conjunction with the writer. W. M. Hastwell and his father were choristers at the Temple Church, London.



FIG. 11.—Memorial tablet of embossed and chased bronze with champlévé enamelled shield.

The memorial tablet, Fig. 8 (1), p. 167, is of hammered copper mounted on verde antico marble. Note how the size and arrangements of the letters vary in respect to their importance, also the simple border and conventional laurel of bay leaf branches used by the ancients for wreaths of honour. The brass chandelier, or if fitted for the electric light, an electrolier, is a reproduction of an eighteenth-century Dutch one, and is made entirely of cast and turned brass, Fig. 8 (2).

The lock plates, see Fig. 9 (1), made of wrought steel, with forged handles, pierced and applied ornament, are of a design based on Elizabethan work of the sixteenth century. They are polished and have been hammered in the making and the marks have not been taken out. These give the metal a rich appearance.

The iron fire-screen, Fig. 9 (2), has been designed and made by Cecil Ern of Ganton Street, London. It is a modern design based on an eighteenth-century style, light and graceful in appearance. It is backed by a fine mesh wire panel to prevent sparks flying through the screen. The welded joints have been carried

out by the forge fire and hammer process, as distinct from oxy-acetylene blowpipe welding.

The wrought-iron pediment of a gate shown in Fig. 13 (1) is a good example, not too intricate, of the use of natural forms treated in a conventional manner, and suitable for the material. Each small leaf has been welded separately on to each stem. They are all modelled, and as they vary in thickness, they have been forged from bar iron and shaped while hot. The larger leaves are cut from thick plate and modelled while hot, and then welded on to the scrolls, with the exception of the two end ones on the bottom bar.

The introduction of oxy-acetylene welding has been the means of altering considerably the design of modern iron work, in fact it has created a "style"; for example see Edgar Brandts' work in iron and bronze.



FIG. 12.—Adam Door Knocker, Percy House, Great Portland Street. (Now destroyed.)

The illustration, Fig. 13 (2), is of a wrought-iron grille of quite a different character. This is based on the palm leaf, and treated conventionally.

The very handsome polished brass door knocker (Fig. 12) from Percy House, Great Portland Street (now demolished), is a good example of practical design, being most suitable for its purpose, and the material from which it is made. It is neither too heavy, nor overloaded with ornament, and it can easily be cleaned. This is an example of eighteenth-century work.



(1) A leaf of a gate made of wrought iron with cast nickel stag in the round. . Designed and made by Cecil Ern of Ganton Street, London.

FIG. 13.



(2) Wrought-iron grille.



FIG. 1.—Part of a Dutch cabinet showing marquetry floral ornament.

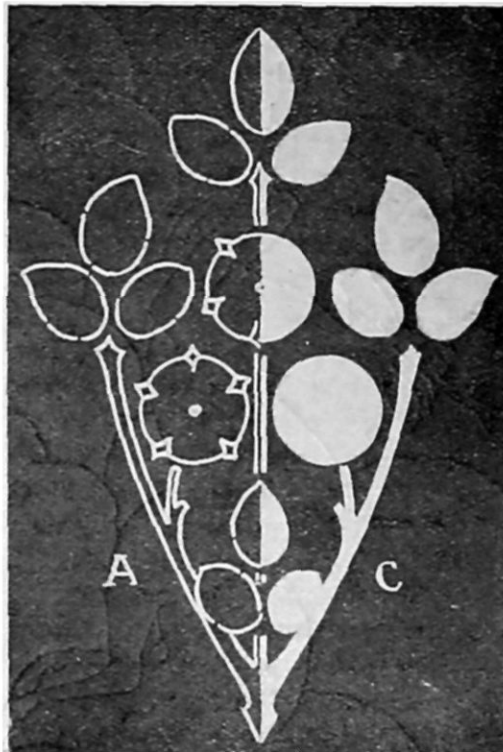

FIG. 2.—Diagram illustrating method of inlaying leaves, etc.

CHAPTER XIII

DECORATIVE PROCESSES

IN WOOD AND METAL WORK

“Art is man added to nature.”—BACON.

INLAYING is an art of great antiquity. The term may be regarded as equivalent to the Latin “interserere,” to insert. Inlaying proper consists of cutting out thin pieces of wood, veneer, or other material to correspond with the units of a certain design. These are marked upon the groundwork and cut with chisels and gouges. This leaves cavities into which the prepared units of the design are “inserted” or “laid in” the groundwork, being fixed with glue or other adhesive medium. The term “marquetry” is often confused with “inlaying,” but the two processes are totally distinct. Marquetry comes from the French word “marqueter,” hence marqueterie, and originally meant to spot or mark. The latter term is applied to decorative work where six or more sheets of veneer are temporarily fixed together and cut simultaneously to a design with a special saw and implement called a “donkey”. The various pieces are then interchanged from the different layers in order to effect the necessary contrast of colour and are then glued down to a sheet of paper to complete the whole design. A good example of inlaying is shown in the frontispiece at the head of the mirror frame. From this it can clearly be seen that the design must be composed of separate and distinct units. A characteristic example of marquetry from a Dutch cabinet is shown in Fig. 1. A comparison of the two examples shows the fact that with the former process stencil effects are best and in the latter continuous designs of floral and symbolical devices can be executed. The inlaying in the frontispiece is also an excellent object lesson in the handling of material, and the limitations of design imposed by the use of a brittle material. It is an axiom of good inlay design that the various units of an inlayed pattern should be of such a shape as to permit of easy handling during the processes of cutting and shaping previous to glueing in. Obviously this prevents the use of composite parts designed with a too close resemblance to the natural motif, when it is intertwining stems, sharply curved stalks, leaves, etc. This principle will be better understood by reference to the illustration, Fig. 3; here are shown some inlaying designs based upon the wild rose. A certain stiffness of effect is inevitable, but considerable charm can be produced by good grouping and colour harmonies with natural woods. To produce either of the panel centres shown, the design is

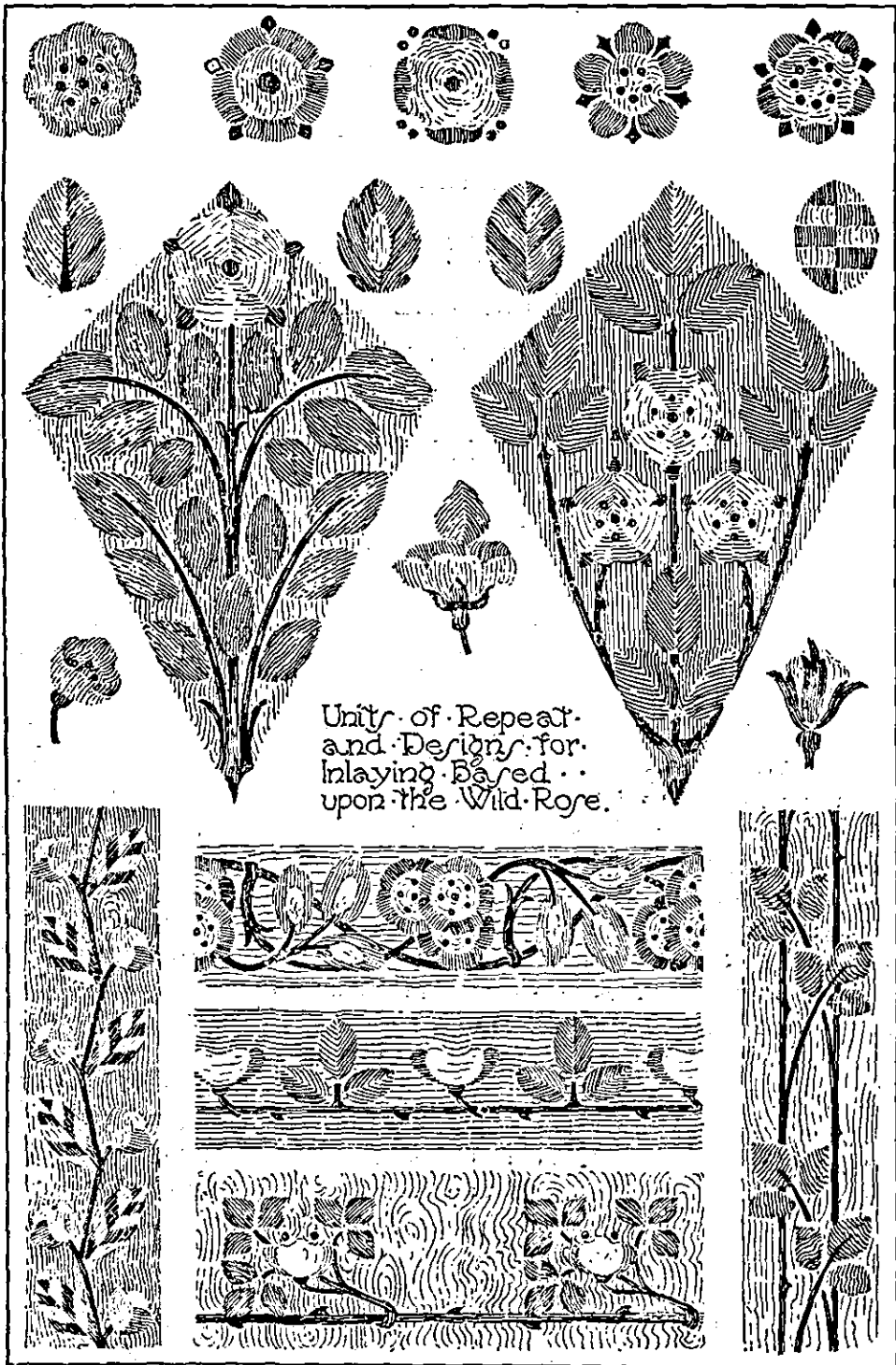

FIG. 3.—Various designs for inlaying based upon the "Wild Rose".



FIG. 4.—Various specimens of pictorial overlaying from Bethnal Green Museum.

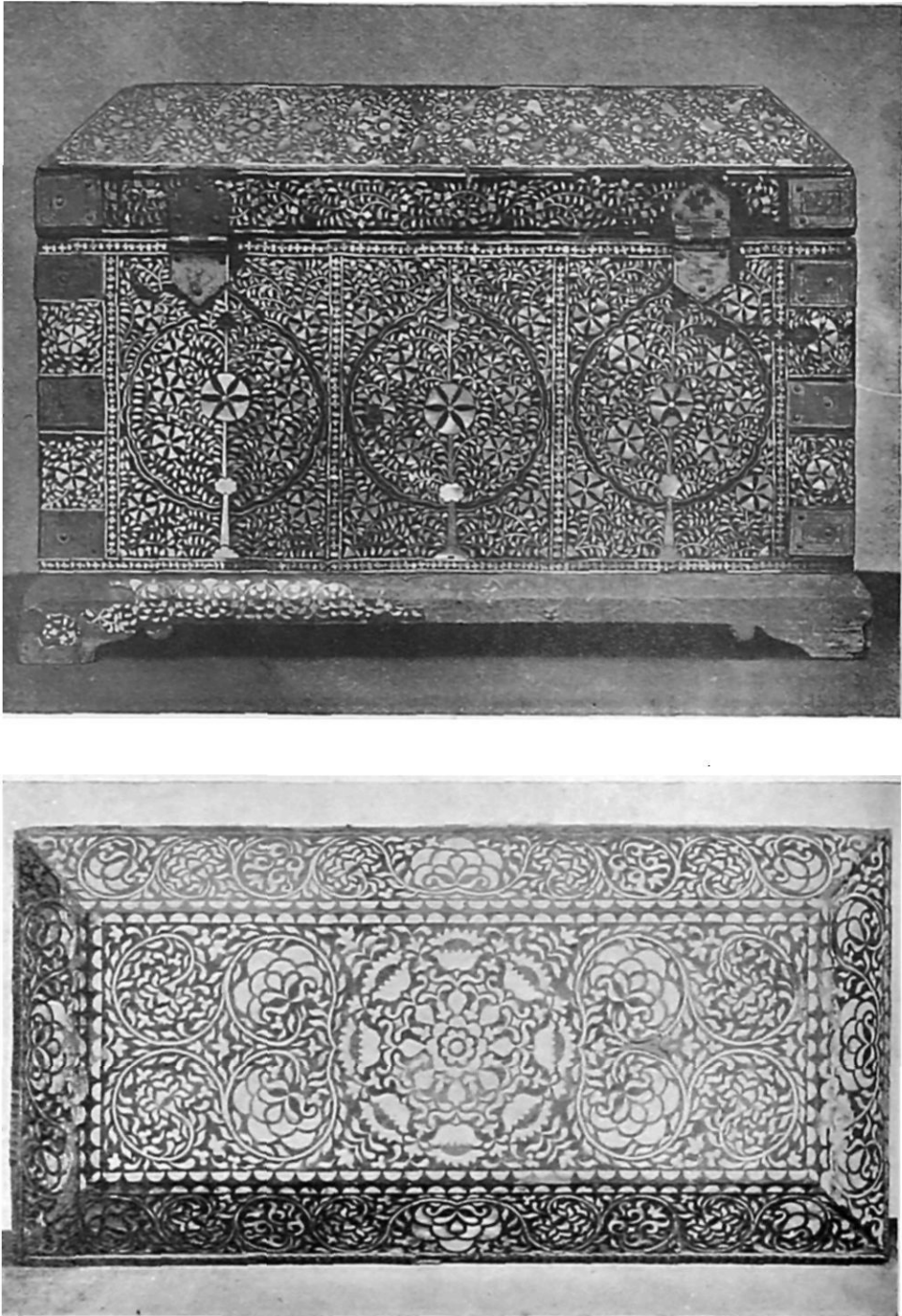

FIG. 5.—Fine examples of Eastern inlaying. Mother of pearl and mastic.

first prepared on cartridge paper and glued down to the groundwork or panel, see A, Fig. 2. Tracings are then made of each unit, i.e. stems, flowers, and leaves, these being glued down to suitably coloured veneer. In the case of the flowers, one tracing serves for three thicknesses of veneer, and so on with leaves and stalks. These are cut out with a small hand fret-saw [see illustration Ch. XVI, f. 8 (1)], used in conjunction with a small cutting board or a vice as illustrated in Ch. XVI, f. 15. They should be cut "outside the line," that is, so as to leave the pencil mark upon the unit, and the cavities upon the ground are cut with gouges first "inside the line". Each piece should be tried and fitted if necessary before glueing is proceeded with. C in Fig. 2 illustrates the design when the main units of the design have been inlaid. The spots and small diamond shapes are best done with a small square awl hole and chisel, afterwards filled with a coloured composition. Although generally termed inlaying, the examples shown in Fig. 4, are really "overlaid". These are admirable examples from the Bethnal Green Museum, illustrating the possibilities of good decorative work in woods and veneers. Richness of effect is obtained by the careful selection of material, with due regard to colour and the natural markings of the wood. The executive processes attached to work of this type vary from those previously described. The general principle is to first lay a piece of veneer upon the groundwork (this is described under the heading of veneering in another part of this work). The design is glued down to the groundwork and a tracing is taken of each unit, these being glued down to pieces of veneer and cut out with a fret-saw. As in the process of inlaying, each unit should be cut outside the line and the groundwork outline just cut away. The design is commenced at a corner and laid down piece by piece until the whole is completed. Inlaying of yet another kind is shown in Fig. 5. This is a fine example of Persian craftsmanship and a beautiful specimen of design work. In the execution of this and similar work the groundwork was covered with a preparation of mastic—a kind of lacquer—and the prepared units were embedded until the whole box was incrustured with mother of pearl or ivory. It was then allowed to stand until thoroughly hardened, when it was levelled down, the finished surface having the appearance of inlaid work. The drawback to this process is that the mastic has a tendency to peel away from the groundwork, as can be seen in the photograph. The original coffer is in the Victoria and Albert Museum. There are various interesting references to inlaying in classical literature. Chests mentioned by Homer were ornamented with inlaid work of precious metals and ivory. Vitruvius and Pliny also refer to inlaying, using the word "cerostrata," meaning inlaid with horn and wax. In Book 23 of the "Odyssey" Ulysses describes to Penelope the bridal bed in the following terms: "Beginning from this head post, I wrought at the bedstead till I had finished it, and made it fair with inlaid work of gold and of silver, and of ivory." A Biblical reference to inlaying is found in 1 Kings x. 18: "Moreover the king made a great throne of ivory and overlaid it with the best gold". There are several other references to this and other arts in the Bible.

Various London museums and the Louvre display specimens of inlaying of ancient Assyrian and Egyptian origin, remarkable both for ingenuity of design and perfection of execution. Metal, ebony, and ivory were the chief media used. Processes connected with handcraft lessons, either constructional or decorative, must necessarily be simple and within the range of a boy's ability. Whilst, however, strict limitations to the practical side are imposed by a pupil's capacity and physical strength, the educational or culture value is practically unlimited. Lessons on the history or development of inlaying can be devised, and the importance attached to this art in ancient times can be discussed through the medium of classic literature. The style of inlaying best suited to the needs of handcraft centres is that in which a definite unit is taken and arranged into a design. Thus in Fig. 6 a leaf is made by the simple action of two gouge cuts. The boys should be limited to the use of a certain number of units and instructed

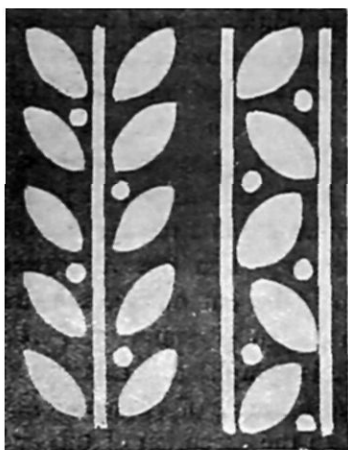

FIG. 6.—Gouge patterns.

to arrange them into a simple design. Reference to Fig. 6 will show two simple treatments. When the design is completed and drawn in outline, it should be pasted down to the work in hand. The same gouge is used to cut the units in the groundwork, and when it is placed in position it should be struck smartly with the hand. The inside can then be easily removed with a small chisel, leaving cavities for the reception of the leaf units. Further applications of this process embodying various degrees of manipulative skill are illustrated in the woodwork models.

Another simple method of decorating the edges of handcraft models is that illustrated in frontispiece. This is a traditional type of decoration, introduced during the period of Queen Anne. It is easy to manipulate and refined in appearance. It is capable of many variations and is proceeded with as follows:

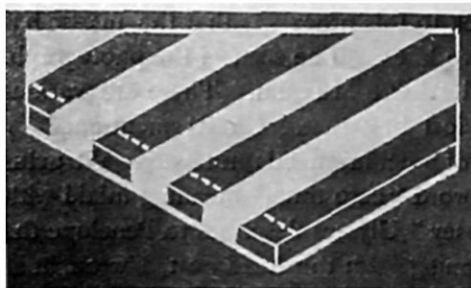

FIG. 7.—Building mosaic edging.

Two pieces of wood of contrasting colours and $\frac{3}{16}$ in. thick are gauged and planed up to thickness; the end of each piece is then planed across and strips gauged and cut from each piece, the edges being smoothed with a finely set plane. They are then glued down alternately to a piece of knife-cut veneer, and when dry the edge is planed, and strips gauged off as indicated by the dotted lines in

diagram Fig. 7. In each of these designs it is necessary to work a small rebate, into which the "mosaic" inlay is glued and levelled off. This process is further

illustrated on p. 53. A few good specimens of mosaic stringings, which can be purchased at most veneer stores, are illustrated on p. 56. These are inlaid as shown on p. 55, and the method by which this is effected is as follows: A scratch stock (see Fig. 8) is first prepared. A represents the stock, B is the stock or butt piece, and is connected to the stock by a bolt passed through A and B. The butterfly nut C is loosened and B can then be

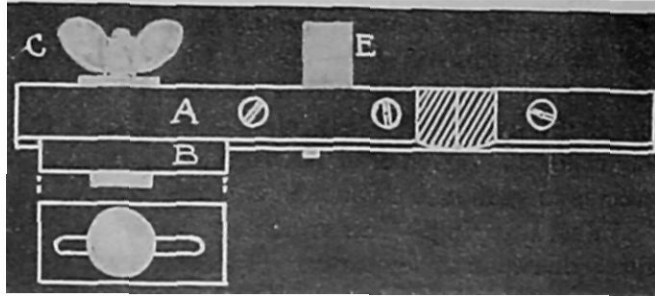

FIG. 8.—Diagrams illustrating a scratch stock.

pushed along the required distance from the edge of cutter E. The sectional view shows the stock with convex edge fitting into the concave edge of the butt piece or stop. The cutter E is made from $\frac{1}{16}$ in. steel, the edge sharpened like a chisel, and then a burr is produced as with an ordinary scraper. The scratch stock is operated by pressing the end of B against the edge of the material, drawing the instrument to and fro to form a channel into which are glued the stringings, and when dry they are levelled with the groundwork. Various other applications of this process involving slight variations of practice are dealt with as they occur in connexion with the models. The following are given as examples of combinations of colour in natural woods for purposes of inlaying :—

For oak groundworks the following woods give pleasing effects :—

Green and brown ebony. Various varieties of rosewoods, holly, chestnut, Italian and American walnut, and cocos wood, a species of ebony.

For Italian or American walnut groundworks :—

Brown oak, the various varieties of ebony and rosewoods, holly, pear, box, and purple wood.

For rosewood groundworks :—

Brown oak, ebony, purple, ivory, and holly.

Other materials used for inlaying include mother of pearl, blue and Japanese pearl, ivory, and various metals, all of which can be judiciously combined with the majority of the preceding woods. All these demand certain processes not previously dealt with. Pearl is a very brittle substance and extremely hard, hence one thickness only can be cut at a time, and the best plan is to trace the desired shapes on to the pearl and then to fix it in the jaws of a parallel vice (see diagram Ch. xvi, f. 15). A small fret saw frame (see Ch. xvi, f. 8 (r)) should be used to cut the pearl, held with the blade horizontal. A little soap rubbed on the blade facilitates working, and if necessary the pieces should be regulated with a fine cut file. Before they are glued in, the pieces should be

roughened with the end of a file in order to assist the adhesion of the glue. Ivory is treated in a similar manner, and is also cut, one or more thicknesses, as described above. Metal for inlaying should be about $\frac{1}{32}$ in. thick, and is also cut with fret saws as described, the underside being picked with a sharp point to assist adhesion. A small quantity of Venice turpentine or garlic added to glue acts chemically upon metallic surfaces, removing all traces of grease, and effects a much stronger joint. Mother of pearl is best when treated in masses for decoration, thus obtaining the full effect of its charming colours and varying shades. Ivory is best for spotted or mosaic decoration, and the use of metal is practically restricted to small escutcheons and enrichments.

Wax Inlaying.—This is another traditional type of decoration, rather unjustly abused in some quarters. Theoretically the application of wax inlaying may be wrong, it being contended that its composition is liable to shrink and fall out. In actual practice, however, a better state of things occurs, as is evinced by a fine French cabinet (period sixteenth century) in the Edinburgh Museum. For this example a free treatment of design is possible, there being practically no limitation to the use of the material, as is the case when inlaying wood. The design is cut out with a vee tool and gouges, and the cavities filled with a composition of wax, dry colour, and resin. The latter acts as a hardening element. The three media are melted and well mixed together, and the mixture is then put into the grooves with a piece of stick. Previous to the insertion of the wax, the wood should be given a coating of ordinary French polish which prevents discoloration of the groundwork and a ragged effect in the fine lines owing to the composition soaking into the end grain. A design can be executed in one or more colours, care being taken not to allow them to merge one in the other where they join. The composition is dry half an hour or so after its application, and the superfluous composition can be removed with a steel scraper. Colour combinations for this process include reds, blues, blacks, and greens for oak; yellows, blues, or greens for mahogany. Stronger contrasts of colour can be effected with wax inlaying, and generally speaking, the tone of natural wood accentuated can be utilized as colour schemes. Various applications of this process are shown on pp. 36 and 30. A combination of wax and veneer inlaying is also an effective treatment (see Fig. 6 on p. 53). Punch work filled with this preparation is particularly suitable for young pupils, giving a deal of scope for ingenuity in design, and it is particularly easy to manipulate.

RECESSING.—This type of decoration, a familiar feature of Jacobean work, is not now used to the extent it deserves. There has been no noteworthy example of this art in England since the seventeenth century, nor abroad, where it flourished about the same time. Switzerland, Germany, and Scandinavia all excelled in the practice of this art, and the museums show some excellent examples of furniture decorated with this process. The details of a fine Tyrolean cabinet in the Victoria and Albert Museum are illustrated in Fig. 9, from which it will be seen that the whole outline is simply vee tooled and then recessed. The veins of the leaves are executed with one cut of the vee tool. Simple

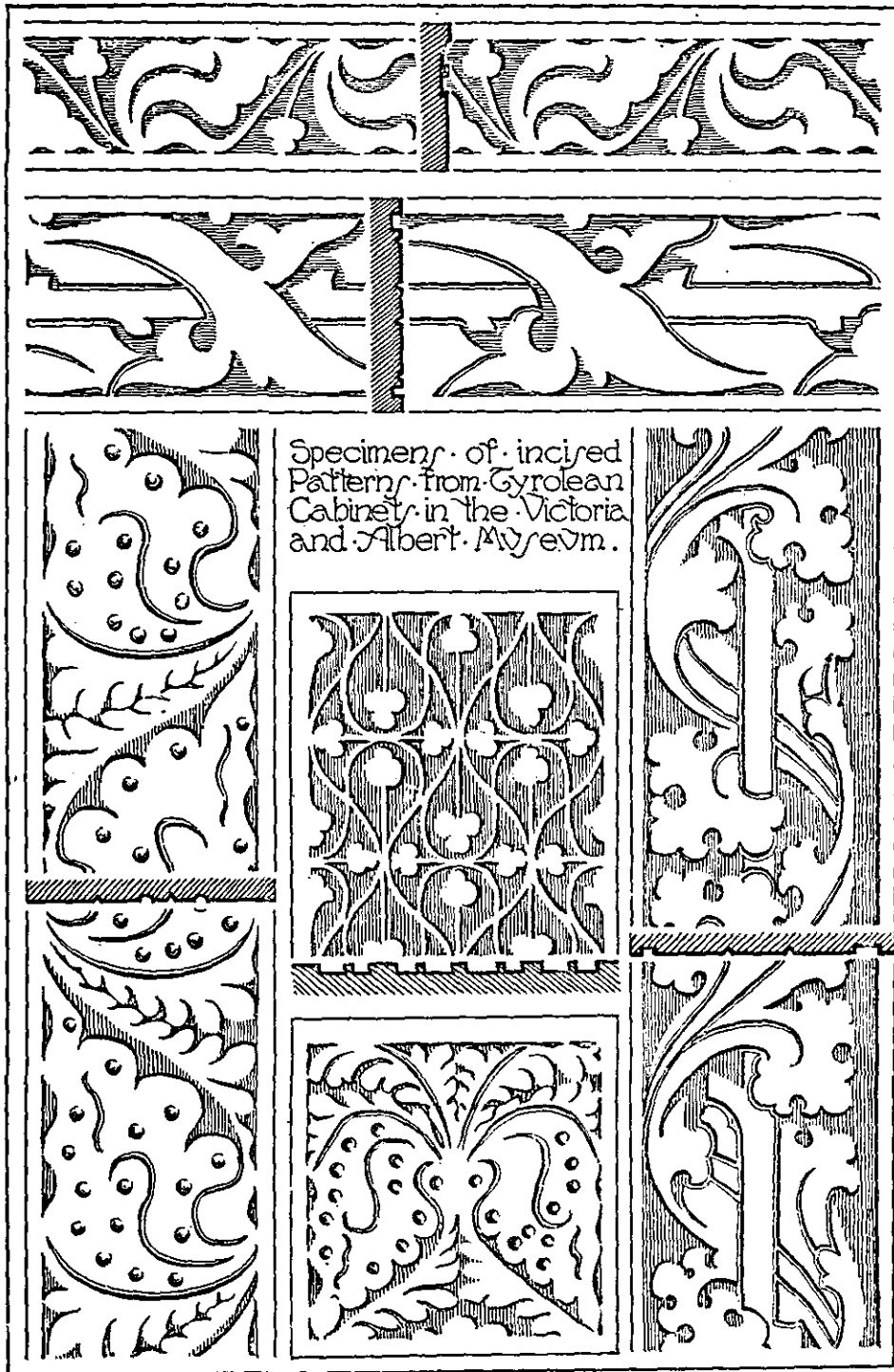

FIG. 9.

geometrical designs and outlines based upon natural motives as on p. 176 can very well be introduced, and if the recessed part is painted in oil colour rich effects are produced. Decorated in this way is the fine Scandinavian chair shown opposite, exhibited at the last Paris Exhibition. It is a rich example of work, following the traditional lines of Scandinavian ornament, and provides much useful detail for lessons, introducing simple carving and recessing. In executing this work, a good plan is to transfer the design on to the groundwork and then to cut or outline the design with gouges, not necessarily removing all traces of the tooling, for a texture is thus imparted to the background which has a very pleasing effect when coloured. The background can be painted with an admixture of painter's gold size and dry artist's colour which dries quickly. The surface or relief part of the decoration can be treated with another colour, or simply cleaned up and waxed. Mediaeval German artists produced some very beautiful specimens of this work, imitating a "gesso" effect, and gilding the background with fine gold leaf; the raised portions were also gilded and burnished bright to effect a contrast of tone. The writer has also seen specimens with a painted background of a red colour with the relief part gilded.

The drawings on p. 42 illustrate simple designs for recessed work which lend themselves also to decorative colour treatment.

PUNCH WORK is a simple process eminently suited to handcraft work. The designing is easy, and has advantages in the development of taste and observation of proportion by the disposition of units in a much greater range than the degree of executive skill demanded. Good designs can be effected with such a simple tool as the leather washer punch, obtainable at ironmongers. This is used for circular holes, whilst square and diamond shapes can be cut with chisels. Borders are especially effective when decorated in this way, and panels for doors and constructional models can be decorated with advantage.

Fig. 10 shows three designs for borders. The circular punch should be held in a vertical position, and struck smartly with a hammer, cutting the wood about $\frac{1}{8}$ in. deep. A slight movement of the tool usually suffices to separate the core, and the next spot can then be proceeded with. The punch has an elongated conical attachment which causes the loose circular pieces to become loose when several cuts are made. They may then be easily removed by reversing the punch. Square and diamond shaped holes are made with four chisel cuts, removing the core with a small chisel.

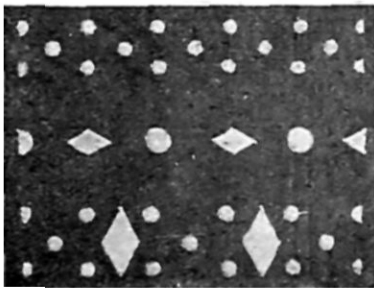

FIG. 10.—Simple patterns for punched work.

Composition can be used to fill in the spaces, or they may be painted in contrasting colours. The play of light and shade also has a pleasing effect in this type of work.

Carving, like its sister art inlaying, is also of very ancient origin, as is evidenced by the examples illustrated in the chapter on decorative examples of



Norwegian bowls, examples of peasant art, carved wood, the bowl being painted.

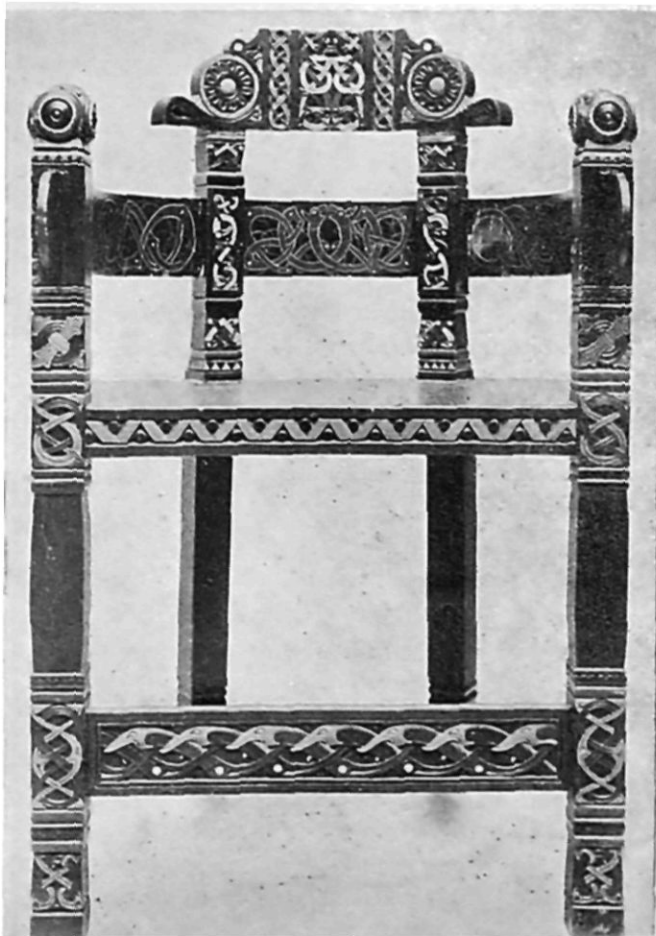

FIG. 10A.—A modern Scandinavian chair shown at the Paris Exhibition.



FIG. 11.—Peasant art: Swiss painted boxes from Argovie and Thurgovie. From a watercolour.

handcraft. Nearly all nations have had a period in their history when carving was the pre-eminent craft. Not only has wood been chosen for carved decoration, but metal, stone, and marble, gems, ivory, and pearls, have from the earliest times all been utilized in the practice of this art. Mediæval France and Italy produced most elaborate specimens of carving, especially during the Gothic and Renaissance periods. These masterpieces are unsurpassed from the point of view of technique, with the exception perhaps of work belonging to the Grinling Gibbons school in England. Educationally, they should be regarded as the peculiar products of a period, interesting as studies, but devoid of true æsthetic feeling.

VENEERING.—As a form of decoration veneering is a valuable process. It can be employed with advantage in nearly all kinds of furniture and advanced models, and affords good opportunities for the exercise of good design and colour ideas. The diagrams in Fig. 13 show right designs for veneering suitable for door panels, and these with slight alterations of size and arrangement would be suitable for bureau flaps, table tops, and flush doors.

To execute the second example shown on p. 188, the following procedure would be adopted: first damp and stretch a sheet of cartridge paper upon a drawing board and then carefully set out the pattern with pencil lines. Next select suitably coloured veneers—or veneers with contrasting figures—such as fiddle back and mottled mahogany, or American and well-figured Italian walnut, or rosewood and brown oak, then cut the pieces rather larger than the drawing, afterwards planing them to shape with an iron shoulder plane upon a shooting board. It will be found the best plan to lay on a piece of cross banding first; this may be laid in one or two pieces neatly joined with the mitres correctly fitted, and secured by glueing down to the paper, then the three top pieces would be planed and glued down to the paper, these being followed by the diamond and half-diamond shapes. The three large centre pieces would be dealt with next, and so on until the whole of the centre part was completed, after which the cross bandings would be fitted to complete the panel. In the first and third examples diamond shapes are fitted into a large diamond. This type of veneering may be expeditiously executed by glueing up strips of veneers—ebony and satinwood, for instance—with the grain and width coinciding with the required pattern. One end can then be cut and fitted to the diamond shape and consecutive rows gauged off and moved along one diamond in order to effect the change. The fifth example shows inlay-



FIG. 12.—A fine carved panel in oak, a simple and effective design, English, early sixteenth century.

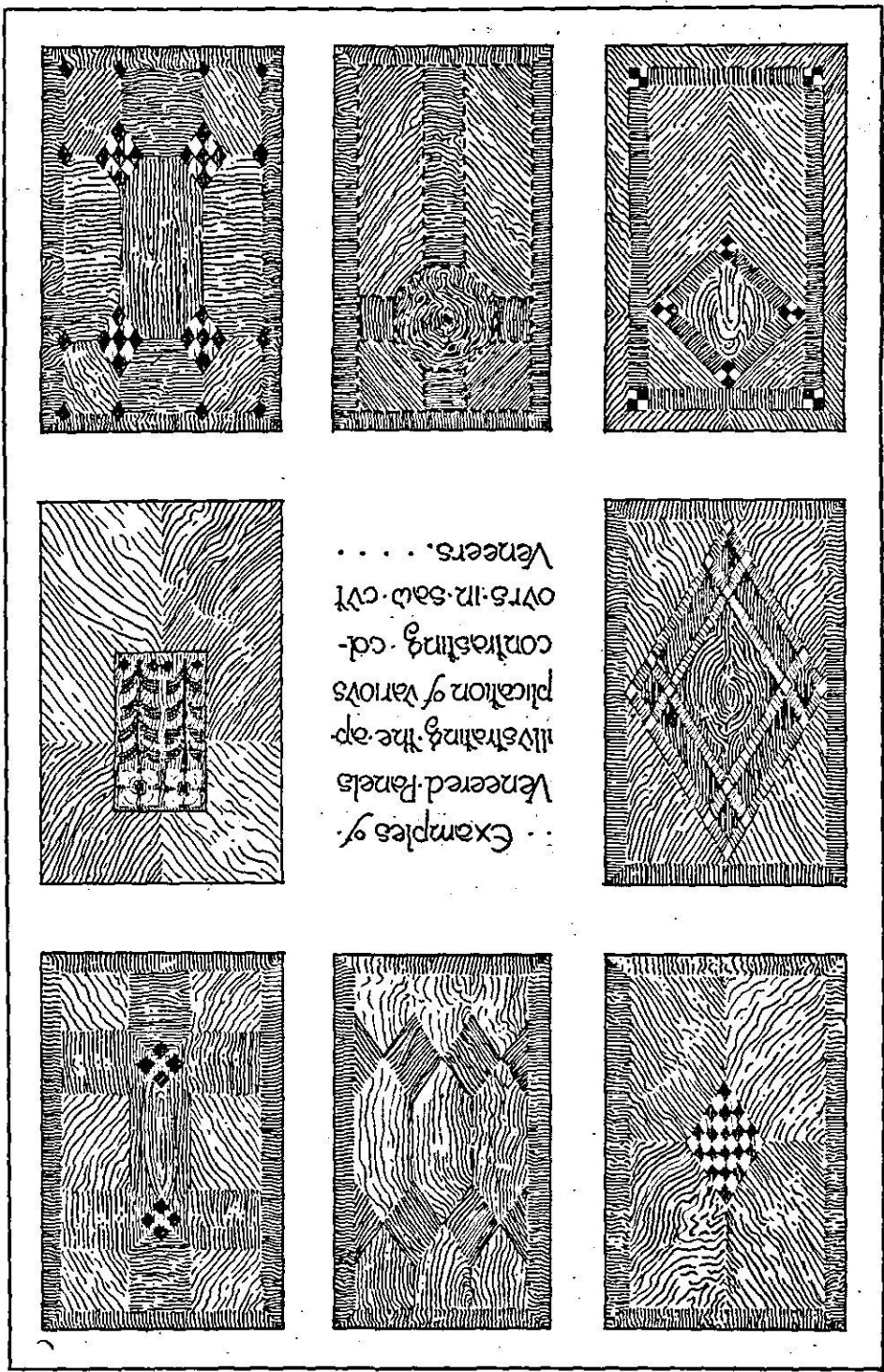

Examples of
 Veneered Panels
 illustrating the ap-
 plication of various
 contrasting col-
 ors in saw-cut
 Veneers.

FIG. 13.



Carved caskets from Lötschental, Switzerland (top, made in 1910; lower, dated 1782).



Carved box from Bohuslan, Sweden.
FIG. 13A.



Carved cupboard from Dalarna, Sweden.



Carved box from Smaland, Sweden.

FIG. 13B.

ing; in this case the groundwork would be fitted and glued to paper as described, the inlaying being completed when the groundwork had been veneered; the process of inlaying would then be similar to that described for solid work earlier in the chapter.

Caul veneering is best for work of this kind, distinct from hammer veneering, suitable only for light knife-cut veneers. A caul should be made from $\frac{3}{4}$ in. pine, rather larger than the surface to be veneered.

The groundwork is well toothed and sized, and when quite dry it is covered with glue, this being allowed to chill before placing the veneer in position with the paper uppermost. The veneer should be secured with one or two veneer pins driven in close to the edge, and then a piece of paper is laid over the paper on the back of the veneer in order to prevent the spare glue sticking to the caul. The latter should be thoroughly heated and then placed over the veneer and firmly handscrewed all together, this causes the glue to run and the pressure applied forces all the spare glue out. The work should remain in the handscrews at least twenty-four hours. When quite dry the pressure is removed and the top paper removed by toothing, or damping down and scraping with a chisel.

Veneering, consisting of hammer and caul veneering, cannot be fully dealt with in a work of this size, and readers are referred to Wells and Hooper's "Modern Cabinet Work" for further details of this process.

DECORATIVE PROCESSES IN METALWORK.

Appliqué or Applied Ornament.—Rosettes, wreaths, medallions, and enamels are often applied to plain surfaces, and all except the enamels could be fixed by brazing, silver soldering, soft soldering, or riveting, the rivets being shown as part of the decoration as illustrated in Ch. vi, Fig. 8 (2) or hidden (secret riveting). Some old Gothic ironwork has been done by piercing the ornament out of thick metal and riveting it on to a plain background, which gives a very fine effect. In some Spanish work of this kind the effect was heightened by laying on the background a piece of red leather or velvet and then fixing on the pierced work. *Doors were decorated in this manner and must have looked very rich and beautiful.*

Where a number of the same small ornaments are to be applied, they may either be cast from a pattern, or stamped with a die. If the design is cut in a piece of iron or steel the reverse shape to that which is required, really making an intaglio, soft metal is easily hammered into the die so formed without the aid of a press.

Another method is to lay a piece of very thin metal on the die, then on this a piece of lead and hammer both into the die, then take out and trim off superfluous metal. In this way quite nice clean ornaments can be made. This is a very ancient method of making small ornaments, borderings, pearlings, etc. When making the die the progress can be seen by wetting the die slightly and squeezing modelling wax into the sunk portion, the wax impression when removed

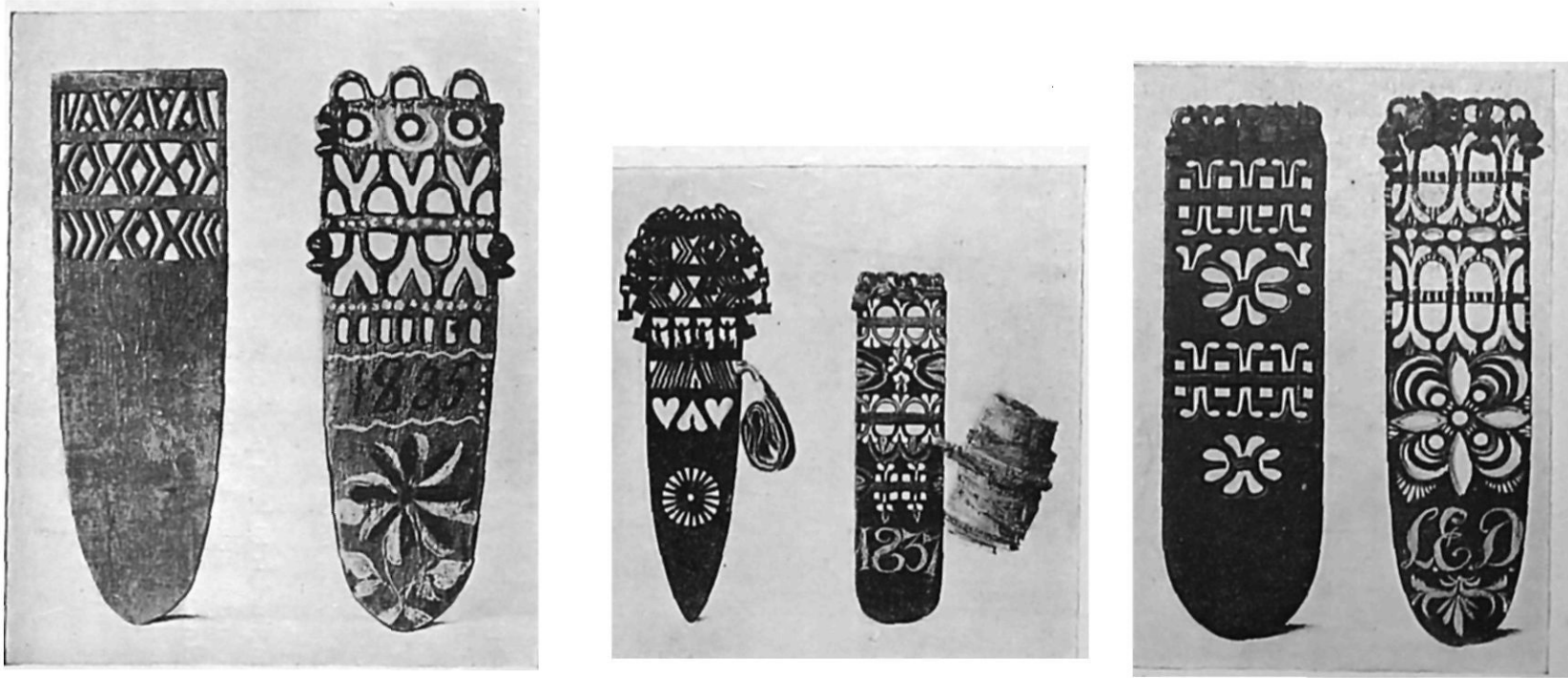

FIG. 13c.—Carved and painted spinning implements from Dalarne, Sweden.

giving the object in relief. Ornaments can also be fixed by screws, but there is always the liability of their working loose. When the appliqué is of china, glass, or enamel, a setting has to be made and fixed to the background, the enamel inserted and the edges of the setting pressed or burnished down on to the enamel; sometimes a loose setting can be made which, holding the object independently, can then be screwed or riveted to the base, so avoiding the burnishing down of the edges of the setting on to the pearl, stone, or enamel.

Bidri Ware.—There is another form of inlaid work which is called Bidri ware, as it was made at Bidar, a city north-west of Hyderabad.

The articles are cast in pewter and the designs are chiselled out and silver hammered in. It is blackened by the application of a solution of salammoniac, saltpetre, salt, and copper sulphate. The design is then rubbed up and the ornament is left in white on a black background. Niello is black on a white background.

Bronzing or Metal Colouring is an art which produces very beautiful results on metallic objects, and to obtain an insight of what is possible in this direction the work that has been executed by the Japanese should be well studied. They are certainly unrivalled in this branch of metalwork. The chemical colouring or bronzing of metals requires a knowledge of metallurgy and chemistry, and to produce beautiful results the possession of artistic taste on the part of the operator. The colouring of the object is affected by the purity or otherwise of the metal, the temperature of the solution used, as well as by the purity or impurity of the chemicals used in making up the bath.

The most important point in connexion with the bronzing of metals is that they must be scrupulously clean and of a uniform colour and smoothness before being immersed in the bronzing solution.

Any article made of brass, bronze, gunmetal, or similar alloy may be brought to many shades of brown by the following method: Thoroughly clean the object by boiling in a strong caustic potash solution and well rinsing in three waters; then dip in a solution of nitric acid 2 parts, sulphuric acid 1 part, hydrochloric acid $\frac{1}{2}$ pint to each gallon of dip. Again rinse well in three waters. If the object does not come up a bright uniform colour, well scrub with silver sand and water and repeat the acid dip. When a nice bright colour, dip in a solution of a quarter of an ounce of potassium sulphide to one gallon of boiling water, if it does not come right the first time scour with silver sand and water, and repeat the dip in the sulphide solution; to produce a very dark shade wipe over with a piece of rag that has been dipped in a weak solution of the acid dip; swill well in two or three waters and dry out in hot sawdust. To produce a blue colour as well as a variety of shades of brown, clean, scour, and dip, as described above, and dip in a boiling solution of hyposulphite of soda 4 oz., acetate of lead 2 oz., water 1 gal. Dissolve these separately and add the lead solution to the hypo solution. To produce a steel colour, clean, scour, and dip as before, and immerse in a solution made as follows: Arsenic 8 oz., blue copperas 2 oz.,

carbonate of iron 2 oz., verdigris 2 oz., spirits of salts 7 lb., then scour well with sand and water and repeat and dry out in hot sawdust. If the colour is too light, blacklead as you would a stove. This can now be turned a dark green if required by lacquering with green lacquer. All these bronzes when finished should be brushed over with beeswax or lacquered.

To redden brass articles to match copper, clean, scour, and dip as before, wrap up the article well in thin iron wire and immerse for a short time in the old acid dip. That is, the acid dip that has become too weak to give the bright colour owing to use, but is still used for pickling.

Note—The potassium sulphide should be in dark greenish-yellow lumps and be kept in an airtight bottle.

Chasing and carving usually go together, as ornamental work that is made in the solid is usually, if made in iron, forged as near as possible to the shape required, then chiselled out and finally smoothed up with punches and bent files called rifiers. Figures that have been cast are finished off by the latter process. Men who do this kind of work are called "Chasers," but they can usually do embossing as well as modelling (this class of work is really modelling in metal). An example of this kind which would be modelled, cast, and then chased is illustrated in Ch. XII, Fig 12, p. 172.

Damascening is the term usually applied to metalwork that has been inlaid with gold or silver, and is of Oriental origin, and was established at Damascus during the reign of the Emperor Domitian, first century A.D. The word is also applied to work which is made of a peculiar kind of steel of a watered or striated appearance. This appearance is obtained by welding together a piece of iron and steel. By repeated twisting, doubling over, and welding together a pattern is obtained which is brought out by the application of sulphuric acid and water.

Another method of damascening which is not such a good one as that indicated above, but was largely practised in later times, is to cross-hatch the whole of the design to be inlaid with a graver which leaves a number of sharp points. Gold leaf is then applied in successive layers and burnished down on to the points, which keys the metal to the ground.

Fine wire can also be applied in the same manner, working out the design as you go along, tapping the wire down with a light hammer which keys it into position. But this is really a form of onlaying, not inlaying. Another method which gives the effect of damascened work is stencilling the spaces of the design with a compound which is not affected by acids and electroplating the object with gold or silver.

Electroplating, or the electro deposition of metals, is coating one metal with another by means of the electric current, and the process is roughly as follows: The article to be electroplated is first thoroughly cleansed by washing in a hot solution of caustic soda and then suspended on a copper wire which is fastened to a copper rod, resting on the edges of a tank containing a solution

of the metal to be deposited. There is a similar rod or set of rods at the other end of the tank which holds suspended in the solution a series of plates or anodes, as they are called, of the metal to be deposited. The path the electricity takes is through the rods and pieces of metal called the anodes, then through the solution to the articles to be plated which are called the cathodes, and through the articles back to the dynamo or battery, when the process is finished or enough metal has been deposited on the articles, they are taken from the solution, washed, scratch brushed, and finished. The thickness or amount of the metal deposited is measured by weighing the article before and after plating, or by the time it is in the bath. The metals mostly used for electro deposition are gold, silver, copper, nickel, cobalt, brass, and zinc.

Embossed Work.—Punch decoration or repoussé work is that kind of work on which designs are raised from the back by means of punches and hammers of many shapes and sizes. The work is usually on thin metal, and is either laid loosely or fixed on a bed of some substance which allows the metal to give, e.g. soft wood, pitch, plasticine, wax, block of lead, a bag of sand or plaster. The design is drawn on the metal and then scribed in so that as the work proceeds the outline remains visible. When high relief is desired it is better to raise the high parts with a hammer, laying the metal loosely on a sand bag; when the necessary amount of relief is obtained the work should be stuck on a bed of pitch, and worked up with punches. A good example of hammered and repoussé work is the silver jug illustrated in Ch. VIII, Fig. 5 (1). This is from the Victoria and Albert Museum; other examples of this kind of work are also shown in Fig. 5.

Enamelling.—This is the name given to vitrified substances applied chiefly to the surfaces of metals. It is executed in various ways and styles, and is known as *Plain enamelling*, which is simply the application of opaque or translucent colour in the form of a pattern, etc.

In *Champlevé enamelling* the design is cut out of the solid metal, leaving thin walls of metal to outline the design, and the cells thus formed are filled with the various coloured enamels.

In *Basse taille enamelling* the same process is gone through as in *champlevé enamelling*, but in addition the bottoms of the cells or divisions are modelled in relief, so giving greater depth and play of light to the enamel the cells are filled with

In *Cloisonné enamelling* the design is laid out by means of applying to a smooth groundwork a piece or pieces of rectangular or triangular wire forming or outlining the design, which are silver soldered down on to the groundwork and then the hollows are filled with enamel; in some instances the cloisons are held in position by the enamel only. This is really a modification, or an easier method, of obtaining a result similar to *champlevé enamelling*.

Plique à jour enamelling is enamelling or enamelled work that can be seen through, simply a network comprising the design and the spaces filled in with various coloured enamels which are translucent. When the spaces in the design

are small the object can be fired without a support to hold the enamel in its place, but where this is not possible the object has to be laid on a back or support made of some material such as platinum that will not stick or fuse at the temperature at which the enamel melts. Enamelled work can be done on gold, silver, copper, and gilding metal, but the best results are obtained on gold or silver, though often the colours have to be toned down to prevent them looking harsh and raw. When enamelling on other metals which are not so brilliant, *paillons* are often used to lighten up the design, these are simply pieces of gold or silver foil laid on the enamel, fired, and then covered with more enamel. By this means a reflected light is obtained which can be toned down to suit the design. Enamel in the sense in which it is used here means coloured glass that is fused on the metal, and there is nothing to compare with it for brilliant and beautiful effects. It is one of the decorative arts seen at its best in association with metal work. Hinges, handles, bell pushes, switch covers, finger plates, brackets, fenders, *jardinières*, grilles, altar rails, candlesticks, etc., could all be made most decorative by the right use of good enamelled work.

To obtain the best results an enamelling furnace must be used, that is a furnace constructed specially for this purpose and heated either by gas or benzene according to the system that is desired.

The enamel which is supplied in the lump or ground to a certain fineness as required must be thoroughly washed (this is one of the most important processes) and the metal base, which must also be scrupulously clean (scraped for preference), is slightly domed, and the enamel in form of a powder which has been wetted with some thin gum tragacanth if necessary, to make it adhere to the metal, is applied to the back and front of the work with a spatula and well pressed down to form a firm and even coating. This is thoroughly dried and then placed in the muffle of the furnace when the furnace is at the right heat, and baked until the enamel has fused. It is then taken out and left to cool. This process is repeated until the operator is satisfied.

Engraved and Punched Decoration.—Decorative processes in metalwork date back to very remote times, and the early tools and objects in metal in our museums show how decorative effects can be produced by very simple means. The early forms of decoration consisted of series of lines arranged to form a definite pattern, often of a geometric character. Dots of various sizes punched either from the front or back were often arranged in the same manner, roughly shaped bumps were hammered up from the back in thin metal and then these shaped bumps were outlined on the front with engraved lines which gave the form required. The bronze-plated doors of Shalmaneser II, now in the British Museum, and made about 859-824 B.C., are decorated in this manner. A very early example of decoration by means of engraved lines is the bronze pin shown in Fig. 14, p. 197, and the bronze shield Fig. 14 on the same page shows also an early specimen decorated by *bosses*. The silver plate or dish in Fig. 5, Ch. VIII, from the Victoria and Albert Museum, of a much later date, shows alternate decoration by

a similar process, and the wider range of sizes makes it most effective. The gold petrel illustrated in Fig. 14, now in the gold room of the British Museum, is another example of the possibilities of decoration by means of different-sized punches of various shapes, and the finger plates shown in Ch. VII, Fig. 6, show how

an arrangement of bosses and engraved lines can be made effective and suitable for modern requirements. Further applications of these simple processes are illustrated in Ch. VII, Fig. 7.

Engraving is cutting a design with a graver or burin, but it can be done with other tools which produce a similar effect. In some kinds of engraving the tool is fixed into a handle of wood and used by hand, but in other kinds of work it is used like a chisel and hit with a hammer. In memorial tablets the design is cut by the latter method, and different-shaped chisels are used, depending on the design and shape of the cutting. In some instances

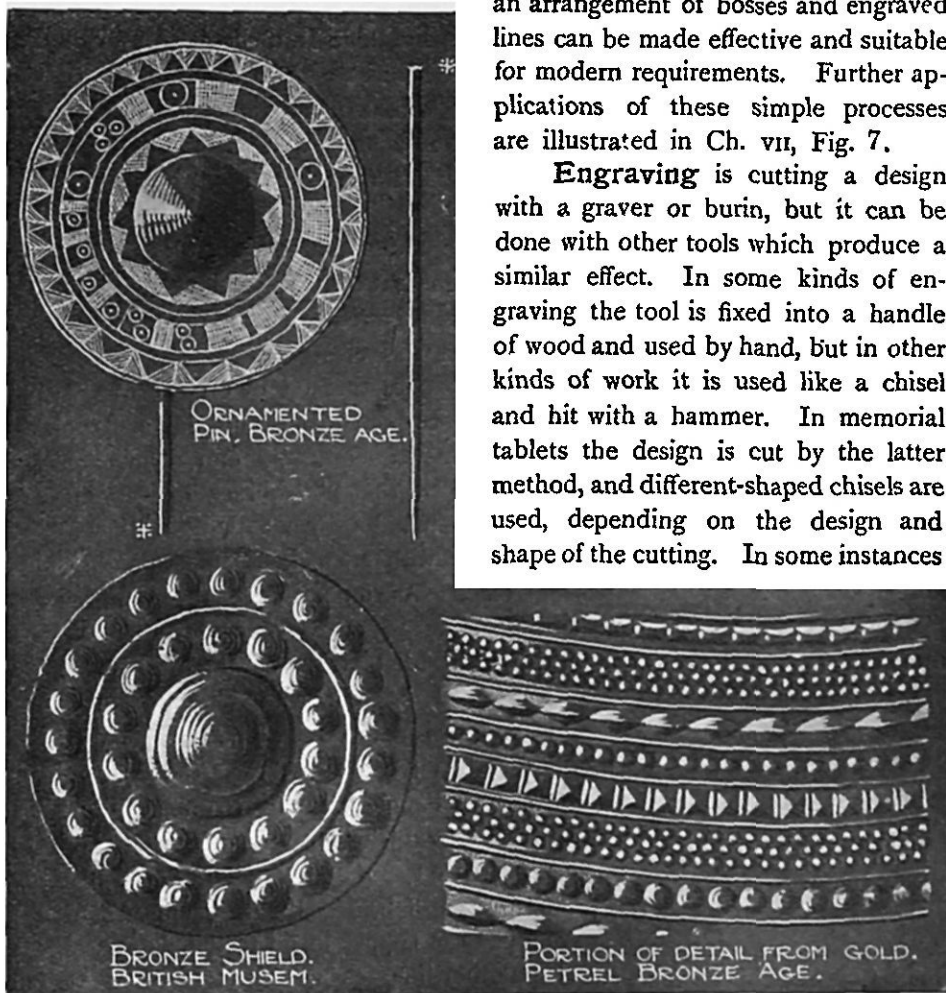

FIG. 14.—Ancient metalwork in the British Museum.

coloured wax is laid in the grooves or channels so formed. The greater part of old work, however, was cut with chisels or gravers leaving vee section lines of various widths. Some modern work is done with a machine called a *Router*, which cuts away the groundwork leaving the letters or ornament in relief.

Filigree.—This consists mainly of round wires, soldered together in various patterns, sometimes, with little metal balls and little leaves soldered to the ends of the wires, producing a most charming effect. Variations of this is where two pieces of wire are twisted together forming a kind of rope, using this

instead of the single wire, and also where the filigree work is fastened to a background.

Gilding is not always applied to metalwork by electro deposition, as gates, railings, signs, weather vanes, etc., are ornamented by applying gold size, and when this becomes tacky gold leaf is laid on. This is very durable when properly done and good quality gold used. It is also done in a cheaper way by using gold powder or imitation gold leaf, but this has to be varnished with a transparent varnish to last, and when this is affected by the weather the alloy underneath turns black. The same method is used for applying copper, silver, and bronze powders of various colours and is known as bronzing, but it is only a sham bronzing.

Another method of gilding, called fire gilding or mercurial gilding, is to cover the article with an amalgam of gold and then heat to volatilize the mercury; afterwards dip and scratch brush or polish as required. This is the most durable method of gilding, but it is also the most expensive.

Inlaying.—This very ancient and historic method of ornamenting metal produced some remarkable examples of craftsmanship, and the many pieces of work shown in the British Museum of Saracenic and Persian origin should be well studied, so that an idea of the possibilities of this kind of work may be obtained. Metal can be inlaid with metal, or with coloured wax, or with coloured stones or gems, or with enamel. Damascening, niello, and Bidri work are forms of inlaying. As for example the Celtic finger plate Ch. vii, Fig. 7 (10), instead of being raised as shown, could have the same design worked out with two parallel strips or threads of copper. When inlaying wire only a groove need be cut with chisel shaped and

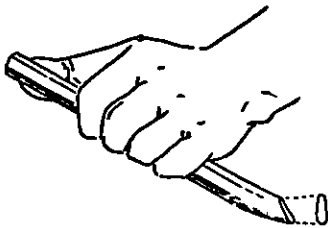

FIG. 15.—Method of holding an engraving chisel.

held as shown in Fig. 15. The wire is annealed and placed in the groove; then the edges of the groove are hammered down on to the wire, the work is planished up from the back and the face finished off as required. The Tudor plate on p. 89, instead of having the rose embossed could have a plate of copper inlaid to the outside shape, and the other lines giving the form could be engraved on the copper plate after it was inlaid. The stars in the memorial tablet illustrated in Ch. xii are of silver inlaid, and show up well against the rich coloured copper.

When wax is to be inlaid the design is cut away, leaving a wall of metal all round, and the wax, which should be of brittle character, is powdered fine and the cells filled with it, then the object is warmed so that the wax melts and fills in the design. This operation is repeated until the cells are filled; the plate is then cleaned up with pumice stone, or Water-of-Ayr stone, and polished. The memorial tablet shown in Ch. xii has been done in this manner. Fusible metal could also be used in the same manner.

Lacquering.—Though this is a method of decorating metals it really comes under the finishing or preserving of metal surfaces. See chapter on “Finishing Metal Objects,” pp 222-223.

Metal Spinning.—This process deals with the working up of thin sheet metal on a lathe, and only applies to what is known as hollow ware. It is a cheaper and quicker method of making such things as reflectors, tea and coffee pots, bowls, cups, bases for candlesticks and lamps, etc. It consists of turning a wood or metal chuck to the shape required, and then fixing between the chuck and back-centre of the lathe a flat circular piece of metal. The lathe is then put in motion, and with a steel burnisher, which is in a long handle and held in the hand and under the arm of the operator, the metal is burnished down on to the chuck. To prevent wrinkles being formed in the metal while it is being spun or burnished down on to the chuck, a flat piece of steel is held up against the back of the metal by the left hand of the worker. In spinning deep articles the metal has to be frequently annealed. Spinning requires a great deal of skill and knowledge of materials to avoid making “wasters,” as they are called. Spun work is often further decorated by etching, that is, a design is drawn or stencilled on the spinning and the spaces are eaten away with acid; this is known as etched work. Stamping has to a certain extent supplanted spinning, but sometimes the work is partially stamped and then finished by spinning.

Niello is the name given to those articles of gold and silver which have the design engraved, and the engraved lines filled with a black composition composed of silver, copper, lead, and sulphur, which is made up separately and powdered very fine. This powder is applied to the metal with borax which acts as a flux; the article is then heated, the compound liquefies and runs into the hollows of the design. When cool the work is scraped over, polished or burnished, leaving the design in black upon the metal. This method is said to be the origin of engraving (printing), as when testing the work for accuracy, etc., the lines were filled with a black substance and a piece of paper was pressed on to the surface which caused the reversed design to be transferred to the paper and any faults could be easily seen. Tommaso Finiguerra was the inventor, and he lived in Florence about the middle of the fifteenth century. He was skilled in niello work.

Piercing.—This is accomplished in many ways according to the material and its thickness. Thin material can be punched or pierced by means of cutting dies, or pierced by cutting out the design with a hand fret saw, or a power fret-cutting machine. Another method is to use various shaped chisels and afterwards trim up with a file.

The examples shown in Ch. VIII, Fig. 7, would be best cut out with a fret saw; if a number were required a pattern could be made in mahogany and castings made from it.

Solder Decoration.—Another method of decorating metal surfaces is to

stencil out a pattern on the object, fill the spaces with a black varnish, or some composition that is not affected by the flux and heat, scrape clean the pattern that is left by the stencil, and apply the flux and ordinary soft solder with a soldering iron, then wash the varnish off and the design in solder will be left in relief.

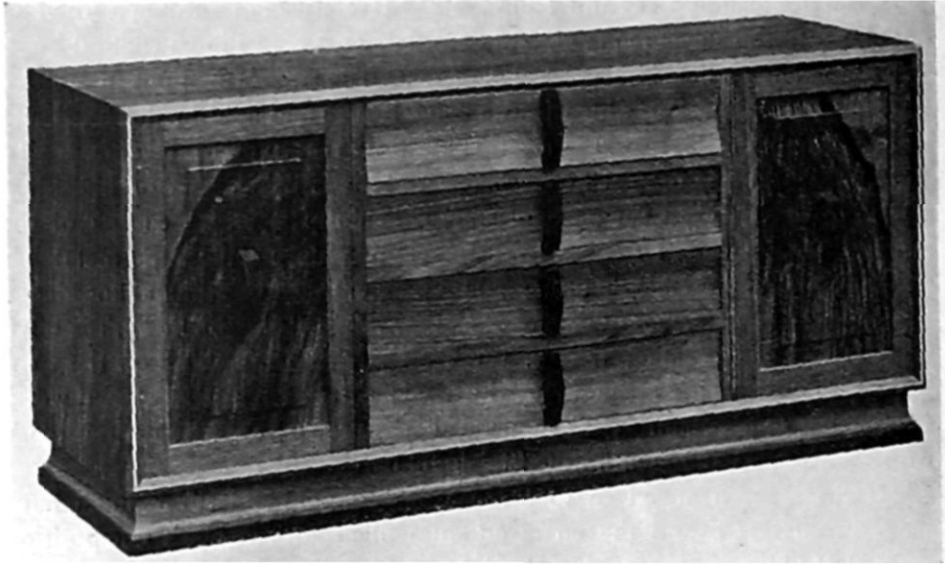

Front view.

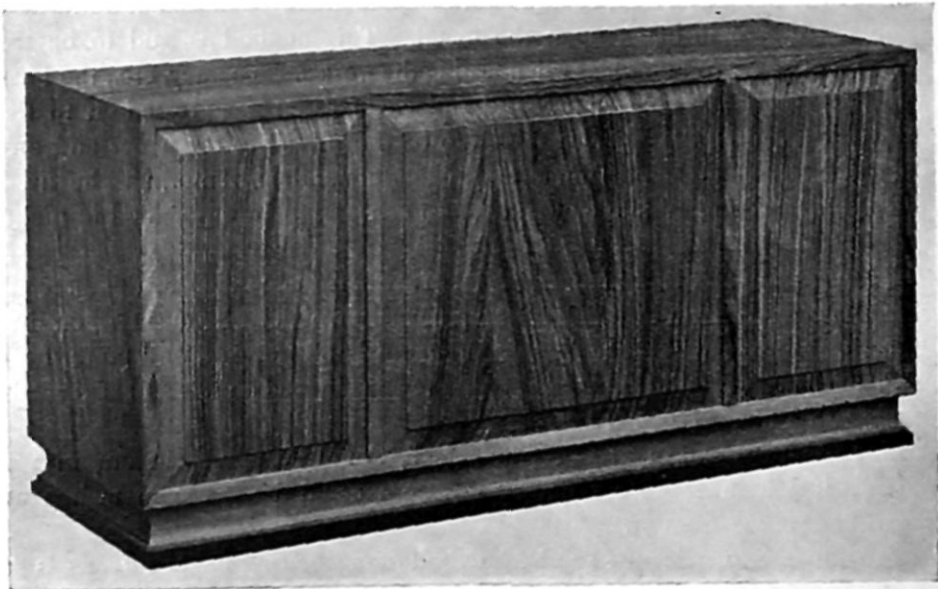

Back view.

A stationary cabinet in English walnut.

(L.C.C. Shoreditch Training College.)

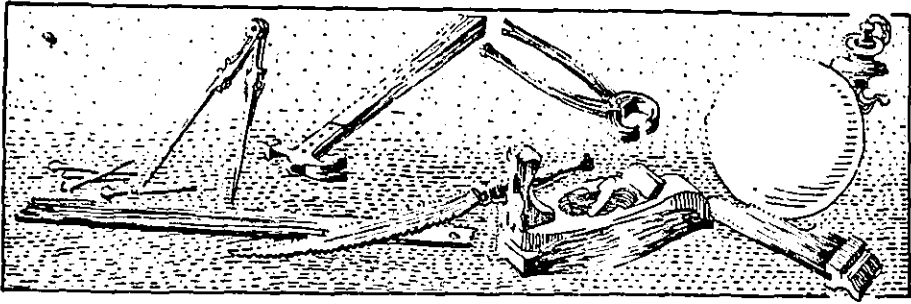

Tools of the early sixteenth century from the picture "Melancholia" by A. Durer.

CHAPTER XIV

TOOLS: THEIR EARLY FORMS & HISTORICAL DEVELOPMENT

"Without tools man is nothing, with tools he is all."—CARLYLE.

"The smith came holding in his hands the tools—the instruments of his craft, anvil and hammer and well-made pincers, wherewith he wrought the gold."—

"Odyssey," Book III.

INTRODUCTORY.

THE study of the development of tools is one, which, owing to the absence of records referring to their early uses, is necessarily difficult, and direct evolution hard to prove. Study of this subject shows that development of races and of tools may be presumed to have proceeded along very similar lines in different countries at different times. But it should be clearly understood that the definite uses of tools and implements belonging to prehistoric times is largely pure conjecture. To correctly trace *evolution* in tools is an impossible task regarding prehistoric examples, and the study of tools belonging to a particular country is necessarily largely conjecture in its early stages. It is, however, interesting to note that the "development" of tools and implements, through which may be traced the development of man, has, as indicated above, proceeded in very like ways in countries so far apart as England and Egypt. European developments, in England, Sweden, and Switzerland for instance, exhibit some remarkable sequences of development in design and material. For the purpose of object lessons to hand-craft classes the national aspects of the subject are probably sufficient, thus considerably reducing the range of the subject. It is recommended that for purposes of demonstration, wherever possible, large charcoal drawings be made from the actual examples, the drawings being made permanent by the application of some fixing solution and placed on rollers.

The Saw.—The first tool to be dealt with is the saw. Its antiquity is indicated by many classical references, and there are references in Isaiah to saws and planes. Illustrations of various saws from earliest times are shown in Fig. 1, but it should be clearly understood that these are shown as

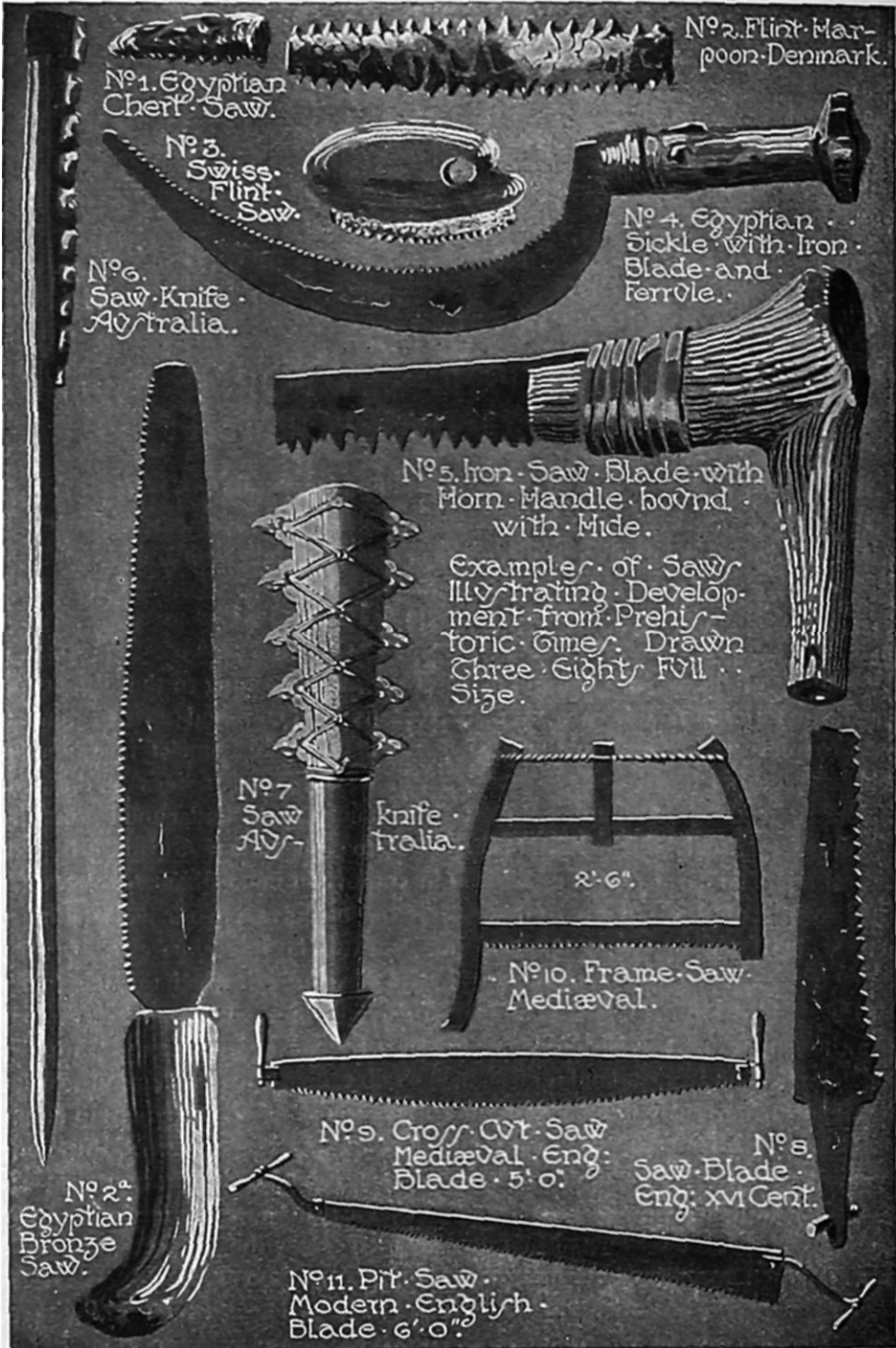

FIG. 1.

interesting examples characteristic of certain periods, rather than an attempt to show definite "evolution".

The example, Fig. 1, No. 1, shows a chert saw of Egyptian origin. Chert is a kind of stone, which here has been worked by a curious chipping process so as to produce a serrated edge. The particular uses of this type are not definitely known, but it is presumed to have been chiefly for bone and meat sawing.

No. 2 on the same page is, like the above, in the British Museum. It is a harpoon, and was produced in a fashion similar to that employed in the Egyptian chert saw. These belong to the European and Egyptian Stone Ages respectively.

No. 3 illustrates a Swiss saw, after Lubbock, the blade of which resembles the first example, and is fixed into a wooden handle. The reason for the hole is not clear. The use of this tool was probably also for bone and wood used in the early Swiss lake dwellings. The Egyptian iron saw, illustrated in No. 4 on the same page, is a particularly fine example, and appears to have been suggested by a sickle. The blade of this implement is of iron, and it is secured to the handle by insertion, with an iron ferrule for extra security. The comparative absence of timber-producing trees indicates the reason for so many early structures being made of stone, or, as is frequently the case with tombs, hewn from the solid rock. Authorities on ancient Egyptian architecture assert that timber was used to a considerable extent in prehistoric times, producing in support of this theory evidences of stone dwellings of a later period, which have obviously been inspired by earlier wooden dwellings.

No. 2a illustrates another Egyptian saw in the form of a knife with one serrated edge. It cannot be decided which is the earlier of these two types, and their uses can only be surmised.

The illustrations Nos. 6 and 7 show two saw knives of Australian origin. They consist of sharks' and animals' teeth fixed in the first case by embedding in gum. They were used more as knives than saws.

The second example of this type, No. 7, is a particularly interesting specimen, consisting of teeth laced into a wooden handle in a most ingenious fashion.

The tools shown in Nos. 5, 8, 9, 10, 11, are all of English origin. The first of the latter series is, together with No. 8, exhibited in the Guildhall Museum of the City of London.

No. 5 is prehistoric, whilst the example No. 8 was excavated in London Wall, and was probably attached to a handle by the insertion of the tang, and secured by pinning through both handle and tang, as is indicated by the example. A mediæval frame saw is illustrated in No. 10, used chiefly for cross cutting; "deeping," or splitting logs from end to end in planks, etc., was doubtless effected by means of the pit saw, the use of which still remains in country districts. A two-handled cross-cut saw is illustrated in No. 9. These were used also for splitting small logs, the latter being fixed in a vertical position. During the eighteenth century veneers also were cut in this manner, as an examination of authentic old work will show. The illustration No. 11 is of a pit saw, the use

of which is now almost entirely superseded by machine saws. It was and still is used to some extent for deep cutting a log from end to end. The log is wedged above a "pit" or well hole, and one sawyer is above the log, the other below. The cut is made on the downward stroke, and it is necessarily a tedious process compared with up-to-date vertical frame sawing, by which twelve or more cuts can be made simultaneously through a log 2 ft. and upwards in diameter.

No account of saws, however brief, would be complete without mention of Japanese saws. These are fashioned as illustrated in Fig. 2, and, as will be seen from the diagram, the teeth are spaced in an opposite direction to those of English saws. They resemble large carving knives, and the cut is made on the backward stroke instead of on the forward one, as is the case with the English pattern. Native Japanese craftsmen are remarkable adepts in the use of these tools, some of which have teeth on both edges, thus combining two grades of cutting edges in one instrument. In the Pitt-Rivers Collection at Oxford are some interesting models of these tools.

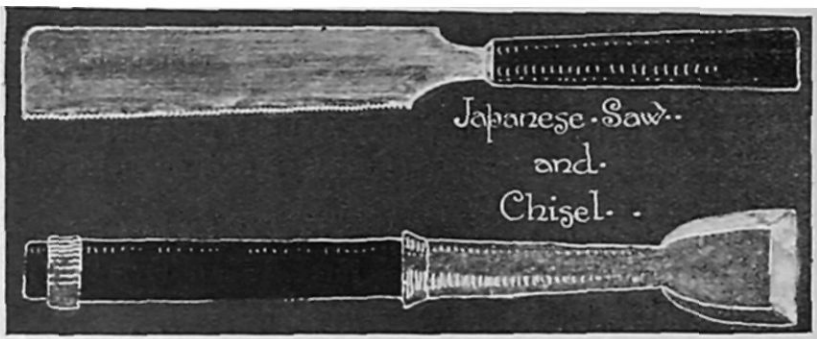

FIG. 2.

The Chisel.—The term is derived from the French word "ciseau," the Latin "seco" (I cut) having a similar meaning, and may safely be supposed to have been practically the first tool used by primitive man. It is the forerunner of the plane, and the term includes generally gouges, turning tools, and various metalworking tools. In the British Museum and other collections there are many existing examples of implements belonging to the early Stone Age which were probably used for "chiselling" and like purposes. Of these may be mentioned a "chopping tool" found at Stoke Newington and a primitive "double chisel" found at Les Eyzies, Dordogne, France, both of which are in the British Museum. They are necessarily of a very simple and crude character, being only roughly shaped pieces of pebble. The Neolithic, or later Stone Age, marks a very considerable advance in tool production; methods of hafting were introduced, and the processes of grinding and polishing the stone blades led the way to the adoption of other materials than flint and quartzite, the two latter being the chief materials employed up to this time. Reference to Fig. 3 will show two good examples of Neolithic celts of flint. One resembles a

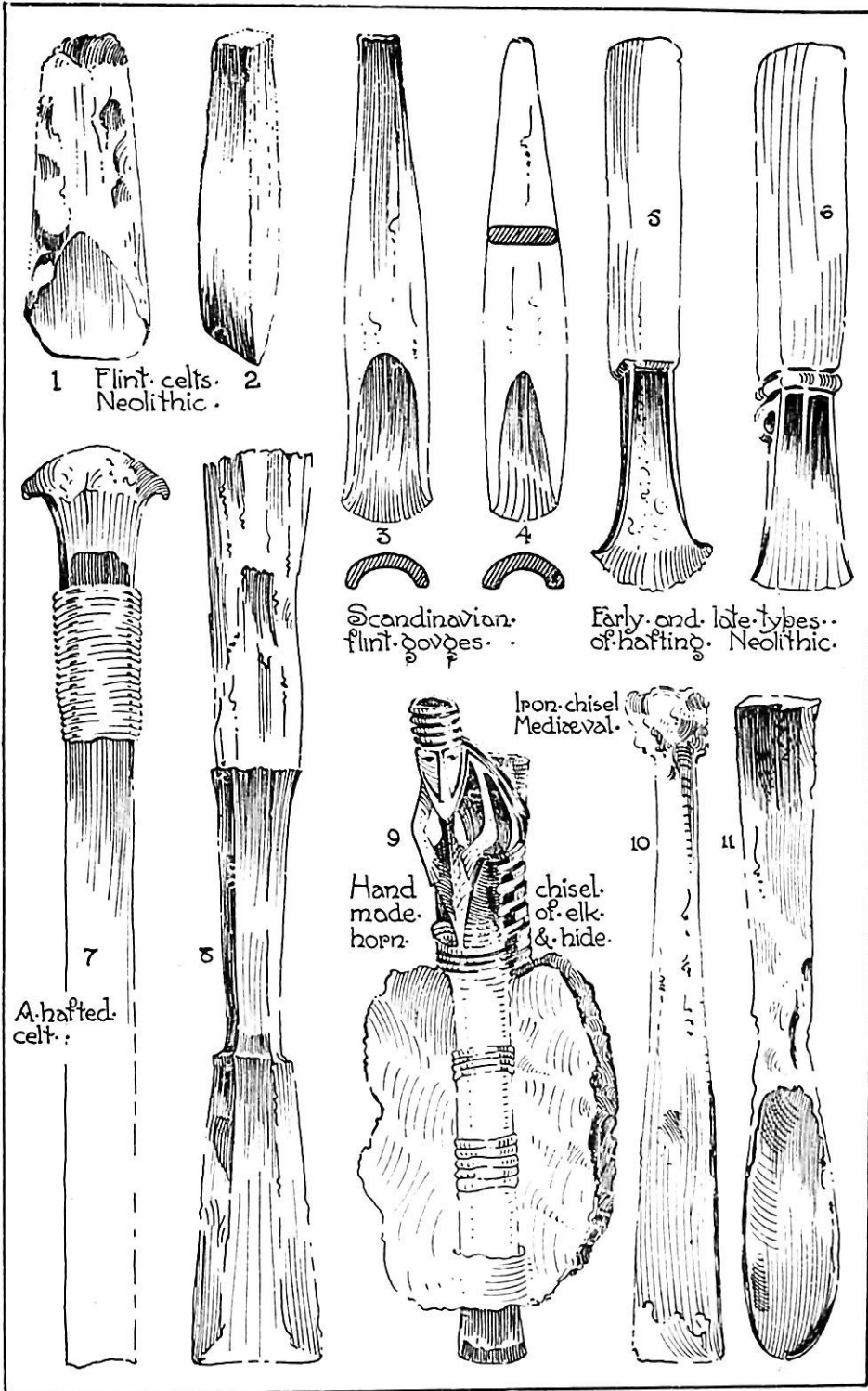

FIG. 3.

“gouge” and the other a “cold chisel”. The uses to which implements of this type were put can only be conjectured, but whether used for breaking clods of earth in agricultural operations or as weapons of defence or sustenance, the process involved would be that of “chiselling,” the implements being based upon the action of a wedge, which forms the basis of cutting actions in planes and chisels alike. Hafting proceeded differently in various countries, one interesting example in the British Museum—of Swiss origin—showing a small stone axe fixed into horn and then mounted in a wooden haft. The centre part of horn was introduced in order to lessen the risk of the handle splitting. In Fig. 3 is also shown two fine specimens of Scandinavian gouges belonging to the Neolithic period. We now come to a stage, approximately some five thousand to six thousand years ago, which marks the introduction of metal into the manufacture of primitive tools. This period is known as the Bronze Age, and it is remarkable also for the artistic character of its productions as well as the extraordinary moulds used for casting the implements. Authorities agree that the use of bronze, strangely enough, preceded that of iron. Early celts of the Bronze Age are really metal copies of their Neolithic prototypes; they were probably used more as axes than as chisels, as we understand the term. There are many evolutionary stages before the type shown in Fig. 3 (5) was reached, the expansion of the blade towards the cutting edge is accounted for by the hammering out necessary to harden the edge. The hafted celt shown in Fig. 3 (5) is drawn from an example in the British Museum, and the haft is not the original one. Both the types shown in Fig. 3 (5, 6) are known as socketed celts, that is, a socket which receives the handle is made in the butt end of the implement, this being effected by means of core casting. In some cases a loop or ear-piece was provided—as is the case with Fig. 3 (6)—which presumably was bound for greater security. The example shown in Fig. 3 (7) is an earlier one, a cleft stick received the celt, which was more firmly secured by binding with thongs of hide. Socketed celts of various types may be considered as the latest development of the implement in prehistoric times, although there are many spear-heads and swords still existing which indicate the development among implements of war. A big jump is now necessary, the next example shown being a relic of the Roman occupation of Britain, see Fig. 3 (8). This specimen is now in the Pitt-Rivers Collection at Oxford, and curiously enough, it is made on almost identical lines to the implement illustrated in Fig. 3 (5). It is obviously of wrought iron, is octagonal in section through the iron socketed part, tapering away to a hexagonal shape at the cutting edge. This was found in 1863 during excavation at the corner of Great Winchester Street, London Wall. There is also a fine example, similar in general character to it, in the Guildhall Museum.

The mediæval iron chisel illustrated in Fig. 3 (10) was found at Wapping, and belongs also to the Romano-British period. It was probably used for stone dressing, as may also have been the curious spoon-like gouge illustrated in Fig.



FIG. 4.
14

3 (11) also belonging to the period last mentioned. In Fig 3 (9) is illustrated a remarkable chisel, a hand adze, from the Pitt-Rivers Collection. It has a short steel blade fitted into a handle of elk horn elaborately carved. Two pieces of hide are attached to the stem part in order to protect the knuckles when using the chisel. It was used with a chopping action for shaping canoes. An interesting native Japanese chisel illustrated in Fig. 2 is constructed on the socketed principle, and similar in general outline to the example, Fig. 3 (8).

THE EVOLUTION OF THE HAMMER.

In Fig. 4 an attempt has been made to show the gradual development of the ordinary hand hammer from the earliest known types. The illustrations show broadly the various stages it has passed through and the many methods adopted for attaching the head to the shaft or handle. As in all human inventions progress has been made in a series of steps.

The hammer, a tool of percussion, is the most widely used of all tools. The prototype of the hammer is of course found in the clinched fist, a tool or a weapon according to circumstances, and one that man soon learned to use. When he found that this was not hard or powerful enough he would naturally look around for something better, and this he found in rounded pebbles. These were used by primitive man for many purposes, and it is only when the stone was chipped or marked by blows caused through working on a harder material that it can be recognized as having been used as a hammer.

Fig. 4, No. 1, shows a piece of flint that has been used as a hammer. It was held in the hand and is known as a hammer stone. Some hammer stones were oval in form, and others had pits or depressions chipped out of both sides for the thumb and finger to fit into so that a better grasp could be obtained. Fig. 4, No. 2, shows a hammer head of deer horn with a hole for the handle. This is in the British Museum and was found in a British barrow in association with a burnt body at Lambourn Downs, Berkshire. In the Guildhall Museum there are some hammers complete with handles made from the antlers of the red deer. Fig. 4, No. 3, is an oval stone hammer grooved for the purpose of lashing it to a handle. Similar forms were used as net sinkers, as is indicated by names and description in the Pitt-Rivers Collection at Oxford. Fig. 4, No. 4, is from the Horniman Museum, and was held in the hand. This comes from Vancouver in North America. A similar object was used in Tahiti for pounding bread fruit and called a pounder. Fig. 4, No. 5, is a quartzite hammer made from a pebble, and the hole has been made by pecking or drilling a pit on either side until the two depressions met. For drilling the holes the drill was simply a stick twirled between the palms of the hand and fed with sand and water (see Fig. 6). Some of the European specimens were perforated by means of a piece of cane twirled between the hands and fed with sand and water as illustrated in Fig. 6, No. 4. Fig. 4, No. 6, is a

decorated hammer head, and was probably not used for serious work. There is in the British Museum a broken portion of a stone hammer decorated with a number of lines arranged to form an all-over pattern, and perforated for the reception of a shaft; this was found in a Mycenæan tomb that dates back to about 1350 B.C. Fig. 4, No. 7, is a stone hammer that was found in the Thames. Fig. 4, Nos. 8 and 9, illustrate hammers of cast bronze hollow at the top end for the insertion of a shaft. That shown in No. 8 was found at Thorndon in Suffolk, and No. 9 comes from Ireland. The round heads shown in No. 9 are simply decorative. Fig. 4, No. 10, shows a limestone mould for casting hammer heads. At the bottom of the mould a depression will be noticed. This was for the reception of a core or circular piece of clay or soft stone, so that when the metal was poured into the mould it would flow round this core, and when the metal had solidified and was removed from the mould and the core taken out a hole would be left ready for the shaft. Fig. 4, No. 11, is a cast bronze hammer head about 7 in. long and $3\frac{1}{2}$ in. in diameter and has been much used. Fig. 4, No. 12, is an iron claw hammer practically the same shape as the modern tool. Fig. 4, No. 13, is also of iron, and it has a thin pene and a rectangular face. Fig. 4, No. 14, is a German claw hammer with a square face and the claws rounded on the top and decorated on the sides with engraved lines and dots. Fig. 4, No. 15, is a modern example of an engineer's or fitter's hammer made of steel with hardened face and pene. In the Guildhall Museum there are two hammer heads of interest, one is an iron war hammer, or as it is called, *Martel de fer*, of the fifteenth century. It is similar in shape to our present-day double square face planishing hammer, with the exception that the faces have nine projecting spikes about half an inch long, thus making it more of a club. The other is a Roman claw hammer of a peculiar shape and made of iron. This was found at Austin Friars.

How the hammer stone became a hammer head is not known, but nearly all the stone-headed hammers from various countries show very simple methods of hafting, and the smith of to-day holds various tools in the manner that was usual in the early centuries. The illustrations forming Fig. 5 show various methods of hafting, so that a larger amount of power can be obtained without hurting the arm or wrist. In Australia the Aborigines fixed the stone head of their hammer to a handle made from the small branch of a tree, with a kind of gum or cement (see Fig. 5, No. 1). Fig. 5, No. 2, shows how the head, which has a groove round the centre, was fastened by means of moistened strips of hide which contracted in the drying, so binding the stone head firmly to the handle. In Fig. 5, No. 3, the head is wrapped round twice with a flexible branch and tied with split rattan. Fig. 5, No. 4, is a stone hammer head with one flat side fitted to a piece of a tree from which a branch has grown out at right angles and the stone head is tied on with sennit cord. The head of Fig. 5, No. 5, is attached to the handle by means of a leather thong. Sometimes the handle and binding is in one piece, as when it is made of substance like whalebone or horn

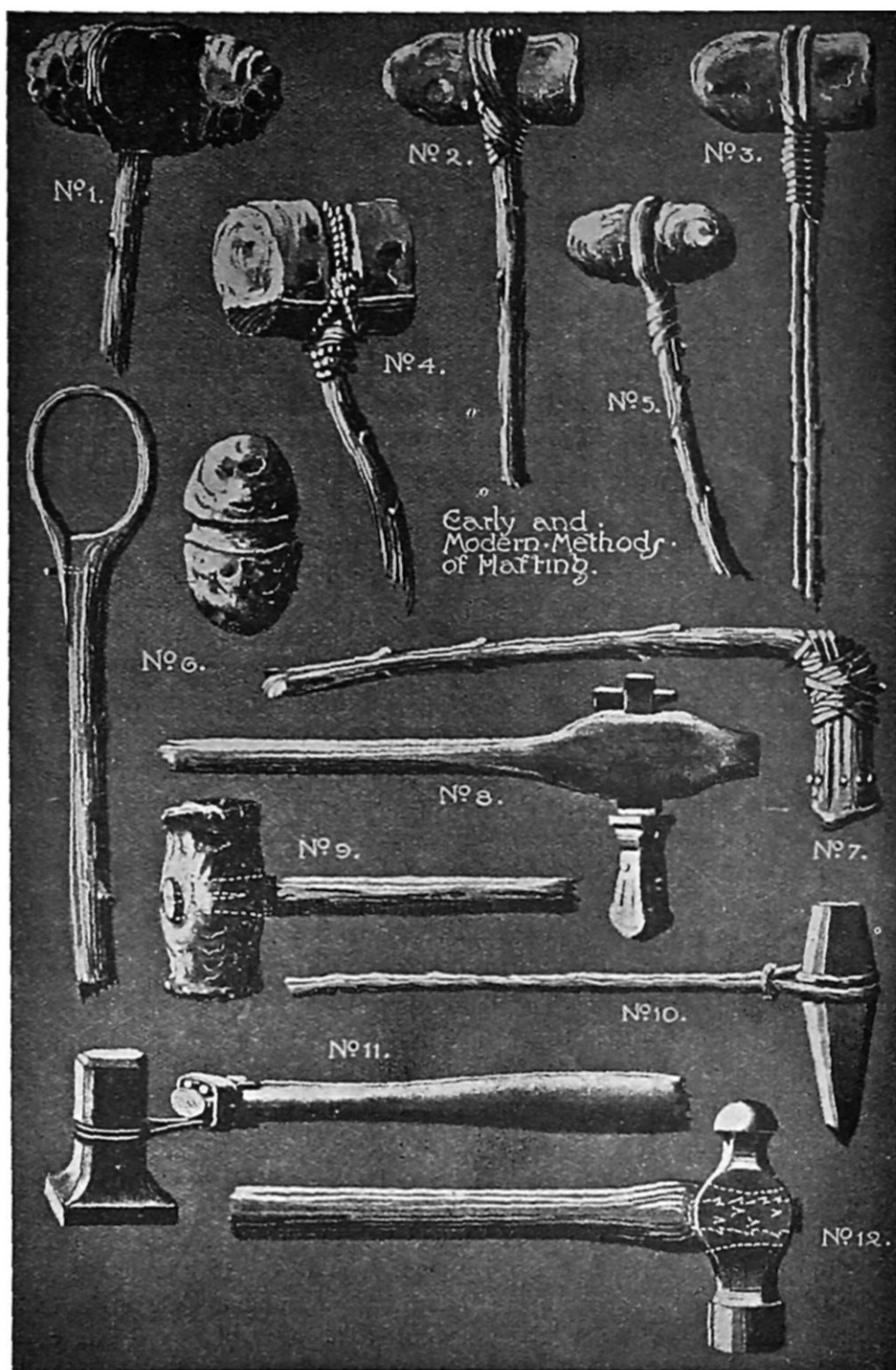

FIG. 5.—The evolution of the hammer.

and tied round the head and then round the shaft while in a pliable condition. When it dries, it hardens and is practically irremovable. Fig 5, No. 6, shows a haft of flexible wood cut away and then bent round the head and pegged down. Fig. 5, No. 7, is a right-angled branch and the end is fitted tightly into the hole left in the bronze hammer head. It is tied on with sinews or strips of hide. These bindings were very often done in quite a decorative manner. In Fig. 5, No. 8, a piece of wood is wedged into the hammer head and this is fitted to a shaped shaft that has a rectangular hole in it. The piece of wood with the hammer head fixed to it was put through the hole and kept in position by a taper wedge. Fig. 5, No. 9, has a hole right through the hammer head which is of bronze, and the end of the shaft is split and a simple taper wedge of wood driven in. In Fig 5, No. 10, a withy, or willow branch, is wound twice round the cold sett and an iron coupling or ring slipped on. Fig. 5, No 11, shows a modern method of holding a flatter. A piece of $\frac{5}{16}$ in. round iron is made red hot and bent twice round the flatter so that when it cools it holds the tool firmly. Two holes are then drilled close together in a hammer shaft, the ends of the rods are bent at right angles and put through the holes in the shaft, bent over and clinched. A collar from $\frac{3}{4} \times \frac{3}{16}$ in iron is then made and shrunk on. Fig. 5, No. 12, is a modern method of fixing an engineer's hammer to the shaft. The shaft is fitted to the eye and then cut down with a saw parallel with the head. A wedge of iron is made with a number of burrs thrown up on the faces and edges with a diamond-pointed chisel. When the wedge is driven in the burrs catch in the wood and the head does not readily work loose. This kind of hammer is made heavier at the face than at the pene end so that it will naturally assume a position in the hand with the face downward, so relieving the user from the necessity of specially forcing it into that position. In using a hammer it is essential to study the difference between a sharp blow with a light hammer and a slow blow with a heavy one, the former penetrates the farthest and gives least lateral pressure, while the latter penetrates less and spreads more.

Of modern hammers there is a great variety, and a volume could be written on this subject alone, for each particular trade has its own set, and a set comprises any number. There are also the mechanically operated hammers, such as the trip or tilt hammer, the steam hammer, and the pneumatic hammer. When one considers all the hammers, from the tiny ones used by the jeweller to the mighty steam hammer with its hundred-ton blow, we are bound to marvel at man's ingenuity.

Forms of Drilling Appliances.—A tool or appliance for making a hole is a world-wide necessity. So early was the need felt that the drill is of unknown antiquity, but the reproductions on Fig 6, p. 213, show a few methods and appliances in use in various countries, and at various times. Fig. 6, No. 1, shows a bone perforator in use in the Neolithic ages. This is in the Horniman Museum. All the early needles for sewing were of some

sort of bone or horn. Fig. 6, No. 2, is a "Firedrill," and although it does not bore a hole as we understand the term, it could be used to make a hole when other appliances were not available, and was the primitive method of getting fire before the introduction of flint and steel. Fig. 6, No. 3, is a drawing of a bow drill from the sculptures at Thebes, and as this city was at the height of its prosperity in 1600 to 800 B.C., some idea can be gained of the age of a tool for drilling holes. In the Pitt-Rivers Collection at Oxford there is a drawing, taken from a fresco in Egypt, of a man using the same kind of drill, and boring a hole in a chair with it, the worker sitting down on a stool while boring. In the Horniman Museum there is a fire-making bow drill, the bow of which is the rib of a walrus, and the thong of hide. Fig. 6, No. 4, shows the ancient method adopted for boring holes in stone, but it must have been very laborious. In Fig. 4 some hammer heads are shown which have been perforated in this manner. Fig. 6, No. 5, is known as a mouth or strap drill for fire-making and has been used in Alaska, North America. The shaped piece at the top is held between the teeth, and in some instances a piece of bone or stone is inlet to take the point of the rod and so prevent it slipping or firing by the circular motion. The strap is simply a piece of hide tied round pieces of bone that can be held conveniently in the hand. The circular motion is obtained by pulling each end of the strap alternately. Fig. 6, No. 6, is a pump drill of very primitive construction; the centre rod is a piece of cane with a circular piece of wood called a whorl wedged in position. The cross bar is a flat piece of wood with a hole to take the rod, and the ends are held by a piece of skin tied to the top of the centre rod. The point or drill is a piece of shell tied on with a piece of wet skin which in drying contracts. The motion, which is backwards and forwards, is obtained by holding and working the cross bar up and down with one hand; this was in use among the Pueblo Indians of New Mexico. The same pattern is now used by saw-piercers, jewellers, and china drillers, the only difference being that they are made with a steel downrod and a brass whorl, the cross bar being connected by a thin cord. A similar drill used by jewellers, called a centrifugal drill, is arranged to turn continually in one direction, and instead of a solid brass whorl, they have a bar going through the down rod with a solid brass ball at each end, and the motion is obtained by the same action as in the Archimedean drill in Fig. 6, No. 9.

Fig. 6, No. 7, is a wood brace, made in 1760, to be seen in the Pitt-Rivers Collection at Oxford.

Fig. 6, No. 8.—This is a bow or fiddle drill of wood and of Indian manufacture. It is modern work, nicely made, and of good shape. The cutting edge of the drill is peculiar, as it is in the form of a vee, so it has a scraping action when in use. This form of drill stock is at the present time largely used for certain work, and it is called a fiddle drill. In the above-mentioned collection at Oxford some primitive lathes based on this form of drill are to be seen. There is no doubt that this form of drill suggested our lathes, through such

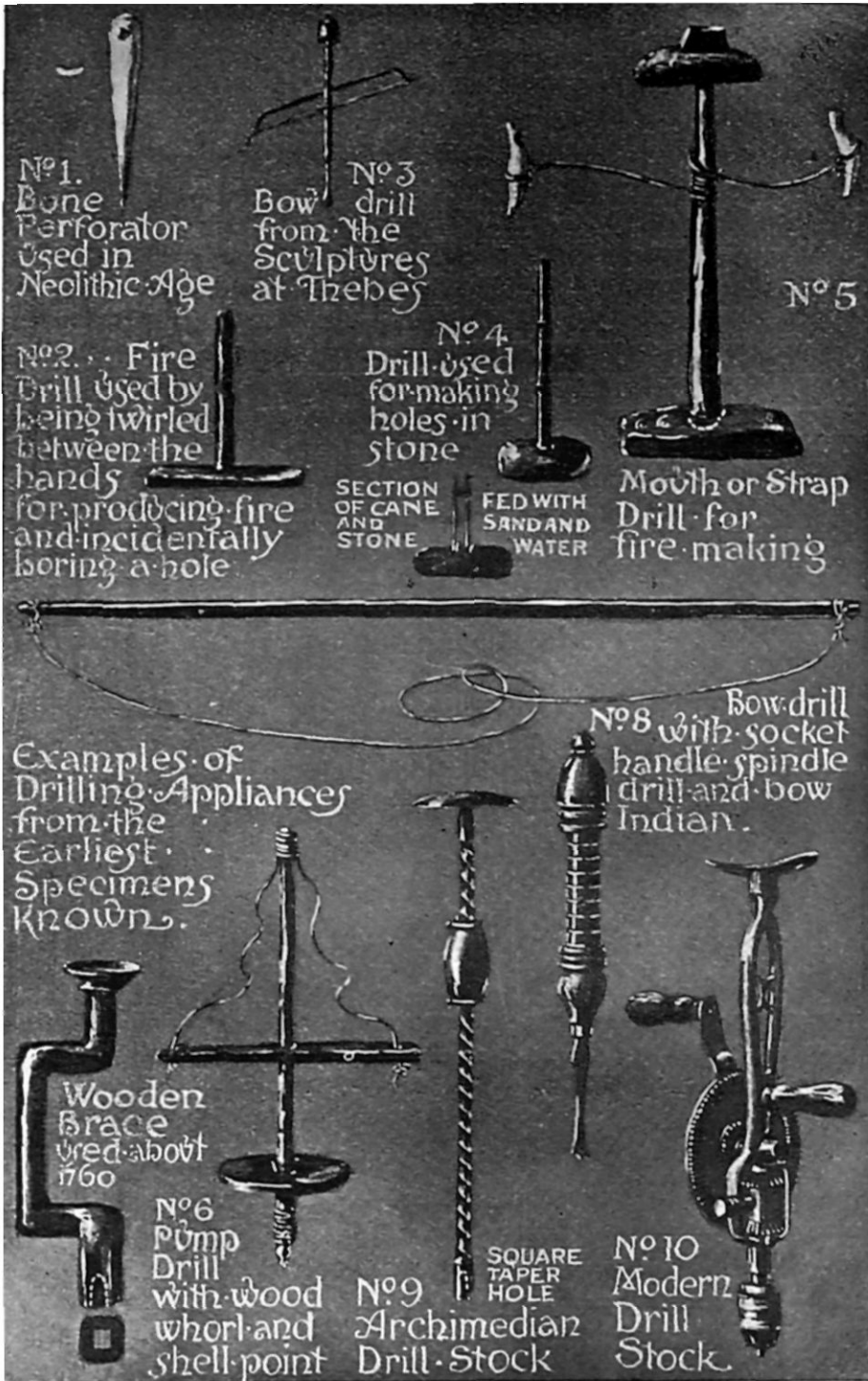

FIG. 6.

forms as the old tree lathe, the spring pole lathe, and Berson's lathe, all which work on the same simple principle.

Fig. 6, No. 9, is the simplest form of an Archimedean drill, named, it need hardly be pointed out, after the supposed inventor of the screw, Archimedes, who lived 250 B.C. This drill stock is of square iron twisted, and the travelling hand-piece of gunmetal is cast on. The top works on a tenon on the twisted rod. The bottom of the rod has a square hole to hold the drills.

Fig. 6, No. 10, shows a modern hand or breast drill geared to two speeds. It has a universal three-jaw chuck to hold the drill. The original ones of this pattern were called Millar's Falls drills, after the place where they were made. In addition to the above drills and materials used as drills, operations have revealed that tubular drills set with emery were used in ancient Egypt. Needless to say, diamonds have replaced emery in the modern development of the tubular drill.



Seventeenth-century smoothing plane.

(*Deutsches Museum, Munich.*)

CHAPTER XV

SUPPLEMENTARY PROCESSES AND DATA FOR OBJECT LESSONS ON METALS

HARDENING AND TEMPERING OF METALS.

THIS may be accomplished in many ways according to the nature of the material. Nearly all metals can be hardened by rolling, hammering, stretching, bending, or by the addition of other metals. They can also be annealed or softened by heating to various temperatures and subsequent cooling. The longer steel is in cooling, within reason of course, the softer it becomes. What is known as spring brass, hard-rolled copper, and hard-rolled phosphor bronze, are hardened by rolling. Wrought iron and mild steel can be hardened by case hardening, i.e. the surface or skin is hardened and the interior left soft. This is a most useful combination in many instances. It is done as follows: The article to be case hardened is placed in an iron box containing substances rich in carbon, such as powdered charcoal, horns, bones, leather cuttings, etc.; the box is then luted up with clay and made airtight, put into a furnace and kept at a red heat until the objects have absorbed sufficient carbon. This may take from one hour upwards. The objects are then dumped into a tank of water which is kept agitated. Small objects may be case hardened by heating to a red heat, then rolling in yellow prussiate of potash, which fuses on the surface; on being reheated the mass is quenched in cold water. This operation has to be repeated until the necessary hardness is obtained. Cast iron can only be hardened by being chilled.

Carbon Tool Steel can be hardened, tempered, and annealed, and these properties make it universally useful. It can be hardened by heating to a bright red heat and quenching in water, brine, oils, fat, wax, lead, and mercury. But the various kinds of *tool* steel vary as to the heat required to obtain the best results. Tempering is bringing the hardened steel to a temper or proper degree of hardness or toughness by reheating after hardening. The temper is judged by the colour of the film of oxide on the brightened surface. It is always necessary to brighten the tool after hardening. To anneal is to soften by heating and cooling slowly by burying in ashes or lime. The oxides seen in colours on the brightened surface of steel while it is being tempered are combinations of the oxygen of the air with the metal.

Stainless Steel.—Stainless steel is an alloy steel containing carbon up to 1 per cent., chromium 12 to 14 per cent., pure iron 85.87 per cent. The

chromium is added as ferro-chromium. To harden this steel it is recommended that temperatures between 950° and 1000° C. be used. Ordinary tool steel is hardened at a red heat. Stainless steel should be taken to an orange yellow heat. This metal in sheet form is difficult to work owing to its hardness.

Non-Tempering Steel.—This is simply carbon tool steel which is used for chisels and like tools; it is hardened by dipping right out in cold water from a cherry red, and as the name implies it does not have to be tempered.

Point hardening is a method sometimes adopted for hardening chisels and similar tools and is conducted as follows: The chisel is heated for about 2 in. from the cutting edge; the point is placed in water to a depth of three-quarters of an inch until cold; the chisel is then taken out and the point is rubbed with a piece of grit stone until bright; the heat from the remaining portion runs back to the point, and when the cutting edge is the right colour it is cooled right out. In oven tempering, ovens are used for tempering tools right through and in some cases is preferable. The ovens are very reliable and can be heated to any known degree of temperature. In small shops where expensive appliances are not available, tempering is done with a gas blowpipe or on a sand bath, which is very useful and simple. A metal box is filled with fine sand and placed on the fire or a gas stove. The tool is hardened and brightened and then laid in the hot sand and turned over and over until the correct temper is obtained. Another method is to heat a piece of iron and lay the tool on it. Lead, tin, and bismuth, alloys are also used. A bath of the molten metal is made and the articles to be tempered are immersed in it. The molten metal can be tested with a pyrometer and very accurate tempering can be accomplished. For very small tools a piece of pipe can be made hot and the article held inside until the right colour is obtained. Self-hardening or air-hardening steels owe their hardness to the presence in them of chromium, tungsten, or molybdenum. They are forged at a bright red heat, and to harden them the cutting edges of the tools are heated to a white glassy heat and cooled by a blast of cold air. This treatment would ruin ordinary carbon tool steel.

Tempering Scale for Carbon Tool Steel.

<i>Colour of Oxide.</i>	<i>Tools.</i>
Light yellow . . .	For files, scrapers, engraving tools, and lathe tools for hard cast iron and steel.
Yellow . . .	Lathe tools, dies, planer tools for iron.
Dark yellow . . .	Milling cutters, dies, punches
Brown . . .	Taps, cold chisels, shears, scissors.
Dark brown . . .	Centre punches, scribes, drills for brass.
Brown with purple spots	Axes, planes, twist drills.
Light purple . . .	Chisels for cast iron, large shear blades, table knives cold sets, saws for metal.
Dark purple . . .	Hand and pit saws, screw-drivers.
Dark blue . . .	Springs.

Tempering Chart for Carbon Tool Steel

	Deg. C.	Deg. F.	
	300	572	Springs
Saws for Wood	295	563	Circular Saws for Metal
Screw Drivers	290	554	Cold Chisels for Wrought Iron Shear Blades for Soft Metal
Moulding and Planing Cutters for Soft Wood	285	545	Needles
Firmer Chisels	280	536	Cold Chisels for Cast Iron Cold Chisels & Setts for Steel
Saws for Bone and Ivory	275	527	Hot Setts
Axes and Adzes	270	518	Press Tools
Dental & Surgical Instruments	265	509	Flat Drills for Brass Twist Drills
Augers	260	500	Stone-Cutting Tools Reamers
Coopers' Tools	255	491	Punches, Dies, Cups and Snaps Chasers
Wood Borer	250	482	Taps
Plane Iron	245	473	Screw-Cutting Dies Boring Cutters
Gouges	240	464	Milling Cutters Drills
Planing and Moulding Cutter for Hard Wood	235	455	Planing and Slotting Tools for Iron
Shear Blades for Hard Metal	230	446	Planing and Slotting Tool for Steel
Mill Chisels and Pick	225	437	Screwing Dies for Brass Light Turning Tools
Rock Drill	220	428	Scrapers and Lathe Tools for Brass
Leather-Cutting Die			
Bone-Cutting Tool			
Wood-Engraving Tools			
Paper Cutter			
Ivory-Cutting Tools			
Hammer Faces			
Mint Dies			
Steel-Engraving Tools			
Lathe Tools			

METHODS FOR DISTINGUISHING TOOL STEELS FROM MILD STEELS AND WROUGHT IRON.

By fracture or examination of the grain—

Wrought Iron has a rough fibrous fracture. Good quality wrought iron has a fine fibrous fracture. Outside appearance is of a dull black colour with reddish scale.

Mild Steel has a grey-white colour with small polished grains intermixed and not fibrous like wrought iron; inclined to be granular and silky in appearance. Outside appearance is of a bright black colour.

Cast Iron has a dull grey granular appearance, and the grain varies according to the quality. The finer the grain the better the quality.

Tool Steels have a grey-white granular appearance, and the better the quality of the steel the finer the grain, until with air hardening steels the grain has a silky appearance. Outside appearance is of a very bright blue-black colour.

Shear Steels have a coarse granular appearance with white faceted grains closely mixed, and it does not break with such a clean fracture. These steels can be welded.

Burnt Iron or Steel is very brittle, coarse grained with very bright facets mixed with dull grains.

To fracture the metal, nick it with a chisel, file, or emery wheel, then break it

DOUBLING OVER TEST.—If wrought iron is doubled over on itself and then hammered flat at the bend it will partly break open and show the fibre, mild steel does not break when treated in this manner.

DROP TEST.—**Tool Steels** have a very high-toned ring when dropped on a stone floor. The harder the steel the higher the note.

Mild Steels and Wrought Iron have a lower tone and a dull ring.

Cast Iron has a very dull and dead sound.

HEAT TEST.—Heat to a bright red and quench out in water, then try it with a file; if it cannot be filed it is carbon tool steel.

SPARK TEST.—Hold the piece of steel on a dry emery wheel and notice the colour and shape of spark.

Mild Steel.—A long, narrow, and bright spark.

Tool Steel.—A bright star-shaped spark.

High Speed or Alloy Steels.—A dark red pear-shaped spark.

High Speed Steel can hardly be filed at all when in its natural state, as it is very hard.

The methods above mentioned are rough and ready, but the necessary apparatus for testing in the proper manner is not always to hand.

Warping and Cracking of steel is caused by improper treatment when being forged, insufficient annealing (setting up internal strains), not heating thoroughly when preparing for hardening, or heating too quickly.

Warping in hardening is caused by one side of the article being cold before the other, or the thin side becoming cold before the thick side, so distorting the object.

CASTING OR FOUNDRY

is the art of working metals by pouring them while in a fluid condition into moulds where they solidify and harden into the form of the mould they fill. It is the most important of the operations by which metals are fashioned into ornamental and useful forms, although in practice some metals cannot be cast. It is an art that has been known and practised from very early times. In the Victoria and Albert Museum there is some cast bronze coinage belonging to the Chou dynasty dated 1122-1225 B.C. In the room of Greek and Roman life at the British Museum there is a limestone mould for casting metal which was in use about the eighth century, B.C., a bronze mould for palstaves (a kind of axe), and a stone mould for casting hammer heads. This last is illustrated in Ch. XIV, f. 4. Nos. 8 and 9 on the same page are bronze castings of an early date.

There are many operations in casting, and the article to be produced is now seldom made, moulded, and cast by one man, as was the case when Benvenuto Cellini modelled his figure of Perseus, and directed and helped in the casting of it. The most important operations in casting are making the pattern, making a mould from this in sand or some other suitable material, and melting and pouring the metal into the mould. Patterns are usually made outside the foundry or in the patternmaker's shop, quite distinct from the foundry. It is a woodworking trade, and the pattern-maker should have a knowledge of metals and of foundry practice. Iron is practically always cast in an iron foundry, while all the non-ferrous metals and alloys are cast in what is called a brass foundry. The tendency of the times is to specialize in one particular metal or group of metals, and by so doing better castings at a cheaper rate are obtained. Patterns are made either in metal, wood, plaster of Paris, or wax. Patterns which must be hollow have cores made of sand and shaped in core boxes. Moulds for casting metal are made of sand, metal, or a mixture of plaster of Paris and brick dust. When sand is used it is contained in an iron frame called a flask; this flask consists of two iron frames which fit together with pegs and eyes, the pegs on one frame the eyes on the other. There is green-sand moulding which is moulding in sand that is not dried, and dried sand moulding, where the mould has to be dried or baked in an oven. Large iron castings are cast in a loam mould, which is often made by being "swept up". When the object is circular a piece of flat wood made to the shape required and pivoted on a centre rod and revolved against a mass of sand cuts or "sweeps up" the mould. Cores are also made by sweeping up.

When the surface of an iron casting is wanted extremely hard, as in the case of car wheels, or rolls, this part of the mould is made of iron, so that when the molten metal flows against the cold iron it is chilled and hardened. Sand, owing to its cheapness, porosity, and refractoriness, is the best and most convenient material for moulding. Its porosity allows for the escape of the gases

generated, while its refractoriness keeps it in shape when the molten metal is poured into the mould. The best moulding sand is found along the banks of large rivers. For repetition work moulding machines worked by hydraulic power or by hand have displaced hand moulding and are now largely used.

Another method of casting, known as "Cire Perdu" or the lost wax process, is used for the best class of figure work, not the bronze figures one sees sold with clocks and marked at £2 17s. 6d. the set. These are mostly cast of zinc or antimonial lead, in what is known as a slush mould. A good illustration of the lost wax process is shown in the Indian section of the Victoria and Albert Museum. It is a sand mould containing a cast brass curb chain anklet; a model of the anklet is first made in wax, each link being unconnected with the others except by a narrow band along the top. The model is gradually encased with the liquid composition which forms the mould; the metal is deposited in a crucible attached to the mould and the whole is placed in the fire. The action of the fire destroys the wax model, the wax being absorbed into the mould, which then retains a complete impression of the anklet, each link being separate from the other with the exception of the narrow band at the top. When the metal is ready the whole affair is reversed, the hot metal fills the impression left by the wax model, and when the band connecting the links is filed off the anklet is left in the form of a chain. This object is from Rajputana. The candlestick on p. 108 is an example of cast and turned work, and the method of making it is shown on the page following.

Castings and wood patterns showing how the patterns would be made for various objects are illustrated in Chs. VII and IX.

The Dutch chandelier (Ch. XII, f. 8) is a good example of cast and turned work. The handles (Ch. V, f. 6, Nos. 10, 11, 12) would have to be modelled in wax and then cast in plaster, or carved in wood. It would be better to have these cast in "fine cored brass," that is, the mould would have to be faced with some very fine parting compound such as French chalk, which gives a fine outer surface to the finished casting, and cored. It is cored by having small pieces of moulding sand fitted to the various undercut parts so that they will come away and the pattern be withdrawn and then the pieces of sand called "false cores" are replaced so that the mould is perfect and ready for receiving the metal. The majority of patterns received by founders from artists are in plaster, and off these plaster patterns piece moulds are made in sand.

The metal used in an iron foundry is usually melted in a cupola furnace, but other metals than iron are melted in crucibles which are placed inside a furnace heated by gas, coke, or oil. Modern furnaces are mostly heated by gas or oil, and can be tilted so that the metal may be poured into the ladle or mould direct, thus saving the trouble of lifting the crucible full of molten metal out of the fire by manual labour. Crucibles are made of plumbago, graphite, fire clay, etc. The plumbago crucible consists of equal parts of clay and graphite. Owing to the great differences in characteristics and faults which are inherent

in the metals themselves, a knowledge of metallurgy is very necessary for the successful casting of metals. The most common faults in castings are:—

Blow Holes, caused by the gases not getting away.

Overshot Castings, caused by badly fitting flasks.

Oval Castings instead of round, owing to the moulds being pinched together too lightly.

Seared Castings, caused by the mould being too hard and not allowing the metal to shrink.

Imperfect Corners, owing to the metal being poured at too low a temperature or the corners of the mould not being pricked to allow the metal to run up sharp.

For the shrinkage of metals in castings see pp. 151-152.

CLEANING, FINISHING, AND PRESERVING OF METALWORK

Many of the articles shown in these pages could be made of brass, bronze, copper, German silver, or similar metals, and it must not be forgotten that finish is most important, but this depends on the possession of good taste by the maker. The finish chosen must suit the object and its surroundings. The colour should be uniform and beautiful and should be consistent with the metallic character of the work. The necessary steps to be taken for preparing the work ready for colouring or finishing are numerous. Thorough cleaning is carried out in the following manner: The object should be held by a piece of copper or brass wire, or by brass tongs, etc., so that it is not stained by the hands. It is then boiled in a solution of caustic soda (1 lb. to the gallon of water) to remove all grease, dirt, or old lacquer. [N.B.—Articles of aluminium, tin, or zinc must be treated with care, as they may be partially dissolved by this liquid.] The object is then well scoured with fine wet sand and well washed in running water. It is placed in pickle to soak for one to three hours, according to the strength of the pickle. (This is spent dip with water added.) Then it is washed and scoured with sand and water, washed again in cold water then passed through boiling water. It is then run through the old dip, then through the bright dip, through three washing waters, and finally through boiling water. It is necessary that the object should be quickly dried, and this drying is done by shaking it about quickly in plenty of hot sawdust.

The above applies to all copper, brass, bronze, and similar metals. The object is now ready to be bronzed, as described on p. 193, scratch brushed, polished, or electroplated. For scratch brushing a brush made of fine brass wire is required. Hand or lathe scratch brushes can be bought. The work is brushed with this and stale beer or water and vinegar. It is then well rinsed in two washing waters, finally in hot water, and dried in hot sawdust. It can now be relieved or lightened up by burnishing with a steel, agate, or bloodstone burnisher and stale beer, wiped off and lacquered. If the object is to be

polished, it may be pressed against a revolving calico or other mop or bob fixed on the spindle of a polishing head which revolves at a very high rate of speed. The mop or bob may be of leather (rhinoceros or walrus hide, which is sometimes called bull neck), felt, calico, or wool, and fed with carborundum, emery, sand, bathbrick, tripoli, rouge, lime, tallow, etc. Mops or bobs are made in various sizes, but are not usually larger than about 12 in. diameter and 2 in. thick. After being polished the work is usually greasy. The grease is removed by washing in two or three baths of paraffin or benzene. Nearly all metalwork after finishing and colouring should be lacquered. Lacquering may be accomplished by dipping the article into a vat of lacquer and drying in a special room or oven, by putting the lacquer on with a brush when the work is hot or cold (depending on the lacquer), and drying, or by spraying the lacquer on with a patent air spray or brush as it is called. Lacquer is a thin spirit varnish made in various colours. It is generally shellac dissolved in alcohol and coloured with dragon's blood, turmeric, saffron, etc. What are known as cold lacquers (all of which are patents and go by fancy names) are made with amyl acetate and coloured with aniline dyes. Many of these lacquers smell like essence of pears. It is essential that the work should be free from all dirt, dust, grease, etc., before being lacquered. Skill and artistic taste are required for the blending and lacquering of metallic objects. Figure work is sometimes brushed over with white paraffin wax or beeswax.

Iron and steel articles, structures, etc., are preserved from rusting by gilding, painting with oil colours, or coating with another metal which is not affected by the atmosphere, such as tin, zinc, copper, nickel, etc. Before being protected by painting, ironwork should be heated sufficiently to dispel all moisture, and while hot should be painted with a coat of boiled linseed oil applied at a boiling heat. After twenty-four hours this operation should be repeated, and then the colour coats applied, or it may now be gilded after the necessary sizing. Tin plate is wrought iron or mild steel sheets, thoroughly cleaned, passed through a bath containing molten tin with about 4 in. of tallow on the top, then through rollers which squeeze off the surplus tin. The plates are dried in bran. Iron is galvanized or coated with zinc by hot galvanizing, electro galvanizing, Sherardizing, or dry galvanizing. For hot galvanizing the work is cleaned by sand blasting, pickling in hydrochloric acid, or burning. It is then passed through a bath of molten zinc, and allowed to cool. Work preserved in this manner can be distinguished by its spangled appearance. Electro galvanizing is done in a similar manner to the electro deposition of other metals (see p. 194), but owing to the difficulty of depositing zinc, slight modifications are necessary. The Cowper Coles process is most successful for this work. Sherardizing is a process invented by Mr. Sherard Cowper Coles, and is somewhat as follows: The work is cleaned as previously described and then placed in an airtight drum charged with zinc dust. This is rotated and heated to 500° or 600° F. for a few hours and allowed to cool. When removed the articles are found to be coated

with zinc depending in thickness upon the temperature and duration of the treatment. They are of a brighter colour than articles done by the electro deposition method.

It is possible by this method to galvanize only certain parts, by coating portions of the articles with a composition which prevents the zinc being deposited.

The following are a few simple and useful recipes for general work :—

Bright Dip for Iron :—

Water	1 gal.
Sulphuric acid	1 lb.
Zinc	1½ oz.
Nitric acid	8 oz.

Bright Dip for Brass, Copper, and Similar Metals :—

Nitric acid	2 parts.
Sulphuric acid	1 part.
Hydrochloric acid ½ pint per gal. of dip.	

Matt Dip for Brass, etc.—Dissolve 6 oz. clean sheet zinc in 1 gal. hot nitric acid, then pour in sulphuric acid slowly until dip looks white, then heat to 160° F. and test; if too coarse add sulphuric acid. Stir with glass rod; never use wood, and don't put hydrochloric acid in it.

Removing Copper Oxide from Brass after Brazing.—Old bright dip heated to 150° F., then add 2 qts. of sulphuric acid for every gallon of bright dip.

To Copper Wire Nails or Iron Screws :—

Blue vitriol	1 oz.
Sulphuric acid	1 oz.
Water	1 gal.

To Boil Brass Articles White.—Put 8 oz. pure tin shavings and 6 oz. cream of tartar into a boiling pot with 1 qt. of water. Make sufficient to cover the work and boil.

Various Shades of Brown on Brass, etc. :—See p. 193

Various Shades of Brown, including Brilliant Shades of Blue :—

Hyposulphite of soda	4 oz.
Acetate of lead	2 oz.
Water	1 gal.

To be used hot and each chemical to be dissolved separately.

Green Br. nze :—

Ammonium carbonate	2½ oz.
Common salt	¾ oz.
Acetate of copper	1 oz.
Cream of tartar	¾ oz.
Water	16 oz.

Brush the work over with this and let it dry. Repeat until the right colour is obtained.

Steel Colour on Brass :

Arsenic	$\frac{1}{2}$ lb.
Blue copperas	4 oz.
Carbonate of iron	2 oz.
Verdigris	2 oz.
Hydrochloric acid	7 lb.

Immerse, wash off, scour with sand, and repeat until a good colour is obtained, then brush up with blacklead.

The procedure for the above cases is similar in nearly all. The work must be thoroughly cleaned and dipped bright and then immersed in above solutions. To obtain the best results a little practice is essential.

Surface colours or patinas may be obtained—

By chemicals as above.

- „ heating.
- „ oxidizing or atmospheric influence.
- „ alkalis.
- „ electro deposition.
- „ dipping in molten metals.
- „ varnishing or lacquering.
- „ rolling, that is, soldering a thin piece of metal on to a thick base and then rolling all out together ; examples : Sheffield plate, rolled gold.

METHODS OF JOINING METALS.

In all kinds of metalwork a knowledge of how metals may be joined together is essential. Joints are either permanent or temporary. Permanent joints can be made by burning, autogenous welding, ordinary welding, brazing, silver soldering, soft soldering, folding, riveting. Temporary joints are screwing, bolting, wedging, taper fitting, force and shrink fitting. In many cases, though we call brazing, silver soldering, soft soldering, and riveting *permanent* joints, they can with care be taken apart again.

Burning.—The method of burning a joint together is as follows : The two pieces of metal to be joined are placed in position and fixed so that a stream of molten metal may be run between the joint until the ends to be joined are at the same heat ; the molten metal that has been flowing to waste is then checked, the joint filled up and left to cool. The joint is usually embedded in sand. When cool it is removed and the lumps trimmed off, leaving the metal in one piece and without any sign of a joint. Nearly all metals can be joined by this method.

Autogenous Welding, or thermit welding, is done as follows : Thermit, which consists of finely divided aluminium and oxide of iron, is placed in a crucible which has a hole in the bottom fitted with a fusible plug. The crucible is placed in position over the ends to be joined, and the ends are enclosed in a

mould which has an outlet that can be closed after sufficient metal has passed through to heat the joint. When everything is ready the fusing action is started by igniting a special powder, or magnesium powder, which can be lit with a match. The heat generated by the chemical action reduces the iron oxide to a fluid mass of iron; this melts the fusible plug, allowing the metal to enter and fill the mould. This is also called aluminothermy.

Blowpipe Welding is carried out by means of various gases, such as acetylene, oxygen, hydrogen, and is now fairly general in its application. The gases are under pressure and drawn from cylinders. The mixing of them takes place in the mixing chamber of the special blowpipes which are used. The edges of the metals to be joined are filed clean and bevelled, and while the fusion of the edges is taking place the actual joint is fed with a metal of the kind that is being welded, in the form of rod, to fill up the spaces in the joint. The advantages of this method are that the appliances are portable, so that welds can be made "in situ" and the heat is localized. The perfection of the weld depends on the skill of the operator.

Electric Welding is very suitable for repetition work, is very quick, and dissimilar metals may be welded. But it requires special plant and fittings for each particular job. The operation is somewhat as follows: The pieces to be welded are held tightly one by each arm or guide, and these are insulated one from the other; the electric current is turned on, and the ends are brought close together but not quite touching. This causes an electric arc to form at the ends to be welded, and they heat from the centre to the outside, and when it is at the right temperature, the ends are forced together either by manual or hydraulic power.

Ordinary Welding which is done by the smith consists of thickening up or up-setting, as it is called, the ends to be joined to allow for their subsequent reduction by hammering and then raising the pieces to a welding heat, laying one on top of the other, and hammering them together. The work is heated in a coal or coke fire assisted by a blast of air. Wrought iron and mild steels are usually brought to a bright white heat and tool steel to a dull white or yellow heat. There are various forms of welds such as scarf welds, tongue welds, split welds, and jump welds, but the scarf weld is the strongest and most common. A flux is generally used to protect the surfaces of the metal to be joined from the action of impurities in the fuel and from oxidation—silver sand for wrought iron and mild steel, venetian red and borax for tool steels.

Brazing and Soldering consists of joining metals by means of alloys which are heated and fused together with the edges of the work, so that they alloy with the metals being joined. There are three essentials for this kind of work.

The joints must be clean.

A flux must be used.

The solder or alloy used must melt before the material that is to be joined.

A coal-gas blowpipe flame assisted by an air blast is generally employed,

but a forge fire, or spirit blow lamp would very often answer the same purpose. The only difference between brazing or hard soldering, as it is sometimes called, and silver soldering, is that in the one case spelter is used and in the other silver solder is used. (For the composition of these see p. 148.) The following method of procedure should be adopted when brazing or silver soldering. The joint should be clean and the edges fit together. When fitted, the parts should be held together by ties of iron binding wire, when the joint is difficult to adjust one or more iron dowel pins should be used. These with the wire ties prevent any shifting of the joint during the progress of the operation. The work should now be carefully adjusted on the bed of the forge, care being taken to support it so that no strain is on the tied joint. When arranging the coke around joint to conserve the heat, place it so that all the parts are open to observation, otherwise while the solder is fusing, some adjoining part may be melted. The difference of the melting temperatures being very slight, spelter should be mixed with water and powdered borax in a small pot. When the work is in position the joint should be moistened with the borax water and the joint "charged," i.e. just sufficient of the moistened spelter laid on the joint to fill it when fused. The work should now be heated in the vicinity of the joint, and when there are unequal thicknesses the heaviest parts should be heated first, gradually bringing the heat up to the joint; watch that both sections receive the same amount of heat, otherwise it will not be a good joint. When a red heat is reached the borax will melt; dry powdered borax should now be dusted on from time to time to prevent the solder perishing or being converted into oxide; as the heat increases the flame should be localized over the solder and a fiercer blast given until the spelter fuses and flows into and fills up the joint. When this point is reached remove the flame and allow the work to cool. It should not be moved until all traces of red heat have disappeared; then place in pickle (for composition of this see p. 222) to dissolve the borax and oxide.

Soft Soldering.—This consists of well cleaning the parts to be soldered, applying a suitable flux (for this see p. 230), heating the metal, and applying just sufficient solder to make the joint. Soft soldering must be done with the aid of a soldering iron or bit (see Ch. xvi, f. 16), spirit lamp, gas blowpipe, or heat of some kind to melt the solder. When using a soldering iron or copper bit, as it is sometimes called, it must be well tinned, that is, the iron must be heated, filed clean, rubbed in the flux, and the point covered with solder. It is very often an advantage to tin the parts to be soldered first.

Zinc Chloride for Soft Soldering.—Place some pieces of zinc in hydrochloric acid until the acid stops working, then leave it for twenty-four hours. Now strain and filter it, and add 2 oz. of water to the pint of acid.

In **Riveting**, pieces of metal are joined together with rivets. These are made of various metals and in different shapes, such as half-round or snap head, pan, countersunk, flat, or conical head. A rivet is known by the shape of the head, length of stem under head, diameter of stem, and the metal it is made of.

The method of riveting is as follows: The rivet is selected according to the thickness of the plate to be riveted, the holes for the rivet are then either punched or drilled, the rivet is placed in position and the metal set down with rivet set; sufficient length of rivet is left to project through the plate and form the other head; the end or tail of the rivet should be flat, the tail should be burred over with a light hammer and finished to shape with the aid of a cup tool. For illustrations of rivet set and cup tool see Ch. xvi, f. 21 (27). The distance of one rivet from the other is known as the "pitch," and depends on the nature of the work.

Screwing is joining metals together with screws and should be avoided, as screws are liable to work loose. They are made of iron, brass, bronze, or steel, and have heads of various shapes, half-round heads, countersunk heads, cheese heads, half-round and countersunk combined. All screws used for metal are known as tapped screws or metal-thread screws to distinguish them from screws used for wood. They are made to many standards and in various pitches.

The pitch of a screw is the distance it will move in the direction of its axis in one revolution through a fixed nut. The following are some of the standards: Whitworth, British Association, known as B.A., U.S.A., International Metric, and Bicycle standard. Screws are known by their diameter, standard, shape of head, metal, and length under head, as for example $\frac{1}{4}$ in. Whitworth round head, brass, 1 in. underhead. In screwing work together the part that takes the head of the screw has a clearing hole in it, while the other part has to have a tapping hole; this is also known as the core diameter so that it can be threaded. This allows the work to be drawn tightly together. In engineering shops the screws used in machinery for imparting motion are known by their shape such as "square," "buttress," "knuckle," or "acme thread". A set or grub screw is one that has a point and no head, but a saw cut in the screw itself, so that it can be turned with a screw-driver.

Bolting and Wedging is used mostly for fixing together various parts of machines. Bolts are now usually made to the Whitworth standard. The size of the head bears a fixed relation to the diameter of the bolt. There is a large variety in use, such as hexagon, ball, cheese, coach, deck, square, countersunk, etc., the name applies generally to the shape of the head. When an extra long bolt is required a "bolt end" is welded to a length of rod, as this is more convenient. Where there is a lot of vibration "lock nuts" have to be used because ordinary nuts work loose. Of these there are many forms. Wedging, keying, and taper fits are due to frictional contact, and in the fixing of nearly all wheels and pulleys this property is utilized as well as in what are known as friction clutches. The system adopted by the Morse and other companies for holding drills of all sizes by means of taper fits and removing them by means of a hand lever is an extremely simple and convenient method in every way.

A **Force Fit** is where the pin is made very slightly larger than the hole and the two parts are forced together. An example of this is the lathe pulley

TABLE SHOWING METHOD BY WHICH METALS MAY BE JOINED.

Name of Metal.	Soft Soldered.		Silver Soldered.		Brazed.		Autogenous Soldering or Burning, including Oxygen Acetylene Welding		Welding, Old Method.	
		Flux.		Flux.		Flux	Flux			Flux
Aluminium . . .	No	—	No	—	No	—	Yes	None	No	—
Aluminium bronze	Yes (after being coppered)	Zinc chloride or Sal ammoniac	Yes	Borax	Yes	Borax	No	—	"	—
Brass	Yes	" "	"	"	"	"	Yes	Borax	"	—
Britannia metal . . .	"	" "	No	—	No	—	No	—	"	—
Bronze	"	" "	Yes	Borax	Yes	Borax	Yes	Borax	"	—
Copper	"	Zinc chloride, Sal ammoniac, or Rosin	"	"	"	"	"	Borax	"	—
Delta metal	"	" "	"	"	"	"	No	—	"	—
Dutch metal	"	" "	"	"	"	"	"	—	"	—
German silver	"	" "	"	"	"	"	"	—	"	—
Gilding metal	"	" "	"	"	"	"	"	—	"	—
Gold	"	" "	"	"	No	—	"	—	"	—
Gunmetal	"	" "	"	"	Yes	Borax	Yes	Borax	"	—
Iron, galvanized	"	Hydrochloric acid	No	No	No	No	No	—	"	—
Iron, wrought	"	" "	"	"	Yes	Borax	Yes	None	Yes	Silver Sand
Iron, cast	Yes, not strong	Zinc chloride	"	—	No	No	"	Borax	No	—
Lead	Yes	Zinc Chloride or Tallow, etc.	"	—	"	"	"	None	"	—
Manganese bronze	"	" "	Yes	Borax	Yes	Borax	No	—	"	—
Mild steel	"	" "	"	"	"	"	Yes	None	Yes	Silver Sand
Muntz metal	"	" "	"	"	"	"	No	—	No	—
Ormolu	"	" "	"	"	"	"	Yes	Borax	"	—
Pewter	Yes, but using special solder	Tallow or Gallipoli oil	No	—	No	—	No	—	"	—
Phosphor bronze	Yes	Zinc chloride or Sal ammoniac	Yes	No	Yes	Borax	"	—	"	—
Silver	"	" "	"	"	No	—	"	—	"	—
Tin	Yes, with care	" "	No	—	"	—	Yes	—	"	—
Tinned plate	Yes	" "	"	—	"	—	No	—	"	—
Tool steel	"	" "	Yes	Borax	Yes	Borax	Yes	None	Yes	10 Borax, 1 Sal ammoniac or Borax and Venetian Red
Zinc	"	Zinc chloride, Sal ammoniac or Hydrochloric acid	No	—	No	—	No	—	No	—

Note.—When rosin is mentioned Venice turpentine will do as well, and is cleaner.

Ch. XVI, f. 22 (26). This pulley of cast iron is forced on to the steel mandrel, or lathe spindle as it is called. This appears as if made in one piece.

A **Shrink Fit** is where advantage is taken of the property of expansion of metals, and it is utilized in many ways. The method is used where a collar has to be put on some work to hold it together. The collar is made slightly smaller than the work it has to go on, it is heated to a bright red and put on. On cooling it contracts, so binding the work tightly together. Cast iron cannot be utilized in this manner. For example see Ch. XII, Fig. 13, No. 1.

Joints in Tinned Plate Work.—These are usually plain or folded lap joints (see A and B, Fig. 9, Ch. VIII). The plain lap joints are soft soldered and riveted with tinned iron flat-headed rivets. Folded lap joints, as illustrated in Fig. 9, Ch. VIII, Letter B, can be made by hand or in a machine called a folder, and when made by machinery they are so well done that they are watertight without the aid of soft solder.

HINTS WHEN WORKING METALS.

Annealing Metals:—

1. Anneal zinc with a Bunsen burner, not a blowpipe, or it may volatilize.
2. When annealing aluminium mark over with common soap and warm until soap turns black; it is then annealed.
3. Before annealing sheet brass work ease any stresses that may exist by malleting. Also warm very slowly and gradually increase temperature to avoid fire cracks.

Soldering Metals:—

1. All metals should be tinned at the joint before being soft soldered.
2. Use hydrochloric acid as a flux when soldering galvanized iron.
3. Before soft soldering pewter be sure the solder melts before the job.

Brazing Metals:—

1. Iron should be reddened before being brazed, i.e. rubbed with sulphate of copper (bluestone) and water.
2. File all joints before brazing and silver soldering.
3. Butt joints should be nicked before brazing.
4. If spelter is not fusible enough add zinc filings or a little silver solder.
5. Before brazing sheet or rod brass, practice on a waste piece of the *same* material first.
6. See that your work is well packed up and tied before brazing so that it does not separate when on the point of fusion.
7. See that there is not any lead or solder on brass when bringing the brass to a red heat as it will cause a hole.

Forging:—

1. Keep the fire clean, and free from clinker.
2. Keep the face of your hammer in good condition.

3. See that your tongs fit the work, so avoiding an accident.
4. Do not work iron at a dull red heat.
5. Do not work or heat carbon tool steel beyond a bright red heat.
6. When cutting material on the anvil with a hot or cold sett see that the tools do not touch the face of the anvil when nearly through.
7. A block of copper with a piece fitting into the square hole in the anvil is handy for cutting out thin material on, especially if the material is hot.
8. Good forge coal should be even in size, glossy black, and should crumble, not split.
9. Pea-size washed coke breeze makes a nice clean fire for light work.
10. Before welding see you have all the tools ready to hand.

Other Points that you may need .—

1. Keep hammers off tin plate as much as possible ; use a mallet instead, and little of that.
2. Measure twice before cutting your material off.
3. See no dampness is in or on the moulds used for casting lead in.
4. When loading brass tube for bending, see that no air-pockets form. Prevent by heating tube at loading end and work downwards with the blowpipe so allowing the material to settle ; reversing the process might cause a burst.
5. Use a slate pencil for marking on iron, or a scribe made of brass wire.
6. Use a black lead pencil when marking on zinc.

Centrifugal Casting.—Applied to “spun” iron pipes.

This method of casting is known as the “De-Lavaud” process and is preferable to other methods in that stronger, thinner and more uniform pipes can be produced cheaply.

The steel mould in which the pipe is formed is revolved at a high speed on its own axis inside a water-cooled iron casing. Upon the introduction of molten iron into one end by means of a cantilever trough the revolving mould is moved backwards on a bedplate, tilted slightly to ensure uniform thickness, in such a manner that the mould is lined evenly with the molten metal. On solidifying the metal contracts and the pipe is withdrawn by the insertion of internal grips, while the mould is traversed in the reverse direction. The rapid cooling causes the chilling of the outer surface of the pipe which has then to be passed through the annealing furnaces. After annealing the pipe is mechanically cleaned and then dipped in Dr. Angus Smith’s mixture (a tar composition), after which it is ready for testing.

CHAPTER XVI

BUILDINGS, EQUIPMENT, AND TOOLS FOR TECHNICAL AND HANDCRAFT CENTRES

THE WOODWORKING SHOP.

THE essential feature of a properly equipped workshop for technical or handcraft work is a lofty, well-lighted spacious room, so arranged as to render classrooms easily accessible, one of these if possible actually adjoining the workshop. A plan of a woodworking shop is illustrated on page 233 arranged for the accommodation of twenty students. In centres devoted exclusively to junior handcraft work, the accommodation can easily be increased to double capacity by using double benches—not necessarily any larger in size than those shown. The plan illustrated is of a shop suitable for day handcraft or technical work, which also lends itself well to evening instruction in woodworking subjects. The benches D are arranged in three rows, all facing one way. An instruction bench A is placed in the same relative position, facilitating demonstrations, and it is placed upon a raised platform B. The wall at this end should be provided with a large blackboard, not less than 6ft. square, which can be raised or lowered at will. Entrance to the handcraft room is made through the folding doors at C from the class room adjoining shop, and on the south side the handcraft room can be entered through the timber store marked D in diagram. E in plan marks the position of a small lathe (see also Fig. 22 (26)) operated by foot-power, or a small electric motor can be attached to each machine at comparatively small cost. G marks position of an oilstone table (see also Fig. 4, p. 237) for general use. F and H show position of store cupboards, the upper parts provided with glazed doors, and serving as storage space for special tools, models of tools, etc.—used for demonstration purposes—books, and a divided portion can be fitted up as a small timber museum, with specimens of timber, cross-sections of timber, leaves, twigs, etc., for use in object lessons. Students' books, drawing paper, charts, and large diagrams used in class work can be accommodated in racks and trays fitted into the bottom part. I indicates a grindstone (see also Fig. 5, p. 238). J is the plan of a gas stove with rings for accommodation of glue-pots

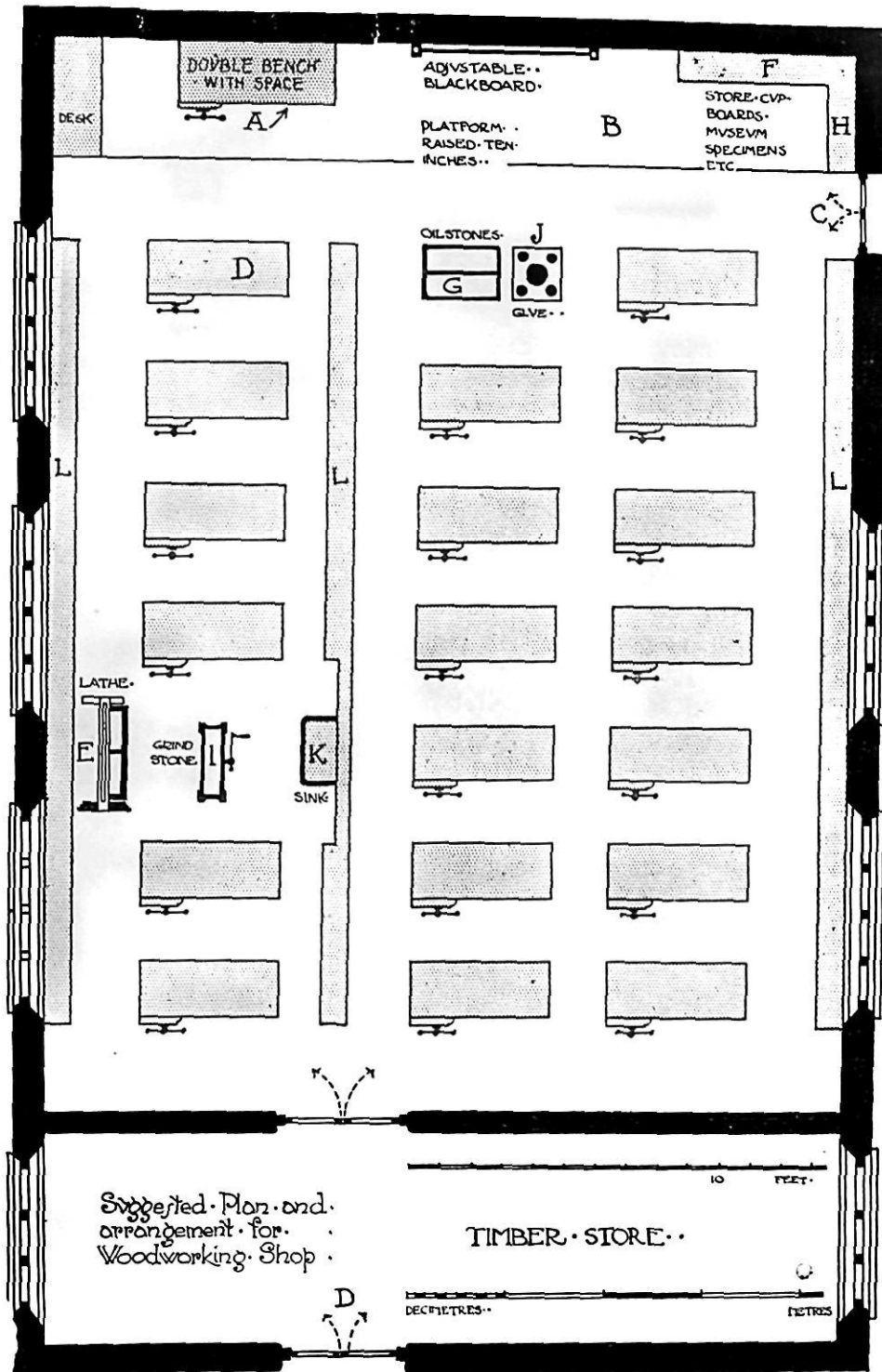

FIG. 1.—Suggested arrangement of workshop for handcraft and technical classes.

Electric power can now be utilized for this purpose. K. represents in plan an earthenware sink for washing purposes.

Heating is best effected by the radiator system, with valves for regulating the temperature. Open fires should not on any account be introduced in wood-working rooms. The spirit of emulation, a much discussed and sometimes abused virtue, can be encouraged by the judicious selection and arrangement of good examples of decorative craftwork. These should be protected with glazed frames and hung about the walls about 4 ft. 6 in. high, changing them at intervals for different specimens.

Decoration, economical, and yet possessing some æsthetic merit, should be carefully studied in institutions which aim at the development of taste. Distemper colours are good, as they can be readily renewed, preferably light green or grey tones, these being more suitable to the eyes than crude or vivid colours which are so conducive to eye-strain. Ventilation is readily effected by means of iron casements, now an accepted type of window for school buildings. Air bricks with adjustable covers are also an advantage.

Flooring.—Parquetry or wood floors of pine or yellow deal are preferable to those made of teak wood, affording a better grip for the feet and not becoming slippery so rapidly. Projecting portions of tool cabinets placed round the walls should be avoided; a good plan is to fit pieces between the tool cabinets at an angle of 45° with the wall and floor lines, thus avoiding accumulation of dust in corners and rendering sweeping and cleaning much easier than would otherwise be the case.

Tool Cabinets.—The particular design and arrangement of these of course varies according to conditions, but the examples illustrated will serve as first suggestions which can be adapted to other requirements. That illustrated in Fig. 2 is designed to serve for both junior pupils and evening students in technical work. The material is whitewood, painted to harmonise with the wall treatment. The arrangement of the tools will be apparent from the diagram, a set of small planes for juniors and a set of large planes for seniors. All other tools, comprising gauges, saws, square, chisels, etc., are for common use. The arrangement shown has the advantage of being readily examined by the instructor before the students are allowed to leave the workshop. A cupboard is provided for storing models or exercises belonging to various sections. A complete list of tools for this cabinet is as follows:—

14 in. tenon saw.	Large trying plane.	Cutting gauge.
8 in. dovetail saw.	Small trying plane.	6 in. try square.
Large trying plane.	Large jack plane.	Dividers, 6 in.
Small trying plane.	Small jack plane.	Bevel.
$\frac{1}{4}$ and $\frac{3}{8}$ in. mortise chisels	Smoothing plane.	12 in. rule.
1, $\frac{3}{4}$, $\frac{1}{2}$, $\frac{3}{8}$, $\frac{1}{4}$ in. firmer chisels.	Rasp and file.	Mallet.
Hammer.	Marking gauge.	Screwdriver.
Striking knife.	Mortise gauge.	

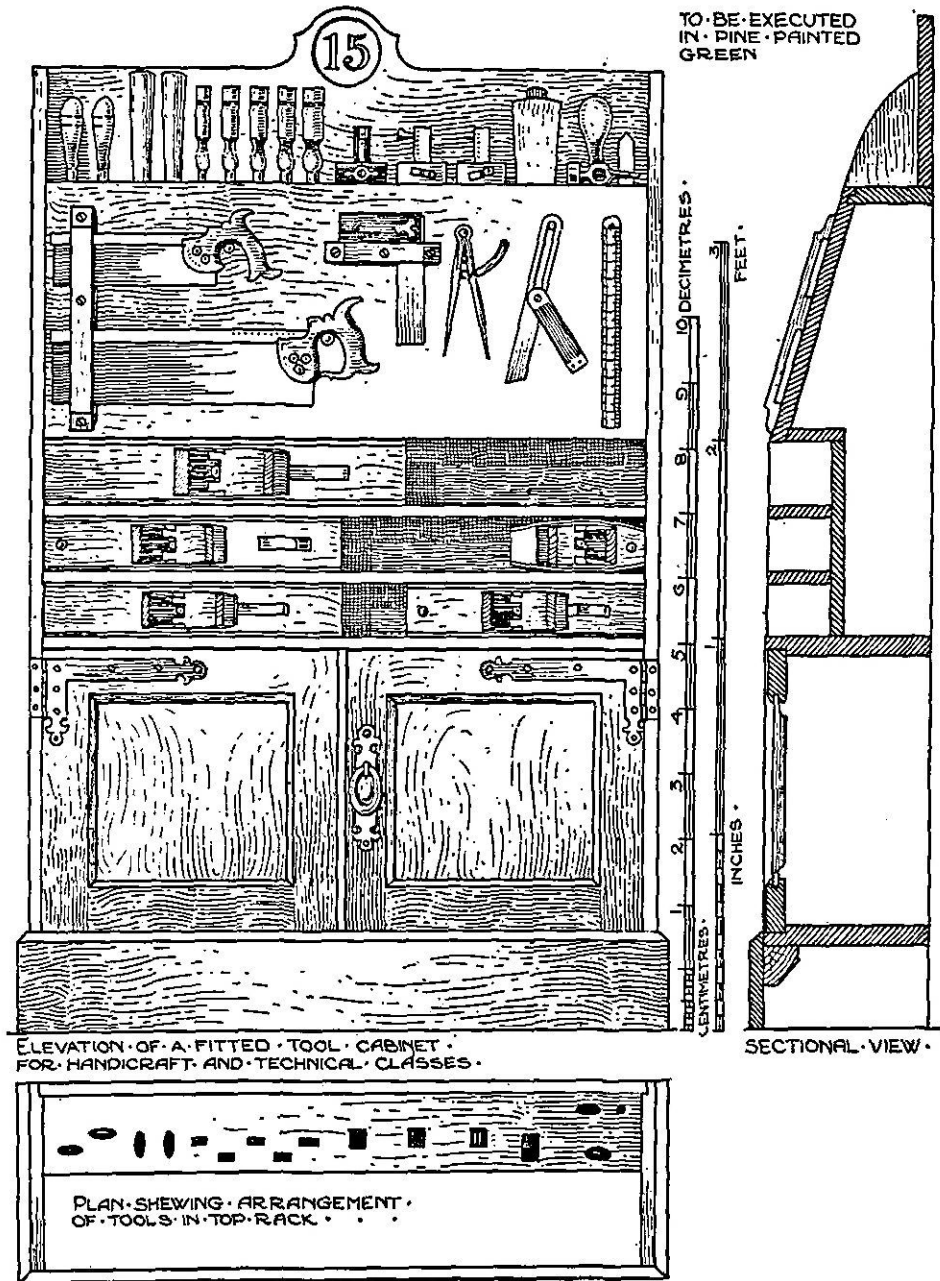
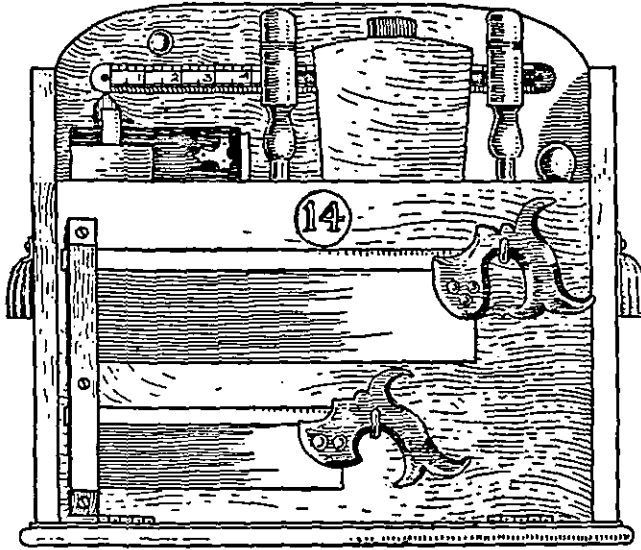

FIG. 2.—Suggestion for tool cabinet accommodating large and small sets of tools for junior and senior students.

The small cabinet illustrated in Fig. 3 indicates a suitable arrangement for a handcraft outfit only, and is intended to be hung on the back of a bench when not in actual use. Upon the commencement of a class these racks are transferred to the students' benches and remain there during the lesson. They may be checked by the instructor after class is finished. A plan shows the arrangement and position of tools allowed to each rack as follows:—



ELEVATION AND PLAN OF A HANGING TOOL CABINET FOR HANDCRAFT CLASSES.

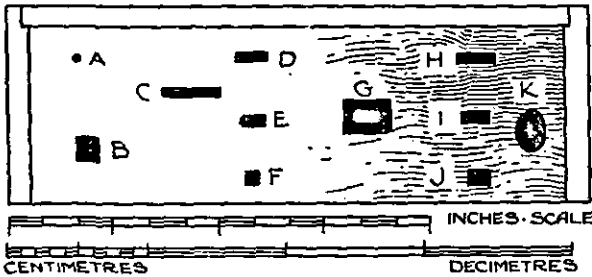

FIG. 3.—A small tool cabinet for the use of handcraft pupils.

- | | |
|------------------------------|------------------------------|
| A. marking knife. | F. $\frac{1}{4}$ in. chisel. |
| B. marking gauge. | G. mallet. |
| C. 6 in. try square. | H. 1 in. chisel. |
| D. $\frac{3}{4}$ in. chisel. | I. $\frac{3}{8}$ in. chisel. |
| E. $\frac{1}{2}$ in. chisel. | J. $\frac{3}{8}$ in. chisel. |
| | K. hammer. |

A **Circular Saw** for the instructor or student teacher would be best placed in the timber store, and operated either by foot or a small $\frac{1}{2}$ horse-power motor. It is especially useful in the preparation of material for large classes. A locking arrangement is advisable in order to prevent tampering.

A small tenon or shoulder saw and a dovetail saw are attached to the front as shown, and a 12 in. iron rule is hung on the back part. All extra tools are stored in the cupboards and are issued as occasion demands. L. in plan of workshop indicates a continuous arrangement of tool cabinets, a decided advantage when sweeping, as no inaccessible corners have to be negotiated.

An **Oilstone Table** (Fig. 4) should be provided, as shown in plan, made about 4 ft. long with the top lined with $\frac{1}{8}$ in. zinc. All sharpening by pupils should be effected on this table, which obviates the disposal of oil upon the benches, and also reduces the number of oilstones required. With thirty pupils not more than five oilstones are necessary.

The **Grindstone** (Fig. 5) is the type best suited to handcraft work. The method of operating same will be evident from the illustration. The chisel is secured in a rack or falling frame, and a straight bevel can easily be obtained by a young boy. It also reduces the chance of accident to a minimum.

A **Glue-pot Stand** is shown in plan, consisting of bar iron riveted together with rings at the top. Each ring has a gas tap attached, and a master tap governing all the rings is also fixed above the connexion to gas pipe.

The **Lathe**, illustrated in Fig. 22 (26), is suitable for small work in a handcraft centre for demonstration purposes, and also for the execution of simple turned work. The length is 4 ft., and includes two slide rests and a centre face-plate for flat work. A motor should be attached if turned work is done to any extent.

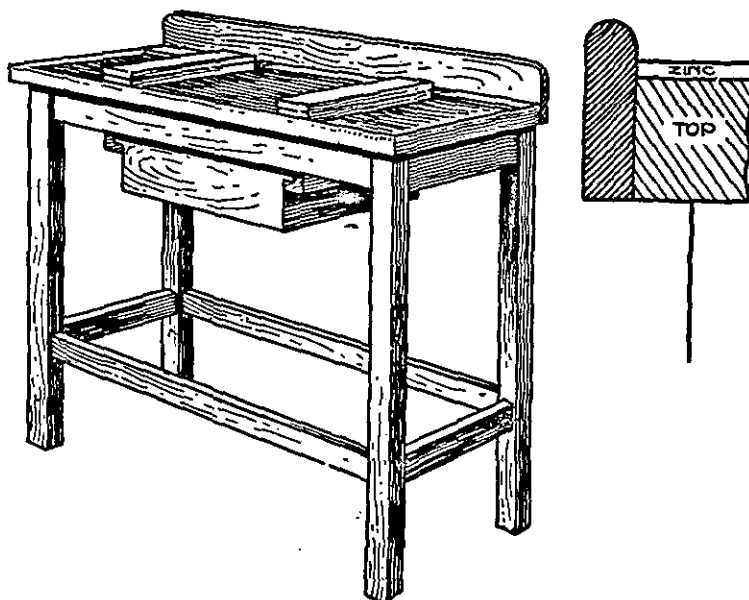

FIG. 4.—An oilstone table with zinc-lined top.

A **Bench** of German manufacture is illustrated in Fig. 6 (1), provided with wooden screws and iron stops. It can also be obtained with iron screws and handles, and these are an advantage in scholastic work, wooden screws being so frequently broken. A double bench is shown in Fig. 7, but its use is not recommended.

TOOLS.

PLANES.—Fig. 6 (4) illustrates a **Trying Plane**, used for obtaining perfectly true surfaces, shooting joints, squaring ends upon a shooting board, in fact for practically every planing process that requires great truth and exactness. The length varies from 18-30 in., the former for junior use, and the latter size for special jointing work. Twenty-eight inches is the standard full size for general work. Double irons are used in both sizes—2 in. for the small size and $2\frac{1}{4}$ in. for the large one.

Description of Fig. 6 (continued).

The **Jack Plane** is illustrated in Fig. 6 (5). It is used for roughly planing material prior to the use of the trying plane. Length varies from 14-20 in. for handcraft and technical work respectively, with irons $2-2\frac{3}{8}$ in. wide. Although gauged irons are recommended for all planes, some prefer the ordinary or tapered type.

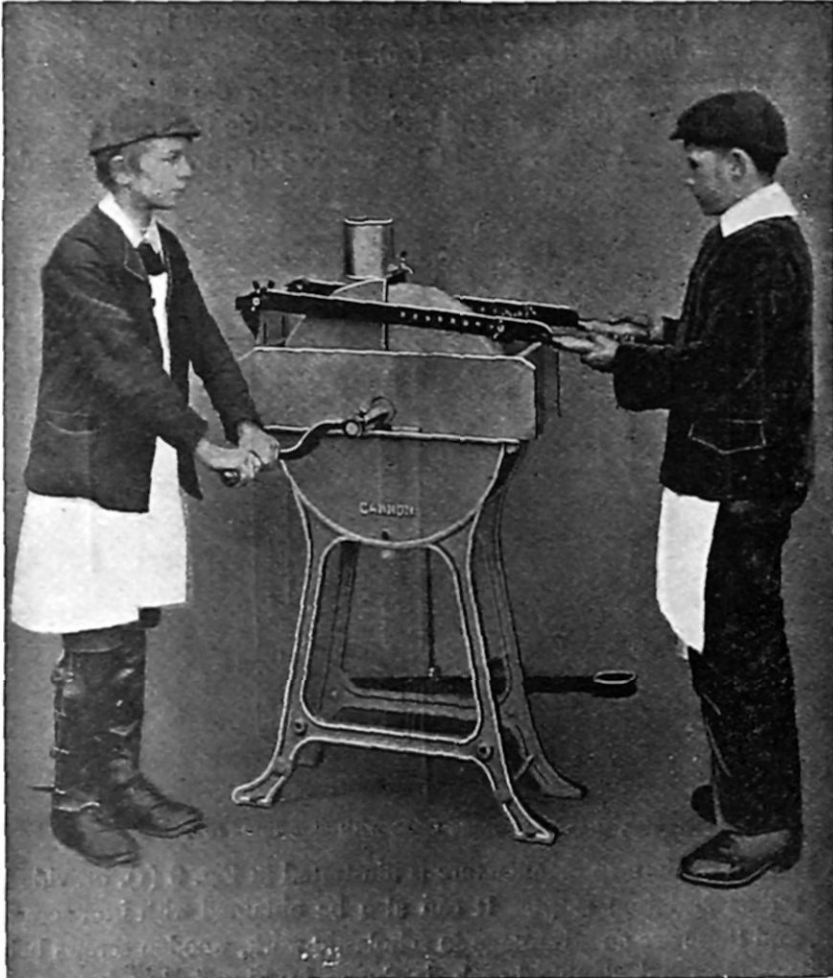

FIG. 5.

A **Smoothing Plane** is shown in (6), and as the name indicates it is used for smoothing up surfaces after they have been prepared with a jack and trying plane. Width of iron varies from $1\frac{3}{4}-2\frac{1}{4}$ in.; the smaller size is best suited to handcraft work, the student obtaining more control over a tool proportionate to his size. In all planes the pitch of the iron varies accordingly as it is intended for hard or soft wood; generally speaking, a low-pitched iron is best for young students.

Description of Fig. 6 (continued).

(7) illustrates the **Plough**. The terms applied to this tool are (1) body or stock; (2) the skate, consisting of a steel fixed in the sole; (3) the fence, which regulates the margin of grooves; and (4) the stop. This is adjustable and is set by means of a screw; it is used to determine the depth of a groove.

(9) is the **Block Plane**. Used by craftsmen for shooting end grain of material, general fitting, and mitres. The iron is fixed at a particularly low angle. It is usually used in conjunction with the mitre block (see Fig. 8 (8)).

(10) is the **Rebate Plane**. Made from $\frac{3}{4}$ -1 $\frac{1}{2}$ in. on sole, and as the name indicates is used for rebating. In addition to its ordinary uses, it may with advantage be used for shooting small veneers when a shoulder plane is inaccessible; it is then worked flat upon a small shooting board.

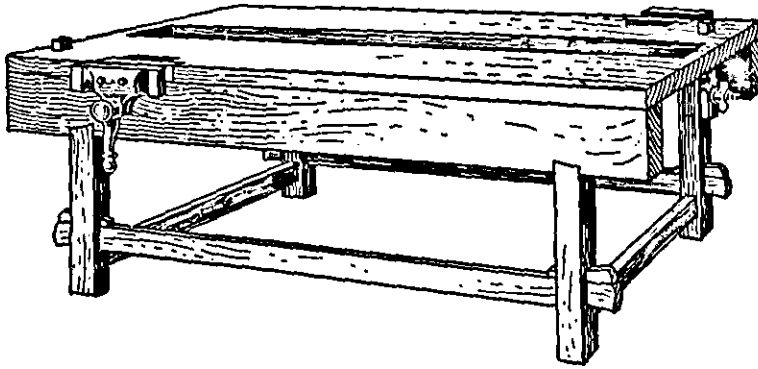

FIG. 7.—A double bench.

(12) is a **Shoulder Plane**. Made of malleable iron, and used for regulating end grain shoulders. This tool is almost indispensable when working veneers. It is then used on its side, and in conjunction with a shooting board. The cutting-iron is fixed at a low angle, and, as is also the case with the block plane, the bevel of the iron is placed uppermost.

An **Old Woman's Tooth** is illustrated in (8), consisting of a block of wood with a plough-iron wedged in position, the cutting part projecting beyond the sole, and used chiefly for regulating the depth of grooves cut across the grain, after the end has been roughly removed with a chisel.

An **Iron Spokeshave** is shown in (11). Useful for fine work, especially in hardwood. The English pattern spokeshave, see Fig. 6 (13), is made flat or curved in section, as is also the American pattern, suited respectively for concave and convex edges or surfaces. The English types are made in box, lance, and beech wood.

(14) illustrates an **Iron Rule**. Such rules may be obtained up to 3 ft. long divided with English and metric measures.

(2) illustrates a beechwood **Mallet**, made in various sizes, and (3) is a combined marking and striking knife made of hard steel.

SAWS are divided into a number of classes according to their design and system of teeth (Fig. 8).

A **Hand Saw** is illustrated in Fig. 8 (9). The rip saw of similar shape is properly called a **Half-rip Saw**, length 28 in., teeth spaced $\frac{1}{4}$ in. apart, and is used for heavy cutting or "ripping" up stuff. The **Hand Saw** ranges from 20-26 in. in length, the blade of steel, teeth $6\frac{1}{2}$ to the in. and $\frac{1}{8}$ in. deep.

Panel Saws are rather smaller in size and the teeth are also closer together. The length ranges from 16-26 in. They are especially suitable for young handcraft students for cross cutting and general use. The American Disston saws are of specially good quality, and their being made with a blade slightly tapering in cross-section, reduces the necessity for much "set" upon the teeth.

A **Tenon Saw** is illustrated in (7). Made with iron or brass backs, according to quality. The thickness of the blades and the spacing of the teeth vary. The blade is held tightly by the metal back, and, as also with dovetail saws, the process of fixing them is as follows: The back is bent slightly in its length and is then closed over the handle end of the blade. The remainder of the blade is then pressed into position, and the back is then sprung straight and closed over the steel. The natural tendency for the back to spring back into a curved shape holds the blade rigid and in constant tension. The use of this saw is restricted to light cross cutting and for wide shoulders. It is not used for tenons as the name seems to imply. Disston shoulder saws range from 12-18 in., and are excellent substitutes for the former in educational work; the teeth are smaller and they are not unwieldy.

A **Dovetail Saw** is similar in shape to the tenon saw, but with an open handle. Lengths vary from 6-10 in. with teeth spaced 15 per inch. They are used for cutting dovetails, small tenon cutting, and cross-grained grooves.

(2) shows a **Bow Saw**, so named because of its construction with bow-string tension attachment. The frames are made of beech or box wood with separate handles, and the blades range in length from 8-16 in.; teeth spaced approximately 12 to the inch; width of blade about $\frac{1}{4}$ in. They are used for general curved cutting, such as circles or shaped brackets.

(4) is sometimes called a **Compass Saw**. It is however generally known as a **Keyhole Saw** from its particular use. It is only used for cutting away material inaccessible to the bow saw.

(1) shows a small frame or **Fret Saw**; the best pattern for cutting thin metals, mother of pearl, veneers, or fretwood, and thin material generally. Fret saws are used with the frame; to be obtained in packets of one dozen in varying degrees of fineness. If a saw breaks off, the thumbscrew can be slackened and the opening of the frame contracted, when a broken saw can be fastened in again.

Description of Fig. 8 (continued).

(3) illustrates one type of **Mitre Cut**. Used when cutting butt or mitre joints in mouldings, etc. It is of beech and can be made as a class model.

(5) shows an **Adjustable Bevel**. Used for setting out oblique shoulders and angles and testing bevelled edges. The stocks are made of rosewood and ebony with a dotted adjustable steel blade.

(6) shows a **Hand Drill** for boring hard woods and thin metals. Drills may be obtained with a screw attachment in the handle, which when screwed off discloses a small receptacle used for storing the drills. This instrument is especially useful for boring simple patterns in wood for inlaying in wax or other material.

A **Mitre Block** is shown in (8) with a piece of moulding in position ready for planing. The metal screw action illustrated is much better and quicker to operate than the wooden screw type. These mitre blocks are prepared to shoot wood at angles of 90° , 45° , and $77\frac{1}{2}^\circ$, square or butt, mitre and half mitres respectively.

A **Block Plane**, Fig. 6 (9). Is designed specially for use with the latter.

Oilstones (10) of various varieties are as follows: (1) Washita, a good stone for general use. The cutting qualities vary, and can be judged best by rubbing the thumb-nail along the surface, comparing the relative grip with stones of differing quality. (2) Indian oilstones are rather more expensive than washita. They are excellent cutting stones, rapid sharpeners, and impart a keen edge. (3) Charnley Forest, a close-grained stone. (4) Turkey oilstones, excellent cutters, lasting, and sharpeners, rather more expensive than the above varieties. (5) "Arkansas" an expensive kind, excellent for surgeons' and dentists' instruments and other fine tools. It is composed of pure silica, crystallized similarly to the washita stone, has a perfectly smooth surface, and yields only to the cutting of a diamond when being trued up; this stone is very expensive.

Slips (13), may be obtained of various sections. Suitable for sharpening gouges and shaped plane-irons in any of the preceding kind of oilstones.

Pincers (14), do not demand a detailed explanation here, being a tool familiar to all.

(15) shows a **Twist Gimlet**. Used for boring holes to receive screws.

(11), a **London pattern Hammer**.

(12), a **Set Mitre** for setting out mitred work.

(17), a **Bradawl**, which when being used should have the cutting edge of the blade placed across the grain, thus avoiding the splitting of the wood fibres.

(18), a **Screwdriver**.

Fig. 8 (19, 20), a **Rasp** and **File** respectively for wood. To be obtained in varying degrees of coarseness. The latter cut specially for use with wood.

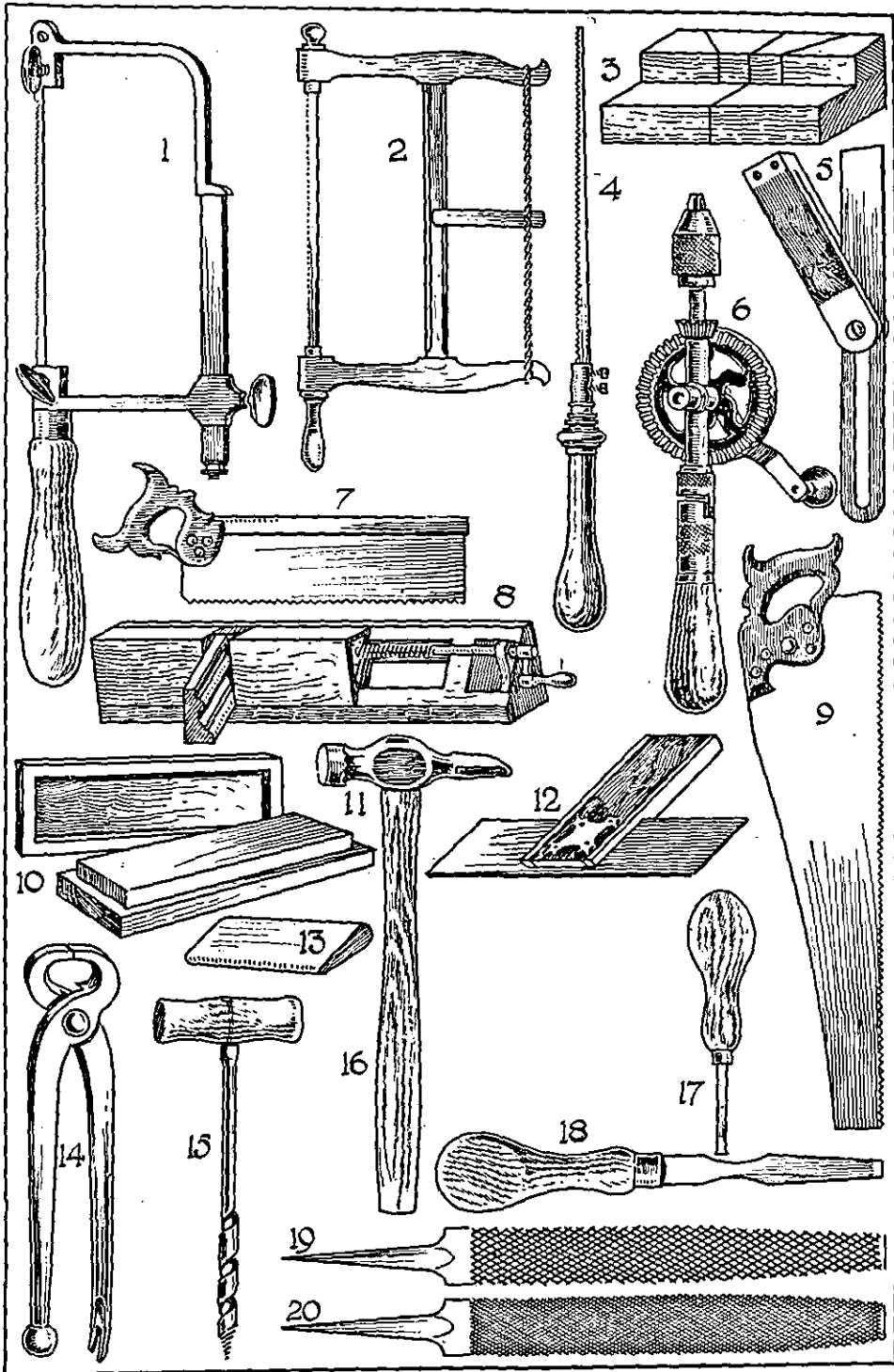

FIG. 8.—Saws and various other woodworking tools.

CHISELS AND GOUGES.—The **Firmer Chisel**, see Fig. 9 (2), is so called because it is the firmest type of paring chisel. Firmer chisels are made from $\frac{1}{8}$ - $1\frac{1}{2}$ in. wide of well-tempered steel, and used for general chisel work where striking with a hammer or mallet is not necessary. A **Paring Chisel** is shown in (1), the blade of extra length, and used for work inaccessible to a firmer chisel. The width of blade varies from $\frac{3}{4}$ - $1\frac{1}{2}$ in. All chisels are made with either square or bevelled edges; the latter, see (3), afford an advantage in dovetailing and in bevelled work where a square chisel edge could not be entered in the corner. (4) shows another kind of handle, made chiefly in boxwood. Fig. 10 (1) illustrates a **Firmer Gouge**, made from $\frac{1}{4}$ - $1\frac{1}{2}$ in. in width and of varying curvature. Firmer gouges are always ground and sharpened on the outside face, distinguishing them from scribing gouges—which are sharpened upon the inside—thus enabling

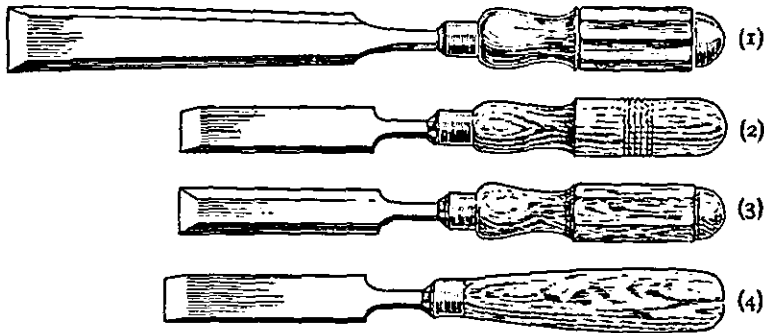

FIG. 9.—Various types of chisels and handles.

a cut to be made square with the face of an object or moulding. Firmer gouges are especially useful for recessing work—such as the concave shape in a pen tray, etc. Carving gouges are made of hard-tempered steel, much thinner in section, with the bevel hardly perceptible, and are made in various shapes.

Mortise Chisels are illustrated in Fig. 10 (2); sizes range upwards from $\frac{1}{8}$ in. in sixteenths. Their use is restricted to mortising, i.e. the act of preparing the receptacle or cavity to receive a tenon or mortise lock.

BORING TOOLS.—Fig. 10 (7) illustrates a **Brace** with a ratchet attachment which permits the use of this tool in a corner, where an ordinary brace could not be used. The best types are made with ball-bearing head (see diagram adjoining) and mounted with cocos or ebony wood.

Dowel or Twist Bits are illustrated in (4); sizes range from $\frac{1}{8}$ -1 in. in diameter. They are used for deep boring where a centre bit would “drift” if bored to any depth.

The **Spoon Bit** (3) is used for boring wood to receive screws and effect a clean hole, reducing the possibility of splitting to a minimum.

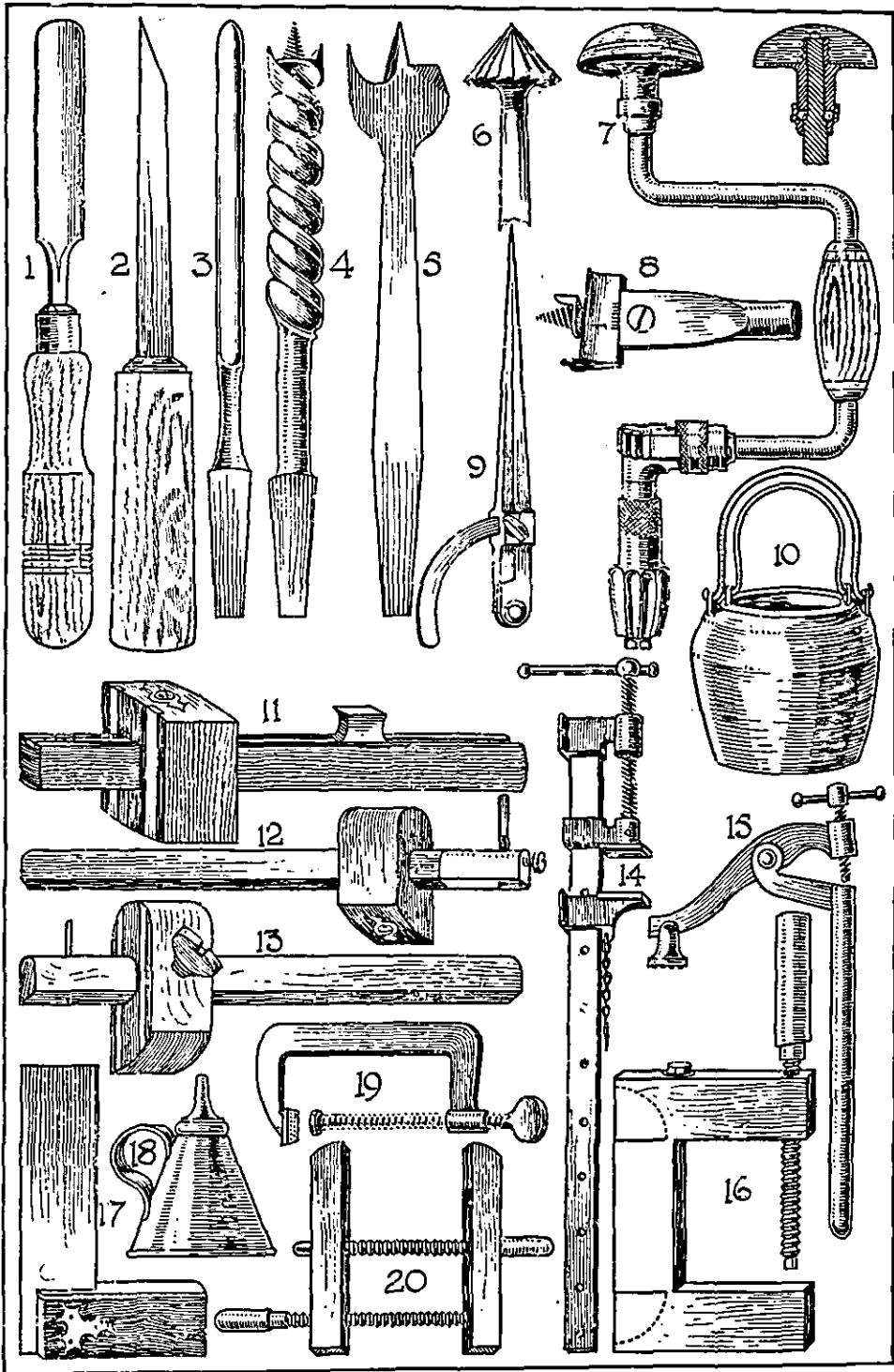

FIG. 10.—Woodworking tools.

Description of Fig. 10 (continued).

Centre Bits (5), are used chiefly for comparatively shallow boring, and the larger sizes are of special utility, as for example, when boring out the core of an oilstone case is necessary.

(6) is a **Rose-head Countersink**.—Used to shape the heads of holes to receive screws. This type bores much cleaner than the **Snail-head Countersink**, which is a quick cutter and useful for large work.

GAUGES.—The **Mortise Gauge (11)**, is made in several qualities and styles of finish, chiefly in rosewood or ebony with brass fittings. The type illustrated is most serviceable, and does not require the use of a screwdriver when the points have to be adjusted. This is the best type owing to its simple action.

(12) is a **Cutting Gauge** with brass-cased head and screw adjustment. This tool is used for splitting thin material, and may be used to advantage in almost every instance where gauging is necessary—making a thinner and cleaner line than the marking gauge. All gauge heads are better when faced up with brass, lasting longer, but working rather heavier owing to the extra grip of the metal-facing.

A **Marking Gauge** is shown in (13). Used for gauging up material previous to planing, and also for the production of lines parallel to an edge from which the gauge is operated. The marking point consists of a small round piece of steel filed to a sharp point. Brass strips are sometimes cut into the face of the stock (see illustration) and add to its wearing qualities. Other gauges of a special character are described in the succeeding chapters.

(9) illustrates a pair of **Steel Compasses** used for marking circular arcs, etc., upon wood. An alternate pattern, which permits of a more speedy adjustment, is called **Spring Dividers**. In addition to their use in striking arcs, the latter pattern are specially suited to the divisions of lines by trial.

Cramps.—(14) illustrates an iron type which has obvious advantages over the wooden pattern. They are stronger and truer, easier to adjust, and do not necessitate the frequent renewal of the screws. They are used for cramping up joints and framing, and are made up to 6 ft. long. Lengthening bars can also be obtained to extend the action of the cramp.

(19) is a **Gee Cramp** for small work—fixing mouldings and slips in drawers.

(20) illustrates the **English pattern Handscrew**, usually made with beechwood chops and split English ash handles. Split material for the screws is essential, or frequent breaking is bound to occur. Hickory, being close-grained, strong, and easy running, is a superior wood for these screws and chops.

The **German pattern** is illustrated in (16), made of hornbeam. A strong handscrew, and more popular with most craftsmen than the English type. Sizes of both vary from 4 in. chops.

A **Glue-pot** is shown in (10). The example is of iron with galvanized lining. Copper glue-pots, although more expensive, are better because of the

Description of Fig. 10 (continued).

quicker heating qualities and freedom from breakage to which the cast-iron type is particularly susceptible.

A **Holdfast** is illustrated in Fig. 10 (15), and is used to secure boards and general work to the bench.

(18) is a suitable kind of **Oil-can**, and that most important tool, the **Try Square**, used for a very large number of purposes, is shown in Fig. 10 (17).

The **Straightedge**, of which several are necessary in the general equipment



FIG. 11.—Straightedge.

of a well-ordered handcraft shop, is illustrated in Fig. 11. They are best made of mahogany with rosewood or satinwood or ebony edging; length varying from 2-5 ft. 6 in.

Winding Strips are shown in Fig. 12. Made from mahogany with ivory or ivorine sights. Short dowels are fixed as shown to keep a pair together when not in use.

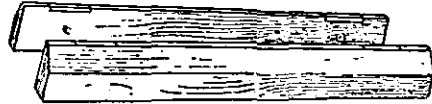

FIG. 12.—Winding strips.

A large **Wooden Square** is shown in Fig. 13. One of this type should

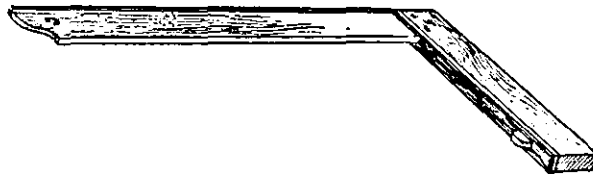

FIG. 13.—Large wooden square.

be included in general equipment. Length of stock and blade varies; the latter ranges from 10-24 in. in length.

A **Shooting Board** is illustrated in Fig. 14. It is best made in mahogany.



FIG. 14.—Shooting board.

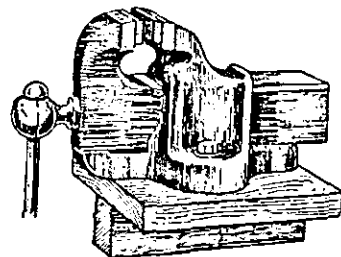

FIG. 15.—A horizontal vice.

A mitre attachment is dowelled to the board, this being used for shooting mitre in clamps, flat mouldings, etc. It can be removed at will.

Fig. 15 is a horizontal vice, one of which should be in every equipment. It is invaluable for holding metal or tools whilst cutting or repairing.

METALWORKING TOOLS AND THEIR USES (Fig. 16).

The tools illustrated in Fig. 16 are as follows :—

(1) **Centre Punch.**—Sometimes called a mitre punch. Used for marking work of all descriptions, also for dotting the place where holes have to be drilled for the centre of the drill to start in. Made of tool steel.

(2) The **Engineer's Hammer** head consists of three parts—the face, the eye, and the pane, pene, or peen. The shaft should be of hickory or ash, and fastened with a metal wedge driven in parallel with the length of the head. The shaft should be carefully fitted so that the oval of the shaft is true with the head; if it is otherwise it causes the student when using a chisel to miss the head of the chisel and hit his hand.

(3) **Scriber.**—Made either of brass or steel—brass for use on iron and steel, steel for use on brass, copper, etc. Used for marking in.

(4) **Outside Calipers.**—Used for measuring the outside diameters of bodies and for transferring sizes from the rule to articles in the round, or vice versa. Usually made of iron or steel and used largely in turning. There are many varieties.

(5) **Wing Compasses.**—Made of iron with hardened steel points. Used for geometrical setting out of all kinds.

(6) **Scratch Card or Card Wire Brush.**—Used for cleaning files by brushing it on the file and in the same direction as the cut of the teeth. It consists of card wire tacked on a piece of wood shaped so that it is suitable for holding in the hand.

(7) **An 8 in. Hand Bastard File.**—Used for filing all kinds of flat surfaces and roughing down any metal. Sometimes called a safe edge flat file, as it has one edge without teeth, for use when filing shoulders.

(8) **An 8 in. Half-round Bastard File.**—Used for the preliminary roughing down of flat and curved surfaces for any metal.

(9) **Hand or Cold Chisel.**—Used for cutting all kinds of metals in a cold state in contradistinction to a hot hand chisel that is used for cutting metals in a hot state. For this purpose it would be 3 in longer and thinner at cutting edge. Made of tool steel.

(10) **Soldering Iron.**—Or sometimes called a copper bit. Used for all kinds of soft soldering. Handle usually of wood, rein of wrought iron, bit of wrought copper. Made in various sizes and shapes; 1-2½ lb. are the most useful weights.

(11) **Tinman's Gas Stove.**—Used by a tinman when soft soldering, so that one iron can be getting hot while the other is being used. Stove made of cast iron.

(12) **Lancashire Hack Saw.**—Used only for soft metals, such as brass, copper, etc. Frame of wrought iron, blade 12 in. long, and thick on edge where teeth are, thin at the back, tempered so that it can be filed; no set to

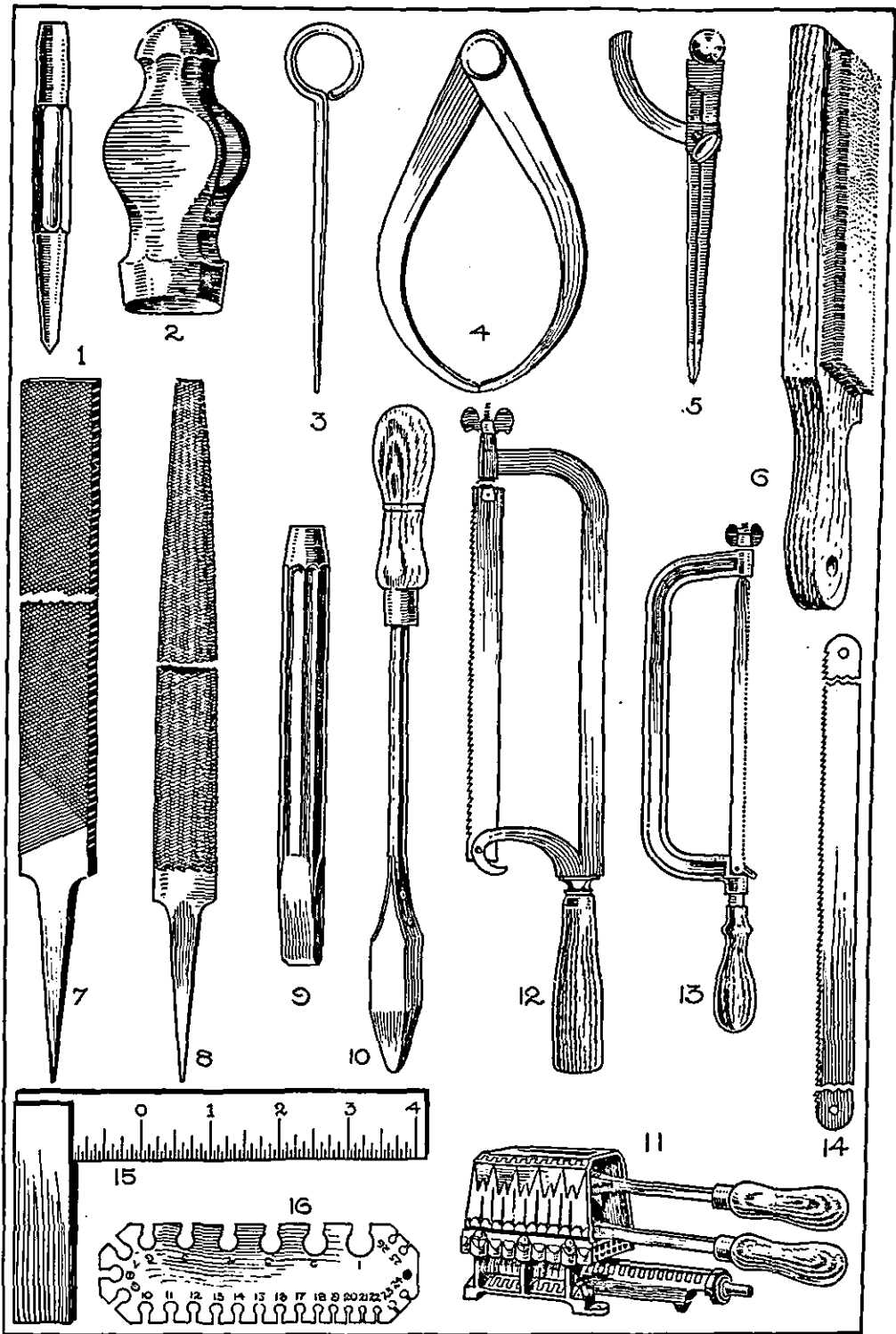

FIG. 16.—Metalworker's tools.

Description of Fig. 16 (continued).

teeth. Should not be used for steel or iron. Teeth 8 or 10 to the inch. Should



FIG. 17.—Method of holding a hack saw.

(13) **Star Hack Saw.**—Used for steel and iron as well as other metals. Frame of cast-iron, blades 8 in. long, hardened, cannot be filed. Teeth 14 to the inch. Can also be had with twenty-three teeth per in.

(14) **Hack Saw Blade.**—Measurements taken over all. Sometimes tempered so that they can be filed, or hardened so that they cannot be filed, or hard teeth with soft backs.

(15) **Steel Try Square.**—Made of all iron or steel, sometimes with or without measurements, hardened or soft.

(16) **Imperial Standard Wire Gauge.**—One of the gauges used in measuring the various thicknesses of metal. Made of steel and hardened and tempered. Not used for steel wire, lead, zinc, silver, or gold.

The tools illustrated on Fig. 18 are as follows :—

(1) **Double-handed Tap Wrench.**—Used generally for turning a tap. Holes made to suit various sized tap heads. Made of iron or steel.

(2) **Adjustable Tap Wrench.**—Used for the same purposes as No. 1, with the exception that adjustment is obtained by turning the right-hand handle which has a hole for a lever to assist in tightening.

(3) **Single-ended Spanner.**—Used for turning bolts and nuts. Made of malleable iron with case-hardened jaws.

(4) **Double-ended Spanner.**—Used for the same purpose as No. 3.

(5) **Stillson Wrench.**—Really an adjustable spanner with teeth; the more pressure put on the handle the tighter the grip in the jaws. The teeth are in opposite directions, and they mark the object being held.

(6) **Double-action Coach Wrench.**—Also an adjustable spanner, but the jaws open and close very quickly, owing to the two screws which are right and left handed; also a better grip of the object being held in the jaws can be obtained. Sometimes called a monkey wrench.

(7) **Stocks and Dies.**—The stock is that portion with handles which holds the dies. The dies are adjustable by means of the set screw, and a number of sets of dies are usually supplied with the stocks. These are used for outside screwing of all sorts up to the capacity of the stocks.

(8) **Stocks and Dies.**—Sometimes called fine dies for brass, as they are usually used for screwing brass and copper tube, and the thread is twenty-six to the inch. This thread is used largely in brass work. The dies are for three different sizes and denote the outside diameter of finished work. There is also a wheel for cutting off thin tube, which, like the dies, is adjustable by means of a thumbscrew.

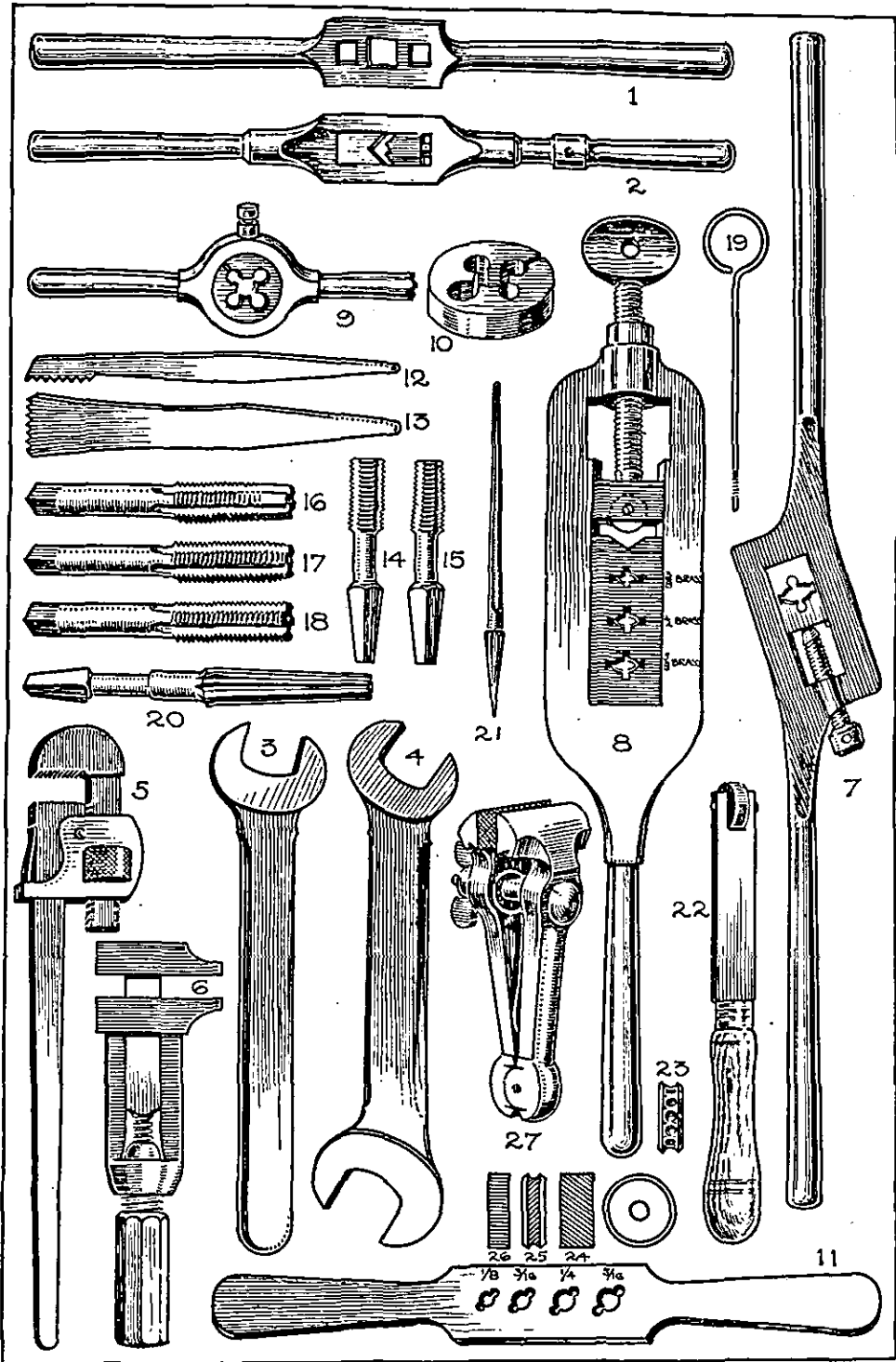

FIG. 18.—Metalworker's tools.

Description of Fig 18 (continued)

(9) **Stocks and Dies.**—Sometimes called B A. stocks and dies (B.A. means British Association). Stocks are usually of gunmetal, and the die is in one piece. A saw-cut is put in one side of die and a small set screw to allow a small adjustment by means of the springiness of the die to compensate for wear. The dies are held in their place by means of the milled-headed set screw shown, and sizes are known by number from 0 to 10, 0 being the largest. This is the B A. standard.

(10) **Circular Split Die.**—This is the die used in the stocks of No. 9, sometimes called a button die.

(11) **Double-handed Screw Plate.**—A piece of flat steel, pierced, tapped, hardened, and tempered, for screwing pins by once running down. Made largely to suit Whitworth standardized threads.

(12) **Inside Chaser.**—Sometimes called inside screwing tool, or inside comb chaser. Made in all pitches for screwing internal vee threads; it has to be fixed into a handle and used by hand.

(13) **Outside Chaser.**—Used for cutting external threads of all kinds and sizes. Makes a pair with (12).

(14) **Plug or Bottoming Tap.**—The one illustrated is a $\frac{3}{8}$ in. fine thread, that is twenty-six to the inch.

(15) **Taper Tap.**—Makes a pair with (14), and this pair with the remaining ones for $\frac{1}{2}$ in. and $\frac{5}{8}$ in. would make a set with the stocks and dies (8).

(16) **First Taper Tap.**

(17) **Second Taper Tap.**

(18) **Plug or Bottoming Tap.**—These three form a set of taps and are of one size and pitch. Used in combination with the stocks and dies (7).

(19) **A Wire Tap.**—Made only in small sizes; it does away with the necessity for using a tap wrench.

(20) **A Reamer or Rimer.**—Made in all sizes, and used for enlarging holes. The ends are made tapered and squared so that they can be turned by means of a tap wrench or used in a fitter's brace, illustrated in Fig. 20 (9).

(21) **Broach.**—Has five flat sides. Used for enlarging holes.

(22) **Milling Tool.**—Sometimes called knurling tool, consisting of a knurling wheel which runs on a hardened pin in an iron holder. Used by pressing against the work, which is revolved in lathe, when the knurling wheel cuts a pattern on the work.

(23) **A Pearling Wheel.**—Used in the same manner as a knurling wheel, but mostly used to decorate, or put a series of pearls or beads on a circular object.

(24, 25, 26) **Knurling Wheels.**—Used in the holder (22). Made of steel and hardened.

(27) **Lancashire Hand Vice.**—Used for holding work in the hand or for holding templets to metal while the metal is being marked out. Sometimes made of all steel or of wrought iron with jaws faced with steel.

SMITH'S TOOLS.—The tools illustrated in Fig. 19 are some of those that are used in the forging of metals.

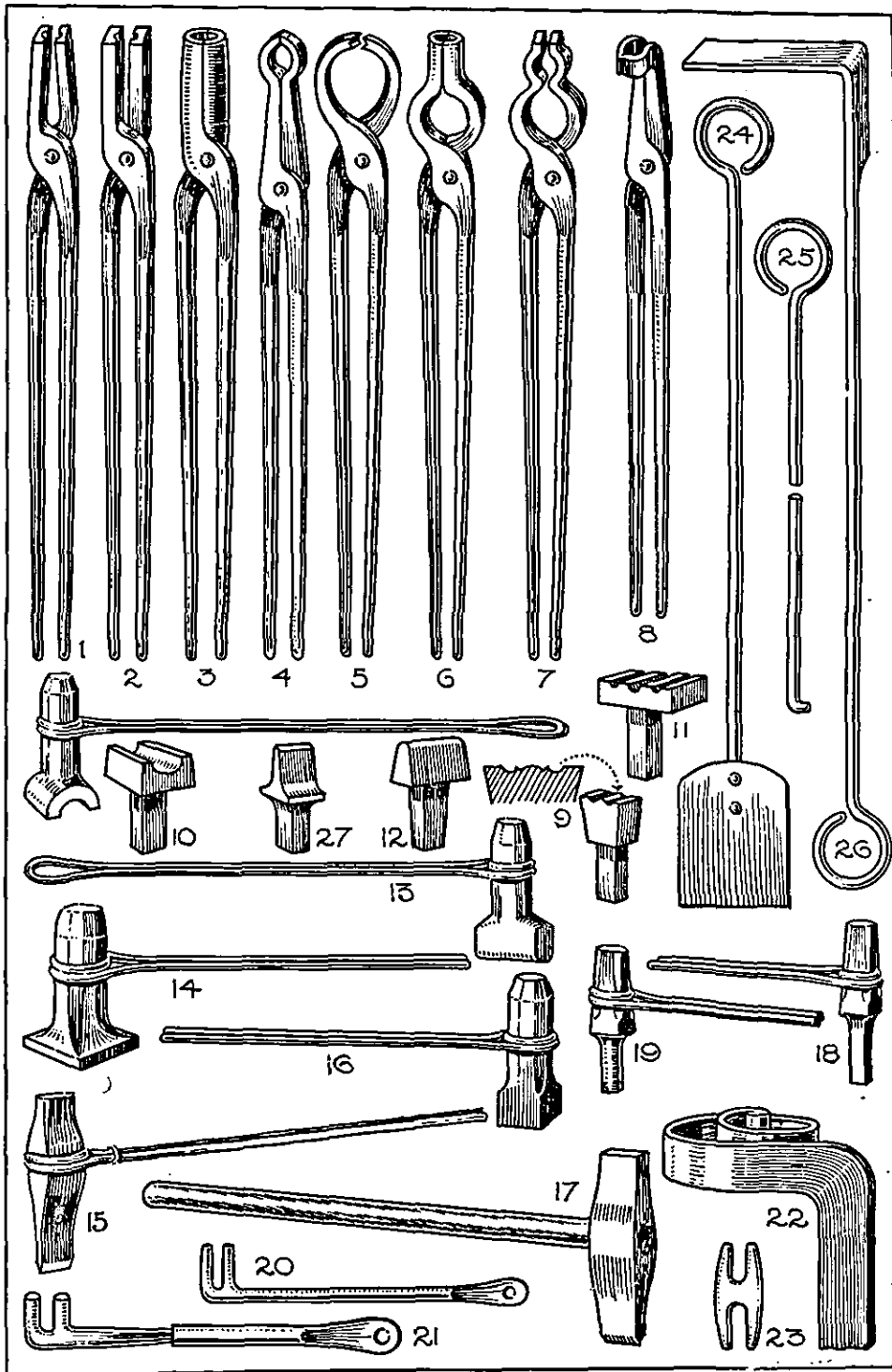

FIG. 19.—Smith's tools.

Description of Fig. 19 (continued).

The first few numbers show some of the tongs in general use, but there is a large number of different shapes which are generally made to fit the work in hand or are altered to fit, as unless the tongs fit the work so that it is held securely, and in the proper manner, an accident is likely to occur. Forge tongs are made of wrought iron and of all sizes.

(1) **Open-mouthed Tongs.**—Used for holding medium-sized pieces of round or square iron. Sometimes called flat bills.

(2) **Close-mouthed Tongs.**—Used for holding small sizes of round or square iron. Sometimes called flat bills.

(3) **Hollow-bit Tongs.**—Used for holding round iron. Sometimes called round bits.

(4) **Rivet Tongs.**—Used for holding rivets or small round iron at right angles to tongs. Sometimes called ring tongs.

(5) **Bolt Tongs.**—For holding bolts or similar work. The hollow at back of jaw allows the head to clear the tongs. Also used for holding flat iron to bend it edgewise.

(6) **Bolt Tongs.**—Another form of (5).

(7) **Pick-up Tongs.**—For picking up work of irregular shape. Sometimes called mandrel tongs.

(8) **Bent-bit Tongs.**—For holding iron parallel to tongs. Sometimes called side tongs.

Tongs for holding flat iron are shown in Fig. 20 (8).

(9) **Bottom Tool.**—For making mouldings. The iron, a little smaller than the width of the tool, is heated and placed in position and is driven into the tool by means of a flatter and sledge hammer.

(10) **Bottom Swage or Rounding Tool.**—Corresponds with the rodded top swage shown just above it. Used for making anything round, and they are made in various sizes.

(11) **Bottom Swage.**—Of three different sizes, $\frac{1}{4}$, $\frac{5}{16}$, $\frac{3}{8}$ in.; for rounding up small tenons or similar work.

(12) **Bottom Fuller.**—Used in conjunction with (13) for putting hollows or necks in the work.

(13) **Top Fuller.**—Used in conjunction with (12) as above.

(14) **A Flatter.**—Used for bringing work to a smooth flat surface.

(15) **Hot Sett.**—Used for cutting hot metal. It is much thinner than a cold sett and not tempered so hard, and has a sharper angle for cutting edge.

(16) **A Set Hammer.**—Used for setting down square shoulders or similar work.

(17) **A Cold Sett.**—Used for cutting cold metal. Is much thicker than a hot sett and tempered to a dark brown colour, and cutting angle is 60° . Usually fitted with a withy twisted round chisel as shown in Ch. XIV, Fig. 5 (10), or has a hazel rod fitted into the eye as shown.

(18) **A Square Drift Punch.**—Used for punching square holes.

Description of Fig. 19 (continued).

(19) **Round Drift Punch.**—Used for punching round holes.

(20 and 21) **Scroll Wrenches.**—Used for bending metal into different forms; (20) is forged out of one piece of metal, and in (21) the fork is forged from one piece, and a handle made from a piece of gas barrel is shrunk on.

(22) **Scroll Iron.**—When doing a number of pieces which are all the same shape it is quicker to make a scroll iron and bend all the scrolls on it by holding the end of the iron at the centre and pulling it round (usually when the iron is at a red heat), thus making them all alike.

(23) **Scroll Horn or Fork.**—It is put in the vice and used in conjunction with (20 and 21).

(24) **Smith's Shovel or Slice.**—For use at the forge fire.

(25) **Poker.**—Used at the smith's fire. The end is turned up so that the clinker which forms at the bottom of the fire can be picked out.

(26) **Smith's Rake.**—Used for pulling the fuel over the work in the fire, etc.

(27) **Hardie or Anvil Cutter.**—Used for cutting off pieces of bar or rod iron either hot or cold. The hardie fits into the square hole in the tail of the anvil. The iron is laid across the edge of the hardie and the iron is struck with the hand hammer. The iron is then reversed and process repeated, a slight tap and the iron breaks off.

The illustrations in Fig. 20 are of the plant and tools largely used by the smith:—

(1) **Portable Forge**, fitted with a hood, and has a solid tue iron or tuyere of cast iron. The other part of the forge is of wrought iron riveted together. Forges are made in various sizes, and the sizes are those of the bed or hearth, and the one illustrated is 33 × 27 in. The hearth should be about 2 ft. 3 in. from the floor.

(2) **Double-blast Circular Bellows**, made in various sizes. The nozzle is connected to the bellows by means of a piece of leather tubing. If the bellows are at a little distance from the forge, the blast is conducted to the back of the tue iron by means of large-bore gas barrel. The size is the diameter.

(3) **Grindstone.**—The size of this is known by the diameter and width of the face of the stone. The one illustrated is 36 × 5 in. The stone itself is either of natural sandstone, or of some artificial composition. They are of different degrees of coarseness and hardness, and some of the names are as follows: Yorkshire, Newcastle Blue, Bilston. The stone should not rest in water for any length of time as this tends to soften it and so make it wear unevenly.

(4) **Hand-drilling Machine**, one of the simplest forms. Made mostly of cast iron, except the spindles, which are of wrought iron. The drill is fed downwards by means of the hand wheel on top, and holes up to $\frac{3}{8}$ in. diameter can be easily drilled with it.

(5) **Smith's Anvil and Stand.**—The anvil is of wrought iron faced with steel. The parts are as follows: The horn or beak; the chopping step or block or table,

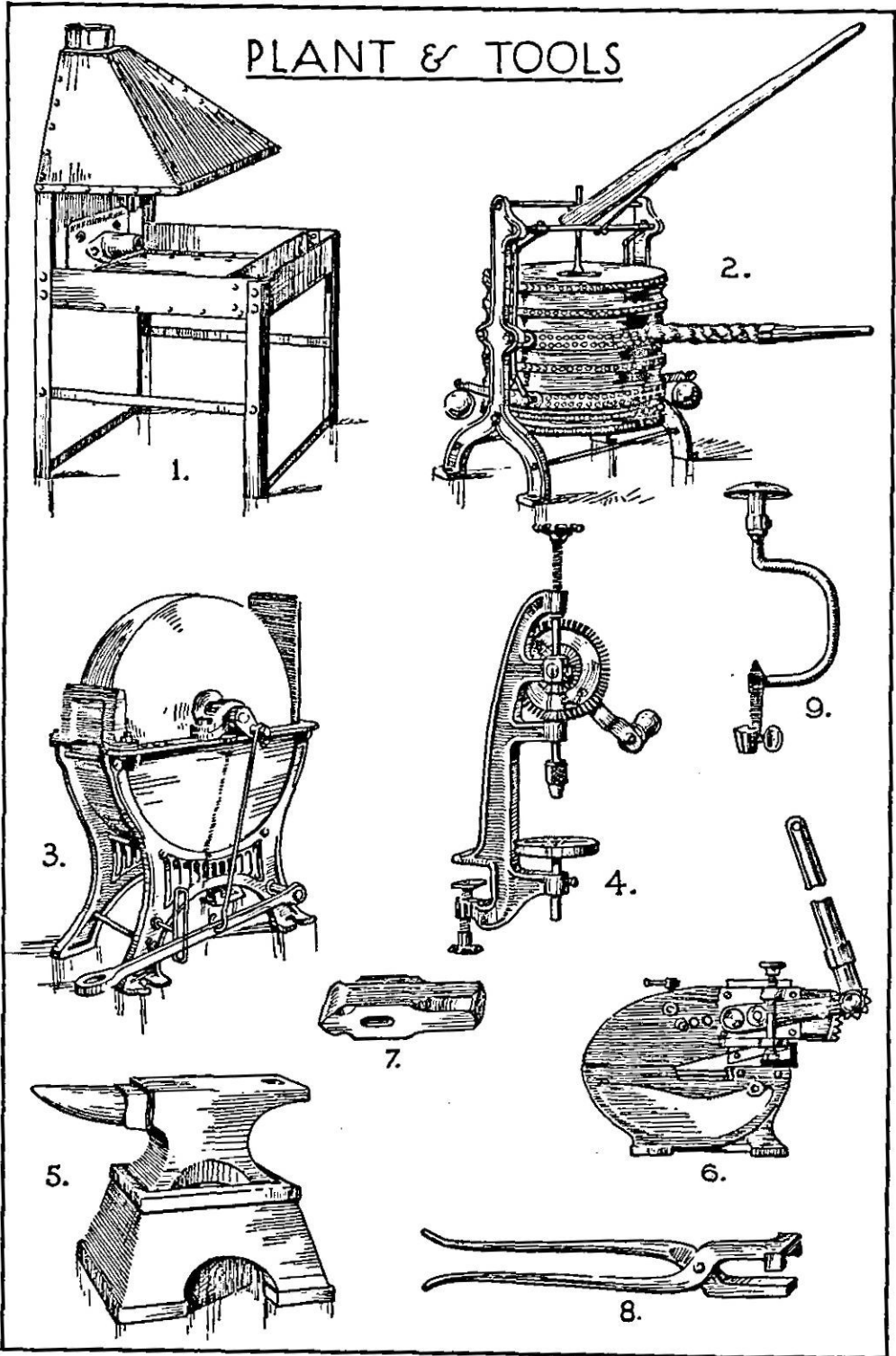

FIG. 20.—Smith's plant and tools.

Description of Fig. 20 (continued)

which is left soft for cutting on; the face, which is hardened and slightly rounded; the tail, which has a square and a round hole in it and is flat. The square hole is for bottom tools, and the round hole is for use when punching small holes. Underneath the tail there is usually a hole which is for placing a lever in, to assist in lifting the anvil. The stand is of cast iron. A tree trunk half-buried in the ground makes a good stand, as it absorbs vibration and does not jump like the cast-iron stands.

(6) **Lever Shearing Machine** for cutting thick sheets and bar iron. That portion which shears the rods is called the cropper.

(7) **Straight Pane Sledge Hammer**.—A useful weight is about 8 lb.

(8) **Box Tongs** for holding flat iron rod.

(9) **Fitter's or Metalworker's Brace**.—It has a taper square hole for the drills and they are fixed with a thumbscrew.

The tools in Fig. 21 are mostly sheet metalworker's tools and are as follows:—

(1) **Two-hole Gas Pliers**.—They are measured over all and the length should be stated, such as 10 in. two-hole gas pliers. Their uses are varied. The 5 in. size are called burner pliers.

(2) **Bellhanger's Cutting Pliers, or Flat-nosed Cutting Pliers**.—Known also by their length over all. Made from 5-10 in. long.

(3) **Round-nosed Pliers**.—Made from 5-10 in. long.

(4) **Manchester Cutting Nippers**.—Made from 6-18 in. long.

(5) **Tinman's Straight Shears or Snips**.—Made also with curved jaws, are then known as bent snips. Made from 6-16 in. long.

(6) **Fret-saw Frame**, best quality. Made of tool steel, used by piercers; measured from saw blade to back of frame. Usual size 12 in.

(7) **Cross-pane Riveting Hammer**.—Head weighs from about 4 oz. to 2 lb. A heavier make of head is called an engineer's or fitter's cross-pane hammer, and weighs up to about 3 lb.

(8) **Round and Square-faced Planishing Hammer**.—Sometimes called a smoothing hammer. Used for smoothing or flattening sheet metal. Made in all weights up to 4 lb.

(9) **Chaser's Hammer or Repoussé Hammer**.—Used chiefly by chasers and embossers. Weight of head from 2-4 oz.

(10-19) **Chasing Tools or Repoussé Punches**, and numbers (10-11) are **Liners or Tracers**; (12-13) are **Raising or Cushion Tools**; (14) is a **Setting-down Tool**, as the straight side is higher than the round; (15) is a **Half-round or Curved Tracer**; (16) is a **Cup or Ring Tool**; (17) is a **Pearling or Ball Tool**; (18) is a **Flatter or Facing Tool or Planisher**; (19) is a **Riffler or Riffle**, used for filing the hollows and shaped surfaces in modelled and cast work.

(20) **Drift**, used for finishing a square hole to an accurate size.

(21) **Creasing Iron**.—Used for knocking up and finishing beads, wired edges, etc.

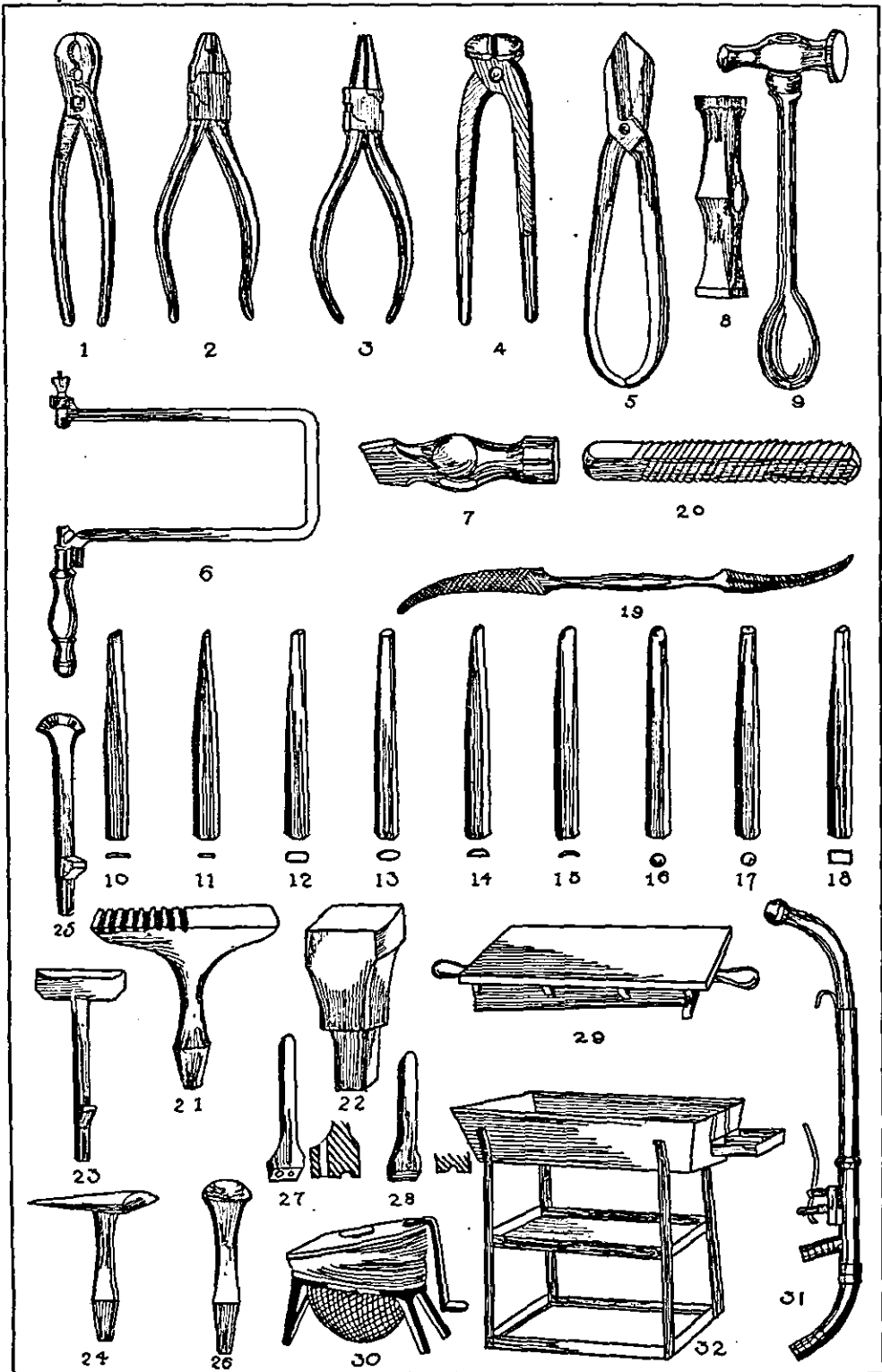

FIG. 21.—Metalworker's tools.

Description of Fig. 21 (continued).

(22) **Tinman's Anvil.**—One edge is rounded off and one side is curved, but the curved edge is square. Made of wrought iron and faced with steel, hardened and polished. Must be kept polished and covered up.

(23) **Hatchet Stake.**—The edge is of steel hardened and polished.

(24) **Funnel Stake.**—Made of wrought iron and polished, not steel faced.

(25) **Half-moon Edging Stake.**—Faced with steel, hardened and polished.

(26) **Pepper-box Head-stake or Ball Head-stake.**—Faced with steel and hardened and polished.

Note.—Nos. (21-26) must be kept polished and well looked after, as any marks on these stakes are transferred to the metal. This also applies to Nos. (8) and (29). These are made in many sizes and weights, and are usually sold by the pound.

(27) **Rivet Set.**—Used for setting down the metal after the rivet has been placed in position. At the side of the hole there is a hollow cup for rounding up the tail of the rivet after it has been hammered over.

(28) **Groover or Seam Set** for setting down seams or folds in sheet metal.

(29) **An Engineer's Surface Plate.**—Used for testing and setting out. Must be kept covered. Usually of cast iron and planed up in a planing machine. Only the most expensive ones are hand scraped. Made in various sizes.

(30) **Fletcher Russell Foot-bellows** for blowpipe work; very useful for small work and does not take up much room. Made in different sizes.

(31) **Gas Blowpipe.**—Used for brazing and silver-soldering and connected with the foot-bellows (30) by india-rubber tube. Known by the size of the outside tube it is made of. The one illustrated is a $\frac{3}{4}$ in. blowpipe with lever-valve gas control.

(32) **Brazing Pan.**—Made of sheet and bar iron riveted together. Filled with coke, fireclay, asbestos, charcoal, or pumice stone, and used for brazing, silver-soldering, etc. A handy size is one about 18 × 24 in. and about 2 ft. 6 in. high to the top edge. The small trays at the side are for spelter and borax.

The tools illustrated in Fig. 22 are mostly lathe tools as follows :—

(1) **Straight-fluted Drill** with parallel shank.

(2) **Morse-twist Drill** with parallel shank.

(3) **Rose Countersink** with taper square shank. This is only suitable for soft metals unless rehardened.

(4) **Slocombe Drill and Countersink** combined. The angle of the countersink is the average angle used for the centres of lathes. This is used largely for the pieces of work that are to be turned in the lathe, as it drills and countersinks the holes for the centres at one operation.

(5) **Lathe Tools.**—Nos. (5-13) make a useful set for use in the slide rest and they are usually made of carbon tool steel, and in different size material according to requirements. No. 5 is known as a **Diamond-pointed Roughing-down tool** or a **hook tool**.

Description of Fig. 22 (continued).

(6) **Round-nosed Roughing-down Tool.**—If used on wrought iron or mild steel it cuts better if the right-hand corner marked A is ground down a bit lower than the front left-hand corner, about $\frac{1}{8}$ – $\frac{1}{4}$ in. lower. But it depends on the metal being cut.

(7) **Right-hand Side Tool.**—Used for squaring up or facing off shoulders, etc., on the right-hand side.

(8) **Left-hand Side Tool.**—Used for the same purpose as (7), only opposite hand.

(9) **Vee Threading Tool** for cutting exterior threads with the automatic slide rest in action.

(10) **Square Threading Tool** for cutting exterior square threads with the automatic slide rest in action. Could also be used for a cutting-off tool. It is also easier to forge the nose at one side of the tool, instead of the centre as drawn. Simply a matter of taste.

(11) **Inside Boring Tool** for roughing out. Used mostly for shallow holes or rings.

(12) **Inside Boring Tool** for finishing cuts.

(13) **Inside Vee Threading Tool** for use with the automatic slide rest in action. The same kind of tool only with a square end instead of a vee is used for cutting inside square threads.

(14, 15, 16, 17) Tools used for turning brass. They have no top rake, and have cutting angles of about 70° to 90° . (14) Is known as a **Ripper**, used for roughing down; (15) is a **Planisher**, used for smoothing or finishing; (16) is a **Round-nosed Planisher**; (17) is a **Right-hand Side Tool** or an offset tool, used for squaring up shoulders, ends, and inside work.

(18) **Lathe Tool Holder.**—Used for holding high-speed steel turning tools. As these small tools can be ground on an emery wheel, and the holder takes the strain of the cutting, steel of small section can be used, so saving cost of material and the trouble of forging.

(19) **Spring Planisher** for finishing off iron and steel. If it springs too much a piece of hardwood is wedged in the hollow.

(20) **Three-jawed Chuck** fitted on to a face-plate of a lathe. The correct name is a **Cushman three-jawed geared scroll chuck**. It usually has two sets of jaws: the ones in the chuck are outside jaws.

(21) **Inside Jaws.**—For Cushman scroll chuck. These are all moved simultaneously by means of a key. Used for holding work that has to be turned.

(22) **An Independent Four-jawed Chuck**, with reversible jaws, slotted for bolts, and has not been fitted to a face-plate. Used for holding irregular shaped pieces of work, parts of which have to be turned. Holds work that (20) cannot hold.

(23) **An Archimedean Breast Drill-stock.**—Used by hand for light drilling.

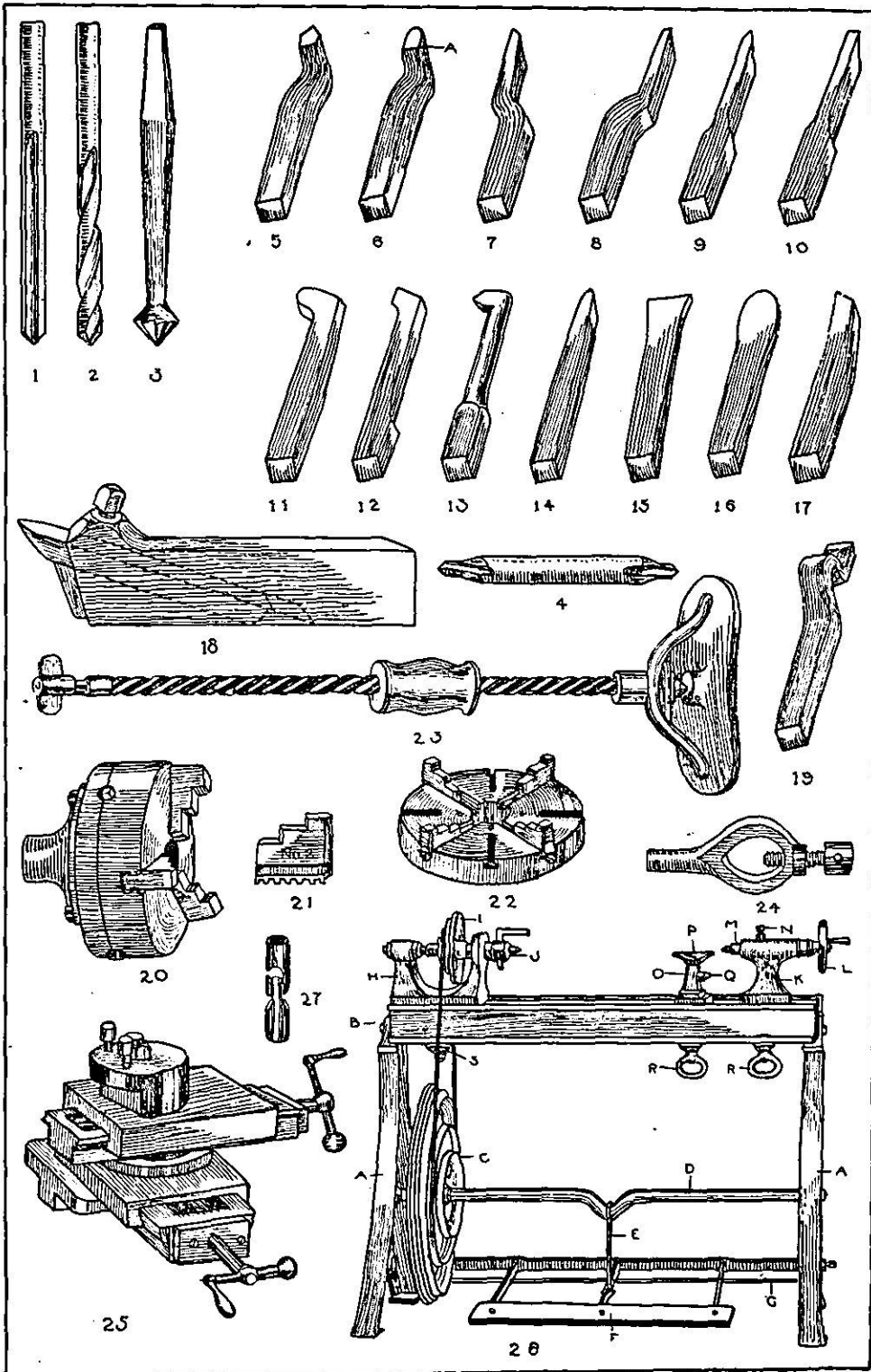

FIG. 22.—Metalworker's tools.

Description of Fig. 22 (continued).

(24) **A Lathe Carrier.**—Used for screwing down on to the end of a piece of work that is being turned between the centres of a lathe. The tail catches on the angle piece in the driving chuck J (26) or the dog in the driver plate. Made in many forms and in cast iron, malleable iron, and steel.

(25) **A Compound Slide Rest,** bolted to the bed of a lathe. Used for holding turning tools and moving them with precision. The circular piece on top is the tool holder and it can be moved in a circle, and the two set screws hold the tool in position. The top slide moves parallel with the bed of the lathe, but it can also be moved in a circle by loosening two bolts which are underneath the top slide, about 30° each side of a line at right angles to the bed of the lathe. The bottom part of the slide rest is fixed, but the whole of the top portion can be moved at right angles to the bed of the lathe by means of the lower screw. The top slide, which turns on the bottom slide, allows for taper turning.

(26) **A Plain Foot-lathe.**—It is very simple, and rarely or never gets out of order. With a few accessories a wide range of work can be done with it. It is usually known by the length of the bed B and the height of its centre. That is the height from the face of the lathe bed to the point of the centre in the driving chuck J. The names of the parts are as follows :—

A. Standards or legs of cast iron.

B. Lathe bed. Usually of cast iron with the top and top edges planed smooth and true.

C. Driving-wheel or fly-wheel of cast iron, with vee grooves, for taking a round belt. A fairly heavy one is preferable.

D. Crankshaft. Made of wrought iron, with the ends case-hardened for the conical bearings. The fly-wheel is fixed on to the crankshaft by a key or with a set screw, the end of which goes a little way into the shaft.

E. Crank. Made of wrought iron. Sometimes called the pitman.

F. Treadle. It should be of hardwood and be as wide as convenient, as then it is more comfortable to use. The bolts after being tightened up should have the ends burred, or riveted up; if not, they soon work loose and drop out. The bar at the back to which the treadle supports are riveted, and which works between two centres, is called the treadle shaft.

G. Back stay or stretcher. Made of wrought iron. Keeps the standards rigid and the correct distance apart.

H. Fast headstock. Made of cast iron, the tail end bored with a hole to take the tail screw, the front end bored to take a coned collar of hardened steel.

I. Driving pulley of cast iron. Fitted on to the steel mandrel. Kept in position by being a force fit. Has four grooves for the reception of the gut band.

J. Driving chuck. This screws on to the nose-piece of mandrel and is fitted with a catch bar which is kept in its place by means of a set screw. The centre is kept in position by being a taper fit.

Description of Fig. 22 (continued).

K. Tailstock or poppet head. Made of cast iron and drilled to receive the barrel M, which is screwed and is made to move backwards and forwards by means of the hand-wheel L. When necessary it is fixed by the set screw N.

L. Hand-wheel of cast iron. This is keyed on to a screw which works in the barrel M, so moving it backwards and forwards.

M. Sliding barrel. Made of wrought iron and screwed for the screw which is fixed to the hand-wheel L. Has a taper fitting at the forward end to take a centre, and has a keyway cut in its length into which a set screw is fitted, so preventing the barrel turning when the hand-wheel is turned.

N. Set screw of wrought iron or steel. Used for fixing the barrel.

O. Tool rest. Made of cast iron. Moves on a base plate, which is fitted to the bed of the lathe. Can be placed in any position.

P. Tee rest. Usually of cast iron, which in consequence generally gets broken. Should be of malleable cast iron or wrought iron. If holes are drilled in the top they add to its convenience.

Q. Set screw of wrought iron or steel. Fixes Tee rest in the correct position.

R. Hand nuts. Made of cast iron. Made like this so that they can be tightened without the use of a lever or spanner. They run up against the cast plates which fit the underneath part of lathe bed; these have a hole in them, through which the bolt passes.

S. Nut and cast plate for tightening up fast headstock.

(27) **Hook and Eye.**—Made of tool steel hardened and tempered to a purple colour and are screwed inside. They are used for connecting the gut belts used on light machinery and foot-lathes. The gut belt is tapered at the end and the hook or eye screwed on until the end of gut comes through; this end is then burnt down level with a red-hot piece of iron. Gut belts can be tightened by twisting them up, or loosened by untwisting them.

THE METALWORKING SHOP.

When setting out a metalworking shop for the purpose of giving instruction, the main idea should not be how much work can be turned out in a given time, or how much labour-saving machinery can we put into a given space, but rather, how can the maximum of instruction be given with the minimum of tools and appliances. By giving instruction without the aid of expensive equipment the resourcefulness of the student is developed as well as his adaptiveness. Moreover, a student, just because he is a student, is more likely to damage expensive tools. Often a student can repair a simple tool that he may have broken, and this in itself is a good training. With the shop planned and equipped with the plant and tools illustrated in Fig. 23, it is possible to do all the work indicated on these pages. All the tools and appliances shown have been proved to be the best and the most necessary for the teaching of metalwork on broad lines. But of course many can be done without, or many more can be added as occasion

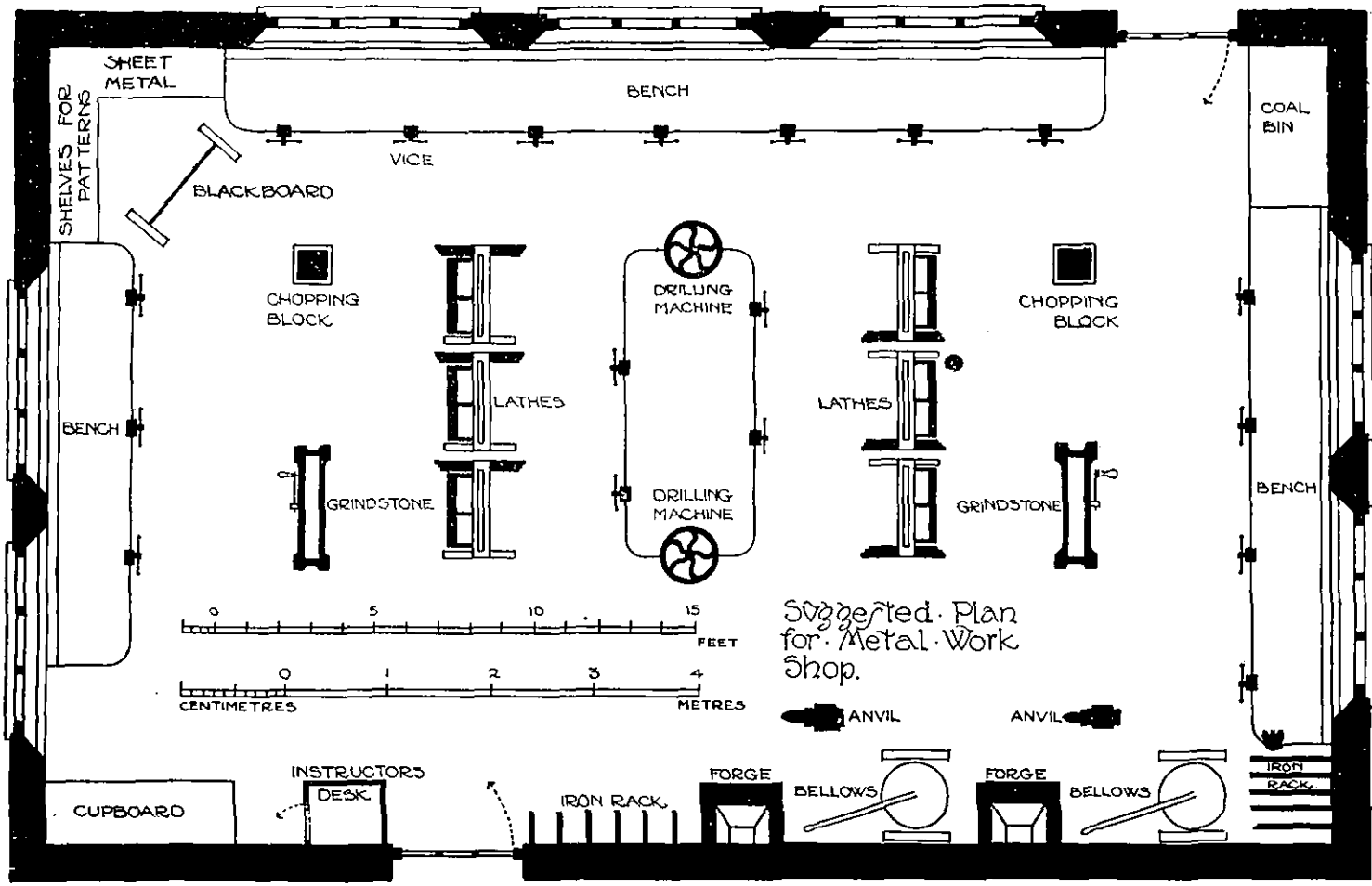

FIG. 23.—Suggested plan for a metalworking workshop.

demands. The plans of shops on pages 264 and 268 are offered as suggestions, and could, if necessary, be modified to suit conditions; but it is based on one in actual use, and is very convenient. An additional advantage would be a store-room for the safe keeping of metals, etc., and a room suitable for the pickling, washing, and dipping of metals, with a small room for lacquering. The necessary working drawings to be used in connexion with the work could be done in the shop itself, as the patterns, tools, etc., necessary for reference are all handy.

With reference to the ventilating, lighting, and heating:—

Plenty of windows with casements and fanlights above, so that artificial light is not used more than is necessary, are suggested. In bad weather the fanlights can be opened when the casements cannot. For artificial lighting the use of individual lights to each vice and lathe, consisting of a single counterweight pendant, with switch lamp holder and lamp, are best. These are economical, as only the light actually wanted need be used.

For heating the shop in winter low-pressure steam seems very satisfactory and comfortable. In Fig. 24 will be seen the section of a bench with a rack for files above.

The bench should be 2 ft. 9 in. high and 2 ft. 8 in. broad; the front board should be of beech 1 ft. 3 in. wide and not less than 2 in. thick. The bottom of the file rack should be 1 ft. 3 in. from the bench. Leg vices are very suitable for general use, as they are more solid to work on than parallel vices. Various sizes should be obtained, say from 3½ to 4½ in. jaw width. The jaws vary by ¼ in. The large vices should be fixed in close proximity to the forges. The rack for smith's tools illustrated on page 266 is most convenient if fixed to the wall by the side of the forges, as then the tools are close by and handy for working. In Fig. 26 is shown a strong wood stand for holding a cast-iron block which is used for chopping out work with hammer and chisel, as illustrated on page 67. The block measures 12 × 12 × 2½ in. A fillet of wood is screwed down all the

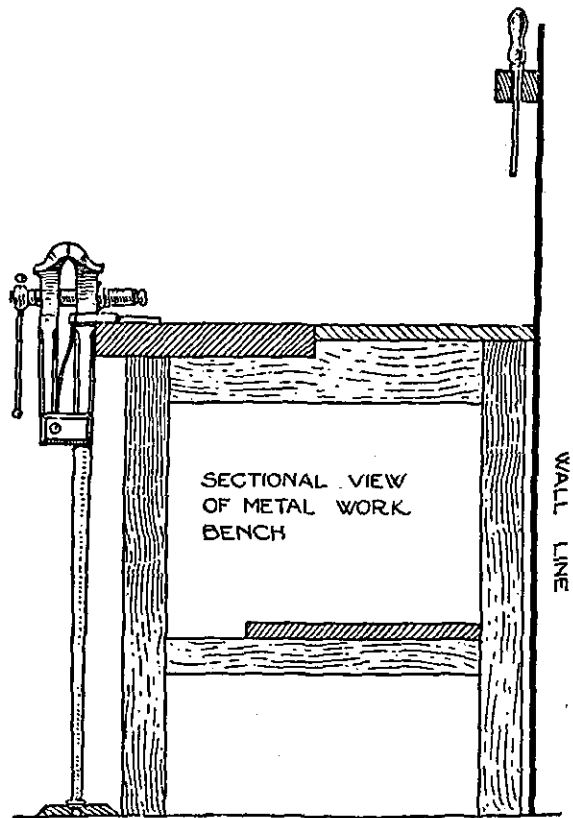

FIG. 24.

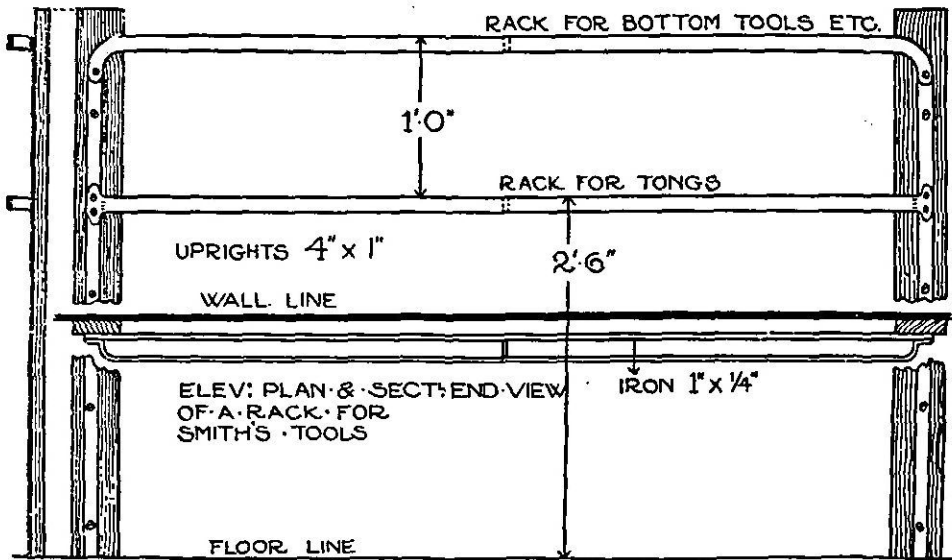

FIG. 25.—Rack for smith's tools.

way round to prevent the iron block jumping off. Six of these blocks should be provided, two for the stands and four for bench use. The shop is designed for use without power; if power was installed the arrangement of the lathes, grindstone, and drilling machines would have to be modified. It is also arranged for eighteen boys and one instructor, but with the aid of another instructor and a little arrangement of the work ten more boys could be accommodated by using the six lathes and two forges, two boys to each forge, so making accommodation for twenty-eight.

If the shop was required for the use of advanced students, some additional machinery would be required, such as a planing machine, screw-cutting lathes, etc., and then power would be a necessity, and for the convenience of working it would be best to have all the machines in a separate shop.

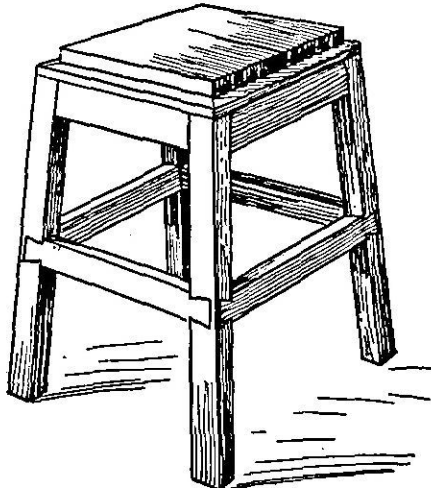

FIG. 26.—A chopping block on wood stand.

Figs. 27 and 28 illustrate the plan, and an interior view of a modern metal workshop, designed for teaching purposes.

Some of the features are as follows :—

It is well arranged for natural light.

The machines are self-contained and electrically driven, doing away with shafting, hangers, and the usual overhead gear.

The drawing bench, with bookcase for books of reference, is along one side.

Many processes can be carried on simultaneously so that the student is able to learn by observation.

The whole of the shop is visible to the teacher in charge from any part of it.

The Education Authority for the school states that the planning, layout, and equipment of the workshop may be taken as an excellent example of what is required for the efficient teaching of metal-work.

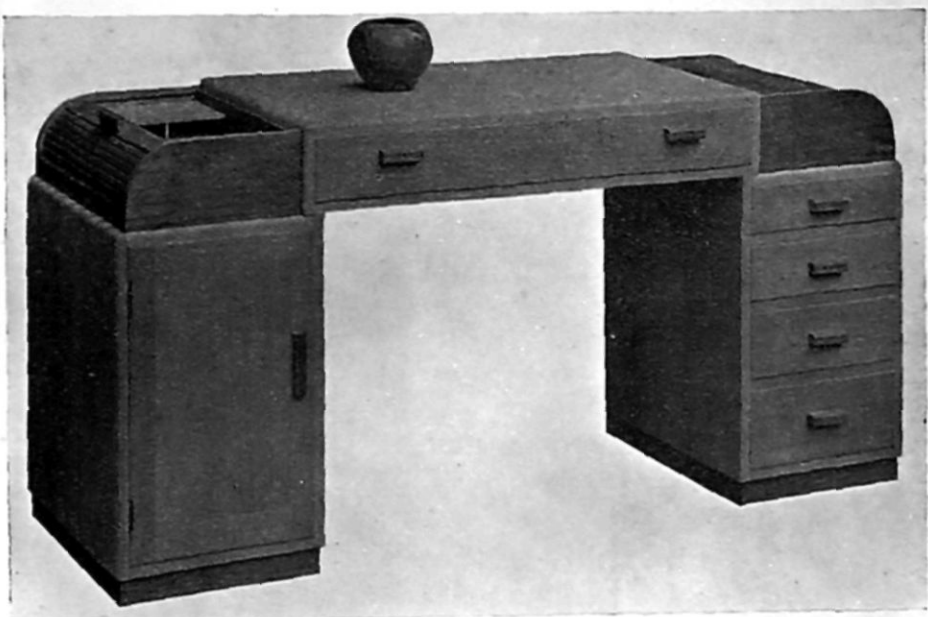

A drawing table with "Tambour" enclosures.

(L.C.C. Shoreditch Training College.)

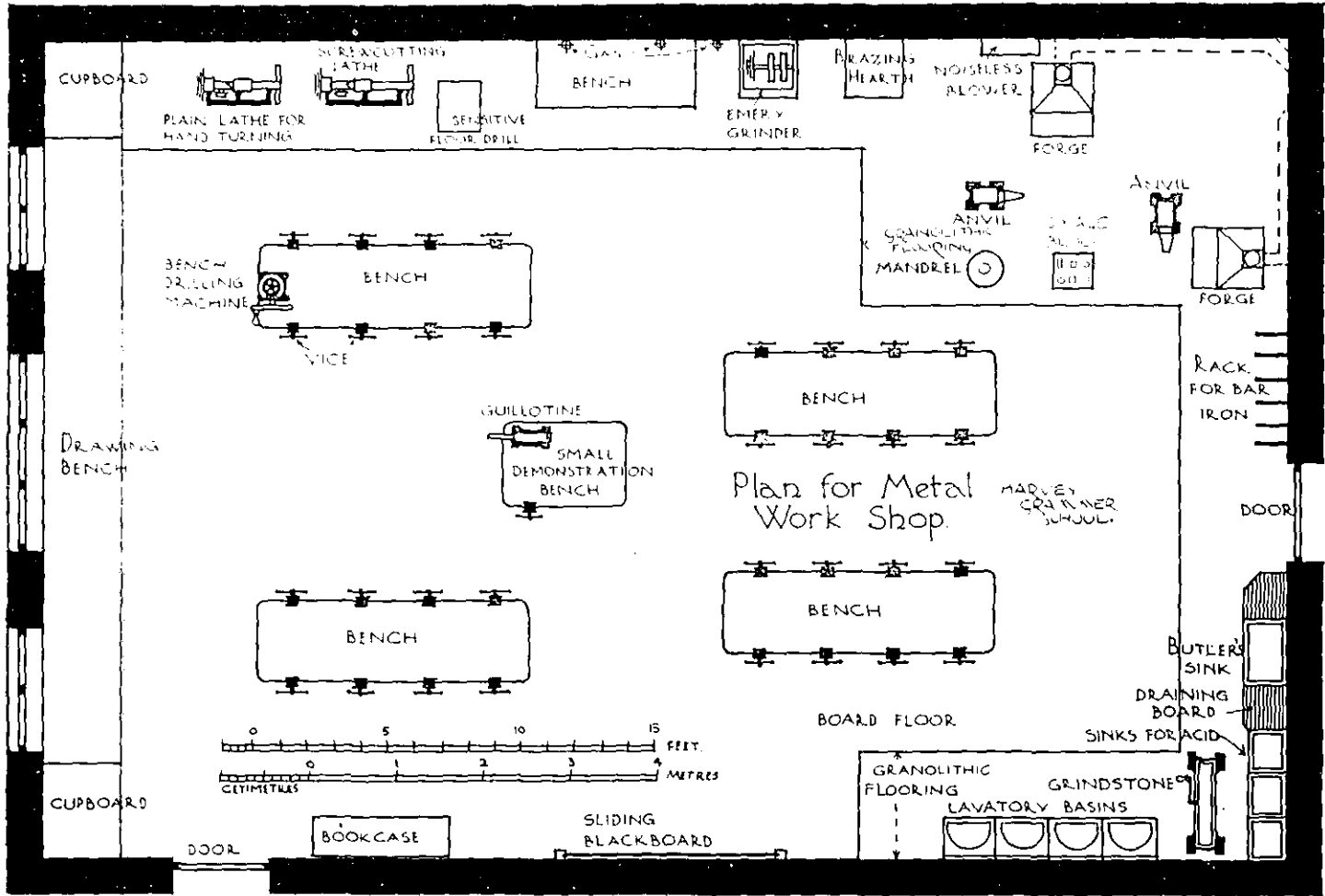

FIG. 27.—Plan of the metalworking shop at the Harvey Grammar School, Folkestone, Kent. Built 1929. Designed by the author.

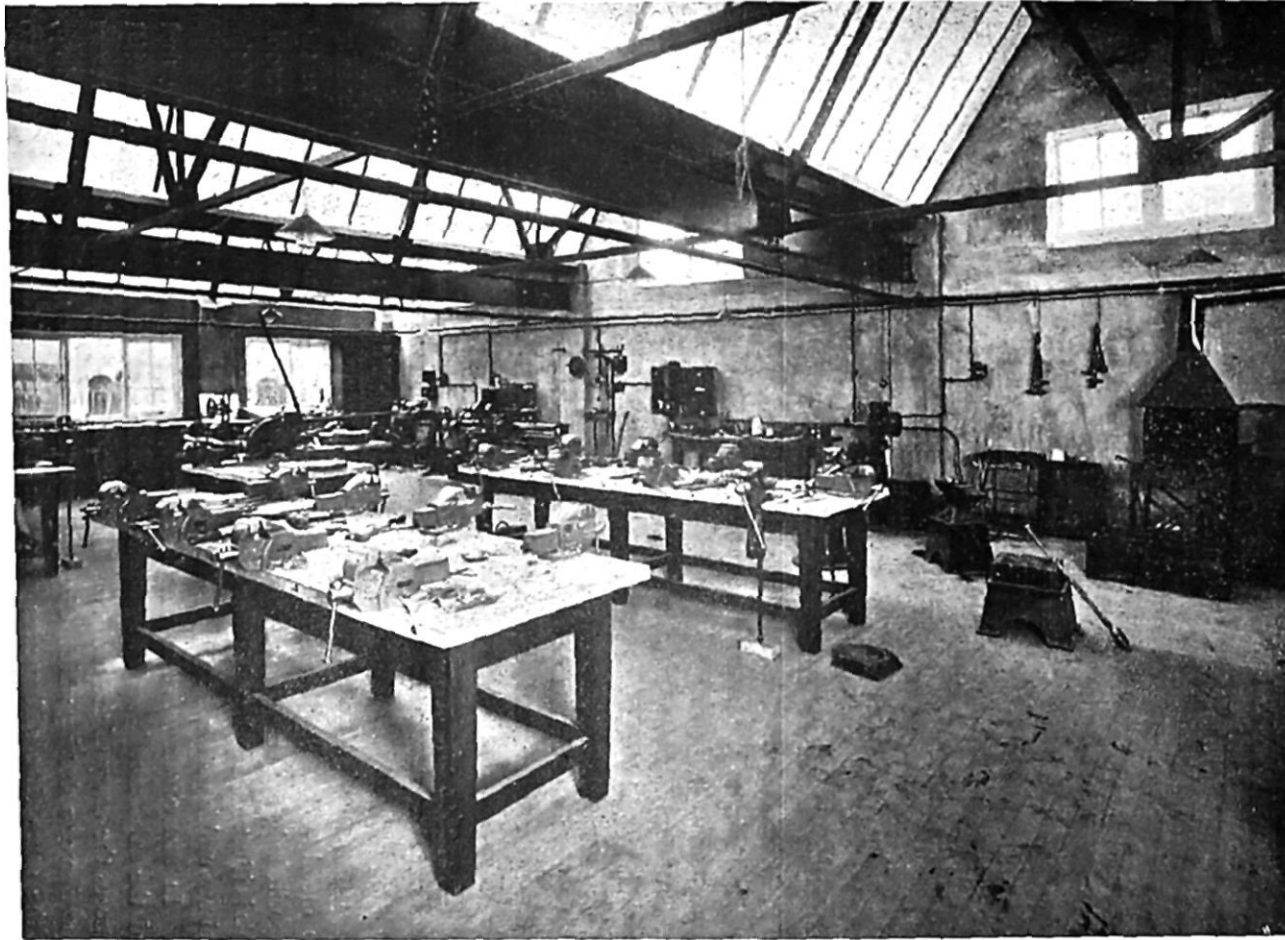

FIG. 28.—Interior view of metalwork shop at the Harvey Grammar School, Folkestone.
 [(Kindly lent by the Director of Education, Kent Education Committee.)]

CHAPTER XVII

THEORY OF CUTTING ACTIONS OF TOOLS

THERE are many methods of cutting metals and necessarily many cutting tools, and a general knowledge of the main principles of the methods is of importance to any one who has to manipulate metals.

Only the elementary cutting tools which can be sharpened without expensive equipment will be dealt with here.

The most efficient cutting angle depends not only on the material of the tool itself but also on the material and condition of the metal to be cut.

To minimize the heat generated by the action of cutting, oil or some other lubricant must be used.

Cutting operations may be classified as follows: Chiselling, sawing, filing, shearing, punching, drilling, turning (including cutting with a diamond), screwing, milling, fusing.

Some of these processes are performed when the metal is cold, some must be done when the metal is hot, whilst for others the metal may be either hot or cold.

The action of a metal cutting tool is generally considered a shearing action. Shearing takes place when sufficient force is applied to tear away the metal from the main body so that the action may be taken as follows:—

Cutting with a metal cutting tool consists of pressing, tearing, and shearing the metal away with the one side or face only of the tool under pressure, as the opposite side is generally clear of the work, as in the action of a turning tool. This is illustrated in Fig. 1, No. 1. With a pair of shears both sides or faces of the tool are under pressure; this is shown in Fig. 1, No. 2.

In many instances a moving force is applied to the cutting edge of the tool and the substance is severed particle by particle. The tenacity of the material opposes the entry of the tool, but the first motion given to the tool, which severs a portion or a shaving which, directly it is away from the main body, is curled up, at the same time still presses down on the slope of the tool so keeping it up to the work. When the tool is too keen, as may be the case with a badly ground turning tool or twist drill, the cutting edge gets drawn into the metal by the same action and the point or edge gets sheared off.

In the use of a "hot sett" or "chisel" the action is rather that of wedging than that of shearing.

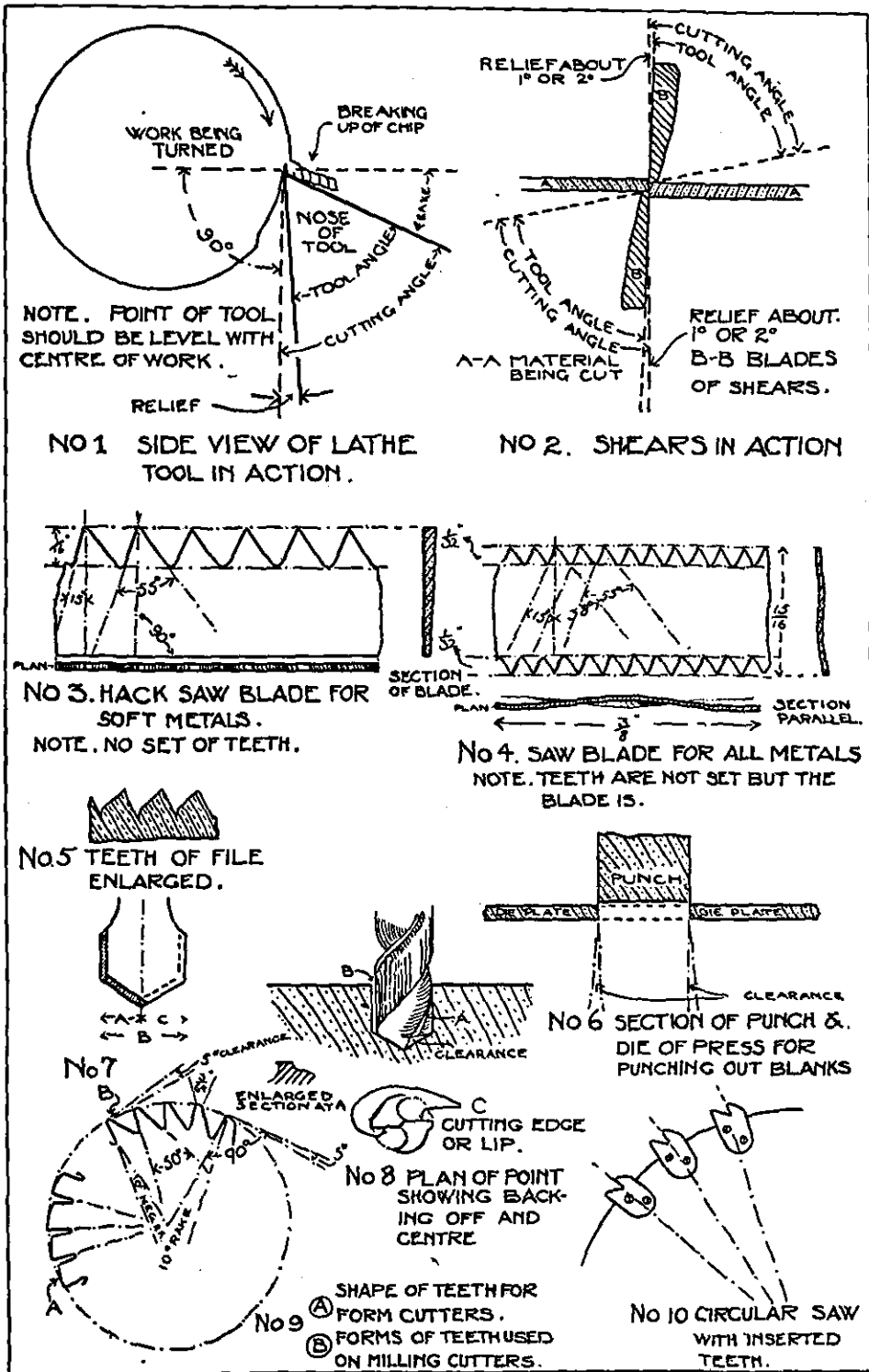

FIG. 1.—Examples of cutting tools, their actions and cutting angles.

Chisels.—Chipping, the removal of metal by means of a chisel and hammer, is becoming obsolete, for machinery does the work better and quicker, and in large works pneumatic tools often take the place of the chisel and hammer. In small shops, however, the chisel is still a very necessary tool, and the one illustrated in Ch. VI, f. 1, is very useful for general purposes; but when used for chipping only, the cutting edge instead of being straight across (as drawn) should be slightly curved, so that in actual use the corners will not break off or be drawn into the metal. For cutting soft metals such as brass, copper, etc., a more acute cutting angle could be used with advantage, say 50° instead of 60° , and it could be left a little harder by cooling out when temper colour is a light brown.

Saws.—The “hack saw” illustrated in Fig. 1, No. 3, which should be held as illustrated in Ch. XVI, f. 17, is used only on soft metals, and the angle to which the teeth should be filed is shown in Fig. 1, No. 3, but the best method is to sharpen the teeth on an automatic grinding machine which not only grinds the teeth to the correct slope but spaces them as well.

Metalworkers do not always rely on “set” of teeth to keep a clear kerf and so prevent the saw from binding, as the saws with thin backs keep their edge better, answer the same purpose, and are more common.

A most efficient saw for cold iron or steel as well as for other metals is shown on the same page (Fig. 1, No. 4). This, a Bradenbergh patent, has a very long life; the peculiar “set” should be noticed. Some saws are made with teeth that are “set” and hardened and the backs left soft.

Metals are now sawn either hot or cold, a circular saw running partly immersed in a bath of cold water for hot metal, in a bath of oil for cold metal. Names of the parts of a saw are as follows: “Space” is the distance from tooth to tooth measured at the points; “gullet” or “throat” is the depth of the tooth from point to the root; “gauge” is the thickness of the saw generally measured by the wire gauge; “set” the amount of clearance given to the saw teeth in either direction to prevent the saw binding and to clear away the chips.

Filing.—A file is one of the principal tools of a metalworker and the most difficult to master. It consists of a steel blade or body of very variable form and size with a “tang” for fixing into a handle. Teeth of suitable form and size are cut on the blade, and the latter is hardened and tempered. Files are classified and described according to the form, use, and nature of their teeth. Most of the terms used to describe the form require no explanation, e.g. parallel, half round, round (a taper round is called a rat tail), triangular; a knife file has a section like the section of a knife blade; a warding file is a very thin flat file used for filing the wards in keys. Pillar and cotter files are narrow files of rectangular section. A riffer is a bent file used for filing concave surfaces. Feather-edge files have a rhombic section with two very acute and two very obtuse angles. The teeth or cut of a file are spoken of as rough, middle, bastard, second cut, smooth, and dead smooth, according to the number of teeth per inch, which

ranges from about 14 to 100 or more. The teeth of an ordinary file form two sets crossing each other at an angle; this arrangement constitutes the double or cross cut. A file with a single set of teeth is termed a float. A safe-edged file is one which has one size or edge without teeth. Rasps may be grouped with files; though their use is chiefly confined to the woodworking trades, their form and process of manufacture are similar to those of files; but the teeth consist of "burrs" thrown up with a diamond-pointed chisel instead of the straight-edged chisel which is used in making the teeth of a file.

The action of filing is similar to that of sawing, consequently it is a scraping action, and if the teeth of the saws in Fig. 1, Nos. 3 and 4, are compared with the enlarged section of the file tooth, Fig. 1, No. 5, on the same page, the similarity is at once apparent. It should be noticed that in all files the front part of the tooth slopes backwards or has what is termed "negative rake". The width of the tooth at the bottom and the height of it have a great deal to do with the life and efficiency of a file, for if the tooth is high and narrow it is liable to chip or wear away more rapidly than if the tooth was of medium height and had a wide base, which gives solidity and length of life owing to having plenty of support under the cutting edge. The angle of the cut in relation to the axis of the file is also important, as by means of this we get a slicing cut which causes the metal to come away in curled chips and with comparative ease.

All files have a small amount of curvature in their length. If a flat file is examined it will be seen to be thickest in the middle, and this allows a nearly flat surface to be obtained by filing, as any high part of the surface can be filed down in that particular place by slightly raising the handle of the file and pressing with the left hand on the front portion of the blade.

A scraper is usually a triangular file ground at the end on all the faces so giving three keen edges which are finished up on the oil stone; of course there are many other forms, but this is very effective. This acts in the same way as a file, only it is like one tooth being used instead of a number, and it has the advantage of being able to be held so that it will cut quickly or slowly according to the angle of the face presented to the work. Another most important point is the height the work should be so as to obtain the best results, and as the work is usually held in a vice this governs the work. The right height for the tops of the jaws of a vice is, when the worker is standing upright with his elbow close to his side and his hand touching his shoulder the tops of the jaws should just touch the point of his elbow.

The most suitable files for use in a general way are 4 in., 6 in., 8 in., 10 in., 12 in.; half round bastards and smooths; safe edge bastards and smooths. A few rat-tail files, and some safe-edge squares might be added as the necessity arose. Files used for iron and steel should be kept separate from those used on soft metals; and when new files that have been used on soft metals will not cut, pass them on to be used on iron and steel which they will cut admirably. New files used on iron and steel get the teeth chipped, and wear out rapidly.

When a file gets clogged it should be brushed with the file cleaner (Ch. XVI, f. 16); if some pieces of metal get jammed in between the teeth of the file and cause scratches on the work being filed, they can be removed by pushing them



FIG. 2.—Position when filing.

out with the corner of a flat piece of brass or iron; these small pieces of metal are called "pins". To avoid these when filing iron or steel chalk the file or put a spot or two of oil on it. When filing aluminium use paraffin or turpentine. The proper method of standing and holding a file is shown in Fig. 2.

Shearing and Punching.—

Shearing is explained in the early part of this chapter, and the action is the same in punching, as both edges cut in each case, and both act on the two sides of the metal. This can be seen by referring to Fig. 1, No. 6. It will be noticed, however, that the punch itself has parallel sides while the die has a very slight clearance to prevent the

punch binding. The use of the punch in smiths' shops, however, is quite different, as when a piece of iron is brought to a bright red heat and then a hole is punched in it by driving a punch which tapers a little outwardly towards the top, through the metal with the aid of a hammer, the hot metal is first of all pressed from underneath the face of the punch and then the punch is usually driven half-way through from each side so forcing the metal outwardly and enlarging the hole. This action makes a swelling on the bar where the hole has been punched, so retaining practically all of the material and hardly weakening the bar to any extent. In the action of punching as illustrated in Fig. 1, No. 6, the bar is weakened according to the amount of material removed, but it is quicker and a machine does the work.

Drilling and Turning.—Drilling, turning, and boring are three different operations. In drilling the work is stationary and the drill revolves, in turning the work revolves, and in boring the work is fixed to the saddle of a lathe which travels in a given direction, while the boring tool is fixed in a boring bar which is placed between the centres of a lathe and revolves.

This is the general practice, but of course there are many variations; the action of boring is similar to drilling, though one could not drill a hole with a boring tool. Drilling differs in principle from almost every other operation in metal cutting, as it cannot be guided in any given direction and is supported by the bearing of the cutting edges of the drill against the material. The ordinary

flat or diamond-pointed drill (Ch. VI, Fig. 7) is a most useful tool, because it can be easily made and tempered, and will withstand very rough usage, but it does not cut in the true sense but scrapes, and requires great pressure to force it into the metal, and cuts very slowly.

If the lip A (Fig. 1, No 6) is longer than lip C the diameter of the hole will be twice the radius of A, as this drill is guided solely by its point, and the hole so drilled will bear no relation to the diameter B. Another disadvantage of this form of drill is that if the metal is spongy or has blow holes in it where a hole is being drilled it will run into the softest part, or into the space away from the harder metal, so giving an uneven or slanting hole.

For rapid and good work twist drills, brought to perfection by Mr. Morse of America, are universally adopted. This drill is illustrated in Ch. XVI, f. 22 To obtain the best results with this drill it should be ground on an emery wheel with an automatic twist drill grinding attachment, for unless the lips are equal a larger hole is made than the diameter of the drill, as illustrated at B in Fig 1, No. 7. If the angles of both the lips (which should be 120° , that is 60° each side of the centre of the drill) are not the same, one lip does all the work, consequently it soon dulls and requires regrinding. Another important point is that if the cutting edge or lip C of the drill is not the highest point or has not the proper amount of "clearance," it will refuse to cut, or if it is too high it gets drawn into the metal and is then broken off.

When the point of the drill protrudes through the stock being drilled, but is not quite through, extra care must be taken or the drill will catch in the fash of the hole and get broken. The spiral grooves of the twist drill provide the "rake," and this causes the chips to curl out of the way instead of being pulverized as is the case with the flat drills and less power is required. Some twist drills have oil holes through the centre so that the cutting edges can be lubricated. The sense of feeling is or can be utilized more in drilling holes than in any other operation, and so the operator can tell whether the drill is doing the work as it should, so avoiding accidents.

Turning — This is partially explained in the early portion of this book (p. 93) and also by the diagram No. 1 on p. 271, but further, the most suitable angles for the various metals are approximately as follows (though the best angle is determined by trial and the shape of the tool being varied according to the hardness of the material being cut) :—

	For Wrought Iron and Mild Steel	For Cast Iron	For Brass and Cast Steel
Cutting angle	60° to 70°	70° to 80°	40° to 90°
Relief	4° or 5°	3°	3° to 5°
Tool angle	55° to 65°	63° to 80°	70° to 87°
Rake	20° to 30°	5° to 20°	0° to 12°

In actual practice the most efficient angle is that which cuts the sweetest and lasts the longest, but the three factors which tend towards or cause the destruction of a turning tool are :—

1. Actual wear due to use.
2. Presence in the material being cut of impurities which are harder than the tool itself.
3. The heat generated which may be sufficient to soften the cutting edge. This last factor does not operate to the same extent where high-speed steel is being used.

In round-nosed roughing down tools such as shown in Ch. XVI, f. 22, No. 6, there should be "side rake" as well as "top rake". Side rake is not shown in No. 6, but it could be obtained by lowering the corner marked A.

Castings of iron should have the scale removed with an old file, or by pickle, or by chipping, before they are turned, as the scale ruins the turning tools owing to its hardness.

The turning tools for brass are very simple, and their cutting angles must be very obtuse or even square as, if made acute they tear the metal or "draw in," and if the job is not held firmly and without any shake it is liable to be full of ripples or striæ. A quicker speed should be used than that in turning iron. Turning tools consisting of black diamonds brazed into suitable shanks are being used in America, and it is claimed by the users that they are as superior to high-speed steel tools as the latter are to carbon steel tools, and in the long run they are cheaper.

Screwing is done in many ways, and when a thread is cut on a piece of work in a lathe, the action is the same as turning, only the movement of the threading tool is sometimes different. Threads are cut by special thread milling machines, by dies which are operated by power, or by hand, by taps. Taps are illustrated in Fig. 18, p. 251. Dies are illustrated in Fig. 18 on the same page. The dies have to be held in various ways, one of which is in the stocks illustrated on the same page.

For cutting screws of different numbers of threads in a lathe the lathe has to be specially designed, and it is usually known as a screw-cutting lathe. The action of a tap cutting a thread is the same as that of a turning tool, as the cutting edge of the thread on the tap has relief made by the "backing off" and rake caused by the shape of the hollows which are milled out of the tap. It is found in practice that when the hole is drilled slightly larger than the theoretical core diameter and then tapped, nearly as good a thread is obtained as would have been if the hole had been the correct size, and this relieves the tap of a portion of the strain. During the cutting of the thread, and owing to the tap forcing its way into the metal, not only is the material removed but it is also squeezed between the threads, so decreasing the diameter of the hole. This illustrates the "flowing" power of metals. This action does not take place in cast iron. In

comb or hand chasers, which are illustrated in Ch. XVI, f. 18, there is relief but no rake, and as they are usually used on soft metals it is not necessary.

Milling is shaping or cutting metal by means of a revolving cutter, and is usually performed in "milling machines," which are made in many forms suitable for various requirements. Cutters are made of almost infinite variety and with varying number of teeth. In some machines the work revolves as well as the cutter. Some work can be done very much quicker on a milling machine than it could be done on a lathe, as milling machines can be run at considerably higher speeds than other tools, as each tooth of the cutter is in contact with the work for only a small portion of the revolution and has a chance of being cooled by the lubricant used. The majority of milling cutters have the front faces of the teeth radial or without any rake, as shown on p. 271, Fig. 1, No. 9, and each tooth should act as a turning tool. Cutters for mild steel cut better with a small amount of rake, but for brass negative rake is necessary. "Form" cutters are those which produce a formed surface and are "backed off" so that they retain their original shape after grinding, which is done on the face of the tooth marked A, Fig. 1, No. 9. Other cutters are sharpened by grinding at B as shown in the same diagram. Milling cutters are also made with inserted teeth, that is, the body is of soft iron and the teeth which are made of special steel are fitted into grooves and screwed into position. This makes a very durable tool, for when a tooth gets damaged it can be easily replaced.

Fusing.—Cutting Metals with Oxidizing Flame.

The oxy-hydrogen and oxy-acetylene flames are specially adapted to cutting metals. When iron or steel is heated to a high temperature it has a great affinity for oxygen and readily combines with it to form different oxides. This causes the metal to be disintegrated and to burn with great rapidity. The metal-cutting blow-pipe operates on this principle. Ordinarily two jets or flames are used. First there is an ordinary welding flame for heating the metal and this is followed by a jet of pure oxygen, which oxidises or burns the metal. The jet of oxygen is made sufficiently strong to blow away the iron oxide in front of it, with the result that a clear narrow cut is effected through the metal at a speed of travel similar to hot sawing. Metal can be cut up to six inches in thickness with the oxy-acetylene, and up to twenty inches with the oxy-hydrogen flame.

Liquid air oxygen has been used in cutting up armour plate fourteen inches thick at a speed of $4\frac{1}{2}$ to 5 minutes per foot run.

A BEAKER (Fig. 3).

Object and Uses.—A drinking cup suitable for presentation. A name or inscription could be engraved on the flat taper sides of base.

Method of Procedure.—

1. Develop body of beaker on a stiff sheet of paper, cut it out and transfer outline to a piece of No. 20 I.S.W.G. metal.

2. Cut out the body and remove all blemishes from both sides of the metal, file a chamfer on each end and bend the metal to a conical form.

3. Anneal the body, pickle and clean it, refit the joint and tie it all together with iron binding wire.

4. Place wet borax on the joint inside and out and silver solder it on the inside.

5. Remove binding wire and place body in pickle until all the borax has dissolved. File off all lumps until the joint is perfectly smooth inside and out.

6. Make a templet from thin sheet metal of the outside curvature of the body, standing the templet vertically and level with the bottom edge of body to test the shape, then hammer the body evenly on a stake until it fits the edge of the templet. Test top edge of body with a scribing block on a surface plate and file the edge level if necessary.

7. Decorate the body as desired.

8. Cut out the blank for the base No. 3, scribing a circle as a guide in working up the sharp angle.

9. File bottom edge level and check top with a scribing block on the surface plate.

10. Bend up the ring for No. 4, silver solder the ends together, make the joint smooth and even, hammer ring to the correct size and shape.

11. Silver solder No. 3 and 4 together, pickle and file off all lumps, etc.

12. Anneal the wire for No. 2, clean it with fine emery cloth, stretch it, then double it and stretch it again, and twist it together, making a close and even twist.

13. Bend twisted wire up into a ring, keeping it small, cut off excess and file ends to the same angle as the twist, anneal the ring, pickle it, refit the ends and tie them together, silver solder them, using a very small amount of silver solder. Pickle and clean the ring.

14. Level the ring and stretch it sufficiently to go tightly on to the body, and push it towards the top as far as it will go, then cover it with a thick paste of rouge and water. This holds it away from the base and protects joint from the heat while the body is being soldered to base.

15. Fit body to base No. 3 and tie it securely into position, silver solder it to base, doing a little at a time. Remove binding wire and place job in pickle until it is clean. Dip job into the bright dip, remove quickly, wash in running water, then in boiling water, and dry out in sawdust.

16. Fit wire circle No. 2 to base and soft solder it into position, using a very small amount of soft solder. Wash well in water, dry out and brush up the twisted wire with a steel wire brush.

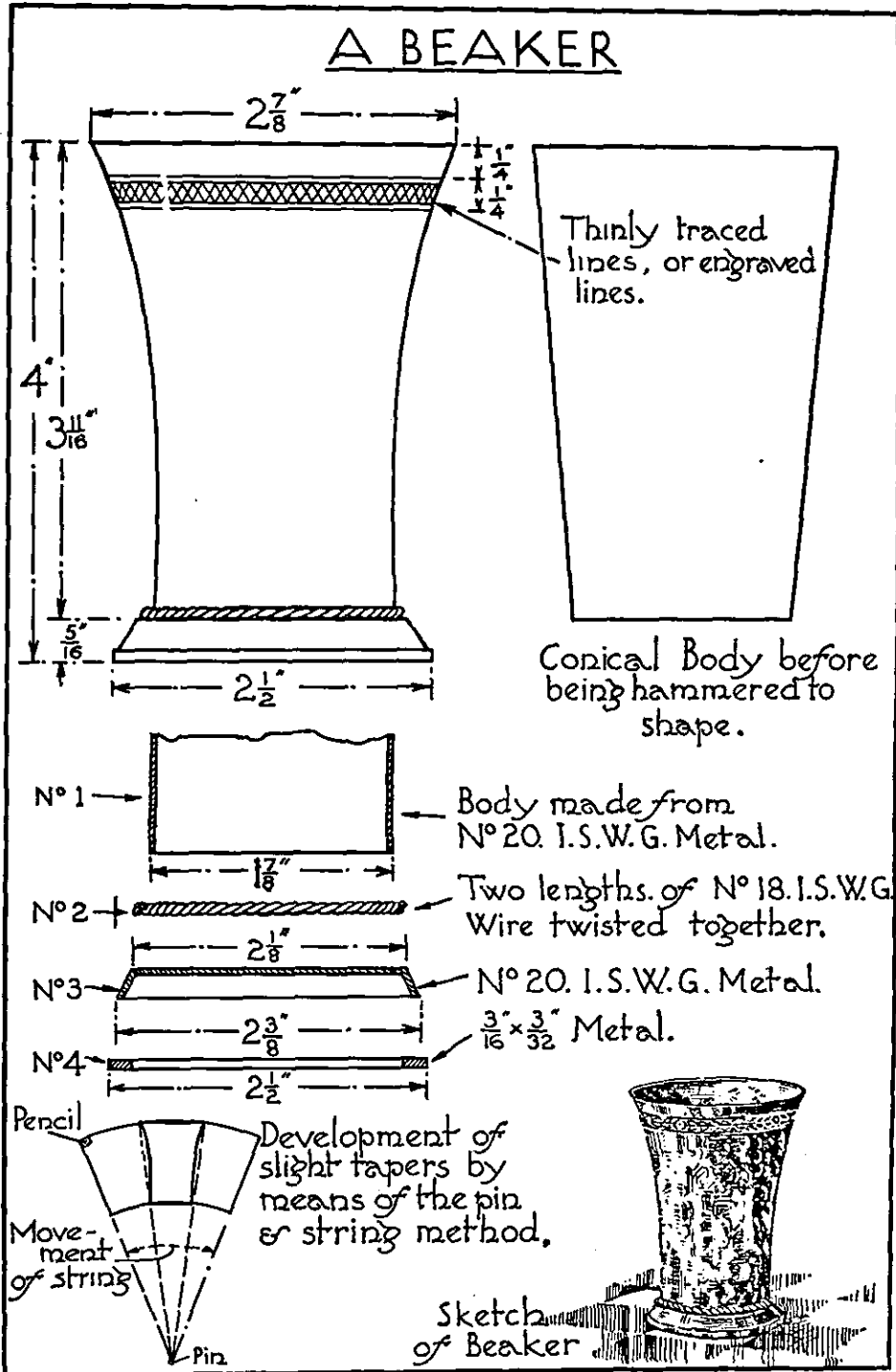

FIG. 3.—A beaker.

17. Clean the job with No. 0 emery cloth and rub up where necessary with Water of Ayr stone; see that there are no sharp burrs anywhere.

18. Test beaker on surface plate. See that it stands firm and that top edge is in alignment.

19. Finish the surface as desired.

No. 1.—Silver plate all over and dull polish.

No. 2.—Silver plate all over and gild the inside, dull polish the outside.

No. 3.—Silver plate and polish the inside and leave the outside a natural bronze colour.

A METHOD OF CASTING VICE CLAMPS

In order to understand casting in metal, the making of vice clamps or clams in lead provides a useful demonstration, and it is with this object in view that the wood mould and vice clamp in Figs. 4 and 5, pp. 281, 282, are suggested. The wood patterns of moulds shown in Fig. 4, p. 281, are fairly simple to make, and when varnished could be sent to a local iron foundry where castings off these could be made in iron at a small cost. When the castings are received they should be cleaned inside to remove any roughness, and outside so that they fit together easily without leaving any gaps. Scrap lead of any sort can be melted in an iron ladle using a gas blowpipe or gas stove to supply the heat. When the lead is molten it should be skimmed and poured into the mould, as shown in Fig. 5. 282. It is most important that the inside of the moulds should be well chalked and no trace of moisture visible, otherwise an explosion will occur.

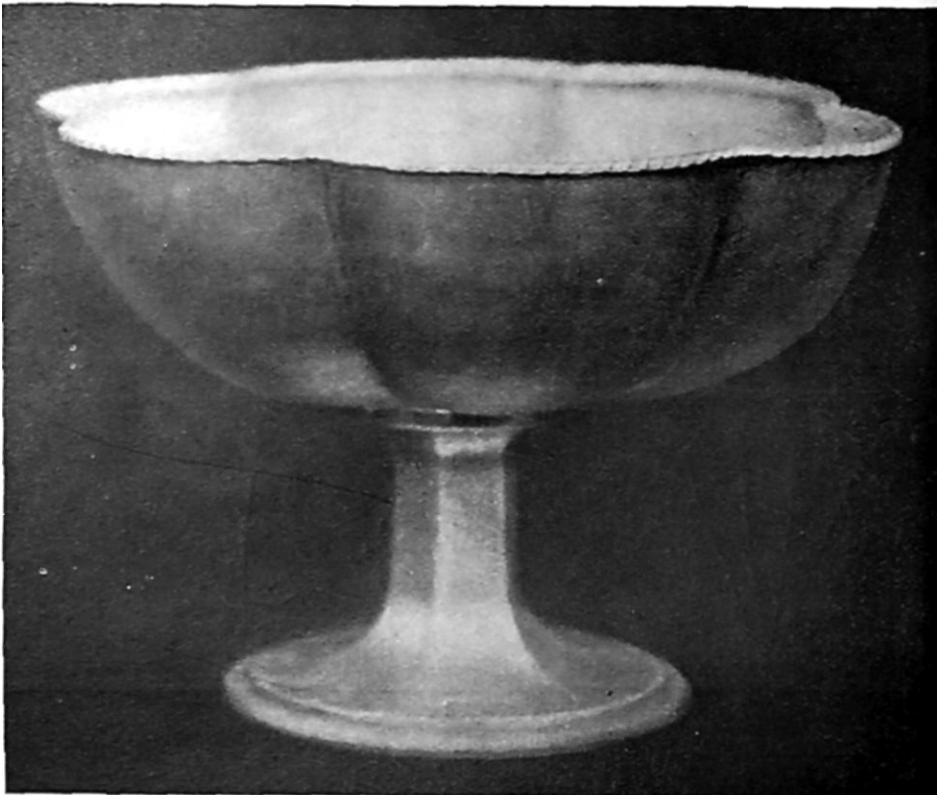

Six-lobed bowl on cast foot.

Height $3\frac{1}{2}$ ins., diameter at top 5 ins., diameter of foot $2\frac{1}{2}$ ins., height of foot $1\frac{1}{2}$ ins.

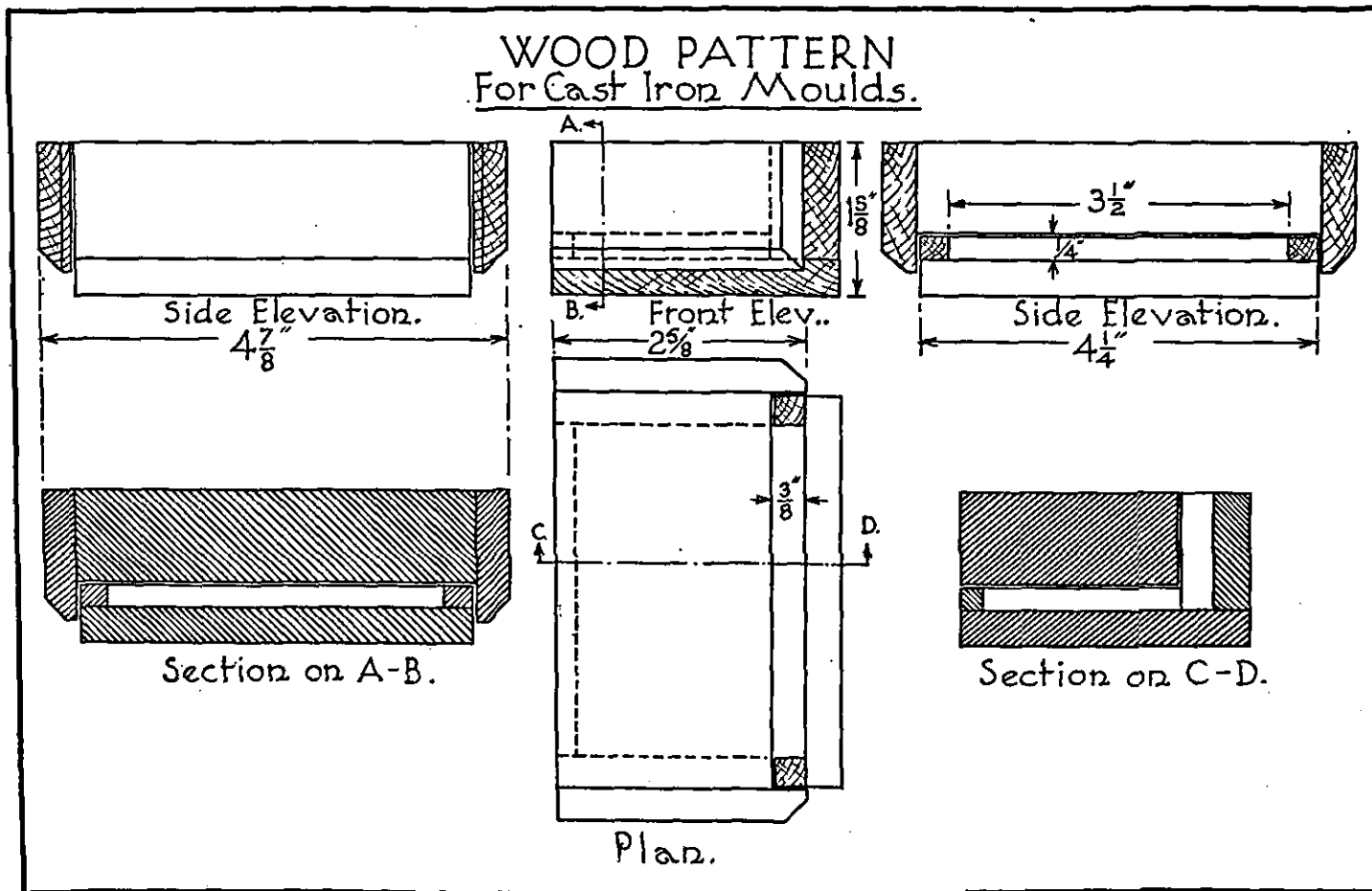

FIG. 4.—Wood pattern for cast iron moulds.

MOULD & CASTING OF VICE CLAMPS

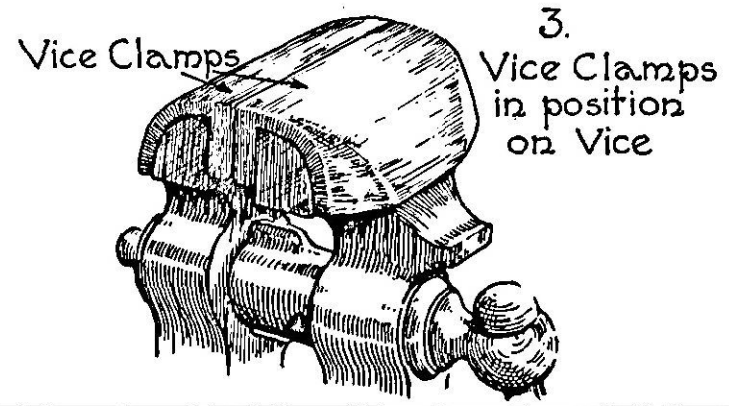
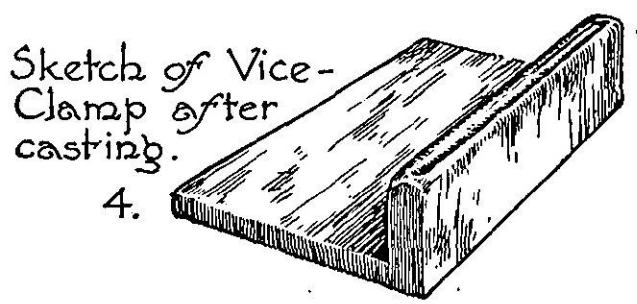
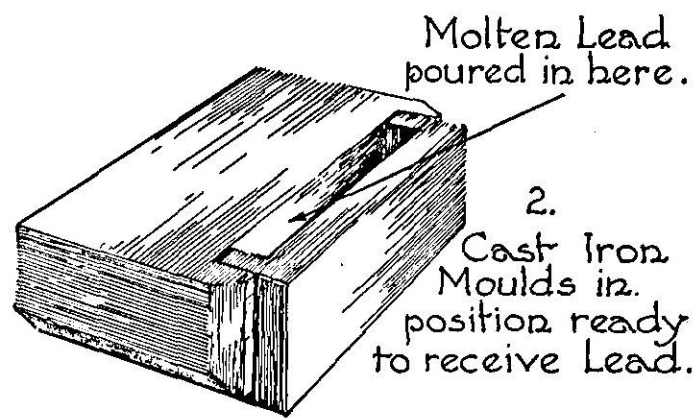
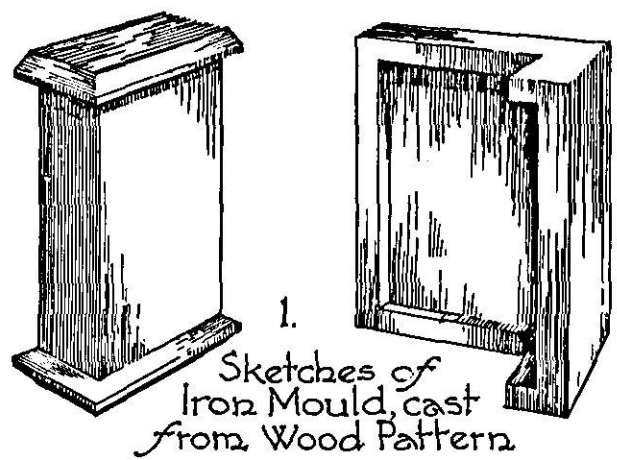

FIG. 5.—Mould and casting of vice clamps.

CHAPTER XVIII

WOODWORK FINISHES

INTRODUCTORY.

THE finishing of metalwork models has been dealt with in earlier chapters, and this chapter is therefore devoted to some methods of wood finishing that are within the scope of students and amateur craftsmen.

There is a wide and ever increasing range of finishes applicable to woodwork having as their primary aim the preservation of the surface in a clean condition, and the addition of decorative value by means of colour, texture or polish. The methods employed in each sub-division vary in technique and material, but they may be separated into four main groups: waxing, painting, polishing and cellulosing. These main processes are dealt with briefly in the following sections.

PAINTING.

This section deals with colour finishes with either lead or metal bases as distinct from the colour finishes associated with french polishing.

Exterior Painting.—Exterior painted finishes for garden furniture such as seats and tables are almost identical to those used for interior work or ordinary house painting. It is important to note that either softwood or hardwood items should be thoroughly prepared. The wood surfaces should be finished “in the white” with graded sandpaper rubbed in *both* directions of the grain. This method, particularly in softwoods, prevents the possibility of a “ribbed” effect in the finished work; and a perfectly flat and level surface can be obtained much more quickly than is the case when sandpapering only with the grain is adopted. When softwood articles are painted, any resinous knots should be painted over with one, or even two, coats of patent knotting, or ordinary gold size, as otherwise exudations from the knots will burn through the final painted surfaces.

All new woodwork should first be covered with one coat of “priming colour” containing red lead. The coat of priming colour serves a double purpose in securing a tenacious grip to new woodwork and obviates future flaking. It also serves as an excellent filler and gives added depth or density of colour to the second coat. The latter is usually a lead paint made with a considerable turpentine content. When a particularly good job is required two coats of lead colour or undercoating are recommended. The final coat usually has

a large varnish content, and the durability of the work is in proportion to the varnish content. Two coats of the final finishing colour increase the durability and also secures a better density in the colour than is possible with one finishing coat.

There are so many excellent proprietary brands of paints on the market that students and amateur craftsmen are recommended to buy the priming or filling coat, undercoating, and finishing colour ready made, and to follow the detailed directions of the manufacturer. It is important to note that fine sandpapering of a perfectly dry coat of undercoating or finishing colour should always precede the application of another coat of paint.

Interior Painting for Furniture.—When large items of furniture such as wardrobes are required to have painted finishes the processes and material are exactly similar to those for exterior works. There are, however, many instances where “super paint” finishes are required, such as mirrors, caskets, boxes and chairs with a “colour quality” comparable to the vermilion, black, blue and green Chinese lacquers in furniture, and in these instances a different painting technique is employed.

Taking as an example the mirror frame illustrated on page 39, the ground-work should preferably be of Honduras mahogany or an equivalent hardwood, fine sandpapered, both with and across the grain.

The next step is to apply a filler. The filling process recommended is thoroughly to cover all surfaces with ordinary shellac french polish, applied with cotton wool. When thoroughly dry the surfaces are sandpapered with No. 1 sandpaper in readiness for the first coat of “body colour”.

Supposing a vermilion lacquer effect is required, “Artists’ Colour” in tube should be mixed with gold size and a small quantity of raw linseed oil. This is applied with a first quality flat brush, taking great care to “lay off” the surface by light brushings both with and across the grain. When the first coat of body colour is thoroughly dry and hard it should be smoothed with No. 0 sandpaper. This process is repeated coat after coat until the required density of colour and finish is obtained.

This process of painting is comparable to the old method of coach painting, when ten or even sixteen coats were applied in order to obtain a perfectly dense colour and “china” finish. Four or five coats are sufficient for small items such as mirrors and then a final coat of a colourless varnish is applied. The later coats should preferably be “rubbed down” with a piece of felt with powdered pumice and linseed oil. A further refinement of finish may be obtained by rubbing down the varnish surface with felt, powdered pumice and oil, and then finishing with french polish applied with cotton wool covered with clean linen rag as in the final stages of ordinary french polishing.

Dull Finish.—When either enamelled, varnished or french polished finishes are required dull instead of the rather hard gloss finish, the surfaces may be dulled by simply sprinkling powdered pumice over the surface and then brushing in

with an ordinary handbrush. A small shoe polishing brush of good quality is quite suitable for this purpose.

Crackle Finish.—This finish is so called because of its resemblance to the “crackle” in old china, and is particularly pleasant when used to finish brightly coloured items. The base colour may be vermilion, apple green, Chinese blue or vellum. The crackle finish is obtained by the use of an astringent varnish which cracks into a crazed pattern after drying. The amount of crackle may be varied by regulating the temperature at which the varnish dries. A higher temperature increases the covering power of the varnish, and results in increased crackle when compared to the amount resulting from lower temperatures. It is possible to introduce a second colour factor in crackle finish by rubbing a contrasting colour into the crackle, taking care that when wiping off all surplus colour is removed from the flat surfaces. Vandyke brown or umber are appropriate for use with an apple green finish. Green is effective with vermilion. The final finish is obtained by the application of a colourless varnish over the whole surface which effectively fixes the secondary colour.

FRENCH POLISHING.

The successful practice of french polishing demands a technique that can only be attained by long practice, and readers who desire to practice french polishing to its full extent are recommended to a handbook dealing in detail with this subject.

The processes may briefly be described as (1) staining the material; (2) filling in with plaster; (3) bodying in with french polish, and lastly, (4) spiriting off.

The materials required are: (a) Plaster of paris for “filling in”; (b) Bichromate of potash for “staining” woods in the mahogany group; (c) Button polish This is so called because it is made of “button shellac” dissolved in methylated spirit; (d) Linseed oil; (e) Pure methylated spirit; (f) Powdered pumice stone.

Modifications of the full process may quite successfully be employed by students and amateurs who do not require the high grade finish of the full process of french polishing and yet require a surface that will not easily mark in use.

Modified french polishing is also of value when the finished article is required to be stained as the polish acts as a fixing medium for the stain.

The following notes cover the timbers most commonly used in domestic woodwork.

Cuba, African and Honduras Mahogany.—The best stain for darkening practically all timbers in the mahogany group is a solution of bichromate of potash dissolved in warm water. This is well rubbed in with a rag and is then allowed to dry.

A plaster filler should then be applied by rubbing in fine plaster of paris with a damp rag, taking care to remove all possible surface plaster with other rags. When the filler is thoroughly dry, the proper colour of the mahogany is re-instated by rubbing linseed oil all over the stained surfaces. At this stage the

inequalities of surface in the grain caused by the wet stain should be removed by rubbing all surfaces with No. 0 sandpaper.

A wad of cotton wool should then be saturated with shellac or button polish and covered with a piece of clean linen. This forms the "rubber". The rubber is drawn fairly rapidly over all surfaces in the direction of the grain, taking care to secure an equal distribution of polish. This process should result in an even surface having a little shine which effectively seals the surface of the wood. This type of finish is sometimes completed by the addition of "waxing".

Oak.—French polishing of oak is not recommended as alternative finishes are much more appropriate to this timber. Good colour in English, Continental and Japanese oak may be obtained by "fuming". Dry fuming gives the best results, as the grain is not raised by the application of wet ammonia.

Small articles such as clock cases should be placed in a box that can be made reasonably airtight with a lid. A clock case, for example, is placed in the box and liquid ammonia is then poured into a saucer in the box just before it is closed. The ammonia fumes act upon certain acids in the above-mentioned oaks with the result that a darker tone is given to the wood. The degree of darkening is regulated by the time allowed for "fuming".

Larger articles may be fumed in sealed cupboards or chambers. It should be noted that the American and Canadian oaks do not contain the acids necessary for fuming, and the darkening of these oaks must be effected by means of water stain.

Metal Leaf Finishes.—Metal leaf finishes are very pleasant for some small articles when used on plain or moulded surfaces, or in conjunction with carving or gesso work.

The materials required consist of a filler or undercoating to cover the woodwork and give a perfectly smooth surface. Gold size is then applied to form an adhesive to thin leaves of gold or silver purchased in the form of a book.

The process of laying metal leaves of gold or silver is a delicate one and interested readers are recommended to a handbook on gilding. The process is particularly effective when used in conjunction with carving or gesso work, and "burnishing" parts with "agate" tools gives an increased richness. Handbooks on gilding usually cover all the materials, tools and processes appropriate to "gilding" and also "gesso" work.

Although the metallic effects obtained by use of "metal powders" are less refined than the leaf gilding processes, they have the advantage of very simple "technique" and are dealt with in the following notes.

Metal Powder Finishes.—Metal powders in packets may be purchased from artists' colourmen in a wide variety of shades in the gold and bronze groups. The third group is that of silver or aluminum.

When using these finishes the groundwork should be prepared in exactly the same way as for painting, and as these powder metal finishes have excellent covering qualities, they may be applied by simply mixing the powder with best quality "size" and applying with a good quality light varnish brush. Two coats will

usually give a sufficiently deep finish. It is important to note that a coat of colourless lacquer varnish is necessary to obviate the later discoloration of a metal powder finish.

Gold, bronze, silver and aluminium powder paints may be obtained mixed ready for use.

Metal powder finishes for mirrors, frames and other small articles open up an interesting range when used in association with coloured mouldings, carving or gesso work. The procedure in such cases is first to apply the metal powder and gold size, and then to paint in the decoration with artist's colour and gold size before finally finishing with a clear varnish.

Special Wood Finishes.—There are many ways of finishing woodwork with a view to obtaining an improved decorative value by securing a definite "texture" to the wood such as that obtained by "sandblasting". Other special finishes such as "weathered oak," and "liming" secure a definite "texture" finish by other methods. The following notes cover some of the special finishes.

Sand Blasting.—This process requires the special plant appropriate to the process by which sand is expelled from a nozzle under high pressure. The process is particularly effective when used on British Columbian pine, or well-figured oak. It has the effect of cutting away the soft wood and giving greater prominence to the slightly projecting harder parts of the wood or "figure." A peculiar dullness or "tone" also results from the process that is very attractive. Although some architectural woodwork is left "in the white" after sand blasting, a wax finish applied with brushes is sometimes used.

Weathered Oak.—This finish is obtained in European or Japanese oak by removing part of the soft wood with a wire brush. Japanese oak is the most suitable variety to use, as the soft wood between the "silver grain" or figure is more easily removed than is the case with the harder European oaks. The finished article should first be "fumed" with ammonia, as previously described, and then the surfaces are vigorously brushed with a wire brush until the required prominence is given to the silver grain or figure. Italian Plaster of Paris is then made into a thick paste with methylated spirit and rubbed into the surfaces. All surplus paste is then removed by rubbing with rags.

The surface is then covered with a mixture of beeswax, turpentine, and a little resin. This mixture is applied hot, and when dry it is well brushed and rubbed with rags to produce a "waxed" finish.

Liming.—The European and Japanese oaks are particularly susceptible to the action of quick lime, and a weathered effect may be obtained by coating the finished work with a heavy coat of quick lime and water. This coating should be left for forty-eight hours and then washed off. This treatment is particularly successful for outside work, such as doors, gates and garden furniture. English oak is the best material when this process of finishing is adopted. The colour of "limed oak" is rather unpleasant until after some exposure which produces a pleasant "silver grey," weathered effect.

Scratching out the softer parts of the wood while wet with a scratch wire brush before liming improves the texture of a limed finish.

CELLULOSING.

During recent years the practice of using cellulose finishes as alternatives to coach painting or motor cars, and for transparent finishes on furniture in place of french polishing, has led to a highly developed technique covering coloured cellulose enamels, stains and transparent cellulose finishes on furniture.

The process necessitates a special spraying plant having as its main components an air compressor, an air receiver or reservoir, and a transformer purifier or clarifier.

The cellulose solutions are applied by means of a spray pistol, and this instrument is operated in a spraying booth or chamber with an efficient exhaust to remove vitiated air.

Two main forms of cellulose finishes are available, the first consisting of coloured enamels, and the second of stains and transparent finishes used for hard or soft woods.

Readers specially interested in this process are recommended to the descriptive booklets published by Nobel Chemical Finishes Limited, entitled "Belco" wood finishes. This booklet gives detailed particulars of water, naphtha and cellulose stains for the primary colouring of woodwork, and also details of the materials and processes in connection with woodfilling, bodying up and finishing.

The booklet "Spraying Plant and Modern Spray Practice," published by the same company, gives detailed particulars of the plant required for large scale work, and a list of spray plant manufacturers.

The section devoted to portable spray plants is of particular interest to the small user. A General letter No. 33 of the Nobel Chemical Finishes Limited covers the "Belco" brushing wood finish process which enables a cellulose finish to be applied by ordinary brush work, and obviates the necessity of the spray pistol and spraying chamber.

Cellulosing in Schools.—This process is now so firmly established in the woodworking industries that the installation of small spraying plants in technical schools and colleges would have a real advantage in the training of technical students by means of demonstrations by trained instructors.

Cellulosing Models in Schools.—In the early stages of woodwork, there are many elementary models in which a paint, polish or cellulose finish is unnecessary, as items such as soap, egg and brush racks, for example, may be occasionally scrubbed to keep them in a clean condition. There are however many articles such as trays, brush boxes, frames and mirrors that would be much more serviceable and presentable if finished with plain or coloured cellulose, and it is suggested that the installation of a small spraying plant in the woodwork room, or even in the chemical laboratory, would have obvious advantages.

The procedure recommended is for a spraying demonstration to be given periodically by an instructor or laboratory steward, using the finished models of pupils as examples. The plant required for small scale work of this type could easily be manipulated in a small chamber comparable to a fume cupboard with an air inlet and an exhaust. It is thought that this procedure would be much more satisfactory than the indifferent finishes of painting, waxing, or polishing by young pupils. The cellulose finishes have special advantages when used in conjunction with ornament applied direct to woodwork.

Finished work of this type may be sealed and protected by "rubbers" of french polish, but alternatively the application of sprayed cellulose would be more reliable and effective.

CHAPTER XIX

SUPPLEMENTARY WOODWORK FOR TEACHERS AND CRAFTSMEN

INTRODUCTORY.

THE examples illustrated and described in this chapter have been introduced with a view to showing examples that cover a fairly wide range of craft technique.

Some of the more simple items shown come within the capacity of elementary pupils, whilst the developed designs in which rich material and fine craftsmanship are essential factors may be of interest to advanced students and craftsmen. On the construction side the items illustrated indicate various main constructive features and also the introduction of "plywood" and "laminated board." The text associated with the examples explains more fully the adaptation of the items to meet the varying needs of teachers, students and craftsmen.

WRITING, MUSIC, AND SPECIMEN CABINETS (Fig. 1).

General Note.—The drawings in Fig. 1 show two treatments of small cabinets. The first example is composed of two carcasses upon a moulded stand with fixed shelves or trays for music in the top and bottom parts. The second example shows the upper part with a falling writing part upon a table stand. These examples are introduced to indicate the possibility of forming pleasant types of small cabinets for various uses with straightforward carcass and table constructive features. Variations of these designs cover a wide range of useful items such as small wardrobes, tall boy chests, and chests on stands.

Constructive Features.—The composite views illustrating construction show the normal methods of carcass and table construction and the following are constructive features to be noted.

The carcass top shows the lapped dovetail attachment to the carcass end. The smaller dovetails at the front and back should be noted, as they prevent the carcass tops and bottoms curling away from the ends. The drawer rail may either be tenoned into the carcass end as shown or alternatively attached by means of a "slip" or "diminished" dovetail shown in Fig. 10, p. 32. The drawer runner should preferably be grooved into the end with a small stub tenon fitting into the groove of the drawer rail. The dust board should be of 3-ply grooved into the drawer rail, and also into the drawer runner. In small carcass

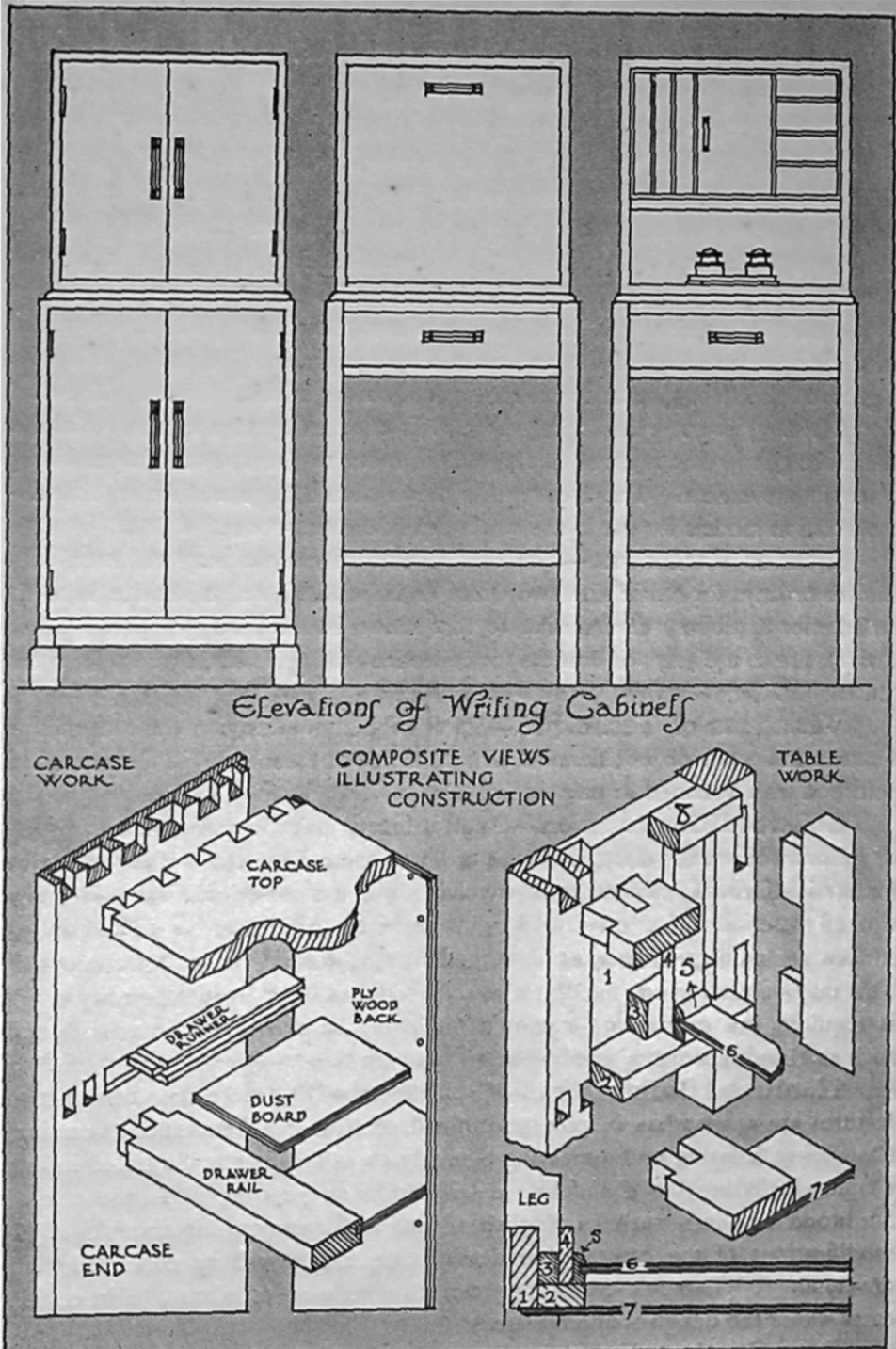

FIG. 1.—Writing, music and specimen cabinets.

work it is sufficient to screw a 3-ply back into rebated carcass ends and top instead of using a "framed" or "panelled" back which is appropriate to large carcass work such as cupboards and wardrobes.

Table Work.—The second composite view illustrates the normal construction of a table with drawer; the chief features are as follows. The end rail (No. 1) and also the back rail are tenoned into the legs, with the rail below the drawer tenoned and half tenoned into the legs. The rail above the drawer is lap dovetailed into the leg and half lap dovetailed into the rail. No. 2 shows the drawer runner that is glued to the end rail. This serves to keep the drawer in a perfectly horizontal position. No. 3 shows the drawer guide that is glued to the drawer runner and the end rail. No. 4 represents the drawer side with a grooved slip (No. 5) attached to receive the drawer bottom (No. 6). The dust board (No. 7) is cut over the legs to permit of screwing to the rails. No. 8 is the kicking strip that is glued to the end in order to prevent the drawer tilting when in movement. These composite views should be useful for making demonstration models for use in the workshop or drawing-room.

Interior Variations.—The double carcass cabinet may be fitted with shelves or trays for music with two doors as indicated. An alternative is to fit an interior stationery case similar to that shown in the third elevation. Other variants are to use trays or drawers for collections of specimens, or trays for sheet music.

Variations of Technique.—Small cabinets embodying the constructive features indicated do not demand a high degree of technical skill if executed in softwood with a stained or painted finish.

Softwood Construction.—Small cabinets made in softwood with "ply" or "laminated wood" doors and with ordinary painted surfaces are very effective for straightforward cabinet work involving the use of economical and easily worked material. If a "quality" finish is desired, a painted, varnished and dulled surface resembling lacquer, as described in Chapter XVIII, may be adopted. This may be used in conjunction with softwood, but if a "lacquer" quality finish is required, the cabinet work should preferably be carried out in a hardwood such as Honduras mahogany.

Hardwood Construction.—Cabinets embodying these main constructive features are appropriate in proportion for decorative treatments such as carving, chamfering, inlaying and veneering similarly to other designs illustrated in this chapter, including the chamfering detail shown on page 294. In the case of hardwood exteriors, such as English walnut and sycamore for example, slight modifications of the constructive detail is necessary, such as concealed "lap dovetailing". Through dovetailing can also be used to advantage in certain cases where the design is appropriate.

Door Construction.—The diagrams shown in Fig. 2 on page 293 illustrate four methods of making "flush doors". No. 1 consists of "laminated wood" with tongued clamps. No. 2 covers the use of solid wood clamped at the ends,

No. 4 indicates solid wood with dowelled clamps and No. 3 refers to mitred clamps mortized and tenoned.

Pivot Hingeing.—An alternative method of hingeing that is more appropriate to small cabinet work than the ordinary brass butt hinges is also illustrated. No. 5 represents simple views of the “necked pivot hinge.” Each “pivot hinge” consists of two necked plates, with a riveted pivot and an intervening washer. The position of the carcass part is shown in No. 6 and that of the door part in No. 7. It should be noted that both hinges are first screwed to the carcass, and that the door is then slid over the door parts before finally screwing to the door. The door is removed when required by reversing the procedure. No. 8 shows the recessing in the top edge to take the door part of the hinge.

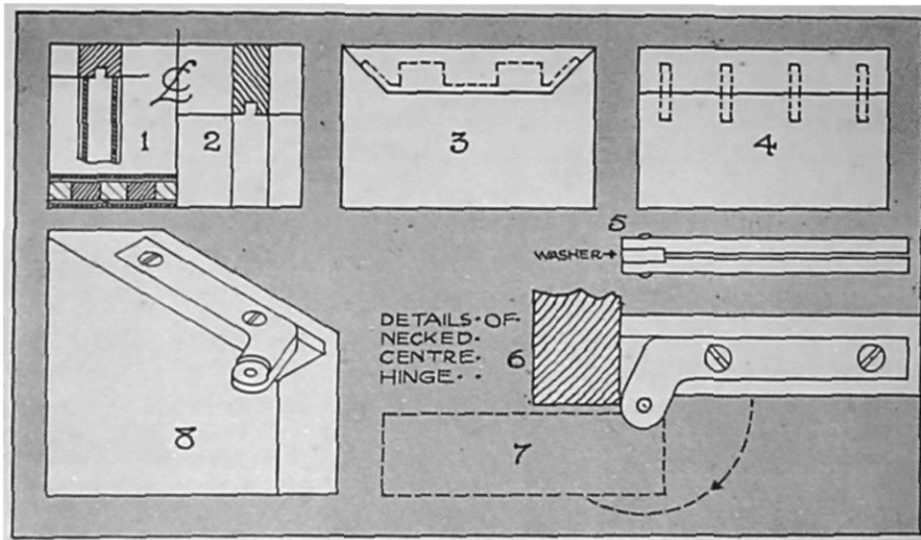

FIG. 2.—Diagrams illustrating flush-door construction and centre hingeing.

A CHEST CABINET (Fig. 3).

General Note.—The drawings in Fig. 3 on page 294 illustrate two types of chest cabinets with constructional and decorative details. These cabinets lend themselves to a wide range of technique, beginning with a simple carcass mounted upon a stand or plinth, and increasing in difficulty by the use of decorative hardwoods and the introduction of decorated edges and veneered or carved surfaces. The various constructive and decorative details are dealt with briefly in the following notes.

Constructive Features.—Larger cabinets of this type require panelled backs in preference to 3-ply backs in one piece, and a view is shown of a four panelled back. This is mortised and tenoned together with four 3-ply panels grooved into the framing. The drawing also shows the normal method of securing a panelled back to the carcass by screwing into rebated ends and top. At the bottom the panelled back is screwed over the carcass.

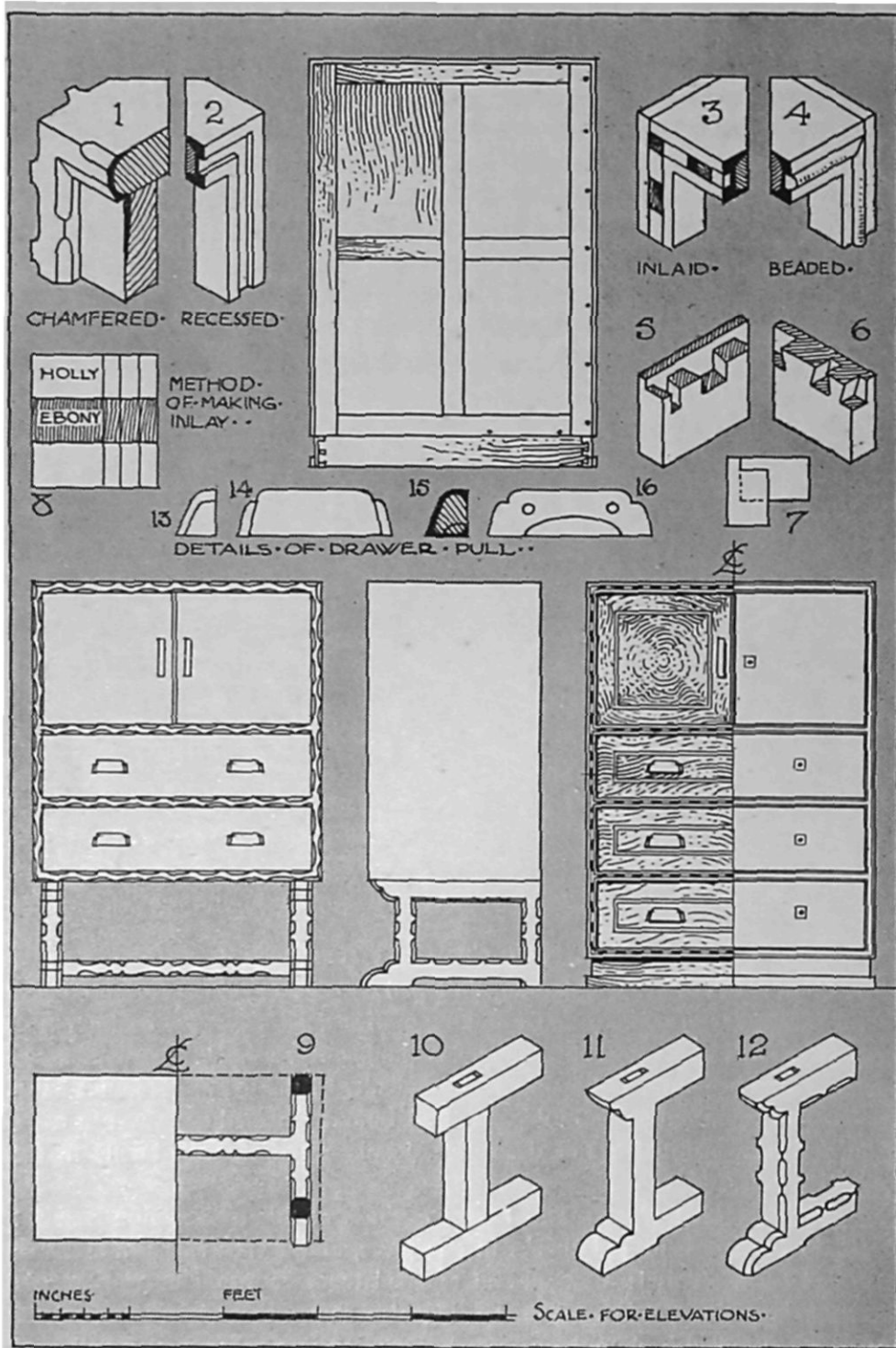

FIG. 3.—Designs and details of chest cabinets.

The carcass top dovetailing (Nos. 5, 6 and 7) is an adaptation of the ordinary carcass detail. This is necessary when it is required to conceal the top dovetails. Nos. 5 and 6 indicate the sockets, dovetail and the lap. No. 7 shows the rebated carcass end, and the dotted lines indicate the exact position of the sockets in the carcass end, and the dovetails of the top. If the spacing is one-third for the lap and two-thirds for the dovetailing the shoulder line coincides with the edge treatments in Nos. 1, 2, 3 and 4, as these are all based upon an equal division of edges into three parts. Nos. 9, 10, 11 and 12 illustrate the method of making the stand. No. 9 is a half plan showing a connecting rail. This may be stub tenoned at each end, through-mortised and tenoned, or lap dovetailed between the end frame; the lap dovetail only showing on the underside.

No. 10 illustrates the first stage in making the stand with through-mortise and tenon joints. After fitting the latter joints, the shaped ends are cut, filed and sandpapered and then the frames are put together dry, prior to planing and sandpapering. The stands are then taken apart and chamfered before finally gluing up. This procedure secures much greater accuracy than is possible when the chamfering is done before the frames are glued up without preliminary levelling.

Decorated Edges.—Four methods of decorating edges are indicated that are based upon an equal division of the edges into three parts. No. 1 shows a chamfered edge. This is very effective in limed oak or waxed walnut. It is also an effective detail when the chamfers are painted a contrasting colour in painted work such as vermilion or apple green in association with black or parchment colour painted carcasses and stand. No. 2 shows a simple treatment of recessing appropriate to waxed or polished hardwood, or alternatively recessed and coloured with painted work. No. 3 is an inlaid edge of holly and ebony for example in English walnut. No. 8 and also Fig. 7 on page 180 shows the method of building up the inlay. Gluing on to thin veneer is necessary to enable the inlay to be handled in lengths of 10 or 12 inches. The veneer can be placed in the grooves, or alternatively the groove is made of less depth than the combined thickness of inlay and wood so that the veneer projects beyond the edge when glued, and is removed by planing down after the glue is thoroughly hard.

No. 4 shows a bead mitred and glued round. This is an attractive detail in most hardwoods. An alternative detail is to make this bead of cross grained when working in strongly figured wood such as English or Ancona walnut.

Wooden Drawer Pulls.—One type of wooden drawer pull is illustrated. These are usually made in a length worked to a simple section such as No. 15. No. 16 shows a gouged finger place at the back, and the position of two dowels for fixing. Gluing and screwing from the inside is an alternative. Nos. 13 and 14 show moulded ends. When several are required to be made the work is facilitated by cutting the angles in a modification of a mitre-cutting block.

Door Construction.—The methods already described on page 293 are appropriate according to practical requirements. The elevation with three drawers shows on the left-hand side a door made from finely figured English oak or

walnut formed by tongueing or dowelling four triangular shaped pieces together. The doors and the drawer fronts are then rebated in order to form raised panel centres with a small moulding worked on the solid. The right-hand side of this elevation shows a refined and simple treatment of mahogany with ivory or erinoid knobs. The centre hinges described on page 293 are particularly appropriate for cabinets of this type.

Fig. 4 shows enlarged details of the wooden handles. These are preferably made in a very hard close grained wood such as coromandel, brown ebony, or rosewood.

A length of simple moulding is first made to the section shown in No. 1, and the angles are cut off in a saw block. No. 2 shows the next stage of cutting away the ends. No. 3 is a plan of the handle at this stage. The handles are next shaped as shown in half elevation (No. 4) and the half plan (No. 5). No. 6 is a back view of the handle, showing the position of finger space and position of the dowels. As firmness is the first essential of any handle, the fixing should be made perfectly secure by also screwing from inside the drawer:

CLOCK CASES (Fig. 5).

General Note.—Fig. 5, on page 297, illustrates various clock cases embodying a wide range of technical practice based upon a simple box construction.

Most rectangular forms of clocks are made by a simple through or lap dovetailed box with a front glued over the box, and a frame glued over the back to contain a door. The drawings (Nos. 1-9) embody the basic box form and illustrate additional features in which a variety of designs may be based.

A Clock Case in Walnut and Sycamore.—No. 2 is a front elevation of a veneered clock case of modern type. The projecting dial part is intended to be in holly or sycamore with inlay of very dark walnut or coromandel. The main case is intended to be veneered with finely figured walnut. The base is carried out in veneer to match the dial part, and the square member of the base should be of brown ebony or coromandel. The hands should preferably be of ivory

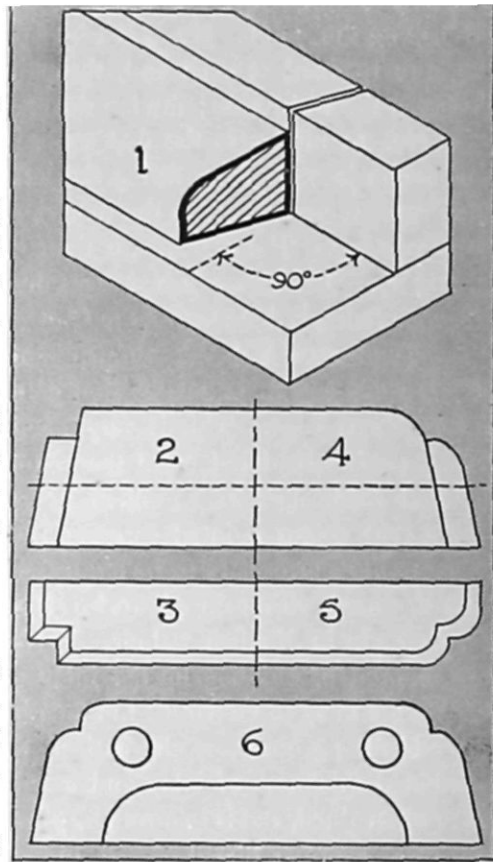

FIG. 4.—Working details of wooden handles.

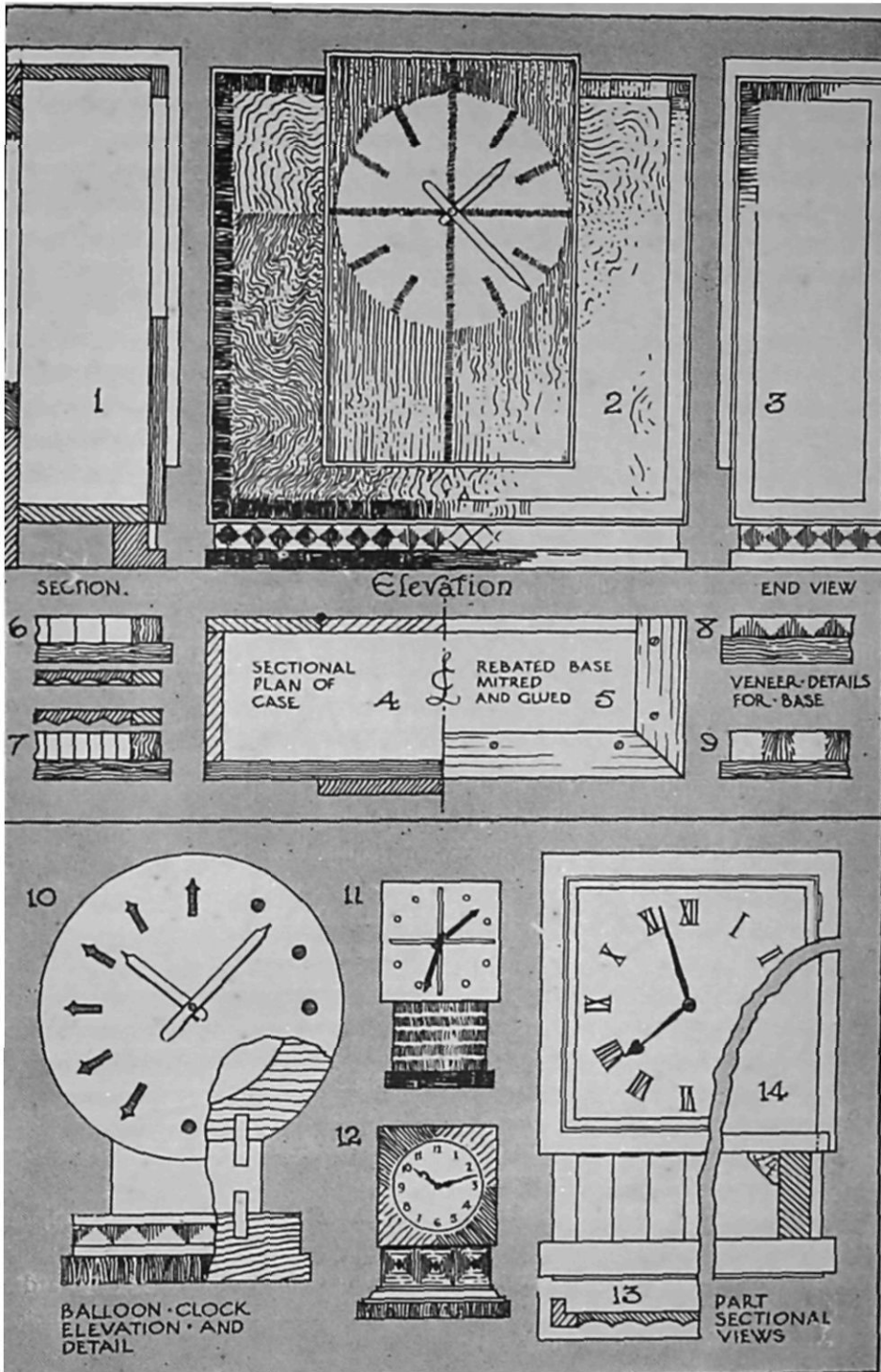

FIG. 5.—Designs and details of clock cases.

Constructive Features.—The carcase consists of a dovetailed box with a 5-ply front and a framed back, glued over the box as indicated in No. 4. The sectional view (No. 1) shows a mitred base, glued and screwed to the box as indicated in No. 5. Nos. 6 and 7 are alternative treatments consisting of flat fluted and flat bevelled members fitted separately into the rebated base. Nos. 8 and 9 are alternative veneered details

The dial part is made by dovetailing two pieces of wood together before veneering and inlaying as shown. This part is fixed by gluing to the box part after completion of all the veneering and inlaying.

A Balloon Clock.—No. 10 illustrates a simple form of balloon clock. The body to contain the movement is made by band-sawing a circular body from a solid block of wood. A 3- or 5-ply front is glued to the body. An enclosed movement could be used for this type wound from the back, thus obviating a door. The diagram also shows the method of completing the clock by dowelling base and connecting blocks. This form of clock case is easily made in softwood and lends itself admirably to simple forms of painted decoration, including the hour symbols. No. 14 illustrates another simple form, consisting of the normal box case mounted upon a fluted base. The base really consists of a second box attached to a rectangular block of wood as a base. The flat fluting is worked with round planes and papering rubbers in a length about 4 in. wide sufficient to cut into short lengths that are glued into the recesses between the body and the base block. Square corners are rebated and fixed as indicated in the sectional view. Nos. 11 and 12 are alternative designs based upon similar constructional features which equally lend themselves to softwood and painting, or the more difficult technique of hardwood, veneered and inlaid.

Clock Movements.—The movement required for No. 2 is a timepiece controlled and wound from the back. The attachment of this to the inside is quite simple by screwing to the case. The pin to take the hands is supplied to the length required and the hands are fixed from the front.

The same type of movement is required for Nos. 10 and 11. No. 12 shows a simple timepiece movement with a glass mounted in a "hinged bezel" and wound from the front. No. 14 shows a square fronted timepiece movement with a "hinged bezel". These timepiece movements usually have comparatively simple fixings, but the first essential of clock case design is to determine which type of movement is required, and to purchase the mechanical part so that the design of the case can be properly related to it.

The order of superiority and cost in clock case movements is roughly as follows:—

1. English eight-day pendulum clock, striking hours on gong, £3 upwards. This movement is usually fixed to a seat board inside the clock or by metal brackets screwed to the clock case sides.

2. French pendulum movement, eight-day with pendulum and striking action on a steel coil, £2 upwards. This movement requires a circular hole in the

back to receive a metal rim. Long threaded screws pass through the rim to metal straps on the movement. The rim also contains a metal inspection door.

3. English or Swiss timepiece, 10s. upwards. This is a self-contained unit without striking action or pendulum and has a simple fixing inside the case.

BRUSH AND COMB TRAYS (Fig. 6).

General Note.—The drawings in Fig. 6, p. 300, cover a number of toilet tray variations based upon the simple outlines of Nos. 1 and 2. The first example shows a tray to accommodate two clothes brushes, two hair brushes and a comb. This and the second example embodies elementary practice if made in softwood nailed together with a 3-ply bottom. These simple types can be stained, cellulosed or painted. Added interest is given by the addition of small feet at each corner (Nos. 3 and 4) or by the addition of moulding mitred and screwed round to the detail shown in Nos. 5, 6 and 7.

Use of Choice Hardwoods.—The perspective sketch illustrates a similarly spaced tray with “roll” sides to be executed in holly, sycamore or satinwood, or the dark toned woods such as ebony, coromandel, Indian laurel or ironwood. The outer frame of the tray should be made with mitred dovetailed corners if a light wood is chosen, but finely made and nicely spaced through dovetails are appropriate for the dark woods, including walnut. In both cases the divisions should be made with “slip” or diminished dovetails previously described.

Working Detail.—The “roll” detail (No. 10) is very effective, used in conjunction with the simple shaping shown in the perspective view. The method of making the roll edges is indicated in No. 17. The wood is first planed to the rectangular section. Rebate lines are then gauged and the hatched portion is removed with a rebate plane and finished with a metal shoulder plane. The actual roll is made by removing the sharp corners by chamfering and then working the round with a hollow plane. A very small metal plane about $\frac{1}{2}$ in. wide is invaluable for this kind of work in very hard wood as an alternative to the hollow plane.

No. 18 shows an alternative treatment. The wide hatched portion is first removed by rebating. The hollow is then worked with a small round plane, and the other shaping is finished with a small metal plane.

Tablet Handles.—No. 15 shows a sectional view of a tablet handle and No. 16 the plan. This handle is formed by gluing a short piece of wood to the side moulded as indicated in Nos. 14 and 15. A second piece is also glued to the top edge as indicated in No. 15. An alternative type is illustrated in Nos. 12 and 13.

Finish and Glass Bottom.—The light coloured hardwood demand either a dull french polished or spray cellulose finish, and the dark hardwoods may be similarly finished or waxed.

An alternative treatment is to introduce a bottom of $\frac{3}{16}$ -in. plate-glass with polished edges. This can be held secure and removed when required for cleaning

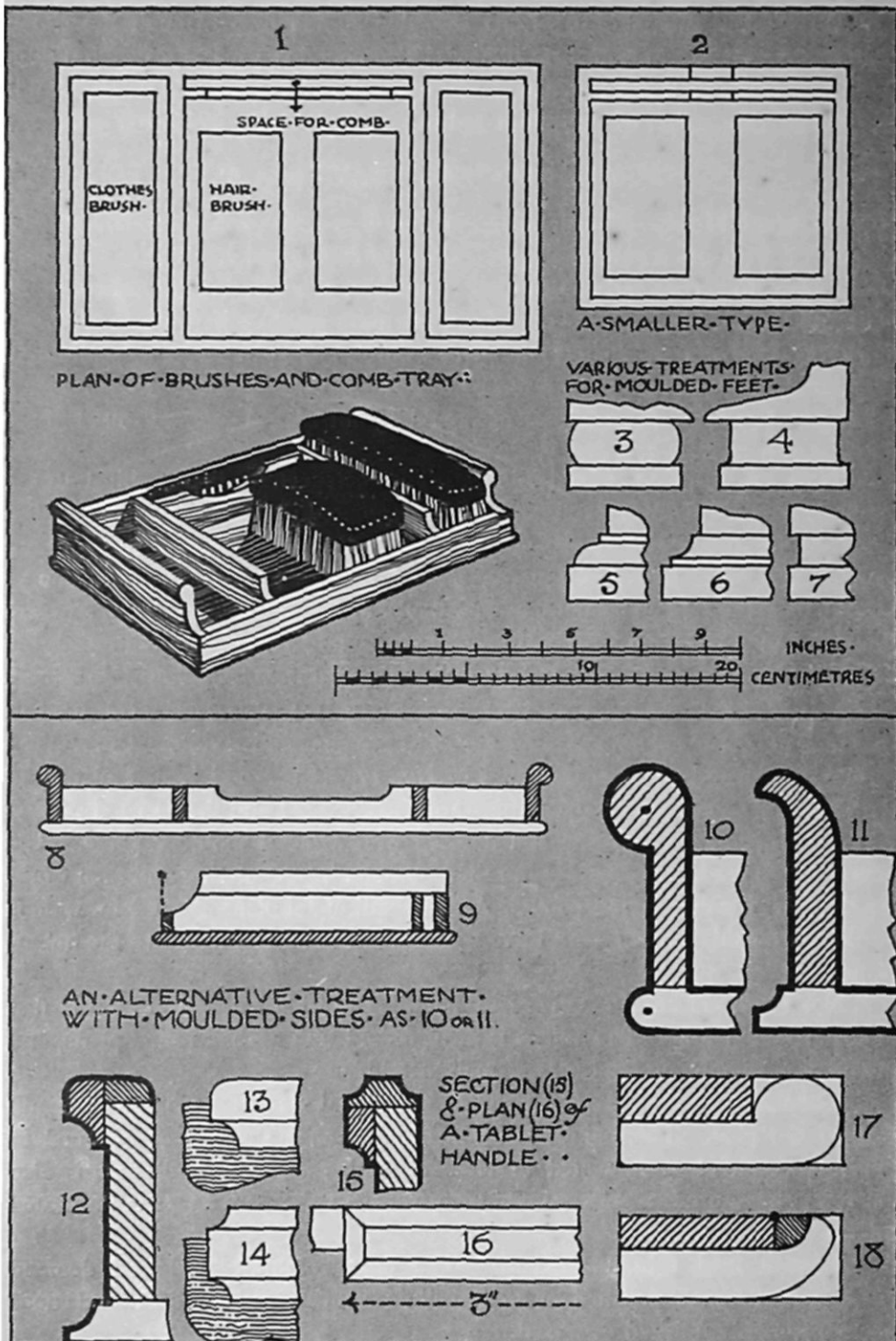

FIG. 6.—Designs and working details of toilet trays.

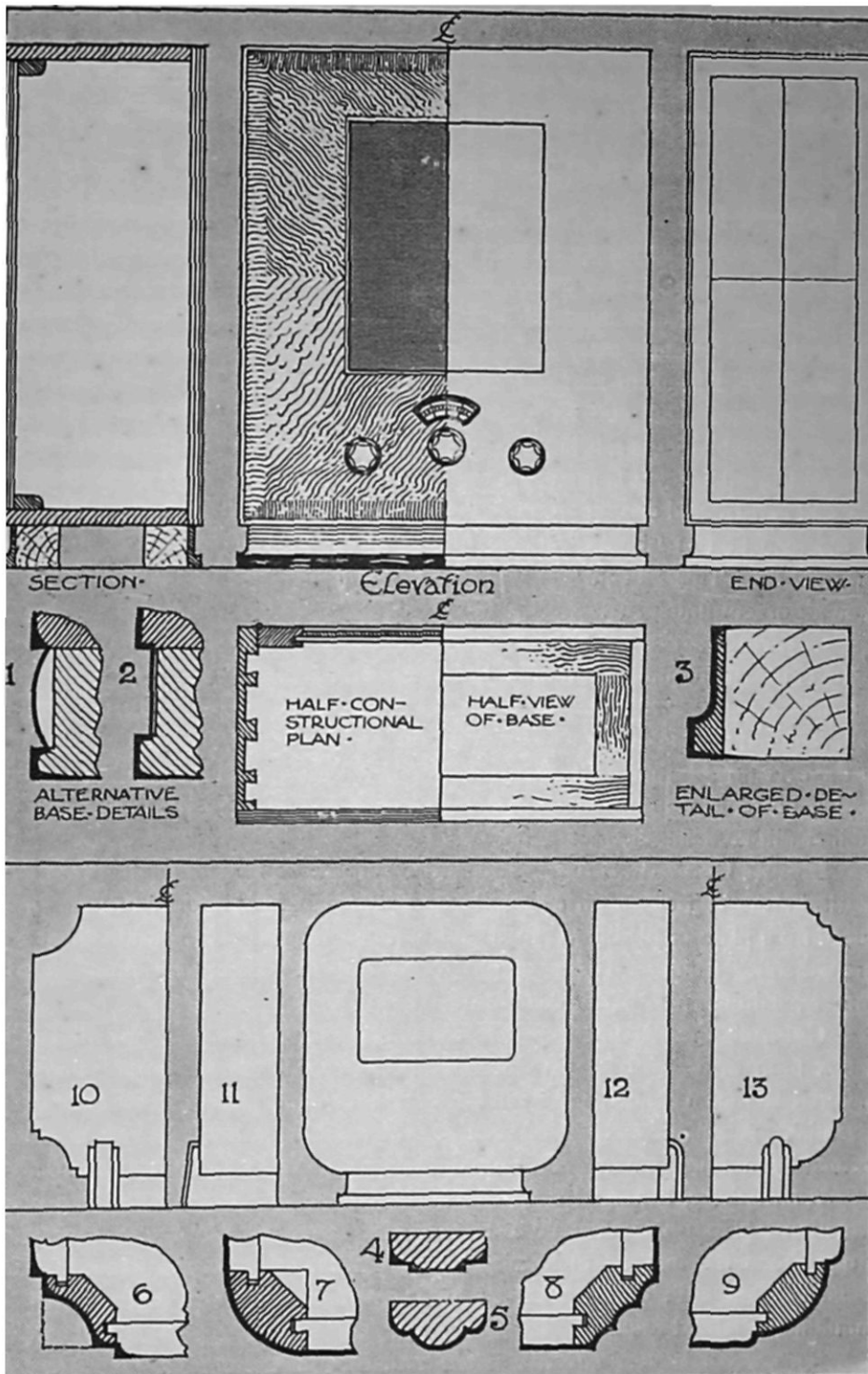

FIG. 7.—Design and details for portable wireless cabinets.

by the introduction of four feet at the corners, quadrant shaped in plan. The divisions and the back reach a full $\frac{3}{8}$ in. from the bottom lines of the sides and front so that the glass bottom can be inserted or removed. Two small buttons on the back obviate the plate glass from falling out by careless handling.

WIRELESS CABINETS (Fig. 7).

General Note.—Small or portable wireless cabinets are illustrated based upon cabinet construction as distinct from the cheap grade commercial types in which the main features are corner framing made of fillets with the exterior of thin plywood. This commercial type of construction lends itself to simply produced cases for elementary and amateur production. The constructive detail can be obtained from an examination of commercial examples. The examples illustrated are intended more for teachers and craftsmen who are desirous of having not only a good wireless set, but an enclosing case embodying good craftsmanship. In regard to efficiency it is interesting to note that the rather heavier material used in a well constructed case of "cabinet" technique results in a finer sounding set by the reduction of "boom" arising from a lightly constructed "drum" form of construction. This "boom" is reduced in commercial sets by the introduction of an absorbent lining such as "Cellutex".

Determination of Size.—It is important also to note that portable cabinets usually require a minimum inside depth of $8\frac{1}{2}$ in. The other sizes are determined by the "lay out" of the set, and if any doubt exists as to the inside sizes required the making of a simple nailed "mock up" is strongly recommended as there is no advantage in having unnecessary inside space. Any necessary seating board can be introduced in the "mock up," and the final sizes of the cabinet will be definitely ascertainable.

Simple Constructions.—The simple construction of commercial cabinets is within the capacity of many pupils, and simple pleasing forms can be produced from plain or ply-board glued and screwed together with inside fillets as strengthening factors. These simple forms can be finished by rounding all corners, staining, painting or cellulosing.

Cabinet Construction.—The three upper views on page 301 illustrate a box form made with lapped dovetails as in normal carcass work. Five-ply material is recommended for both the front and back, although not absolutely essential. A simple method of securing the back is to screw it into a rebate formed by mitring, gluing and screwed fillets round the inside of the cabinet.

Alternatively, a hinged door can be introduced as shown in the half constructional plan. This diagram also shows the spacing of the carcass dovetails. No. 3 shows the method of forming a simple moulded base. A frame of softwood is made with ordinary halved joints glued and screwed together, and a moulding is mitred round.

This detail is very effective if the moulding is executed in cross banded walnut or other strongly grained material. The joints in this detail are not

mitred, and the cross grained strips are jointed round the frame, as indicated in the half view of the base.

No. 1 indicates an alternative treatment of the base with a mortized and tenoned frame rebated to receive a cross banded moulding member. No 2 is a further alternative with a cross banded veneer member.

Alternative Designs.—Nos 4-13 illustrate outlines and bases which lend themselves to a wide variety of technical practice. These are made on the same basis as the previous type: the front being glued over a four-sided box form, and with a fitted plywood back.

No. 6 illustrates the method of forming the two shaped corners indicated in No. 10. The grooves and chamfers are preferably worked in a length, but the hollows are best worked after the box is glued up, as the square edges shown by dotted lines facilitate cramping up the work. Nos. 7, 8 and 9 are alternatives based upon similar practice.

Nos. 4 and 5 are sectional details of moulded feet consisting of simple L shapes, as shown in Nos. 11 and 12, tenoned and screwed up to the bottom. The elevation shows a moulded base of the same type as that used in the top elevation.

GLOSSARY OF WOODWORKING TERMS.

A.

- ABACUS.**—The top member of the capital of a column.
“ADAM” period of decoration. Applied generally to the architectural and decorative work of Robert and James Adam. 129.
- ALBRECHT DURER TYPE.**—Lettering based upon constructions laid down by A Durer. 166.
- ALBURNUM.**—The botanical term for sapwood.
- AMERICAN WHITEWOOD.**—A term loosely applied to various timbers resembling (*Tulpifera lirioidendron*).
- ARCHIMEDEAN DRILL.**—A light metal boring drill operating with bobbin on a spiral shaft. 243.
- ARCHITRAVE.**—The moulding surrounding a door or window opening. 130.
- ARRIS**—The line or edge between two plane surfaces.
- AUGER.**—A specially long wood boring tool similar to a gimlet or “twist bit.”
- AUTUMN GROWTH.**—Part of the annual ring in timber formed by the descending sap. 143.
- AXIS**—An imaginary line on which a body revolves.

B.

- BALTIC TIMBER.**—A term applied generally to softwood timber exported from ports on the Baltic Sea, including Russian, Polish, Swedish and Norwegian timber.
- BASE.**—The main bottom portion of an architectural order comprising Frieze or Entablature, Column and Pedestal or Base. 130.
- BEVEL.**—An adjustable tool used for marking and testing bevelled shoulders and edges. 242, 243.
- BOLECTION.**—A rebated moulding, usually used in connection with panels in doors and framing.
- BOSS.**—A carved or decorated ornament placed at the intersection of mouldings and ribs in ceilings and roofs.
- BOULE OR BUHL WORK.**—A general term applied to designs in brass, tortoise shell, and other material in the style of Andre Charles Boule.
- BOXWOOD.**—A very hard, dense timber, pale yellow in colour. The best variety is Turkey Box.
- BRONZE MOUNTS.**—The term applied to “Gilt Bronze” mounts of the Louis XIV., XV., XVI., and other periods of French design, also referred to as “Ormolu.”
- BURR WALNUT.**—Is a foreign growth or excrescence on the walnut tree which is cut into veneers and used for decorative purposes

C.

CAPPING.—A moulding on the top of a pedestal or post.

CARCASE.—The term applied to the box or cupboard unit in cupboards, wardrobes, etc.

CARTRIDGE PAPER.—Strong drawing paper.

CASTING.—In woodwork, the term refers to the “twisting” or “casting” of timber.

CAUL.—A piece of wood or metal used for veneering with a heated “caul” and handscrews.

CAVETTO.—A classical “hollow” moulding. 130.

CELLULOSE PAINT.—Quick-drying paint, usually applied by “spraying.”

CHAIR RAIL.—A moulded rail fixed to walls to obviate damages by chairs.

CHAMFER.—A small plane surface or bevel between two adjacent surfaces of timber.

CHANNELLING.—Grooving across boards, and also applied in decoration as very flat flutes without “fillets” on large columns.

CINQUEFOIL.—A “five” pointed device in Gothic detail.

CLAMP.—A piece of wood tenoned, tongued or doweled to a wide piece to prevent warp. Variation, “mitred clamp.”

CLUSTER GALLS.—A foreign growth on the oak tree. 144.

COMPOSITE.—One of the classical orders of architecture.

CONCENTRIC.—Circular forms having the same centre.

CONIFEROUS TIMBER.—The product of “cone-bearing” trees such as the pines and cedars. 140.

CONSOLE.—A decorated bracket used in architecture and furniture.

CONVENTIONAL ORNAMENT.—Formal ornament based upon natural forms such as the Greek Honeysuckle.

CONVERSION.—The process of cutting logs and balks into boards, planks, etc.

CORE.—As a woodworking term is applied to a wood shape faced up with other wood or veneer.

CORNICE.—The top member of a cupboard or wardrobe consisting of cornice moulding, frieze and frieze moulding.

CRAMP.—An iron or metal tool used for “cramping” framing and doors. 245, 246.

CROSS-BANDING.—Decorative veneering in the form of narrow bands cut across the grain, also cross-banded rail edges in Queen Anne furniture.

CUPSHAKE.—A defect in timber following the lines of the annual rings.

CYMA RECTA.—The classical “ogee” moulding. 130.

CYMA REVERSA.—The reverse of “Cyma Recta.” 130.

D.

DECIDUOUS.—Leaf Shedding, characteristic of broad-leaved timber trees.

DEEPING.—Deep cuts in timber when converting logs, balks, and planks.

DENTIL.—Rectangular ornaments on cornice mouldings.

DESSICATION.—The artificial drying of timber in heated “kilns.”

DIAGONAL.—A line from corner to corner.

DIAPER.—“Repeating” ornament or pattern or geometrical bases, e.g. Louis XVI. inlay or marquetry. 49.

- DOATINESS.**—A speckled appearance in timber indicating decay.
- DOG'S TOOTH ORNAMENT.**—A carved moulding of the Early English period.
- DONKEY.**—Appliance used by "marquetry cutters" with wooden vice and fret frame saw.
- DOWELS.**—Cylindrical pieces of wood of $\frac{1}{4}$ -in and upwards diameter, usually made of beech.
- DRY ROT.**—A disease of timber usually arising from damp.

E.

- EBONY.**—Very hard and heavy timber chiefly of Indian origin.
- ECCENTRIC.**—Circular forms having different centres.
- ECHINUS.**—Egg-shaped carved ornament on classical cornice mouldings.
- ELLIPSE.**—The inclined transverse section of a cone or a cylinder.
- ENRICHMENT** —Carved detail on mouldings
- ENTASIS.**—The curvature of a "column" from base to capital. Also applied to curvature or shaping of a "pilaster."
- ERINOID.**—A composition made with a basis of milk to imitate ivory, amber, tortoise-shell, etc., for cabinet handles, etc.
- ESCUTCHEON** —Keyhole plates on doors and furniture.
- EXOGENOUS.**—An outward growth characteristic of all timber trees. 138.

F.

- FACET.**—A "fillet" or narrow band between the "flutes" of a column.
- FANLIGHT.**—Glazed overdoors of fan shape, characteristic of eighteenth century doorways. 131.
- FIGURE.**—A decorative feature of timber called "Fiddleback," "Curl," etc.
- FILLETS.**—Narrow pieces of wood supporting shelves.
- FIRMER CHISEL.**—A strong, square-edged paring chisel. 244, 245.
- FIXATIVE.**—Medium made with benzine and shellac used for "fixing" pencil or charcoal drawings by spraying.
- FLUTE.**—Semi-circular grooves in columns and pilasters. 131.
- FOXINESS.**—Incipient decay in timber shown by reddish colour.
- FRAMED WORK.**—The term usually applied to construction of table frames and also framed doors and panelling.
- FRIEZE MOULDING.**—The lowest division or moulding of an entablature or cornice consisting of cornice moulding, frieze and frieze moulding. 131.

G.

- GESSO** —Composition of "stucco" type used to give low relief to designs for lacquer and other decorated work.
- GOTHIC.**—Architecture of the Middle Ages.
- GROUNDING OUT TOOL.**—A necked form of carver's tool used for "grounding out" the design.
- GROUNDWORK.**—The base to which veneer is applied.

H.

- HAFT.**—The handle of “cutting” tool such as gouge or chisel. 205.
- HAMMER VENEERING.**—Term applied to process of veneer by “laying” with a veneering hammer.
- HEARTWOOD.**—The mature timber as distinct from “sapwood.”
- HERRING BONING.**—Strip veneering with strongly defined grain placed “Vee” fashion in the form of a herring bone.
- HOUSED PINS.**—A variation of housing sometimes used in conjunction with stub tenons.
- HOUSING.**—The recessing or grooving to receive drawer runners in carcass construction.
- HUMIDITY.**—Damp atmosphere used in connection with the “Kiln” drying or “Dessication” of timber.
- HUSK.**—A decorative detail resembling a leaf form used in “Adam” ornament.

I.

- INCISED ORNAMENT.**—Executed by Vee tooling. 183.
- INLAYING.**—A decorative process consisting of “laying” or cutting into wood lines, stringing or decorative units. 176, 178.
- INTRADOS.**—The under surface or “soffit” of an arch. Exterior is “Extrados.”
- ISOMETRIC PROJECTION.**—A conventional method of drawing on isometric axes. 160, 161.
- IVORY.**—The product of Elephant and Walrus tusks used for inlaying and over-laying.

J.

- JAMB.**—The vertical side of window, door, or fireplace opening.
- JOINTING.**—The process of making joints with planes.
- JOISTS.**—Timbers carrying floor and ceiling.

K.

- KERF.**—A piece of wood shaped as double dovetail to strengthen defective joints.
- KERFS.**—Saw cuts across timber, and also saw cuts in mitres to receive hardwood veneer “keys”
- KEY.**—A piece of wood shaped as double dovetail to strengthen defective joint.
- KNUCKLE.**—The back part of a hinge or back flap containing the pin.

L.

- LACQUER.**—A transparent varnish used for gilded work, and a process of English and also Chinese decoration.
- LAMINATED.**—Constructed in layers such as “ply wood,” or shaped segments in curved work.
- LAPPED DOVETAIL.**—Used in drawer sides and carcasses
- LIME WOOD.**—Product of the lime tree, very close grained and admirably suitable for carving in the style of Grinling Gibbons.
- LINEN FOLD PANEL.**—Characteristic of Gothic panelling; moulded and carved panels resembling folded linen or parchment.

M.

- MARQUETRY.**—A decorative process of ornament or pictures in veneer executed upon a marquetry cutter's donkey.
- MASON'S MITRE.**—Characteristic of Mediæval and Tudor woodwork The angle of moulded framing chiselled to show a "mitre"
- MEDULLA.**—A botanical timber term to indicate the pith column.
- MEDULLARY RAY.**—Radiating lines seen in cross section of oak and beech forming the "silver grain." 140.
- MITRE** —The intersection between two pieces of moulding or timber as in the corner of a picture frame.
- MODILLION** —Small decorated brackets underneath the soffit of a large cornice
- MODULE** —Divisions or measurements used in "setting out" an order of architecture to secure correct proportion
- MOSAIC** —Woodwork in the form of small patterns of wood or veneer.
- MOULD.**—A piece of shaped wood used as a pattern or templet.
- MULLION.**—Vertical division in a window frame.
- MUNTING.**—The inside vertical division of a panelled frame.

N.

- NECKING.**—A small moulding near the top of a pilaster or column.
- NEEDLE LEAF TREES** —Timber producing trees or conifers of the soft wood variety.
141.
- NOSING.**—A semi-circular moulding used in furniture.

O.

- OBLIQUE PROJECTION.**—A conventional method of representing the actual length breadth and thickness of simple objects. 160.
- ORTHOGRAPHIC PROJECTION.**—Representation of objects drawn in front and end elevation, etc 160.
- OVOLO** —A classic moulding, either of quarter circle or ellipse.

P.

- PARQUETRY.**—Hardwood flooring laid in geometrical designs
- PATERA.**—A carved unit usually of circular or elliptical shape used chiefly in "Adam" decoration
- PEDESTAL.**—One main division of an architectural order In furniture the term is applied to side cupboards of pedestal sideboards, and the nests of drawers in pedestal tables.
- PEDIMENT.**—A triangular shaped addition to a cornice, used frequently in the Kent and Chippendale periods.
- PILASTER** —Based upon a column design with shaft, cap and base cut rectangular instead of circular in section.
- PITH RAY.**—An alternative term for the medullary ray shown clearly in oak and beech
140.

PLINTH.—Term applied in architecture to the lowest division of the pedestal supporting a column. In furniture the lowest division of a cupboard or wardrobe immediately under the doors. 130.

PLUG.—A wooden filling or peg driven into brickwork, etc., to receive a fixing screw.

Q.

QUARTERED OAK.—A method of cutting a log into four quarters and then radially, to secure maximum "figure" in oak.

QUARTRE-FOIL.—A "tracery" detail based upon four intersecting circles.

QUIRK.—A narrow or Vee-shaped groove at the side of a bead.

R.

RAIL.—Horizontal member in framing.

RAKE.—Inclined to the horizontal as "raking" rails in ship furniture and panelling.

RATCHET BRACE.—Brace fitted with adjustable bit holder to work in certain positions. 244-245.

REBATE.—A rectangular shape on edges of boards, etc., formed with rebate plane.

ROCOCO.—A style of ornament consisting of shell work, flowers, etc., particularly used in the French Louis XIV. and XV. periods.

S.

SCOTIA.—A classic moulding based upon elliptical curves. 130.

SCRATCH STOCK.—A small tool to hold shaped cutter of thin steel for "inlaying" lines and "scratching" small straight or curved mouldings. 181.

SCROLL.—A terminal used in conjunction with moulded pediments and caps to columns.

SEASONING.—Method of drying or seasoning timber by various processes such as water seasoning, natural seasoning, and dessication or kiln seasoning.

SECRET DOVETAIL.—Used in hardwood plinths to secure a secret dovetail with outward appearance of "mitreing."

SEGMENTS.—Curved pieces of wood used to build up table rails, etc., of circular and other curved forms.

SHUTTING STILES.—The meeting stiles of a pair of doors, or the locking stile of a single door.

SOFFIT.—The underside of a window, door, or fireplace opening.

STAR SHAKE.—A defect of timber shown in transverse section in the form of a star radiating from the pith column or centre of a log.

STILE.—The outside vertical members of a piece of framing.

STRAP HINGE.—A long shaped hinge usually of wrought iron used on Tudor furniture.

STUB TENON.—Used chiefly in cabinet door construction about two thirds the width of the stile fitting into a "stub" mortise.

STUCCO.—In furniture this term is usually applied to composition ornament in imitation of carving, also "Compo."

SURBASE MOULDING.—A moulding placed between the cornice and plinth, e.g. on the table part of a bureau bookcase.

SWAG.—Ornamental detail resembling a festoon of flowers or material suspended from two pateræ. A feature of "Georgian" and "Adam" ornament. 130.

T.

TRAJAN LETTERING—Roman lettering copied from the inscriptions on Trajan's column in Rome.

U.

UNDERCUT.—A carving term to indicate under cutting to increase the relief.

V.

VENEER.—Thin pieces of finely coloured or grained work formed by "saw cutting" or rotary knife cutting, called respectively "saw cut" and "knife cut."

VENEER PIN.—A very fine nail or pin about $\frac{3}{8}$ -in. long without a shaped head.

VOLUTE.—A spiral scroll.

W.

WAINSCOT OAK.—Oak cut specially on the "quartering" principle to secure fine "figure" or grain.

WARPING.—The twisting of boards due to unequal shrinkage.

WINDING.—A twisted surface instead of a perfect "plane" surface.

WORKING DRAWING.—Elevation, section, plane, etc., to show full-size measurements and sections.

GLOSSARY OF METALWORKING TERMS.

A.

- ACHILLES.**—A famous mythological Greek warrior.
- ADAM BROTHERS** —Architects of the eighteenth century.
- AGATE.**—An ornamental stone, a form of chalcedony.
- ALABASTER.**—A white, granulated variety of gypsum.
- ALCINOUS.**—The King of Phæcia who entertained Ulysses (q.v.)
- ALIGNMENT.**—To be in a straight line
- ALLOY STEELS.**—Steels containing other elements with and without carbon or iron.
- ALUMINOTHERMY (or Thermit Welding).**—A welding process in which a compound sold under the name of “thermit” (consisting of finely divided aluminium and oxide of iron) is used for joining iron rails.
- AMYL-ACETATE.**—A substance used in the preparation of collodion and other varnishes.
- ANILINE DYES** —A series of dyes obtained from coal-tar, a product of coal.
- ANNEAL.**—To soften by heating and gradually cooling.
- AQUA REGIA.**—A mixture of three volumes of hydrochloric acid and one volume of nitric acid.
- ARMOUR BRIGHT.**—Polished and having the appearance of armour.
- ASSYRIA.**—An Asiatic country between Mesopotamia and Media. It was the seat of the earliest known monarchy.
- AUSTIN FRIARS.**—Originally a priory founded in 1243. Now a district near the Bank of England, London.
- AUTOGENOUS.**—Self-generated.

B.

- B. A. DIE.**—A standard screw thread called the British Association standard.
- BALL HEAD STAKE.**—A piece of iron or steel with a ball-shaped knob at one end.
- BARROW, BRITISH.**—The grave of an ancient Briton.
- BASTARD FILE.**—Files are cut with a certain number of teeth to the inch. A bastard file is one between a rough file and a second-cut file.
- BENDING BARS.**—Two pieces of iron which fit closely together between which pieces of metal are held so that they may be bent.
- BENVENUTO CELLINI.**—An Italian sculptor and goldsmith of the sixteenth century.
- BESSEMER, SIR HENRY.**—Engineer. Inventor of the Bessemer process for making steel.
- BICK IRON.**—A piece of iron in the form of a letter “T.” One end is usually pointed and round.
- BINDING WIRE.**—Soft iron wire, comparatively thin, used for binding pieces of work together.
- BLANK.**—A flat piece of metal cut to a shape, ready for working up into a required form.

- BLOODSTONE.**—A semi-precious stone, dark-green and speckled with red.
- BLUEING.**—The heating up or letting down of the temper of steel until it assumes a blue colour (about 570° F.)
- BOILED OIL.**—Linseed oil which has been boiled, used for painting castings to prevent rusting.
- BOXWOOD.**—The wood of the box tree.
- BRANDT, EDGAR.**—A noted designer and metalworker of Paris.
- BRONZED.**—Coloured to look like bronze.
- BUCKLED.**—Irregular, wavy or bent.
- BUNSEN BURNER.**—A gas burner used when a hot, non-luminous flame is required.
- BURNISH.**—To polish a metallic surface by rubbing it with a hard stone.
- BURRS.**—Very thin sharp pieces of metal which are thrown up by the action of tools.

C.

- CABIN-HOOK.**—A hook used in ships to keep doors open or shut.
- CANOPY.**—A decorative cover over an altar, pulpit, etc.
- CARBON TOOL STEEL.**—An alloy of iron and carbon which may be hardened, tempered, and annealed.
- CELTIC.**—Pertaining to the Celts, an ancient race which formerly inhabited Italy, France, Spain and Great Britain.
- CENTRIFUGAL CASTING.**—Casting or pouring molten metal into a mould which is revolving at a high speed.
- CHAMFER.**—A bevelled edge.
- CHATTER.**—The vibration caused by lack of rigidity in machine tools.
- CHUCK.**—A revolving vice attached to the spindle of a lathe.
- CHUCKING PIECE.**—A piece of metal which has been purposely left on a job so that the job can be held in the lathe, afterwards removed.
- CLEARING HOLE.**—A hole made to allow a screw or a bolt to slip through.
- CLINCH.**—To make or hold fast by bending or folding together.
- CLINKER.**—A mass of partly vitrified brick.
- CLOISONNÉ ENAMELLING.**—A form of enamelling in which a pattern is raised by strips of metal or wire soldered on.
- COMPOSITE ARCHITECTURE.**—A form of architecture composed of the other four forms: Tuscan, Ionic, Corinthian, Doric.
- CONSTANTINE.**—Emperor of Rome. Born A.D. 272. Died A.D. 337.
- COPPER-OXIDISING.**—A process in which a piece of metal is copper-coloured, then blackened, and its high-lights relieved.
- CORE-BOX.**—A box in which the core for hollow casting is rammed up.
- CORINTHIAN.**—Pertaining to Corinth, a celebrated city of Greece.
- CORONA.**—A form of crown
- CORT, HENRY.**—A metallurgist born 1740, died 1800.
- COUNTERSINK.**—To bevel or chamfer the inside edge of a hole.
- CROCUS.**—Ferric oxide.
- CRUCIBLE.**—Deep cup-shaped vessels used for melting metals, made of fire clay or plumbago.
- CUPOLA FURNACE.**—A furnace in which cast iron is melted for foundry use
- CYMA.**—An architectural moulding (Greek: *cyma*, a wave or billow).

D.

DAMASCUS SWORDS.—Swords of high carbon steel which when tempered assume the many-coloured, watered appearance by which they are known.

DE LAVAUD PROCESS.—A process for casting iron pipes by pouring molten metal into a revolving mould.

DOMITIAN, EMPEROR.—Emperor of Rome first century A.D.

DORIC.—The earliest and simplest of the three Greek orders of architecture.

DOWEL JOINTS.—Joints held together with small cylindrical pieces of wood or metal.

DRAGON'S BLOOD.—A resinous gum from an East Indian palm, used for colouring metals.

E.

EMERY-BOB or BUFF.—A wooden disc or roller with emery powder glued upon its faces, which when revolved at a high speed is used for polishing metalwork.

ESCUTCHEON.—A covering for a key-hole, originally in the form of a shield.

ESTRAMADURA.—A district in Spain.

EXTINGUISHER STAKE.—A small Bick Iron (q.v.).

EXTRUDED.—Forced outwards.

EYE.—Usually denotes a circular ring or hole on or at the end of a rod.

F.

FACIA.—The plate or board on a shop-front on which is shown the owner's name, etc.

FARADAY, MICHAEL.—A Scientist, 1791-1867.

FEMALE THREAD.—An internal screw, i.e. a screw cut in a hole or hollow surface.

FILAMENT.—A fine metal thread.

FILLET.—A narrow band or raised rim of metal.

FINIGUERRA, TOMMASO.—A Tuscan goldsmith. Born 1410 Died 1475.

FIRE-CLAY.—A fire-proof substance composed of silica alumina and water in various proportions.

FIRTH, THOMAS—Producer of stainless steel at Sheffield, England.

FLAT.—A small flat surface

FLATTER.—A tool used by smiths, struck with a sledge-hammer.

FLUX.—A substance for assisting molten metals to flow easily.

FORMING TOOLS.—Tools of various shapes, usually to definite forms, used in the lathe to bring work to a uniform shape, used for repetition work.

FREEMAN.—A man in the enjoyment of liberty and entitled to certain privileges.

FRIDGILENE.—The name of a patent lacquer which can be used on cold work.

FULCRUM.—The point on which a lever turns.

FULLER.—A round-faced tool used for forming grooves in smith's work.

G.

GARGOYLE.—The projecting extremity of a gutter.

GAS-FIRED FURNACES.—Furnaces heated by various kinds of gas sometimes mixed with air.

GESSO.—A mixture of glue and whiting.

GIBBONS, GRINLING.—Sculptor, 1648-1721.

GILCHRIST.—A metallurgist of the nineteenth century.

GILCHRIST-THOMAS PROCESS.—A process invented by Gilchrist and Thomas, chemists of the nineteenth century.

GOLD-SIZE.—A substance made from pure gelatine much used by gilders.

GOLDSMIDT, DR. HANS.—Inventor of the Thermit welding process.

GRAPHITE.—Carbon; also called plumbago or black-lead.

GRILLE.—A lattice-work of metal.

GUM TRAGACANTH.—A species of gum obtained from shrubs in Asia Minor.

H.

HAND-CHASER.—A hand tool used for cutting screw-threads in or on metal in a lathe.

HOMER.—A celebrated Greek poet.

HUNTSMAN, BENJAMIN.—The inventor of cast steel Born 1704. Died 1776.

I.

INTAGLIO.—A figure cut or engraved into a substance. The reverse of Cameo.

IONIC.—One of the orders of Grecian architecture.

IRON AGE.—The last of the four Great Ages of the world.

I.S.W.G. (IMPERIAL STANDARD WIRE GAUGE)—A English standard of measurement used for metal.

K.

KNUCKLE.—The joint-pieces forming a hinge, through which the pintle passes.

L.

LACQUER.—A varnish sprayed or brushed over metal to preserve the surface.

LAPIS-LAZULI.—A rich blue stone.

LATHE-DOG.—A carrier on a lathe.

LEAD-PAINT.—A paint containing white lead.

LINING TOOL.—A tool with a thin edge like a chisel, used for making thin lines on a metal surface.

LUG.—A protection on a piece of work.

LUTE UP.—To make air-tight with a mixture of clay, water, loam, etc

M.

MANDREL—A revolving spindle of iron or steel used for holding work on machines.

METALLURGY.—The art of separating metals from their ores.

MOULDING SAND.—The material into which a metal is run in order to impart the definite outline required in castings.

MYCENÆAN.—Pertaining to Mycææ. An ancient Greek town.

N.

NEOLITHIC AGE.—One of the epochs of Prehistoric Archæology.

NICK.—A notch.

NIELLO.—The art of chasing out lines or forms and inlaying a black composition called niello.

O.

OVERSHOT CASTINGS.—Irregular castings caused by badly-fitting flasks.

OVOLO.—A convex moulding showing the quarter of a circle.

P.

- PALMETTE.**—A small ornament resembling a palm leaf carved upon some Roman mouldings.
- PANE (OR PENE)** —The pointed or edged end of a hammer-head.
- PANING HAMMER.**—A hammer having a narrow pane at each end.
- PARCELLING** —The treatment of only a part of a surface by plating or colouring.
- PART OFF.**—To cut a part, usually in a lathe.
- PATINA.**—The colour or incrustation which age imparts to works of art.
- PEARLING PUNCH** —A punch which forms small beads or pearls in relief.
- PEWTER.**—An alloy of tin and lead.
- PHIDIAS** —A famous Greek sculptor of Athens. Died 432 B.C.
- PICKLE.**—A mixture of acids for cleaning metals.
- PINS.**—Shoemakers' rivets Short thick nails with small heads.
- PITCH.**—A resinous substance obtained from wood and coal.
- PLANISH** —To bring to a plane surface.
- PLASTER OF PARIS** —A substance consisting of gypsum, heated to drive off the water.
- PLINY.**—A Roman historian Born A.D. 23. Died A.D. 79.
- PLUG.**—A stopper that fills a hole or recess like a cork.
- PLUMBAGO.**—Graphite.
- PYROMETER.**—An instrument for measuring the temperature or expansion of heated metals
- PYROTECHNY** —Pertaining to the art of making fireworks.

Q.

- QUARTZITE** —A very hard rock.

R.

- REIN.**—The handles of a blacksmith's tongs
- REPOUSSÉ** —Ornamental metalwork formed in relief and chased
- RIPPER.**—A round-ended tool used by brass-finishers to turn work in a lathe.
- ROUGE.**—Ferric oxide.

S.

- SAL-AMMONIAC.**—Chloride of ammonia.
- SARACENIC.**—Pertaining to the Saracens—the mediæval name for Arabs or Mohammedans.
- SAVE-ALL.**—A contrivance to hold a candle-end in a candle-stick while burning.
- SCARF** —The flattened edges of iron prepared for welding.
- SCRATCH-BRUSHED** —A wire-brush used for brushing sand and dirt off the surfaces of castings
- SENNIT CORD** —A coarse hempen yarn.
- SHEFFIELD LIME.**—A prepared lime used for polishing metals.
- SHELLAC.**—A crude resin lac, a varnish.

- SHUT A COLLAR**—To place a red-hot metal collar round pieces of work and then hammer or press the ends together whilst at a red heat. On cooling the collar contracts, so binding the work together.
- SIEMENS-MARTIN**.—A method of manufacturing steel by fusing together pig-iron and iron-ore.
- SILVER-PLATED**.—Covered with a thin coating of silver, usually by electrolytic action.
- SLUSH MOULD**.—A mould into which molten metal is poured and immediately decanted, leaving on the inner side of the mould a thin coating of the metal. Imitation bronzes and toy soldiers are made in this fashion.
- SMITH, DR. ANGUS**.—Inventor of a tar compound for coating iron pipes to prevent the formation of rust.
- SPATULA**.—A broad flat tool, slightly rounded like a finger top.
- SPELTER**.—An alloy of equal parts of zinc and copper.
- STAINLESS STEEL**.—An alloy of iron, chromium and carbon. A rust-resisting steel.
- STAKE**.—A piece of iron or steel made in various shapes with a pointed and squared end which fits into a heavy wood block, used for shaping metals.
- STRETCHING-HAMMER**.—A hammer with two thick panes, one at right-angles to the other, used for raising or working up metal bowls, etc.
- STRIATED**.—In wavy stripes.
- SUGAR-LOAF MANDREL**.—A tapered iron tool used for making roughly-shaped holes and rings into perfect circles.

T.

- TANG**.—The pointed end of a tool which is driven into a wood handle.
- TAPER TAP**.—A tap for cutting screw threads, sold in sets of three: first taper, second taper, and plug.
- TAPPING HOLES**.—Holes drilled a size so that they will allow a full thread to be cut by a tap.
- TAZZA**.—A shallow bowl on a stem or foot. See page 128.
- TEMPLET**.—A thin light plate of metal cut to special outlines.
- TENONS**.—Tongues projecting from a piece of metal which, together with the holes into which they fit, form one of the commonest joints in metalwork.
- THEODOSIUS**.—Emperor of Rome. Born A.D. 335. Died A.D. 395.
- THEOPHILUS**.—An eleventh-century monk who worked in gold and silver and wrote a treatise on the subject.
- THERMIT**.—A mixture of metallic oxide (usually iron) and pulverised aluminium.
- THOMAS**.—A metallurgist of the nineteenth century.
- TRACER**.—A tool similar to a lining tool for tracing or making lines on metal.
- TRIPOLI**.—A fine earth used in polishing, found at Seneca, Missouri, U.S.A.
- TUMERIC**.—The root of an East Indian plant used for colouring lacquers.

U.

- ULYSSES**.—A famous Greek hero and King of Ithaca.
- UPSET**.—To thicken up. A piece of metal is made white-hot and then hammered so that the part heated is made thicker.
- UZZIAH**.—King of Judah who reigned from 808 to 756 B.C.

V.

VEE-BLOCK.—A rectangular piece of metal with a vee cut down the centre.

VITRIFIED SUBSTANCES.—Substances that have been converted by heat and fusing into glass.

VITRUVIUS.—A Roman architect *circa* 80 B.C.

VOLATILISE.—To change immediately into vapour without first becoming liquid.

VULCAN.—A son of Juno. A mythological god famous for his metalwork.

W.

WATER-OF-AYR STONE.—A smooth, hard, fast-cutting stone used for polishing metal. The stone is dipped into water and rubbed upon the surface requiring to be polished.

WATT, JAMES.—A Scotch engineer. Born 1736. Died 1819.

WELD.—To unite two pieces of metal by fusing and hammering.

WHALE-BONE—A horny substance found in the mouth of a whale.

WHITING—Fine chalk pulverised and freed from all impurities by washing.

WOBBLE.—To move from side to side irregularly.

WÖHLER, DR.—Discovered aluminium at Göttingen in 1827.

WOOLLEY, MR. C. LEONARD.—Director of the recent excavations at Ur-of-the-Chaldees, Mesopotamia.

WROUGHT IRON.—Pig-iron subjected to the process of puddling, i.e. stirring up with long rods while in a molten state.

Y.

YARRINGTON, ANDREW.—Ironmaster of the seventeenth century.

INDEX

NOTE.—The page numbers in thin type refer to references in the text; numbers in black type refer to illustrations, or to references accompanied by an illustration on the same page.

WOODWORK

(For index to METALWORK SECTION, see p. 325.)

A

Abacus, 130
Adam, R. & J., 129
 " doorways, 129, 130, 131, 132, 133
Ages or periods—
 Stone, copper, bronze, and iron, 1
Ammonia, 286
Ancient Egyptian furniture, 5
 " " sculpture, 3
Angle brackets, 52
 " for dovetailing, 29
 " joint, 31
Animal forms of prehistoric art, 2
Antiquity of craft-work, 1
Appliqué, 200
Architects, great, 4
Architectural terms, 129-132
Architrave, 130
Ark, the evidence of construction of, 3, 4
Artichoke-, galls, 143, 144
Artist craftsman, 4

B

Back, four-panelled, 293, 294
Backs, panelled, 293
Base, 130
Bead, 130
Beech, 139
Bench demonstration, 233
 " wood-worker's, 237, 239, 240

Bevel, adjustable, 242, 243
Bi-chromate of potash, 285
Bookstand, 29, 30
Boom, 302
Boring tools, 244, 245
Boule work, 146
Bow saw, 241, 243
Boxes, Swiss-painted, 186
 " carved, 189, 190
Brace, historic, 138
 " ratchet-, 244, 245
Brackets, angle, 52
 " for candle, 36
Bradawl, 242, 243
Bread platters, 43, 44, 45
Bridling, 55
Bronze Age, 2
 " celts, 2
Brush, scratch wire, 287
Building for centre equipment, etc., 232-58
Burnishing, 286

C

Cabinet, chest, 293, 294
 " music, 290
 " specimen, 290
 " stationery, 200
 " wireless, 301, 302
 " with marquetry, 174
 " writing, 290
Cabinets, tool-, 234, 235, 236

- Candle bracket, 39, 40
 Carbon paper, use of, 27
 Carved box, 190
 " caskets, 189
 " cupboard, 190
 " panel, 187
 Carving, 30, 184
 " application of, 42, 58
 " Norwegian and Scandinavian, 185
 Cases, clock, 33, 296, 297
 Cavetto, 130
 Cellulosing, 288
 Cellutex, 302
 Celts, forms of chisel, 205, 206
 Centre-bit, 245, 246
 Chair, Egyptian, 5
 Channelling, 130
 Chisel, Early English and foreign forms of, 205, 206
 " Japanese, 205
 Chisels, firmer, 244
 " various, 244
 Circular rims, construction of, 56
 Classical quotations, 3
 Climatic conditions, 138
 Clock, balloon, 297, 298
 " case, 23, 24
 " movements, 298, 299
 Colour, body, 284
 Column circular, 130
 " development and forms of, 129, 130, 131
 " origin of, 130
 Compasses, steel, 245, 246
 Composite order, 130
 Conventional designs, 176
 Cornice, 130
 Corona, 130
 Cotton wool, 285
 Countersink, 245, 246
 Cow collar, 200
 Crackle, 285
 " coloured, 285
 Craftwork, historic: application to classwork, 129
 Cramp, Gee, 245, 248
 " handscrew, 245, 246
 " woodworker's, 245, 246
 Crossbanding, 55
 Cupboard, livery, 6
 Cupboards, carved, 190
 Currant galls, 144
 Cyma recta, 130
 " reversa, 130

D

 Decoration, diaper, 49
 " geometrical, 49
 Decorative processes, 175, 183
 Dentil, 130
 Dividers, Spring, 246
 Door construction, 295
 " -knockers, 27, 28, 29, 172
 Doorways, features of, 129-33
 " historical styles, 129-33
 " object lessons on, 132-33
 " Southgate Street, Winchester, 131
 Doric, 130
 Dovetailing, 54
 " angles for, 29
 " diminished, 32
 " lapped-, 30
 " through, 22
 Dovetails, 29
 " cutting, 29
 Dowel bits, 244, 245
 Drawer guide, 292
 " pulls, wooden, 295, 296
 Drawing, 160
 " projection of a, 159, 160, 161, 162
 Drill, evolution of, 213
 " hand, 242, 243
 Drip moulding, 130
 Durer, A., sixteenth-century tools, 201
 Dutch cabinet, 174

E

 Edges, decorated, 294, 295
 Egyptian arts, 2, 3, 5
 " chairs, 3, 5
 " stools, 3, 5
 Enamels, cellulose, 288
 Engraved bone, 2
 Entablature, 130
 Entasis, 130
 Equipment and tools for centres, 242-47

Evidence of early art, 2
 Exogenous growth, 138
 Expansion bit, 244, 245

F

Facia, 130
 Fanlights, 129
 File, wood, 242, 243
 Fillet, 130
 Filling-in, 285
 Finger-plates, 41, 42
 Finish, crackle, 284
 " dull, 284
 " waxed, 287
 Finishes, metal-leaf, 286
 " transparent, 288
 " woodwork, 283
 Firmer chisel, 244, 245
 " gouge, 244, 245
 Flap or fall, 53
 Flower-support, 13
 Fluted column, 129
 Forking, 155
 Frame, half-lapped, 15, 16
 French polishing, 285
 Fretsaw, 241, 243
 Frieze moulding, 130
 Fuming, 286
 " cupboard, 286

G

Gauges, cutting-, 245, 246
 " marking-, 245, 246
 " mortise-, 245, 246
 Gibbons, Grinling, 187
 Gimlet, twist, 242, 243
 Glove box, 25, 26
 Glue-pot, 237, 245, 246
 Gold size, 286
 Gopher wood, 4
 Gothic livery cupboard, 6
 " windows, 132
 Gouge carving, 244
 " firmer, 244, 245
 " flint, 205
 " patterns, 180
 " tooling, 30, 38
 Grain twisted, 140

Grindstone, 237, 238
 Guttae, 129, 130
 Gwydir Castle, 27

H

Hafting, early forms of, 205
 Half-lapped frame, 13, 15, 17
 " " " joints used in, 16
 " " " setting out, 16
 Hammer evolution of, 207, 208, 209,
 210, 211
 " London pattern, 242, 243
 " mediæval forms of, 207
 Hand drill, 242, 243
 " holes, 22.
 Handkerchief box, 25, 26
 Handscrew, English, 245, 246
 Hardwoods, 140
 Hinge, pivot, 293
 Hinging, 293
 " centre, 293, 296
 " a knocker, 28
 " pivot, 26
 Historical notes on craftwork, 1-4, 129
 Holdfast, bench, 245, 247
 Hollow moulding, 130
 Husk ornament, 130

I

Incised pattern, 183
 Inkstand, 33
 Inlaying, 40, 41, 174
 " application of wood, 35, 38,
 40, 48, 58
 " designs for, 176, 178
 " Eastern examples, 178
 " pictorial, 177
 " procedure for, 41, 179
 " with wax, 30, 182
 Introduction of gold, 1
 Ionic, 130
 Isometric axis, 161
 " projection, 160
 Ivory, uses of, 146

J

Japanese pearl, 146

K

Keyhole saw, 241, 243
 Keyrack, 13, 14
 Knife box, 21, 22
 Knocker, 27, 28
 Knotting, patent, 283

L

Lacquer, vermilion, 284
 Lamp bracket, 36
 " " hanging, 34, 35
 Latch and bolt, 47
 Lathe, 237
 Lead, red, 283
 Legs, turned, 51, 52
 Lettering, 27, 166
 " methods of cutting, 27
 Liming, 287
 Livery cupboard, 6

M

Machinery, 10
 Mahogany, 139
 Mallet, 239, 240
 Marking awl, 239, 240
 Marquetried cabinet, 174
 Materials used in handcraft work, 138
 Mirror frames, 37, 38, 39, 49
 " shaving, 39
 " swing toilet, 48, 49, 50
 Mitre block, 242, 243
 Models, demonstration, 292
 Modillion, 130
 Module, 130
 Morris, William, 1
 Mortise and tenon joints, 37, 38
 " chisels, 244, 245
 Mosaic edging, 180
 Mother of pearl, 146, 180
 " " " inlaying, 178
 Mouldings, 32

N

Name-plates, 27, 28

O

Oak-apples, 143, 144
 " European, 139
 " limed, 287
 " tree, growth of an, 142, 143, 144
 " weathered, 287
 Oblique projection, 160
 Occasional table, 55, 59
 Oilcan, 245, 246
 Oilstones, varieties, 242, 243
 Old woman's tooth, 239, 240
 Orthographic projection, 160
 Overlaying, pictorial, 177
 Ovolo moulding, 130

P

Paint filler, 284
 Painting, 283
 " coach, 284
 " decoration, 36
 " interior, 283
 Panel saws, 241, 243
 Paring chisel, 241, 243
 Pateræ, 130
 Peasant art, 185
 Pedestal, 130
 Pen trays, 19, 20
 Perspective, drawing in, 161, 162, 163, 164
 Petrie, Prof. Flinders-, 2
 Pictorial inlaying, 177, 179
 " overlaying, 177
 " projection, 160
 Picture frames, 15, 16, 17, 39, 40, 41
 Pigeon holes, 53, 54
 Pilasters, 129, 131
 Pin-bit, 245
 Pincers, 242, 243
 Pine, yellow-, 139
 Pinning, 45, 46
 Pin or pivot-hanging, 45, 46
 Pin trays, 19
 Plan of shop, 233
 Plane block, 239, 240, 242
 " historic, 214
 " jack, 238, 239
 " rebate, 239, 240
 " shoulder, 239, 240

Plane, smoothing, 239, 240
 " trying, 238, 239
 Plinth, 130
 Plough, 239, 240
 Polish, button, 285
 Poplar, 139
 Portcullis, 129
 Portico, 129
 " Adam, 130
 Powder, aluminium, 287
 " gold, 287
 " silver, 287
 Powders, metal, 287
 Prehistoric art, 2
 Priming colour, 283
 Projection, system of, 159
 Pumice, powdered, 284
 Punch work, 10, 184

R

Ramification, 143, 144, 145
 Rasp wood, 242, 243
 Rays, medullary, 140
 Recessing, application of, 34
 " patterns for, 35
 Roots, hair, 143
 " secondary and primary, 143
 Rose-head countersink, 245, 246
 Router, 45
 Royal exchange, 129
 Rubber, polishing, 285
 Rule, iron, 239, 240
 Ruler, 13

S

Sandblasting, 287
 Sap, 143
 Saw, bow, 241, 243
 " circular, 236
 " compass, 241, 243
 " dovetail, 241
 " Egyptian chest, 204
 " fret, 241, 243
 " hand, 241, 243
 " Japanese, 204
 " keyhole, 241, 243
 " knife, 203

Saw, mediæval, 203
 " panel, 241, 243
 " Swiss flint, 203
 " tenon, 243
 " various, 201, 202, 203, 204, 241, 242
 Scandinavian work, 184, 185
 Scotia, 130
 Scratch stock, 181
 Screwdriver, 242, 243
 Segmental building up, 55, 56
 Set mitre, 242, 243
 Shaft of column, 130
 Shellac, button, 285
 Shooting board, 246, 247
 Shop decoration, 234
 " flooring of, 234
 " ventilation of, 234
 Silver grain, 140
 " spoons, 10
 Skirting, 10
 Slips, oilstone, 242, 243
 Slot screwing, 36
 Soft woods, 140
 Spinning implements, 191
 Spiriting off, 285
 Spoke-shaves, iron and wood, 239, 240
 Spoon-bit, 244, 245
 Spray pistol, 288
 Spraying paint, 288
 Spring growth, 143
 Square, try, 245, 247
 " wooden, 247
 Staining, 285
 Stationery case, 43, 52, 53, 54
 Stencilled ornament, 37
 Stencilling, 16, 18, 26, 37, 38, 40, 42
 Stiles, 131
 Stone Age, 2
 Stool, construction of, 50, 51, 52
 Store, timber, 232, 233
 Straight-edge, 247
 Strapwork, 27, 28
 Striking knife, 239, 240
 " plate for knocker, 28
 Stringings, drawings of, 56
 Styles in architecture, 130
 Subbase, 130
 Swag, 130
 Swiss painted boxes, 186

T

Table, circular, 57
 „ construction of, 57, 292
 „ oblong, 57, 58
 „ occasional, 55, 56, 57, 58, 59
 Tablet, handles, 299, 300
 Tea caddies, 44A, 44B
 „ tray, 31, 32
 Templet, use of, 56
 Tenon, mitred, 51, 52
 „ saw, 240, 243
 Timber, characteristics of, 144
 „ chart, 139
 „ classification, 139
 „ growths, 138, 140, 142
 „ hard and soft, 140, 141, 142
 Toilet mirror, 48, 49, 50
 Tool cabinets, 234, 235, 236
 Tooling, application of, 42, 58
 Tools, early forms of, 201
 „ list of, 238
 Tothing, 192
 Tortoise shell, 146
 Tortus, 130
 Towel rail, 46
 Tracery, 129, 131
 Tray bottoms, glass, 299
 Trays, brush and comb, 299, 300
 „ construction of, 299, 300
 Try-square, 245, 247
 Turning, construction of, 52
 „ designs for, 51, 52
 Tuscan, 130
 Twist-bits, 244, 245
 Tyrolean detail, 183

U

Under railing, 51, 55, 57
 Upholstered stool, 50, 51, 52

V

Varnish, astringent, 285
 „ colourless, 285
 „ lacquer, 287
 Vee tooling, 25
 „ „ application of, 14, 26, 36
 Veneered pattern, building up, 188
 Veneering, 187
 „ caul, 192
 „ designs, 188
 „ procedure for, 187
 Venice turpentine, use of, 182
 Vice, horizontal, 247
 Von Reber, 130

W

Walnut, black, 139
 Watchstand, 17, 18
 „ method of making, 18
 Waxing, 286
 Whitewood, American, 139
 Wild rose design, 176
 Winding strips, 247
 Winklestein, 130
 Wireless cabinets, sizes of, 302
 Wood, laminated, 292
 Wood-working tools, 239, 243, 244,
 245, 247
 Working drawings, 161
 Workshop, arrangement of, 232
 „ plan of, 233

Y

Yew, 139

INDEX TO METALWORK SECTION

A

- Achilles, 8
 Addison, J. de Wolf, 137
 Agate, 222
 Alabaster, 8
 Alcinous, palace of, 8
 Alloy steels, 12
 Alloys, 148
 " characteristics of, 148, 152
 Altar front, 10
 Aluminium, 12, 152
 " bronze, 152
 Aluminothermy, 226
 Amalgam, 148
 Amalgamation, process of extraction
 of metals, 158
 Amyl-acetate, 223
 Angle and corner plates, 68, 69, 74, 77
 Angles for cutting tools, 275, 276
 Aniline dyes, 223
 Annealing metals, 230
 Antimony, 152
 Anvil, cutter, 253, 254, 255
 " smith's, 255, 256
 " tinman's, 258, 259.
 Applied ornament, 192
 Appliqué, 192, 200
 Aqua regia, 156
 Armour bright, 84
 Ash-trays, 78, 79
 Assyria, 8
 Autogenous welding, 154, 224
- B**
- B.A., 113
 Ball head-stake, 258, 259
 Beaker, 279
 " method of procedure, 278-80
 Bellows, double-blast circular, 255, 256
 " Fletcher Russell foot, 258,
 259
 Belton house gates, 135
 Bench, metal-worker's, 265
 Bending, 66, 67
 Bessemer, Sir H. G., 12
- Bidri ware, 193
 Bismuth, 152
 Block, for chopping, 266
 " tin, 156
 Blood-stone, 222
 Blow-holes, 222
 " pipe, gas, 258, 259
 " " welding, 226
 Blue, 66
 Boiled oil, 76
 Bolting, 228
 Bottom tool, 253, 254
 Bowl, six-lobed on cast foot, 280
 Bowls, 80, 95, 96, 97, 98, 99, 100, 101,
 102
 " hammered, 101, 102
 " pin, 79, 80
 " method of raising, 88
 Box, tinned-iron, 74, 75
 " tongs, 256, 257
 Boxwood, 90
 Brace fitters, 256, 257
 Brandt, Edgar, 172
 Brass, 152
 Brazing, 226, 227, 230
 " pan, 258, 259
 Bright dip, 193-223
 Britannia metal, 152
 Broach, 251, 252
 Bronze, 153
 " Age, 7
 " bowl, 101, 102
 " founding, 10
 " Gates of Shalmaneser II., 8
 " hammers, 207-II
 " lamps, 10
 Bronzed, 120
 Bronzing, 193, 222, 225
 Buddha, 11
 Building and equipment for handcraft
 centees, 232
 Bunsen burner, 226
 Burning, 225
 Burnisher, 222
 Burr, 106
 Burton die, 251, 252
 Byzantium, 9

- C**
- Cabin hooks, 63, 64
 Cadmium, 153
 Calamine, 9
 Calipers, outside, 70, 71, 248, 249
 Candlestick, turned brass, 107, 108, 109, 110
 " " iron, III, 112, 113
 " wrought-iron, III, 112
 Canopy, 116
 Carbon paper, 71
 Card wire brush, 248, 249
 Casket, 170
 Cast brass candlesticks, turned, 107, 108, 109, 110, 111
 Casting "cire perdue," 221
 " faults of, 220
 " lead vice clamps, 280
 " or founding, 220
 Castings, imperfect corners, 222
 " oval, 222
 " overshot, 222
 " seared, 222
 Celtic finger-plates, 88, 89
 Centre, a loose, 90, 91, 92
 " or mitre punch, 63, 64, 248, 249
 " squares, 88-9
 Centrifugal casting of iron, 231
 Chamfer, 60, 61, 62
 Chandelier, Dutch, in brass, 168
 Chariot burials, 9
 Chaser, inside and outside, 251, 252
 Chasing, 194
 " tools, 257, 258
 " " method of holding, 97
 Chatter, 119
 Chest mountings, 68, 69, 77
 Chisel, cutting action of, 272
 " engraving, 198
 " hand on cold, 72, 73, 248, 249
 " method of holding, 208
 Chopping block, 266
 " out, 66, 67
 Chromium, 153
 Chryselephantine works, 7
 Chucks, 90, 91
 Circular split die, 251, 252
 Cleaning, colouring, etc., of metals, 222, 223
 Clinched, 84
 Clip, development of, 85
 Clock-case, silver oxidised, 127, 128
 Cloisonné, 10, 195
 Coach wrench, double-action, 250, 251
 Cobalt, 153
 Coke-making, 11
 Cold set, 253, 254
 Compasses, wing, 248, 249
 Composition of alloys, 148
 Conductivity of metals, 151
 Constantine, 10
 Constantinople, 9
 Contraction of metals, 151
 Copper, 7, 153, 215
 " Age, 7
 " candlesticks, 81, 82
 " oxidised, 120
 Core-box, method of making, 110
 Corner clamps, 69, 77
 " plates, 61, 69, 77
 Cort, Henry, 11
 Countersink, 113
 " rose, 259, 261
 " slcombe, 259, 261
 Court, 11
 Cowper, Coles, 223
 Craftwork, Historic, application to class-work, 129
 Cramp-pin, 65, 66
 Creasing iron, 257, 258
 Crocus, 124
 Cropper, 257
 Crucible, 221
 Cupboard button, 68
 Cupola furnace, 221
 Cutters, 271
 Cutting action of tools, 270, 271, 272-7
 " tools, examples of, with cutting angles, 271, 275
- D**
- Dagobert, 10
 Damascening, 194
 Damascus swords, 9
 Darby, Abraham, 11
 Decorative processes, 192

- De Lavaud process, 231
 Delta metal, 153
 Design, 159, 161, 163
 Development of cone, 105
 Die, circular split, 251, 252
 Dipping, 222-5
 Dishes or pateræ, 94, 95
 Distillation of metals, 158
 Dog-bars, 137
 Domitian Emperor, 194
 Dowel joints, 90
 Dragon's blood, 223
 Drawbridge, 136
 Drawer handles, 76-7, 82-3
 Drawings, projection of, 159, 160, 162
 Drift, 64
 Drift Punch, 253, 254, 257, 258
 Drill, diamond-pointed, 70, 71
 " morse, 261
 Drilling and turning, 274
 " appliances, 211, 213, 214
 " machines, 255, 256
 " plug, 90, 91, 92
 Drills, evolution of, 211, 214
 " various, 211, 212, 213, 214, 259, 261
 Drill-stock, Archimedean, 260, 261
 Ductibility of metals, 151
 Dunstan, Archbishop of Canterbury, 10
 Dutch, 114
 " chandelier, 168
 " metal, 153
- E**
- Eighteenth-century gates, 133, 134, 135, 136, 137
 Eleanor, Queen, 10
 Electric welding, 226
 Electrolytic methods, 158
 Electro-plating, 194
 Elizabeth, reign of, 11
 Elizabethan finger-plate, 88, 89
 Emboss, 113
 Embossed work, 195
 Emery bob, 72
 Enamelling, 9, 195, 196
 Engineer's hammer, 248, 249
 Engraving, 196, 197
 Engraving and punched decoration, 196, 197
 " chisel, method of use, 198
 Equipment, 248, 263
 Escutcheons, 60, 61, 62
 Estramadura, 10
 Evolution of drill, 211, 214
 " " hammer, 207-11
 Examples of raised work, 79, 96
 Extraction of iron, 158
 " " metals, 157
 Extrude, 150, 154
- F**
- Facias, 166
 Female, thread, 90
 Filament, 156
 File half-round, 248, 249
 " hand bastard, 248, 249
 " teeth, 271, 272
 Files, cutting action of, 272, 273
 " various, 272, 273
 Filgree work, 197
 Filing, 272
 " position, 274
 Finger-plates, 72, 73, 87, 88, 89
 Finiguerra, Thommaso, 199
 Finishing metal-work, 222
 Firebacks, cast iron, 11
 Fire-clay, 221
 Fire-screen, 169-72
 Fireside companion, 169
 Firth, Thomas, & Son, 12
 Flatter, 253, 254
 Flushing handle, 76
 Fluxes, 227
 " table of, 227, 229
 Force fit, 228
 Forge, portable, 255, 256
 " practice, models for, 63, 64, 65, 66
 Forging, 63, 64, 65
 Foot-bellows, Fletcher-Russell, 258, 259
 Footmen, 103, 104
 Founding or casting, object lesson on, 220
 Freeman, 9
 Fret saw frame, 257, 258

- Fret saw frame, method of holding, **104**
 Fulcrum, 93
 Fuller, bottom and top, 253, 254
 Funnel stake, 258, 259
 Fusibility of metals, 151
 Fusing, 277
- G**
- Gargoyles, 10
 Gas-fired furnaces, 12
 Gas-stove, tinman's, 248, 249
 Gates, 133, 134, 135, 136, 137
 " eighteenth-century, 133, 134, 135, 136, 137
 " wicket, 136
 Galvanizing, 223
 Gauge, grinding, 70, 71
 " Imperial Standard, 249, 250
 Gauls, 9
 German finger-plates, 88, 89
 " silver, 153
 Gesso, 166
 Gilchrist, Thomas, 12
 Gilding, 198
 " metal, 153
 Gold, 153
 " Age, 7
 " -size, 198
 Goldsmidt, Dr. Hans, 12
 Graphite, 221
 Grilles, Iron, 74, 77, 83, 85, 86, 173
 Grindstone, 255, 256
 Groover or Seam set, 258, 259
 Gunmetal, 153
- H**
- Hack sawblades, 250, 251
 " saws, 248-50
 " " Lancashire, 248, 249
 " " method of holding, 250
 " " Star, 249, 250
 Hafting, method of, 210
 Half-moon edging stake, 258, 259
 Hammer-head, 90, 91, 92
 Hammered work, 78, 79, 80, 81, 82
 Hammers, evolution of, 207, 208, 209, 210, 211
 " various, 90, 91, 92, 257, 258
- Handle balance, 90, 91
 " cage, method of making, 125, 126
 Handles, decoration of, 85
 " drawer, 83, 84, 85
 " implement, 120, 121, 122, 123, 124
 " method of making, 84, 85
 " ring, 76, 77
 Hardening and tempering of metals, 215, 216, 217
 Hardie, 253, 255
 Hardness of metals, 152
 Hatchet stake, 259, 259
 Henkle, J., 9
 Hinges, 113, 114, 115, 116
 Hints when working metals, 230
 Historical notes on metals and metal-working, 4
 Holdfast, 63, 64
 Homer's "Odyssey," 7, 8
 Hook and eye, 261, 263
 Huntsman, 11
- I**
- Inlaying, 198
 Intaglio, 192
 Iridium, 154
 Iron Age, 8
 " burnt, 219
 " cast, 11
 " fire-screen, 169-72
 " gates, 133, 134, 135, 136, 137
 " " Belton House, 135
 " " Bloomsbury, 137
 " grilles, 74, 77, 83, 85, 86, 173
 " panel, 173
 " railings, 133, 134, 135, 136, 137
 " scroll, 253, 255
 " soldering, 248, 249
 " work, Spanish, 11
 " wrought and cast, 154
 " " " " how to distinguish, 219
- J**
- Jacobean hinges, 114
 Joining metals, 225-30
 Joints in tin-plate, 105, 230
 " for hinges, 115, 116

K

Keltic finger-plates, 88, 89
 „ work, 9
 Knocker, 172
 Knuckle for hinges, method of making,
 115, 116
 Knurling wheel, 251, 252

L

Lacquering, 199, 222, 223
 Lamp irons, 136
 „ standards, 136
 Lancashire hack-saw, 248, 249
 Lanterns, 117, 118, 119, 120
 Lapis lazuli, 7
 Lathe, carriers, 261, 262
 „ chucks, 260, 261
 „ dog, 92
 „ foot, 261, 262
 „ tool-holder, 260, 261
 „ tools, 259, 260, 261, 262
 „ „ for brass, 260, 261
 Lead, 9, 11, 154
 „ and zinc method of extracting
 metal from ore, 158
 Leaf of a gate, 173
 Leonardo da Vinci, 10
 Lettering in metal-work, 160, 165,
 166, 168, 171
 Lever, 63
 Link extinguishers, 137
 „ holders, 137
 Liquefaction, 158
 Lock-plates and handles, 169
 Lubricants, table of, 94
 Lubrication, 94
 Lustre, 150
 Lute up, 215
 Lyre forms, 137

M

Magnesium, 154
 Malleability of metals, 150
 Mandrel, 93
 Manganese, 154
 „ bronze, 154
 „ steel, 154
 Memorial brasses, 11

Memorial tablets, 168, 171
 Mercury, 155
 Metal appliqué, 200
 „ colouring, 193
 „ spinning, 199
 Metallurgy, 7
 Metals, 147
 „ characteristics of, 148-52
 „ descriptions of, 152-7
 „ distinguishing and testing, 219
 „ extraction of, 157
 „ historical notes on craftwork,
 9, 133
 „ method of hardening and tem-
 pering, 215-17
 „ „ „ joining, 225-30
 „ object lessons on, 215
 „ properties of, 149
 „ shrinkage of, 151, 152
 „ to clean, finish, etc., 193, 224,
 225
 Metalworker's bench, 265
 „ shop, 263, 268, 269
 „ tools, 249, 250, 251,
 252, 253, 254, 255,
 256, 257, 258, 259,
 260, 261
 Methods of hafting, 210, 211
 Michael Faraday, 12
 Mild steel, 155
 Milling, 277
 „ tool, 251, 252
 Moat, 136
 Models for forge practice, 63, 64, 65,
 66
 Morse drill, 261
 Moulding sand, 107
 Muntz metal, 155
 Mycenaean, 209

N

Name-plates, 165, 166, 167, 168, 171
 Neolithic Ages, 209
 Nicked, 230
 Nickel, 155
 „ steel, 155
 Niello, 10, 199
 Nippers, cutting, 257, 258
 Notes on Centuries (1st to 19th), 9, 10,
 11, 12

O

Object lessons, data for, 215
 Oil-can, method of making, 104, 105,
 106
 Oriental finger-plates, 88, 89
 Ormolu, 155
 Osmium, 155
 Oxy-acetylene, 172

P

Palace of Alcinous, 8
 Pala d'Ora, 10
 Palladium, 155
 Paneel gilt, 10
 Pateræ, 94, 95
 Pattern for brass candlesticks, 107,
 108, 109, 110
 Pearling, 60
 " wheel, 251, 252
 Pediment, wrought iron, 173
 Pere, 209
 Persians, 198
 Perspective, 161, 162, 163, 164
 Pepper-box head-stake, 258, 259
 Pewter, 10, 155
 Phidias, 7
 Phosphor bronze, 155
 Picture suspender, 71, 72
 Piercing, 199
 " saw, 104
 Pilaster, 137
 Pin-bowl, 79, 80
 " cutter, 74, 75
 Pitch, to make up, 97.
 Planish, 95
 Plaster-of-Paris, 97
 Platinum, 156
 Pliers, various, 257, 258
 Plumbago, 221
 Poker, 121, 122, 123, 124, 125, 126,
 127
 " handles, 121, 122, 123 —
 Polishing metals, 222, 223
 Portcullis, 136
 Preserving metal-work, 222-5
 Process for making iron frame, 74, 77
 Properties of metals, 149
 Pumice-stone, 198

Punch decoration, 78, 79, 100, 196,
 197
 " round drift, 253, 255
 " square, 253, 254
 Pyrometer, 216
 Pyrotechny, 154

Q

Quartzite, 208
 Queen Eleanor, 10
 Quicksilver, 155

R

Rack for smith's tools, 266
 Raising, method of, bead on a plate, 96
 " " " on a stake, 95, 99
 Rake, smith's, 254, 255
 Ramps, 137
 Reamer, 65, 66, 251, 252
 Recipes for cleaning, colouring, etc.,
 193, 224, 225
 " " lubrication, 94
 Rein, 122
 Rejas or screens, 136
 Repoussé tools, 257, 258
 Riffle (process), 124
 Riffler, 257, 258
 Ring handle, 76, 77
 Riveting, 227, 228
 Rivet set, 258, 259
 Rolled gold, 225
 Romans, 9
 Rooge, 99

S

Saffron, 223
 Sal-ammoniac, 99
 Saracens, 198
 Save-all, 113
 Saw-blades, 249, 250
 " cutting, action of, 272
 " fret, 257, 258
 " Lancashire hack, 248, 249
 " method of holding hack, 250
 " piercing in metal, 104
 " star hack, 250, 251
 Scarf, 80, 122
 Scraper, 273

- Scratch brushing, 222
 " card, 248, 249
 Screens, 11
 Screw plate, double-handed, 251, 252
 Screwdriver, 63, 64, 65
 Screwing, 228, 276
 Screws, 228
 Scriber, 72, 73, 248, 249
 " steel, 72, 73
 Scroll, horn, 253, 255
 " iron, 253, 255
 " wrench, 253, 255
 Sea-coal, 11
 Seam-set, 258, 259
 Sennit-cord, 209
 Set-hammer, 253, 254
 Sett, hot or cold, 253, 254
 Shalmaneser II., 8
 Shearing and punching, 274
 " machine lever, 256, 257
 Shears, in action, 271
 " tinman's, 257, 258
 Shovel, smith's, 253, 255
 Shrink fit, 230
 Shrinkage in castings, 151, 152
 Shut a collar, 122
 Siemens-Martin Process, 12
 Silver, 156
 " cup, dish, and jug, 100, 102
 " mazer, 100, 102.
 " -plated, 102
 " -oxidised, 120
 " solder, 156, 227
 Silveroid, 153
 Sledge-hammer, straight-pane, 256,
 257
 Slide-rest, 261, 262
 Slocombe drill, 259, 261
 Slush mould, 221
 Small tools, 249, 253, 258, 261
 Smelting, 157
 Smith's tool-rack, 266
 " tools, 252, 253, 254, 255, 256
 Softness of metal, 152
 Solder decorations, 199
 " tinman's or soft, 156, 227
 Soldering fluid, 227
 " iron, 248, 249
 " metals, 230
 Solidification of metals, 151
 Spanner, double-ended, 250, 251
 Spanner, single-ended, 250, 251
 Spelter, 156
 Spinning, metal, 199
 Splay out, 82
 Square, steel try-, 249, 250
 Squirting, 154
 St. Mark's Cathedral, 10
 Stainless steel, 12, 148, 215
 Stakes, various, 258, 259
 Standards, lamp, 136
 Staple, 63, 64
 Steel, 9
 " burnt, 219
 " carbon tool, 215
 " cast, 12
 " how to distinguish, 219
 " mild, 155
 " nickel, 155
 " non-tempering, 216
 " shear, 219
 " stainless, 215
 " tempering chart, 217
 Steels, heat test, 219
 " spark test, 219
 " warping and cracking, 219
 Stillson wrench, 250, 251
 Stocks and dies, 250, 251, 252
 Stove, tinman's gas, 248, 249
 Stretching hammer, 82
 Striated, 194
 Studs, 90
 Sugar-loaf mandrel, 104
 Surface plate, 258, 259
 Swage, bottom, 253, 254
 Swaging, 66, 67
 Swape, 90, 91
- T
- Tablets, 168, 171
 Tang, 64
 Tantalum 156
 Tap, 116
 Tap wrench, 63, 64, 250, 251
 Taps, various, 251, 252
 Tazza silver gilt, 128
 Tempering of metals, 215, 217
 " scale, 216, 217
 Templet, 76, 78
 Tenacity of metals, 151
 Tenons, 137

Terne plates, 156
 Thebes, 212
 Theodosios, 10
 Theophilus, 10
 Theory of cutting actions, 270
 Thermit welding, 12, 225
 Thomas of Leighton Buzzard, 10
 Tin, 156
 „ plate, 156
 Tinman's gas stove, 248, 249
 „ tools, 257, 258, 260
 Tommy or lever, 63, 64
 Tongs, smith's various, 253, 254, 256,
 257
 Tool racks, 265, 266
 „ steel, 157, 215, 219
 Tools, metalworking, 248, 249, 250,
 251, 252, 253, 254, 255, 256,
 257, 258, 259, 260, 261, 262,
 263
 „ small, 63, 64, 65
 Transfer-paper, 97
 Tripods, 103, 104
 Try-square, 249, 250
 Tubal Cain, 9
 Tudor finger-plate, 88, 89
 Tumeric, 223
 Tungsten, 157
 „ steel, 157
 Turned brass candlesticks, 107, 108,
 109, 110
 „ iron candlesticks, 111, 113,
 113
 „ wood moulds, 79
 „ „ patterns, 105
 „ work, examples, 90, 91
 Turning, 274, 275
 „ brass with a ripper, 94
 „ iron with a graver, 94
 „ notes on, 93
 Twisting, method of, 85
 Type metal, 157

U

Upsetting, 66, 67
 Ur excavations, 7
 Uzziah, 9

V

Vanadium, 157
 Vee block, 92
 Vice clamps, 282
 „ Lancashire hand, 251, 252
 „ method of fixing, 265
 Vinci, Leonardo da, 8
 Vulcan, arms and shield, 8

W

Water-of-Ayr stone, 198-280
 Watt's Steam Engine, 11
 Wedging, 228
 Weight, 148
 Weld, 122
 Welding, various, 225, 226
 Wet methods of extracting metal from
 ore, 158
 Whale-bone, 209
 Whiting, 99
 Wicket gate, 133-7
 Wire gauge, Imperial Standard, 249,
 250
 Wobble, 90
 Wohler, 12
 Wood patterns for vice-clamp moulds,
 281
 Wooley, Mrs., 7
 Working drawings, 167
 Wootz, 8
 Wrenches, various, 250, 251
 Wrought-iron grille, 173
 „ „ pediment for a gate, 173

Y

Yarrenton, Andrew, 11

Z

Zinc, 157
 „ chloride, 227

A Selected List of
BATSFORD BOOKS

relating to

*Architecture, Fine and
Decorative Art, Interior
Decoration, Gardens, Social
History, Crafts, Applied
Science, Engineering, etc.*



Published by B. T. BATSFORD LTD

Booksellers and Publishers by Appointment to H.M. The Queen

15 North Audley Street, Mayfair
London, W.1

CONTENTS

	<i>Page</i>
THE BRITISH HERITAGE, PILGRIMS', FACE OF BRITAIN & NEW CENTURY LIBRARIES	3-5
BOOKS ON ENGLAND	3-11
HISTORIC COSTUME	10
SOCIAL HISTORY	8-13
HISTORIC ARCHITECTURE	14-21
HISTORIES OF ARCHITECTURE	14-17
CLASSIC ARCHITECTURE AND THE ORDERS	14-17
RENAISSANCE ARCHITECTURE	14-17
MEDIÆVAL ARCHITECTURE	14-19
ARCHITECTURAL DRAWING	11, 13
GARDENS	5, 17, 18
CHURCH ART	16-19
MODERN ARCHITECTURE AND DESIGN	19, 21
THE MODERN HOME	21, 22
PERIOD FURNITURE AND DECORATION	19-22
BOOKS FOR COLLECTORS	18-25
FINE AND DECORATIVE ART	20-23
HISTORIC ART	24-26
DESIGN AND ORNAMENT	25-27
MANUALS ON DRAWING, COMPOSITION, ETC.	26-29
ART ANATOMY	28-29
LETTERING	29
ARTS AND CRAFTS	30-31
NEEDLEWORK AND EMBROIDERY	30-31
INDEX	32

NOTE.—This list comprises over 200 books on the subjects shown above from Batsford's main catalogue, in which are listed some 600 odd titles. It is intended to form a representative selection for the use of readers, but those interested in any particular subject should obtain the main catalogue (which will be sent post free on request), that comprises a much wider range of titles under every head. Fully illustrated prospectuses of most books can also be sent on request. Patrons are reminded that Batsford's new premises are at 15 North Audley Street, London, W.1, one minute from Oxford Street, on the main thoroughfare leading to Grosvenor Square, three minutes' walk from either Bond Street or Marble Arch Stations on the Central London Railway; there an immense stock of books, old and new, English and foreign, with prints, pictures, etc., can be inspected at leisure in the large and beautifully-fitted showrooms and gallery. *Telephone Mayfair 6118; Accounts and Production, Mayfair 4337. Cables: Batsfordsa, London. Telegrams: Batsford, Audley, London.*

A full index of the books contained in this list, arranged alphabetically under the names of authors, is given on page 32.

THE BRITISH HERITAGE SERIES

Numerous other volumes in the British Heritage Series are in active preparation or projected, particulars will be gladly placed at the disposal of any interested, together with illustrated prospectuses of any or all of the above volumes, on application to the Publishers.

THE OLD TOWNS OF ENGLAND

By CLIVE ROUSE, F.S.A. A careful and informative Review of their Types and History, Features and Industries, including Cathedral Cities, Spas and Resorts, Market Towns, Scholastic and Church Centres, Sea Ports, etc. Illustrated by some 120 fine photographs of general views and fine public and private buildings, picturesque corners and byways, aerial views, and including sketches, old prints, etc. With coloured Frontispiece by W. SIDNEY CAUSER and decorative jacket in colour by BRIAN COOK. Demy 8vo, cloth, lettered, 7s. 6d. net.

THE ENGLISH CASTLE

By HUGH BRAUN, F.S.A., A.R.I.B.A. An original and thorough review of the origin, evolution and vicissitudes of medieval fortresses, with accounts of military engines, famous sieges, etc. Illustrated by some 125 fine photographs of general and air views, features and details of the outstanding examples in England and Wales. Including also a series of reconstructions, sketches, old manuscripts, pictures, etc., and Foreword by HILAIRE BELLOC. With coloured Frontispiece and decorative jacket in colour by BRIAN COOK. Demy 8vo, cloth, lettered, 7s. 6d. net.

THE SEAS AND SHORES OF ENGLAND

By EDMUND VALE, Author of "Things that are Seen," "The World of Wales," etc. With a Foreword by Sir ARTHUR QUILLER-COUCH ("Q"). A bright, racy account of the varied English and Welsh coastline, its Cliffs and Coves, Estuaries and Ports, Inlets and Harbours, including the Solway, the Irish Sea and St. George's Channel, the Severn Sea, the Atlantic, the English Channel and the North Sea. Illustrated by some 130 fine photographs of coast and sea scenes, etc. With coloured Frontispiece by P. SHEPPARD and decorative coloured jacket by BRIAN COOK. Demy 8vo, cloth, lettered, 7s. 6d. net.

THE SPIRIT OF IRELAND

By LYNN DOYLE, Author of "Ballybullion," and short stories of Irish Life. A bright, witty yet informative review of Dublin, the South East Corner, Grasslands and County Towns, Cork and Kerry, Limerick and Clare, Galway and the North-West, Derry and Antrim, Belfast, etc. Illustrated by 138 superb unpublished Photographs of coast and mountains, islands, rivers, antiquities, cottages, towns, life in fairs, gatherings, sport, etc., forming an unrivalled pictorial survey. With 3 colour pictures by PAUL HENRY and HUMBERT CRAIG, and pen drawings, map and decorative jacket in colour by BRIAN COOK. Second edition. Demy 8vo, cloth, gilt. 7s. 6d. net.

THE ENGLISH COUNTRY HOUSE

By RALPH DUTTON, Author of "English County Homes Open to the Public." An historical and social review, tracing design and evolution from the Conquest to Victorian times, including Interior Decoration and Gardens. Illustrated by 130 fine Photographs, largely taken expressly for the work, by WILL F. TAYLOR, and others, of Medieval, Elizabethan, Stuart, Georgian, Classic and Neo-Gothic examples throughout the country in their charming settings. With coloured Frontispiece by ALGERNON NEWTON. Numerous Plans, End Papers of Old Views, and decorative coloured jacket by BRIAN COOK. Demy 8vo, cloth, lettered. 7s. 6d. net.

THE BRITISH HERITAGE SERIES—(continued)

THE ENGLISH ABBEY: ITS LIFE AND WORK IN THE MIDDLE AGES.

By **FRED H. CROSSLEY, F.S.A.**, author of "English Church Monuments," etc. With a Foreword by the Rt. Hon. W. Ormsby-Gore, P.C., M.P., First Commissioner of Works. An informative yet vivid review of Origins and Orders, the Working Staff of the Convent, the Buildings, Daily Round and Processions, Administration, Building Methods, and Social Reactions. With 138 Illustrations from Photographs by the Author, and others of Interior and Exterior views, features, etc., and sketches by **BRIAN COOK**. Including also List of Abbeys, Map and Plans, 2 coloured plates from contemporary MSS., and 1 by **T. GIRTIN**. With gay coloured jacket by **BRIAN COOK**. Demy 8vo, cloth, lettered, 7s. 6d. net.

THE PARISH CHURCHES OF ENGLAND

By the Rev. **J. C. COX, LL.D.** Edited, with an additional three Chapters, by **CHARLES BRADLEY FORD**, author of "The Landscape of England." With a Foreword by the **VERY REV. W. R. INGE, D.D.**, late Dean of St. Paul's. With Chapters on the Life and Services, the Evolution of Plan, Structural Design, Fittings and Furniture, and Local Varieties of Style. Including 135 fine Photographic Illustrations of Exteriors and Interiors, Features in stone, wood and metal, a special series of Plans and Drawings. With a coloured Frontispiece by **HUGH O'NEILL**, glossary, and gay decorative coloured Wrapper by **BRIAN COOK**. Demy 8vo, cloth, lettered, 7s. 6d. net.

THE CATHEDRALS OF ENGLAND

By **HARRY BATSFORD, Hon. A.R.I.B.A.** and **CHARLES FRY**, with a Foreword by **HUGH WALPOLE**. With a rapid but comprehensive Introduction, followed by a short, clear, description of each cathedral, its situation, history and architecture. Including 133 Illustrations from new photographs, a superb series, far in advance of anything yet produced, a colour Frontispiece from an old drawing by **F. MACKENZIE**, a complete series of uniform Scale Plans, Glossary, and some 30 Line Sketches and gay decorative coloured jacket by **BRIAN COOK**. The book is ideal for the tourist; untechnical but informative, superbly produced and illustrated. Second Edition, revised. Demy 8vo, cloth, lettered. 7s. 6d. net.

ENGLISH VILLAGES AND HAMLETS

By the Hon. **HUMPHREY PAKINGTON, F.R.I.B.A.**, President of the Architectural Association, Author of "How Men Build," etc., with a Foreword by **E. V. KNOX ("Evoc")**, Editor of *Punch*. A popular Pictorial Survey in 130 fine new Photographic Illustrations of unspoilt varied examples from some 30 English counties, in stone, brick, plaster, half-timber and cob, including many full-page unpublished Views, also 4 coloured Plates and 25 Pen Drawings specially made by **SYDNEY R. JONES**, Maps, and gay decorative coloured wrapper by **BRIAN COOK**. Second Edition, with an Historical Introduction by **G. N. YOUNG**. Demy 8vo, cloth, lettered. 7s. 6d. net.

THE SPIRIT OF LONDON

By **PAUL COHEN-PORTEHM**, author of "England the Unknown Isle," "While Time Stood Still," etc., with a Foreword by **RAYMOND MORTIMER**. A series of original and brightly written chapters on Through the Centuries; Streets and their Life; Green London; Amusements and Night Life; Traditional London; and other subjects, with 144 splendid photographic illustrations of many London scenes and life, including a colour Frontispiece by **W. SIDNEY CAUSER**, pictorial endpapers, and gay decorative coloured jacket by **BRIAN COOK**. Demy 8vo, cloth, lettered 7s. 6d. net.

An extremely thorough and well-balanced survey of London as a living entity by one of its greatest cosmopolitan admirers. Indispensable to the Londoner, and invaluable to every provincial and overseas visitor.

THE BRITISH HERITAGE SERIES—(continued)

THE FACE OF SCOTLAND

A Pictorial Review of its Scenery: Hills, Glens, Lochs, Coast, Islands, Moors, etc., with Old Buildings, Castles, Churches, etc. Including a brief review of Topography, History and Characteristics. By HARRY BATSFORD and CHARLES FRY, with a Foreword by JOHN BUCHAN, C.H., M.P. With 130 splendid illustrations, from specially selected Photographs, many hitherto unpublished, a Frontispiece in colour from a Water-colour by W. RUSSELL FLINT, R.A., and numerous Line Drawings in the text and gay decorative coloured Wrapper by BRIAN COOK. Second Edition revised. Demy 8vo, cloth, lettered. 7s. 6d. net.

THE HEART OF SCOTLAND

By GEORGE BLAKE, author of "Shipbuilders," "Rest and Be Thankful," etc., with a Foreword by ERIC LINELATER. A companion and complement to "The Face of Scotland." An able and vigorous account of the Land and its People, including a review of Highland Places, the True Lowlands, Black Country, a Tale of Four Cities, the Kirk and the People, the Fireside Clime, Sport, Institutions, Legends and Realities. Containing some 130 superb Photographic Illustrations of Scenery and Life, Mountains, Cities, Towns, Cottages, Sport, etc. With a coloured Frontispiece by KEITH HENDERSON, numerous Drawings, Map, and a gay decorative coloured wrapper by BRIAN COOK. Demy 8vo, cloth, lettered. 7s. 6d. net.

THE HEART OF ENGLAND

By IVOR BROWN, author of "I Commit to the Flames," "Master Sanguine," "Brown Studies," etc. An able witty Review, written with penetrating and sympathetic insight, on many aspects of present-day Life and Work, including Chapters on Seaport and Seaside; the Downs and the Moors; Country Matters; Markets and Mills; The Suburb; The Week-End; The Young Idea; Recreation. With some 130 new and attractive Photographic Illustrations of many varied types of Country and Town, Life, Work and Play, a coloured Frontispiece by W. SIDNEY CAUSER, and a gay decorative coloured Jacket by BRIAN COOK. Demy 8vo, cloth, lettered. 7s. 6d. net.

THE OLD INNS OF ENGLAND

By A. E. RICHARDSON, F.S.A., with a Foreword by Sir E. LUTYENS, R.A. A comprehensive survey of one of the most attractive features of English life. With a letterpress full of knowledge and robust humour. Illustrated by 130 fine new Photographs of inns, medieval and later, in stone or timber, and in addition pictorial endpapers, and 20 Line Drawings and gay decorative coloured wrapper by BRIAN COOK. An indispensable possession to the tourist. Second impression. Demy 8vo, cloth, lettered. 7s. 6d. net.

THE COUNTRYMAN'S ENGLAND

By DOROTHY HARTLEY, author of "Here's England," "The Old Book," etc. An illustrated sketch of the various types of English country, the people, and their occupations. Arranged under: Mountain and Moorland; Garden and Orchard Country; The Undulating Farmlands; Hill and Downland; Fens and Levels; Coast and Estuaries. With a superb series of about 130 Photographic Illustrations of Scenery, Farmsteads, Fieldwork, Country Crafts and Occupations, etc. Including many miniature Sketches by the author, coloured Frontispiece by JOHN NASH, and gay decorative, coloured jacket by BRIAN COOK. Demy 8vo, cloth, lettered, 7s. 6d. net.

GARDENS IN THE MAKING

By WALTER H. GODFREY. A simple Guide to the Planning of a Garden. With upwards of 70 Illustrations of Plans, Views, and various Garden Accessories. Crown 8vo, cloth. 7s. 6d. net.

THE "FACE OF BRITAIN" SERIES I.

THE HIGHLANDS OF SCOTLAND

By HUGH QUIGLEY, author of "The Trentino and the Tyrol," etc. A graphic account of the Cairngorms, the Lower Grampians, the Far North-West, the West Coast, the Inner and Outer Hebrides and the Glencoe district. Illustrated by some 130 fine photographs of mountains, lochs, seascapes, rivers, glens, woods, etc., by ROBERT M. ADAM. With coloured pastel Frontispiece by W. DOUGLAS McLEOD, Maps, etc., and decorative coloured wrapper by BRIAN COOK. Demy 8vo, cloth, lettered, 7s. 6d. net.

THE "FACE OF BRITAIN" SERIES II

ENGLISH DOWNLAND

By H. J. MASSINGHAM, Author of "Wold Without End," "Downland Man," etc. A comprehensive review of the features, distinctive characteristics, antiquities, villages, etc., of the Chalk Country in England, including the Wiltshire Mass, the Berkshire Ridges, the Chilterns, the North and South Downs, etc. Illustrated by some 130 fine photographs of general views, hill-scenes, panoramas, farms and fieldwork, cottages and churches, barrows, cromlechs, etc. With colour Frontispiece and decorative colour jacket by BRIAN COOK. Demy 8vo, cloth, lettered, 7s. 6d. net.

THE NEW CENTURY ILLUSTRATED LIBRARY, I

MOTOR RACING AND RECORD BREAKING

By the well-known Record-holding Racer, CAPTAIN G. E. EYSTON, Author of "Flat Out," etc., and BARRÉ LYNDON, Author of "Circuit Dust," etc. An historical account of achievements and thrills in many countries, and the influence of racing on car design. With 110 vivid Photographic Illustrations of track and road racing in Europe and America, hill-climbing, risks and personalities, etc. Including a colour Frontispiece by GORDON CROSBY, novel coloured photographic jacket, etc. Demy 8vo, cloth, lettered. 7s. 6d. net.

Other Volumes are in preparation; particulars will be announced later.

THE NEW CENTURY LIBRARY, VOLUME II

THE WAR OF THE GUNS

Experiences of a Battery Signaller on the Climax of the Western Front, 1917-19. By AUBREY WADE. With an Introduction by EDMUND BLUNDEN, Author of "Undertones of War," etc. A graphic and vividly written first-hand account of the last desperate fighting round Ypres, Messines, Passchendaele, the Cambrai front, the German break-through, Villers-Bretonneux, and the final advance. Illustrated by some 120 fine photographs, English and German, of trench fighting, artillery work, etc., forming a unique record in pen and picture of the intensest phase of the Great War. With Maps, coloured Frontispiece by SIR WILLIAM ORPEN, R.A., and decorative jacket by BRIAN COOK. Demy 8vo, cloth, lettered, 7s. 6d. net.

THE ENGLISH AT HOME

A graphic pictorial record from photographs specially taken by BILL BRANDT. With an Introduction by RAYMOND MORTIMER. Comprising 64 full-page photogravure plates of typical scenes and Characters at Work and Play in Town and Country. Including Racing, Betting, Mining, Children rich and poor, Drinking, Bathing, Cricket, Selling, Travelling, City Life, Suburbs, a Garden Party, Teas high and low, Schools, Games, Sport, etc. A remarkable original and fascinating review of the full-flowing stream of life and work in modern England. Crown 4to, decorative boards, cloth back, 5s. net.

*A Revelation in modern publishing, THE PILGRIMS' LIBRARY.
A miniature Pocket Encyclopaedia of National Varied Attractiveness.*

THE BEAUTY OF BRITAIN

A new composite picture of the English, Welsh and Scottish countryside, under 14 divisions by various writers, with an Introduction by J. B. PRIESTLEY. Including the Coast, and Wales, by EDMUND VALE; the West Country by EDMUND BARBER; the Chalk Country by A. G. STREET; the Central Midlands by SIR W. BRACH THOMAS; Scotland, Lowlands and Highlands, by GEORGE BLAKE; and articles by other well-known writers. With 256 pages of Text, 130 splendid Photographic Pictures of the finest and fairest scenes of the country, a Frontispiece in colour by JOHN CONSTABLE, R.A., and a decorative coloured jacket by FRED TAYLOR, R.I. Crown 8vo, cloth, lettered, 5s. net.

THE LEGACY OF ENGLAND

An Illustrated Survey of the Works of Man in the English Country: Farm, Village, Country House, Town, Church, Inn, Sport. With Introduction by EDMUND BLUNDEN and contributions by ADRIAN BELL, C. BRADLEY FORD, G. M. YOUNG, G. A. BIRMINGHAM, IVOR BROWN and BERNARD DARWIN. 256 pages, illustrated by 130 splendid Photographs of fine varied examples from all parts. With colour Frontispiece by J. M. W. TURNER, and decorative jacket in colour. Crown 8vo, cloth, lettered. 5s. net.

NATURE IN BRITAIN

A Pictorial Review of our native wild Fauna and Flora, including Animals, Birds, Fishes and Water Life, Insects, Trees and Shrubs, and Flowers. With Introduction by HENRY WILLIAMSON, and contributions by FRANCE PITT, SETON GORDON, E. G. BOULENGER, C. BUSHBY, R. ST. BARBE BAKER and R. GATHORNE-HARDY. With 120 fine photographs of animal, bird, water insect, plant and tree life, colour frontispiece and decorative colour jacket by BRIAN COOK. Crown 8vo, cloth, lettered, 5s. net.

THE BOOK OF SPEED

With 165 superb Illustrations in photogravure. Including: The Quest of Speed by STEPHEN KING-HALL; The Dawn of Flight by Col. ETHERTON; Speed in the Air by G. DE HAVILAND; "400 Miles an Hour!" by Flight-Lt. G. H. STAINFORTH; Motor Record Breaking by G. E. T. EYTON; "What It Feels Like!" by Sir MALCOM CAMPBELL; Speed-Boats by H. SCOTT-PAINE; Motor-Cycle Racing by JAMES GUTHRIE; Speed by Rail by CECIL J. ALLEN; The Ocean Routes by Sir A. ROSTRON; Speed in Warfare by Maj.-Gen. FULLER; The Non-Stop Run by the Driver of the "Flying Scotsman." Second Edition, revised and enlarged, with a Review of "The Pace in 1935" by BARRE LYNDON, and fresh illustrations. Cr. 4to, cloth, lettered, with new Frontispiece and coloured photographic wrapper. 5s. net.

DINNER BUILDING

A Book of entertaining and practical instruction in the Noble Arts of Cooking and Eating. Written by W. THIGNMOUTH SHORR. With an Introduction by GILBERT FRANKAU. A series of 42 bright, stimulating but practical Talks on such subjects as The Perfect Dinner, Sandwichery, Remnant Days, Cabbages and Things, incorporating hundreds of fresh recipes of all kinds. Cheaper reissue. Fcap 8vo, cloth, lettered. 2s. net.

ROUND THE WORLD IN FOLK TALES

A Regional Treatment. By RACHEL M. FLEMING. 16 Tales from Iceland, Mexico, Africa, Australia, etc., told in a fresh, easy style. With 17 Illustrations from Prints, Drawings, and Photographs. 8vo, boards, 2s. net. Cloth, 3s. net.

A fine series of exceptional Colour Records: BATSFORD'S "ART AND LIFE IN COLOUR" LIBRARY

In two sizes: (I) Quarto, (II) Small Folio. (I) comprises TROPICAL BUTTERFLIES; RARE SHELLS; THE YEAR'S WORK AND PLAY; IN MASTERPIECES OF FLEMISH ILLUMINATION; to be followed by TYPICAL MINERALS and ALPINE FLOWERS. Each contains 12 superb facsimile colour plates, reproduced regardless of expense, forming veritable works of art. With brief Introduction and text. Stiff covers, 5s. 6d. per volume.

II. PAINTING OF THE FAR EAST, chiefly Chinese, with some Japanese examples; TROPICAL FISHES and MARINE GROWTHS; the LANDSCAPES OF SWITZERLAND from views of a century ago. With brief introduction and text. Stiff covers 7s. 6d. net per volume.

These two sister series constitute an endeavour to represent some of the finest works of Nature and Art by the highest achievements of modern reproductive processes. No trouble or cost has been stinted to obtain most artistic facsimile results, which will appeal to all for their beauty and intrinsic interest. Copies in portfolio can be supplied for framing if wished. The introductions on BUTTERFLIES, SHELLS and FISHES are by Professor JULIAN HUXLEY, F.S.A. of the London Zoo; that of the volume on ILLUMINATION by Mr. FRANCIS KELLY, the writer on costume; and to the volume on PAINTING OF THE FAR EAST by Mr. LAURENCE BINYON, late Keeper of Prints at the British Museum, the well-known authority on Oriental Art.

A NEW VOLUME IN THE "ENGLISH LIFE" SERIES
THE MEDIEVAL STYLES OF THE ENGLISH PARISH CHURCH

By F. E. HOWARD, joint author of "English Church Woodwork," etc. A careful and informative account of the Evolution of Design, Features and Detail from early pre-Conquest days to the sixteenth century, including chapters on each Transitional Phase and on Methods of Studying a Parish Church. With some 160 illustrations from photographs of exterior and interior views, arcades, capitals, towers and spires, doorways, windows, carving, etc. With plans, mouldings, and decorative jacket. Large 8vo, cloth, lettered, 12s. 6d. net.

THE "ENGLISH LIFE" SERIES
THE ENGLISH COUNTRYSIDE

By ERNEST C. PULBROOK. A Review of some of its Aspects, Features, and Attractions. With 126 Illustrations from Photographs, and a Pencil Frontispiece by A. E. NEWCOMBE. New and cheaper impression. Large 8vo, cloth, gilt. 10s. 6d. net.

ENGLISH COUNTRY LIFE AND WORK

An Account of some Past Aspects and Present Features. By ERNEST C. PULBROOK. Containing about 200 pages on Farmers, Old and New—Field-Work—Cottage Folk—The Village Craftsman—Religious Life, etc. With about 200 artistic Illustrations from special Photographs. A New and cheaper reissue. Large 8vo, cloth, gilt. 12s. 6d. net.

OLD ENGLISH HOUSEHOLD LIFE

Some Account of Cottage Objects and Country Folk. By GERTRUDE JEKYLL. Consisting of 17 sections on the Fireplace, Candlelight, the Hearth, the Kitchen, Old Furniture, Home Industries, Cottage Buildings, Itinerants, Mills, Churchyards, etc. With 277 Illustrations from Photographs and Old Prints and Drawings. New and cheaper reissue. Large thick 8vo, cloth, gilt. 12s. 6d. net.

An appealing novel series at cheap price:

BATSFORD'S PICTORIAL GUIDES TO HISTORIC CITIES OF NORTHERN EUROPE.

I. STOCKHOLM. II. COPENHAGEN. III. AMSTERDAM. IV.
HAMBURG.

Their Layout, Highways, Byways and Waterways, Distinctive Buildings, Life, Work and Play, presented in a series of some 100 attractive modern photographs, full-page and smaller, specially taken by Geoffrey Gilbert. With brief Introduction, Tourist Information and full informative captions. Square 8vo, in decorative two-colour stiff covers specially designed by E. McKnight Kauffer. 2s. 6d net per volume.

THE GOOD NEW DAYS

Things that Boys and Girls Should Know. By MARJORIE and C. H. B. QUENNELL, Authors of "Everyday Things in England," "The Everyday Life" Series, etc. Demy 8vo, with coloured jacket. 6s. net.

A Series of bright informative talks about the fundamental factors of English Citizenship, present-day conditions and problems, and including comparisons with the past, in Agriculture, Towns and Suburbs, Trade and Finance, Production, Legislation, Leisure, Taxation, National Debt and Imprisonment, Armaments, etc., With historical summaries Illustrated by numerous plans, diagrams, reproductions of old prints and up-to-date photographs, showing comparatively, power machines, farming, old villages, steamships, slums and ultra-modern flats, recent developments of social life, etc.

A striking and original book, which in an informal way provides a course in Civics, and will be found of remarkable value to all interested in the past and future of their own country.

"ESSENTIALS OF LIFE" SERIES

By Lieut -Colonel F S. BRERETON, C.B.E. Bright, informative reviews of the Indispensable Things of Human Life. Each with 80 pages of text, and about 100 Illustrations in Line and Half-tone from Photographs, Drawings, Old Prints, etc., of Old and Modern Developments. Large crown 8vo, cloth, lettered. Cheaper reissue. 2s. 6d. net each.

CLOTHING: An Account of its Types and Manufacture. Contents: Materials—Spinning—Weaving—The Sewing Machine—A Morden Factory—Furs and Rubber—Leather and Tanning—Boots—Hats—Glove-making—Dyeing and Cleaning—Pins—Needles—Buttons, etc.

TRAVEL: An Account of its Methods in Past and Present. Contents: Early Roads and Trading Routes—Coaching—The Steam Engine—Steamships and Railways—The Bicycle—The Petrol Engine—Air Travel—Postman—Wire or Wireless. With Illustrations of Coaches, Engines, Balloons, Aircraft, Ships, Steamers, etc.

THE XVIIITH CENTURY IN LONDON

An Account of its Social Life and Arts By E. BERESFORD CHANCELLOR. Containing 280 pages, with 192 Illustrations, printed in sepia, from Prints and Drawings by Contemporary artists. With a Frontispiece in colour. Cheaper reissue. Crown 4to, cloth, gilt. 15s. net.

A Companion and Sequel to the above

LIFE IN REGENCY AND EARLY VICTORIAN TIMES

An Account of Social Life in the days of Brummel and D'Orsay By E. BERESFORD CHANCELLOR. A Series of Chapters on the time of Brummel and D'Orsay, 1800-1843. With numerous Illustrations from Rare Prints and Original Drawings. Cheaper reissue. Large 8vo, cloth, gilt 12s. 6d. net.

THE "PEOPLE'S LIFE AND WORK" SERIES

LIFE AND WORK OF THE ENGLISH PEOPLE THROUGH THE CENTURIES

A Pictorial Record from Contemporary Sources. By DOROTHY HARTLEY and MARGARET M. ELLIOT, B.A. (Lond.). Each volume is devoted to a century and contains about 150 pictures on 48 Plates, of Household Life, Industries, Building, Farming, Warfare, Transport, Children, Church Life, Gardens, etc. With an Introduction, Descriptive Notes, Chart, Analytical Index, Music, etc. Large (royal) 8vo, boards, lettered, or in portfolio with flaps, 3s. net, or in cloth, 3s. 6d. net per volume. Volumes I and II (Early Middle Ages), III and IV (Later Middle Ages), and V and VI (Renaissance) are also together in cloth, 6s. net each, and volumes I, II and III (Middle Ages), and IV, V and VI (Renaissance) are also in cloth at 9s. net each. A few copies of volumes II and III (Later Middle Ages), and volumes IV and V (Early and Middle Renaissance), can also be obtained together in cloth at 5s. net each.

The Series has now been completed as follows:

- | | |
|----------------------------|----------------------------|
| I. SAXON TIMES TO 1300 | IV. THE SIXTEENTH CENTURY |
| II. THE FOURTEENTH CENTURY | V. THE SEVENTEENTH CENTURY |
| III. THE FIFTEENTH CENTURY | VI. THE EIGHTEENTH CENTURY |

MEDIEVAL COSTUME AND LIFE

An Historic and Practical Review. By DOROTHY HARTLEY. Containing 22 full-page Plates from Photographs of living Male and Female Figures in specially made Costumes from Medieval MSS., 20 Plates in Line from the Author's Drawings of practical Construction, Detail, Sketches, etc., and 40 Plates of some 200 Reproductions from Contemporary Manuscripts of scenes of Medieval life and work. Including full historical and descriptive text, with directions for the practical cutting out and making of many costumes illustrated. Large royal 8vo, cloth. 12s. net.

A SHORT HISTORY OF COSTUME AND ARMOUR, CHIEFLY IN ENGLAND, 1066-1800

By F. M. KELLY and RANDOLPH SCHWABE, Principal of the Slade School of Fine Art. Royal 8vo, cloth, gilt. 25s. net. Or in 2 volumes:

I. THE MIDDLE AGES, 1066-1485. With Sections on Civilian Dress, "Shirts," "Shapes," Houppelandes and Burgundian Modes Armour, Illustrated by 4 Plates in colours and gold, over 100 special Pen Drawings by RANDOLPH SCHWABE from original sources and 32 Photographic Plates of over 70 reproductions. Royal 8vo, cloth, gilt. 13s. net.

II. THE RENAISSANCE, 1485-1800. With Sections on Puff and Slashes, The Spanish Trend, "Cavalier" and French Modes, the Heyday and Decline of Powder, Armour, etc. Illustrated by 5 Plates (3 double) in colours and gold, over 100 special Pen Drawings by RANDOLPH SCHWABE from original sources, 36 Photographic Plates of 58 Reproductions. Royal 8vo, cloth, gilt. 13s. net.

HISTORICAL COSTUME

A Chronicle of Fashion in Western Europe, 1490-1790. By FRANCIS M. KELLY and RANDOLPH SCHWABE. Containing the chief characteristics of Dress in each century. Illustrated by some hundreds of full-page and text Sketches from original sources by RANDOLPH SCHWABE of typical groups, figures and details. Including 7 Plates specially reproduced in colour, and 70 Photographic reproductions of Pictures, Portraits, Scenes, etc. Second Edition revised and enlarged. Large royal 8vo, cloth, gilt, 25s. net.

The Quennell Series of Books on Social Life and History

In their volume the authors have approached history from a new angle and in the process have revolutionised the teaching of it. In their hands it has become a live, vivid and picturesque subject, for they have breathed new life into old bones. Their methods are now widely and generally recognised and appreciated."—*Western Mail*.

A HISTORY OF EVERYDAY THINGS IN ENGLAND, 1066-1934

Written and Illustrated by MARJORIE and C. H. B. QUENNEL. In Four Volumes. Medium 8vo, 8s. 6d. net each; also Vols. I and II, and III and IV, issued each pair bound in one volume, 16s. 6d. net.

VOL. I—EVERYDAY THINGS IN ENGLAND, 1066-1499
With 90 Illustrations, many full-page, and 3 Plates in colour. Second Edition, revised and enlarged, with additional illustrations.

VOL. II—EVERYDAY THINGS IN ENGLAND, 1500-1799
By MARJORIE and C. H. B. QUENNEL. With 4 Coloured Plates and 111 other Illustrations from the Author's Drawings. Second Edition, revised and enlarged, with additional Illustrations.

Issued in Parts for Schools and Class Teaching. Stiff paper covers. 3s. net each.

PART I. ENGLAND UNDER FOREIGN KINGS (1066-1199). Containing 2 Colour Plates, 5 full-page line Illustrations, and 15 in the text.

PART II. THE RISE OF PARLIAMENT (1200-1599). Containing 2 Colour Plates, 8 full-page Illustrations, and 22 in the text.

PART III. THE HUNDRED YEARS' WAR (1400-1499). Containing 1 Colour Plate, 11 full-page line Illustrations, and 13 in the text.

PART IV. THE AGE OF ADVENTURE (1500-1599). Containing 2 Colour Plates, 16 full-page line Illustrations, and 30 in the text.

PART V. THE CROWN'S BID FOR POWER (1600-1699). Containing 1 Colour Plate, 11 full-page line Illustrations, and 21 in the text.

PART VI. THE RISE OF MODERN ENGLAND (1700-1799). Containing 1 Colour Plate, 11 full-page line Illustrations, and 19 in text.

VOL. III—EVERYDAY THINGS IN ENGLAND, 1733-1851

THE COMING OF THE INDUSTRIAL ERA. An Account of the Transition from Traditional to Modern Life and Civilization. Written and Illustrated by MARJORIE and C. H. B. QUENNEL. Tracing the Transformation of Agriculture, the coming of Steam Power, the application of Inventions, Trends in Social Life in Town and Country, Costume, Building, etc. Illustrated by 4 Coloured Plates, 120 full-page and smaller Drawings specially prepared by the Authors, and a series of Reproductions of contemporary Engravings and Drawings. Medium 8vo, art cloth, 8s. 6d. net.

VOL. IV.—EVERYDAY THINGS IN ENGLAND, 1852-1934

THE AGE OF PRODUCTION. An Account of Modern Life and Civilisation. Written and Illustrated by MARJORIE and C. H. B. QUENNEL. Treating of old and new methods regarding the Farmer and Food, Buildings, Town Planning, Slums, Schools, Furniture, Production and Distribution, Public Health, Transport, Social Life in Clothes, etc. Illustrated by 4 single and 3 double Plates in colour, 120 full-page and smaller Drawings specially prepared by the authors, and numerous Plates from Photographs and contemporary Prints. Medium 8vo, art cloth, 8s. 6d. net.

ARCHITECTURAL DRAWING

By G. GORDON HAKE, F.R.I.B.A., and E. H. BURTON, Architects. An Introductory Treatise for Architects and Students on work of every type and in every medium. With 96 pages, 16 pages of Half-tone Illustrations and 90 Line Illustrations. Cheaper reissue. 8vo, cloth, 7s. 6d. net.

THE QUENNELLS EVERYDAY LIFE SERIES

A Graphic and Popular Survey of the Efforts and Progress of the Human Race, now completed in 4 volumes. Crown 8vo, cloth. 5s. net each.

EVERYDAY LIFE IN THE OLD STONE AGE

Written and Illustrated by MARJORIE and C. H. B. QUENNELLS. Containing 128 pages, including 70 Illustrations, and a coloured Frontispiece, from the Authors' Drawings, with a Chronological Chart. Second Edition, revised.

EVERYDAY LIFE IN THE NEW STONE, BRONZE AND EARLY IRON AGES

Written and Illustrated by MARJORIE and C. H. B. QUENNELLS. Containing 144 pages, with 90 original Illustrations from the Authors' Drawings, of Household Life, Agriculture, Pottery, Weapons, Ornaments, etc., including 2 Plates in colour, a marked Map, and a Chronological Chart. Second Edition, revised.

The above two works may now be obtained bound in one handy volume as follows:

EVERYDAY LIFE IN PREHISTORIC TIMES

Containing 272 pages, 3 Plates in colour and 2 in monochrome, with 160 Illustrations from the Authors' Pen-and-Ink Drawings, two Chronological Charts and a Comparative Map. The Old Stone Age Section has an account of the Rhodesian Skull and Nebraskan Tooth, with 2 additional Illustrations. Crown 8vo, cloth, lettered. 10s. net.

EVERYDAY LIFE IN ROMAN BRITAIN

Written and Illustrated by MARJORIE and C. H. B. QUENNELLS. Containing 128 pages, with over 100 original Illustrations from the Authors' Pen Drawings, of Cities and Camps, Villas, Ships, Chariots, Monuments, Costume, Military Life, Household Objects, Pottery, etc. Including 3 Colour Plates, Chart, and Map of Roads. Second edition, revised and enlarged.

EVERYDAY LIFE IN SAXON, VIKING & NORMAN TIMES

Written and Illustrated by MARJORIE and C. H. B. QUENNELLS. Containing 128 pages, with over 100 original Illustrations from the Authors' Pen and Pencil Drawings of Ships, Cooking, Metalwork, Caskets, Crosses, Buildings, Pottery, and Illuminated MSS., including 2 coloured Plates, Historical Chart, etc. Crown 8vo, cloth. 5s. net.

ENGLAND IN TUDOR TIMES

An Account of its Social Life and Industries. By L. F. SALZMAN, M.A. F.S.A., Author of "English Industries of the Middle Ages," etc. A remarkable survey of a great period in England's Social history. Containing chapters on The Spirit of the Tudor Age—Life in the Country—Life in the Town—Life in the Home—The Church—Adventure on Land and Sea. With 138 pages of text, 64 full-page Illustrations and plentiful illustrations in the text from Drawings, Engravings, etc. Cheaper reissue. Demy 8vo, cloth. 5s. net.

TOURING LONDON

By W. TEIGNMOUTH SHORE, Author of "Dinner Building," etc. With an Introduction by the Rt. Hon. John Burns, P.C. A Series of 4 Tours, covering the chief parts of Inner London, written in a bright and pleasant style, but conveying much practical and historical information. Illustrated by 28 Photographs, with Drawings and Sketches in the text by well-known artists. Also a two-colour Map of the City, and Plans. Cheaper reissue. Large crown 8vo, cloth. 2s. 6d. net.

*A New Fascinating Series of Classical Social Life. Uniform with the Authors
"Everyday Things in England"*

"The Quennell books are likely to outlast some of the most imposing institutions of the post-war world. A book which is written with great scholarship and surprising lucidity. To speak in superlatives of this series is only justice, for seldom is there found such a unity between publisher, author, and illustrator as the Batsford books display"—*G.K.'s Weekly*.

**EVERYDAY THINGS IN ANCIENT GREECE (HOMERIC
—ARCHAIC—CLASSICAL)**

An "Omnibus" Volume of the three following works. Written and Illustrated by MARJORIE and C. H. B. QUENNEL. A full review of Social Life and the Arts. Containing 3 coloured Plates, some 238 full-page and smaller Illustrations from Drawings in Pen-and-Ink, Pencil, and Wash and 20 from Photographs. Large thick 8vo. 21s. net.

VOL. I. EVERYDAY THINGS IN HOMERIC GREECE

Written and Illustrated by MARJORIE and C. H. B. QUENNEL. Presenting a vivid picture based on the Social Life in the *Iliad* and *Odyssey*, etc. Illustrated by 70 Drawings by the Authors, after Vase Paintings and their own restorations. With Colour Frontispiece, Photographic Illustrations, Map, etc. Large 8vo, decoratively bound. 7s. 6d. net.

VOL. II. EVERYDAY THINGS IN ARCHAIC GREECE

Written and Illustrated by MARJORIE and C. H. B. QUENNEL. An Account of Social Life from the close of the Trojan War to the Persian Struggle. Illustrated by 85 full-page and smaller Drawings by the Authors. With a coloured Frontispiece, a number of Photographic Illustrations, Map, etc. Large 8vo, decoratively bound, cloth, lettered. 7s. 6d. net.

VOL. III. EVERYDAY THINGS IN CLASSICAL GREECE

Written and Illustrated by MARJORIE and C. H. B. QUENNEL. A vivid picture of Social Life in the Golden Age of Pericles, Socrates, Phidias, and Plato, 480-404 B.C. With Sections on Architecture; the Town and its Planning; Everyday Life; Sea Fights and Land Battles, etc. Illustrated by 83 Drawings specially made by the Authors. With coloured Frontispiece, Photographic Illustrations, Chart, Map, etc. Large 8vo, cloth, lettered. 8s. net.

If ordered at one time the three volumes of this series are priced at 22s. net.

**ARCHITECTURAL DRAWING, PERSPECTIVE AND
RENDERING**

By CYRIL A. FAREY, A.R.I.B.A., and A. TRYSTAN EDWARDS, A.R.I.B.A. Containing accounts of Measured Work, Colouring, Sketching, Methods of Technique, Shading, Competition Drawings, Publicity and Posters, etc. Including a specially prepared Perspective in various stages by C. A. FAREY and Drawings by William Walcot, R.A., F. Brangwyn, R.A., W. Curtis Green, R.A., P. D. Hepworth, J. D. M. Harvey, and other well-known draughtsmen. With 43 Plates in half-tone, 9 in colour, 31 Line Reproductions, and 196 pages of Text. Cr. 4to, cloth. 16s. net.

SPEED ON SALT

By GEORGE EYSTON and W. F. BRADLEY. With a Foreword by SIR MALCOLM CAMPBELL. A graphic first-hand review of their pioneer record-breaking motor-runs on the Bonneville Salt Flats, Utah, U.S.A., including the world's land speed record of 300 m.p.h., and the world's 24-hour record. Describing also the strange wild romance of the surroundings and the desert village of Wardmer, etc. With 132 attractive illustrations from special photographs of machines and men. Frontispiece in colour and coloured decorative jacket by BRIAN COOK. Quarto, cloth, lettered, 5s. net.

A SHORT CRITICAL HISTORY OF ARCHITECTURE

By H. HEATHCOTE STATHAM, F.R.I.B.A. Second Edition, revised and enlarged by G. MAXWELL AYLWIN, F.R.I.B.A. Containing 600 pages and 750 Illustrations from Photographs, Drawings, Plans, Prints, etc., with Chronological Charts and Glossary. Demy 8vo, cloth, gilt. 16s. net.

Also supplied in 3 parts, cloth, gilt. 6s. net each.

- I. ARCHITECTURE OF ANTIQUITY AND THE CLASSIC AGES
- II. BYZANTINE, ROMANESQUE AND SARACENIC STYLES
- III. THE MIDDLE AGES AND THE RENAISSANCE TO MODERN TIMES

Each part contains about 200 pages, with 250 full-page and smaller Illustrations, and is complete with Prefaces, Charts, Glossary and Indexes.

"Within the limits of its size and price it is the most valuable handbook that has appeared in English for those who wish to understand the architecture of the past."
—*The Architect.*

THE STORY OF ARCHITECTURE

From the Earliest Ages to the Present Day. By P. LESLEY WATERHOUSE, F.R.I.B.A. With numerous Illustrations of the great buildings of all time from Photographs and Drawings, and many Diagrams in the text. F'cap 8vo, boards, lettered. 6s. net.

THE STORY OF ARCHITECTURE IN ENGLAND

By WALTER H. GODFREY, F.S.A., F.R.I.B.A. A popular illustrated account, in which the aims and methods of Architectural Design are simply explained, and linked up with the social life of the time. In Two Parts: I. Early and Medieval, to 1500, chiefly Churches; II. Renaissance, 1500-1800, chiefly Houses. Demy 8vo, cloth. 6s. 6d. net per part; or the two volumes bound in one, 12s. 6d. net.

I. PRE-REFORMATION, THE PERIOD OF CHURCH BUILDING
Illustrated by 133 full-page and smaller Photographs and Drawings. Large crown 8vo, cloth. 6s. 6d. net.

II. RENAISSANCE, THE PERIOD OF HOUSE BUILDING
Illustrated by 150 full-page and smaller Photographs and Drawings. Large crown 8vo, cloth, 6s. 6d. net.

NEW EDITION, REVISED AND ENLARGED, NOW READY OF
THIS GREAT STANDARD WORK

THE DOMESTIC ARCHITECTURE OF ENGLAND DURING THE TUDOR PERIOD

Illustrated in a Series of Photographs and Measured Drawings of Country Houses, Manor Houses and Other Buildings. By THOMAS GARNER and ARTHUR STRATTON, F.R.I.B.A. Second Edition, Revised and Enlarged, comprising 210 Plates, mostly full-page, finely reproduced in Collotype, and 250 pages of Historical and Descriptive Text, including 462 Illustrations of Additional Views, Plans, Details, etc., from photographs and drawings, making a total of over 800 Illustrations in all. In two volumes, small folio, buckram, gilt. £9 9s. net the set. (The volumes cannot be obtained separately *but can be purchased by instalments.*)

ANCIENT ARCHITECTURE, PREHISTORIC, EGYPTIAN, WEST ASIAN, GREEK AND ROMAN

A Chronicle in Verse, by H. CHESTER JONES, M.A., F.S.A. Comprising also an outline history of Architecture, brief Prose Introductions to each Section, and a full Glossary of Terms, etc. Illustrated by numerous large Charts and Compositions, and many Drawings and Plans of Buildings by the Author. Including a photogravure portrait and appreciative Forewords by Sir EDWIN LUTYENS, R.A., Dr. HADEN GUEST, M.P., and others. Large 8vo, cloth, gilt. 15s. net.

BATSFORD'S "HISTORICAL ARCHITECTURE LIBRARY"
of Standard Textbooks on Classic and Renaissance Architecture

BYZANTINE ARCHITECTURE AND DECORATION

By J. ARNOTT HAMILTON, M.A., author of "The Churches of Palermo," etc. A careful, scholarly and thorough account of the development and character of constructional methods and decoration, and types of extant buildings in Constantinople, Greece, the Balkans, Cyprus, Armenia, Italy, etc. With coloured Frontispiece and 120 Photographic Illustrations of exteriors and interiors, Reconstructions, Constructional Diagrams, Carving, Details, etc., and numerous Line Plans, Measured Drawings, and Sketches in the text. Medium 8vo, cloth, gilt. 18s. net.

ANDERSON AND SPIERS' "ARCHITECTURE OF GREECE AND ROME"

Now reissued in two volumes, obtainable separately, revised and much enlarged. Small Royal 8vo, cloth, gilt. 21s. net each volume, or £2 the two.
I. ARCHITECTURE OF ANCIENT GREECE. Rewritten, remodelled and much enlarged by WILLIAM BELL DINSMOOR, Professor of Architecture at Columbia University, New York, and the American Academy at Athens. With over 200 Illustrations in Collotype, half-tone and line.
II. ARCHITECTURE OF ANCIENT ROME. Revised and rewritten by THOMAS ASHBY, LL.D., Late Director of the British School at Rome. With about 200 Illustrations in half-tone and line.

ARCHITECTURE OF THE RENAISSANCE IN ITALY

By WILLIAM J. ANDERSON, A.R.I.B.A. Revised and Enlarged, with an additional Chapter on Baroque and later work, by ARTHUR STRATTON, F.S.A., F.R.I.B.A. With 80 Plates, including 16 in Collotype, and 120 Illustrations in the text. Small Royal 8vo, cloth, gilt. 21s. net.

ARCHITECTURE OF THE RENAISSANCE IN FRANCE

By W. H. WARD, M.A., F.R.I.B.A. Revised and Enlarged by Sir JOHN W. SIMPSON, K.B.E., PP.R.I.B.A. In two volumes, obtainable separately. Small Royal 8vo, cloth, gilt. 21s. net, each volume, or £2 for the two.
IV. THE EARLY RENAISSANCE (1495-1640). With 259 Illustrations.
V. THE LATER RENAISSANCE (1640-1830). With 214 Illustrations.

DESIGN AND MEDIEVAL ARCHITECTURE

By HELEN ROSENAU, Ph.D., Hamburg. A study of Orientation, Planning and Design. The medieval architect and his design. With 17 Illustrations from Photographs of contemporary architectural drawings and designs, Interiors and details of cathedrals, etc., in Europe and England. A concise and able thesis incorporating the results of much close research. Large 8vo, paper covers. 2s. 6d. net.

THE SMALLER ENGLISH HOUSE FROM THE RESTORATION TO THE VICTORIAN ERA, 1660-1840

By A. E. RICHARDSON, F.S.A., F.R.I.B.A., and HAROLD DONALDSON EBERLEIN, B.A. Treating of the Characteristics and Periods of Style; the Evolution of Plan; Materials and Craftsmanship: Roofing, Windows, Ironwork, Fireplaces, Staircases, Wall Treatment, Ceilings. With over 200 Illustrations, many full-page, from Photographs and Drawings. Demy 4to, cloth, gilt. Cheaper reissue, 15s. net.

A NEW AND IMPORTANT SERIES OF SCHOOL WALL CHARTS

In Two Series now ready, consisting of 25 large lithographed Plates, 30cm. by 20cm. Price, Complete 25s. net on stout paper; or £3 2s. od. net mounted on linen, with bound edges. Single diagrams, 1s. 4d. net each; or mounted, 2s. 10d. net each. Introductory Handbook to each Series, 1s. 6d. net each, stiff paper covers, 2s. 6d. net each, cloth, lettered.

THE STYLES OF ENGLISH ARCHITECTURE

A SERIES OF COMPARATIVE WALL OR LECTURE DIAGRAMS. For Schools, Teachers, Students, etc. By ARTHUR STRATTON, F.S.A., F.R.I.B.A. Series I: THE MIDDLE AGES (Saxon Times to the Start of the Tudor Period). Consisting of 13 large double crown Plates, 20in. by 30in. clearly lithographed from the Author's specially prepared Drawings. 13s. net paper, 32s. net mounted.

Series II: THE RENAISSANCE (Tudor, Elizabethan, Stuart, and Georgian Periods). Comprising 12 large diagrams, as in Series I. 12s. net paper, 30s. net mounted.

The 32 pp. Introductory Handbooks contain reduced reproductions of all the Plates with all their sources, and an outline account of each style with numerous further Illustrations. The first Handbook on the Middle Ages is in its second edition, revised, with additional illustrations. Paper covers 1s. 6d. net; cloth 2s. 6d. net each.

ELEMENTS OF FORM AND DESIGN IN CLASSIC ARCHITECTURE

Shown in Exterior and Interior Motives collated from Fine Buildings of all Times. By ARTHUR STRATTON, F.S.A., F.R.I.B.A. Presenting in 80 full-page Plates about 600 motives of Façades, Loggias, Halls, Staircases, etc. Including a Series of 16 Plates of Classic and Renaissance Composition and Designs. With Introduction, Analytical Account to each Section. Descriptive Notes, and Foreword by Prof. A. E. RICHARDSON, F.S.A., F.R.I.B.A. 4to, cloth, gilt, 28s. net.

THE ORDERS OF ARCHITECTURE

GREEK, ROMAN, and RENAISSANCE; with EXAMPLES of their historic APPLICATION in ITALIAN, FRENCH, ENGLISH, and AMERICAN COLONIAL. By ARTHUR STRATTON, F.S.A. With an Introduction by A. TRYSTAN EDWARDS, A.R.I.B.A. Illustrated in a Series of 80 full-page Plates from Drawings, mostly specially prepared, including a complete series of Vignola's Orders, and rendered examples of French, Italian, and English buildings. With full historical and practical notes and numerous Text Illustrations. 4to, cloth, gilt, or in portfolio, 21s. net; or in 3 parts: CLASSIC, ITALIAN and APPLICATIONS, cloth 8s. net each.

ENGLISH GOTHIC CHURCHES

THE STORY OF THEIR ARCHITECTURE. By CHARLES W. BUDDEN, M.A. A simple informative account of the Planning, Design, and Details of Parish Churches, Cathedrals, etc., 1066-1500, including Chapters on Local Building, Towers, Spires, Ornaments, etc. Illustrated by 53 Plans and Line Diagrams, and 40 Photographic Plates of 80 Views and Details, including a County List of the chief Churches worth seeing. Crown 8vo, cloth, cheaper reissue, 5s. net.

LITTLE KNOWN TOWNS OF SPAIN

A series of Water-colours and Drawings in facsimile colour and monochrome from the originals of VERNON HOWE BAILEY. Comprising 57 full-page Plates, many in colour, others in sepia, wash, lithography, etc., with text, including historical and descriptive short notes. Large 4to, in decorative paper binding, £1 10s. net.

CHILDREN'S TOYS OF BYGONE DAYS

A History of Playthings of all Peoples from Prehistoric Times to the XIXth Century. By KARL GRÖBER. English Version by PHILIP HERFORD. A beautifully produced survey, with a Frontispiece and 11 Plates in colour, and 306 photographic illustrations of Dolls, Dolls-houses, Mechanical Toys, Carts, Ships, Tin Soldiers, etc., etc., of every country and period from the earliest times. With 66 pages of historical and descriptive text. 4to, canvas, gilt, with decorative wrapper. New and cheaper edition, 12s. 6d. net.

RENAISSANCE PALACES OF NORTHERN ITALY

(With some Buildings of Earlier Periods). From the XIIIth to the XVIIth Centuries. Edited by PROFESSOR DR. ALBRECHT HAUPT, in 3 vols., each containing 160 full-page Plates in Collotype from specially taken Photographs or Measured Drawings. With full text. Vol. I, TUSCANY, FLORENCE, PISA, SIENA, MONTEPULCIANO, LUCCA, PISTOIA, etc.; Vol. II, VENICE, including also VERONA, MANTUA, VICENZA, and PADUA; Vol. III, GENOA, including also BOLOGNA, FERRARA, MODENA, MILAN, TURIN, PAVIA, BERGAMO, BRESCIA, etc. Small folio, cloth, lettered, £2 15s. net each volume, or the set of 3 for £7 10s. net.

THE ARCHITECTURAL WORK OF SIR BANISTER FLETCHER, M.Arch., P.P.R.I.B.A., F.S.A.

A Monograph Edited with Introductory and Descriptive Text, including a short Account of his Life and Activities, by W. HANNEFORD SMITH, Hon. A.R.I.B.A., F.R.S.E., Assoc. Inst. C.E. With numerous Plates of Sketches and Drawings of Historic Buildings at home and abroad, together with Photographs and Drawings of Town and Country Houses, Banks, Business Premises, Schools, Town Halls, Memorials, Gates, Furniture, etc., designed by the author. Quarto, cloth, fully gilt, gilt top. £2 2s. net. Edition limited to 500 copies, of which 400 are for sale.

A HISTORY OF ARCHITECTURE ON THE COMPARATIVE METHOD

For the Student, Craftsman, and Amateur. By Sir BANISTER FLETCHER, P.P.R.I.B.A. Ninth Edition, completely rewritten. Containing over 1,000 pages, with about 3,500 Illustrations (1,560 recently added and nearly 2,000 reproduced larger for this Edition), from Photographs and Drawings of Buildings of all Countries and Times. Royal 8vo, cloth, gilt. £2 2s. net.

THE OLD HALLS AND MANOR HOUSES OF NORTH-AMPTONSHIRE

By J. ALFRED GOTCH, M.A., F.S.A., F.R.I.B.A., Author of "The Growth of the English Houses," and numerous other standard works. With full Historical Introduction and Descriptive text, and 100 Plates of some 150 Illustrations from photographs, largely specially taken, and from original drawings and old prints, comprising Interior and Exterior Views, Features, Details and Gardens. Including also numerous plans and sketches in the text. Crown 4to, cloth, lettered. Strictly limited edition offered before publication to subscribers, 21s. net.

THE ART AND CRAFT OF GARDEN MAKING

By THOMAS H. MAWSON, assisted by E. PRENTICE MAWSON, Fifth Edition, Revised and Enlarged. Containing 440 pages, illustrated by 544 Plans, Sketches and Photographs, and 5 colour Plates. Including Site, Entrances, Gates, Avenues, Terraces, Beds, Pergolas, Treillage, Rock and Water, Greenhouses, etc., etc., and list of Shrubs and Trees. Small folio, buckram, gilt. £3 15s. net.

GEORGIAN ENGLAND (1700-1830)

A Review of its Social Life, Arts and Industries. By Professor A. E. RICHARDSON, F.S.A., F.R.I.B.A., Author of "The English Inn," etc. Containing sections on the Social Scene, Navy, Army, Church, Sport, Architecture, Building Crafts, the Trades, Decorative Arts, Painting, Literature, Theatres, etc. Illustrated by 200 subjects from Photographs and contemporary Prints, Engravings and Drawings, by Hogarth, Wheatley, Gainsborough, Reynolds, Rowlandson, and other artists largely unpublished. With 54 Line Text Illustrations, and a Colour Frontispiece from an unpublished aquatint by ROBERT DIGHTON. Med. 8vo, cloth, gilt. 21s. net.

SPANISH GARDENS

By Mrs. C. M. VILLIERS-STUART. A finely illustrated volume describing the beautiful and most famous gardens by a foremost authority. With 6 Plates in colour from the Author's original Water-colour Drawings, 80 pages of reproductions of gardens, statuary, cascades, garden features, etc., from Photographs, and numerous Illustrations in the text from old Engravings, Pen Drawings, etc. Small royal 8vo, cloth. 25s. net.

TOURING ENGLAND BY ROAD AND BY-WAY

A Popular Illustrated Guide, in a new form, to the Beauties of Rural England. By SYDNEY R. JONES. Comprising 20 Typical Tours under Five Divisions, with General Introduction and complete Map, Introduction to each District and specially drawn simplified Route Map of each Tour, which is described in detail, with finger-post reference to features, and buildings of Interest. Illustrated by 54 Drawings, including a number full-page, specially drawn by the Author, and 50 Illustrations from Photographs by the Artist and others. New and cheaper issue. Crown 8vo, cloth. 7s. net.

ANCIENT CHURCH CHESTS AND CHAIRS IN THE HOME COUNTIES ROUND GREATER LONDON

With some Reference to their Surroundings. By FRED ROE, R.I., R.B.C. With a Foreword by C. REGINALD GRUNDY. A survey of the finest of these survivals of ancient craftsmanship by the leading authority on the subject. With 95 Illustrations, many full-page, from Drawings by the Author and from Photographs, and a number of Line Illustrations in the text. Cheaper reissue. Demy 4to, cloth, gilt. 12s. 6d. net.

EARLY CHURCH ART IN NORTHERN EUROPE

With special Reference to Timber Construction and Decoration. By Professor JOSEF STRZYGOWSKI, Author of "Origin of Christian Church Art," etc. Dealing with PRE-ROMANESQUE ART OF THE CROATIANS; WOODEN ARCHITECTURE IN EASTERN EUROPE; HALF-TIMBER CHURCHES IN WESTERN EUROPE; THE MAST CHURCHES OF NORWAY; ROYAL TOMBS IN SCANDINAVIA. With 190 Illustrations. Royal 8vo, cloth, gilt. 21s. net.

REPRESENTATIVE BRITISH ARCHITECTS OF THE PRESENT DAY

By PROFESSOR C. H. REILLY, M.A., F.R.I.B.A., late Director of the Liverpool School of Architecture. An Account of Twelve Typical Figures, their Careers and Work, including Professor Adshead, Robert Atkinson, Sir Herbert Baker, Sir R. Blomfield, A. J. Davis, E. Guy Dawber, Clough Williams-Ellis, W. Curtis Green, H. V. Lanchester, Sir E. L. Lutyens, Sir Giles Gilbert Scott and Walter Tapper. Illustrated by 130 Exterior and Interior Views of well-known Buildings, and including 12 Portraits. Large 8vo, cloth, gilt. 7s. 6d. net.

(New Volume in "English Church Art" Series)

ENGLISH CHURCH SCREENS

A comprehensive Review of their Evolution and Design, including Great Roods, Tympana and Celures in Parish Churches during Medieval and Renaissance Times. By **AYMER VALLANCE, M.A., F.S.A.**, author of "Crosses and Lychgates," "The Old Colleges of Oxford," etc. Illustrated by some 300 reproductions of typical examples, detail, carving, etc., from photographs, measured drawings and sketches, including many no longer extant and a series in colour from special water-colour drawings. The fullest account of an exceptionally interesting subject. Small 4to, cloth, lettered, 21s. net. Only a limited edition is available.

THE ENGLISH CHURCH ART SERIES

OLD CROSSES AND LychGATES

A Study of their Design and Craftsmanship. By **AYMER VALLANCE, M.A., F.S.A.** With over 200 fine Illustrations from special Photographs, Old Prints, and Drawings. Crown 4to, art linen. Cheaper reissue, 12s. 6d. net.

ENGLISH CHURCH WOODWORK AND FURNITURE

A Study in Craftsmanship from A.D. 1250-1550. By **F. E. HOWARD** and **F. H. CROSSLEY, F.S.A.** Illustrating, in over 480 examples from Photographs, the Development of Screens, Stalls, Benches, Font-Covers, Roofs, Doors, Porches, etc., with details of the Carved and Painted Decoration, etc., etc. Second and cheaper Edition, revised, with a new series of 16 Colotype Plates. Crown 4to, cloth, gilt. 25s. net.

ENGLISH CHURCH MONUMENTS, A.D. 1150-1550

By **F. H. CROSSLEY, F.S.A.** A survey of the work of the old English craftsmen in stone, marble, and alabaster. Containing over 250 pages, with upwards of 350 Illustrations, from special Photographs and Drawings. Crown 4to, cloth, gilt. Cheaper reissue. 21s. net.

ENGLISH CHURCH FITTINGS AND FURNITURE

By the Rev. **J. C. COX, LL.D., F.S.A.** A Popular Survey, treating of Churchyards, Bells, Fonts and Covers, Pulpits, Lecterns, Screens, Chained Books, Stained Glass, Organs, Plate and other features of interest. With upwards of 250 Illustrations from Photographs and Drawings. 8vo, cloth, gilt. New and cheaper reissue. 12s. 6d. net.

THE GROWTH OF THE ENGLISH HOUSE

A short History of its Design and Development from 1100 to 1800 A.D. By **J. ALFRED GOTCH, F.S.A., PP.R.I.B.A.** Containing 300 pages, with over 150 Illustrations from Photographs, and many pictures in the text from Measured Drawings, Sketches, Plans, and Old Prints. Second Edition, revised and enlarged. Large crown 8vo, cloth, gilt. 12s. 6d. net.

THE SMALLER HOUSE OF TO-DAY

By **GORDON ALLEN, F.R.I.B.A.**, Winner of the *Daily Mail* Prize for the Best £1,500 House. Containing Notes on Sites and Subsoils, Plans, Exteriors, Methods, Interiors, Hygiene, Gardens, Finance, etc. With 2 Plates in colour, 64 from Photographs, and 153 Illustrations from Line Drawings of Houses, Plans, and Designs. Medium 8vo, cloth. 10s. 6d. net.

THE CHEAP COTTAGE AND SMALL HOUSE

By **GORDON ALLEN, F.R.I.B.A.** New Edition, remodelled and enlarged, containing over 150 Illustrations from Drawings and Photographs of Cottages and their Plans, Housing Schemes, etc., from typical Designs. Medium 8vo, cloth. 8s. 6d. net.

**THE FOUR VOLUMES OF
BATSFORD'S LIBRARY OF DECORATIVE ART**

form an attractive Series of remarkable scope and completeness. It reviews the Development of English Decoration and Furniture during the three Renaissance Centuries, XVI, XVII, and XVIII (1500-1820). Each volume has an extensive series of Plates, and is a complete guide to the work of its Period. The volumes are remarkable for the beauty and number of their illustrations, the simplicity and clearness of their arrangement, and their moderate prices. The complete series is published at prices amounting to £10, but is supplied for the present at the special price of £9 net.

"These handsome volumes with their extremely fine and copious illustrations provide a full survey of English Furniture and Decoration."—*The Times*.

**VOL. I. DECORATION AND FURNITURE IN ENGLAND
DURING THE EARLY RENAISSANCE, 1500-1660**

An Account of their Development and Characteristic Forms during the Tudor, Elizabethan and Jacobean Periods, by M. JOURDAIN. Containing about 300 pages, and over 200 full-page Plates (with Coloured Frontispiece and some in Photogravure), including over 400 Illustrations, from specially made Photographs and Measured Drawings, and from Engravings. Folio (size 14 x 10½ in.), cloth, gilt. £2 10s. net.

VOL. II. FURNITURE IN ENGLAND FROM 1666 TO 1760

By FRANCIS LENYON. A Survey of the Development of its Chief Types. Containing 300 pages with over 400 Illustrations, from special Photographs, together with 5 in colour. Second Edition, revised with many new Illustrations. Folio (14 in. x 10½ in.), cloth, gilt. £2 10s. net.

VOL. III. DECORATION IN ENGLAND FROM 1640 TO 1770

By FRANCIS LENYON. A Review of its Development and Features. Containing 300 pages with over 350 Illustrations, of which 133 are full-page, from special Photographs, and 4 in colour. Second Edition, Revised and Enlarged. Folio (14 in. x 10½ in.), cloth, gilt. £2 10s. net.

**VOL. IV. DECORATION AND FURNITURE IN ENGLAND
DURING THE LATER XVIIITH CENTURY, 1760-1820**

An Account of their Development and Characteristic Forms, by M. JOURDAIN. Containing about 300 pages, with over 180 full-page Plates (a selection in Collotype), including over 400 Illustrations, from specially made Photographs and Measured Drawings, and from Engravings. Folio (size 14 x 10½ in.), cloth, gilt. £2 10s. net.

**OLD ENGLISH FURNITURE FOR THE SMALL
COLLECTOR**

Its History, Types and Surroundings from Medieval to Early Victorian Times. By J. P. BLAKE and A. E. REVEIRS-HOPKINS. Containing 150 pages with about 130 Illustrations from Photographs, Old Prints and Pictures, Original Designs, Ornaments, etc. The book is planned as the first systematic and comprehensive guide to the simpler types of old furniture within the scope of the collector of average means. Med. 8vo. 12s. 6d. net.

THE DECORATIVE ARTS IN ENGLAND, 1660-1780

By H. H. MULLNER, with an Introduction by J. STARKIE GARDNER. A Series of 110 full-page Plates illustrating 256 Specimens of Furniture, Lacquering, Marquetry, Chandeliers, Clocks, Silver, Enamels, Locks, Ormolu Vases, Tapestry, Needlework, Bookbindings. With brief Historical Introductions and full descriptions. Folio, half-parchment, gilt. The few remaining copies offered at 30s. net, published at £3 10s. net.

A BOOK OF BUNGALOWS AND MODERN HOMES

A series of Typical Designs and Plans. By **Cecil J. H. Keeley, F.S.I., A.R.San.L., Architect.** Comprising 36 Designs, with large scale Plans, Brief Descriptions and Estimated Cost, including some two-Storey Houses, Frontispiece in colour, Interior Views, Photographic Plates, etc. Large 8vo, cloth, lettered. 7s. 6d. net.

"The work may be recommended to those people who are on the look-out for homes designed with intelligence and convenience, and who have an eye for charm and artistic finish."—*Field.*

MODERN THEATRES AND CINEMAS

By **P. Morton Shand.** A series of 80 plates giving over 100 examples of exteriors, interiors, foyers, vestibules, lighting, mural decoration, details, etc., of Theatres and Cinemas in the modern post-war style in France, Germany, England, Scandinavia, Italy, America, etc. Containing reproductions of the work of such architects as Margold, Kaufmann, Siclus, Gropius, Lipp, Ionides, Sauvage, de Soissons, Wilms, Mendelsohn, etc. Containing in addition numerous plans, elevations, sections in the text. Cr. 4to, art canvas. 15s. net.

THE NEW STYLE

Architecture and Design. A Survey of its First Phase in Europe and America. With an Introduction adapted from the French of **Maurice Castells**, and descriptive notes on the Plates. Comprising 144 full-page Plates in Photogravure of Buildings, Interiors, Furniture, Lighting, etc., by well-known modern architects such as Le Corbusier, Mendelsohn, Gropius, Dudock, Mallet-Stevens, etc., chosen to illustrate the new movement in all its most representative manifestations. 4to, cloth, gilt. 12s. 6d. net.

ENGLISH INTERIORS FROM SMALLER HOUSES OF THE XVIITH TO XIXTH CENTURIES, 1660-1820

By **M. Jourdain.** Illustrating the simpler type of Design during the Stuart, Georgian, and Regency Periods. Containing 200 pages, and 100 Plates, comprising 200 Illustrations, from Photographs and Measured Drawings of Interiors, Chimney-pieces, Staircases, Doors, Ceilings, Panelling, Metalwork, Carving, etc., from minor Country and Town Houses. With Introduction and Historical Notes. Cheaper reissue. Large 4to, cloth, gilt. 15s. net.

ENGLISH PLASTERWORK OF THE RENAISSANCE

A Review of its Design during the Period from 1500 to 1800. By **M. Jourdain.** Comprising over 100 full-page Plates of Elizabethan, Stuart, Georgian, and Adam ceilings, friezes, overmantels, panels, ornament, detail, etc., from specially taken Photographs and from Measured Drawings and Sketches. With an Illustrated Historical Survey on Foreign Influences and the Evolution of Design, Work and Names of Craftsmen, etc. New and cheaper reissue. Demy 4to, cloth. 15s. net.

OLD ENGLISH FURNITURE: THE OAK PERIOD, 1550-1630

Its Characteristics, Features, and Detail from Tudor Times to the Regency. For the use of Collectors, Designers, Students, and Others. By **J. T. Garside.** Containing 30 Plates reproduced from the Author's specially prepared Drawings illustrating about 400 details of Table Legs; Bedposts; Corbels; Friezes; Capitals; Panels; Inlay Motives; Metal Fittings, etc. Including also Drawings of type-pieces of the period and 20 Photographic Illustrations. With an Historical Introduction, etc. Cheaper reissue 8vo, cloth, gilt. 7s. 6d. net.

THE ART AND CRAFT OF HOME MAKING

A Comprehensive Guide with an Appendix of Household Recipes. By EDWARD W. GREGORY. Second Edition, revised, with additional Chapters and new Illustrations. Containing Practical Hints and Information on such subjects as Taking a House—Wallpapers—Furnishing Various Rooms—Pictures—Kitchen—Heating—Carpets—Curtains—Things that Get Out of Order—Costs, etc. Containing 224 pages, with 9 Plates in full colour of decorative schemes by GORDON BLUNT, numerous Photographs of Interiors by well-known architects, and many Sketches, Plans and Diagrams in the text. Square 8vo, cloth lettered. 7s. 6d. net.

THE NEW INTERIOR DECORATION

An Introduction to its Principles and International Survey of its Methods. By DOROTHY TODD and RAYMOND MORTIMER. With over 200 Illustrations on 96 Plates of Interiors of every sort, Furniture, Carpets, Textiles, Lighting, Wall Painting, etc., of the new school by such Architects and Artists as Le Corbusier, Mallet-Stevens, Gropius, Oud, Duncan Grant, Lescaze, etc. With a Frontispiece in colour from a drawing by E. MCKNIGHT KAUFFER and full Introductory and Practical Text. Demy 4to, art canvas, with decorative wrapper by E. MCKNIGHT KAUFFER. 12s. 6d. net.

OLD PEWTER: ITS MAKERS AND MARKS

A Guide for Collectors, Connoisseurs, and Antiquaries. By HOWARD HERSCHEL COTTERELL, First Vice-President of the Society of Pewter Collectors. Containing about 500 pages, with 64 Plates of 200 Specimens of British Pewter, dated and described, and a List of 5,000 to 6,000 Pewterers, with Illustrations of their Touches and Secondary Marks, Facsimile Reproductions of existing Touch-Plates, and Text Illustrations. Cheaper reissue. Demy 4to, cloth, gilt. £3 3s. net.

OLD SILVER OF EUROPE AND AMERICA

From Early Times to the XIXth Century. By E. ALFRED JONES. A Survey of the Old Silver of England, America, Austria, Belgium, Canada, Czechoslovakia, Denmark, France, Germany, Holland, Hungary, Ireland, Italy, Norway, Poland, Portugal, Russia, Scotland, Spain, Sweden, Switzerland, etc. With a Chapter on Spurious Plate and 96 Photogravure Plates, comprising Illustrations of 537 subjects. Cheaper reissue. Crown 4to, art canvas, lettered in silver. 18s. net.

ENGLISH LEADWORK: ITS ART AND HISTORY

A Book for Architects, Antiquaries, Craftsmen, and Lovers of Gardens. By Sir LAWRENCE WEAVER, F.S.A. Containing 280 pages, with 441 Illustrations from Photographs and drawings. Large 4to, art linen, gilt. 30s. net.

BATSFORD'S COLLECTORS' LIBRARY

A Series of Handbooks written by experts, providing information of practical value to Connoisseurs, Collectors, Designers, and Students. Each volume forms an ideal introduction to its subject, and is fully illustrated by Reproductions in Colour and from Photographs. The following volumes are still available. 8vo, cloth, gilt, price 6s. net each.

OLD ENGLISH FURNITURE. By F. FENN and B. WYLLIE. With 94 Illustrations. *New Impression.*

OLD PEWTER. By MALCOLM BELL. With 106 Illustrations.

SHEFFIELD PLATE. By BERTIE WYLLIE. With 121 Illustrations.

FRENCH FURNITURE. By ANDRÉ SAGLIO. With 59 Illustrations.

DUTCH POTTERY AND PORCELAIN. By W. P. KNOWLES. With 54 Illustrations.

PORCELAIN. By WILLIAM BURTON. With over 50 full-page Plates illustrating 87 fine examples of the Porcelain of Various Countries and Periods.

A HANDBOOK OF CHINESE ART

Including an Introduction by ROGER FRY and articles on Painting, Sculpture, Bronzes, Ceramics, Textiles, Jade, Enamels and Lacquer, etc., by LAURENCE BINYON, OSVALD SIREN, BERNARD RACKHAM, A. F. KENDRICK and W. W. WINKWORTH. With 23 fine full-page coloured plates, beautifully reproduced, of outstanding examples in public and private collections, and including also between 70 and 80 Photographic Illustrations on 52 plates, and a number of line cuts in the text, with maps, marks, tables of dynasties, etc. Large royal 8vo, cloth, lettered. 15s. net.

THE BURLINGTON MAGAZINE MONOGRAPHS

Issued by the Publishers jointly with The Burlington Magazine

MONOGRAPH NO. I—CHINESE ART (*Out of print*)

MONOGRAPH NO. II—SPANISH ART

An Introductory Review of Architecture, Painting, Sculpture, Textiles, Ceramics, Woodwork, Metalwork, by ROYALL TYLER, SIR CHARLES HOLMES and H. ISHERWOOD KAY, GEOFFREY WEBB, A. F. KENDRICK, B. RACKHAM and A. VAN DE PUT, BERNARD BEVAN, and P. DE ARTINANO, respectively. With a General Introduction by R. R. TATLOCK, late Editor of *The Burlington Magazine*. Illustrated by 120 large scale reproductions of Paintings, Decorative Art, Buildings, etc., including 9 Plates in full colour, comprising 280 pictures in all. With Maps, Bibliography, etc. Royal 4to, cloth. Cheaper reissue, 25s. net.

MONOGRAPH NO. III—GEORGIAN ART

A Survey of Art in England during the reign of George III, 1760-1820, by leading authorities. The Sections comprise: *Painting* by J. B. MANSON; *Architecture and Sculpture* by GEOFFREY WEBB; *Ceramics* by BERNARD RACKHAM; *Woodwork* by OLIVER BRACKETT; *Textiles* by A. F. KENDRICK; *Minor Arts* by LOUISE GORDON-STABLES. With an Introduction by ROGER FRY. The Illustrations include 6 Plates in colour and 64 in half-tone, comprising some 100 subjects, and forming a gallery of the fine and decorative arts of the Period. Cheaper reissue. Royal 4to, cloth. 21s. net.

COLOUR: A MANUAL OF ITS STUDY AND PRACTICE

By H. BARRETT CARPENTER, late Headmaster of the School of Art, Rochdale. A Series of 16 concise but very practical chapters, based on the Author's experiments, on Harmony—Contrast—Discord—Keynotes—Intermingling—Effect of Lighting—Dirty Colour—Black-and-White, etc. Illustrated by 24 Plates (some double size), printed in colour; giving 40 Examples of Colour Combinations, Grading, Toning, etc., including some new examples in colour of application in Historic Design. New and Revised Impression. 8vo, cloth, gilt. 9s. net.

A COLOUR CHART

Issued in connection with the above book. Consisting of a circle 17 inches in diameter, printed in Graded Colour, showing 14 shades, Combinations and Contrasts. With explanatory letterpress. Folio, stout paper. 2s. 6d. net.

FASHION DRAWING AND DESIGN

By LOUIS E. CHADWICK. Illustrated by numerous examples of Historic Fashion Plates, Explanatory Sketches by the Author, Figure Studies, and a series of about 80 full-page and double Plates of Contemporary Fashion Drawings by well-known artists. Cheaper reissue. Large 8vo, cloth, lettered. 7s. 6d. net.

ART IN THE LIFE OF MANKIND

A Survey of its Achievements from the Earliest Times. By ALLEN W. SEABY. Planned in a series of concise volumes, each containing about 80 pages of text, with about 70 full-page and smaller Illustrations from the author's specially prepared Sketches and Drawings, and a series of 16 Photographic Plates. Crown 8vo, cloth. 5s. net per volume.

I. A GENERAL VIEW OF ART: ITS NATURE, MEANING, PRINCIPLES AND APPRECIATION. II. ANCIENT TIMES: THE ART OF ANCIENT EGYPT, CHALDÆA, ASSYRIA, PERSIA, and other lands. III. GREEK ART & ITS INFLUENCE. IV. ROMAN & BYZANTINE ART & THEIR INFLUENCE.

These concise little volumes are designed to serve as an Introduction to the Appreciation and Study of Art in general. They are simply and graphically written and fully illustrated by many Drawings and Photographs.

A SHORT HISTORY OF ART

From Prehistoric times to the Nineteenth Century. Translated from the French of Dr. ANDRÉ BLUM. Edited and Revised by R. R. TATLOCK. Illustrated by 128 full-page Photographic Plates, comprising about 250 examples of the finest Painting, Sculpture, Architecture, and Decorative Art of Early, Classic, Byzantine, Gothic, Renaissance, and Recent Times. Including also about 100 Illustrations in the text from Drawings, Engravings, and Plans. Medium 8vo, gilt. 12s. 6d. net.

HISTORY OF ART

By JOSEPH PRJOAN, Professor at Pomona College, California. In 3 volumes, Royal 8vo, bound in cloth, gilt. A few sets specially available at 30s. net set. Published at 36s. net per volume.

VOL. I. PRIMITIVE, ANCIENT AND CLASSIC ART. With 61 full-page Plates, including many in colour, and 876 Illustrations from Photographs, Plans, Drawings, Restorations, etc.

VOL. II. BYZANTINE, ISLAMIC, ROMANESQUE AND GOTHIC ART. With 52 double- and full-page Plates, including many in colour, and 856 Illustrations from Photographs, etc.

VOL. III. THE RENAISSANCE TO MODERN TIMES. With 34 full-page Plates, including many in colour and 776 Illustrations from Photographs, etc.

THE DRAWINGS OF ANTOINE WATTEAU, 1684-1721

By Dr. K. T. PARKER, of the Ashmolean Museum, Oxford, Editor of "Old Master Drawings." A full, original and critical Survey. Illustrated by 100 Collotype Reproductions of selected characteristic Drawings from private and public collections, many unpublished, a Frontispiece in colour and 16 of the Master's most important pictures. With full, critical and descriptive letterpress, 4to, canvas cloth, gilt. £2 2s. net.

A HISTORY OF BRITISH WATER-COLOUR PAINTING

By H. M. CUNDALL, F.S.A. With a Foreword by Sir H. HUGHES-STANTON, P.R.W.S. A New and Cheaper Edition, revised and enlarged, of this important standard work, with 64 full-page Illustrations in colour, and a full biographical list, arranged alphabetically, of the principal English Water-colourists. Large Medium 8vo, cloth, 15s. net.

HISTORIC TEXTILE FABRICS

By RICHARD GLAZIER. Containing: Materials—The Loom—Pattern—Tapestries—Dyed and Printed Fabrics—Church Vestments, etc., with about 100 Plates from Photographs and from the Author's Drawings including 4 in colour, and 43 Line Diagrams, illustrating over 200 varieties of Textile Design. Large 8vo, cloth, gilt. 21s. net.

THE ART AND CRAFT OF OLD LACE

In all Countries, from the XVIth to the Early XIXth Centuries. By ALFRED VON HENNEBERG. With an Introduction by WILHELM PINDER. Containing a full original account of the Development of Style and an Analysis of Technique and Texture. Including descriptive Notes and a Bibliography. Illustrated by 190 full-page Plates, 8 in colour, giving 60 specimens from scale diagrams and 250 of the finest pieces of Old Lace. Large 4to, cloth, gilt. £3 3s. net.

JOHN OBRISSET

Huguenot, Carver, Medallist, Horn and Tortoise-shell Worker, and Snuff-box Maker. With examples of his Works dated 1705-1728. By PHILIP A. S. PHILLIPS. Containing Text on the Records of the Obrisset family. Writings on his Craftsmanship, and Notes. With 104 Illustrations on 40 Plates, finely reproduced in Collotype, of Horn and Tortoise-shell Tobacco-boxes, Medals, Plaques in different Materials, Medallions, etc. Edition limited to 250 numbered copies, of which 210 are for sale. 4to, canvas, gilt, gilt top. £3 3s. net.

DESIGN IN WOODWORK

A practical manual. By PERCY A. WELLS, late Head of the Woodwork Department, L.C.C., Shoreditch Technical Institute; Author of "Modern Cabinetwork," "Furniture for Small Houses," etc. Comprising chapters on Design (Introductory), Craftsmanship—Decoration—Finishing—Staining—Polishing—Suggestions for courses in Trade Schools and Training Colleges, etc. Illustrated by 25 full-page specially prepared Drawings comprising 150 diagrams and 47 Plates from photographs specially taken of 100 Mirrors, Stools, Clocks, Cabinets, Tables, Bookcases, etc. Demy 8vo, cloth, lettered, 6s. net.

FURNITURE FOR SMALL HOUSES

A Series of Designs. By PERCY A. WELLS. Containing 56 Plates reproduced from Photographs and Working Drawings by the Author, together with Illustrations in the text. Cheaper reissue. Small 4to, cloth. 7s. 6d. net.

HANDCRAFT IN WOOD AND METAL

A Handbook for the use of Teachers, Students, Craftsmen, and others. By JOHN HOOPER and ALFRED J. SHIRLEY. With over 300 Illustrations from Drawings and Photographs. Second Edition, revised and enlarged. Large 8vo, cloth, lettered. 10s. 6d. net.

CRAFTWORK IN METAL

A Practical Elementary Textbook for Teachers, Students, and Workers. By ALFRED J. SHIRLEY. Comprising a series of progressive Lessons and Exercises, illustrated by numerous full-page Plates from the Author's Drawings, each accompanied by detailed working directions, including also Practical Notes, Tables, etc. Medium 8vo, cloth; cheaper reissue with additional plates. 5s. net.

"It bears the imprint of the successful practical teacher—hence its value to other teachers of the craft. We predict the book will be extensively used by teachers and students in the metalwork centres."—*The London Schoolmaster*.

BOOKCRAFTS AND BOOKBINDINGS. A Practical Course.

By JOHN MASON, Teacher at Leicester College of Arts and Crafts, etc.; with an Introduction by S. I. HERMAN, A.R.C.A., Principal of Hull Arts and Crafts College. Containing sections on Historical Developments, various Binding Processes, Lettering, Leather, Paper, etc., with some 300 Illustrations from diagrams and photographs of operations and finished designs. Large 8vo, cloth, hand-marbled by the Author. 8s. 6d. net.

A MANUAL OF HISTORIC ORNAMENT

Being an Account of the Development of Architecture and the Historic Arts, for the use of Students and Craftsmen. By RICHARD GLAZIER, A.R.I.B.A. Fifth Edition, revised and enlarged. Containing 700 Illustrations, chiefly from the Author's Pen Drawings, including many new to this Edition from various sources, and a special series of coloured and Photographic Plates of Ornament of the Orient and the Renaissance. Large 8vo, cloth. 12s. 6d. net.

A HANDBOOK OF ORNAMENT

By Professor F. SALES MEYER. With 3,000 Illustrations of the Elements and the Application of Decoration to Objects, e.g. Vases, Frets, Diapers, Consoles, Frames, Jewellery, Heraldry, etc., grouped on over 300 Plates, reproduced from the Author's specially prepared Drawings. With descriptive text to each subject. Large 8vo, cloth, lettered. 15s. net.

"IT IS A LIBRARY, A MUSEUM, AN ENCYCLOPEDIA, AND AN ART SCHOOL IN ONE. TO RIVAL IT AS A BOOK OF REFERENCE ONE MUST FILL A BOOKCASE. The quality of the drawings is unusually high, and the choice of examples is singularly good. . . . The text is well digested, and not merely descriptive or didactic, but an admirable mixture of example and precept. So good a book needs no praise."—*The Studio*.

THE STYLES OF ORNAMENT

From Prehistoric Times to the Middle of the XIXth Century. A Series of 3,500 Examples Arranged in Historical Order, with descriptive text. By ALEXANDER SPELTZ. Revised and Edited by R. PHENÉ SPIERS, F.S.A., F.R.I.B.A. Containing 560 pages, with 400 full-page Plates exhibiting upwards of 3,500 separate Illustrations. Large 8vo, cloth, gilt. 15s. net.

Mr. WALTER CRANE, in a lengthy review in the *Manchester Guardian*, wrote: ". . . To pack into a single volume of some 626 pages and 400 illustrations a really intelligible account of the styles of ornament prevailing in the world from prehistoric times to the middle of the nineteenth century is a REMARKABLE FEAT. . . . The illustrations are for the most part well chosen and characteristic, and are drawn with decision and facility."

ABSTRACT DESIGN

A Practical Manual on the Making of Pattern. By AMOR FENN, late Head of the Art Section, Goldsmith's College, New Cross. A series of careful, informative sections on Conditions, Elements, etc. Illustrated by about 180 full-page Designs from the Author's specially-prepared Drawings. 8vo, cloth, lettered. 12s. 6d. net.

PATTERN DESIGN

For Students, treating in a practical way the Anatomy, Planning, and Evolution of Repeated Ornament. By LEWIS F. DAY. Containing about 300 pages, and 300 practical Illustrations from specially prepared Drawings and Photographs of the Principles of Repeat Design, the "Drop," the "Spot" Geometrical Ornament, etc. New edition, revised and enlarged by AMOR FENN, with many fresh Illustrations, including a series in colour. Demy 8vo, cloth, gilt. 10s. 6d. net.

NATURE AND ORNAMENT

By LEWIS F. DAY. NATURE THE RAW MATERIAL OF DESIGN, treating chiefly of the decorative possibilities of Plant Form, its growth, features, and detail. With 350 Illustrations, chiefly grouped comparatively under Flowers, Seed Vessels, Fruits, Berries, etc., specially drawn by Miss J. FOORD. New and cheaper Edition, revised, with a Chapter by MARY HOGARTH. Demy 8vo, cloth, lettered. 5s. net.

SHOULD WE STOP TEACHING ART?

By C. R. ASHBEER. An interesting and outspoken account of modern Art Education. 8vo, boards, buckram back. 3s. 6d. net.

THE PRACTICAL DRAWING SERIES

COMPOSITION

An Analysis of the Principles of Pictorial Design. By CYRIL C. PEARCE, R.B.A. With chapters on Tone, Distribution, Gradation, Scale, Perspective, Rhythm, Harmony and Balance of Colour, Discords. Illustrated by 130 comparative and analytical Drawings, Sketches, and Diagrams, 6 Plates in colour, and 28 full-page Illustrations from great Masters. Med. cloth, gilt, paper sides. 10s. 6d. net each.

ANIMAL ANATOMY AND DRAWING

By EDWIN NOBLE. Illustrated by a series of Plates in facsimile of the Author's Drawings of HORSES, CATTLE, DOGS, BIRDS and WILD ANIMALS, representing also Features, Details, etc. Including also numerous full-page and smaller Line Drawings of Anatomy, Muscles, Bones, etc.

PEN DRAWING

A Practical Manual on Materials, Technique, Style, Texture, etc. By G. M. ELLWOOD. Containing sections on History—Technique—Materials—Figures, Faces and Hands—Style and Methods—Landscape and Architecture—Modern Work—Magazine Illustration—Humorous Drawing Advertisements—Fashion. With numerous practical Diagrams by the Author, and 100 pages of Illustrations by the chief Pen Draughtsmen of present and recent times.

THE ART AND PRACTICE OF SKETCHING

A Comprehensive Treatise on the Practice of Sketching by every method. By JASPER SALWEY, A.R.I.B.A. The Author deals successively with various media—Pen, Pencil, Water-colour, Oil, Wash, Crayon, Chalk, etc., and gives a complete account of the Technique of each. Illustrated by 64 Plates of half-tone Illustration and 6 Plates in colour, with various Line Illustrations in the text, from the work of great Artists.

THE ART OF DRAWING IN LEAD PENCIL

By JASPER SALWEY, A.R.I.B.A. A Practical Manual dealing with Materials, Technique, Notes and Sketching, Building up, Form and Style, Process Reproduction, etc. Second Edition, revised and enlarged. Containing 232 pages with 122 finely printed reproductions of selected Pencil Drawings of Land and Seascapes, Figure-Studies, Book-Illustrations, etc.

SKETCHING IN LEAD PENCIL

By JASPER SALWEY, A.R.I.B.A. An Introduction to the same author's "Art of Drawing in Lead Pencil," but dealing entirely with sketching as differentiated from the making of finished Drawings. A practical manual for the Architect, Student and Artist. Containing 111 pages and 56 Illustrations, by well-known artists in the medium, and by the author. 7s. 6d. net.

SKETCHING FROM NATURE

A Practical Treatise on the Principles of Pictorial Composition. By F. J. GLASS. CONTENTS: Choice of Subject and Planning of Sketch—Tones—Exercise in Composition—Examples from the Old Masters. With 6 Plates in colour, numerous compositions from the Author's Drawings, and a series by de Wint, Crome, Constable, Harpignies, Bonnington, etc.

DRAWING FOR ART STUDENTS AND ILLUSTRATORS

By ALLEN W. SEABY. Containing 220 pages, with 133 Illustrations printed in Sepia, mostly full-page Plates, from Drawings by Old and Modern Artists. Second Edition, revised and enlarged. 8vo, cloth.

ART IN DAILY LIFE FOR YOUNG AND OLD

By D. D. SAWER. A companion and complement to the following work with a Foreword by P. H. JOWETT, A.R.C.A., Principal of the Central School of Arts and Crafts, London. A comprehensive practical course for Teachers, Students, and Art Lovers; treating of the Place of Drawing, Plants and their Use, Figure Drawing and Drapery, Animal Drawing, Modelling Shapes and Figures, Casting, Clay Modelling, Object Drawing, Notes on Crafts, Composition, Design, applied and graphic. Each chapter is divided into three sections: A historical résumé, a note on educational significance, and a brief review of its practice and technique. With 10 Plates in Colour, and numerous full-page and text Illustrations in Line and Half-tone. Medium 8vo, cloth, lettered. 10s. 6d. net.

EVERYDAY ART AT SCHOOL AND HOME

By D. D. SAWER. With an appreciative Foreword by Sir Michael Sadler, C.B., Oxford. A Practical Course based on the new Board of Education "Suggestions to Teachers," and adaptable to Dalton Methods, containing graduated lessons on Brushwork, Design, Flower-painting, etc., with sections on Architectural Drawing, Lettering, Stained Glass, Leatherwork, and other Crafts. With 64 Plates in half-tone, from the Author's Drawings, numerous full-page and smaller Line Illustrations, and 8 Plates in colour, many Verse Extracts, etc. Second and cheaper edition, revised and enlarged. Medium 8vo, cloth. 10s. 6d. net.

PERSPECTIVE IN DRAWING

A simple Introductory Account. By Miss D. D. SAWER, late Art Lecturer at the Diocesan College, Brighton, Author of "Everyday Art at School and Home." With an Introduction by Professor ALLEN W. SEABY, late Professor of Fine Art, University of Reading. With Sections on Basic Principles, the Cube, Cylinder, Shadows, Reflections, Aerial Perspective, Colour, and Drawing. Illustrated by over 100 Diagrams and Sketches, a Frontispiece in colour, specially drawn by the Author, and reproductions from Photographs. Crown 8vo, cloth. 5s. net.

SKETCHING AND PAINTING FOR YOUNG AND OLD

An Elementary Practical Manual. By D. D. SAWER, late Art Mistress, Brighton Diocesan Training College, Author of "Everyday Art," "Perspective," etc. With a Foreword by Lord BADEN-POWELL. With chapters on: Ungathered Wealth, a Day Out, Materials, Practice, the First Sketch Out of Doors, Composition, Mounting and Framing. Illustrated by coloured Frontispiece, 8 Plates in Line and half-tone, and 31 text Illustrations from the Author's specially prepared Sketches Diagrams, etc. Crown 8vo, stiff covers, 1s. 6d. net; or quarter-cloth, lettered, 2s. net.

THE ART OF THE BODY

Rhythmic Exercises for Health and Beauty. By MARGUERITE AGNIEL, Dancer and Physical Instructress. A series of simple, easy and enjoyable exercises, illustrated by numerous Photographic Plates, specially posed by the Author. With 100 subjects on 64 Plates, including many reproductions of dance poses and figure studies, draped and nude. CONTENTS: Functions of the Spine—How to Walk Well—Figure Reducing—Exercises for the Digestive Organs, Back and Neck—Legs and Ankles—The Care of the Hands and Feet—Skin, Eyes and Teeth—Constipation—Women's Disorders, etc. Large 8vo, cloth, gilt. 12s. 6d. net.

THE HUMAN FORM AND ITS USE IN ART

A Series of 118 Photographic Studies on 73 Plates from specially selected Female and Child Models, by F. R. YERBURY, including a Series of Male Studies by F. H. CROSSLEY, F.S.A. With an Introduction by G. M. ELLWOOD. Illustrated by 17 Photographic Plates and numerous Text Figures. With descriptive Notes on the Poses. Large 8vo, cloth. 18s. net.

LIVING SCULPTURE

A Record of Expression in the Human Figure. By BERTRAM PARK and YVONNE GREGORY. With an historical and descriptive Introduction by G. MONTAGUE ELLWOOD. Comprising a Series of 47 full-page Studies of Selected Male and Female Figures with descriptive Notes. The Introduction is illustrated by 9 plates, giving 16 examples of the Human Form in Prehistoric, Greek, Renaissance and newest Art. Cheaper reissue. Small 4to, cloth, gilt. 12s. 6d. net.

LAUGHS AND SMILES and How to Draw Them. By A. A. Braun, author of "Figures, Faces and Folds" and other works.

Containing 45 Plates, printed in tints, of numerous constructional sketches, building up in successive stages humorous likenesses of well-known personages, and also figures from old Masters. Comprising in all about 300 Sketches by the Author, with concise instructive Text, including numerous anatomical Diagrams. Oblong 4to, decorative boards, cloth back. 3s. 6d. net.

"A book which young art students, or anyone with a practical taste for art, would appreciate. This attractive manual on humorous portrait-drawing should have a wide appeal."—*Overseas Daily Mail*.

FIGURES, FACES AND FOLDS

A Reference Book on Costume and the Female Countenance and Form. For Fashion Artists, Dress Designers, and Art Students. By ADOLPHE ARMAND BRAUN. Containing 112 comparative Plates, giving over 300 Illustrations of Costumes and Drapery, and of typical Women's Faces, from antique statues and paintings. Including a special series of nude and draped studies from selected models specially posed for fashion work. With practical text, Dress diagrams, Figure details, Anatomy analysis, etc. Cheaper reissue. Demy 4to, stiff paper covers, 10s. 6d. net; cloth, gilt, 12s. 6d. net.

THE CHILD IN ART AND NATURE

By A. A. BRAUN. Containing chapters on Anatomy, Development, and Expression, and over 300 Illustrations from Photographs and Drawings of child poses, expressions, the Child Figure in Art. Second Edition, revised and enlarged. Cheaper reissue. 4to, in stiff covers, 10s. 6d. net; or cloth, gilt, 12s. 6d. net.

ALPHABETS, OLD AND NEW

With 224 complete Alphabets, 30 series of Numerals, many Ancient Dates, etc. Selected and Arranged by LEWIS F. DAY. With a short account of the Development of the Alphabet. Crown 8vo, cloth. 5s. net.

"A book which has, perhaps, proved more helpful than any ever before issued on the subject of alphabets."—*The Decorator*.

A valuable and attractive little Manual

PEN PRACTICE

By WALTER HIGGINS. Chapters on Tools, Broad-pen Practice, Spacing, Italics, Uncials and Half-uncials, Setting out, A Cursive Hand, etc. With 27 Plates specially drawn by the Author, giving some hundreds of Letters, Ornaments and Exercises, and 6 from selected Historical Examples. Second Edition, revised. Crown 8vo, stiff paper covers, 1s. 6d. net; or boards lettered, 2s. 6d. net.

THE ROMAN ALPHABET AND ITS DERIVATIVES

A large-sized Reproduction of the Alphabet of the Trajan Column. By ALLEN W. SEABY. A Series of large Plates, printed from the wood blocks, and including typical examples of Renaissance, Gothic, and Modern Alphabets and Types. With Introduction and descriptive Notes. Medium 4to, half-bound, lettered, or in portfolio. 4s. 6d. net.

DRAWING, DESIGN AND CRAFTWORK

For Teachers, Students, and Designers. By FREDK. J. GLASS. Containing 262 pages, with some 2,000 Illustrations on 156 Plates, from Drawings by the Author and others, and Historic Designs: Chinese, Persian, Japanese, Medieval, etc. Third Edition revised and enlarged with many new Plates, including a special series in colour of Historic and Modern Designs. Demy 8vo, cloth. 12s. net.

MODELLING

A Practical Treatise for the Use of Students, etc. By F. J. GLASS. Containing Chapters on Modelling for Bronze, Wood, Stone, Terra-Cotta, etc.; Modelling a Bust from Life; Figure Modelling; Relief Work; Composition; Casting; Gelatine Moulding; Proportionate Enlargement, etc. With an additional section on the History of Sculpture and Modelled Ornament. Illustrated by about 30 Plates of comparative stages and processes of Modelling, with about 35 Plates of the greatest Sculpture of all Periods, together with many Line Illustrations in the text. Royal 8vo, cloth, gilt. 15s. net.

THE ART AND CRAFT OF LINO CUTTING AND PRINTING

A Manual for the use of Schools and Amateurs. By CLAUDE FLIGHT, author of "Lino-Cuts," "Tinker, Tailor," etc. With a Foreword by J. E. BARTON, Headmaster Bristol Grammar School, author of "Purpose and Admiration." Treating of Designing, Cutting the Blocks, Printing the Blocks, Alterations, Criticism, Rise and Future, etc. The volume contains 80 Pages, with 77 Illustrations, largely full-page, of which 72 are in black and white or single tone and 5 in full colour, by the author and other well-known modern artists, including practical diagrams and prints in various stages. Tall 8vo, decorative boards. 3s. 6d. net.

PRACTICAL WOODCARVING

By ELEANOR ROWE. Third Edition, revised and enlarged, in Two Parts; I. ELEMENTARY WOODCARVING, embodying "Hints on Woodcarving." With numerous Illustrations, many full-page, from Drawings and Photographs of carving operations, examples and details. II. ADVANCED WOODCARVING. With numerous Illustrations, many full-page from Drawings and Photographs of historic and modern carvings. Demy 8vo, limp cloth, lettered, 5s. net each; or two parts in one volume, cloth, gilt, 10s. net.

ONE HUNDRED AND ONE THINGS FOR A BOY TO MAKE

By A. C. HORTH. With Notes on Workshop Practice and Processes, Tools, Joints, and full reliable directions for making Working Models. Illustrated by numerous full-page and smaller practical Diagrams and Sketches specially prepared. Second Edition, revised and enlarged. Crown 8vo, cloth. 5s. net.

Uniform with "101 Things for Boys to Make"

ONE HUNDRED AND ONE THINGS FOR GIRLS TO DO

By A. C. HORTH, Editor of "Educational Handwork," etc. With practical sections on Stitchery, the making of decorative Household Articles in felt, leather, gesso, raffia, Hints on Mending, Cleaning, First-Aid, etc. Illustrated by numerous Line Diagrams, Photographs of finished objects, etc. Crown 8vo, cloth, lettered. 5s. net.

SAMPLERS AND STITCHES

A Handbook of the Embroiderer's Art. By MRS. ARCHIBALD CHRISTIE. Containing 40 full-page Reproductions from Photographs, a Frontispiece in colour, and 289 Text Drawings. Third Edition, revised and enlarged. Crown 4to, boards, canvas back. 25s. net.

ART IN NEEDLEWORK

A BOOK ABOUT EMBROIDERY. By LEWIS F. DAY and MARY BUCKLE. Fourth Edition, revised by MARY HOGARTH. Including a specially worked Series of Stitch-Samplers, numerous supplementary Diagrams and many Plates of Historic Embroidery—Chinese, Medieval, Italian, French and Modern English. With additional Examples of Modern Work by DUNCAN GRANT, MRS. NEWALL, MRS. STOLL, D. HAGER, and others. Containing 280 pages, 80 full-page Plates, reproduced from Photographs, and 50 Illustrations in the text. Crown 8vo, cloth. 7s. 6d. net.

SIMPLE STITCH PATTERNS FOR EMBROIDERY

By ANNE BRANDON-JONES. With coloured Frontispiece and 13 Photographic Plates illustrating 44 Patterns, 4 Plates from the Author's Pen Drawings, showing 31 Stitch Diagrams and 11 Complete Objects. With an Introduction, Chapters on the Method, Sketches, Colour Materials and Application of Designs, also descriptive Notes, with Colour Schemes. Crown 40, paper wrappers, 2s. 6d. net; or in cloth, 3s. 6d. net.

"There is valuable help in this book. There are excellent plates in line and colour. The directions are clear and concise, and the articles suggested for practice are such as will please young people to make."—*Education Outlook*.

STITCH PATTERNS AND DESIGNS FOR EMBROIDERY

By ANNE BRANDON-JONES. An independent companion volume to the above work, containing 48 pages with 45 photographic examples on 12 Plates of simple and effective embroidery Motives, a Frontispiece in colour and numerous Text Illustrations of Stitches and Methods. Crown 4to, paper wrappers, 3s. net; or in cloth, 4s. net.

CANVAS EMBROIDERY

A Manual for Students and Amateurs by LOUISA F. PESEL. Containing 48 pages of text, a coloured Frontispiece, and 14 specially prepared Plates showing Stitches and methods. Medium oblong 4to, paper wrappers, 3s. net; or bound in cloth, 4s. net.

ENGLISH EMBROIDERY. I. DOUBLE-RUNNING, OR BACK-STITCH

By LOUISA F. PESEL. With coloured Frontispiece, 10 specially drawn Plates of 45 Working Designs, and 8 Plates from Photographs of 10 English and Coptic Samplers, comprising numerous Patterns and Motives. With Practical Text and a Preface by ETTA CAMPBELL, Embroidery Teacher, Winchester School of Arts. Uniform with "Canvas Embroidery." Large oblong 4to, paper wrappers, 3s. net; or boards, cloth back, 4s. net.

ENGLISH EMBROIDERY. II. CROSS-STITCH

By LOUISA F. PESEL. With a Coloured Frontispiece, 10 specially drawn Plates of 32 Working Designs, etc., and 8 Plates from Photographs of 15 typical English Samplers and Objects. Comprising 43 subjects, giving hundreds of Patterns and Motives. With Practical Text and a Preface by Professor R. GLEADOWE, late Slade Professor of Fine Arts, Oxford University. Large oblong 4to, paper wrappers, 3s. net; or boards, cloth back, 4s. net.

ILLUSTRATED STITCHERY DECORATIONS

By WINIFRED M. CLARKE. Containing 19 Plates from the Author's specially prepared Drawings, giving some 120 useful original Motives: Borders, Rosettes, Floral Elements, Patterns, Lettering and Worked Objects, such as Bags, Blotters, etc. Including a coloured Frontispiece, Introductory Text and full descriptive Notes on the Plates. Crown 4to, stiff paper wrappers, 3s. net; boards, cloth back, 4s. net.

"A new and extremely useful little book for the embroidery worker. Miss Clarke has succeeded admirably in her task."—*Edinburgh Evening News*.

INDEX TO AUTHORS' NAMES

- Agniel, *Art of the Body*, 28
 Allen, *Cheap Cottage*, 19
 — Small House, 19
 Anderson & Spiers, *Greece and Rome*, 15
 Anderson, *Italy*, 15
 Ashbee, *Teaching Art*, 26
 Ashby, *Arch. of Rome*, 15

 Bailey, *Spanish Towns*, 16
 Batsford & Fry, *The Cathedrals of England*, 4
 — *The Face of Scotland*, 5
 Bell, *Old Pewter*, 22
Beauty of Britain, 7
 Blake, *The Heart of Scotland*, 5
 Blake & Hopkins, *Old Furniture*, 20
 Blum, *History of Art*, 24
Book of Speed, 7
 Brandon-Jones, *Stitch Patterns*, 31
 Brandt, *English at Home*, 6
 Braun, *Child in Art*, 29
 — *Figures, Faces, Folds*, 29
 — *Laughs and Smiles*, 29
 Breton, *Clothing*, 9
 — *Travel*, 9
 Brown, *The Heart of England*, 5
 Budden, *Gothic Churches*, 16
Burlington Magazine Monographs, 23
 Burton, *Porcelain*, 22

 Carpenter, *Colour*, 23
 Casteels, *New Style*, 21
 Chadwick, *Fashion Drawing*, 23
 Chancellor, *18th Century*, 9
 — *Regency Period*, 9
 Chinese Art, 23
 Christie, *Samplers*, 30
Cities of Northern Europe, Pictorial Guide, 9
 Clarke, *Stitchery Decorations*, 31
 Cohen-Portheim, *Spirit of London*, 4
Collectors' Library, 22
Colour, Art and Life Library, 8
 Cotterell, *Old Pewter*, 22
 Cox, J. C., *Church Fixings*, 19
 — & Ford, *Parish Churches*, 4
 Crossley, *English Abbey*, 4
 — *Monuments*, 19
 Crossley & Howard, *Church Woodwork*, 19
 Cundall, *Water Colour Painting*, 24

 Day, *Alphabets*, 29
 — *Needlework*, 31
 — *Pattern Design*, 26
 — *Nature and Ornament*, 26
 Dinsmoor, *Greek Architecture*, 15
 Doyle, *Spirit of Ireland*, 3
 Dutton, *Country House*, 3

 Ellwood, *Pen Drawing*, 27
 Ellwood & Yerbury, *Human Form*, 28
 Eyston, *Motor Racing*, 6
 — *Speed on Salt*, 13

 Farey & Edwards, *Architectural Drawing*, 13
 Fenn, *Abstract Design*, 26
 Fenn & Wyllie, *Furniture*, 22
 Fleming, *Folk Tales*, 7
 Fletcher, *Architecture*, 17
 — *The Architectural Work of*, 17
 Flight, *Lino-Cutting*, 30
 Ford, *Parish Churches*, 4

 Garner & Stratton, *Tudor Architecture*, 14
 Garside, *Furniture*, 21
 Georgian Art, 23
 Glass, *Drawing, Design*, 30
 — *Modelling*, 30
 — *Sketching*, 27
 Glazier, *Ornament*, 26
 — *Textiles*, 24
 Godfrey, *English Architecture*, 14
 — *Gardens*, 5
 Gotch, *English House*, 19
 — *Northamptonshire Houses*, 17
 Gregory, *Home Making*, 22
 Gröber, *Toys*, 17

 Hako & Button, *Archl. Drawing*, 11
 Hamilton, *Byzantine Arch's*, 15
 Hartley, *Medieval Costume*, 10
 — *Countryman's England*, 5
 Hartley & Elliott, *Life and Work*, 10
 Haupt, *Italian Palaces*, 17
 Henneberg, *Old Lace*, 25
 Higgins, *Pen Practice*, 29
 Hooper & Shirley, *Handcraft*, 25
 Horth, *101 Things for Boys and Girls*, 30
 Howard, *Styles of Parish Church*, 8

 Jekyll, *Household Life*, 8
 Jones, *Ancient Architecture*, 14
 — *Old Silver*, 22
 — *Touring England*, 18
 Jourdain, *Decoration and Furniture*, 20
 — *Interiors*, 21
 — *Plasterwork*, 21
 Keeley, *Bungalows*, 21
 Kelly & Schwabe, *Costume*, 10
 — *Costume and Armour*, 10
 Knowles, *Dutch Pottery*, 22

Legacy of England, 7
 Lenygon, *Decoration and Furniture*, 20
Library of Decorative Art, 20

 Mason, *Bookcrafts*, 25
 Massingham, *English Downland*, 6
 Mawson, *Garden-making*, 17
 Meyer, *Ornament*, 26
 Mulliner, *Decorative Arts*, 20
Nature in Britain, 7
 Noble, *Animal Drawing*, 27
 Pakington, *Villages and Hamlets of England*, 4

 Park, *Living Sculpture*, 29
 Parker, *Watteau Drawings*, 24
 Pearce, *Composition*, 27
 Pesel, *Embroidery Works*, 31
 Phillips, *Ovrisseid*, 25
 Pijoan, *History of Art*, 24
Practical Drawing Series, 27
 Pulbrook, *Country Life*, 8
 — *Countryside*, 8

 Quennell, *Everyday Life*, 12
 — *Everyday Things*, 11
 — *Greece*, 13
 — *Good New Days*, 9
 Quigley, *Scottish Highlands*, 6

 Reilly, *Mod. British Architects*, 18
 Richardson, *Georgian England*, 18
 — *Smaller House*, 15
 — *The Old Inns of England*, 5
 Roe, *Church Chests*, 18
 Rosenau, *Design and Medieval Architecture*, 15
 Rouse, *Old Towns*, 3
 Rowe, *Woodcarving*, 30

 Saglio, *French Furniture*, 22
 Salwey, *Lead Pencil*, 27
 — *Sketching*, 27
 Salzman, *Tudor England*, 12
 Sawyer, *Everday Art*, 28
 — *Art in Daily Life*, 28
 — *Perspective*, 28
 — *Sketching*, 28
 Seaby, *Art of Manhind*, 24
 — *Drawing*, 27
 — *Roman alphabet*, 29
 Shand, *Theatres & Cinemas*, 21
 Shore, *Dinner Building*, 7
 — *Touring London*, 12
 Smith, *Archl. Work of Sir Banister Fletcher*, Spanish Art, 23
Speed, Book of, 7
 Speltz, *Styles of Ornament*, 26
 Statham, *Architecture*, 14
 Stratton, *Archl. Diagrams*, 16
 — *Elements*, 16
 — *Orders*, 16
 — *Styles*, 16
 Strzygowski, *Church Art*, 18

 Todd & Mortimer, *Modern Decoration*, 22

 Vale, *Seas and Shores*, 3
 Vallance, *Crosses and Lychgates*, 19
 — *English Church Screens*, 19
 Villiers-Stuart, *Spanish Gardens*, 18

 Ward, *French Architecture*, 15
 Waterhouse, *Story of Archire.*, 14
 Weaver, *Leadwork*, 22
 Wells, *Furniture*, 25
 — *Design in Woodwork*, 25
 Wyllie, *Furniture*, 22
 — *Sheffield Plate*, 22