

# LENNOX FOUNDRY Co. LTD.

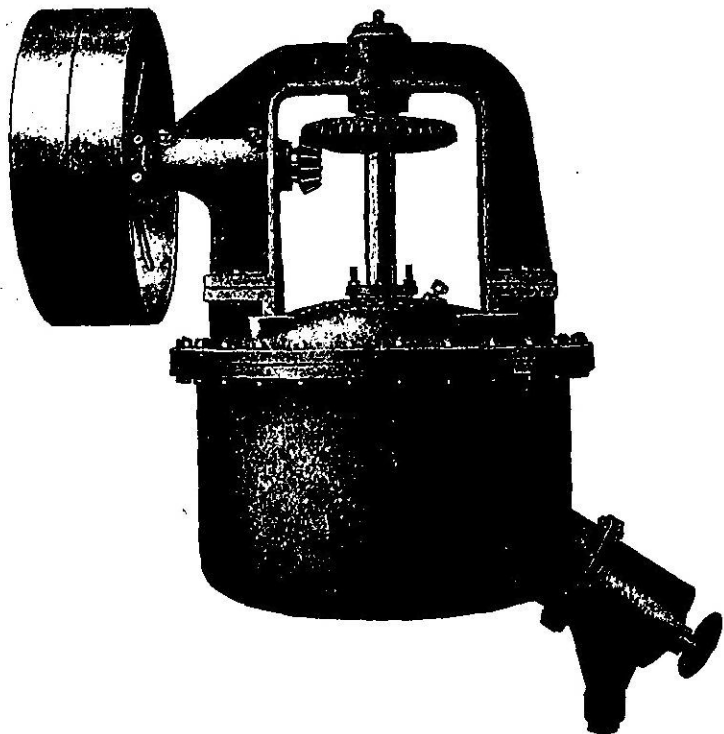

Plant for every Chemical and Industrial Operation in  
**STEEL, COPPER, LEAD,  
SPECIAL CAST IRON,  
ALUMINIUM, REGULUS,**  
or alloys of these on any scale for any temperature  
whether subject to corrosion or erosion.

*CONSIDER THE USE OF*

**TANTIRON      TANTNICKEL  
TANTCOPPER    TANTLEAD**

in any part of your plant where corrosion gives trouble.  
Ask our research department or have your requirements  
demonstrated in our technical laboratories.

**LENNOX FOUNDRY CO. LTD.**  
**GLENVILLE GROVE - LONDON, S.E. 8**  
**NEAREST RY. STATION: NEW CROSS**

Telegrams: "EQUIFEX DEPTMARK, LONDON"

Telephones: NEW CROSS, 770

ALL CODES

# CHEAPNESS OF COST VERSUS ECONOMICAL WORKING

Cheapness of Cost and Economical Working look at first sight the same thing.

## THEY ARE NOT!

It is always a case of a choice between the two; a struggle between the two. In a Chemical Works at any rate a cheap thing is scarcely ever an economical thing. The conditions are so severe for one thing, and for another the effects of stoppage are so serious.

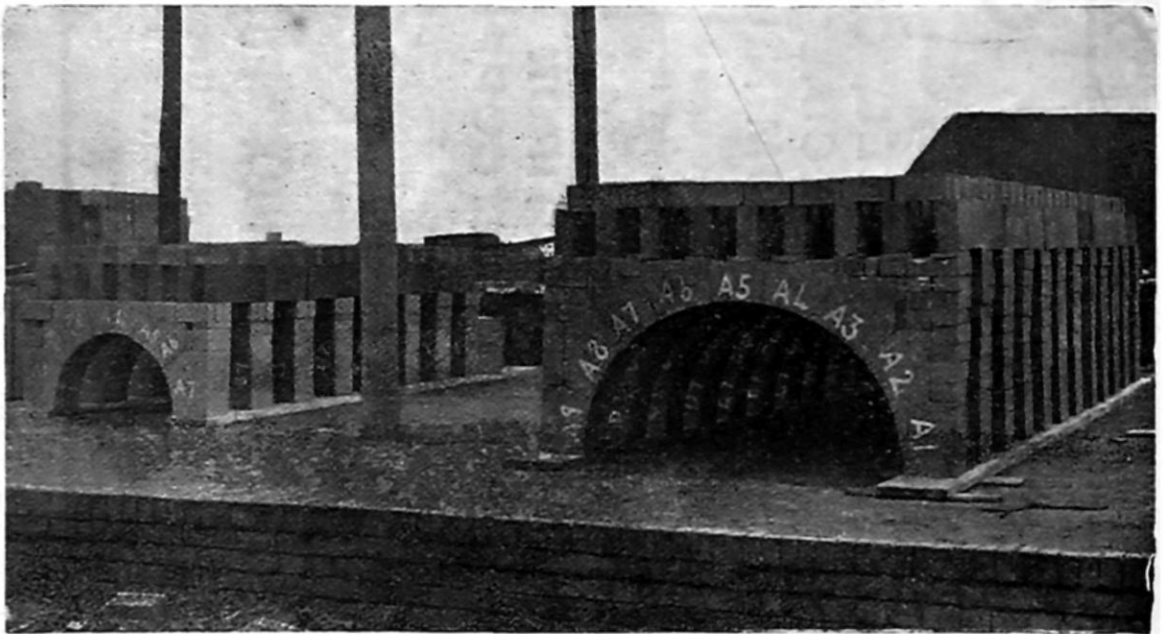

**No. 4.**—A large stock of "**OBSDIANITE**" Fire-and-acid-proof Arches for Glover Towers, with openings from 3 ft. to 6 ft. 6 in., always kept in stock, fitted and numbered for re-erection. Two of these arches put together will make a circular gas inlet.

## OBSDIANITE ACIDPROOF

goods are the most economical goods to use in an Acid Works, because they long outlast all others, and therefore give the smoothest working and least breakdown with consequent expenditure on repairs and upkeep, and loss in stoppages.

But they are not the cheapest at first cost. They cannot be; for no trouble or expense is spared to make them the best that can be produced.

But note, please, **IN THE END ECONOMY OF WORKING WILL ALWAYS WIN AGAINST CHEAPNESS OF FIRST COST**; and he is wise who learns this lesson before it is too late.

"**OBSDIANITE**" FIRE-AND-ACID-PROOF TOWER PACKING AND LINING GOODS, etc., are made only by

**CHARLES DAVISON & CO. LTD.,** EWLOE BARN, BUCKLEY  
CHESTER

INDUSTRIAL AND MANUFACTURING  
CHEMISTRY (INORGANIC)  
VOL. II.

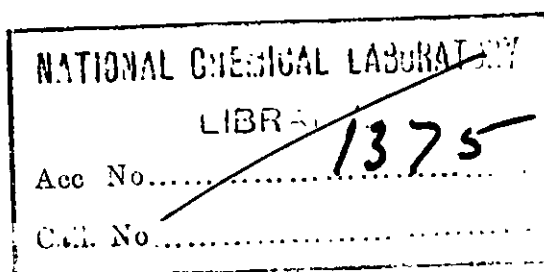

*Uniform with the Present Volume*

Fourth Edition, Revised. Royal 8vo. 500 pages. Cloth.  
Fully Illustrated. Price 28s. net

# INDUSTRIAL AND MANUFACTURING CHEMISTRY

## INORGANIC

A PRACTICAL TREATISE

BY

GEOFFREY MARTIN, D.Sc., Ph.D., F.I.C.

TECHNOLOGICAL CHEMIST AND CHEMICAL ENGINEER, FORMERLY LECTURER AND  
DEMONSTRATOR IN CHEMISTRY AT UNIVERSITY COLLEGE, NOTTINGHAM; LATE OF THE  
CHEMICAL RESEARCH DEPARTMENT OF THE CO-OPERATIVE WHOLESALE SOCIETY LTD.

ASSISTED BY EMINENT SPECIALISTS

### VOLUME I

#### LIST OF SECTIONS

Solid Fuels.  
Manufacture of Briquettes.  
Liquid Fuels.  
Furnaces.  
Coke Ovens.  
Surface Combustion.  
Pyrometry and Pyroscopy.  
Refrigerating and Ice-Making.  
Liquefaction of Gases.  
Industrial Oxygen, Nitrogen, and  
Hydrogen.  
Producer Gas.  
Carbon-Dioxide and Carbonic  
Acid.  
Industrial Ozone.  
Technology of Water.  
Artificial Mineral Waters.  
Sulphur, Sulphuric Acid, Sulphur  
Dioxide, and Sulphites.  
Salt.  
Hydrochloric Acid.  
Sodium Sulphate, Sodium Carbonate,  
and Soda.

The Stassfurt Industry.  
Potassium Salts.  
Calcium and Magnesium Salts.  
Gypsum.  
Barium Salts.  
Strontium Salts.  
Compounds of Boron.  
Manufacture of Chlorine.  
Electrolytic Chlorine and Alkali.  
Liquid Chlorine.  
Chlorates and Perchlorates.  
Bleaching Powder.  
Bromine.  
Iodine.  
Hydrofluoric Acid.  
Peroxides and Per-Acids.  
The Nitrate Industry.  
Nitric Acid.  
Ammonia and Ammonium Salts.  
Synthetic Ammonia.  
The Cyanamide Industry.  
The Cyanide and Prussiate Industry.  
Nitrous Oxide.

CROSBY LOCKWOOD & SON, Publishers, LONDON

# INDUSTRIAL AND MANUFACTURING CHEMISTRY

## PART II

### INORGANIC

*A PRACTICAL TREATISE*

BY

**GEOFFREY MARTIN, D.Sc., Ph.D., F.I.C.**

TECHNOLOGICAL CHEMIST AND CHEMICAL ENGINEER,  
FORMERLY LECTURER AND DEMONSTRATOR IN CHEMISTRY AT  
UNIVERSITY COLLEGE, NOTTINGHAM;  
HEAD OF THE CHEMICAL RESEARCH DEPARTMENT OF THE  
CO-OPERATIVE WHOLESALE SOCIETY LTD.

### VOLUME II

Assisted by

A. S. CARLOS, B.Sc.  
E. A. DANCASTER, B.Sc.  
H. D. K. DREW, B.Sc.  
SYDNEY J. JOHNSTONE, B.Sc.  
C. AINSWORTH MITCHELL  
B.A., F.I.C.

F. W. PENNY, B.Sc.  
H. STANLEY REDGROVE, B.Sc.  
ALEXANDER S. RUSSELL,  
D.Sc.  
ALFRED B. SEARLE.  
JAMES SHELTON, F.I.C.

*FOURTH IMPRINT*

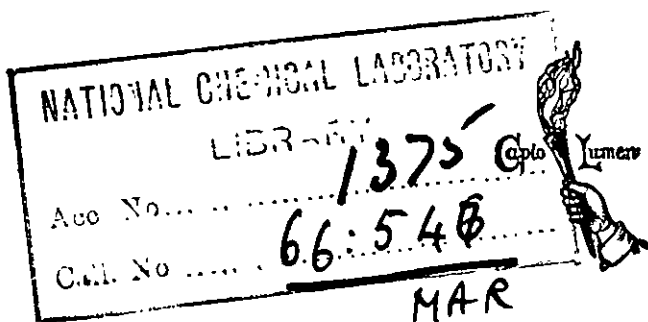

LONDON  
THE TECHNICAL PRESS LTD  
5 AVE MARIA LANE, LUDGATE HILL, E.C.4

1925

[All Rights Reserved]

*By the Author of the Present Volume*

Just Published. Sixth Edition, Revised. Nearly 750 Pages, with  
250 Illustrations. Royal 8vo. Price 36s. net.

# INDUSTRIAL AND MANUFACTURING CHEMISTRY

## ORGANIC

### A PRACTICAL TREATISE

#### LIST OF SECTIONS

1. The Oil, Fat, Varnish, and Soap Industry (by Dr Newton Friend, Dr Goodwin, Dr Martin, Mr C. A. Mitchell, Mr W. H. Stephens).
  2. The Sugar Industry (by Dr Druce Lander).
  3. The Starch Industry (by Dr G. Martin).
  4. The Cellulose Industry (by Mr A. J. Carrier and Dr G. Martin).
  5. The Fermentation Industries (by Mr C. H. Griffiths, Dr G. Martin, Dr A. Slator, and Mr W. H. Stephens).
    - (1) Ferments, Enzymes, Bacteria, Moulds, Yeasts, etc.
    - (2) The Rate of Alcoholic Fermentation by Living Yeast.
    - (3) Wine.
    - (4) Beer.
    - (5) Spirits and Industrial Alcohol. Parts I. and II.
    - (6) Vinegar, Lactic and Butyric Acids.
  6. The Charcoal and Wood Distilling Industries (by Dr G. Martin).
  7. The Turpentine and Rosin Industry (by Dr G. Martin).
  - Appendix*—Natural and Synthetic Camphor.
  8. Industrial Gums and Resins (by Dr Newton Friend).
  9. The Rubber Industry (by Mr A. J. Carrier, B.Sc., Dr G. Martin, and Mr C. H. Martin).
    - (1) Natural Rubber, Guttapercha, and Balata.
    - (2) Synthetic Rubber.
  10. The Industry of Aliphatic Chemicals (by Dr G. Martin).
  11. The Illuminating Gas Industry (by Mr E. A. Dancaster, B.Sc., including a section on Acetylene by Mr F. B. Gatehouse).
  12. The Coal Tar and Coal Tar Product Industry (by Dr G. Martin).
  13. Industry of Synthetic Colouring Matters (by Mr T. Beacall, B.A., and Dr G. Martin).
  14. Industry of Natural Dye Stuffs (by Dr G. Martin).
  15. The Ink Industry (by Dr G. Martin).
  16. The Paint and Pigment Industry (by Dr Newton Friend).
  17. The Textile Fibre, Bleaching, and Waterproofing Industries (by Dr G. Martin).
  18. The Dyeing and Colour-Printing Industry (by Dr Henry S. Sand).
  19. The Leather and Tanning Industry (by Mr Douglas L. Law, B.Sc., F.I.C.).
  20. The Glue, Gelatine, and Albumen Industry (by Dr G. Martin).
  21. The Industry of Modern Synthetic and other Drugs (by Dr F. Challenger).
  22. The Modern Explosives Industry (by Mr Wm. Barbour, M.A., B.Sc.).
  23. The Industry of Photographic Chemicals (by Dr G. Martin).
  24. The Tobacco Industry (by Mr S. E. Hodgkinson).
- Appendix I. Useful Tables.  
Appendix II. Index List of Trade Names of the Newer Synthetic Drugs, etc.

LONDON: CROSBY LOCKWOOD & SON

# TABLE OF CONTENTS

## OF VOL. II. (INORGANIC)

### SECTION LII

### DISINFECTANTS AND ANTISEPTICS

By GEOFFREY MARTIN, Ph.D., D.Sc.

PAGE

Literature—Introduction—Distinction between Disinfectants and Antiseptics— Germicidal Power—Testing Disinfectants—The Rideal-Walker Carbohc Acid Coefficient—Table of Rideal-Walker Coefficients . . . . .	I
--	---

#### Part I. Organic Disinfectants and Antiseptics.

Coal Tar Fluids—The Creosoles—Guaiacol—Creosol—Thymol—Resorcinol— Catechol—Hydroquinone—Pyrogallol—Beta-Naphthol—Tribromnaphthol—Sub- stituted Naphthols—Essential Oils—Eucalyptus—Pinol—Sanitas—Benzoic Acid— Salicylic Acid—Salol—Salophen—Acetic Acid—Propionic Acid—Tartaric Acid— Citric Acid—Lactic Acid—Formic Acid—Formaldehyde—Paraformaldehyde— Iodine Cyanide—Iodoform—Carbon Tetrachloride—Saccharin—Hexamethylene— Tetramine . . . . .	4
---	---

#### Part II. Inorganic Disinfectants.

1. <b>Oxidising Disinfectants</b> —Oxygen—Ozone—Hydrogen Peroxides— <b>Metallic Peroxides</b> —Calcium Peroxide—Magnesium Peroxide—Sodium Peroxide—Zinc Peroxide—Mercury Peroxide—Persulphates—Percarbonates—Perborates—Per- manganates— <b>Chlorine</b> —Hypochlorites—Bleaching Powder—Sodium Hypo- chlorite—Removal of Chlorine from Water . . . . .	6
2. <b>Bromine and Iodine and their Derivatives</b> —Bromine—Bromidine—Iodine —Iodine Trichloride . . . . .	10
3. <b>Acids, Metallic Salts, Alkalis, and Metals</b> —Germicidal Power of Acids and Metallic Salts—Boric Acid—Sodium Borofluoride—Osmic Acid—Carbonic Acid—Hydrofluoric Acid and Fluorides—Hydrofluorsilicic Acid—Hydrocyanic Acid and Cyanides—Nitric Acid and Oxides of Nitrogen—Chromic Acid—Sulphuric Acid—Acid Sodium Sulphate—Sulphur Dioxide and Sulphites—Sulphur—Arsenic —Lime—Sodium and Potassium Hydroxides—Sodium and Potassium Carbonates —Soaps—Salt—Copper and Copper Salts—Mercury and Mercury Salts—Silver Salts—Zinc Salts and Zinc—Aluminium Salts and Aluminium—Iron Salts and Metallic Iron . . . . .	10

## SECTION LIII

## INSECTICIDES, FUNGICIDES, AND SHEEP-DIPS

By GEOFFREY MARTIN, Ph.D., D.Sc.

	PAGE
Literature—Copper Compounds—Bordeaux Mixtures—Peach Bordeaux Mixture—Soda Bordeaux Mixture—Potash Bordeaux Mixture—Soap Bordeaux—Manufacture . . . . .	17
Sulphur Fungicides—Sulphur—Sulphur and Resin Solution—Potassium Sulphide Fungicide—Corrosive Sublimate—Lime—Sulphur Washes—Preparation—Formaldehyde . . . . .	17
Sheep-Dips—Lime and Sulphur Dips—Preparation of Lime and Sulphur Dips—Use of Lime and Sulphur Dips . . . . .	18
Tobacco and Sulphur Dips—Nicotine—Manufacture—Preparation of Tobacco Extract for Dips . . . . .	19
Arsenical Dips—Formulas—Disadvantages . . . . .	20
Carbolic Dips . . . . .	20

## SECTION LIV

## ARTIFICIAL MANURES

By A. S. CARLOS, B.Sc.

Literature—I. Phosphatic Manures—Natural Phosphates—Crushing—Grinding—Ball Mills—Tube Mills—Ring-Roll Mills—Roll Mills—Disintegrating Machines—Stamp Mills—Separators—Screen Separators—Air Separators—Superphosphate—Process of Manufacture—Milch Patent Superphosphate Den—Milch Chamber—Basic Superphosphate—Double Superphosphate—Dissolved or Vitriolised Raw Bones—Dissolved Bone Compounds—Basic Slag . . . . .	21
II. Phospho-Nitrogenous Manures—Bones—Raw and Unsteamed Bone Manure—Crushing—Steamed or Gelatinised Bones—Flesh Meal—"Fray-Bentos" Guano—Fish Manures or Guanos—The Drier—Wet Fish Scrap—Whale Meal . . . . .	33
III. Nitrogenous Manures—(a) Inorganic—Nitrate of Soda—Ammonium Sulphate—Calcium Nitrate. (b) Organic—Calcium Cyanamide—Nitrolime—Rape Cakes and Meals—Rape Seed Meal—Castor Oil Meals—Blood Meal—Horn and Hoof Meals—Wool, Shoddy, Rags, etc.—Skin and Leather Meals—Bacterial Manures—Use of Waste Products for Making Manures . . . . .	36
IV. Potash Manures—Agricultural Consumption of Potash in the World—Chief Potash Manures: Kainit—Muriate of Potash—Sulphate of Potash—Nitrate of Potash—Miscellaneous Manures: Salt—Calcium or Lime Manures—Quicklime—Calcium Carbonate—Silicate Manures—Mixed Manures—Potassic Superphosphate—Saltpetre Superphosphate—Artificial Guanos—Guanos: (a) Raw Peruvian Guano—Ichabœ Guano. (b) Riddled Guano—Products obtained from Sewage Sludge, Town Refuse, etc.—The Fertilisers and Feeding Stuff Act, 1906—Limits of Error—Analysis of Manures: 1. Determination of Moisture. 2. Determination of Nitrogen: Nitrogen in the Absence of Nitrates—Nitrogen when Nitrates are Present—Nitrogen in the Form of Ammonium Salts—Nitrogen in Nitrates in the Absence of Ammonium Salts and of Organic Nitrogen—Control Experiments in the Determination of Nitrogen. 3. Determination of Phosphates: Phosphates Soluble in Water—Phosphates Soluble in the Prescribed Citric Acid Solution—Total Phosphoric Acid—Molybdate Method—Preparation of Molybdic Acid Solution—Preparation of Magnesia Mixture—Preparation of Ammonia Solutions. 4. Determination of Potash: Muriate of Potash Free from Sulphates—Salts of Potash Containing Sulphates—Potash in Guanos and Mixed Fertilisers—Forms of Certificates . . . . .	40



## SECTION LV

## THE INDUSTRY OF ALUMINIUM COMPOUNDS

By GEOFFREY MARTIN, Ph.D., D.Sc.

	PAGE
Literature—Manufacture of Aluminium Hydroxide and Alumina—The Dry Process—The Wet Process - - - - -	49
Manufacture of Alumina and Aluminium Hydroxide from Cryolite—Cryolite—Manufacture of Alumina from Aluminium Nitride—Properties and Use of Aluminium Hydroxide and Alumina—Anhydrous Alumina—Fused Alumina as a Grinding Agent—Alumina in the Manufacture of Artificial Rubies and Sapphires—Use of Bauxite, Kaolin, and Cryolite in the Manufacture of Aluminium Sulphate—Manufacture from Bauxite - - - - -	51
Manufacture of Aluminium Sulphate from China Clay—White Sulphate of Alumina—Properties of Aluminium Sulphate—Use of Bauxite, Alunite, and Cryolite in the Manufacture of Alum—Alunite, Alumstone—Manufacture of Alum from Bauxite or Kaolin—Properties of Potassium Alum—Ammonium Alum—Ammonium Iron Alum—Potassium Chrome Alum - - - - -	54
Some other Salts of Alumina—Aluminium Acetate—Aluminium Chloride—Solid Sodium Aluminate—Technical Uses of Salts of Alumina—Mordants—Sizing Paper—Waterproofing and Fireproofing—Aluminium Soaps—Alum and Aluminium Sulphate - - - - -	56

## SECTION LVI

## THE ARTIFICIAL ZEOLITE OR PERMUTITE INDUSTRY

By GEOFFREY MARTIN, Ph.D., D.Sc.

Literature—Manufacture—Removal of Calcium and Magnesium Salts from Water—Removal of Sodium and Potassium Salts from Water—Removal of Iron and Manganese from Water—Removal of Free Alkali from Water—Preparation of Salts of Different Bases by Exchange—Precipitation of Gold from Solution -	59
--	----

## SECTION LVII

## THE ARTIFICIAL GEM INDUSTRY

By GEOFFREY MARTIN, Ph.D., D.Sc.

Literature—Composition of the Principal Precious Stones—Artificial Turquoises—Reconstituted Rubies—Genuine Rubies—White Sapphires—Blue Spinel—Blue Sapphires - - - - -	63
--	----

## SECTION LVIII

ALUMINIUM-THERMICS:  
"Thermit" and its Applications

By H. STANLEY REDGROVE, B.Sc. (Lond.), F.C.S.

Literature—Uses of "Thermit" Slag—Technological Preparation of Metals and Alloys by the "Goldschmidt" Reaction—Uses of "Thermit" as a Heating Agent—Uses of "Thermit" as a Heating Agent and Source of Molten Steel - - -	67
---	----

## SECTION LIX

## THE CALCAREOUS CEMENTS INDUSTRY

By ERNEST A. DANCASTER, B.Sc. (Lond.)

	PAGE
Literature—Nature and Composition of Lime and Cement - - - -	77
<b>Common Lime</b> —Properties and Manufacture—Marble—Limestone—Chalk— Other Sources of Lime—Lime Burning—Kilns - - - -	78
<b>Hydraulic Lime</b> —Chaux de Theil—Grappier Cements or Ciment Grappier— Scott's Selenitic Cement - - - -	82
<b>Puzzuolanic and Slag Cements</b> —Composition—Granulating the Slag—Drying the Slag—Ruggles-Coles Drier—Mixing and Grinding—Passov's Slag Cement— Snelus' Process of Preparing Cement—Iron Portland Cement—Puzzuolana -	83
<b>Natural Cements</b> —Parker's Cement—Roman Cement—Medina Cement— Continental Natural Cements—American Natural Cements—Rosendale Cement —Louisville Cement - - - -	85
<b>Portland Cement</b> —First Made by Joseph Aspdin—Mixing the Raw Materials— The Wet Process—The Semi-Wet Process—Ball Mills—Scoop Wheel or Belt Elevator—Tube Mills—Margett's Process—Clarke's Mill—Mixers—Ram Pumps— The Dry Process—Crushing—Blake's Stonebreaker—Blake-Marsden "Friction- less Lever" Crusher—Wheeler Forced Feed Crusher—Hadfield's Gyratory Crusher—Drying the Raw Materials—Grinding—Edge-Runners—Bar Disin- tegrators—Jeffrey Pulveriser—Abbé Ball Mill—Krupp Ball Mill—Kominor Mill —Molitor Ball and Ball-Tube Mill—Krupp's Pregrit Mill—Griffin Mill—Bradley Three-Roll Mill—Kent Mill—Maxecon Mill—Sturtevant Ring-Roller Mill— Fuller Lehigh Mill—Davidsen, Krupp, and Polysius Tube Mills—Lenix Drive— Compound Mills—Löhnert's Compound Mill—Solo Mill—President Dry Press— Eggett Moulding Machine—Burning to Clinkers - - - -	87
<b>The Rotary Kiln</b> —Construction—Kiln Hood—Fuel—The Cooler—Smidth and Mosser Coolers—Shaking Coolers - - - -	99
<b>Stationary or Vertical Kilns</b> —Dome or Bottle Kiln—Johnson Kiln—Gibbons Kiln—Batchelor Kiln—Spackman's Kiln—Hoffman Ring Kiln—Continuous Stationary Kilns—Shaft Kilns—Stage Kilns—Dietzsch Kiln—Aalborg Kiln— Schneider Havenschild and Hotop Kilns—Storing and Grinding the Clinker— Storing and Packing the Finished Cement—Dust Collectors—Beth Dust Collector —Weighing Machines—Composition of Portland Cement—Magnesia in Cement —Analyses of Portland Cement—Various Formulas—Adulteration of Portland Cement—Action of Sea Water on Portland Cement—Physical Properties of Portland Cement—Iron-Ore Cement—Analysis—White Portland Cement— Super Cement—Sand Cement - - - -	103
<b>The Plaster Cements</b> —Prepared from Gypsum—Processes Employed in Manu- facture—Plaster of Paris and the Cement Plasters—Calcining in Kilns—The Dumesnil Kiln—Rotary Kilns—Mannheim Calciner—Cummer Rotary Calciner— Calcining in Kettles—Grinding—Retarders and Accelerators—Hardening Plaster —Flooring Plasters—Hard-Finish Plasters—Keene's Cement—Mack's Cement— Parian Cement - - - -	113
<b>Mortar, Concrete, Plaster, and Stucco</b> —Mortars—Cement Mortar—Concrete —Armoured or Reinforced Concrete—Plasters—Stucco—Staff - - - -	117
<b>Waterproofing Cement, Mortar, and Concrete</b> —Sylvester and Moyer Pro- cesses—"Ironite"—Super Cement - - - -	118
<b>Chemical Analysis of Limes and Cements</b> —Common and Hydraulic Limes— Portland Cement—Natural and Puzzuolanic or Slag Cements—Plaster of Paris -	119
<b>Physical and Mechanical Tests</b> —Specific Gravity—Fineness—Tensile Strength —Adie Testing Machine—Crushing Strength—Amsler and Laffon's Press— Setting Time—Tests—Tetmajor, Perin, and Marten's Apparatus—Nicol's Spisso- graph—Gary's Method—Quick Setting—Medium Setting—Slow Setting—Con- stancy of Volume and Soundness—Faija Test—Le Chatelier Test—Expansion -	120
<b>Microscopic Examination</b> —Constituents found in Cement Clinker: Alite, Belite, Celite, Felite - - - -	125

## SECTION LX

### SORREL CEMENT

By JAMES SHELTON, F.I.C.

	PAGE
Literature—Ingredients in Manufacture: Magnesite, Magnesium Chloride, and Carnallite—Magnesium Oxychloride—Artificial Marble . . . . .	127

## SECTION LXI

### ARTIFICIAL STONE

By JAMES SHELTON, F.I.C.

Literature—Process of Production—Concrete—Victoria Stone—Ward's Stone—Stuart's Granolithic Stone—Globe Granite—Non-Slip Stone—Clinker and Slag Blocks—Ford's Silicate of Lime Stone—Ransome's Artificial Stone—Plaster Cements—Marezzo Marble—Scagliola—Sorrel Cement—Reconstructed Stone—Moreau Marble—Lime-Sand Bricks—Blast Furnace Slag . . . . .	129
---	-----

## SECTION LXII

### SODIUM SILICATE, WATER-GLASS, SOLUBLE GLASS

By JAMES SHELTON, F.I.C.

Literature—Methods of Manufacture—Trade Names—Ransome's Artificial Stone—Uralite . . . . .	133
--	-----

## SECTION LXIII

### LUTES AND MISCELLANEOUS CEMENTS

By GEOFFREY MARTIN, Ph.D., D.Sc.

Cements to Resist Nitric and Sulphuric Acid—Lute Proof against Nitric and Hydrochloric Acid Vapours—Lutes for Chemical Retorts—Crucible Lutes—Crucible Cements—Cement for Furnaces—Cement to Resist White Heat—Water-glass, Zinc, and Pyrolusite Cement—A Joint which will Resist Great Heat—Non-conducting Cements for Covering Boilers and Steam-Pipes—Cement for Fixing Tiles into Fireplaces and Grates—Cement for Fixing Iron Bars into Stone—Cements for Seams and Joints of Stone Cisterns—Cement for Steam and Water Joints—Cement for Cisterns and Water Courses—Rust Iron Cement for Cast-Iron Cisterns—Enamel Glaze Cement for Coating Iron Pans—Cement for Marble—Keene's Marble Cement—Cements for Joining Metals and Wood—Cements for Joining Metals to Earthenware—Cements for Joining Metals to Glass—Turner's Cement—Cement for Plumbers—Cement for Joining Porcelain Heads to Metal Bars—Compositions Insoluble in Benzene and Petroleum—Joints which will Resist Benzene—Lute for Neck of Bottles with Glass Stoppers—Dental Cements . . . . .	135
---	-----

## SECTION LXIV

### CLAYS AND ALLIED MATERIALS

By ALFRED B. SEARLE

	PAGE
Literature—Occurrence—Chemical Constitution—Plasticity—Shrinkage—Impurities—Flux—Limestone—Sand—Metallic Oxides and Silicates - - -	139
<b>Clays of Commercial Importance</b> —Adobe Clay—Alluvial Clay—Alum Shales—Ball Clays—Boulder Clays—Brick Clays and Brick Earths—Cement Clays—Marl China Clay or Kaolin—Crucible Clays—Fireclays—Fuller's Earth—Ganister—Grog—Kaolinite—Loams—Pipeclay—Puddling Clay—Red-Burning Clays—Rubbers—Refractory Clays—Saggar Clays—Shales—Oil Shales—Alum Shales—Slates—Sails—Surface Clays—Tender Clays—Vitrifiable Clays—Yellow or Buff-Burning Clays - - - - -	144
<b>Analysis of Clays</b> - - - - -	149

## SECTION LXV

### POTTERY

By ALFRED B. SEARLE

Literature—Importance—The Classification of Pottery—Porous Pottery—Non-Porous Pottery—Unglazed Pottery—Terra-Cotta—Faience—Chinaware and Porcelain—Various Kinds of Porcelain—Stoneware—Physical Properties of Pottery—Manufacture of Pottery - - - - -	151
---	-----

## SECTION LXVI

### EARTHENWARE

By ALFRED B. SEARLE

Literature—Application of Term—Coarse Earthenware—Fine Earthenware—Calcareous Earthenware—Siliceous Earthenware—Constituents of Earthenware—Raw Materials—Fluxes or Glass-Forming Materials—Refractory Substances—Colouring Materials—Testing Raw Materials—Earthenware Bodies—Consistency—Methods of Shaping Ware—Modelling—Throwing—Turning—Moulding—Jolleying—Presses—Casting—Finishing—Slipping and Sticking Up—Engobing—Drying Earthenware—Shrinkage—Ovens - - - - -	157
<b>Setting or Placing</b> —Firing—Trials—Glazes—Fritting—Mixture of Frits—Mixture for Glaze - - - - -	175
<b>The Decoration of Earthenware</b> —Underglaze Painting—Overglaze Decoration	179
<b>Probable Progress</b> - - - - -	181

## SECTION LXVII

### PORCELAIN

By ALFRED B. SEARLE

Literature—Varieties of Porcelain—Raw Materials—Felspar—Cornish or China Stone—Quartz—Steatite—Chalk—Magnesite—Grog—Bone Ash—Porcelain Bodies—Glazes—Glassy Porcelains—Parian Ware—Belech Porcelain—Chinese and Japanese Porcelains—Preparation of Porcelain Bodies - - - - -	183
---	-----

## CONTENTS

xi

### SECTION LXVII.—*continued.*

	PAGE
Processes of Manufacture—Moulding, Throwing, and Casting—Firing— Decoration—Underglaze—Overglaze—Cracked Ware—Crystalline Glazes—Matt Glazes—Flowing Glazes—Rouge Flambé—Lustre Glazes . . . . .	186
<b>Artificial Teeth.</b> By GEOFFREY MARTIN, Ph.D., D.Sc.	
Literature—History—Manufacture . . . . .	191

## SECTION LXVIII

### STONEWARE AND SANITARY WARE

By ALFRED B. SEARLE

Literature—The Term "Stoneware"—Sanitary Ware—Fine Stoneware—Glazes —White Ware—Casting—Chemical and Culinary Stoneware—Drain Pipes— Glazed Pipes—Paving Blocks and Tiles—Testing . . . . .	193
---	-----

## SECTION LXIX

### BRICKS

By ALFRED B. SEARLE

Literature—Groups—Building Bricks—Facing Bricks—Common or Stock Bricks —Variations in Crushing Strength—Engineering Bricks—Refractory or Furnace Bricks—Paving Bricks—Glazed Bricks—Sand-Lime Bricks—Raw Materials— Impurities—Red Bricks—White Bricks—Buff Bricks—Preparation of Material— Cleaning Plant—Wash Mill—Crushing Rolls—Edge-Runner Mills—Tempering— Moulding—Expressing—Wire-Cut Process—Stiff Plastic Process—Semi-Dry Process—Drying—Burning—Kilns—"Clamp" Kiln—Archless Kiln—Single Kilns—Up-Draught Kilns—Down-Draught Kilns—Horizontal Kilns—Semi- Continuous Kilns—Hoffman Kiln—Use of Fan Instead of Chimney . . . . .	199
--	-----

## SECTION LXX

### LIME-SAND BRICKS

By JAMES SHELTON, F.I.C.

Literature—The Mixture for Lime-Sand Bricks . . . . .	223
---	-----

## SECTION LXXI

### TILES

By ALFRED B. SEARLE

Literature—Uses—Roofing Tiles—Paving Tiles—Glazed Tiles . . . . .	225
Architectural Terra-Cotta—Hollow Partition Blocks—Flooring Blocks . . . . .	226

## SECTION LXXII

## FURNACE LININGS AND OTHER REFRACTORY MATERIALS

By ALFRED B. SEARLE

	PAGE
Literature—Raw Materials—Bricks for Gas Retorts—Glassmakers' Pots and Crucibles—Kilns—Silica Bricks—Basic Bricks—Neutral Bricks—Chromite Bricks—Bauxite Bricks	229

## SECTION LXXIII

## GLASS

By ALFRED B. SEARLE

Literature—Description of Glasses—Normal Glasses—Chemical Constitution of Glasses—Formulas—Properties of Glasses—Spun Glass—Chemical Properties—Water-Glass	235
<b>The Raw Materials used for Glass-Making</b> —Silica—Soda—Sodium Carbonate—Potash—Lime—Magnesia—Zinc Oxide—Boracic Acid—Phosphoric Acid—Arsenic and Antimonic acids—Barium Oxide—Alumina—Lead Oxide—Cullet—Decolorants—Red Lead and Nitre—Nickel Compounds—Selenium Compounds—Colouring Agents	247
<b>Technical Classification of Glasses</b> —Crown Glasses—Bohemian Glasses—Flint Glasses—Bottle Glasses—Boro-Silicate Crown Glasses—Boro-Silicate Flint Glasses—Phosphate Glasses—Silica-Free Glasses—Water-Glass—Opaque and Coloured Glasses—Hollow Ware—Bottle Glass—Bead Glass	251
<b>Mixing and Preparing the Glass</b> —Proportions—Loss in Form of Scum—Various Recipes	252
<b>Glass-Working</b> —Methods Employed—Blowing—Casting—Rolling—Pressing—The Brühler Machine—Making of Plate or Sheet Glass—Patent Plate—Casting of Glass—Reinforced Glass—Figured Plate—Pressing—Annealing—Hardened Glass—Bending or Cutting—Ground Glass—Engraving—Cameos—Etching and Embossing—Frosting—Iridescent Glass	255
<b>Mirrors</b> —Mercury Mirrors—Silver Mirrors	263
<b>Optical Glass</b> —Production and Working of Optical Glass—Qualities Desired in Optical Glasses—Manufacture	263
<b>Special Glasses</b> —For Chemical Purposes—Steam Boiler Gauges—Lamp and Gas-Burner Chimneys—Transparent to Selected Rays—Electrical Insulation—Thermometers—Artificial Gems	265
<b>Defects in Glasses</b> —Decay—Defects: Glasses which have been Badly Manipulated—Glasses which have Decayed by Exposure to Unsuitable Conditions—Glasses of Defective Composition	266
<b>Opaque and Coloured Glasses</b> —Porpora Glass—Copper Ruby Glass—Aventurine Glass—Methods of Colouring Glass—Green Glass—Blue Glass—Violet Glass—Brown Glass—Yellow Glass—Black Glass—Pinkish Shades—Red Glass—Silver Stain—White Opaque Glass—Gilded Glass—Use of Coloured Glasses—New Use for Coloured Glass	266
<b>Quartz Glass or Fused Silica Glass</b> —Literature—Composition of Fused Silica—Shenstone's Process—Heraeus Process—Vitreosil—Voleker's Process—Process of the Silica Syndicate	270

## SECTION LXXIV

## ENAMELS

By ALFRED B. SEARLE

	PAGE
Literature—Use of Term—Vegetable Enamels—Paint Enamels—Glassy Enamels—Glazes—True Enamels—Mode of Manufacture—Materials Used in Enamelling—Ground Coats—Art Enamels . . . . .	275

## SECTION LXXV

## THE ASBESTOS INDUSTRY

By F. W. PENNY, B.Sc., F.G.S.

Literature—Definition . . . . .	281
Amphibole Asbestos—Tremolite and Actinolite—Anthophyllite—Crocidolite . . . . .	281
Serpentine Asbestos—Occurrence—Preparation—Properties . . . . .	282
Uses of Asbestos . . . . .	284

## SECTION LXXVI

## THE MICA INDUSTRY

By F. W. PENNY, B.Sc., F.G.S.

Literature—Occurrence—Species of Mica : Muscovite—Phlogopite—Lepidolite—Manufacture—Uses—Production—Value . . . . .	528
---	-----

## SECTION LXXVII

## THE THORIUM AND CERIUM INDUSTRY

INCLUDING THE MANUFACTURE OF INCANDESCENT MANTLES AND  
PYROPHORIC ALLOYS

By SYDNEY J. JOHNSTONE, B.Sc.

Thorium—Occurrence—Monazite Sand—Preparation of the Sand for Export—Thorianite and Thorite—Commercial Valuation of Thorium Minerals—Production—Analysis of Thorium Minerals—Manufacture of Thorium Nitrate—Testing of Thorium Nitrate—Manufacture of Incandescent Gas Mantles—Testing the Mantles—Production—Minor Uses of Thorium Compounds—Patent Literature—Cerium, Lanthanum, and Didymium—Pyrophoric Alloys—Other Uses of the Cerium Metals—Cerium Nitrate—Minor Uses of the Cerium Earths and their Salts—Estimation of the Cerium in Minerals . . . . .	291
--	-----

## SECTION LXXVIII

## TITANIUM

By SYDNEY J. JOHNSTONE, B.Sc.

	PAGE
Occurrence—Geographical Distribution of Titanium Ores—Commercial Value of Titanium Minerals—Statistics of Production—Utilisation—Ferro-Alloys—Non-Ferrous Alloys—Metallic Titanium—Titanium Salts—Use of Titanium Compounds as Illuminants—Analysis of Titanium Minerals and Salts . . . . .	323

## SECTION LXXIX

## ZIRCONIUM

By SYDNEY J. JOHNSTONE, B.Sc.

Occurrence—Preparation of Ores before Use—Industrial Utilisation of Zirconium Compounds—Metallic Zirconium—Ferro-Zirconium—Zirconia-Quartz Wire—Zirconium Carbide—Pigments—Illuminants—Commercial Value of Zirconium Ores—Statistics of Production—Estimation of Zirconium in Minerals . . . . .	331
--	-----

## SECTION LXXX

## TANTALUM AND NIOBIUM

By SYDNEY J. JOHNSTONE, B.Sc.

Occurrence—Composition of Typical Tantalum Ores—Commercial Valuation—Manufacture of Metallic Tantalum—Properties of Metallic Tantalum—Uses of Metallic Tantalum—Tantalum Alloys—Niobium—Properties—Estimation of Tantalum and Niobium in Minerals . . . . .	337
---	-----

## SECTION LXXXI

## TUNGSTEN

By SYDNEY J. JOHNSTONE, B.Sc.

Occurrence—Geographical Distribution of Tungsten Ores—Concentration of Ore—Production—Commercial Value of Ores—Manufacture of Metallic Tungsten and its Salts—Preparation of Metallic Tungsten—Cost of Production—Ferro-Tungsten—Ductile Tungsten—Properties of Metallic Tungsten—Utilisation of Metallic Tungsten and its Salts—Tungsten Steel—Bronze Powders—Estimation of Tungsten in Ores, etc. . . . .	343
---	-----

## SECTION LXXXII

THE INCANDESCENT ELECTRIC GLOW  
LAMP INDUSTRY

By SYDNEY J. JOHNSTONE, B.Sc.

Incandescent Electric Glow Lamps—Manufacture of Carbon Filament Lamps—Metallic Filament Lamps—The Tantalum Lamp—The Tungsten Lamp—Process of Making Tungsten Filaments—Colloidal Tungsten Filaments—Drawn Wire Filaments—Tungsten Alloy Filaments—Nitrogen-Filled Lamps—Cost of Production of Metallic Filament Lamps—Efficiency of Metallic Filament Lamps—Patent Literature . . . . .	351
---	-----



SECTION LXXXIII

URANIUM

By SYDNEY J. JOHNSTONE, B.Sc.

Natural Occurrence—Geographical Distribution of Uranium Ores—Production—Commercial Value of Ores—Composition of Ores—Treatment of Ores—Utilisation of Uranium and its Salts—Analysis of Uranium Minerals and Alloys	PAGE 369
---	-------------

SECTION LXXXIV

VANADIUM

By SYDNEY J. JOHNSTONE, B.Sc.

Natural Occurrence—Composition of Ores—Geographical Distribution of Vanadium Ores—Production—Extraction Processes—Vanadic Acid—Metallic Vanadium—Ferro-Vanadium—Utilisation of Vanadium and its Salts—Analysis of Vanadium Ores and Alloys	PAGE 375
--	-------------

SECTION LXXXV

THE INDUSTRY OF RADIOACTIVE SUBSTANCES

By ALEXANDER S. RUSSELL, M.A., D.Sc.

Introduction—Radioactive Elements—Characteristic Constants—The Uranium Series—The Actinium Series—The Thorium Series—Radioactive Bodies of Technical Importance—Sources of Uranium—The Manufacture of Radium—The Separation of Ionium, Radio Lead, and of Polonium—The Separation of Mesothorium and Radio-Thorium from Thorium Minerals—Methods of Testing the Strength of Radioactive Bodies—Uses of Radioactive Substances in Medicine and in General—The Prices of Materials—Output of Radium Compounds	PAGE 383
---	-------------

SECTION LXXXVI

ELECTRIC FURNACE PRODUCTS INDUSTRY

By H. D. K. DREW, B.Sc. (Lond.).

Literature	399
Carborundum—Manufacture—Properties—Uses of Carborundum—Statistics—Silundum Articles—Siloxicon—Monox	400
Manufactured Graphite—Occurrence and Mode of Formation—Graphite Powder—Uses—The Graphitising of Electrodes	404
Alundum—Silicon—Properties	406
Ferro-Silicon—Manufacture—Furnaces—Properties—Uses—Storage and Transport—Statistics	407
Calcium Carbide—Raw Materials—Electric Furnaces Used—Properties and Uses—Acetylene Gas—Calcium Cyanamide—Nitrolim—Statistics	409

## SECTION LXXXVII

### GRINDING AND POLISHING MATERIALS

By ALFRED B. SEARLE

	PAGE
Literature—Abrasive Nature of Grinding Materials—Hard Mineral Abrasives—Mild Mineral Abrasives—Waxy Polishes—Mill Stones—Grinding Wheel—Sizes of Grain in the Abrasive—Table giving Grade and Grain for Different Classes of Work—Hard Abrasive Powders—Diamonds—Carborundum—Corundum—Corubin—Emery—Electrite—Sand—Crushed Steel—Chalk—Lime—Rouge—Tripoli Powder or Rotten Stone—Kieselguhr—Pumice Stone—Polishes—Metal Polishes—Furniture Polishes—French Polish—Boot and Shoe Polishes—Boot Blackings—Stove Polishes—Mechanical Methods of Polishing	413

## SECTION LXXXVIII

### PHOSPHORUS

By C. AINSWORTH MITCHELL, B.A. (Oxon.), F.I.C.

History—Process of Manufacture—Readman and Parker's Process—Neumann's Process—Harding's Process—Properties—Allotropic Modifications of Phosphorus—Red Phosphorus—Hittorf's Black Phosphorus—Pyromorphic Phosphorus—Schenk's Scarlet Phosphorus—Totenhaupt Modification	423
--	-----

## SECTION LXXXIX

### MATCHES

By C. AINSWORTH MITCHELL, B.A. (Oxon.), F.I.C.

Literature—"Friction Lights"—"Lucifer" Matches—Typical Specimens of Early Matches—Early Phosphorus Matches—First Safety Matches—Composition of White Phosphorus Matches—Safety Match Compositions—Ichtenhäuser's Formula—After-Glowing—Prohibition of White Phosphorus Matches—"Double-Dip" Matches—Substitutes for White Phosphorus	429
Use of Phosphorus Sulphides—French State Matches	431
Statistics—Exports and Imports of British Matches	431
<b>COMPLETE INDEX TO VOLS. I. AND II.</b>	<b>433</b>

# INDUSTRIAL & MANUFACTURING CHEMISTRY

## (INORGANIC)

### SECTION LII DISINFECTANTS AND ANTISEPTICS

BY GEOFFREY MARTIN, D.Sc., Ph.D.

#### LITERATURE

- S. RIDEAL.—“Disinfection.” London, 1903.  
— Art. “Disinfectants” in Thorpe’s “Dictionary of Applied Chemistry” (1912). See also references in text.
- M. CHRISTIAN.—“Disinfection and Disinfectants.” London, 1913.
- R. GRASSBERGER.—“Die Desinfektion.” Leipzig, 1913.
- H. BOCQUILLON-LIMOUSIN.—“Formulaire de l’antisepsie, de la Desinfection, et de la Stérilisation.” Paris, 1905.
- ROSENAU.—“Disinfection.” London, 1903.
- F. W. ANDREWS.—“Lessons in Disinfection.” London, 1903.
- F. CRONER.—“Lehrbuch der Desinfection.” Leipzig, 1913.

**Disinfectants** are germicides; that is to say, they kill bacteria and other lower organisms which injuriously affect the upper forms of life.

After disinfection usually there remains a residue of harmless, highly resistant organisms, which often act beneficially by consuming injurious organic matter and organisms. In practice a complete annihilation of all organisms would be difficult to attain economically.

**Antiseptics** are less powerful than disinfectants in that they only retard or prevent the growth of injurious lower organisms in suitable media.

The **germicidal power** and the **antiseptic power** of a material are not always simply related. For example, guaiacol has only 0.9 the germicidal value of phenol, whereas it is two and a half times as effective as an antiseptic, *e.g.*, it takes two and a half times as much phenol as guaiacol to stop an organism developing in a broth (antiseptic action), whereas when it comes to killing an already existing organism 0.9 part of phenol has the same action as 1 part of guaiacol (germicidal action).

**Testing Disinfectants.**—The test usually employed for comparing the germicidal action of disinfectants is that introduced by Rideal and Walker (*Journ. Roy. San. Inst.*, 1903, p. 424).

In this test the standard disinfectant is pure phenol (carbolic acid),  $C_6H_5OH$ , and the power of a disinfectant is expressed numerically in multiples of the amount of pure phenol which will achieve the same germicidal result. This multiple is called “the Rideal-Walker carbolic acid coefficient,” or “germicidal value” of the disinfectant.

To give an example, if a disinfectant has a "carbolic acid coefficient" of 10, it means that the disinfectant acts ten times more powerfully than phenol; in other words, 1 part of disinfectant will act with the same power as 10 parts of phenol.

The Rideal-Walker test is usually applied as follows:—

The disinfectant is dissolved in sterile distilled water, several different concentrations being made, e.g., 1 g. disinfectant to 500 c.c. water, 1 : 550, 1 : 600, 1 : 700, etc.

Next 5 drops of a twenty-nine hours' blood-heat culture in broth of an organism is added to 5 c.c. of each of the diluted solutions of disinfectant, and subcultures are taken with a platinum loop from each solution each two and a-half minutes up to fifteen minutes. Each subculture is incubated at 37° C. for forty-eight hours, and it is noted whether the culture lives (denoted by +) or is dead (denoted by -).

A similar experiment is carried out with a solution of phenol of known strength, and the results are compared.

The following results are typical:—

Dilution of Disinfectant.	Time the Disinfectant has Acted on Culture before Making the Sub-Incubation.	Result on Culture.
1 : 500 - - -	2½ minutes	alive (+)
	5 " "	dead (-)
	7½ " "	" (-)
	10 " "	" (-)
	12½ " "	" (-)
	15 " "	" (-)
1 : 550 - - -	2½ " "	alive (+)
	5 " "	" (+)
	7½ " "	dead (-)
	10 " "	" (-)
	12½ " "	" (-)
	15 " "	" (-)
1 : 600 - - -	2½ " "	alive (+)
	5 " "	" (+)
	7½ " "	" (+)
	10 " "	dead (-)
	12½ " "	" (-)
	15 " "	" (-)
1 : 700 - - -	2½ " "	alive (+)
	5 " "	" (+)
	7½ " "	" (+)
	10 " "	" (+)
	12½ " "	" (+)
	15 " "	dead (-)
Phenol solution, 1 : 100	2½ " "	alive (+)
	5 " "	" (+)
	7½ " "	" (+)
	10 " "	dead (-)
	12½ " "	" (-)
	15 " "	" (-)

Comparing these results<sup>1</sup> it will be seen that the disinfectant, diluted 1:600, acts with the same power as a phenol solution of dilution 1:100.

Hence the "carbolic acid coefficient" or "germicidal value" of the disinfectant is  $\frac{600}{100} = 6$ , *i.e.*, 1 part of disinfectant will do the work of 6 parts of phenol.

The following shows the germicidal value (Rideal-Walker carbolic acid coefficient) of various disinfectants towards *B. typhosus* :--

<i>Disinfectant.</i>	<i>(Rideal-Walker Coefficient) Germicidal Value.</i>
Mercuric chloride - - -	400-3,000
Hypochlorites (calculated on available chlorine) -	146-220
Iodine water - - - -	100
Iodine trichloride - - - -	94
Bromine water - - - -	64
Potassium permanganate - - - -	42
Chlorine water - - - -	28
Silver nitrate - - - -	16
Formic acid - - - -	5.7
Benzoic acid - - - -	5.0
Sodium bisulphate - - - -	4.1
Cresylic acid - - - -	3.7
Copper sulphate (calculated as CuSO <sub>4</sub> ) - - -	2.0
Lactic acid - - - -	1.8
Hydrochloric acid - - - -	1.6
Eucalyptol - - - -	1.2
Guaiacol - - - -	0.9
Acetic acid - - - -	0.6
Formaldehyde - - - -	0.5-0.7
Resorcin - - - -	0.3
Chinosol - - - -	0.15-0.30
Pyrogallic acid - - - -	0.2
Zinc chloride - - - -	0.15
Boric acid - - - -	<0.1
Alcohol (absolute) - - - -	<0.1

<sup>1</sup> Rideal and Walker very concisely express these results as follows :--

Disinfectant Dilution.	Minutes.					
	2½	5	7½	10	12½	15
1:500 - - -	+	-	-	-	-	-
1:550 - - -	+	+	-	-	-	-
1:600 - - -	+	+	+	-	-	-
1:700 - - -	+	+	+	+	+	-
Phenol, 1:100 -	+	+	+	+	-	-

## PART I.—ORGANIC DISINFECTANTS AND ANTISEPTICS

**Coal Tar Fluids.**—These consist of dark, thick fluids, smelling of coal tar, and containing phenolic bodies or their sodium or potassium salts mixed with soaps, resins, etc.

*Water-Soluble Solutions* are achieved by converting the phenols into their sodium or potassium salts.

For example, a well-known mixture consists of crude creosol, 1 part; potassium soap, 1 part; which are heated together with stirring; often alcohol or glycerol is added to such mixtures to increase the solubility in water.

Recently linseed and other oils have been sulphonated, cresylic acids then mixed into the liquid, and caustic soda or potash added in sufficient amount to obtain a water-soluble neutral solution.

The liquids which yield **emulsions** with water consist of nearly insoluble cresylic and other phenolic acids, mixed with soaps, resins, oils, gelatine and soda.

The cresylic acids and similar homologues of phenol are much less soluble and much less poisonous to man than free phenol, and at the same time have a higher germicidal value (see list above). Consequently, most of the commercial coal tar disinfectant fluids are now practically free from phenol, and are practically non-poisonous. The Privy Council Orders of 1900 and 1902 prohibit the uncontrolled sale of liquors containing more than 3 per cent. phenol or its homologues.

**Guaiacol** (methyl-catechol,  $C_6H_4(OH)(OCH_3)$ ) and **creosol** (methyl-guaiacol,  $C_6H_4(OCH_3)_2$ ) are contained in wood creosotes, and form the basis of disinfectants and antiseptics much used in the treatment of tuberculosis.

The germicidal value (Rideal-Walker coefficient) of guaiacol is only 0.9 that of phenol, whereas its antiseptic power (*i.e.*, power of preventing the growth of bacteria) is stated to be 2.5 times that of phenol. A 1 per cent. solution kills *B. tuberculosis* in two hours.

OH

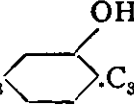
**Thymol** ( $CH_3$    $.C_3H_7$ ), present in oil of thyme, in saturated solution (0.3 per cent.) arrests putrefaction.

**Resorcinol** (m-dihydroxybenzene,  $m-C_6H_4(OH)_2$ ), **catechol** (o-dihydroxybenzene,  $o-C_6H_4(OH)_2$ ) and **hydroquinone** (quinol, p-dihydroxybenzene,  $p-C_6H_4(OH)_2$ ) and **pyrogallol**,  $C_6H_3(OH)_3$ , are all powerful medicinal antiseptics.

A 1 per cent. solution of resorcinol is very effective. A 9 per cent. solution is sold as "Aundeer's lotion." Bismuth iodo-resorcin sulphonate is sold under the name of "anusol."

**Pyrogallol** ( $C_6H_3(OH)_3$ ) is an effective bactericide in a 3 per cent. solution. It is, however, poisonous and quickly oxidises.

The antiseptic values of these phenols may be taken as hydroquinone 30, resorcinol 25, catechol 20, pyrogallol 15, phenol being taken as 20.

The Rideal-Walker carbolic acid coefficient of **resorcinol** is 0.30, of **catechol** is 0.25, and of **pyrogallol** is 0.22.

**Beta-naphthol** ( $C_{10}H_7(OH)$ ) is much used for internal disinfection, the usual dose being 3-10 grains.

A solution of 0.5-1.0 per cent. of B-naphthol dissolved in alkaline carbonate solution kills typhoid germs in a short time. The free B-naphthol has a greater germicidal action than its alkaline salts.

B-naphthol, up to 10-15 per cent., is much used in ointments in certain skin diseases. Certain derivatives of B-naphthol are very powerful disinfectants. Among these may be mentioned the non-poisonous and odourless **halogen substituted naphthols**. For example, **tribromonaphthol** ( $C_{10}H_4Br_3(OH)$ ) in dilutions of 1 : 250,000 has a decided germicidal action.

The halogen substituted naphthols are, next to mercuric chloride, the most powerful disinfectants.

The easily soluble calcium or aluminium salts of B-naphthol sulphate are in the market under such names as "abrastol," "alumnol," etc.

A dilution of 1 : 250 will inhibit the growth of pus cocci and similar bacteria.

Various essential oils have a distinct antiseptic value. Oil of eucalyptus (Rideal-Walker coefficient 1.2) and pinol are widely used. Sanitas owes its disinfecting powers to the slow oxidation of certain essential oils, whereby ozone is generated, reabsorbed, and the oil regenerated (see British Patent, 274, 1876).

Benzoic acid ( $C_6H_5.COOH$ ), and salts thereof, are powerful antiseptics. 1 part dissolved in 400 of water kills *B. typhosus* in three or four minutes, 0.022 per cent. benzoic acid in milk retards souring, 0.26 per cent. sodium benzoate and 0.29 per cent. potassium benzoate having an equal value. Rideal-Walker coefficient is 5.0.

Benzoic acid and benzoates are not poisonous, 0.5 grain per day in food leaving no injurious effect on man. Hence the use of benzoic acid and benzoates in food-preservation; their taste and smell, however, tend to flavour the goods.

Salicylic acid ( $O-C_6H_4(OH).COOH$ ) is widely used as an antiseptic. It is only sparingly soluble in water (1 : 500), and at this dilution it takes three hours to kill *B. typhosus*.

Its food-preservative value is about that of benzoic acid. Moulds and ferments are inhibited by 0.1 per cent., smaller quantities than this being inefficient.

Salol (phenyl-salicylate,  $C_6H_4.OH.COOC_6H_5$ ) is used as an internal antiseptic, being hydrolysed when in the intestines into phenol and salicylic acid.

Salophen is p-aminophenyl acetyl salicylate; it has a stronger antiseptic action than salol.

Acetic acid, propionic acid, tartaric and citric acid have all a distinct preservative power towards certain bacteria.

A 5 per cent. solution of acetic acid was found by Rideal to kill *B. coli* in five minutes; a 2.5 per cent. solution killed it in fifteen minutes, while the bacteria were unaffected after forty minutes by 0.5 per cent. solution. The Rideal-Walker coefficient for acetic acid is 0.6. Cholera germs are stated to be killed by 0.08 per cent. solutions of citric acid, and typhoid germs by 0.1 per cent.

Citric and tartaric acid solutions, however, soon go mouldy in warm weather.

Lactic acid has considerable disinfecting and germicidal value, having a Rideal-Walker coefficient of 1.8. It is much used in various fermentation industries as an antiseptic.

Formic acid ( $HCOOH$ ) is a powerful antiseptic and germicide, the Rideal-Walker coefficient being 5.7.

According to Rideal a 0.5 per cent. aqueous solution will kill *B. typhosus* in fifteen minutes, and 0.1 per cent. solution will kill this organism in thirty minutes, and will inhibit the growth of mould. Formic acid, however, is less efficient than formaldehyde in destroying spores. The salts of formic acid are not effective disinfectants.

Formaldehyde ( $H.CHO$ ) is sold as an antiseptic as a 40 per cent. solution under the name "formalin." The Rideal-Walker coefficient is 0.55. A solution of 1.5 per cent. formaldehyde (3 pints formalin in 10 galls. of water) will keep fruit immersed therein for ten minutes for ten to twenty-one days longer than when untreated. 1 part formaldehyde in 50,000 water (1 part formalin to 20,000 water) will keep milk from souring for twenty-four hours without injury to health. 1 part formalin to 10 parts water is used for preserving bodies for dissection, etc. 0.003-0.03 per cent. stops the development of bacteria; 0.007-0.060 stops the development of yeasts; while moulds are inhibited by 0.03-0.125 per cent. Soft potassium soaps impregnated with formalin are much used in operations for instrument and hand disinfection.

Formaldehyde in small amount is present in smoked fish and bacon (1 : 10,000 to 1 : 100,000 of weight of goods) and is one of the agents which effect preservation of smoked provisions,

**Paraformaldehyde, paraform, triformal**  $(\text{CH}_2\text{O})_n$ , is a solid polymer of formaldehyde. It dissociates when heated into gaseous formaldehyde. It is only slightly soluble in water. It is used for disinfecting instruments, also as an internal disinfectant. It is also widely used as a means of generating gaseous formaldehyde for disinfecting rooms, etc.

Mixtures of paraformaldehydes and peroxides of sodium, or barium, form formaldehyde and hydrogen peroxide, a powerful disinfecting agent.

**Iodine cyanide (ICN)** is fatal to all lower forms of life, and its use as a preservative for biological specimens has been suggested by Kobert.

**Iodoform**  $(\text{CHI}_3)$  is a powerful antiseptic, formerly much used in surgery, although it is stated to be less efficient than a dilute solution of iodine.

**Carbon tetrachloride**  $(\text{CCl}_4)$  kills typhoid germs, but **chloroform**  $(\text{CHCl}_3)$  vapour does not, although the latter is efficient in aqueous solutions (0.62 per cent. solution takes thirty minutes), and chloroform is frequently employed for preserving specimens and infusions.

**Other Organic Substitution Compounds of Chlorine, Bromine, and Iodine.**—Most of these have a high antiseptic value. For details, see *Bechhold, Zeitsch. Hyg. Infect.*, 1909, 64, 113.

**Saccharin** (Benzoyl-sulphonic-imide) has some preservative power, and is non-fermentable. It has been used medicinally, and is a preservative. See *Martin's "Industrial Chemistry: Organic,"* under **Sweetening Chemicals**.

**Hexamethylene tetramine**  $(\text{C}_6\text{H}_{12}\text{N}_4)$ , made by evaporating together ammonia and formaldehyde, has long been used as an antiseptic under the name "**urotropine**."

Hexamethylene tetramine forms the basis of a large number of antiseptic preparations.

## PART II.—INORGANIC DISINFECTANTS

### Oxidising Disinfectants

Ordinary oxygen  $(\text{O}_2)$  has a distinct germicidal value, especially in the presence of light. Its active modification, **ozone**  $(\text{O}_3)$ , is one of the most powerful disinfectants known.

According to Rideal, ozone in the proportion of 0.6 g. per cubic metre of water (*i.e.*, 6 lbs. per 1,000,000 galls.) destroys all dangerous bacteria in average filtered river water.

Ozone treatment effects a great improvement in the physical and chemical properties of the treated water, and leaves no injurious chemicals behind in the water.

Ozone treatment can only be applied to clean filtered water, *i.e.*, water free from much oxidisable matter, ferrous salts, etc., otherwise the consumption of ozone would be too great, this substance being rapidly destroyed by organic and oxidisable matter.

Ozone has also been used for improving the air of underground railways and the like.

Ozone is especially active towards micro-organisms when moist, less so when dry.

Ozone is absorbed by certain essential oils and confers on them oxidising and disinfecting properties. This is the basis of the well-known disinfectant "**Sanitas**" (see above).

Various other liquids absorb ozone and the resulting fluids are powerful oxidising agents. Thus according to the British Patent, 4,153, of 1902, acetaldehyde absorbs 2,800 vols. of ozone; a 10 per cent. solution of acetaldehyde in water absorbs 536 vols. of ozone.

Alcohol is stated to absorb 750 vols. and ether 800 vols., forming stable solutions which can be used in surgery for sterilising purposes.

It should be noted that many ozonides are explosive.



For further details regarding the use of ozone as a disinfectant see this work, Vol. I., under **Ozone** and also under **Water**.

**Hydrogen peroxide** ( $H_2O_2$ ) is a powerful germicide. In dilute solution it does not injure foods, and is non-poisonous. It does not destroy enzymes such as **diastase**, **pepsin**, **pancreatin**, **ptyalin**, although it attacks and destroys certain other enzymes, such as **catalase** (contained in malt, milk, yeast, etc.).

These properties make hydrogen peroxide very suitable as a preservative for milk and similar foods.

Rideal states that when milk is treated with 0.6 g.  $H_2O_2$  per litre and heated to  $52^{\circ}$ - $56^{\circ}$  C. for eight hours, the milk kept unchanged for four weeks in a closed receptacle, and was unchanged in physical properties. Thus the pasteurisation of milk is effected at a lower temperature in the presence of hydrogen peroxide.

One per cent. of hydrogen peroxide will destroy pathogenic bacteria in about twenty-four hours.

Hydrogen peroxide is largely used as a spray, gargle, and a dressing for wounds, also as an internal disinfectant.

It is sold under various names, such as **perhydrol** (30 per cent. solution giving off 100 vols. of oxygen); **dioxogen** (3 per cent.); "**peroxol**," "**pyrozone**," "**glycozone**"; all these contain hydrogen peroxides, sometimes mixed with other disinfectants.

A solution of hydrogen peroxide in ether, containing 1.2 per cent.  $H_2O_2$ , has been used in scarlet fever and whooping cough under the name "**ozonic ether**."

Ethereal solutions of hydrogen peroxide are more stable than aqueous solutions.

### Metallic Peroxides

Foregger and Philipp (*Journ. Soc. Chem. Ind.*, 1906, 298) state that **calcium peroxide** is better than hydrogen peroxide for sterilising milk, the effects being much more durable.

For sterilising water tablets of **magnesium peroxide** and citric acid have been used.

The citric acid on coming into contact with the water attacks the magnesium peroxide, liberating hydrogen peroxide. According to Park 0.2 g. of magnesium peroxide killed 2,000,000 typhoid organisms contained in 150 c.c. of water in one minute. 0.1 g. magnesium peroxide achieved the same result in thirty minutes. Magnesium peroxide is the main constituent of "**Hopogan**." Calcium peroxide and magnesium peroxide have been advocated as a constituent of tooth powders.

**Sodium peroxide** also generates oxygen or hydrogen peroxide, and has disinfecting properties. Unfortunately it yields a strongly alkaline solution.

**Zinc peroxide** also evolves oxygen and has powerful antiseptic properties. It has been sold under the names "**Dermogen**" and "**Ektogan**."

**Mercury peroxide** has antiseptic properties, and has been used as a constituent of ointments and similar preparations.

**Persulphates**, **percarbonates**, and **perborates** have recently been introduced as disinfectants (see this work, Vol. I., under **Oxidising Agents**).

**Permanganates** and **manganates** have long been used as disinfectants under the name of **Condy's Red** and **Green Fluids**.

Both the sodium and potassium salts have powerful disinfecting properties, but the sodium salt seems to be preferred.

They owe their germicidal action to their oxidising properties, and are rapidly reduced by oxidisable matter, yielding brown oxide of manganese. Consequently disinfection by permanganates can only be economically exercised in cases where there is, comparatively speaking, only small amounts of oxidisable matter present. The Rideal-Walker coefficient of potassium permanganate is 42.

The usual method of application is to add the permanganate until the water remains permanently pink, and for polluted waters the pink colour should persist for twenty-four hours. This process of disinfection has long been practised in India in cases of water suspected of carrying cholera germs,

## Chlorine and Hypochlorites

**Chlorine**, owing to its chemical properties, can act as a disinfectant by uniting with the hydrogen of water and liberating nascent oxygen, which then destroys the organisms. Chlorine also acts by directly attacking the organic matter, forming substituted compounds incapable of putrefying.

Chlorine acts as a direct poison towards bacteria. Chlorine water has a Rideal-Walker carbolic acid coefficient of 28.

Perhaps the most important disinfecting effect obtained by chlorine and also hypochlorites is an indirect one. The substitution compounds which they form with organic matter act themselves as powerful germicides.

According to Rideal (*Journ. Roy. San. Inst.*, 1910, 31, 2) these bodies are the chloroproteids, the chloramines, and hydrazine.

Rideal proved this by showing that although the Rideal-Walker carbolic acid coefficient is only 2.2 for 1 per cent. available chlorine, yet on adding one equivalent of ammonia the germicidal value increases to 6.4, and remains nearly at this level for over twenty-four hours. Since the germicidal value of ammonia by itself is only about 0.007, this enhanced germicidal effect must be due solely to the presence of **chloramine** ( $\text{NH}_2\text{Cl}$ ), a body which has a pungent odour like hypochlorous acid, and which gives the blue reaction with KI and starch. The chloramine unites with the excess of ammonia usually contained in sewage, forming **hydrazine** ( $\text{NH}_2\text{Cl} + \text{NH}_3 = \text{NH}_2\text{NH}_2 + \text{HCl}$ ), which has, in the form of free base, a Rideal-Walker coefficient of 24. Compound chloramines are formed when chlorine acts on nitrogenous compounds of a more complex type than ammonia, and these compounds are likewise poisonous to bacteria, tending to attack their cellulose envelopes.

The fact that chlorine in a free state is inconvenient to use, and that it acts much more powerfully when suitably combined, has caused the gas to be replaced by **hypochlorites**, which are cheap and efficient, and whose activity is measured by the amount of "available chlorine" that they contain. The Rideal-Walker coefficient of hypochlorites (calculated on "available chlorine") is 146-220. The chief hypochlorite used is "**chloride of lime**" or "**bleaching powder**" (*calx chlorinata*), which is prepared as described in this work, Vol. I., under **Bleaching Powder**. The active basis is **calcium hypochlorite**. Chloride of lime has the great advantage of being an easily transportable solid, and is very cheap; but it suffers from the serious disadvantages of being rapidly destroyed on exposure to moist air, takes a considerable time to pass into solution, and leaves behind a bulky residue of undissolved lime. Moreover, it leaves on the surfaces treated a layer of damp for a long time from the highly deliquescent calcium chloride. When applied for the purification of drinking water it imparts a bitter taste and increases its hardness. In spite of these disadvantages chloride of lime is very widely used for treating drinking water, especially in times of epidemics.

Thus at Maidstone in 1897, after an outbreak of typhoid fever, the infected reservoir and pipes were sterilised by the addition of 1 per cent. solution of chloride of lime. The ironwork was not corroded. At Cambridge in 1910 the addition of chloride of lime to the water supply in the proportion of 1 part of available chlorine to 4-8 million parts of water destroyed 66-98 per cent. of the bacteria, and totally destroyed all the *coli* bacteria.

In Jersey City, U.S.A., 40,000,000 galls. of water per day are treated with 0.2 part of available chlorine (in form of chloride of lime) per million parts of water, and the daily examination shows that *coli* is absent from 10 c.c. of the treated water.

At Antwerp 0.2 available chlorine per million is added to the storage reservoirs with a contact of twelve hours.

In disinfecting **sewages**, of course, a much larger amount of chloride of lime would be necessary. Instead of using pure chloride of lime, Duyck treats with 8 parts per million of ferric chloride and 0.5 part of chloride of lime. This clarifies the water. (Ferrochlore treatment.)

There is an increasing tendency to use **sodium hypochlorite** (for manufacture and properties see this work, Vol. I.). It has the advantage of tending to soften the water, and does not noticeably alter its flavour. Moreover, it does not (like chloride of lime) leave the treated surface damp for a long time afterwards owing to the presence of deliquescent salts.

Sodium hypochlorite solution is placed on the market as a disinfectant under several fancy names.

Thus "antiformin" contains sodium hypochlorite and caustic soda, and has been much used in breweries. "Chloros" is a solution of sodium hypochlorite containing 10 per cent. available chlorine. "Oxychloride" contains 10-12 per cent. available chlorine. The old "Eau de Javel" was potassium hypochlorite (made by chlorinating potassium hydroxide). Its place is now taken by the well-known "Eau de Labarraque," which is a chlorinated soda containing 2.5 per cent. available chlorine.

"Hermite Fluid" is a well-known fluid prepared by the electrolytic method, containing 4.5 per cent. available chlorine. It contains magnesia and also free hypochlorous acid, and has been successfully employed in several London districts.

Local disinfection can be achieved by sodium hypochlorite solutions containing 0.35 per cent. available chlorine, which will kill most organisms in a few minutes, and will destroy all pathogenic spores in the space of a couple of hours.

Clean filtered water, however, requires much less available chlorine to effect practical sterilisation. According to Rideal 0.75-1 part of available chlorine to each million parts of water destroys all harmful bacteria, and after the water has stood for a couple of hours its taste and odour are unchanged. Swimming baths are also best sterilised by sodium hypochlorite solution, which destroys surface growths and bacteria.

In the case of sewage, however, very much larger quantities of hypochlorite solution must be used in order to disinfect them. This is on account of the large amount of oxidisable matter. In fact, it is on this account uneconomical to directly disinfect sewage with hypochlorites. It is best to purify by other means (see disposal of sewage under **Water**, this work, Vol. I.), and finally use hypochlorite for imparting final sterilisation to the partially purified liquid.

In America it has been proved that treating sewage effluents with 2.5 parts per million of available chlorine applied as sodium hypochlorite will destroy about 97 per cent. of all bacteria in about two hours. Rideal states that 3 parts per million of available chlorine applied to partially purified effluents will reduce the bacterial contents to about 20 per 100 c.c. of liquid, while 17 parts per million of available chlorine completely destroyed all organisms in about fifteen minutes.

Raw sewage, however, required for complete sterilisation about 30-70 parts of available chlorine per million parts water, and a contact period of between four and five hours (see Rideal, *Journ. Roy. San. Inst.*, 1905, 26, 7; 1906, p. 556; *Trans. Farad. Soc.*, 1909, 4, 3. See also U.S. Dept. of Agriculture, Bull. 115, Oct. 1907; Royal Commission on Sewage, Appendix IV., 1910, pp. 84-171; Rep., 1908, 195-201).

From these results it will be seen that time is an essential factor in causing efficient sterilisation. A small amount of disinfectant acting for several hours will cause almost complete sterilisation, whereas to achieve the same results in a few minutes requires a large proportion of disinfectant, and (except in the case of ozone and hydrogen peroxide) leaves behind in the treated water considerable amounts of residual chemicals, which affect the palatability and odour of the water.

*Removal of Chlorine.*—In order to remove chlorine from drinking waters sterilised thereby, it is either treated with metallic iron (Thresh, British Patent, 3,023, of 1909) or else filtered through coke (Candy, British Patent, 4,212, of 1909). In order to detect free chlorine in drinking water sterilised by hypochlorites, Le Roy (*Compt. rend.*, 1916, 163, 226-228) suggests the use of hexamethyltrip-aminotriphenylmethane, the reagent being prepared by dissolving 1 g. of the free base in 10 c.c. of cold hydrochloric acid, diluted with its own volume of water, and then making the solution up to 100 c.c. with distilled water. A few c.c. of this reagent added to 1 litre of water gives an immediate violet coloration if free chlorine is present. The reagent is sensitive to 3 parts of available chlorine in 100,000,000 of water.

The usual method of detecting the presence of available chlorine in water is to add to the suspected liquid a solution of potassium iodide and starch, when a blue colour develops.

### Bromine and Iodine and their Derivatives

**Bromine** is an even more efficient germicide than chlorine, bromine water having a Rideal-Walker carboic acid coefficient of 64 against 28 for chlorine water. The difficulty of using bromine extensively for sterilisation is the danger attending its use, although it is very efficient for rapid sterilisation in the field.

It has been suggested to use for sterilisation in the field free bromine in thin sealed glass tubes, and Rideal found that 20 parts per million of bromine sterilised *B. typhosus* in water in about thirty minutes. The process was employed in the Soudan campaign in 1898, using 60 parts of bromine per million of water with five minutes' contact, and removing the excess of bromine by 57 parts of sodium thiosulphate.

It has been disputed whether this process is efficient (see Schöder, *Zeitsch. f. Hyg.*, 1900, p. 53), and one objection is the formation of residual bromides.

"**Bromidine**" consists of a dry mixture of sodium bisulphate with sodium or potassium bromide and bromate. These react when moist to liberate free bromine. This material was introduced by Braithwaite. The main disadvantage is the entry of residual bromides into the drinking water.

**Altmann's process** consists in dissolving free bromine in potassium bromide solution. Forty parts of bromine with five minutes' contact per million parts of water sterilises the liquid. The excess of bromine is then removed by ammonia.

This process suffers from the defect that a bulky solution must be employed. Moreover, the expensive and physiologically active potassium bromide remains dissolved in the treated water.

**Iodine.**—Although free bromine is more rapidly absorbed by organic matter than free iodine, yet the latter appears to be a more vigorous poison towards protoplasm.

Cash proved that the quantities of chlorine, bromine, and iodine required for disinfection under similar conditions is nearly in the ratio of their atomic weights. The increase of toxicity with increase of atomic weight is apparent if we compare the germicidal value (Rideal-Walker coefficient) of chlorine water (28) with that of bromine water (64) and iodine water (100).

The high germicidal value of iodine makes it widely used as a constituent of ointments or tinctures in parasitic diseases. The surface of the skin is often disinfected before operations by painting with the tincture. Sometimes the surface of the skin is cleansed by applying a 1 per cent. solution in benzene or chloroform, especially prior to hypodermic injections.

Iodine has had a limited application for the purpose of sterilising water in the field. Thus, during the Thibet and Sikkim expeditions iodine tincture was applied to the water, the excess of free iodine being removed by the subsequent addition of sodium sulphite.

**Nesfield's triple tablets**, supplied for the purpose of sterilising water, consist of (1) a tablet of iodide and iodate, (2) a tablet of tartaric or citric acid. These are left in the water for two to three minutes, when the acid liberates free iodine from the iodate. Next, (3) a tablet containing sodium sulphite is added, which removes the free iodine. It is claimed that 4.5 parts of free iodine per million parts of water will destroy all typhoid, dysentery, and cholera germs.

**Iodine trichloride** ( $\text{ICl}_3$ ) is used for sterilising the instruments and hands in surgical operations.

According to Rideal 50 parts  $\text{ICl}_3$  per million of water kill typhoid germs in thirty minutes. The Rideal-Walker carboic acid coefficient is 94.

### Acids, Metallic Salts, Alkalis, and Metals

**Germicidal Power of Acids and Metallic Salts.**—The general rule appears to be that in each of these cases the germicidal power depends to a very large extent on the degree of ionisation and on the specific properties of the individual ions.

Thus it has been proved in the case of acids that, other things being equal, the germicidal value of an acid depends not so much upon the amount of alkali required to neutralise it as upon its degree of ionic dissociation.

The same applies to metallic salts. In general the metallic ion possesses a distinct germicidal value, and the more highly that they are dissociated at a given concentration the greater their germicidal value.

This general principle tends to be obscured by the fact that several salts and acids possess an inherent toxic effect on bacteria, quite independent of their degree of ionic dissociation. Moreover, some disinfecting salts are occluded or absorbed by solid substances accompanying bacteria, and so are prevented from exercising their full germicidal value.

The relationship between the chemical nature of the disinfectant employed and its disinfecting powers is, therefore, a very complex one, but much light has been thrown on the subject within recent years. The chief researches on the subject were carried out by Paul, Krönig, Sawey, and others between 1897 and 1900 (see *Pharm. Journ.*, 1900), to whose papers the reader should refer for further particulars.

Extended research has shown that metallic salts rank highest as germicides for spores (see Chick and Martin, *Journ. of Hygiene*, 1908, p. 634).

**Boric Acid** ( $H_3BO_3$ ) has only a very small germicidal value (Rideal-Walker carbolic acid coefficient less than 0.1) and so cannot be considered to be a disinfectant.

Its chief value lies in its considerable power of preventing bacteria which attack food from developing. Thus, according to Rideal and Foulerton, 3 parts of boric acid and 1 part of crystallised borax added to 8,000 parts of milk prevented it from becoming sour for twenty-four hours, and no ill effects on the digestion appear to follow its use in moderate quantities.

Consequently it is now the main preservative employed in preserving cream (0.25-0.5 per cent. boric acid), butter, and margarine (0.5 per cent. boric acid).

Usually mixtures of boric acid and crystallised borax are employed.

**Sodium borofluoride** ( $NaBF_4$ ), under the name "pyriat," has been used as a food preservative.

**Osmic acid** is a very powerful germicide, being very poisonous and a powerful oxidiser, but is too expensive to be widely used.

**Carbonic acid, carbon dioxide**, has a distinct antiseptic action, since  $CO_2$  under pressure preserves food, and many aerated waters seem to be almost completely sterilised.

**Fluorides and hydrofluoric acid (HF)** are valuable antiseptics in that they inhibit the growth of various injurious organisms, although their direct germicidal value is small. Hydrofluoric acid and its salts (especially ammonium fluoride) have long been used in the brewing industry in order to check side fermentations and disinfect rubber hose, etc., 0.5-1 per cent.  $NH_4F$  being efficient for the purpose. For further details see Martin's "Industrial Chemistry: Organic," under **Fermentation Industries**.

Hydrofluoric acid and fluorides cannot be used for food preservation as they cause digestive disturbances.

**Hydrofluorsilicic acid** ( $H_2SiF_6$ ) has been used as an antiseptic under the names of "keramyl" (25 per cent.  $H_2SiF_6$ ) and "montanin." The sodium salt ( $Na_2SiF_6$ ) has been used for the same purpose under the name "salufer."

**Hydrocyanic acid (HCN)** and its sodium and potassium salts are extensively used as insecticides and fungicides (see this volume under **Insecticides and Fungicides**), but are not nearly so effective towards bacteria and similar lower organisms.

**Nitric acid and oxides of nitrogen** are violent disinfectants, but their corrosive action, and also the extremely poisonous nature of these substances (breathing oxides of nitrogen may cause inflammation of the lungs, and even death), has caused their use for this purpose to be extremely limited. The cost of disinfection is very high.

**Chromic acid** is a very powerful germicide, instantly oxidising and coagulating albumen. The substance, however, is too expensive, too corrosive, and too poisonous for general use as a disinfectant and preservative.

**Sulphuric acid** is distinctly antiseptic and, when present in sufficient quantities, is also a disinfectant.

Thus, 0.05 per cent. disinfects iron pipes without markedly corroding the iron. 0.04-0.08 per cent. can destroy cholera germs in sewage. According to Rideal 0.035 per cent. sulphuric acid destroys typhoid germs in thirty minutes, 0.07 per cent. in fifteen to forty-five minutes. 0.09 per cent. sterilises the drainage from hospitals.

Nearly all acids possess considerable disinfectant power, and very few bacteria will develop in acid solutions.

According to Paul, Krönig, and Sawey (*Pharm. Journ.*, 1900) the germicidal action of acids is proportional to their degree of ionisation in solution, except in certain cases where the acids exercise a definite poisonous action.

For example, Winslow and Lochridge found in the case of sulphuric and hydrochloric acid that 99-100 per cent. destruction of *B. typhosus* or *B. coli* was effected with either acid at the same concentration of dissociated hydrogen (the germicidal action not being proportional to the strength of the acids as reckoned in normality).

The alteration in the ionisation in a dilute acid solution, brought about by the addition of neutral salts of the acid, usually accounts for the alteration of the germicidal value.

There are, however, many disturbing factors to be considered. Thus, certain acids, quite independently of their degree of ionisation, exercise a specific toxic action (e.g., HCN, HNO<sub>3</sub>, CCl<sub>3</sub>, COOH, HF, all act poisonously towards certain bacteria). Again, the absorptive effect of solids in suspension affect the results considerably. What has been thoroughly proved is that the acidity, as measured by titration with alkali, does not give the germicidal value of an acid solution.

**Acid sodium sulphate, sodium bisulphate** (NaHSO<sub>4</sub>), has a considerable germicidal value (Rideal-Walker coefficient = 4.1). It has been widely used for sterilising water for army purposes, being applied in the form of effervescing tablets both in the South African and the Russo-Japanese wars.

Rideal and Parkes (who introduced the substance for this purpose) showed that 15 grains of NaHSO<sub>4</sub> to a pint of water in fifteen minutes destroyed nearly all disease germs, as well as internal parasitic worms.

**Sulphur dioxide** has long been used as a disinfectant, being produced either by burning sulphur in air, or else by employing the liquefied gas in canisters. The latter method is preferable, as a regular supply of gas is assured, and there is no danger of fire.

Attention to certain details is necessary in order to secure good results. Thus the dry gas has little effect on bacteria and spores, but kills vermin of all kinds, and so is especially effective in combating insect-borne infection.

The wet gas is very much more germicidal in its action, but as a rule there is sufficient natural moisture in the air to make it act efficiently with only slight moistening. Thus, 1 lb. of sulphur burnt in a closed space of 1,000 cub. ft. dilutes the air with 1.15 per cent. of sulphur dioxide. 0.56 lb. of water is theoretically required to turn this into sulphurous acid, but owing to the water already in the air the additional moisture should only be applied by lightly spraying the surface or washing. Rideal found that when shallow pans of water were placed on the floor of a room with the object of supplying moisture, the sulphur dioxide contents were actually lowered (by water absorbing the gas) by over 50 per cent. in twenty-four hours, and disinfection was not complete.

*Quantities Necessary for Disinfection of Rooms.*—3½ lbs. sulphur burnt per 1,000 cub. ft. in twenty-four hours killed germs like *B. typhosus* and *diphtheria*, but not *B. tuberculosis* in dried sputum, nor anthrax spores. According to Rosenau, 5 lbs. sulphur per 1,000 cub. ft. kills all spore-bearing organisms after sixteen hours' exposure. Of course the rooms must be sealed.

Employing liquefied SO<sub>2</sub> in canisters, one can reckon that 1 lb. of the liquid will yield 5½ cub. ft. of gas.

For disinfecting the holds of ships, sulphur is burnt in a special apparatus, and the issuing gases (containing air, SO<sub>2</sub>, and a cloud of H<sub>2</sub>SO<sub>4</sub> mist) are forced in until the SO<sub>2</sub> contents of the air shall reach 10 per cent. For details in use, see "The Local Government Board Report," 232, 1906; "Med. Off. Rep.," 330, 1903-04; *Rev. d Hyg.*, October 1902,

*Other Uses of Sulphurous Acid and Sulphites.*—A solution of sulphur dioxide in water (sulphurous acid) is much used as a germicidal wash or spray in parasitic diseases like diphtheria, and is also applied internally in gastric fermentations, cholera, etc.

The solution and also bisulphites are widely used in the fermentation and food industries as a means of checking injurious fermentation.

Several preparations of sulphites have been placed on the market, e.g., "Hawke's anti-ferment," "meat preserve crystals," etc.

There are, however, objections to the extended use of sulphites in this direction. According to Lehmann 0.004 per cent. will not injure health.

Durham (*Journ. of Hygiene*, April 1909) suggests the maximum legal limit allowed should be 0.01 per cent. of "total sulphur dioxide."

**Disadvantages of the Use of Sulphur Dioxide.**—One of the main disadvantages of the use of sulphur dioxide for disinfecting purposes is that it is corrosive; it attacks metals and organic substances (being of an acid nature), and a great deal is absorbed by the calcareous plaster, of which the ceiling and walls are usually composed. Moreover the substance has little penetrating power, and cloth, bedding, and similar materials cannot be easily sterilised by it, the usual practice being to remove them and sterilise by heating in boilers. The fibres of textiles, too, are often rotted after treatment with sulphur dioxide, owing to the free sulphuric acid produced gradually disintegrating the material.

Moreover the gas is poisonous. It has been found that about 5 per cent. in the air has caused death. 0.5 per cent. can be breathed for some time, and a higher percentage than this can be tolerated by breathing through a wet cloth soaked in washing soda.

**Sulphur** is principally used as an insecticide and fungicide, its use in this respect being fully discussed in the section on **Insecticides and Fungicides**, which see. The same applies to the **polysulphides**.

**Arsenic** is also principally used as an insecticide, it being widely employed for sheep-dips and similar preparations, the preparation and uses of which are described in the section on **Insecticides, Fungicides, and Sheep-Dips**. Arsenic acts more injuriously on the higher forms of life than on the lower. The medicinal organic compounds, introduced by Ehrlich and others for various parasitical diseases, are treated of in **Martin's "Industrial Chemistry: Organic."**

**Lime, quicklime (CaO)**, has a strong germicidal action when in a dry condition, a fact which has been taken advantage of for centuries in the practice of burying the bodies of victims of plague and cholera in quicklime, and in the periodical whitewashing of buildings.

Unfortunately the disinfecting power of lime is not so great as was formerly supposed.

Thus it requires 74 parts of CaO (in the form of milk of lime) per million of water to destroy typhoid bacteria, while no less than 247 parts per million are required for destroying cholera bacteria, some hours' contact being required in each case. The "excess lime" method of sterilising drinking water is referred to at length in Vol. I. of this work under **Water**.

Two per cent. of dry quicklime and some hours' contact are required to sterilise cholera discharges.

It has been proved that disinterred infected bodies, which have been buried in lime, still retain the disease spores alive for a long time; these may again become active and cause infection.

**Sodium and potassium hydroxides** act as sterilisers when present in the proportion of 3-5 per cent. Warm solutions (60° C.) cause the death of most organisms in three or four minutes.

**Sodium and potassium carbonates** are also antiseptics when present in solution to the extent of 6-10 per cent. The hot solutions (50°-60° C.) cause the death of most germs in a few minutes.

**Soaps** are also slightly antiseptic (see **Martin's "Industrial Chemistry: Organic,"** under **Soap**).

Salt, or strong brine, acts as an antiseptic—that is, prevents injurious bacteria from developing, and hence the ancient practice of salting beef, etc. Wounds are now treated with brine to prevent the development therein of dangerous organisms. Salt, however, is not a disinfectant—that is, it does not actually destroy disease germs. Thus it has been shown that a 50 per cent. salt solution does not kill the spores of ordinary moulds.

The common practice of washing out milk utensils, cans, etc., with brine has, therefore, little value from the disinfecting point of view.

### Copper and Copper Salts

Copper salts are all powerful germicides, the efficiency of the soluble copper salts depending upon their percentage of copper. *Copper sulphate*, being the cheapest, is the most usual one employed of the copper salts. It has a Rideal-Walker coefficient of 2.0 (calculated as  $\text{CuSO}_4$ ). The main use of copper sulphate occurs in agriculture for killing parasites infesting vegetation. The best known preparation is called **Bordeaux mixture**, and as the matter is fully discussed in the section on **Insecticides, Fungicides, and Sheep-Dips**, we refer the reader thereto for further information.

It has been proved that the disinfection of excreta, etc., with such large quantities as 5-10 per cent. copper sulphate is not satisfactory. According to American authorities [see Bull. U.S. Dept. of Agric., No. 100, 1906; see also U.S. Geological Survey, Water Supply Paper, 229, p. 32 (1909)], disinfection by means of copper sulphate is not so efficient as that caused by chlorine compounds, and is very much more expensive. However, a soluble disinfectant for stables and drains, consisting of about 75 per cent. of copper sulphate and sulpho-carbolate, and containing some free sulphur dioxide, has been sold under the name of "microsol."

Cuprous chloride ( $\text{Cu}_2\text{Cl}_2$ ) is considerably more germicidal in its action than copper sulphate. Thus Kroncke completely sterilised Elbe water (containing 50,000 organisms per c.c.) by treating with 50 parts per million of cuprous chloride, adding 20 parts of ferrous sulphate, standing for six hours, and then precipitating all metal by mixing with 10 parts lime. On filtering through sand the water was perfectly colourless and sterile.

Metallic copper appears to possess sterilisation properties. Thus the U.S. Department of Agriculture (1904) states that 1 sq. cm. of bright copper per 100 c.c. of water destroys *uroglena*, some forms of *spirogyra*.

Kraemer, Rideal and Baines (*Journ. San. Inst.*, 1904, p. 594), and B. Smith (*Journ. Prev. Med.*, July 1904) have extended these observations, and confirmed them. Thus it was proved that by immersing strips of copper of 2 sq. cm. to each 100 c.c. water (*i.e.*,  $3\frac{1}{2}$  sq. in. to each quart) typhoid and colon bacilli were destroyed in four to twenty-four hours (the length of time given by the different authorities varies greatly), and that with water containing over 1,000 ordinary organisms per c.c., only eight organisms per c.c. were left after twenty-four hours.

The germicidal effect of copper on many algæ and bacteria is believed to be due to the passing of the copper into colloidal solution.

### Mercury and Mercury Salts

Mercury salts are nearly all possessed of a high germicidal power.

According to Krönig and Paul (1897) the germicidal power depends almost solely upon the metallic ion, and is proportional to its degree of ionisation.

Thus, on comparing equivalent solutions of mercuric chloride, bromide, and cyanide, he found that the first is more germicidal than the second, and the second than the third, and that this order corresponds with the degree of ionisation of these substances, the cyanide being almost non-ionised.

Again he showed that on comparing solution of mercuric chloride in water of different strengths, a solution of one part  $\text{HgCl}_2$  : 1,000 water is more than twice as active as one part  $\text{HgCl}_2$  : 500 water, this enhanced activity corresponding to the increased dissociation of the mercury salt in the diluter solution.



**Mercuric chloride** ( $\text{HgCl}_2$ ), long known as "corrosive sublimate," is one of the most powerful of disinfectants known, and formerly a 0.1 per cent. solution was taken as the standard of comparison of other disinfectants. The Rideal-Walker coefficient is 400-4,000.

The solution recommended for disinfecting purposes by the **Local Government Board** consists of mercuric chloride,  $\frac{1}{2}$  oz.; hydrochloric acid, 1 fluid oz.; aniline blue, 5 grains; water, 3 galls.

The aniline blue is added for colouring the liquor, so as to prevent it getting into potable waters, etc., by accident.

Mercuric chloride is largely used in museums and similar institutions for preserving stuffed animals and specimens. Mercuric chloride has never come into extended use as a general disinfectant for the following reasons:—

(1) The substance is very expensive; (2) it is extremely poisonous to higher animals and plants, and hence is dangerous to use; (3) it is an irritant to wounds; (4) it is often destroyed chemically, the mercury being precipitated in the form of insoluble salts, by alkalis, by many salts, hard water, sulphides, and organic bodies; so that the substance is liable to be removed from solution before it has done its germicidal work—time being an important factor in this.

In particular, the substance combines with albuminous matter, forming an insoluble coagulum. Consequently it may form a pellicle over organisms without killing them, and cannot be used for disinfecting excreta and sputum, owing to its penetration being stopped by the protective albuminoid coagulations. The soluble albumen contained in blood serum precipitates mercuric chloride, and so reduces its efficiency.

The addition of ammonium or sodium chloride somewhat increases the stability of  $\text{HgCl}_2$  solutions, but considerably diminishes its germicidal activity, no doubt, by lessening the ionic dissociation of this substance.

**Mercuric bromide** ( $\text{HgBr}_2$ ) is less germicidal than mercuric chloride, and so is seldom employed.

**Mercuric iodide** ( $\text{HgI}_2$ ) is a powerful germicide, and finds some use under the name of "iodic hydrarg," which consists of a solution of mercuric iodide in potassium iodide.

Mercuric iodide is less irritant to wounds than mercuric chloride, and does not coagulate albumen in the same manner. Hence it has been incorporated into several antiseptic ointments and soaps.

**Mercuric cyanide** ( $\text{Hg}(\text{CN})_2$ ) is no less than four times less germicidal than mercuric chloride, and so is seldom employed. **Mercury oxycyanide**, however, finds considerable application in surgery since, unlike mercuric chloride, it only slightly precipitates albumen. A solution of 1:1,500 forms a faintly alkaline antiseptic non-irritant solution, suitable for disinfecting surgical instruments.

**Mercuric-zinc cyanide** has been widely used for disinfecting surgical instruments under the name of "Lister's Antiseptic."

**Mercuric ethylene diamine sulphate** has been used as a hand-disinfectant under the name "sublamen." It does not coagulate albuminoid matter, is less irritant than mercuric chloride. It is readily soluble in water.

**Sodium hydroxy mercury benzoate** has been suggested as a powerful disinfectant.

**Mercury salicylate** is also a disinfectant.

"Protectyl" consists of a solution containing 0.2 per cent. Hg, 1 per cent. salicylic acid, 3 per cent. gelatine, and 95.8 per cent. water.

**Metallic mercury** has a powerful germicidal value, and is much used in a finely divided form for certain parasitic diseases, such as syphilis. Many well-known ointments contain metallic mercury.

### Silver Salts

**Silver Nitrate** is a very powerful germicide, possessing a Rideal-Walker coefficient of 16. A 0.1 per cent. solution will kill *B. coli* and *S. py. aureus* in twenty-four hours. 0.5-2 per cent. solution kills the same germs in two to five minutes.

Although silver nitrate enjoys considerable vogue in surgical practice for painting and spraying skin surfaces infected with various parasitical diseases, yet it has never come into extended use as a disinfectant because:—

(1) It is very expensive; (2) it combines with albumen, and is precipitated by many salts, including chlorides. Rideal proved that a very small amount of chloride added to a 0.1 per cent. solution entirely upset its disinfecting powers.

**Silver fluoride** is a powerful non-toxic and easily soluble germicide much used in 0.1-0.02 per cent. solutions as an antiseptic in diseases of the urinary organs. It has been sold under the name "Tachiol."

**Organic Silver Salts.**—A great number of these have been placed on the market as disinfectants. The great advantage of employing organic silver salts is that they do not, as a rule, coagulate albumen, as their silver is not completely precipitated by chlorides, and they are less irritant than silver nitrate.

**Silver citrate** is used as an antiseptic dust for wounds under the name "Itrol."

**Silver lactate** is used as an antiseptic injection under the name "Actol."

**Ethylenediamine-silver-phosphate** has been used for a similar purpose under the name "Argentamine."

Compounds of silver with albumen, casein, wheat gluten, etc., have been put on the market under the names "largin," "argonine," "agyrol," "protargol," and some of these have a considerable germicidal value.

For particulars see the *Journ. Chem. Soc. Ind.*, 1903, p. 315; the *Lancet*, 1907, Vol. I., p. 675. They have been used especially for destroying ophthalmic disease organisms, and in diseases of the urinary organs.

### Zinc Salts and Zinc

**Zinc chloride** ( $ZnCl_2$ ) has a feeble disinfecting power (Rideal-Walker coefficient 0.15), and was at one time widely used under the name of "Burnett's Fluid." It is now little used. **Zinc chloride** has also been used for injecting into timber for the purpose of preserving it.

**Zinc sulphate** ( $ZnSO_4$ ) has also some germicidal action (Rideal-Walker coefficient 0.09), but is now little used.

**Metallic zinc** is said to possess a very considerable germicidal action. Thus agitation of water with granulated zinc is stated to destroy *B. coli* and *B. typhosus* in a few hours. Margosches sterilised water by agitating it with zinc dust, lime, and charcoal.

The presence of air or oxygen seems necessary.

### Aluminium Salts and Aluminium

**Aluminium chloride** ( $AlCl_3$ ) has a feeble disinfecting action, less than that exerted by copper sulphate and greater than that of zinc chloride.

**Metallic aluminium** seems to have a considerable sterilising effect on water. On running water down aluminium gutters the number of bacteria considerably decreases. The subject is discussed in Vol. I. of this work under **Water**.

**Iron salts**, especially ferrous sulphate, have been applied for disinfecting purposes, but according to Rideal they are ineffective. **Metallic iron**, however, appears to possess some germicidal value. A process for purifying water has been founded on this fact (see *Journ. Soc. Arts*, 14th Feb. 1896).

## SECTION LIII

# INSECTICIDES, FUNGICIDES, AND SHEEP-DIPS

BY GEOFFREY MARTIN, Ph.D., D.Sc.

### LITERATURE

"Abridged Agricultural Records," Vol. VI. Washington, 1912.

### COPPER COMPOUNDS

**BORDEAUX MIXTURES.**—One of the most valuable fungicides for plant diseases is Bordeaux mixture, consisting of copper sulphate and slaked lime.

**Formula I.**—Copper sulphate, 6 lbs. ; lime, 4 lbs. ; water, 50 galls.

**Formula II.**—Copper sulphate, 5 lbs. ; lime, 5 lbs. ; water, 50 galls.

**Peach Bordeaux Mixture.**—Copper sulphate, 3 lbs. ; lime, 9 lbs. ; water, 50 galls.

**Soda Bordeaux Mixture.**—Copper sulphate, 6 lbs. ; caustic soda, 2 lbs. ; water, 50 galls.

**Potash Bordeaux Mixture.**—Copper sulphate, 6 lbs. ; caustic potash, 2 lbs. ; water, 50 galls.

**Soap Bordeaux** (increases spreading power).—Ordinary hard soap is dissolved in water and added at the rate of 4 lbs. to the barrel of solution.

**Manufacture.**—In order to make small quantities, two half barrels are made by sawing a barrel through the middle. In one half barrel is placed the copper sulphate and 25 galls. of water. In the other is the lime and also 25 galls. of water. The contents are stirred until as much has dissolved as possible.

The two half-barrel tubs are placed on a platform, and by means of hose or spigots the two solutions are allowed to flow together into a barrel placed below.

The Bordeaux mixture is then strained through a brass wire strainer of eighteen to twenty meshes to the inch.

In preparing Bordeaux mixture for large operations a 50-gall. barrel is three-quarters filled with water. Then a sack or a box with perforations covered with copper wire containing 50 lbs. of copper sulphate is suspended in the upper part of the barrel, and enough water is added to fill the barrel. In twenty-four to thirty-six hours, solution is complete and the sack or box is lifted out, and the liquid is stirred. The copper sulphate solution must be stored in copper or earthenware vessels. *Iron or tinned iron vessels are corroded.*

The stock solution of lime (1 lb. lime to each gallon of water) is prepared in the same way. Then measured quantities of each solution are run simultaneously into a third mixing tank placed below.

### SULPHUR FUNGICIDES

**Sulphur**, especially in the form of a powder, "flowers" of sulphur, is used as a fungicide, especially as a remedy for mildew. "Flour" of sulphur is not so finely divided as "flowers," and so is not so good. The heating pipes of greenhouses are often painted with a paste of flour of sulphur and water.

**Sulphur and Resin Solution.**—Sulphur (flowers or flour), 16 lbs. ; resin (finely powdered),  $\frac{1}{2}$  lb. ; caustic soda (finely powdered), 10 lbs. ; water, 6 galls.

Mix the sulphur and resin, place in a barrel, and make into a thick paste by adding 3 quarts of water. Now stir in the caustic soda. The mass, after a few

minutes, begins to boil vigorously, turning a reddish brown. It should be thoroughly stirred, and after boiling has ceased 2 galls. of water are added, the liquid is poured off into another vessel, and sufficient water to make 6 galls. is added.

This solution is used (1 : 50 galls. of water) for spraying plants and soaking seeds.

**Potassium Sulphide Fungicide.**—Dissolve 1 oz. of potassium sulphide (liver of sulphur) in 3 galls. of water and use immediately. Mixture deteriorates rapidly on standing.

**Corrosive Sublimate** (mercuric chloride,  $\text{HgCl}_2$ ) is used (1 part in 1,000 of water) to disinfect knives, etc., used in cutting out pear-blight, etc.

**Lime-Sulphur Washes.**—The mixture may contain 8 lbs. of sulphur (flowers, flour, or ground), 8 lbs. of fresh stone lime, and 50 galls. of water.

**Preparation.**—The lime is placed in a barrel and enough water (6 galls.) is poured on to almost cover it. As soon as the lime begins to slake, run in the sieved sulphur powder, stir continually, and add 3-4 galls. more water so as to form first a thick and then a thin paste. The heat evolved by the slaking lime should heat the water almost to boiling for several minutes.

Finally water is added to cool the hot liquid, and it is run through a strainer into a tank, diluted, and applied.

The time at which cold water should be added to cool the hot liquid depends upon the nature of the lime used. A poor lime often evolves so little heat on slaking, that a properly hot solution does not result. Other limes evolve much heat. The liquid must *not* be allowed to remain hot for long (say fifteen to twenty minutes after slaking) otherwise the lime goes into solution and forms soluble calcium sulphides which are injurious to foliage. Hence with a hot lime the mixture must be cooled rapidly by adding cold water as soon as the slaking of the lime is complete. A uniform mixture of finely divided lime and sulphur results, in which but little sulphur is in true solution. The liquid is strained from lumps of lime.

**Formaldehyde** (see Martin's "Industrial Chemistry: Organic"), either in solution (1 lb. formalin to 50 galls. of water) or gasified, is often used for treating seeds, wheat, or oats.

Formalin if used in too strong a solution, or if the grain is soaked too long, may destroy the germinating power of grain.

## SHEEP-DIPS

The sheep-dips most commonly used contain sulphur, arsenic, carbolic acid, and (in America) sulphur.

The dips containing sulphur are the best, the sulphur being retained in the wool (being non-volatile and non-soluble) for a longer period of time than the scab parasites remain alive away from their hosts.

**Lime and Sulphur Dips.**—The following are various lime and sulphur dips which have been used in various parts of the world :—

(1) **Victorian Lime and Sulphur Dip** (adopted officially in Australia) :—

Flowers of sulphur	-	-	-	-	20 lbs.
Fresh slaked lime	-	-	-	-	10 lbs.
Water	-	-	-	-	100 galls.

(2) **South African (Cape Town) Official Lime and Sulphur Dip** :—

Flowers of sulphur (minimum)	-	-	-	-	15 lbs.
Unslaked lime	-	-	-	-	15 lbs.
Water	-	-	-	-	100 galls.

(3) **South African (Cape Town) Official Lime and Sulphur Dip, of 4th Feb. 1897** :—

Flowers of sulphur	-	-	-	-	20 lbs.
Unslaked lime	-	-	-	-	16 lbs.
Water	-	-	-	-	100 galls.

(4) Nevada Lime and Sulphur Dip :—

Flowers of sulphur	-	-	-	-	16 lbs.
Lime	-	-	-	-	33 lbs.
Water	-	-	-	-	100 galls.

(5) Fort Collins Lime and Sulphur Dip :—

Flowers of sulphur	-	-	-	-	33 lbs.
Unslaked lime	-	-	-	-	11 lbs.
Water	-	-	-	-	100 galls.

(6) The following mixture has been widely used with satisfaction :—

Flowers of sulphur	-	-	-	-	24 lbs.
Unslaked lime	-	-	-	-	8 lbs.
Water	-	-	-	-	100 galls.

Fresh scab is efficiently treated by No. 6. In cases of very hard scab a stronger dip, such as No. 5, is used. In unusually severe cases use No. 1, No. 3, or No. 4.

It is dangerous to use *more than 33 lbs. of lime to 100 galls. of water, and 16 lbs. is as much as should be used without expert advice.*

**Preparation of Lime and Sulphur Dips.**—8-11 lbs. of unslaked lime are placed in a pail and enough water is added to slake the lime and form a thick paste. One pint of water will slake 3 lbs. of lime. Sift into the lime paste three times as much flowers of sulphur as was used of lime, and stir mixture. Next place the sulphur-lime paste in a kettle or boiler with 25-30 galls. of boiling water, boil mixture for two to three hours, stirring continuously, and replacing evaporated water.

The sulphur should disappear from the surface and a solution of a chocolate-brown colour should result.

Now pour into a settling tank or barrel and allow to settle four hours.

The barrel or tank should have a spigot inserted 3-4 in. from the bottom, so as to run the liquid out without disturbing the sediment.

When fully settled run the clear liquid off through a filter made of ordinary sacking into the dipping vat for sheep, and add enough warm water to make 100 galls. The sediment left in the barrel and filter sack **must not be used for dipping cattle**. It may, however, be mixed with water and used as a disinfectant.

**Use of Lime and Sulphur Dips.**—When properly made and used, these dips are the most efficient known as scab destroyers.

The wool is always injured to a slight extent by the use of such dips, but when used upon shorn sheep the injury is negligible. On long wool, however, the injury is greater, being most pronounced on fine wool and less so on coarse wool. The injury consists in a change in the microscopic structure of the fibre, caused by the caustic action of the liquor. Improperly made and used lime and sulphur dips are, however, both injurious and dangerous.

### Tobacco and Sulphur Dips

The proper preparation of a lime and sulphur dip requires at least two hours' boiling of the mixture. In certain districts of America and Australia, however, where fuel is scarce and facilities for boiling are not at hand, the use of a **tobacco (or nicotine) and sulphur dip** is growing, since these can be made without lengthy boiling.

The advantage of these dips is that two of the best scab remedies, namely, tobacco (nicotine) and sulphur, are used together, both of which kill the parasites, while the sulphur remains in the wool, and protects for some time against re-infection.

**Nicotine** (see *Martin's "Industrial Chemistry: Organic"*), an alkaloid contained in tobacco, is the poisonous active principle of the tobacco. This poison when applied externally to animals may cause nausea, fainting, and even death.

A solution containing from 30-60 parts of nicotine in 100,000 parts of water makes a slow but sure acting sheep-dip. The percentage of nicotine, however, varies greatly in different varieties of

tobacco, and in the different parts of the tobacco plant. There is more nicotine in the leaves than in the stem. Hence it is usual to use an extract of tobacco, or a nicotine solution, on account of the ease with which these extracts dissolve in water.

**Manufacture.**—An efficient tobacco dip should contain at least 0.0007 per cent. of nicotine. Sufficient nicotine would therefore be obtained for 100 galls. (800 lbs.) of dip by using 1 lb. of a 40 per cent. solution of nicotine. Hence the formula for an efficient dip would be:—

Nicotine	-	-	-	-	0.56 lb.
Water	-	-	-	-	100 galls.

The nicotine solution or tobacco extract should not be added to the dip until just before it is ready for use. The dip should be thoroughly stirred.

The dip should never be heated above 110° F. (44° C.) after the nicotine has been added, as the nicotine can volatilise and weakens the dip.

In order to calculate the amount of nicotine solution or tobacco extract to be used per 100 galls. of water, divide the amount of nicotine required in 100 galls. of the dip by the proportion of nicotine in the extract.

For example, a 25 per cent. solution of nicotine is used to make a dip containing 0.56 lb. of nicotine to 100 galls. of water. Hence we have— $0.56 \div 0.25 = 2.24$  lbs. of nicotine extract to be used per 100 galls. of dip. If a tobacco extract is used, having, e.g., 2.40 per cent. of nicotine, we have— $0.56 \div 0.024 = 24.33$  lbs. of tobacco extract per 100 galls. of dip.

**Preparation of Tobacco Extracts for Dips.**—For 100 galls. of dip use 21 lbs. of good leaves. Soak in water for twenty-four hours, then raise water to boiling for a moment, allow infusion to stand one hour (or allow to stand overnight), strain liquid (best under pressure) from leaves and dilute to 100 galls. per 21 lbs. of tobacco used.

The advantages of the tobacco dip are—(1) Cheapness, since the farmer can grow his own tobacco; (2) efficient and non-injurious to wool. The disadvantages are—(1) The persons using it are often made ill; (2) it spoils very rapidly; (3) it sometimes injures the sheep ("causes a set-back").

### ARSENICAL DIPS

Formulas:—(1) 3 lbs. each of arsenic oxide, soda ash, soft soap, and sulphur (a pint or two of naphtha is sometimes added) is dissolved in 10-20 galls. of boiling water, and cold water is added to make 120 galls. Keep head of sheep out of bath.

2 Commercial pure sodium arsenite	-	-	-	-	14 lbs.
Ground roll sulphur	-	-	-	-	34.5 lbs.
Water	-	-	-	-	432 galls.

The arsenite of soda is mixed with the sulphur before adding the water.

The disadvantages of arsenic dips are:—(1) Danger as a deadly poison; (2) drying effect on wool; (3) weakens the fibre of wool in one particular spot near the skin; (4) does not tend to increase the growth of the wool; (5) sometimes injures the sheep. The advantages are its excellent scab-curing qualities.

### CARBOLIC DIPS

These dips act very quickly in killing mites (quicker than tobacco or sulphur dips), but unfortunately the wash soon leaves the sheep, which is, consequently, not protected from reinfection in the pastures. Hence it is advisable to add 1 lb. of flowers of sulphur to every 6 galls. of dip as a protection against reinfection.

## SECTION LIV

# ARTIFICIAL MANURES

BY ARTHUR S. CARLOS, B.Sc. (Lond.), A.I.C.

*Consulting and Analytical Chemist, London; Fellow of the Chemical Society, London*

### LITERATURE

- ROGERS and AUBERT.—“Industrial Chemistry.” 1912.  
 THORPE.—“Dictionary of Applied Chemistry.” 1912.  
 DYER.—“Fertilisers and Feeding Stuffs.” 1910.  
 HALL.—“Fertilisers and Manures.” 1910.  
 MURRAY.—“Soils and Manures.” 1910.  
 ——— “The Standard Cyclopædia of Modern Agriculture and Rural Economy.” 1910.  
 ELLIS.—“Outlines of Bacteriology.” 1909.  
 PERCIVAL.—“Agricultural Bacteriology.” 1909.  
 DAMMAR.—“Technologie der Neuzeit.” 1910.  
 OST.—“Lehrbuch der Technologie.” 1911.  
 BLUCHER.—“Modern Industrial Chemistry” (Translation). 1911.

IN general, plants obtain their carbon (as carbon dioxide) from the air, water from rain, and nitrogen (as ammonia or combined nitric acid) from the soil. Certain plants (*i.e.*, legumes) are able to assimilate free nitrogen from the air.

In addition to these three chief substances other nutriments are required, such as are found in the ash of most plants. They are:—

Potash, $K_2O$ .	(Sometimes soda, $Na_2O$ .)
Lime, $CaO$ .	Magnesia, $MgO$ .
Iron oxide, $Fe_2O_3$ .	Silica, $SiO_2$ .
Sulphuric acid, $H_2SO_4$ .	Phosphoric acid, $H_3PO_4$ .
Hydrochloric acid, $HCl$ .	

Most of these are present in sufficient quantities in virgin soil, but their stock can very easily be used up, especially if the soil is poor, and often at a greater rate than that at which it is replenished; consequently manures have to be put on the land in order to replace, in the soil, the constituents removed by the plants.

In all manures the active constituents should be easily assimilable by the plants. In other words, the manure should decompose fairly rapidly, and also the chief constituents should be soluble in water or very dilute acid.

### I. PHOSPHATIC MANURES

**Natural Phosphates.**—Extensive deposits of natural phosphates occur in various parts of the world. The harder of these raw phosphates, even in the finest milled condition, are of very little manurial value, because they are only very slowly soluble in water, and hence plants can only make use of them very slowly. The softer minerals, if sufficiently finely ground, have an appreciable but limited value for direct application to the soil.

The chief deposits are:—

(i.) **Coprolites.**—This was the first deposit to be used as a manure. It occurs in the Jurassic Strata and Suffolk Crag, particularly in Cambridge, Gloucestershire, and Bedfordshire, and consists

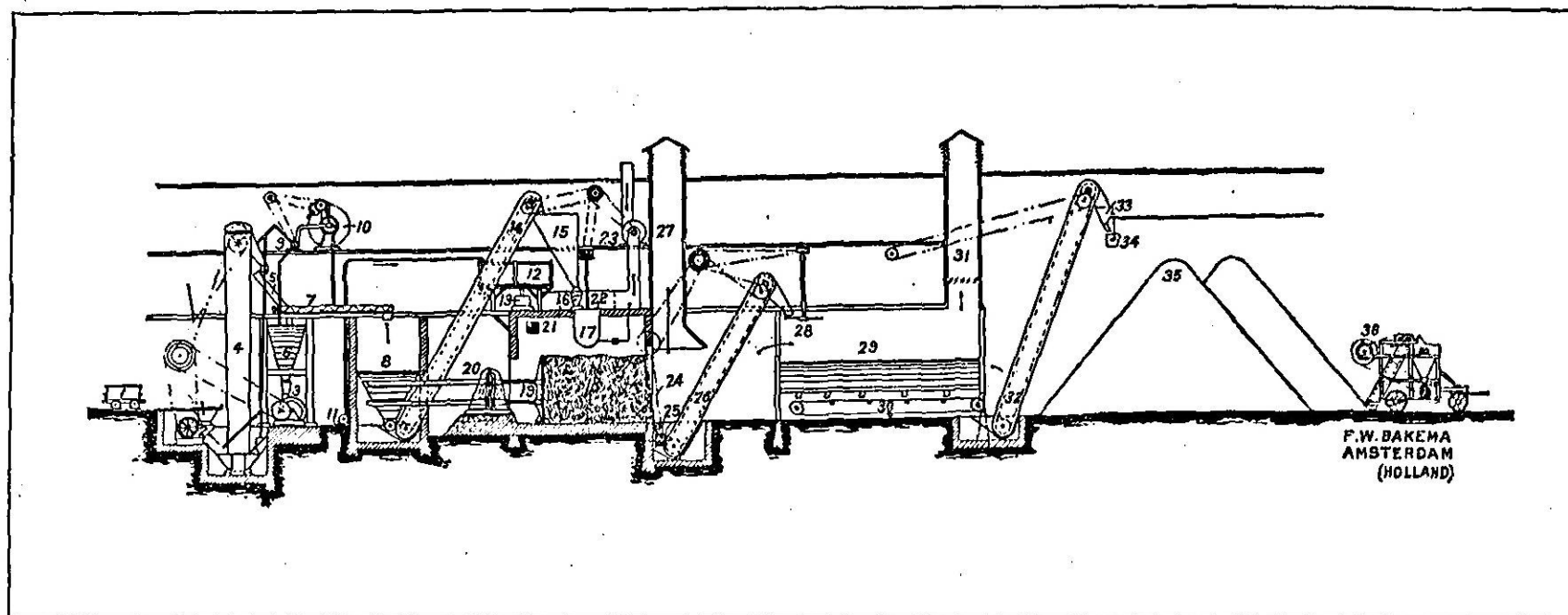

FIG. 1.—Complete Fertiliser Plant (see p. 31).

1. Tip waggon for raw phosphate.
2. Rough crusher.
3. Mill.
4. Elevator.
5. Fine screens.
6. Feed hopper for mill.
7. Worm conveyer for ground phosphate.
8. Store bin for fine phosphate.
9. Exhaust fan.

10. Dust collector.
- 10a. Dust collecting pipes.
11. Centrifugal pump for acid.
12. Acid store tank.
13. Acid measuring tank.
14. Fine phosphate elevator.
15. Fine phosphate feed hopper.
16. Special weighing machine.
17. Acid and phosphate mixer.
18. "Svenska" den-excavator.

19. Piston.
20. Worm-wheel gearing.
21. Ventilation.
22. Condenser flues.
23. Exhaust fan.
24. Crumbling arrangement.
25. Superphosphate conveyer.
26. Superphosphate elevator.
27. Ventilation.
28. Slicing (rasping) machine.

29. Store silo for sliced super.
30. Belt conveyer.
31. Outlet flue from store silo.
32. Superphosphate elevator.
33. Small feed hopper.
34. Mono-rail system.
35. Finished superphosphate in store.
36. Portable bagging and weighing machine.



of the excrement of Saurians metamorphosed to tricalcium phosphate. Coprolites usually contain about 25 per cent. phosphoric oxide ( $P_2O_5$ ) and about 42 per cent. lime ( $CaO$ ). English coprolites are no longer in use.

(ii.) **Sandy Phosphates.**—These deposits occur in Belgium, and in France on the Somme.

(iii.) **African Phosphates** are deposits found in the north of Africa. The beds in Tunis (Algerian phosphate) are extremely important, and contain about 30 per cent.  $P_2O_5$  and 48 per cent. lime.

(iv.) **Deposits in Florida, Tennessee, and South Carolina.**—The composition of Florida phosphate is on the average 35 per cent.  $P_2O_5$ , 2.5 per cent.  $Fe_2O_3$  and  $Al_2O_3$ , and 45 per cent.  $CaO$ .

(v.) **Christmas Island Phosphates**, from Christmas Island, south of Java, where there is estimated a bed of  $2\frac{1}{2}$  million tons, consisting of a white phosphate, very easy to mill if sufficiently dry. Its average composition is 87 per cent. tricalcium phosphate, 0.5 per cent. iron oxide, 1 per cent. alumina, and 6 per cent. lime.

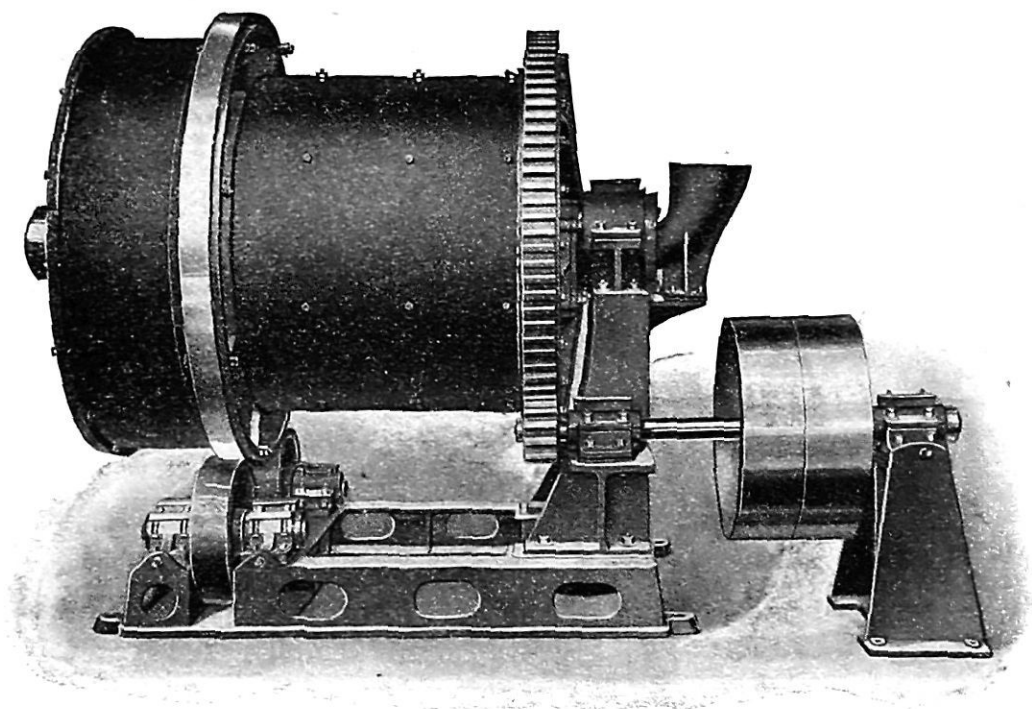

FIG. 2.—Abbé Ball Mill.  
(The Abbé Engineering Co., New York.)

(vi.) **Pacific Phosphate.**—There are two extensive deposits of this phosphate which are now being worked to a very large extent.

(a) **Ocean Phosphate** from Ocean Island (British), in the Gilbert Group. This is a very extensive deposit of mineralised guano, the excrement of sea birds, which has accumulated for thousands of years. The phosphate is light to dark brown in colour, crushes well, and is fairly easily assimilable by plants. It contains about 85 per cent. acid calcium phosphate, 0.5 per cent. iron oxide and alumina, and 5 per cent. calcium carbonate.

(b) **Deposit at Nauru Island** (Pleasant Island), belonging to the Marshall Islands. This deposit is exactly similar to ocean phosphate.

(vii.) **Further Deposits.**—In the States of Idaho, Utah, and Wyoming new deposits have been discovered. These are estimated at least at 100 million tons.

Great deposits also occur at Angaur Island (Paulau), west of Caroline Islands, where about  $2\frac{1}{2}$  million tons of an 80 per cent. phosphate are said to exist. The deposits at the Island of Makatu in the Tuamotu archipelago, have not yet been fully investigated.

The phosphate in all these deposits exists chiefly as tricalcium phosphate, and appears to have arisen from the action of phosphoric acid (of organic origin) on calcium carbonate. Phosphate in this form is very slightly soluble in water, so that it is necessary to convert it into a soluble form, such as superphosphate, before it is of much use as a manure. The first step is to crush the mineral phosphate, then

grind and separate the fine powder. This process of milling has been carried on for a long time in a wrong manner by using mills that are not suitable for the purpose.

**Crushing.**—The raw material should be first crushed so as to reduce the larger lumps to a convenient size for the grinding mill.

This is done in special machines, such as the **Roll-Jaw Rock Crusher** or the **Rotary "Open Door" Fine Crusher**, supplied by the Sturtevant Engineering Co. Ltd., of London, and which the writer can recommend. Similar machines are described under the **Calcareous Cement Industry**, p. 92, to which the reader is referred for a description.

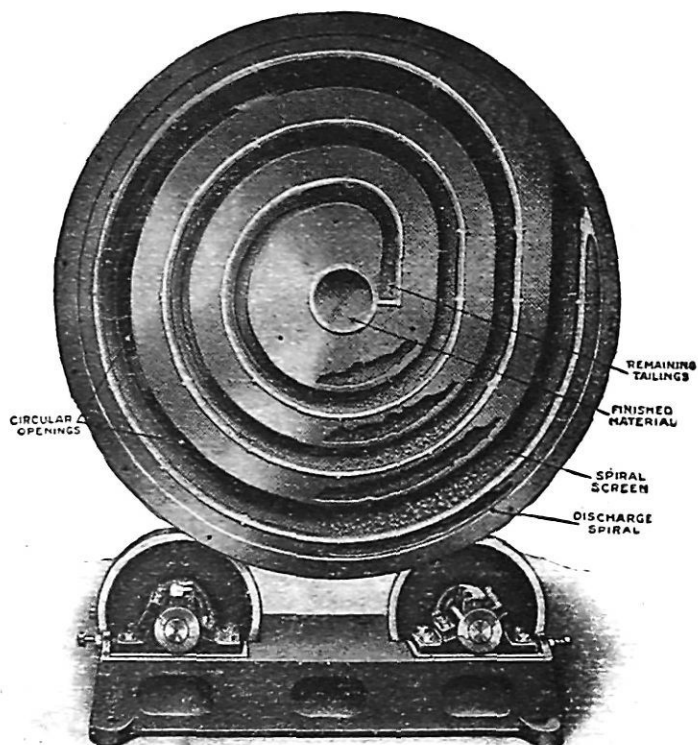

FIG. 3.—Abbé Ball Mill—Spiral Screen (open).

(Abbé Engineering Co., New York.)

**Grinding.**—After the phosphate has been crushed it is transferred to a suitable mill for grinding or disintegrating.

The best mills in use at present are:—

(1) **Ball Mills.**—The Abbé Ball Mill, manufactured by the Abbé Engineering Co., New York (see Figs. 2 and 3), consists of a rotating drum-like cylinder containing steel balls, and covered inside with steel step-like plates. The material to be ground enters this chamber through a hole at the end (seen on the right, Fig. 2).

The crushing is performed by the balls falling from one step on to the next. To the end of the chamber is bolted a patent spiral discharge, and screening spiral. The spiral screen consists of a number of convolutes of diminishing diameter as they approach the centre.

The crushed material passes into the screen on its largest convolute (see Fig. 3), and after sifting over the whole length of the spiral, the remaining tailings are delivered, by means of a conveyer at the centre, to the opposite end of the grinding chamber. The various convolutes of the screen are surrounded by a discharge spiral which runs the full length of the screen spiral, and conveys the finished product to the discharge at the centre of the end of the machine.

(2) **Tube Mills.**—These are essentially mills for fine grinding. A typical mill consists of a long tube of steel plates (up to 30 ft. long and 6 ft. diameter), containing a number of flint or steel balls, and revolved by suitable gear. The mill is capable of being used for either wet or dry grinding, and this is effected solely by the flint pebbles or steel balls rubbing against each other

and the side of the tube. The feed is placed at one end, and the outlet at the other. Fig. 4 shows a tube mill capable of turning out about 4-7 tons of very fine finished powder per hour. The material delivered to the mill should be pulverised to about  $\frac{1}{4}$  in. cubes, and the final product separated, the coarse particles being returned to the mill. One of the great advantages of

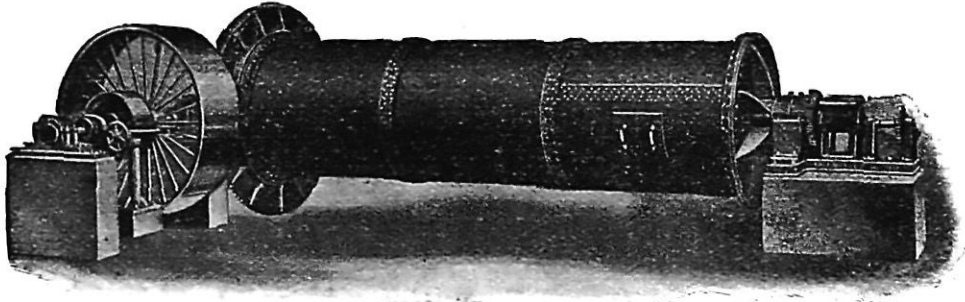

FIG. 4.—Tube Mill.  
(Edgar Allen & Co. Ltd., Sheffield.)

such mills is the simplicity in construction ; no sieves are required, and hence there is freedom from breakdown.

(3) Ring-Roll Mills.—By far the best mills of this type are those patented by the Sturtevant

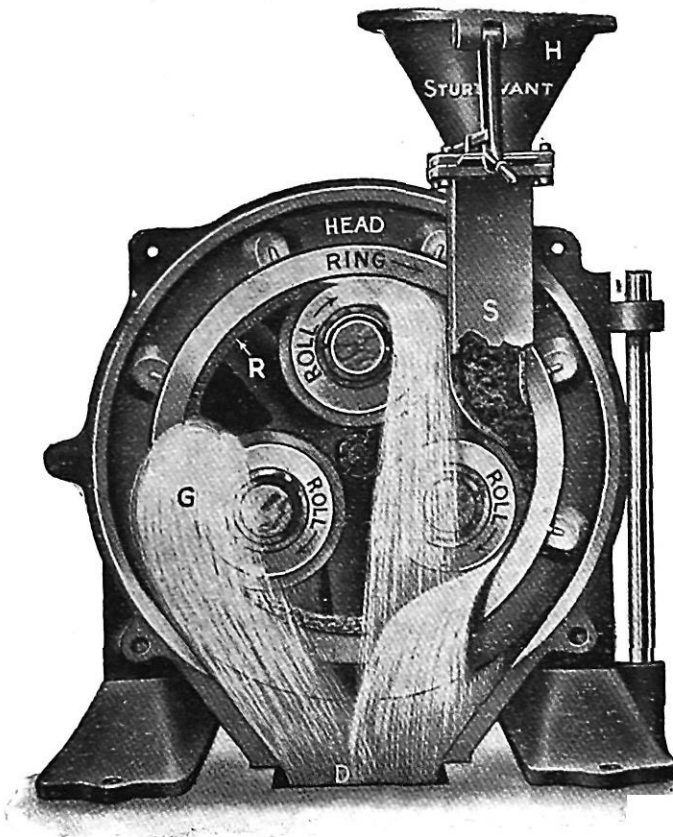

FIG. 5.—Ring-Roll Mill (section).  
(Sturtevant Engineering Co. Ltd., London.)

Engineering Co. Ltd., London. These essentially consist of a heavy steel anvil ring, concave on the inside (see Fig. 5), and revolved by a horizontal shaft. Three, so-called, hammer rolls are pressed against the ring with enormous force by springs, and a lever arrangement on the axles. These rolls are convex, and work free. The revolving ring drives all three rolls by means of an inch layer of centrifugally held material seen at R (Fig. 5).

The feed enters the hopper at H, and is delivered by the spout s at the centre of the concave surface of the ring, where it is strongly held by centrifugal force (seen at R), until the ground rock is crushed off on both sides of the ring (as at G), and discharged at D.

These mills are very durable, and give a large output, using little power. They have replaced many other grinding mills.

(4) **Roll Mills.**—The most efficient mill of this pattern is the Bradley three-roll mill (Fig. 6) manufactured by the Bradley Pulveriser Co., London. In the figure the upper and part of the lower shield are removed in order to show the working parts. Three rolls, free to move, are supported in a pendulum fashion from a central vertical shaft, and hang inside a fixed annular ring or die. When the shaft revolves, the rolls tend to rise by centrifugal action and crush against the ring. The crushing power varies with the speed of the shaft. The material to be ground is fed to a central hopper surrounding the shaft, and is distributed continuously on to the

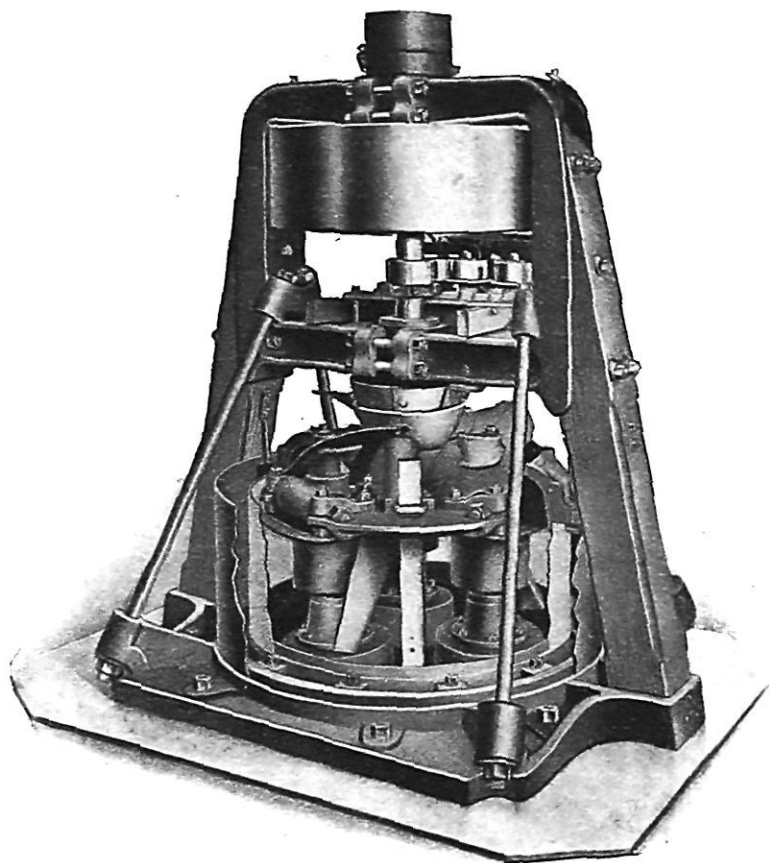

FIG. 6.—Bradley Three-Roll Mill.

(Bradley Pulveriser Co., London.)

ring directly in front of the three advancing rolls by long spouts (seen in Fig. 6); hence the material is fed exactly in the place where it is to be ground. This is a slow-running mill, and all the working parts are easily accessible.

The output of the Bradley three-roll mill, with phosphate rock, is as follows:—

On Florida high grade rock—2½-3 tons per hour; on Florida land pebble phosphate—3½-4 tons per hour, both ground to a fineness of 80-85 per cent. to pass a 100 mesh sieve (= 100,000 holes per square inch). A higher output up to 6 tons per hour is obtained with softer phosphate rocks.

(5) **Disintegrating Machines.**—In these machines disintegration is brought about by blows which are either on the supported or the unsupported particles of the material.

Mills of the first type are mostly **stamp mills**, and are chiefly used in the mining industry and districts. A very good disintegrator of the second type is "Carter's" Disintegrator, supplied by J. Harrison Carter, London, and seen in section in Fig. 7. It consists of a circular chamber lined with cast-iron plates which have grooved or ratcheted surfaces, F and G. The lower half of the circumference of the chamber is formed of screens H from ¼-3 in. mesh according to the required fineness of the finished product.

A strong spindle A passes through the centre of the chamber, and carries four or six iron beaters C attached to a very strong steel disc B. These beaters are replaceable, and run close to

the inner circumference of the grinding chamber, covering its whole width. The material to be ground is fed as near as possible to the periphery of the chamber, and there it meets the beaters

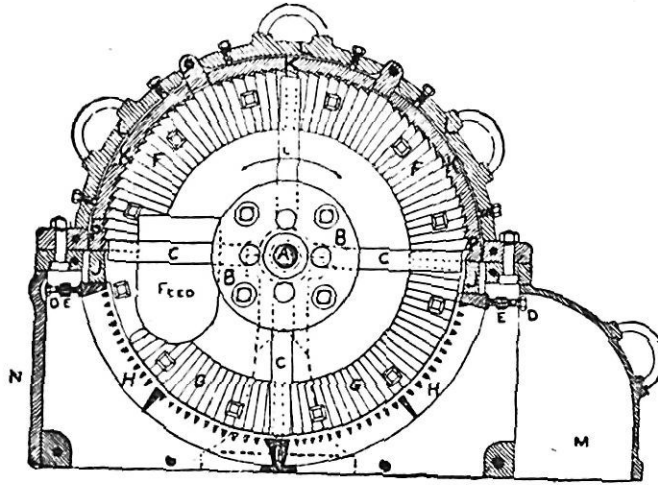

FIG. 7.—Section of Carter's Disintegrator.  
(J. Harrison Carter, London.)

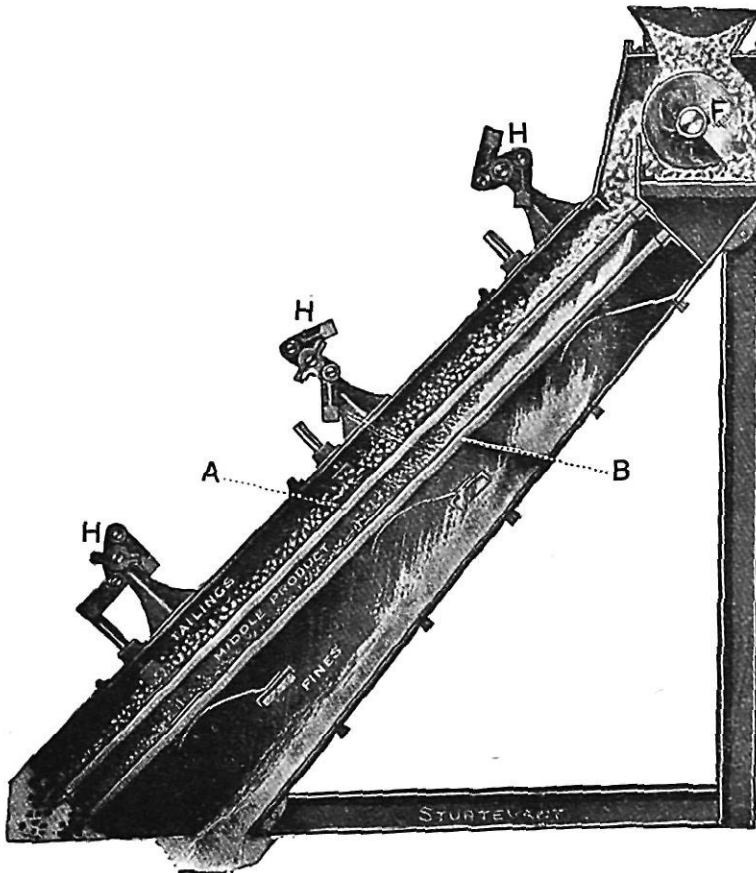

FIG. 8.—Sturtevant-Newaygo Separator.  
(Sturtevant Engineering Co. Ltd., London.)

while they are travelling at a high speed of 15,000-20,000 ft. per minute. The material is thus beaten and driven against the lining. As the particles become sufficiently fine they pass through the screens into the chamber below, the coarse particles being again operated on by the beaters, and finally reduced.

**Separators.**—These are used to separate the fine ground phosphate.

(1) **Screen Separators.**—An excellent machine of this type is the Sturtevant-Newaygo Patent Separator (Sturtevant Engineering Co. Ltd., London), seen in the diagram (Fig. 8).

The screens A and B are made of stretched wire cloth, and are subjected to very light and rapid blows from the hammers H, which cause the mesh to keep in constant vibration. These hammers are driven by gearing to the revolving feed F placed right along the top of the screen.

(2) **Air Separators** (see Fig. 9).—This type of separator consists of a funnel-shaped iron vessel having two casings H and G separated from each other. The material is fed from the hopper K on to the disc A, rotated by the pulley B. The lower part of the hopper, as well as the fan F, are driven by the pulley C.

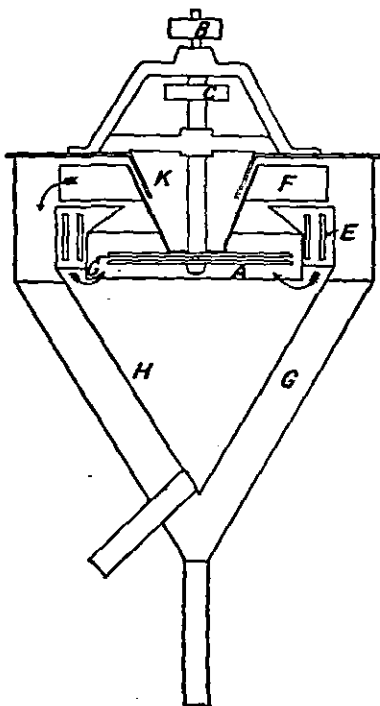

FIG. 9.—Section of an Air Separator.

The material is spread out in a fine stream by the plate A towards a fixed hood G directly below the fan. Here there is a strong current of air, produced by the fan F and coming through the slits E. This air stream carries the smaller particles forward into the chamber G, while the larger particles, too heavy to be carried up by the air, strike against G, and fall into the casing H. The degree of fineness of the finished product can be regulated by the speed of the fan.

### Complete Plant for the Treatment of Phosphate Rock

Fig. 10 shows a suitable plant for crushing, grinding, and screening phosphates, supplied by the Sturtevant Engineering Co. Ltd., London.

The material is first crushed in the roll-jaw fine crusher A, and falls into the "crushed rock bin" D, from which it passes, by gravity, to the ring-roll mill C, where the grinding takes place.

The ground material is next elevated to the Sturtevant patent separator B, where it is screened, the finely milled portion passes into the "fine rock bin" E, while the tailings pass on to the bin D for further treatment.

**Superphosphate.**—After milling, the powdered phosphate is treated with sulphuric acid in order to convert the insoluble tricalcium phosphate into soluble monocalcium phosphate or superphosphate:—

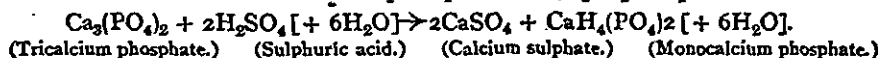

This formula does not represent exactly the chemical change that takes place. If a smaller amount of acid is used, insoluble dicalcium phosphate is formed, as in the following equation:—



Similarly, if a large amount of acid is added, the following change takes place, phosphoric acid being liberated:—



In the manufacture of superphosphate care must be taken to use the requisite amount of acid, because if it is present in large excess a sticky product will be the result, and this is liable to be reverted into insoluble calcium phosphate or "Precipitated" phosphate. Reversion also takes place if superphosphate is kept for a long time:—



Iron oxide and alumina may also bring about this change, hence care must be taken in mixing superphosphates with other manures.

**Process of Manufacture.**—Chamber acid of 1.55-1.60 sp. gr. is chiefly used; the quantity must be so adjusted that to one molecule of calcium phosphate there are rather more than two of acid; also sufficient acid must be added to convert the excess of lime (present as calcium carbonate and calcium fluoride) as well as the iron and aluminium oxides into sulphates:—

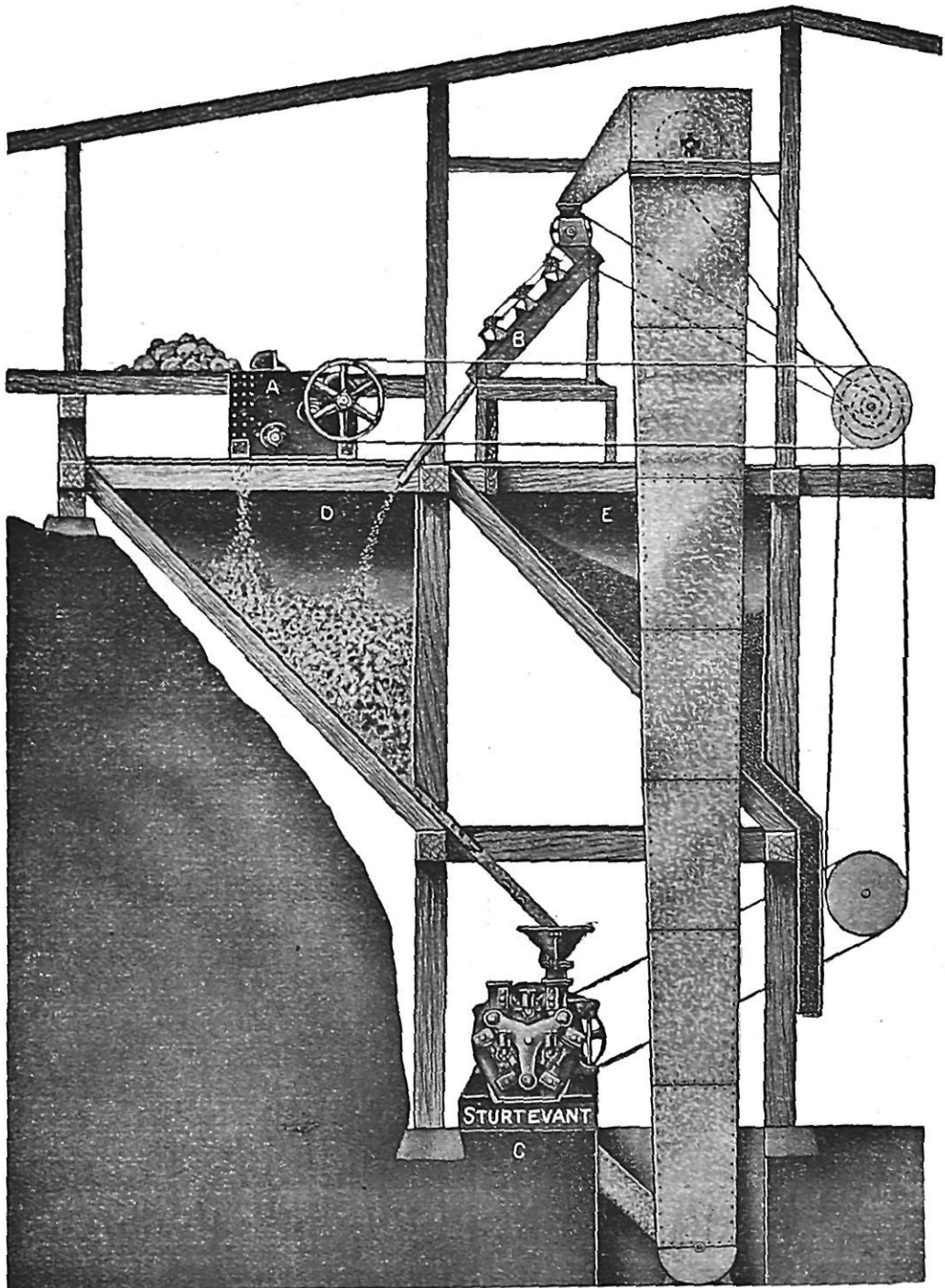

FIG. 10.—Phosphate Unit.  
(Sturtevant Engineering Co. Ltd., London.)

It is usual to effect this decomposition according to analysis. A general analysis is made of each batch of phosphate to be treated, and the calculated amount of acid, plus about 5 per cent., is added.

The acid must be used cold: sufficient heat will be evolved during the reaction to effect the decomposition. According to French Patent, 419,716, 1910, a little nitric acid added to the sulphuric acid accelerates the decomposition.

Fig. 11 shows the Milch patent superphosphate den supplied by W. J. Fraser & Co., of Dagenham, Essex.

The various grades of finely-milled phosphates are conveyed from storage bins to a weighing machine which empties a weighed quantity of phosphate into the mixer R (Fig. 11); next the requisite amount of acid is measured into the mixer by another machine working automatically in conjunction with the first. The mixture is now well stirred, and by opening a valve at the bottom of the mixer the contents fall into the chamber or den D where the action completes itself.

This chamber consists of a large cylinder D made of iron plates and mounted on running wheels, so that it can remain inside the large closed brick chamber C or be withdrawn. On either side of the cylinder D there is a long screwed shaft S, which works in threads fixed on the side of the cylinder; by rotating these shafts, the cylinder D can be slowly drawn out of the chamber C.

There is an opening all along the top and bottom of the cylinder D. The bottom opening is

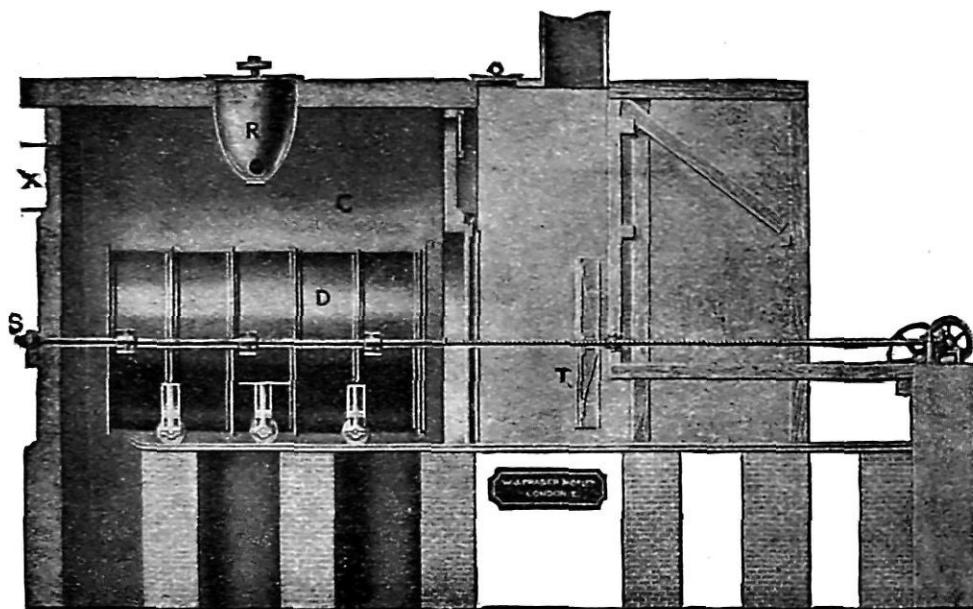

FIG. 11.—Milch Patent Superphosphate Den.  
(W. J. Fraser & Co., Dagenham.)

closed by means of heavy wooden doors during the process of filling. The back end of the cylinder consists of a permanent steel plate, while the front is left open and closed by a wooden door bolted on.

After the cylinder D has received its charge of mixed acid and phosphate (15-40 tons according to size), it is allowed to stand for a short time inside the brick chamber C; sufficient heat is developed to carry out the change into superphosphate.

The acid gases which escape both at this stage and in the subsequent excavation of the superphosphate are carried away by a ventilating shaft X, which is connected with a fan to absorption towers. Modern arrangements are described in Vol. I., p. 417, under *The Hydrofluoric Acid Industry*.

Next the front door of D is removed, and the bottom doors dropped on their hinges, and the work of excavating the superphosphate from D is now commenced.

Many difficulties have been experienced in the manner of excavating the superphosphate from the den D: firstly, the material must be cut away without any rubbing action, which spoils its physical condition; secondly, there must be no undue pressure which might spoil its chemical condition; and thirdly, the difficulty from the corrosive action of the chemicals and gases must be overcome.

In the Milch chamber and most other dens the excavating is carried out automatically. A revolving knife T of rather less diameter than the cylinder D is arranged on a third shaft and fixed in front of the cylinder (as shown).



When the machinery is started the knife T is caused to rotate about fifty times per minute; simultaneously the screw shafts rotate which slowly draw the cylinder D towards the knife T. The material in the drum is thus shaved off to a very fine powder which falls inside the cylinder and drops through the bottom opening on a special conveyer by which it is taken to the storage sheds.

The power needed for such a plant is comparatively small, and the output per day amounts to about 160 tons.

Fig. 1 shows in detail an excellent up-to-date plant (made by Bakema, of Amsterdam) for the manufacture of superphosphate.

In some cases the chamber is placed vertically and the lower end removed for emptying (English Patent, 15,940, 1910). Other recent patents referring to superphosphate dens and manufacture are:—English Patents, 11,215, 1906; 18,523 and 24,249, 1910; 19,572, 1912 (U.S. Patent, 1,040,081); also French Patents, 422,875, 1910; 425,210, 1910; and German Patent, 257,191, 1911.

The product, **superphosphate of lime**, is generally called “super-

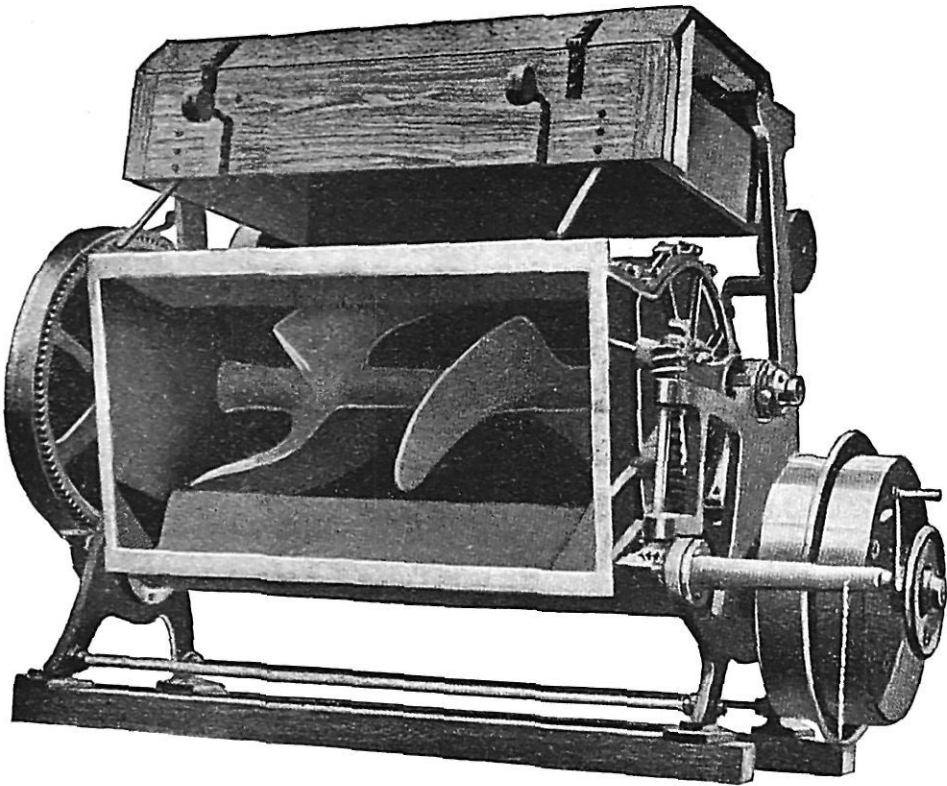

FIG. 12.—“Single-Blade Mixing Machine.”  
(Werner, Pfeiderer, & Perkins Ltd., Peterborough.)

phosphate” or “**mineral superphosphate**.” The strength varies according to the material used, and is judged by the amount of phosphate soluble in water, and in a 2 per cent. citric acid solution. Usually superphosphates contain 25-28 per cent. of soluble phosphate, but some samples contain a much higher percentage.

Superphosphate should be in a friable and dry condition or else it will clog the drills when used for manuring. The colour of the sample is not a criterion as to the quality.

**Basic Superphosphate.**—This contains excess of lime and is made by neutralising the excess of acid in superphosphate by lime. According to English Patent, 3,327, 1912, if superphosphate is heated to about 825° C. the calcium sulphate is decomposed, and sulphuric acid is driven off, forming lime. Water also passes off, forming a basic superphosphate containing about 40 per cent. of lime.

**Double Superphosphate** contains some 45 per cent. water-soluble phosphoric acid, and is made as follows: Phosphoric acid solution is first obtained

by the action of sulphuric acid on natural phosphates, and filtering off the gypsum formed.

The solution is now evaporated in covered pans, and stirred with the requisite quantity of phosphate meal, then drying the double superphosphate which is formed.

Phosphoric acid prepared in this manner is also used for making potassium, sodium, and ammonium phosphates.

**Dissolved or Vitriolised Raw Bones.**—Manures of this type are prepared by treating crushed bones with sulphuric acid, which converts the calcium phosphates into an acid phosphate.

A suitable mixer, and one that will resist the action of the acid, is made by Werner, Pfeiderer, & Perkins Ltd., of Peterborough. This is shown in Fig. 12, tilted to empty the contents.

**Raw unsteamed bones** should be used in the manufacture, and excess of acid must be avoided as it forms a pasty mass.

In order to obtain a good product the bone meal should be in a fine condition, and the mixing well carried out. Dissolved bone meal usually contains 30-35 per cent. of total phosphate and nitrogen equivalent to 3-3.5 per cent. ammonia. If steamed bones are used the product will not be so rich in nitrogen.

Analyses of various raw and steamed bone meal (according to J. Richardson, York) are as follows:—

	Raw Bone Meal.	Steamed Bone Meal.
Moisture - - - - -	9.10	6.30
* Organic matter - - - - -	35.96	12.90
† Phosphoric acid - - - - -	22.00	32.10
Lime - - - - -	29.20	41.97
Magnesia, alkalis, etc. - - - - -	2.74	6.58
Insoluble siliceous matter - - - - -	1.00	0.15
	100.00	100.00
* Containing nitrogen - - - - -	4.27	1.38
Equivalent to ammonia - - - - -	5.18	1.67
† Equal to tribasic calcium phosphate - - - - -	48.04	70.07

**Dissolved Bone Compounds.**—These are made by mixing dissolved bone meal with water-soluble mineral phosphates. Sometimes other substances, such as dried blood, guano, etc., are added to the bones before dissolving in the acid.

The composition of such manures naturally varies: a good quality sample contains about 30 per cent. total phosphates, of which 20 per cent. is soluble in water, and 1.25 per cent. nitrogen (equal to 1.5 per cent. ammonia). A poorer sample may only contain nitrogen up to about 1 per cent. ammonia.

**Basic Slag.**—(Otherwise known as basic cinder, basic phosphate, Thomas slag, Thomas meal, or Thomas phosphate.)

This is a by-product of the Thomas-Gilchrist process for the Bessemer conversion of phosphatic pig iron into steel. The phosphorus, at the high temperature of the molten iron, is converted into tetra-calcium phosphate by combining with the coating of lime in the converter; this phosphate, unlike tri-calcium phosphate, is soluble in citric acid solution.

The actual percentage of phosphate in the slag varies considerably; medium grade slag contains about 30 per cent., and the best grade about 40 per cent. of phosphate calculated as  $\text{Ca}_3\text{P}_2\text{O}_8$ . The same tetra-phosphate, under the name of Wiborgh-phosphate, is formed in Germany by heating mineral phosphates with soda.

Basic slag is a very heavy material, and when finely ground forms an excellent

manure, the phosphorus being more readily available than in the case of natural phosphates.

The preparation of the slag as a manure simply consists in fine crushing and separating.

This is usually carried out at the iron works. Some of the most suitable mills used in this work are ball or ball-tube mills (see p. 24), whilst air separation is the best. On the average about 80 per cent. of the slag should pass through a sieve of 10,000 meshes to the square inch. According to English Patent, 63, 1902, Thomas slag is converted into a powder by the action of steam.

The value of the meal depends on the percentage of citric-soluble phosphoric acid it contains. In good slag 80-90 per cent. of the total phosphoric acid should be soluble in a 2 per cent. citric acid solution.

Two typical analyses of basic slag, as given by J. Richardson & Co., are as follows:—

	30% Grade.	39% Grade.
Silica - - - - -	12.60	8.10
Peroxide of iron - - - - -	10.87	10.20
Protoxide of iron - - - - -	7.01	8.54
Protoxide of manganese - - - - -	6.19	5.34
Lime - - - - -	44.53	45.42
Magnesia - - - - -	4.12	3.63
Sulphur - - - - -	0.27	0.41
Phosphoric acid - - - - -	14.41	18.36
	100.00	100.00

Basic slag is suitable for clay and peaty soils, moorland, fruit, and vineyards, and generally all lands poor in phosphoric acid. The action is somewhat slower than in the case of superphosphate, but the actual cost of the phosphoric acid in the slag is about three-quarters the price of that contained in superphosphate.

The annual output of slag in the United Kingdom now amounts to some 400,000 tons, of which about 220,000 tons are used for home consumption. The Continental production alone is estimated at 3,000,000 tons, while over 2,200,000 tons were used annually in Germany.

## II. PHOSPHO-NITROGENOUS MANURES

**Bones.**—(a) **Raw and unsteamed bone manure** is rich in phosphorus and fairly rich in nitrogen.

**Crushing.**—Bones are crushed in any suitable mill; the type usually used consists of a pair of toothed rollers between which the bones pass. Unless the bones are finely crushed they are best used on the land early in the season on account of the time taken to decompose.

Good raw bone meal contains 40-50 per cent. phosphates, and 3.5-4 per cent. nitrogen (equivalent to 4.5 per cent. ammonia). English raw bone meal generally contains 45 per cent. phosphates and 3.5 per cent. nitrogen:—

Indian bone meals have been placed on the market, and are usually slightly richer than the English varieties.

Raw bone meal is more often used for permanent pastures than for crops, on account of its slow rate of action.

(b) **Steamed or Degelatinised Bones.**—Crushed bones are treated with superheated steam and benzene to remove the fat and glue (for description of process, see **Martin's "Industrial Chemistry: Organic,"** pp. 31 and 595). The bones after treatment contain only about 1 per cent. of the nitrogen, and after grinding are sold as "steamed bone meal":—

Another method of extraction is to soak the bones in 8 per cent. hydrochloric acid for some days. This takes out all the phosphate, which is then thrown down as dicalcium phosphate by lime; the so-called "Lime Precipitate" is citric soluble, and is an excellent manure, only it is fairly expensive.

The value of steamed bone meal is less than raw bones on account of the smaller nitrogen content; the amount of phosphates is, however, higher.

**Flesh Meal** (flesh guano or meat meal) is obtained from the carcasses of horses and other animals, the putrid animal refuse from slaughter-houses, garbage, etc.

Suitable plants have been designed and are in operation at various places. The refuse is placed in a sieve in an iron cylinder into which superheated steam is passed; after a few hours the meat becomes thoroughly cooked. The fat and gelatine broth drop down and are collected; the evil-smelling steam is also collected by condensation. The solid matter after straining is reduced, by pulverising, to a pulp and then conveyed to a suitable drying apparatus. The dried product is called **flesh meal** and is completely scentless: it contains 6-8 per cent. nitrogen and 6-15 per cent. phosphoric oxide.

The water or tannage that separates from the above cooking is stored in vats, heated to 170° F., and the grease removed as completely as possible; this is important, because if grease is present, it interferes with the evaporation. The liquid is now evaporated in a suitable machine, the dried product being used as a manure. (See English Patents, 23,045, 1904; 24,492, 1906; 21,630, 1908; 15,654, 1909.)

The so-called "**Fray-Bentos**" guano is produced in a similar manner from the residue during the manufacture of Liebig's extract of meat.

**Fish Manures or Guanos**.—These are largely made from the residue and offal from fisheries, and sometimes (as in America) from whole fish.

The fish scrap is carried in a continuous stream to the **cooker or digester** (Fig. 13 (A)).

This consists of a horizontal cylinder to one end of which is fitted a mechanical feeder. A long hollow steel shaft, capable of being rotated, passes through the cylinder, and carries a special spiral conveyer which, by rotation, continually moves the material through the cooker. The shaft is also provided with hollow radial arms, and pierced with numerous holes.

The fish scrap is thoroughly disintegrated by the rotating of the shaft, and cooked in a few minutes by the steam which passes through the shaft and arms.

When the material reaches the other end of the cylinder, it is automatically conveyed to the **press** (Fig. 13 (B)).

The central rotating hollow shaft of the press carries a tapering pressing screw which revolves in a similar conical steel casing. The wet material is fed by means of a mechanical device, and discharged at the smaller end of the machine thoroughly pressed. The pressure on the material is regulated by the size of the opening at the discharge end.

Steam may be passed into the material from the shaft during pressing; this is advantageous in pressing substances which contain much grease or oil. The water and oil which separate during pressing drain away into large settling tanks where the oil is separated. From the discharge end of the press the material is fed to the **drier**. That shown in Fig. 13 (C) is a **direct heat rotary drier**, and reduces the moisture to about 10 per cent.

The long rotating cylinder is slightly tilted from the furnace end, and is provided inside with a number of shelf-like vanes. The material and furnace gases enter at the higher end. The wet material falls to the bottom, but is elevated by the shelves to the highest point in the cylinder, and is then showered through the hot furnace gases. This operation is repeated until the dried material is discharged at the lower end of the drier.

**Wet Fish Scrap**.—In some cases the fish scrap as it comes from the press is acidulated with sulphuric acid of 60° Bé. (60-80 lbs. per ton of wet scrap). This converts the bone phosphates into the soluble form, and also prevents the material from decomposition. Good fish scrap contains 50 per cent. water, and 7.5-7.75 per cent. ammonia.

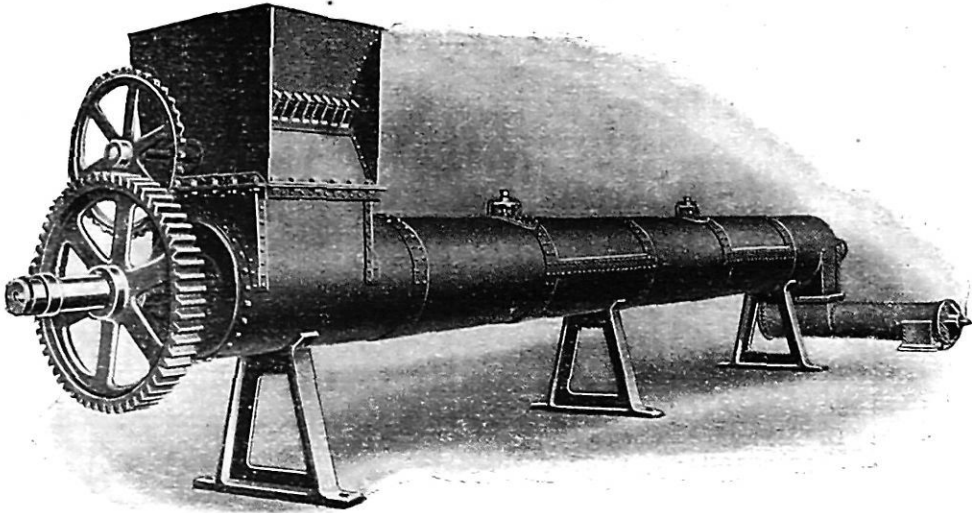

(A) Automatic Continuous Cooker or Digester.

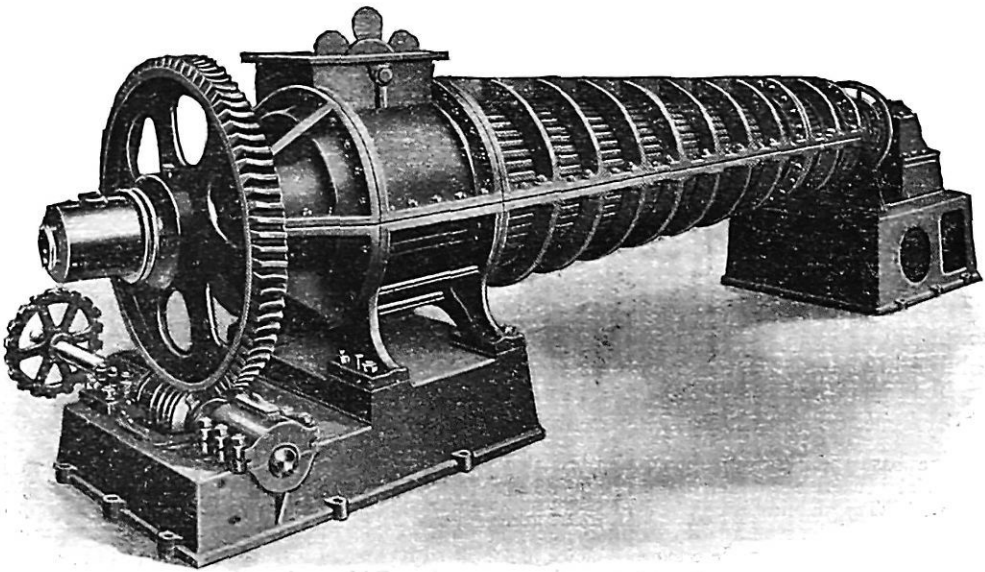

(B) Automatic Continuous Screw Press.

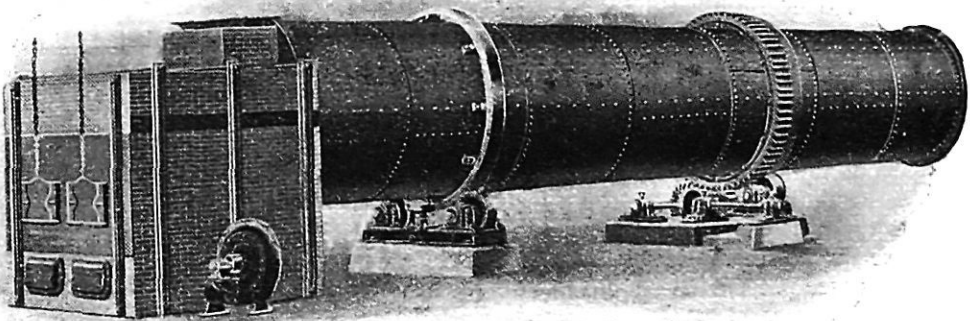

(C) Direct Heat Rotary Drier (with ring gear).

FIG. 13.

(American Process Co., New York.)

**Whale Meal** (or whale guano) is a variety of fish manure made from the refuse from whales.

The oil should be removed as completely as possible from fish scraps, because if present in the manure it hinders the decomposition, and is itself useless as a manure. Dry fish manure should be stored carefully on account of its great combustibility due to the residual oil. If stored in large heaps, fires may be caused by spontaneous combustion.

(See English Patents, 3,470, 8,483, 9,773, and 25,425 for 1901; 18,741, 1902; 15,319, 1903; 9,018, 1904; 23,399, 1907; 19,706, 1910; and 18,365, 1911.)

ANALYSES OF FISH GUANOS. (H. Richardson & Co., York.)

	Fish Meal.	Whale Meal.
Moisture - - - - -	9.10	5.74
* Organic matter and water of combination -	65.44	59.98
Phosphoric acid - - - - -	8.82	12.79
[Equal to calcium phosphate] - - - - -	[19.28]	[27.93]
Lime - - - - -	10.10	16.60
Magnesia, alkalis, etc. - - - - -	3.32	1.87
Insoluble siliceous matter - . . . .	3.22	3.02
	100.00	100.00
* Containing nitrogen - - - - -	7.21	6.63
Equal to ammonia - - - - -	8.75	8.06

### III. NITROGENOUS MANURES

(a) **Inorganic—Nitrate of Soda, or Sodium Nitrate**,  $\text{NaNO}_3$  (Chile saltpetre) (for occurrence, preparation, etc., see Vol. I., p. 431).—This is one of the most concentrated forms of nitrogen, and a manure in which the nitrogen is in a condition very easily available by plants. The reason for this is that nitrate is very soluble in water.

The usual standard for good quality nitrate of soda is "at least 95 per cent. purity," *i.e.*, containing 15.6 per cent. nitrogen, equivalent to 19 per cent. ammonia.

The base soda ( $\text{Na}_2\text{O}$ ) of the nitrate can hardly be called a fertilising ingredient, but it is beneficial because its action on clays in the soil causes decomposition, during which potash is liberated. This manure is chiefly used as a top dressing on account of its great solubility. The effect on the plant can be seen in a few hours by a change in the colour of the leaves.

Saltpetre is not a complete manure, since it supplies only one essential constituent of plant food, *i.e.*, nitrogen, and for most purposes it should therefore be used in conjunction with phosphates, etc.

**Ammonium Sulphate**,  $(\text{NH}_4)_2\text{SO}_4$  (for preparation, etc., see Vol. I., pp. 453 *et seq.*).—This is practically the only ammonium compound on the market as a fertiliser. Ammonium sulphate contains about 20-21 per cent. nitrogen, equivalent to 24-25 per cent. ammonia.

The nitrogen in the form of ammonia is not so easily assimilated by plants as it is in the nitrate form: this is because the ammonia has to be converted into nitrate in the soil by the action of nitrifying bacteria before being available for plant use (see Vol. I., pp. 427-429).

The addition of **Common Salt** to ammonium sulphate is said to increase the fertilising power (*Journ. Soc. Chem. Ind.*, 1911, p. 40).

Ammonium sulphate should not be applied to soil soon after limeing, and is not very suitable (unless on grass) for wet clay soils where the want of good aeration makes the nitrifying process slow and imperfect. It is a very valuable nitrogenous manure for corn crops, potatoes, etc., while it is very suitable for making mixed manures (see p. 41). It should not be used too frequently on soils poor in lime.

**Calcium nitrate**, lime nitrate, lime saltpetre,  $\text{Ca}(\text{NO}_3)_2 \cdot 2\text{H}_2\text{O}$  (for preparation, properties, etc., see Vol. I, p. 435).—This is a comparatively new fertiliser, and is

rapidly becoming a valuable nitrogenous manure, competing closely with sodium nitrate.

Nitrate of lime usually contains about 13 per cent. nitrogen, equivalent to 16 per cent. ammonia (if of 95 per cent. purity it contains 15.6 per cent. nitrogen equal to 19 per cent. ammonia), and is directly assimilable by plants without having to undergo any change in the soil. It is hygroscopic, and is best employed in the basic state  $[\text{Ca}(\text{NO}_3)_2 \cdot \text{CaO}]$  on account of its greater stability.

It can be rendered dry and non-deliquescent by mixing with an absorbent substance, such as sodium sulphate or calcium sulphate (English Patent, 24,297, 1903). According to German Patent, 22,9163, 1909, a mixture of solutions of calcium nitrate and nitrite on evaporation (the nitrate nitrogen being less than 15 per cent. of the total) forms a dry, friable powder which is not deliquescent.

Calcium nitrate like sodium nitrate is specially suitable for top dressing on account of its hygroscopic nature, which causes it to find its way into the soil very easily.

The results of recent experiments show that nitrate of lime gives the best result of all manures.

(b) **Organic—Calcium Cyanamide** ("lime nitrogen" or "nitrolime").—This is the calcium compound of hydrocyamic acid,  $\text{Ca}=\text{N}-\text{C}\equiv\text{N}$  (for preparation, etc., see Vol. I., p. 475). It is a black compound, and contains 19-20 per cent. nitrogen, 40-60 per cent. lime, and 12-14 per cent. carbon. When exposed to the air water is taken up by the lime, but there is no loss of nitrogen as was formerly supposed.

Raw nitrolime may contain small quantities of carbides, phosphides, and sulphides as impurities; these are undesirable in manures, because the corresponding gases (*i.e.*, acetylene,  $\text{C}_2\text{H}_2$ , phosphine,  $\text{PH}_3$ , and hydrogen sulphide,  $\text{H}_2\text{S}$ ) are all poisonous to vegetation, and particularly to seedlets, and during germination. Several processes have been introduced and much machinery designed to prepare a good product from crude calcium cyanamide, suitable for use as a fertiliser. The object of these is to hydrate all the caustic lime, and discharge or expel these poisonous gases from the raw material. A granular product may be made by mixing with molasses to hydrate the nitrolime, then drying and grinding (French Patent, 444,933, 1912).

The use of nitrolime as a manure depends on the reaction it undergoes with water into calcium carbonate and ammonia—

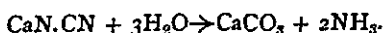

Its decomposition in the soil is not so simple as shown by this equation, but probably takes place in stages.

First atmospheric carbon dioxide and water form cyanamide—

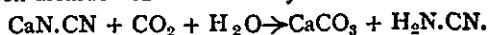

Then this is converted into urea by further action—

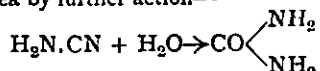

Urea by ammonia fermentation yields ammonium carbonate—



This can be assimilated either direct by plants or indirectly after being converted into nitric acid by nitrifying bacteria.

The decomposition in the soil is said to be due to inorganic catalysts as well as bacteria (*Journ. Soc. Chem. Ind.*, 1911, p. 101).

The presence of the lime in calcium cyanamide has a valuable action during manuring: it prevents the soil becoming acid, thereby causing abundant growth of the nitrifying bacteria, which cannot live in acid soil.

Calcium cyanamide is not pleasant to handle, and the dust is injurious. U.S. Patent, 1,049,953 (1913), refers to making a non-dusting product from calcium cyanamide.

**Nitrolime**, as now manufactured, can be stored for a good time under ordinary conditions without damage or loss of fertilising power, and may be mixed in any proportion with other manures without evolution of heat or loss of ammonia. It

is claimed that unit for unit nitrolime is equal in value to sodium nitrate or ammonium sulphate, but it is not suitable for top dressing, although it does not injure germination. It is a good deal dependent upon the season for its rapidity of action.

The fertility of calcium cyanamide may be increased by adding iron oxide (powdered bog iron ore). (*Journ. Soc. Chem. Ind.*, 1912, p. 941.)

A stable "nitrolime" fertiliser may be made by mixing the raw material with calcium nitrate, then drying and grinding the product (German Patent, 252,164, 1909). A similar powder can be made by mixing with alkaline silicates, etc., and partially hydrating (French Patent, 423,072, 1910).

According to German Patent, 242,522, 1910, the mixing of nitrolime, before its application to the soil, with a colloidal substance, or one readily converted into the colloidal condition (e.g., iron oxide), causes the transformation into urea to be accelerated.

"Nitrolime" in a fertiliser may be detected by its odour, alkaline reaction, and abundance of lime in the ash.

The analysis of fairly pure calcium cyanamide is as follows (Rogers and Aubert):—

Calcium cyanamide	-	-	-	-	29.26	} Total nitrogen = 17.01 per cent. Total lime = 34.73 per cent. Nitrate nitrogen = 3.39 per cent. Cyanamide nitrogen = 13.62 per cent.
Calcium carbonate	-	-	-	-	0.21	
Calcium nitrate	-	-	-	-	20.06	
Slaked lime	-	-	-	-	28.78	
Sodium cyanamide	-	-	-	-	10.38	
Free carbon	-	-	-	-	7.89	
Silica, alumina, iron oxide, etc.	-	-	-	-	3.42	
<hr/>						
100.00						

**Rape Cakes and Meals** (for manufacture see **Martin's "Industrial Chemistry: Organic" (Oil Extraction)**).—These contain about 4-5 per cent. nitrogen, and a little potash and phosphates. **Rape cakes** and **Rape dust** are gradually decomposing fertilisers, and are specially suitable for potatoes and corn. They are prepared from rape seed which has not been completely oil-extracted. The best variety is East Indian rape cake, in which the nitrogen is as much as 6.5 per cent.

**Rape Seed Meal**, on the other hand, is produced by the newer chemical oil-extracting processes, and the nitrogen content is somewhat higher than in rape dust; the price is, however, lower because it takes longer time to decompose in the soil.

**Castor Oil Meals** are similar in character to rape meals, and are the residues from the castor oil beans after chemical extraction of the oil. For manufacture see **Martin's "Industrial Chemistry: Organic" (Oil Extraction)**.

Similar manures are often made from damaged feeding cakes, etc.

ANALYSES OF THESE MANURES. (J. Richardson & Co., York.)

	East Indian Rape Cakes.	Oil-Extracted.	
		Rape Seed Meal.	Castor Meal.
Moisture - - - - -	10.84	10.88	10.34
*Organic matter - - - - -	81.14	72.78	79.42
†Phosphoric acid - - - - -	2.43	1.92	1.52
Lime - - - - -	1.30	2.60	1.08
‡Magnesia, alkalis, etc. - - - - -	2.59	4.00	3.36
Insoluble siliceous matter - - - - -	1.70	7.82	4.28
	100.00	100.00	100.00
* Containing nitrogen - - - - -	5.32	5.12	4.66
Equal to ammonia - - - - -	6.46	6.21	5.66
† Equal to tribasic calcium phosphate - - - - -	5.31	4.19	3.32
‡ Containing potash - - - - -	1.42	1.40	1.19



**Blood Meal** is a very rich manure, containing on an average 11-13 per cent. nitrogen and 0.75 per cent. phosphoric acid, and rots rapidly in the soil. It is prepared by coagulating blood from slaughter-houses, etc., drying and grinding the product. The manufacture is carried on in America, and also in our own country, the product fetching a good price.

Blood meal is becoming less used as a manure, its place being taken by chemical manures. Dried blood is now mostly bought by manufacturers and converted into compound manures.

**Horn and Hoof Meals.**—Scraps of horn, hoof shavings, etc., are ground to form a meal; sometimes, however, they are heated or treated with superheated steam previous to grinding.

The meal must be finely ground, because horn is insoluble and decays slowly. The product is very rich in nitrogen, containing some 14 per cent. or more, and is chiefly used for vines, roses, and making mixed manures. The use as a manure is becoming less.

**Wool, Shoddy, Rags, etc.**—These are not suitable manures for ordinary farming, but are useful for crops such as hops and grapes. Wool, when dry, often contains 16-17 per cent. nitrogen, and as shoddy 13 per cent. The wool in shoddy is finely broken up by mechanical means.

These products are useful if obtained cheap; the value is diminished if they contain oil and dirt. Sulphuric acid is sometimes mixed with shoddy to form a manure (English Patent, 24,647, 1906). Hair and feathers form a fertiliser of similar composition to the above. The principal protein substance in all these is "Keratin."

**Skin and Leather Meals.**—The trimmings and waste from leather works are ground so as to form a meal. Samples of ground leather are difficult to obtain, the trade being a hidden one, and the product sold under the name of "Nitrogenous Fertiliser." The meal contains 4-6 per cent. nitrogen, and is little used as a manure on account of its slow decomposition. According to English Patent, 11,644, 1908, the residue from the dry distillation of leather is used as a manure.

Suitable products for manuring may be prepared by treating wool, leather, horn, etc., with superheated steam, sulphuric acid, or both, and a solvent like benzene for removing fat (English Patents, 12,844, 1910, and 27,266, 1911; also French Patent, 437,628, 1911, and U.S. Patent, 1,049,482, 1913).

**Soot** may contain up to 35 per cent. ammonium sulphate, and has been much used for manurial purposes. Soot also exerts a mechanical effect on clay lands. In buying soot for farming, care should be taken to obtain chimney soot rather than shaft soot, which only contains a little nitrogen.

**Analysis of Soot** (*Mark Lane Express*, 1913, Vol. CIX., p. 579) :—

	Shaft Soot.	Chimney Soot.
Nitrogen - - - - -	0.26	6.72
Equal to ammonium sulphate - - -	1.7	38.7
Ash - - - - -	62.48	18.04
Moisture - - - - -	17.0	6.59

**Bacterial Manures.**—Many such manures have been tried from time to time, but so far have not proved very satisfactory.

They chiefly consist of pure cultures of bacteria from the nodules that occur on the roots of leguminous plants (English Patent, 694, 1901).

These bacteria are able to assimilate nitrogen direct from the air, but only in the presence of carbon compounds (*Chemical News*, 21st September 1910).

It is still held by one class of agriculturists that soil inoculation is one of the solutions of the great problem of manuring for certain crops.

**Nitraria** is a culture of bacteria occurring in the nodules of legumes. The chief organism is *B. radiocoli*. Pure cultures of this bacillus have not been found successful for soil inoculation. It is best to prepare the culture from several varieties of nodules, *i.e.*, peas, beans, etc.

Cultures of azotobacter and pseudo-monas have been tried with some success.

English Patent, 19,902 (1908), and U.S. Patent, 982,569 (1911), deal with the preparation of a culture of organisms that will increase the growth of non-leguminous plants.

**Use of Waste Products for Making Manures.**—This should be an important source of both nitrogen, phosphates, and potash, and should receive careful attention from the chemist.

Many patents exist for the utilisation of waste products for making fertilisers. The chief English Patents are :—

9,514, 1901; 11,645, 1902; 2,519, 6604, and 16,607, 1903; 18,484, 1904; 2,591 and 2,591A, 1907; and 25,108, 1910, using waste from breweries and distilleries.

15,266, 1902; 7,921, 1903; 23,055, 1906, using molasses and yeast; 8,088, 1901, and 8,779, 1908, using cellulose waste products; 20,679, 1902, using sawdust, etc.

#### IV. POTASH MANURES

Potash in some form is almost indispensable to the growth of all cultivated crops; it is needed for the production of albuminoids, and helps the formation of carbohydrates. Potash occurs in all parts of the plant, and particularly in the seeds; about one-third of the ash of plants is  $K_2O$ .

The effect of potash manuring varies according to the soil; cultivated land is not usually poor in potash. Sandy, gravelly, chalky, and peaty soils, as well as reclaimed fenland and moorland, are those on which potash is most likely to have a good effect. These manures are profitable, especially for meadow grass, clover, tobacco, cotton, coffee, potatoes, legumes, corn, etc.

**Agricultural Consumption of Potash in the World** (*Mark Lane Express*, Vol. CIX., p. 271, 1913).—Expressed as tons of pure potash ( $K_2O$ ). It takes 8 tons of kainit, 2 tons of 90 per cent. sulphate, or 2 tons of 80 per cent. chloride of potash to yield 1 ton of pure potash :—

	Consumption (Tons $K_2O$ ).	Consumption (Lbs. $K_2O$ per 100 Acres).
Germany - - - - -	422,355	1,056
United States - - - - -	144,034	75
Holland - - - - -	34,374	1,491
France - - - - -	26,468	70
Sweden - - - - -	17,452	439
Russia - - - - -	17,079	11
Austria - - - - -	15,564	94
Spain - - - - -	9,845	38
Belgium - - - - -	9,101	424
England - - - - -	11,637	149
Scotland - - - - -	6,539	387
Ireland - - - - -	2,996	121
Italy - - - - -	6,051	33
Denmark - - - - -	5,632	193
Switzerland - - - - -	2,674	105
Norway - - - - -	2,282	349

The chief source of potassium salts is the Stassfurt deposits (see Vol. I., p. 329).

The following are the chief Potash Manures :—

**Kainit** (see Vol. I., p. 330).—This is a natural salt from Stassfurt, and is a cheap manure. It usually contains about 23 per cent. potassium sulphate (equal to 12.5 per cent.  $K_2O$ ), 27 per cent. magnesia salts, and 4 per cent. common salt. The colour is white to reddish brown, but this is no evidence as to the quality.

**Muriate of Potash** (potassium chloride,  $KCl$ , see Vol. I., p. 335) is the most concentrated and soluble salt of potash, consequently it is suitable for top dressing. The potash content varies according to the purity of the salt, and is usually 50-55 per cent.

**Sulphate of Potash** ( $K_2SO_4$ , see Vol. I., p. 337) is not so soluble as the chloride, but nevertheless is an excellent manure. As generally sold, it is of 90-95 per cent. purity, containing about 48-52 per cent. potash.

**Nitrate of Potash** ( $KNO_3$ , see Vol. I., p. 433) is an excellent manure, because it contains both nitrogen, as nitrate, and potash. When pure the value is too high to enable it to be used as a manure, but impure nitrate can be obtained at a moderate price. The purity of such nitrate is about 95 per cent., and it contains 44 per cent. potash as well as 13 per cent. nitrogen (equal to 16 per cent. ammonia).

Other potassium salts used for manuring are carnallite, kieserite, potassium phosphate, and sometimes chlorate of potash.

## V. MISCELLANEOUS MANURES

**Salt** (sodium chloride,  $NaCl$ , Vol. I., p. 261).—This is useful for applying to mangels, cabbages, and other crops, so-called "broad" salt or ground rock salt being used for the purpose. Soiled fish curing salt contains a certain amount of oil, and is not very effective for agricultural use. It can be obtained at a low price.

**Calcium or Lime Manures** are used on soils which contain little calcium.

**Quicklime** (see p. 78, also Vol. I., p. 341) is of great use in order to neutralise the acidity of the soil which hinders the growth of the nitrifying organisms. Lime also tends to improve the mechanical condition of the soil, increasing its porosity and general condition. Sometimes slaked lime is used, but this is heavier than quicklime, and consequently the cartage is more expensive.

**Calcium Carbonate** (see p. 78, also Vol. I., p. 341).—Unburnt limestone has been found to be better than quicklime on certain soils, especially on light porous soils. The cost is less than lime, but the amount of lime in limestone is only 56 per cent. Ground shells have been used as a calcareous manure.

Calcium carbide residues may be used on the soil, according to Golach and Schulze, without harm.

**Silicate Manures.**—Plants cannot assimilate silica in the form of quartz. According to Witt, waterglass and potassium silicate possess great possibilities as manures, particularly for growing maize and cereals which contain much silica.

## VI. MIXED MANURES

Manures containing more than one fertilising ingredient may be made by mixing together two or more manures of a special character in suitable proportions.

It is very important to mix the fertilising materials thoroughly in order to obtain a product of uniform composition, and consequently efficient mixing machines should be used. Fig. 14 shows the interior view of the "Sturtevant Hurso Mixer." This machine is capable of mixing to an

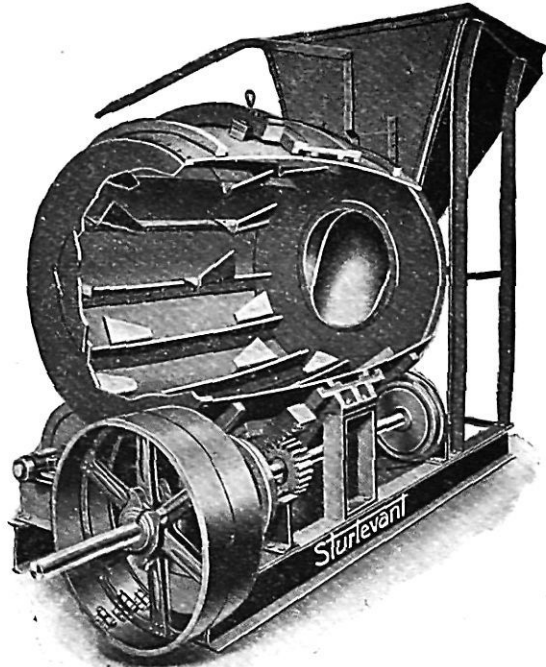

FIG. 14.—Interior View of Mixing Machine.  
(Sturtevant Engineering Co. Ltd., London.)

accuracy of 0.1-0.01 per cent., with an output up to 400 tons of material per day. There are many other types of mixers on the market.

**Potassic Superphosphate** is made by combining calcium superphosphate and potash salts.

**Saltpetre Superphosphate** is likewise made by mixing nitre and superphosphate. It is not liked because free nitric acid is developed, and this corrodes the sacks and even causes them to catch fire.

**Artificial Guanos** are prepared by mixing nitrogenous and phosphatic manures such as calcium superphosphate and ammonium sulphate in varying proportions. The mixture changes partly into ammonium phosphate and calcium sulphate, and is sold under the name of "nitro-phosphate" or sometimes wrongly called "ammonium superphosphate."

Certain manures should not be mixed. For instance, nitrolime should not be mixed with guanos, etc., and if mixed with superphosphate causes part of the soluble phosphate to be reverted, although there is no loss of nitrogen.

## VII. GUANOS

(a) **Raw Peruvian Guano** is obtained from the huge deposits of excreta, up to 100 ft. thick, from extinct as well as present-day birds at Ballestas and other islands, and along the Pacific coast of Peru.

The birds are chiefly pelicans and cormorants, and deposit 20,000-30,000 tons per year.

These deposits vary in composition; some are rich in nitrogen, and others in phosphates. In general, when one constituent is present in a large amount, the proportion of the others is comparatively low. The ammonia in guano varies from about 2-12 or 14 per cent., calcium phosphate from 20-60, and potash 1.5-4 per cent.

Sometimes guanos are blended or mixed with chemical manures, such as ammonium salts, in order to obtain definite proportions of phosphates and nitrogen. The product is sold as "equalised guano." The Peruvian guanos are gradually becoming exhausted, but the Peruvian Government propose to limit the removal of the guano so as not to disturb the birds, and hope in this way to conserve the supply.

### Export of Peruvian Guano in Tons :—

Year 1908	-	-	-	76,108 tons.		Year 1910	-	-	-	61,578 tons.
„ 1909	-	-	-	50,378 „		„ 1911	-	-	-	(approx.) 60,000 „

(b) **Ichaboe Guano** is obtained from the Ichaboe group of islands off the south-west coast of Africa. Deposits of guano are formed by recent birds, and dry naturally. The deposit is collected after the birds have migrated.

Ichaboe guano is a rich nitrogenous and phosphatic manure, and compares well with the Peruvian guanos, the price being decidedly less.

(c) **Riddled Guano.**— Ordinary raw guano is in a lumpy condition, and contains some stones. Riddled guano is made by removing the stones and reducing the lumps to a powder.

Sometimes guanos are treated with acid in order to obtain a product which is more soluble and of use for top dressing. This is sold as "dissolved guano."

Natural guanos have a decided advantage over mixtures of ammonium salts, phosphates, etc., because the nitrogen and phosphates are closely associated.

**Products obtained from Sewage Sludge, Town Refuse, etc.**— Many attempts have been made to utilise human faecal substances for manuring,

but without very much success at present. Sludge produced by certain processes for treating sewage (see Vol. I., p. 191) is used in places as a manure, and gives very excellent results.

A manure sold as "**native guano**" is prepared as follows by pressing sludge which is pumped under a pressure of some 70 lbs. per square foot into **filter presses** (see Martin's "Industrial Chemistry: Organic," pp. 33, 34).

The liquid drips into a channel underneath the press. Filtration is carried on until the filter press chambers are completely full, and no more liquid drips from them. The press is now opened, and the solid cakes removed.

With a press of plates 30 in. square, and 1½ in. deep, seventy cakes weigh a ton.

The cakes are next air-dried and ground. The product is a very excellent fertiliser, and is sold at about £3. 10s. per ton.

The **native guano** (as supplied by the Native Guano Co.) was found on analysis to contain the following: Nitrogen 4.59 per cent. (equivalent to 5.57 ammonia), phosphoric oxide 2.15 per cent., and a little potash.

A patent drier for drying sewage sludge, wet grain, etc., by means of superheated steam is supplied by Messrs Blair, Campbell, & McLean, of Glasgow.

There are many other methods for preparing manures from sewage sludge. Some of the chief English Patents dealing with the subject are: 21,856, 1901; 11,890, 1903; 10,539, 1904, by treatment with sulphuric acid; 13,135, 1901; 29,558, 1904; 16,397, 1908; 9,625, 1910, by distilling sludge; 7,388, 1901; 9,337, 1901; 21,297, 1902; 8,931, 1903; 28,646, 1904; 8,347, 1905; 13,198, 1908, by treating with a precipitant such as lime or chalk; 11,471, 1903, by bacterial treatment.

**Plants** have been designed for utilising town refuse, street sweepings, etc. The chief patents consist in treatment of the refuse with sulphuric or nitric acids, or with heat or superheated steam. (English Patents, 11,315, 1905; 26,889, 1905; 19,727 and 19,728, 1907; and 15,827, 1910.)

Manures made from town refuse and sewage are usually poor in fertilising constituents, and must therefore be used in large quantities. Under these circumstances the cost of carriage becomes a serious element in deciding when and where they can be economically used.

**Seaweed** contains 1.3 per cent. nitrogen, 3 per cent. potash, and 0.5 per cent. phosphoric acid. According to English Patent, 27,257, 1912, seaweed is dried and powdered, gelatinous matter being added.

**Farmyard Manure.**—This has been used since very early times. It consists of the dung and urine of animals together with litter, and contains complete nourishment for the plant as well as humus-forming substance. Such manure contains on an average 0.4 nitrogen, 0.5 potash, 0.15 phosphoric oxide, and 0.45 lime per cent.

The most important constituent is the nitrogen. This is greater in manure from sheep and horses than from cattle and pigs.

Farmyard manure loses part of its nitrogen (as ammonia, and also as free nitrogen) while it is lying in heaps. Efforts have been made to prevent the loss by adding sulphuric acid or gypsum in order to fix the ammonia, but so far have not proved very satisfactory.

## VIII. THE FERTILISERS AND FEEDING STUFFS ACT, 1906

[6 Edw. VII., chap. 27.]

Some of the chief parts of this Act dealing with fertilisers are:—

1. (1) "Every person who sells for use as a fertiliser of the soil, any article which has been subjected to any artificial process in the United Kingdom, or which has been imported from abroad, shall give to the purchaser an invoice stating the name of the article, and what are the respective percentages (if any) of nitrogen, soluble phosphates, insoluble phosphates, and potash contained in the article, and the invoice shall have effect as a warranty by the seller that the actual percentages do not differ from those stated in the invoice beyond the prescribed limits of error."

1. (5) "Any statement by the seller of the percentages of the chemical and other ingredients contained in any article sold for use as a fertiliser of the soil . . . made after the commencement of this Act in an invoice of such article, or in any circular or advertisement descriptive of such article, shall have effect as a warranty by the seller."

1. (6) "Where an article sold for use as a fertiliser of the soil . . . consists of two or more ingredients which have been mixed at the request of the purchaser, it shall be a sufficient compliance with the provisions of this section with respect to percentages if the invoice contains a statement of percentages with respect to the several ingredients before mixture, and a statement that they have been mixed at the request of the purchaser."

**Limits of Error (Fertilisers and Feeding Stuffs Regulations, 1906).**—The percentage should be within the limits of error. Thus, if the phosphates are 20 per cent., then the article should contain 19-21 per cent. of phosphate. It is doubtful whether these limits are sufficiently elastic to cover the inevitable variation of samples and of the tests used by different chemists.

	DESCRIPTION OF FERTILISER.	LIMITS OF ERROR			
		Soluble Phosphates.	Insoluble Phosphates.	Nitrogen.	Potash.
1	Superphosphates - - - - -	1	...	...	...
2	Dissolved raw bones :—				
	(A) When total percentage of phosphate is 32 or more per cent.—				
	(a) If excess of actual percentage of insoluble phosphate over that stated in the invoice is 3 or more per cent. - - - - -	4	...	.3	...
	(b) If excess is between 3 and 2 per cent. - - - - -	3	...	.3	...
	(c) If excess is between 2 and 1 per cent. - - - - -	2	...	.3	...
	(B) In all other cases - - - - -	1	1	.3	...
3	Bone compounds - - - - -	1	1	.3	...
4	Compound manures (other than bone compounds, but including dissolved or equalised guano)—				
	(a) If respective percentage of nitrogen and of phosphate stated do not exceed 4 per cent. - - - - -	1	1	.3	.3
	(b) If such exceed 4 per cent. - - - - -	1	1	.5	.5
5	Sulphate of ammonia - - - - -	...	...	.5	...
6	Nitrate of soda - - - - -	...	...	.5	...
7	Ground hoofs and horns - - - - -	...	...	.5	...
8	Dried blood - - - - -	...	...	.5	...
9	Fish guano and meat meal - - - - -	...	2	.5	...
10	All cakes and meals (other than bone and meat meals) - - - - -	...	...	.5	...
11	Ground bones and bone meal - - - - -	...	2	.5	...
12	Basic slag and basic superphosphate - - - - -	2	2	...	...
		(Soluble in 2 per cent. citric acid.)			
13	Shoddy, wool and hair waste - - - - -	...	...	1	...
14	Kainit and other potash salts—				
	(a) Where percentage of $K_2O$ is not over 15 per cent. - - - - -	...	...	...	1
	(b) Where percentage of $K_2O$ exceeds 15 per cent. - - - - -	...	...	...	2
15	Nitrate of potash - - - - -	...	...	.5	2
16	Peruvian and other natural imported guanos—				
	(a) Where insoluble phosphates do not exceed 30 per cent. - - - - -	...	3	...	.5
	(b) Where such exceeds 30 per cent. - - - - -	...	5	...	.5
	(c) Where the percentage of nitrogen stated does not exceed 3 per cent. - - - - -	...	...	.5	.5
	(d) Where such percentage is between 3 and 5 per cent. - - - - -	...	...	.75	.5
	(e) Where such percentage is over 5 per cent. - - - - -	...	...	1	.5

**Analysis of Manures.**—This is carried out according to the Regulations of the Board of Agriculture, 1908 (see *Analyst*, 1909, p. 462).

**I. Determination of Moisture (loss on drying).**

A weighed quantity of the sample shall be dried at 100° C.

**II. Determination of Nitrogen.**

The presence or absence of nitrates must first be ascertained.

(A) **Nitrogen in the Absence of Nitrates.**—(a) A weighed portion of the sample shall be transferred to a Kjeldahl flask; 10 g. of potassium sulphate and 25 c.c. of concentrated sulphuric acid shall be added, and the flask heated until a clear, colourless, or light straw coloured liquid is obtained. The operation may be accelerated by the addition of a small crystal of copper sulphate or a small globule of mercury to the liquid in the flask.

(b) The quantity of ammonia shall be determined by distillation into standard acid after liberation with alkali, and where mercury is used, with the addition also of sodium or potassium sulphide solution.

(B) **Nitrogen when Nitrates are Present.**—(a) A weighed portion of the sample shall be transferred to a Kjeldahl flask; 30 c.c. of concentrated sulphuric acid added (containing 1 g. of salicylic acid), and the flask shaken so as to mix the contents without delay. The shaking shall be continued at intervals for ten minutes, the flask being kept cool, and then 5 g. of sodium thiosulphate and 10 g. of potassium sulphate added. The flask shall now be heated until the contents are colourless or nearly so. Copper sulphate or mercury may be used as above (II. (A) (a)).

(b) The quantity of ammonia shall be determined in exactly the same way as above (II. (A) (b)).

(C) **Nitrogen in the Form of Ammonium Salts.**—A weighed portion shall be taken and transferred to a flask, and the ammonia determined in the way described in II. (A) (b).

(D) **Nitrogen in Nitrates in the Absence of Ammonium Salts, and of Organic Nitrogen.**—1 g. of the sample shall be placed in a  $\frac{1}{2}$  litre Erlenmeyer flask with 50 c.c. of water, 10 g. of reduced iron and 20 c.c. of sulphuric acid of 1.35 sp. gr. shall be added. The flask shall now be closed with a rubber stopper provided with a thistle funnel, the head of which shall be filled with glass beads. The liquid shall be boiled for five minutes, and the flask removed from the flame; any liquid which may have accumulated on the beads shall be rinsed back into the flask with water. The solution shall now be boiled for three minutes more, and the beads again washed with water. The ammonia shall then be estimated as above (II. (A) (b)).

In the cases in which the proportion of nitrates is small, a larger quantity of the sample shall be taken.

(E) **Control Experiments in the Determination of Nitrogen.**—The materials used in any of the methods described under this paragraph (II.) shall be examined as to their freedom from nitrogen by means of a control experiment carried out under similar conditions, with the same quantities of reagents which have been employed in the actual analysis, in the case of (A), 1 g. of pure sugar being used in the place of the weighed portion of the sample. The quantity of standard acid used in the control experiment shall be deducted from the total quantity of acid found to have been neutralised in the distillation of the sample.

**III. Determination of Phosphates:—**

(A) **Phosphates Soluble in Water.**—In the case of superphosphates, dissolved bones, and similar substances, 20 g. of the sample shall be continuously agitated for thirty minutes in a litre flask with 800 c.c. of water. The flask shall then be filled up to the mark and again shaken, and the contents shall be filtered. 50 c.c. of the filtrate shall be boiled with 20 c.c. of concentrated nitric acid, and the phosphoric acid determined by the molybdate method prescribed below in paragraph III. (D). In the case in which the proportions of phosphates soluble in water is small, a larger quantity of the filtrate prepared as above shall be taken.

(B) **Phosphates Soluble in the Prescribed Citric Acid Solution.**—5 g. of the sample shall be transferred to a stoppered bottle of about a litre capacity. 10 g. of pure crystallised citric acid shall be dissolved in water, the volume shall be made up to 500 c.c., and the solution shall be added to the weighed sample in the bottle. To lessen the possibility of caking, the portion of the sample in the bottle may be moistened with 5 c.c. of methylated spirit or alcohol before the citric acid solution is added; and in that case the volume of the citric acid solution shall be 495 c.c. instead of 500 c.c. The bottle shall at once be fitted to a shaking apparatus, and shall be cautiously agitated during thirty minutes. The solution shall then be filtered through a large "folded" filter, the whole of the liquid being poured on the paper at once. If not clear, the filtrate shall be again poured through the same paper. 50 c.c. of the filtrate shall then be taken, and the phosphoric acid shall be determined by the molybdate method prescribed below in paragraph III. (D).

(C) **Total Phosphoric Acid.**—A weighed portion of the sample, in which portion, if necessary, the organic matter has been destroyed by ignition, and the silica removed by appropriate means, shall be dissolved in nitric acid and boiled, the solution being made up to a definite bulk.

The phosphoric acid shall be determined in an aliquot part of the solution by the molybdate method in paragraph III. (D).

(D) **Molybdate Method.**—To the solution, which should preferably contain 0.1-0.2 g. of phosphoric oxide, obtained as above described in paragraphs III. (A), (B), or (C), 100-150 c.c. of molybdic acid solution, or an excess of such a solution—*i.e.*, more than sufficient to precipitate all the phosphoric oxide present in the solution—shall be added, and the vessel containing the solution be placed in a water bath maintained at 70° C. for fifteen minutes, or until the solution has reached 70° C. It shall then be taken out of the bath and allowed to cool, and the solution filtered, the phospho-molybdate precipitate being washed several times by decantation, and finally on the paper with 1 per cent. nitric acid solution. The filtrate and the washings shall be mixed with more molybdic acid solution, and allowed to stand in a warm place in order to ascertain that the whole of the phosphoric oxide has been precipitated.

The phospho-molybdate precipitate shall be dissolved in cold 2 per cent. ammonia solution, prepared as described below, and about 100 c.c. of the ammonia solution shall be used for the solution and washings. 15-20 c.c. of magnesia mixture, prepared as described below, or an excess of such mixture—*i.e.*, more than sufficient to precipitate all the phosphoric oxide present—shall be added drop by drop, with constant stirring. After standing at least two hours with occasional stirring, the precipitate shall be filtered off, washed with 2 per cent. ammonia solution, dried, and finally weighed as magnesium pyrophosphate. The filtrate and washings shall be tested by the addition of more magnesia mixture.

(E) **Preparation of Molybdic Acid Solution.**—125 g. of molybdic acid and 100 c.c. of water shall be placed in a litre flask, and the molybdic acid shall be dissolved by the addition, while the flask is shaken, of 300 c.c. of 8 per cent. ammonia solution, prepared as described below. 400 g. of ammonium nitrate shall be added, the solution made up to the mark with water, and the whole added to 1 litre of nitric acid (*sp. gr.* 1.19), the solution maintained at about 25° C. for twenty-four hours, and then filtered.

(F) **Preparation of Magnesia Mixture.**—110 g. of crystallised magnesium chloride and 140 g. of ammonium chloride shall be dissolved in 1,300 c.c. of water. This solution shall be mixed with 700 c.c. of 8 per cent. ammonia solution, and the whole shall be allowed to stand for not less than three days, and shall then be filtered.

(G) **Preparation of Ammonia Solutions:—**

(i.) 8 per cent. ammonia solution.—One volume of ammonia solution of *sp. gr.* 0.880 shall be mixed with three volumes of water. This solution shall then be adjusted by the addition of strong ammonia or water as required until it has the *sp. gr.* of 0.967.

(ii.) 2 per cent. ammonia solution.—One volume of the 8 per cent. ammonia shall be mixed with three volumes of water.

#### IV. Determination of Potash:—

(A) **Muriate of Potash Free from Sulphates.**—A weighed portion of the sample (about 5 g. in the case of a concentrated muriate of potash, or 10 g. in the case of a low-grade muriate) shall be dissolved in water, the solution filtered (if necessary) and made up to 500 c.c. To 50 c.c. of the solution, placed in a porcelain basin, a few drops of hydrochloric acid shall be added, and also 10-20 c.c. (according to whether the portion weighed was 5 or 10 g.) of a solution of platinum chloride containing 10 g. of platinum per 100 c.c. After evaporation to a syrupy consistency on a water bath, the contents of the basin shall be allowed to cool, and shall then be treated with alcohol of *sp. gr.* 0.864, being washed by decantation until the alcohol is colourless. The washings shall then be passed through a weighed or counterpoised filter paper, on which the precipitate shall be finally collected and washed with alcohol as above, dried at 100° C. and weighed. The precipitate is to be regarded as  $K_2PtCl_6$ .

(B) **Salts of Potash containing Sulphates.**—A weighed portion of the sample (about 5 g. in the case of a concentrated sulphate of potash, or 10 g. in the case of kainit or other low-grade salts) shall be boiled with 20 c.c. of hydrochloric acid and 300 c.c. of water in a  $\frac{1}{2}$  litre flask. Barium chloride solution shall then be cautiously added, drop by drop, to the boiling solution, until the sulphuric acid is completely precipitated. Any slight excess of barium shall be removed by the addition of the least possible excess of dilute sulphuric acid. The liquid (without filtration) shall be cooled and made up to 500 c.c. A portion shall then be filtered, and 50 c.c. of the filtrate shall be treated as in paragraph IV. (A), 10 or 20 c.c. of platinum chloride, as the case may be, being used.

(C) **Potash in Guanos and Mixed Fertilisers.**—10 g. of the sample shall be gently ignited in order to char the organic matter, if present, and shall be heated for ten minutes with 10 c.c. of concentrated hydrochloric acid, and finally boiled with 300 c.c. of water. The liquid shall then be filtered into a  $\frac{1}{2}$  litre flask, raised to boiling point, and a slight excess of barium hydrate added. The contents of the flask shall be cooled and made up to 500 c.c. and filtered. Of the filtrate 250 c.c. shall be treated with ammonia solution and excess of ammonium carbonate; and then, while boiling, with a little powdered ammonium oxalate, cooled, made up to 500 c.c., and filtered. Of the filtrate, 100 c.c. are to be evaporated in a platinum dish, and the residue heated, first in an air bath, and then very gently over a low flame, till all ammonium salts are expelled, the temperature being kept below that of low redness. The residue shall be treated with hot water, filtered if necessary, and the potash determined in the filtrate as in paragraph IV. (A).



**Forms of Certificates.**—These should contain the following words:—“The analysis was made in accordance with the Fertilisers and Feeding Stuffs (Methods of Analysis) Regulations, 1908.”

IMPORT AND EXPORT OF FERTILISERS—UNITED KINGDOM, 1912.

	1912.	1911.
<b>Import in tons :—</b>		
Basic slag - - - -	49,310	22,666
Bones - - - -	41,206	45,883
Guano - - - -	14,115	34,124
Sodium nitrate - - - -	123,580	128,487
Phosphate of lime - - - -	520,270	493,415
<b>Total - - - -</b>	<b>748,481</b>	<b>724,575</b>
<b>Export in tons :—</b>		
Ammonium sulphate - - - -	286,864	291,148
Superphosphate - - - -	88,920	159,463
Basic slag - - - -	157,074	195,844
Sundry - - - -	133,541	157,857
<b>Total - - - -</b>	<b>666,399</b>	<b>804,322</b>

The writer is greatly obliged to Dr Bernard Dyer, F.I.C., for his very kind advice and suggestions.

## SECTION LV

# THE INDUSTRY OF ALUMINIUM COMPOUNDS

BY GEOFFREY MARTIN, Ph.D., D.Sc.

### LITERATURE

L. GESCHWIND.—“Manufacture of Alum and the Sulphates of Alumina and Iron.”  
1901.

JURISCH.—“Tonerdesulfat aus Bauxite.”

WITHIN the last few years the industry of aluminium compounds has undergone great changes and developments. First of all, bauxite at the present time has almost entirely displaced the other raw materials used for the manufacture of aluminium compounds. Secondly, the manufacture of aluminium oxide,  $Al_2O_3$ , on the large scale for the manufacture of metallic aluminium, is now by far the most important part of the industry, and the alumina thus prepared from the hydrate must be very pure. The third great change is the gradual replacement of alum in the dyeing and other industries by aluminium sulphate—now made possible by the manufacture of the latter in a high degree of purity by means of pure aluminium hydroxide. Where the aluminium sulphate is not required of a high degree of purity (as in paper manufacture) the old methods are still used.

**Manufacture of Aluminium Hydroxide,  $Al(OH)_3$ , and Alumina,  $Al_2O_3$ .—Bauxite** is by far the most important source of aluminium compounds, being richer than any other mineral in alumina; it occurs in very large quantities in Southern France, Dalmatia, South America, Ireland, and other districts as well.

Bauxite consists principally of hydrated alumina,  $Al_2O_3 \cdot 2H_2O$ , mixed with silica and iron hydroxide. It contains as a rule 41-70 per cent.  $Al_2O_3$ , 1-20 per cent.  $Fe_2O_3$ , 2-20 per cent.  $SiO_2$  and  $TiO_2$ , 10-20 per cent. combined water. The following gives some typical analyses of bauxite:—

	1.	2	3.	4.	5.
$Al_2O_3$ - - - -	60.98	65.02	70.38	68.50	41.08
$Fe_2O_3$ - - - -	2.82	2.14	5.12	3.44	3.2
$SiO_2$ - - - -	17.47	15.08	} 9.00	10.40	33.2
$TiO_2$ - - - -	3.50	3.56			
$H_2O$ (combined) - -	14.61	14.06	15.50	17.66	22.5

1-4 are specimens of French bauxite. 5 is a sample of Irish bauxite.

Two main processes for working the bauxite are in use, viz.—(1) **The Dry Process**; (2) **The Wet Process**.

1. **The Dry Process** of working the bauxite is as follows:—The bauxite is ground to a fine powder, mixed with calcined soda ash,  $Na_2CO_3$ , and heated in a reverberatory furnace to bright redness, carefully avoiding actual fusion.

The amount of  $Na_2CO_3$  added varies with the kind of bauxite employed, samples rich in silica having added to them somewhat more sodium carbonate than those poorer in this constituent

From 1.2-1.8 molecules of  $Na_2CO_3$  are added per molecule of  $Al_2O_3$ , so that not only some

normal aluminate,  $\text{Al}(\text{ONa})_3$ , is produced, but also much mono-aluminate,  $\text{AlO.ONa}$ . The addition of more soda than this favours the fusing of the mass, and the  $\text{CO}_2$ , not being completely expelled, causes decomposition of the soluble aluminate in the subsequent lixiviation processes.

Jurisch gives the following working example: 285 kilos of a bauxite containing 60 per cent.  $\text{Al}_2\text{O}_3$ , 20 per cent.  $\text{Fe}_2\text{O}_3$ , and 17 per cent.  $\text{H}_2\text{O}$  were mixed with 230 kilos  $\text{Na}_2\text{CO}_3$  (95 per cent.) and heated four hours, when a greenish mass weighing 362 kilos was obtained, which contained 50 per cent. of its  $\text{Al}_2\text{O}_3$  in a soluble form.

There is thus obtained a dirty green mass of sodium aluminate, easily crumbling to a powder. This is now rapidly extracted with water, by first grinding up, then placing in a wooden vat provided with a stirring gear, and hot weak liquors from previous extractions are first poured on, finishing up with pure water, to which a little  $\text{KOH}$  or  $\text{NaOH}$  has been added. During the process heating is carried out by steam.

The soluble sodium aluminates dissolve in water, while there remains behind in insoluble form all the iron (so that for this process even iron-rich bauxites can be used), much silica, and some alumina.<sup>1</sup>

The process of lixiviation must be completed as rapidly as possible (five to ten minutes), for the alkaline superficial layers of the liquid are decomposed by atmospheric  $\text{CO}_2$ , depositing  $\text{Al}(\text{OH})_3$  in a crystalline form as hydrargyllit. The separation of  $\text{Al}(\text{OH})_3$  at this stage means a loss of alumina, as this would go to the insoluble residues which are filtered off. Towards the end of the extraction some  $\text{NaOH}$  or  $\text{KOH}$  is added to clear the liquid.

The liquor thus obtained should be clear, and contain at least 170 g.  $\text{Al}_2\text{O}_3$  and 182-190 g.  $\text{Na}_2\text{O}$  in the litre. From weaker solutions  $\text{Al}(\text{OH})_3$  spontaneously separates out in a slimy condition, and causes trouble in filtering. It will be noticed that this ratio corresponds roughly to 1 mol.  $\text{Al}_2\text{O}_3$  : 1.8 mols.  $\text{Na}_2\text{O}$ , whereas  $\text{Al}(\text{ONa})_3$  requires theoretically 1  $\text{Al}_2\text{O}_3$  : 3  $\text{Na}_2\text{O}$ . The reason is, however, that much mono-aluminate,  $\text{Al}(\text{OH})_2\text{ONa}$ , and dialuminate,  $\text{Al}(\text{OH})(\text{ONa})_2$ , is present in the solution in addition to  $\text{Al}(\text{ONa})_3$ . This smaller percentage of  $\text{Na}_2\text{O}$  effects economy, in that less  $\text{CO}_2$  is required in the final precipitation of the  $\text{Al}(\text{OH})_3$ .

The hot solution of sodium aluminate is rapidly sent through a filter press to free from any insoluble residue, and is then run clear into cylinders some 9 or 10 ft. high and 3-4 ft. in diameter. By means of live steam the temperature is kept at 50°-60° C., while  $\text{CO}_2$  (obtained from coke fires or from lime-kilns) is pumped through the liquid, and precipitates the alumina in a granular and easily filtrable condition.

The liquor should have a density of 35° Bé. The reaction is—

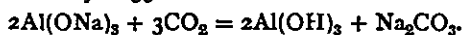

However, some free  $\text{NaOH}$  is present in the solution, no doubt arising from the decomposition of the sodium ferrite,  $\text{NaFeO}_2$ , by water, thus—

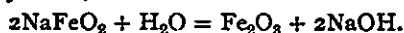

The iron present is thus rendered insoluble. No doubt, also, a simple hydrolysing action of the water takes place thus—

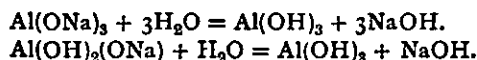

Another method of precipitating the  $\text{Al}(\text{OH})_3$  is that described by Bayer's patent (D.R.P., 43,977; *Chem. Zeitung*, 1888, 1893), which consists in stirring into the liquid crystalline  $\text{Al}(\text{OH})_3$ . This causes all, or nearly all, the alumina in solution to separate out in a crystalline and very pure form.

The precipitated alumina is filtered off, pressed, and washed; it then contains 40 per cent.  $\text{Al}_2\text{O}_3$ , 58 per cent.  $\text{H}_2\text{O}$ , 2 per cent.  $\text{Na}_2\text{CO}_3$ , and only traces of iron. By careful washing it can be further purified.

The mother liquors from the precipitated alumina, containing sodium carbonate and some caustic soda, are evaporated down and the alkali used again.

**2. The Wet Process.**—A somewhat cheaper method of procedure is the "wet process," introduced by Bayer. The finely powdered bauxite is heated with conc.  $\text{NaOH}$  solution (1 mol.  $\text{Al}_2\text{O}_3$  : 1.3 mols.  $\text{NaOH}$ ) under pressure in

<sup>1</sup> The residues, after drying at 100° C., often contain 55-56 per cent.  $\text{Fe}_2\text{O}_3$ , 9-10 per cent.  $\text{Al}_2\text{O}_3$ , 7-8 per cent.  $\text{SiO}_2$ , 5-6 per cent.  $\text{Na}_2\text{O}$ , 3-4 per cent.  $\text{CO}_2$ , and 18-20 per cent.  $\text{H}_2\text{O}$ . They are often sold to gas works for purifying gas (Lux's mass). The iron, in the process of calcination, has been converted into sodium ferrite,  $\text{NaFeO}_2$ . This, when treated with water, yields insoluble  $\text{Fe}_2\text{O}_3$  and  $\text{NaOH}$ .

boilers. The mono-aluminate,  $\text{AlO.ONa}$ , is produced and goes into solution. The solution, separated from the undissolved residue, is now stirred continually, whereby  $\text{Al(OH)}_3$  separates— $\text{AlO.ONa} + \text{Na}_2\text{O} = \text{AlO.OH} + \text{NaOH}$ . The alumina is filtered off and washed. The liquor containing all the  $\text{NaOH}$  are concentrated and used again.

A very large number of variations of these two methods have been worked or proposed. For these, however, the reader should consult the following patents:—Pickard, D.R.P., 182,442, of 9th September 1902; A. Clem, D.R.P., 180,554, of 8th June 1905; Hall, D.R.P., 138,219, of 15th August 1900; Levi, D.R.P., 174,698, 1904; Curtius, D.R.P., 175,416, 1904; Griesheim-Elektron, D.R.P., 182,775, 1905; Rinmann, D.R.P., 201,893, 1907.

In addition to this precipitated alumina a certain amount of "colloidal alumina" is used in the textile and dye industries, being prepared by decomposing aluminium sulphate with excess of sodium carbonate solution, the precipitate being thoroughly washed (see J. Bronn, *Zeit. Angew. Chem.*, 1901, 14, 851).

### Manufacture of Alumina and Aluminium Hydroxide from Cryolite

**Cryolite**,  $\text{AlF}_2 \cdot 3\text{NaF}$ , containing more than half its weight of fluorine, occurs in a great deposit in Greenland, embedded in granite rocks. The deposit extends under the sea bed, and is now mined to the extent of some 10,000 tons a year. The bulk goes to the United States, where a large factory works it up into soda, sodium aluminate, and fluorine compounds. A similar factory also exists in Belgium.

The cryolite is finely ground, intimately mixed with limestone or chalk,  $\text{CaCO}_3$ , and heated in a reverberatory furnace, when sodium aluminate and calcium fluoride are produced thus—

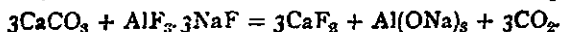

The mass is now extracted with water, whereby the  $\text{CaF}_2$  is left behind in an insoluble form, the sodium aluminate,  $\text{Al(ONa)}_3$ , going into solution.

The solution of sodium aluminate is decomposed by means of  $\text{CO}_2$  as explained under **Bauxite**—



The  $\text{Na}_2\text{CO}_3$  solution is evaporated and sold for soda, while the  $\text{CaF}_2$  also finds some sale.

However, cryolite is, in general, too dear a mineral to make the manufacture of  $\text{Al}_2\text{O}_3$  by this method a very profitable matter, and most of the factories in Europe which formerly worked this process have now given it up.

The principal uses of cryolite are (1) the manufacture of opaque milk glass; (2) for manufacture of enamels; (3) as a flux in the manufacture of metallic aluminium.

Germany in 1909 used about 1,000 tons of cryolite.

Manufacture of alumina from aluminium nitride by the **Serpek process** is fully discussed in this work, Vol. I., under **Ammonia from Nitrides**.

**Properties and Use of Aluminium Hydroxide,  $\text{Al(OH)}_3$ , and Alumina,  $\text{Al}_2\text{O}_3$ .**—When moist,  $\text{Al(OH)}_3$  is a gelatinous substance which gradually dries at ordinary temperatures to a white powder, and when ignited is converted into alumina,  $\text{Al}_2\text{O}_3$ . The substance is insoluble in water, but dissolves in dilute  $\text{NaOH}$ ,  $\text{KOH}$ , and acids. However, prolonged boiling of the hydrate in water makes it insoluble both in acids and alkalis.

Aluminium hydroxide finds considerable use as a mordant in the dyeing and calico printing trades. When precipitated from solutions containing dyes, it either combines or occludes the dyes, and fixes them firmly in the cloth.

Precipitated aluminium hydrate,  $\text{Al(OH)}_3$ , contains no iron, and only traces of  $\text{SiO}_2$  and  $\text{Na}$ . From this a very pure iron-free aluminium sulphate is produced by simply dissolving it in sulphuric acid— $2\text{Al(OH)}_3 + 3\text{H}_2\text{SO}_4 = \text{Al}_2(\text{SO}_4)_3 + 3\text{H}_2\text{O}$ .

However, the bulk of the aluminium hydroxide thus produced is ignited, whereby it is converted into **anhydrous alumina**,  $\text{Al}_2\text{O}_3$  ( $2\text{Al(OH)}_3 = \text{Al}_2\text{O}_3 + 3\text{H}_2\text{O}$ ), which contains, on the average, 98-99 per cent.  $\text{Al}_2\text{O}_3$ , 0.2 per cent.  $\text{Na}_2\text{O}$ , and less than 0.2 per cent.  $\text{SiO}_2$ . This alumina is used on the large scale for the manufacture of metallic aluminium (see this work, Vol. III., "Metals").

The present production of metallic aluminium reaches 20,000 tons annually, and for this quantity 45,000 tons of anhydrous  $\text{Al}_2\text{O}_3$  are necessary.

The anhydrous alumina used for the manufacture of metallic aluminium must be very pure,

free from iron, silica, and  $\text{Na}_2\text{O}$ . By adding less than 1 per cent. of aluminium fluoride,  $\text{AlF}_3$ , and strongly igniting so as to volatilise it, the  $\text{Al}_2\text{O}_3$  can be completely dehydrated (see German Patent, 165,612, of 1905).

**Fused alumina** finds some application as a **grinding agent**, being an artificial corundum or emery (the basis of which is alumina). H. Gintl (*Zeit. Angew. Chem.*, 1901, 1173) fused together in an electric furnace a mixture of bauxite and coal, using 100 volts and 1,000 amperes. He thus obtained very hard blue crystals, utilisable for grinding purposes. For other attempts to produce grinding and polishing materials, the basis of which is crystalline alumina, see the German Patents, 85,021, 1894; 96,317, 1895; 97,408, 1897.

Fused alumina, produced by the "thermite process," has been put on the market for polishing, under the name "Corubin." See also the article on **Polishing and Grinding Materials**, in this volume.

Another use is its addition to porcelain or clay crucibles for rendering them very **fire resisting** (see German Patent, 96,317, 1895). A considerable amount of fused alumina is used as a packing material for acid towers, being introduced for this purpose by Oscar Guttman (see **Sulphuric Acid**, this work, Vol. I.).

Another curious application of alumina is the **manufacture of artificial rubies and sapphires**, which at the present time has become a considerable industry. This is discussed in the article on **The Artificial Gem Industry**, p. 63. These hard artificial gems are used in watches, phonographs, balances, and other kinds of delicate mechanism, where hard, unwearable, smooth surfaces are necessary.

**Manufacture of Aluminium Sulphate,  $\text{Al}_2(\text{SO}_4)_3 \cdot 18\text{H}_2\text{O}$ .**—The most important raw material for the manufacture of aluminium sulphate is **Bauxite** (p. 49); it is, however, also manufactured from **Kaolin** (china clay) and from **Cryolite** (see p. 51).

**Manufacture from Bauxite.**—The bauxite (or cryolite) is calcined with soda ash (sodium carbonate) as described on p. 49, the product is lixiviated with water, and from the solution of sodium aluminate nearly pure aluminium hydroxide is precipitated by  $\text{CO}_2$  as described on p. 50. The process adopted when cryolite is used as the starting product is described on p. 51.

The filtered and washed  $\text{Al}(\text{OH})_3$  is next mixed with sulphuric acid of  $58^\circ\text{--}66^\circ \text{Bé}$ . ( $133^\circ\text{--}167^\circ \text{Tw.}$ ), when heat is evolved and the product dissolves to form aluminium sulphate,  $\text{Al}_2(\text{SO}_4)_3 \cdot 18\text{H}_2\text{O}$ , thus:—

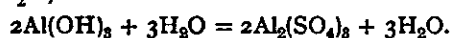

After cooling, the product sets to a solid glass-like mass, having a porous structure and containing about 60 per cent.  $\text{Al}_2(\text{SO}_4)_3$ .

The exact procedure differs in different works. As a rule, however, excess of acid is avoided, the proportion of  $\text{Al}_2\text{O}_3$  to  $\text{H}_2\text{SO}_4$  being from 1 : 2.8 or 2.9, against 1 : 3 as required for the compound  $\text{Al}_2(\text{SO}_4)_3$ . It is most important that the aluminium hydroxide and the sulphuric acid should be almost totally free from iron, as the presence of only traces of iron in the resulting aluminium sulphate greatly diminishes its value for certain technical purposes. The action which takes place is at first vigorous, the mixture foaming and frothing up. However, as soon as the process is completed this foaming action immediately ceases. The liquid mass is allowed to solidify in flat pans, some 6 ft. long, 5 ft. wide, and 8 in. deep. These pans are covered with lead, and during the solidifying process the mass is often kept continually stirred with wooden shovels, when it finally sets to a number of lumps, each about the size of a hen's egg. The product is then packed into casks.

In some works the hot fluid mass is run into leaden channels, and just before solidification a number of partitions are placed at intervals down the channel, so that when the mass finally sets a number of equal-sized blocks, about the size of half a brick, are produced.

The product thus produced is now often almost entirely iron-free. It usually contains a small amount of sodium sulphate,  $\text{Na}_2\text{SO}_4$  (produced by the action of the sulphuric acid on a little unchanged sodium carbonate, etc., contained in the precipitated aluminium hydroxide), and also a little free sulphuric acid, so that the product has an acid reaction. The presence of the sodium sulphate does not, as a rule, hinder in any way the technical applications of the aluminium sulphate. The

acid reaction cannot be destroyed by adding excess of aluminium hydroxide, as the excess does not dissolve.

The properly manufactured product contains 14.3-14.5  $\text{Al}_2\text{O}_3$ ; 33.7 per cent.  $\text{SO}_3$ ; 0.60 per cent.  $\text{Na}_2\text{SO}_4$ ; under 0.02 per cent.  $\text{Fe}_2\text{O}_3$ ; insoluble residue, 0.5 per cent.;  $\text{H}_2\text{O}$ , 50.68 per cent. (see Jurisch, *Chem. Industrie*, 1894, 17, 92). This product is so pure that in general it can be directly used instead of alum as a mordant in the dyeing and colour printing industry. In some delicate dyeing operations even so small an amount of iron as 0.001 per cent. exerts a deleterious effect. For sizing paper, 0.01 per cent. of iron is allowable.

Where the presence of iron does not greatly affect the use of the product, sometimes aluminium sulphate is manufactured from bauxite by the acid process.

Here the bauxite is treated with dilute sulphuric acid of  $45^\circ$ - $52^\circ$  Bé. (or  $90^\circ$ - $112^\circ$  Tw.) (stronger acid than this being less effective), and the mixture is warmed by means of live steam until the acid is neutralised.

The previously calcined and finely ground bauxite is run through a manhole into a large cast-iron boiler, lined internally with lead and stoneware, which contains the requisite amount of  $45^\circ$ - $52^\circ$  Bé. ( $90^\circ$ - $112^\circ$  Tw.) sulphuric acid, heated by indirect steam to  $90^\circ$ - $100^\circ$  C. A violent action soon takes place, and the pressure inside the boiler sometimes rises to 4 atmos. After ten to fifteen minutes the action is completed, and the pressure gradually sinks. By opening a valve the pressure is reduced to atmospheric, the manhole is opened, the pasty mass is diluted until a concentration of  $29^\circ$ - $31^\circ$  Bé. is attained, and the liquid mass run out into tall settling tanks, settled for four days, and the clear solution run off into leaden concentrating pans and concentrated until  $42^\circ$  Bé. is reached, when the liquid is run into small crystallising pans and is allowed to crystallise. The solid cakes thus obtained are subjected to a hydraulic pressure of 300 or more atmos. (whereby iron-containing mother liquors, etc., are pressed out), and the hard white cakes of aluminium sulphate thus obtained, containing less than 0.05 per cent. iron, are sold to paper manufacturers for sizing purposes.

The insoluble residues in the clearing tanks are technically nearly worthless at present. They are washed with water and then thrown away; the aqueous washings are worked up for alum as described below.

The great disadvantage of the acid process is the fact that much iron is taken up from the bauxite, so that in general the product can only be used for sizing paper and similar products, where the presence of some iron, e.g., 0.01-0.02 per cent., does not matter. For dyeing purposes, where even a trace of iron, e.g., so little as 0.001 per cent., often spoils the colour effect, it cannot be used, and so the alkaline process of manufacture before described is used for preparing the pure product.

For example, one process (English Patent, 5,579, 1881, Fahlberg & Semple) consists in stirring into the paste from the sulphuric acid a little lead peroxide,  $\text{PbO}_2$ . The iron is precipitated as  $\text{Fe}_2\text{O}_3 \cdot \text{PbO}_2$ . This remains behind in the insoluble residues of the settling tank. The liquors are then worked up as previously described. Spence oxidises the iron with  $\text{MnO}_2$  (English Patent, 3,835, 1882).

Another successful process is to precipitate the iron as Prussian Blue. The clear liquor, as it comes from the settling tanks, is first titrated with permanganate, and the amount of ferrous iron in it is exactly estimated. Next the theoretical amount of bleaching powder is run in in order to just oxidise all the iron to the ferric state. The excess of chlorine must be completely removed by blowing air through the liquor. Next ferrocyanide is run in very carefully in the exact amount necessary to precipitate all the iron present as Prussian blue.

The liquid is now carefully filtered under its own pressure through a filter press provided with the finest Nessel filter cloths, which retain most of the Prussian blue. The first portions of the fluid, however, come through turbid, and the liquid is rendered perfectly clear by forcing it once more, but now under 4 atmos. pressure, through a filter composed of twenty or thirty porous plates of calcined magnesia, mounted one behind the other in an enamelled vessel.

By reversing the direction of the entering liquid these plates can be washed free from the clogging Prussian blue.

More recently the liquid has been freed from Prussian blue by sending it through centrifugal machines provided with very fine filtering cloths.

The perfectly clear liquid is now concentrated from  $42^\circ$ - $52^\circ$  Bé. in leaden pans, and allowed to solidify as above described. This product contains only 0.0005 per cent. iron oxide; bad samples sometimes contain 0.01 per cent.  $\text{Fe}_2\text{O}_3$ .

The separated Prussian blue, after washing by boiling with water and pressing, is converted into ferrocyanide by heating with alkalis, and so is used over again.

### Manufacture of Aluminium Sulphate from China Clay

White china clay,  $\text{Al}_2\text{O}_3 \cdot 2\text{SiO}_2 \cdot 2\text{H}_2\text{O}$ , when pure, contains 39.2 per cent.  $\text{Al}_2\text{O}_3$ . Treated with conc.  $\text{H}_2\text{SO}_4$  the  $\text{Al}_2\text{O}_3$  is dissolved as  $\text{Al}_2(\text{SO}_4)_3$ , while the  $\text{SiO}_2$  remains behind insoluble. The clay is reduced to a fine powder and calcined, when a loss of weight of 20-25 per cent. occurs, owing to loss of water.

The calcined clay is now treated in a lead-lined wooden vat with somewhat less conc. sulphuric acid ( $96^\circ \text{Tw.}$ ,  $60^\circ \text{Bé.}$ ) than suffices to dissolve all the  $\text{Al}_2\text{O}_3$ . A vigorous action takes place, and after fifteen to twenty minutes of continual stirring, the mass is run into lead-lined wooden waggons with removable sides, in which the action continues for some time. Finally the mass solidifies, and is then reduced by cutting with a heavy knife to a coarse powder.

This product, known as "alum cake," has the average composition: soluble  $\text{Al}_2\text{O}_3$ , 12-13.5 per cent.;  $\text{Fe}_2\text{O}_3$ , 0.10-0.25 per cent.; combined  $\text{SO}_3$ , 29-32 per cent.; free  $\text{SO}_3$ , 0.5-1 per cent.; insoluble matter, 20-27 per cent.

By this process some 60 per cent. of the  $\text{Al}_2\text{O}_3$  originally present in the clay is converted into  $\text{Al}_2(\text{SO}_4)_3$ .

"White Sulphate of Alumina" is prepared from the crude "alum cake" by lixiviating the latter with hot water (heated by live steam) in lead-lined wooden tanks. After settling, the clear fluid is decanted into lead-lined evaporators and concentrated to a density of  $112^\circ \text{Tw.}$  ( $52^\circ \text{Bé.}$ ). It is then run into a series of shallow tiled troughs, where it solidifies to a crystalline mass.

This product contains 0.25 per cent.  $\text{Fe}_2\text{O}_3$  and 14 per cent.  $\text{Al}_2\text{O}_3$ , and is largely used for sizing paper (see Martin's "Industrial Chemistry: Organic").

In this process, of 35 per cent.  $\text{Al}_2\text{O}_3$  of the clay no less than 15 per cent. remains behind in the residue of  $\text{SiO}_2$ .

**Properties of Aluminium Sulphate.**—The substance is variously given the formula  $\text{Al}_2(\text{SO}_4)_3 \cdot 18\text{H}_2\text{O}$ , and  $\text{Al}_2(\text{SO}_4)_3 \cdot 20\text{H}_2\text{O}$ . It crystallises in white, pearly tablets, and is very soluble in water. On heating it melts in its water of crystallisation, and then swells up, the anhydrous salt only slowly dissolving again in water. At a red heat it is decomposed into  $\text{Al}_2\text{O}_3$ .

The following figures give the weight of salt which dissolves in 100 parts  $\text{H}_2\text{O}$ :—

Temperature	0°	10°	20°	50°	100°
Crystallised salt	86.8	95.8	107.3	201.4	1132.0
Anhydrous salt	31.3	33.5	36.1	52.1	89.1

The following table gives the specific gravities of solutions of aluminium sulphate of various strengths:—

Per cent. $\text{Al}_2(\text{SO}_4)_3$ .	Sp. Gr.	Per cent. $\text{Al}_2(\text{SO}_4)_3$ .	Sp. Gr.	Per cent. $\text{Al}_2(\text{SO}_4)_3$ .	Sp. Gr.
1	1.017	10	1.107	19	1.197
2	1.027	11	1.117	20	1.207
3	1.037	12	1.127	21	1.217
4	1.047	13	1.137	22	1.227
5	1.057	14	1.147	23	1.237
6	1.067	15	1.157	24	1.247
7	1.077	16	1.167	25	1.257
8	1.087	17	1.177		
9	1.097	18	1.188		

The substance is insoluble in absolute alcohol and free  $\text{H}_2\text{SO}_4$ , etc., and can be removed by precipitating the substance from aqueous solution with much alcohol.

**Alum**,  $K_2SO_4 \cdot Al_2(SO_4)_3 \cdot 24H_2O$ .—The most important raw material for the manufacture of alum is **Bauxite**; of lesser importance is **Alunite** (alumstone) and **Kaolin**. Some alum and aluminium sulphate is also produced from **Kryolite**. The manufacture from black bituminous, aluminiferous shale has now, to a large extent, been given up.

**Alunite, Alumstone**, is the oldest known raw material for the manufacture of alum and other aluminium compounds. It is a basic potassium aluminium sulphate, of formula  $K(AlO)_3(SO_4)_2 \cdot 3H_2O$ , and is a volcanic product, being produced by the combined action of  $SO_2$  and steam on lava.

It occurs in China (where an "alum mountain, 1,900 ft. high, with a circumference at the base of 10 miles," is said to occur) (see "U.S. Cons. Report," 1903), Hungary, Greece, and Italy.

The best known source is at **Civita Vecchia**, in Italy. This has been known and worked for centuries, and is still worked at the present time for producing "Roman alum."

The native alunite cannot be directly extracted with water, because it consists of a **basic alum** insoluble in water. It must first be heated to a high temperature, when it loses its hydrated water, crumbles, and becomes soluble in water.

The method of procedure is as follows:—The alunite is first calcined at  $600^\circ$ , and then broken up and exposed to the action of the atmosphere. Next, the mineral is extracted with water, whereby alum,  $K_2SO_4 \cdot Al_2(SO_4)_3 \cdot 24H_2O$ , passes into solution, while unchanged clay, alumina, iron oxide, etc., remain behind.

On concentrating the solution the alum crystallises out in cubes. This alum, being almost entirely free from iron, was at one time a valuable product.

The modern method of working alunite for alum is to treat the calcined and finely powdered mineral with sulphuric acid and allow the solution thus obtained to crystallise.

There first crystallises out alum,  $K_2SO_4 \cdot Al_2(SO_4)_3 \cdot 24H_2O$ , and the mother liquors from this, when further concentrated, yield a crystallised mass of aluminium sulphate,  $Al_2(SO_4)_3 \cdot 18H_2O$ , which is much more soluble and much more difficult to obtain pure than alum.

**Manufacture of Alum from Bauxite or Kaolin**.—Aluminium sulphate solution is first prepared by treating the bauxite or kaolin with sulphuric acid according to the acid process described on pp. 52-53.

To the concentrated hot solution of aluminium sulphate there is now added potassium sulphate, and the liquid is vigorously stirred. On cooling, the moderately soluble potassium alum separates as a fine crystalline mass:—



The formation of large crystals is avoided by stirring during the precipitation. Large crystals enclose mother liquor, and so their formation is avoided.

Sometimes instead of potassium sulphate the cheaper potassium chloride is used, when the following action takes place:—



The aluminium chloride remains in solution, and so is lost for the formation of alum.

The alum crystals are separated from the greenish-coloured iron-containing mother liquors, and are well washed with water and again dissolved in hot water and crystallised therefrom, after first making a solution of sp. gr. 1.5.

On account of its moderate solubility in cold water alum can be easily prepared almost quite iron-free, and so is used for purposes where the absence of iron is necessary.

**Properties of Potassium Alum**,  $K_2SO_4 \cdot Al_2(SO_4)_3 \cdot 24H_2O$ .—The body is only moderately soluble in cold water: 100 parts of water dissolve:—

Temperature:—

° C.	10°	20°	30°	40°	50°	60°	70°	80°	90°	100°	
$K_2SO_4 \cdot Al_2(SO_4)_3 \cdot 24H_2O$ dissolved:—	3.9	9.5	15.1	22.0	31.0	44.1	66.6	90.7	124.5	209.3	357.5



The specific gravity of the aqueous solution at 17.5° C. is:—

Per cent. alum	-	-	-	4	8	12	13
Specific gravity	-	-	-	1.0205	1.0415	1.0635	1.0690

The aqueous solution is acid in reaction, dissolving iron and zinc with evolution of hydrogen. It boils at 111.9° C., is insoluble in alcohol; heated, it melts in its water of crystallisation at 92.5° C.; ignited, it loses its water of crystallisation and also sulphuric acid, and goes into "burnt alum."

The ordinary alum crystallises in octahedra, but in a neutral solution (to which alkali carbonate, lime, caustic potash, or soda has been added) the substance crystallises out below 45° in cubes. Exposed to the air, alum loses part of its water of crystallisation.

In the technical application of alum the chemically active part is simply the aluminium sulphate,  $\text{Al}_2(\text{SO}_4)_3$ , and so within recent years the manufacture of aluminium sulphate,  $\text{Al}_2(\text{SO}_4)_3 \cdot 18\text{H}_2\text{O}$ , has taken place on an increasing scale.

Were it possible to obtain aluminium sulphate as pure as alum, there is little doubt that alum would be completely displaced by it.

However, aluminium sulphate is very soluble in water (soluble in its own weight of water) and crystallises with difficulty, and is difficult to free from iron and free  $\text{H}_2\text{SO}_4$ , consequently for all purposes where a pure salt is necessary alum is superior to aluminium sulphate.

**Ammonium alum**,  $(\text{NH}_4)_2\text{SO}_4 \cdot \text{Al}_2(\text{SO}_4)_3 \cdot 24\text{H}_2\text{O}$ , is prepared in a manner precisely similar to potassium alum, merely by adding ammonium sulphate to a solution of aluminium sulphate.

Since ammonium alum is only very slightly more soluble in water than potassium alum, it can also, like this latter, be easily prepared in a pure state by crystallisation.

100 parts of water dissolve:—

Temperature -	0°	10°	20°	30°	40°	50°	60°	70°	80°	90°	100°
Ammonium } alum }	5.2	9.1	13.6	19.3	27.3	36.5	51.3	72.0	103	188	422

Ignited it leaves a residue of pure alumina,  $\text{Al}_2\text{O}_3$ .

The crystals frequently have an amethyst tint (possibly due to traces of iron and chromium), although containing less than 0.001 per cent. of iron.

Since the introduction of cheap potassium chloride from Stassfurt, ammonium alum is no longer manufactured to the same extent in England as it was formerly.

**Sodium alum**,  $\text{Na}_2\text{SO}_4 \cdot \text{Al}_2(\text{SO}_4)_3 \cdot 24\text{H}_2\text{O}$ , is also prepared on a large scale. It is more soluble in water than potassium alum, and is also cheaper. It is, however, more difficult to prepare pure than either potassium or ammonium alum, on account of its great solubility, 100 parts of water dissolving 51 parts sodium alum at 16° C. Two other alums, which are prepared on a large scale, are **potassium chrome alum**,  $\text{K}_2\text{SO}_4 \cdot \text{Cr}_2(\text{SO}_4)_3 \cdot 24\text{H}_2\text{O}$ , and **ammonium iron alum**,  $(\text{NH}_4)_2\text{Fe}_3(\text{SO}_4)_2 \cdot 24\text{H}_2\text{O}$ .

### Some other Salts of Alumina

**Aluminium acetate**, prepared in aqueous solution by treating aluminium sulphate (or alum) solution with lead acetate ( $3\text{PbAc}_2 + \text{Al}_2(\text{SO}_4)_3 = \text{PbSO}_4 + 2\text{AlAc}_3$ ), or by dissolving precipitated aluminium hydroxide,  $\text{Al}(\text{OH})_3$ , in acetic acid, finds fairly extensive use as a mordant in dyeing and colour printing on cloth.

**Aluminium chloride**,  $\text{AlCl}_3$ , is obtained technically by dissolving precipitated aluminium hydroxide,  $\text{Al}(\text{OH})_3$ , in HCl. It is used for carbonising wool (see Martin's "Industrial Chemistry: Organic").

**Solid sodium aluminate**,  $\text{Al}(\text{ONa})_3$ , is sometimes obtained from bauxite or cryolite, as above described (see pp. 49, 51), by heating with soda or caustic soda, extracting with water, and concentrating the liquid when it is obtained as a white, easily soluble mass. Its solution is decomposed by atmospheric  $\text{CO}_2$  (or even on long standing by water), giving a precipitate of  $\text{Al}(\text{OH})_3$ . Consequently, when the powder is exposed to air for any length of time, it yields turbid solutions.

It finds use as a mordant in dyeing and cloth printing, and in the preparation of certain paints. It is also sometimes used in sizing paper, for the manufacture of aluminium soaps (substitute for alum), for hardening plaster of Paris and similar stony compositions, and for saponifying fats in candle manufacture.

**Technical Uses of Salts of Alumina.**—Both alum and aluminium sulphate find extensive use as mordants for cotton and wool. The salts used for this pur-

pose must be almost iron-free—0.01-0.001 per cent. of iron often rendering these products useless for such dyes as alizarin. This high degree of purity was, until recently, only attainable with alum, since aluminium sulphate is very difficult to crystallise and purify from the iron-containing mother liquors. A still greater quantity of alum (and still more aluminium sulphate) is used for **sizing paper** (see **Martin's** "Industrial Chemistry: Organic"), a mixture of resin soap (rosin partly dissolved in NaOH), starch, and aluminium sulphate being added to the paper pulp, and so forms an adherent precipitate of aluminium rosenate, which causes the fibres to adhere together and prevents ink sinking into the paper.

Aluminium salts also find extensive use in making cloth **waterproof**, the method being explained in **Martin's** "Industrial Chemistry: Organic." Wood is made **fireproof** by impregnating with aluminium sulphate.

**Aluminium soaps** (made by treating ordinary soaps with aluminium acetate or sulphate) find a variety of uses, one of which is the cementing together of sandstone to form solid blocks. The aluminium soap is sometimes sold for this purpose under the name "Testalin."

Both **alum** and **aluminium sulphate** are used in tanning leather (see **Martin's** "Industrial Chemistry: Organic"). Another use of aluminium sulphate is the clearance of sewage water. Water is treated with this substance, together with lime-water, when a gelatinous precipitate of aluminium hydroxide brings down with it any suspended organic matter (see **Martin's** "Industrial Chemistry Inorganic," Vol. I.).

## SECTION LVI

# THE ARTIFICIAL ZEOLITE OR PERMUTITE INDUSTRY

BY GEOFFREY MARTIN, Ph.D., D.Sc.

### LITERATURE

- R. GANS.—*Chem. Ind.*, 1909, 32, 197; *Chem. Zentr.*, 1908, 52; *Chem. Zentr.*, 1909, I, 2031.  
 JAHN K. PRUSS.—“*Geol. Landesamt.*” Berlin, 1905, 1906, pp. 179-211.  
 SIEDLER.—“*Seventh International Congress of Applied Chemistry*,” Section II. “*Inorganic Chemistry*,” 1910, p. 262.  
 LÜHRIG and BECKER.—*Chem. Zentr.*, 1908, 532.

THE zeolites are a large class of naturally occurring hydrated aluminium silicates containing alkali or alkaline earth metals. A few of the more important are:—

Natrolite	-	-	-	$\text{Na}_2\text{O} \cdot \text{Al}_2\text{O}_3 \cdot 3\text{SiO}_2 \cdot 2\text{H}_2\text{O}$ .
Analcite	-	-	-	$\text{Na}_2\text{O} \cdot \text{Al}_2\text{O}_3 \cdot 4\text{SiO}_2 \cdot 2\text{H}_2\text{O}$ .
Chabazite	-	-	-	$\text{CaO} \cdot \text{Al}_2\text{O}_3 \cdot 4\text{SiO}_2 \cdot 6\text{H}_2\text{O}$ .
Stilbite	-	-	-	$\text{CaO} \cdot \text{Al}_2\text{O}_3 \cdot 6\text{SiO}_2 \cdot 6\text{H}_2\text{O}$ .

They play an important part in soils, by retaining in a readily soluble form the alkalis set free on the weathering of felspar. They can be artificially synthesised, and within the last few years they have become of considerable industrial importance owing to R. Gans' discoveries that they contain alkali or alkaline earth metals which, when brought into contact with various solutions of metallic salts, are interchanged for the metal from the salt solution, the alkali or alkaline earth metal in the zeolite itself going into solution in the salt.

The name given to the artificially made zeolite is “**Permutite**,” of which many different varieties exist, according to the nature of the bases employed in their manufacture.

**Manufacture.**—The permutites are made by igniting together china clay (aluminium silicates) and (sometimes) quartz or sand with the alkali carbonates. The melt is extracted with water, and the residual permutite is left as a granular mass. This must be porous if a high degree of reactivity is necessary—a condition which is attained by the presence of potassium as one of the bases.

R. Gans, in his D.R. Patent, 174,097, of 12th Jan. 1905, manufactures zeolites by allowing an alkali aluminate, free from uncombined alkali, to act on hydrated silicic acid. Heat is employed to complete the union, and then calcium chloride,  $\text{CaCl}_2$ , solution is added. The alkali is thereby exchanged for the calcium. The zeolites made by this process have the formulæ of the natural zeolites, e.g.,  $\text{CaO} \cdot \text{Al}_2\text{O}_3 \cdot 6\text{SiO}_2 + 6\text{H}_2\text{O}$ , or  $\text{CaO} \cdot \text{Al}_2\text{O}_3 \cdot 4\text{SiO}_2 + 8\text{H}_2\text{O}$ .

J. D. Riedel, in his D.R. Patent, 186,630, of 24th Feb. 1906, manufactures zeolites by fusing together 3 parts of kaolin, 6 parts of quartz, and 12 parts of sodium carbonate. Excess of alkali must be carefully avoided. There results  $\text{Al}_2\text{O}_3 + 10\text{Na}_2\text{O} + 10\text{SiO}_2$ .

In his later patent, D.R.P., 200,931, of 11th Oct. 1907, Riedel replaces the sodium carbonate by a mixture of the cheaper sodium sulphate and coal. On extracting with water a crystalline aluminosilicate passes into solution.

In general, the greater the percentage of sodium or potassium present in the molecule, the greater is their capacity of interchanging their bases. According to Gans, in general to every 1 molecule  $\text{Al}_2\text{O}_3$  present, we must have present 1 molecule  $\text{Na}_2\text{O}$  or  $\text{K}_2\text{O}$ . The chemical formula of a typical zeolite is given by Gans as  $\text{Al}_2\text{O}_3 \cdot \text{Na}_2\text{O} \cdot 2\text{SiO}_2 + 6\text{H}_2\text{O}$ .

These artificial aluminium silicates possess properties only found to a very minute degree in similar natural silicates. This peculiar behaviour led Dr Gans to the conclusion that in the artificial product the sodium or potassium are joined to the silicon through the medium of aluminium, while in the natural silicates the base was attached in the usual way, the atoms of hydrogen being replaced by the metals. The graphic formula of a simple artificial aluminium silicate of empirical formula,  $\text{Na}_2\text{O} \cdot \text{Al}_2\text{O}_3 \cdot 2\text{SiO}_2 \cdot 6\text{H}_2\text{O}$ , would then be as follows:—

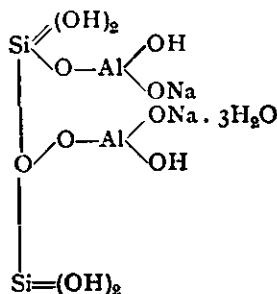

A sodium zeolite is now made on a large scale, and put on the market under the name of "Sodium Permutite." It is used either as such, or is converted into other permutites containing basic components other than sodium, and the uses to which it has been technically subjected are as follows:—

(1) **The removal of calcium and magnesium salts from water.**—*E.g.*, if it is desired to remove  $\text{CaCl}_2$  from water, the water is sent through a granular layer of sodium permutite some 60-100 cm. high, when a calcium permutite is formed, and sodium chloride passes in solution, thus—

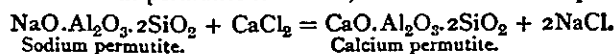

In order to regenerate the sodium permutite when exhausted, a concentrated  $\text{NaCl}$  solution is led through the layer of permutite, when the calcium permutite formed is decomposed according to the equation:—

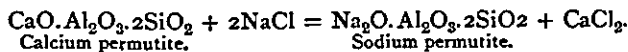

Thus calcium, magnesium, and similar salts can be easily removed from water, the calcium or magnesium replacing the sodium of the permutite, and sodium salts being formed in solution, and the process has already attained considerable technical importance as a water-softening process (see this work, Vol. I., under Water). See also R. Gans' *Chem. Zentr.*, 1907; Lührig and Becker, *Chem. Zentr.*, 1908, 532.

(2) **Removal of sodium and potassium salts from water.**—For this purpose the water is sent through a calcium permutite. *E.g.*, if it is desired to free water from  $\text{Na}_2\text{CO}_3$ , the water is filtered through calcium permutite, when the following change takes place:—

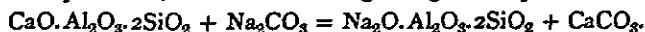

In the sugar industry Harms and Rümpler have used a similar process for clearing the juice and withdrawing potassium for sodium in the salts contained therein, thereby attaining a better taste in the molasses.

The calcium permutite of Gans removes from the sugar, syrup, and molasses not only the greater part of the potash, but also much sodium, by exchanging these bases for lime. The hot molasses can be filtered without dilution with water, so that reconcentration is avoided. In order to exchange the potash for an equivalent of sodium, the molasses is sent through a sodium permutite, when the potassium permutite is formed, while the sodium takes its place in solution. Molasses containing only sodium are stated to be much better than those which contain either potassium or lime. See Siedler, *loc. cit.*

(3) **Removal of manganese and iron from water.**—For the removal of manganese a manganese permutite is first made from calcium permutite and manganese chloride, thus:—

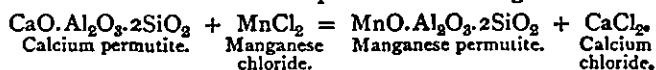

Next, the manganese radicle in the manganese permutite is converted into the heptoxide by treating with calcium or potassium permanganate:—

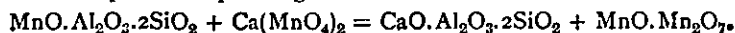

The  $\text{MnO.Mn}_2\text{O}_7$  is precipitated on and in the zeolith particles, and exercises an oxidising action on the lower oxides of manganese contained in the water, being itself reduced to lower stages of oxidation. Owing to this oxidising action the manganese contents of the water is completely precipitated as  $\text{MnO}_2$ . For example, if the manganese is present in water as a bicarbonate,  $\text{Mn}(\text{HCO}_3)_2$ , we get the following action taking place :—

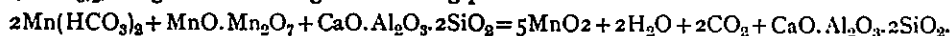

As soon as the manganese heptoxide has lost all its available oxygen its power of removing manganese from water is exhausted. This may be regenerated merely by retreating the permutite with calcium or potassium permanganate. The manganese mud formed which remains on the filter increases its efficiency.

Use is made of their reactions in sterilising water. First of all, the germs are killed by adding to the water some calcium or potassium permanganate. Next, the sterilised water is filtered through a manganese permutite, whereby all the permanganate and other manganese salts are removed. See this work, Vol. I., under **Water**.

The complete removal of iron from water is similarly effected by means of a manganese permutite. The iron is removed completely from the water, and this matter of de-ironising water is the most complete and efficient yet introduced into industry.

The action in removing the iron is probably catalytic. Under the influence of the manganese heptoxide and monoxide on the surface of the zeolite, the oxygen in the water oxidises the iron completely and quantitatively. It is thrown down and retained as oxide by the zeolite.

(4) **Removal of free alkali from water.**—The permutites possess the capacity of absorbing free alkalis from aqueous solution. By treating the zeolite with weak acids the absorbed alkali can be given up once more.

(5) **Preparation of salts of different bases by exchange.**—It is possible to extract a salt out of a dilute solution by filtering through a suitable permutite, and next, by suitable treatment, obtain it again in a concentrated form. For example, by passing a solution of potassium chlorate or perchlorate through an ammonium permutite, we get formed ammonium chlorate or ammonium perchlorate. By filtering ammonium carbonate through potassium permutite, potassium carbonate is obtained, and so on.

The use of this in recovering valuable salts escaping in waste liquors from factories as by-products will be obvious. It is possible that this process may have some value in quantitatively determining the amount of calcium, etc., in very dilute solutions.

(6) **Precipitation of gold from solution.**—The sodium base of sodium permutite is exchanged for ferrous or stannous oxide, and the gold-containing solution is filtered through it.

Gold from even extremely dilute solutions is precipitated in the zeolitic mass as purple of Cassius.

The manufacture and use of artificial zeolites (permutites) are protected by the patents of the firm of J. D. Riedel, A.G., Berlin.

## SECTION LVII

# THE ARTIFICIAL GEM INDUSTRY

BY GEOFFREY MARTIN, D.Sc., Ph.D.

### LITERATURE

- A. VERNEUIL.—“Production artificielle du rubis par fusion.” *Compt. rend.*, 1902, 135, 791; *ibid.*, 1908, 147, 933. *Ann. Chem. Phys.*, 1904 [8], 3, 20.
- L. PARIS.—*Compt. rend.*, 1908, 147, 933.
- A. J. MOSES.—*Amer. Journ. Soc.*, 1910, 30, 271.
- M. BAUER.—*Zeit. Angew. Chem.*, 1909, 2177.
- J. BOYER.—“La Synthèse des pierres précieuses.” Paris, 1909.
- NOËL HEATON.—“Artificial Precious Stones,” *Chem. World*, 1912, I., 79.
- P. TSCHINWINSKY.—“Reproduction artificielle de minéraux au XIX<sup>e</sup>. siècle.” Kieff, 1903-1906.

THE following table shows the composition of the principal precious stones:—

	Species.	Variety.	Composition.	
Element	Diamond	...	Carbon.	
Oxides	Corundum	Ruby	$Al_2O_3$ .	
		Sapphire		
		Oriental amethyst, etc.		
Oxides	Quartz	Rock crystal	$SiO_2$ .	
		Cairngorm		
		Amethyst		
Albuminates	Spinel	Balas ruby, etc.	Magnesium aluminate, $MgAl_2O_4$ .	
	Chrysoberyl	Alexandrite Cymophane	Beryllium aluminate.	
Silicates	Beryl	Emerald	Beryllium aluminium silicate.	
		Aquamarine		
	Garnet	Pyrope	Magnesium aluminium silicate.	
		Hessonite	Calcium            “            “	
		Almandine	Iron                “            “	
		Demantoid, etc.	Calcium iron silicate.	
	Silicates	Olivene	(Peridot)	Magnesium iron silicate.
		Sphene	...	Calcium titanium   “
		Spogumene	(Kunzite)	Lithium aluminium silicate.
		Topaz	...	Aluminium hydroxy-fluo-silicate.
Tourmaline		...	Alkali-calcium aluminium silicate.	
Zircon		Hyacinth	Zirconium silicate.	
		Jargoon		
Turquoise	...	Hydrated aluminium phosphate.		
Pearl	...	Calcium carbonate.		
Opal	...	Hydrated silica.		

Corundum and spinel are the main gem stones which have been produced artificially of a size and quality suitable for jewellery. Moissan has produced microscopic diamonds (see Moissan, "The Electric Furnace," 1904), but valueless as gems.

**Artificial turquoises** have been made for thirty years from aluminium phosphate containing water and a trace of copper to give a blue colour to the product.

"**Reconstituted rubies**" consist of splinters of rubies cemented together by a lead-containing flux.

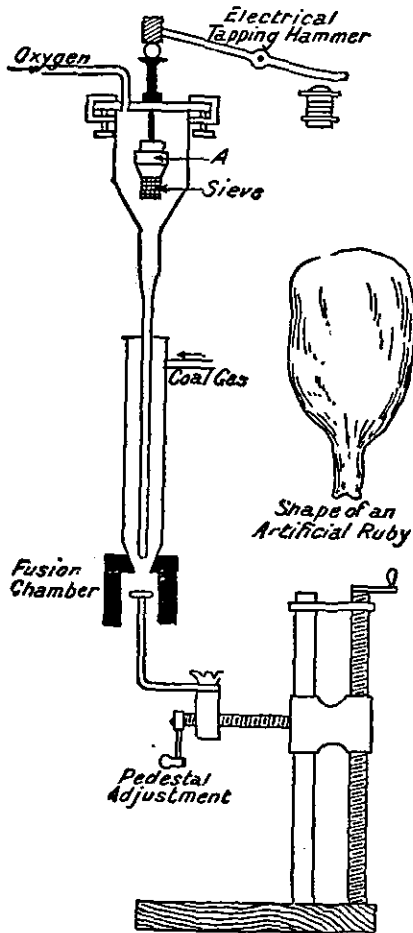

FIG. 1.—Verneuil's Blowpipe for Artificial Rubies and Sapphires.

It is stated that it is by no means unusual to form true artificial rubies of some 50-80 carats (10 g.) which, after cutting, form 12 carat rubies of a fine red colour. The uncut stones have a value under one shilling a carat. The sp. gr. (3.98-4.0), hardness, optical properties, etc., agree with the natural rubies.

Omission of the chromium leads to the formation of "**white sapphires**," consisting of pure alumina,  $\text{Al}_2\text{O}_3$ .

Other stones are also made of various colours and qualities, yellow like topaz, violet, amethyst, and also blue like sapphire. Since the blue colour of the sapphire is destroyed by intense heat, the colouring is artificially imparted to these stones by adding a little cobalt salt in the presence of lime or magnesium (otherwise the cobalt is not dissolved by the alumina), when a blue spinel ( $\text{MgAl}_2\text{O}_4$ ) is formed.

**Genuine rubies**, under the name "**rubis scientifiques**," were made by Fremy in 1891, by heating to  $1,500^\circ$  in a porous crucible a mixture of pure precipitated  $\text{Al}_2\text{O}_3$ , with a little  $\text{BaF}_2$  (or  $\text{CaF}_2$ ),  $\text{K}_2\text{CO}_3$ , and 2-5 per cent. potassium bichromate. The moist gases of the furnace caused the liberation of  $\text{HF}$ , and this, combined with water vapour, caused the crystallisation of the alumina into small rubies. However, in 1902, A. Verneuil, of Paris, made his "**rubis synthétiques**," which have since attained considerable importance, his factory producing annually some 5,000,000 carats of precious stones (1,000 kg.). The main process is briefly this:—

Pure iron-free ammonium alum,  
 $(\text{NH}_4)_2\text{SO}_4 \cdot \text{Al}_2\text{SO}_4 \cdot 24\text{H}_2\text{O}$ ,  
 is mixed with a little chrome alum,  
 $(\text{NH}_4)_2\text{SO}_4 \cdot \text{Cr}_2(\text{SO}_4)_3 \cdot 24\text{H}_2\text{O}$ ,  
 and the whole precipitated in warm aqueous solution by means of ammonia. A mixture of  $\text{Al}(\text{OH})_3$  and  $\text{Cr}(\text{OH})_3$  (2½ per cent.  $\text{Cr}_2\text{O}_3$  gives the best colour) is thus obtained.

The product is dried in the air, dehydrated at a bright red heat, and then the fine powder thus obtained is fused into a coherent mass in a special vertically placed reducing blowpipe flame, the flame playing downwards (see Fig. 1). Into this flame, from a receptacle A, the fine powder is allowed to steadily fall in a stream from a platinum sieve situated in a widening of the oxygen tube. A steady automatic shaking of this sieve by means of a tapping hammer, worked by an electromagnet, ensures that a steady rain of powder falls downwards continuously into the flame, and cools as a little cone of fused pure alumina just below the flame. First of all a little rod of fused alumina is formed, which later assumes the form of a drop, and finally acquires the form of an inverted bottle. The drop must finally be cautiously cooled (otherwise it may crack), and is then ground

True blue sapphires are made by Verneuil by adding 0.5 per cent. titanium dioxide,  $\text{TiO}_2$ , and 1.5 per cent. magnetic oxide of iron,  $\text{Fe}_3\text{O}_4$ ; analysis of the resulting sapphire gave  $\text{Al}_2\text{O}_3$ , 99.84 per cent.;  $\text{TiO}_2$ , 0.11-0.13 per cent.;  $\text{Fe}_2\text{O}_3$ , trace; sp. gr. 3.977-4.01.

Most of the other precious stones are either very costly to produce, or else do not possess sufficient value for their artificial production. The Japanese produce a kind of artificial pearl by introducing a mother-of-pearl shape between the shell and mantle of the oyster. The oyster deposits in time a layer of nacre over this. The mass, after removal, is backed with mother-of-pearl. A real artificial pearl or opal has not yet been made. Imitation diamonds, etc., are made from highly refractive lead or other glass, called "paste," or "strass." (See this Vol., under Glass.)



## SECTION LVIII

# ALUMINO-THERMICS: "THERMIT" AND ITS APPLICATIONS

BY H. STANLEY REDGROVE, B.Sc. (Lond.), F.C.S.

### LITERATURE

- Zeitschrift für angewandte Chemie.* Berlin, Jahrgang 1898, pp. 362 *et seq.*
- H. GOLDSCHMIDT.—"Ueber ein neues Verfahren zur Darstellung von Metallen und Legierungen mittelst Aluminiums," *Annalen der Chemie*, Vol. CCCI., Leipzig, 1898, pp. 19 *et seq.*
- and C. VAUTIN.—"Aluminium as a Heating and Reducing Agent," *Journal of the Society of Chemical Industry*, Vol. XVII., London, 1898, pp. 543 and 649.
- "Alumino-Thermics," *Transactions of the American Electrochemical Society*, Vol. VI., Philadelphia, 1904, Part II., pp. 85 *et seq.*
- ADOLPHE MINET.—"The Production of Aluminium and its Industrial Use," translated, with additions, by LEONARD WALDO, S.D. (Harv.). New York, 1905.
- H. STANLEY REDGROVE.—"The Goldschmidt Reaction," *Knowledge*, Vol. XXXIV., London, 1911, pp. 249 *et seq.*
- "Alumino-Thermics and their Application to Engineering and Metallurgy," and other pamphlets issued by Messrs Thermit Ltd.<sup>1</sup>

### HISTORICAL AND THEORETICAL

If one examines a table of the heats of combustion of the elements, in which the figures given refer in each case to the same weight of oxygen, it will be found that aluminium stands almost highest. It is evident, therefore, that it ought to be possible to obtain a reduction of the oxides of most other elements by means of aluminium.

Early experiments in this field, however, proved very unsatisfactory. The brothers Tissier, who attempted the preparation of manganese in this way, did not succeed in getting any reaction, probably because they did not heat their ingredients to a sufficiently high temperature. Other experimenters found that the reaction between aluminium and metallic oxides took place with explosive violence. L. Frank and others have succeeded in reducing various oxides and other compounds by heating them with aluminium in the ordinary way; but it is to a discovery made by Dr Hans Goldschmidt that all the technological developments of the subject are due.

Goldschmidt required, for the purposes of another experiment, a quantity of pure aluminium sulphide, and after some unsuccessful attempts to prepare this by other methods, attempted the reduction of galena (lead sulphide) by means of aluminium. The ingredients in coarse powder were intimately mixed together and heated in a furnace. A violent reaction took place, with the generation of sufficient heat to render the whole contents of the crucible fluid, and by using a weight of aluminium slightly in excess of that given by the equation,

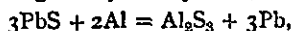

aluminium sulphide of a very high degree of purity was obtained. The excess of aluminium settled out as a button from the mass of lead (which, owing to its density, sank to the bottom of the crucible), and removed from it various metallic impurities (*e.g.*, silver).

---

<sup>1</sup> My very best thanks are due to Messrs Thermit Ltd. for their kindness in supplying me with details concerning the various technological applications of "thermic" reactions, and for opportunity to examine their apparatus and methods.

**Goldschmidt** was thus led to experiment on oxides; and these experiments and those of other investigators show (1) that the reaction between aluminium and metallic oxides will not take place until a certain critical temperature is reached—about  $1,050^{\circ}$  C. in the case of chromic oxide; and (2) that the reaction once started generates sufficient energy to heat the mixture to a temperature (nearly  $3,000^{\circ}$  C. in the case of ferric oxide) far above this critical temperature. It follows, therefore, that if the reaction can be once started at any point in the mixture, it will spread throughout the whole mass. The case is quite analogous to that of a ball balanced at the top of a hill, which may serve to illustrate the principle involved. Nothing happens so long as sufficient energy to overcome the friction between the surface of the ball and the ground at the top of the hill is not forthcoming; but if this friction is once overcome, the ball will commence to roll down the hill, and will continue until its journey is completed at the bottom. **Goldschmidt** succeeded in producing reactions in the case of mixtures of aluminium and metallic oxides by means of a fuse of aluminium and barium peroxide (which can be ignited by a flaming vesta), or in some cases by means of a burning strip of magnesium ribbon. The reaction can very easily be carried out. All that is necessary is to make an intimate mixture of aluminium and the oxide, both in powder, in a fire-clay crucible, which may be stood inside another crucible to avoid overflowing of the contents in case the first crucible should crack. The reaction is then started by a fuse as described above. It rapidly spreads throughout the mass, the whole contents of the crucible becoming liquid, and the metal sinking to the bottom.

In some cases, by using a weight of metallic oxide slightly in excess of the theoretical, metals of a very high degree of purity, free from carbon, may be obtained. **Goldschmidt** succeeded in producing reactions with oxides of the following metals:—Chromium, manganese, iron, copper, titanium, tungsten, molybdenum, nickel, cobalt, zirconium, vanadium, niobium, tantalum, cerium, thorium, barium, calcium, sodium, potassium, lead, and tin—but the pure metal was not obtained in every case. In some cases, however, such as that of titanous oxide, in which the product is not the pure metal, it is sufficiently pure to serve for the preparation of the chloride. Moreover, by using mixtures of metallic oxides, alloys of desired composition can be obtained.

The reaction in the case of ferric oxide is represented by the following equation:—

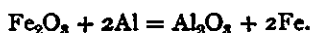

A mixture of ferric oxide (or other oxide of iron) with aluminium, in the right proportion, has very many technological uses, as will appear hereafter, and has been given the registered name of "thermit." Reactions similar to those between aluminium and ferric oxide are classed as "thermic" reactions.

The reaction between aluminium and calcium oxide (lime) has been specially studied by **Weston** and **Ellis**.<sup>1</sup> It only occurs when the ingredients are heated in a furnace, and is then by no means complete. It seems, therefore, to differ from the reactions between aluminium and other metallic oxides in being endothermic, and the authors conclude that calcium has greater affinity than aluminium for oxygen. They found that magnesia (magnesium oxide) was quite unattacked by aluminium. With alumina itself, aluminium yields a blackish-grey product, probably containing a suboxide.

Aluminium will react with certain non-metallic oxides, e.g., boron trioxide and silica.<sup>2</sup> In the former case the product of the reaction contains aluminium boride and aluminium nitride (the nitrogen coming from the air) as well as alumina and free boron. In the latter case impure silicon is obtained as a crystalline body containing aluminium. Aluminium will also react with charcoal; in this reaction the air seems to play an important part, the product containing aluminium oxide and nitride, as well as aluminium carbide ( $\text{Al}_4\text{C}_3$ ), together with unchanged aluminium and carbon.<sup>3</sup>

Aluminium readily reacts with many metallic sulphides. In the reaction with lead sulphide

<sup>1</sup> F. E. Weston and H. R. Ellis: "The Heats of Combustion of Aluminium, Calcium, and Magnesium," *Transactions of the Faraday Society*, Vol. IV., 1908, pp. 130 *et seq.*

<sup>2</sup> F. E. Weston and H. R. Ellis: "Note on the Action of Aluminium Powder on Silica and Boric Anhydride," *Transactions of the Faraday Society*, Vol. III., 1907, pp. 170 *et seq.*

<sup>3</sup> F. E. Weston and H. R. Ellis: "The Interaction of Aluminium Powder and Carbon," *Transactions of the Faraday Society*, Vol. IV., 1908, pp. 60 *et seq.*

already mentioned, if finely powdered aluminium is used, sufficient heat may be generated to volatilise the lead and produce explosion. Goldschmidt, at the time of the announcement of his discovery, had also succeeded in reducing sulphides of the following metals by means of aluminium—iron, cobalt, nickel, molybdenum and zinc.

Aluminium will also reduce phosphates, sulphates, and nitrates, the reactions with sulphates being more violent than those with nitrates.

Weston and Ellis have succeeded in bringing about the reaction between aluminium and sodium peroxide and aluminium and ferric oxide *in vacuo*, using an electrically heated iron wire to start the first reaction, and employing this reaction to initiate the second.<sup>1</sup>

Similar reactions in which bodies other than aluminium are employed are also known. For instance, F. M. Perkin has found that a mixture of calcium hydride ( $\text{CaH}_2$ ) and cupric oxide in the proportion of two molecules of the latter to one of the former can be readily ignited with the production of copper, lime, and steam, the temperature, however, being insufficient to melt the whole of the copper produced. A mixture of antimony sulphide with calcium hydride is also very easy to ignite, the mixture swelling up as the reaction proceeds in a manner resembling that in which mercury thiocyanate (Pharaoh's serpents) behaves when ignited.<sup>2</sup>

Goldschmidt has succeeded in bringing about the reduction of metallic oxides, etc., by means of metallic calcium. He has found that whilst this metal reacts with oxides in a very violent manner, no regulus of metal is produced because of the limited fusibility of the calcium oxide formed. He has found, further, that, whereas negative results are obtained if silicon is substituted for calcium, a mixture of calcium and silicon will react satisfactorily with metallic oxides, giving a fusible slag of calcium silicate.<sup>3</sup>

G. F. Jaubert has patented mixtures which, on ignition, react "thermically" with the evolution of hydrogen.<sup>4</sup>

## TECHNOLOGICAL PREPARATION OF METALS AND ALLOYS BY THE "GOLDSCHMIDT REACTION"

The preparation of metals and alloys by the Goldschmidt reaction is, as already mentioned, an exceedingly simple matter. All that is necessary is to make an intimate mixture of the oxide or mixture of oxides (in the right proportion) with slightly less than the theoretical weight of aluminium powder. The mixture must be dry, and is preferably heated before starting the reaction, which is done by means of a fuse, as already described. After the reaction has ceased, the metal or alloy will be found at the bottom of the crucible in which it is carried out. One great advantage of the method is that products can be obtained free from carbon. In the case of chromium and manganese, it is found that the low oxides give rather poor yields, whilst the high oxides act explosively. Goldschmidt and Weil find that the yield can be much improved, without the reaction becoming explosive, if the lower oxides are used with the addition of a small amount of the higher oxides.

The following are some of the metals and alloys actually manufactured by this method, and on the market at present.

### (A) Metals.

(1) **Chromium.**—"Thermic" chromium has a purity of about 98-99 per cent.; the impurities consist of iron and silicon. It is a brittle metal, of melting point higher than that of platinum, but alloying easily with liquid steel. It is employed in the manufacture of steels with a high chromium content, mainly crucible steel for the best grades of high-speed tool steel. It is also used in ordnance manufacture.

<sup>1</sup> F. E. Weston and H. R. Ellis: "Thermic Reactions in Vacuo," *Transactions of the Faraday Society*, Vol. VI., 1910, pp. 144 *et seq.*

<sup>2</sup> F. M. Perkin and L. Pratt: "Reducing Action of Metallic Calcium and Calcium Hydride upon Metallic Oxides, Sulphides, and Halogen Salts," *Transactions of the Faraday Society*, Vol. III., 1907, pp. 179 *et seq.*

<sup>3</sup> English Patent, 1906, No. 788.

<sup>4</sup> English Patent, 1911, No. 153. For further particulars see the present writer's article on "Hydrogen" in "Industrial Gases" (Crosby Lockwood, 1916)

(2) **Molybdenum.**—“Thermic” molybdenum has a purity of about 98-99 per cent., the impurities being similar to those in the case of chromium. It is used for rendering steel specially hard, and thus finds an application in the manufacture of tool steels. In this property it is said to be preferable to tungsten. “Thermic” molybdenum, being in fused lumps, does not oxidise in the air like the ordinary powdered variety.

(3) **Manganese.**—“Thermic” manganese has a purity of 96-97 per cent. The chief impurities are iron and silicon. It is very brittle, and fuses at a lower temperature (*circa* 1,227° C.) than chromium. It is used in the manufacture of very hard steel (12-14 per cent. Mn), which may be subjected to considerable strain, and also to alloy with other metals and alloys. It may be added in any amount to zinc-copper alloys, whose strength and other properties are thereby improved. It may, to about 2 per cent., be added to nickel castings to act as a deoxidising agent, whereby the density is increased, for which purpose its use does not occasion the deleterious effects sometimes produced by magnesium. A very small proportion of manganese is found to improve the colour of German silver, and is used with advantage as a deoxidising agent in the case of many other alloys, though it should not be employed with copper-tin alloys containing more than a very low percentage of tin.

### (B) Alloys.

(1) **Chromium-Molybdenum**, 50 per cent. Cr, 50 per cent. Mo.

(2) **Chromium-Manganese**, 30 per cent. Cr, 70 per cent. Mn.

(3) **Chromium-Nickel**, 10 per cent. Cr, 90 per cent. Ni, and 50 per cent. Cr, 50 per cent. Ni.

(4) **Chromium-Copper**, 10 per cent. Cr.

The alloys of chromium with molybdenum, manganese, and nickel are used in the manufacture of hard steels. Those with manganese and copper may be added with advantage to copper, and increase its elasticity.

(5) **Molybdenum-Nickel**, 75 per cent. Mo, 25 per cent. Ni.

(6) **Ferro-Molybdenum**, 80 per cent. Mo.

Ferro-molybdenum may be used in place of molybdenum in the manufacture of hard steel, and the price of the alloy is less per weight of molybdenum it contains than that of the pure metal. The molybdenum-nickel alloy is used in the manufacture of saws.

(7) **Ferro-Titanium**, 23-25 per cent. Ti, 70-72 per cent. Fe, 5 per cent. Al.

This alloy is extensively used as a cleansing agent for all classes of steel. The presence of the small proportion of aluminium renders the alloy more soluble; moreover, the aluminium acts as a deoxidising agent, leaving the titanium free to remove nitrogen, and further, it produces a slag of aluminium titanate, which is more easily fusible than either alumina or titanous oxide. Steel treated with this alloy is rendered tougher and denser.

(8) **Ferro-Vanadium**, 35 per cent. Va, 1-2 per cent. impurity (Al and Si).

Added to mild steel, vanadium in slight amount considerably increases its elasticity. It may also be added to iron castings to render them tougher.

(9) **Ferro-Boron**, 20-25 per cent. Bo.

This alloy added to steel acts in a somewhat similar way to carbon, but it is only infrequently employed.

(10) **Manganese-Copper** (iron-free), 30 per cent. Mn.

(11) **Manganese-Tin** (lead-free), 50 per cent. Mn.

(12) **Manganese-Zinc** (lead-free), 20 per cent. Mn.

(13) **Manganese-Titanium**, 30-35 per cent. Ti.

These manganese alloys are used in place of pure manganese in the manufacture of non-ferrous alloys. In the preparation of those containing tin and zinc, the slag formed on the molten tin and zinc must be removed before adding the manganese, and the charge kept heated for several hours. Manganese-titanium alloy is used for removing oxygen and nitrogen from copper alloys.

In this connection may be mentioned the use of titanium “thermit” in foundry work. This preparation consists of ordinary “thermit” containing a small proportion of titanium oxide, and is put up in tins, through which are drilled a couple of holes, by means of which the tin can be fastened to a rod. As soon as the molten metal is run from the furnace into the ladle, the tin of titanium “thermit” is plunged in and held at the bottom until the reaction is over. The slag rises to the top, and can thus be easily removed. The effect of the treatment is to cleanse the metal from impurities, thus increasing its fluidity, and producing a finer and closer grain; moreover, the sulphur content is reduced.

USES OF "THERMIT" AS A HEATING AGENT

The uses of "thermit" as a heating agent are defined by the nature of the "thermit" fire. As Goldschmidt has pointed out, "thermit" provides us with a fire differing in certain important respects from all other fires. In the first place, in the combustion of "thermit," neither is air consumed nor is any gas evolved, as in the case of the combustion of wood, coal, coal-gas, producer-gas, or petrol. The most important difference, however, is in the heat-density. The actual amount of heat obtainable from a given weight of "thermit" is considerably less than that obtainable from the same weight of anthracite;<sup>1</sup> but in the former case the whole of this heat is, so to speak, obtained at once, since the reaction between aluminium and iron oxide takes a very small period of time from commencement to completion, even when the weight of material is very considerable. Indeed, in the combustion of "thermit," a heat-density is produced not otherwise obtainable, the actual temperature being considerably above that of the electric furnace. Where a continuous heating effect rather than density of heat is the essential desideratum, "thermit" would be useless; thus it is not suitable for locomotive purposes, or for cooking generally.<sup>2</sup> But where great density of heat is required, "thermit" is preferable to other sources of heat, because by its aid one can so readily produce an enormous temperature at a moment's notice.

The chief uses of "thermit" as a source of heat are in the butt-welding of pipes, and for reheating sluggish metal in foundry practice.

For the latter purpose the "thermit" is made up in tins, which are employed, when it is desired to reheat the metal in the ladle, in a similar manner to that used in the case of titanium "thermit." Tins of "thermit" may also be placed in the risers of castings, and are found particularly useful in making intricate castings, or those that are long and narrow (*e.g.*, ships' stems and stern posts). In such cases the tins should be built into the moulds. A pinch of ignition powder is necessary to initiate the reaction in the case of cast iron, but is not required in the case of steel.

The butt-welding of iron or steel pipes<sup>3</sup> is accomplished in the following manner:—The ends of the pipes to be welded together are surrounded by a suitable mould, into which the products of the "thermit" reaction are poured. Welding temperature being reached, the ends of the pipes are pressed together by means of screws placed in position beforehand. For pipes not exceeding  $\frac{1}{2}$  in. in thickness, special cast-iron moulds with handles have been designed, and can be used over and over again; but for larger pipes it is advisable to use sheet-iron moulds (made in the shape of a horseshoe, in two pieces) banked round with damp (but not wet) sand. Of course, if the liquid iron, formed by the reaction, were allowed to come into contact with the pipes they would be fused through, but it is found that the alumina slag, which first issues from the crucible when the products of the "thermit" reaction are poured out, solidifies on the surfaces of the pipes, thus forming a highly refractory protective coating, through which the metal cannot penetrate.

During the present war a deplorable application for the "thermit" fire has been found in the construction of incendiary bombs—unfortunately, so many scientific discoveries, which rightly applied are of the greatest utility to man, may be debased to vile ends.

The "thermit" fire is peculiarly adapted for purposes of destruction, inasmuch as it is so difficult to extinguish. Fire may usually be extinguished (i.) either by cutting off the supply of oxygen (air) necessary to the combustion of the burning body, by means, for example, of blankets, sand, carbon dioxide, etc., or (ii.) by wetting the body with a non-inflammable liquid (*e.g.*, water), which not only to some extent screens it from the air, but, by extracting much of its heat, reduces its temperature below that at which the combustion will take place. In the case of the "thermit" fire, however, like that of gunpowder and similar mixtures, no external oxygen is needed for the combustion, hence screening it from the air is without effect, as is evident from the equation representing the reaction, and is demonstrated by the experiments of Weston and Ellis mentioned above. Moreover, the temperature is sufficiently high to decompose water, with the evolution of hydrogen, which itself is highly inflammable—

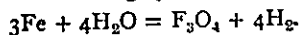

<sup>1</sup> Goldschmidt gives the following figures: 1 kilogram of "thermit" gives 450 cal., 1 kilogram of anthracite gives 7,000 cal.

<sup>2</sup> As concerns cooking, it may be mentioned that the "Deutsche Munition und Waffenfabrik," of Karlsruhe, have constructed a cooking and roasting stove for camp cooking.

<sup>3</sup> English Patents, 1899, No. 18,328, and 1900, No. 20,894.

On the other hand, of course, the burning of objects set fire to by the "thermit" fire may be extinguished in any way ordinarily applicable.

The "thermit" incendiary bombs used by the Germans in their air raids over England are usually conical in shape, with a flat metallic cup, about 10 in. in diameter, as base. On this is fitted a pierced metallic funnel filled with thermit, with a metallic cap and handle at the top. Generally some yellow phosphorus, which is not only highly inflammable, but generates nauseous fumes on combustion, is introduced at the base of the funnel. Outside the funnel is a padding of highly inflammable resinous material, which is bound on with rope, wires being fastened from the outer rim of the cap to that of the base to increase the stability of the bomb. The rope used is probably first treated so as to increase its inflammability. Occasionally celluloid chippings are added, and more rarely a small amount of petrol.<sup>1</sup>

### USES OF "THERMIT" AS A HEATING AGENT AND SOURCE OF MOLTEN STEEL

Not only may the heat derived from the "thermit" reaction be utilised in welding, but the liquid steel produced at the same time may be employed to form a bulb around the joint, thereby greatly strengthening it. This method of welding, patented by **Goldschmidt**,<sup>2</sup> has been very extensively employed in the welding of tram-lines.

The rails which are to be welded by this method should have no bolt holes, and the ends should be undercut  $\frac{1}{8}$  in. in order to ensure a proper butt-weld. They must be brought into true alignment and clamped tightly together. The "thermit" is ignited in a crucible with a hole in the bottom fitted with a device for tapping. Moulds of sand of a loamy and plastic nature, mixed with quartz of not too close-grained or clayey a character, but as free, porous, and sharp as will permit of binding, are constructed so that the "thermit" steel, which first issues from the crucible when it is tapped after the reaction is over, runs to the bottom of the rail, forming a metal bulb over the joint to about half-way up the rail or more. The moulds must be thoroughly baked, coated with graphite, and the two sections carefully luted together. It is very essential that everything with which the products of the "thermit" reaction come into contact should be thoroughly dry and warm. The molten metal, of course, must not be allowed to come in contact with the top of the rail, which should be completely covered by the molten alumina which issues from the crucible after the metal has flowed out. When welding temperature has been reached the rails are pressed together by means of clamps placed in position beforehand.

Third, or conductor, rails may also be similarly welded, or conduction may be ensured simply by welding a small bridge of "thermit" metal on to the base of the rail.

In the case of rails containing high percentage of carbon a modified method of welding, known as the "Stelcop" (Steel-Copper) process, is employed. The main point in this process is that prior to welding, and after the rails have been placed in alignment, a thin copper-coated steel shim is introduced between the rail heads. The rail ends are, for welding by this process, not undercut, and the clamps are not screwed up after welding. The heat of the molten slag surrounding the rail heads melts out the copper and leaves them firmly welded together.

Tests carried out on rails welded by means of "thermit" have proved eminently satisfactory. The following are given by the Manchester Corporation Tramways (29th November 1906):—

BENDING TESTS

Description.	Span.	Loads. Elastic Limit.	Bending Moment.
Solid rail - - - - -	10 ft.	28,200	70,500
Fishplate jointed rail - - - - -	10 "	10,000	25,000
"Thermit" jointed rail - - - - -	10 "	25,000	62,500
Solid rail - - - - -	5 "	74,000	92,500
"Thermit" jointed rail - - - - -	6 "	42,000	63,000

<sup>1</sup> Cf. "German Zeppelin Raids over Great Britain," *The Sphere*, Vol. LXII., London, 1915 (18th September), p. 296.

<sup>2</sup> English Patent, 1901, No. 10,859.

CHEMICAL TESTS

Ordinary Steel Rail.	"Thermit" Weld.	Drillings from Rail Head near Welded Joint.	Drillings from Rail Head away from Welded Joint.
Iron - - 98.520	Iron - - 97.82	Iron - - 98.3743	Iron - - 93.331
Manganese - 0.865	Manganese - trace	Manganese - 1.009	Manganese - 1.038
Phosphorus - 0.042	Phosphorus - "	Phosphorus - 0.067	Phosphorus - 0.065
Sulphur - 0.054	Sulphur - 0.02	Sulphur - 0.059	Sulphur - 0.058
Silicon - 0.021	Silicon and In-	Silicon - 0.0027	Silicon - 0.018
Carbon - 0.498	soluble - 0.51	Carbon - 0.488	Carbon - 0.490
Arsenic - trace	Carbon - 0.11		
	Aluminium - 1.48		

These analyses indicate no alteration in the composition of the steel in the rail head.

HARDNESS TESTS<sup>1</sup>

Load on Die in Tons.	Welded Rail. Length of Indentation Produced.	
	Away from Joint.	Close to Joint.
0.25	0.26 in.	0.26 in.
0.50	0.32 "	0.32 "
0.75	0.37 "	0.36 "

Metal tested from head of rail.

It is clear from the results of the hardness test that the subjection of the welded edges of the rail to the high temperature of the reaction had no injurious effect on the hardness of the rail.

The liquid steel produced by the "thermit" reaction may also be used in repair work of every character, not only in the case of small articles, but in that of the very largest. Indeed, by the ignition of a couple of hundredweights of "thermit," one may produce in a few moments a hundredweight of superheated mild steel; a quantity producible in so short a period of time by no other means. Crucibles, similar to those employed in the welding of tram-lines, are employed, the details of the method depending, of course, on the type of repair to be effected. The process has been sanctioned by the British Corporation for the Survey and Registry of Shipping for repairs to fractured stern posts, rudder frames, and damages of a similar character. The results of the Corporation's bending tests (July 1909) on "thermit" welded bars are here appended, and show that the welded bars were considerably stronger than an unwelded bar.

<sup>1</sup> The relative hardness was determined by measuring the lengths of indentations made by a hardened steel die with a curved edge struck to a radius of 1 in., and having a cutting edge whose angle was 50°.

Description.		Distance between Supports.	Load Applied in Tons at Centre of 3-ft. Supports.															Maximum Stress, Tons.	Remarks.	
			Deflection and Set in Inches.																	
Mark.			Load in Tons.	5	20	30	35	40	50	60	70	80	90	100	110	120	130	140		
K1	5 in. square "thermit" welded bar	3 ft.	Defln.	zero	...	.02	.06	.08	.10	.12	.40	.80	.85	1.02	1.38	1.85	2.58	3.72	143.0	The bar broke outside the weld. Fracture, finely granular.
			Set	...	...	...	...	...	.02	.06	...	...	...	...	...	...	...	...		
K2	5 in. square "thermit" welded bar	3 ft.	Defln.	zero	.02	.06	.08	.09	.11	.13	.26	...	...	...	...	...	...	...	71.5	Bar deflected 0.30 in. Load applied, half maximum applied to bar K1. No sign of cracking.
			Set	...	...	...	none	.05	.06	.07	...	...	...	...	...	...	...	...		
K3	5 in. square unwelded bar	3 ft.	Defln.	zero	...	none	.02	.05	.10	.38	.75	1.20	1.88	2.90	4.62	6.33	...	...	123.15	The bar continued to bend without any further increase of load, and the test was stopped after bending through an angle of 50°. No sign of cracking.
			Set	...	...	...	...	...	.03	.30	...	...	...	...	...	...	...	...		
K4	5 in. square "thermit" welded bar	3 ft.	Defln.	zero	...	.02	.04	.08	.08	.10	.22	.48	.70	1.08	1.50	2.25	3.18	...	139.60	The bar broke outside weld.
			Set	...	...	..	...	none	.03	.05	...	...	...	...	...	...	...	...		<i>FRACTURE:</i> Finely granular.



In repair work it is frequently found advantageous to add a certain proportion of steel punchings to the "thermit"; this reduces the weight of "thermit" required (and hence the cost) and renders the action less violent. As to the chemical composition of the steel obtained from "thermit," the following figures are given by Messrs Thermit Ltd.—

Carbon	-	-	-	0.05 per cent. to 0.10 per cent.
Manganese	-	-	-	0.08       "     0.10   "
Silicon	-	-	-	0.09       "     0.20   "
Sulphur	-	-	-	0.03       "     0.04   "
Phosphorus	-	-	-	0.04       "     0.05   "
Aluminium	-	-	-	0.07       "     0.18   "

The figures of the Manchester Corporation Tramways for the weld in tram-rails, which differ slightly from these, have already been given.

### USES OF "THERMIT" SLAG

In the slag from the reaction of chromium "thermit," minute red-coloured crystals are found, which must be regarded as rubies, the ruby consisting of nothing but alumina coloured by chromium. They are too small to be of any commercial value.

Important commercial uses have, however, been found for the alumina which constitutes the slag formed in the reaction between aluminium and metallic oxides. The alumina thus obtained has been given the registered name "corubin." Owing to its comparative freedom from other metallic oxides and absolutely anhydrous condition, it is harder than natural emery and is therefore found to be preferable to it for polishing purposes. Moreover, according to **Dr Buchner** of Mannheim, it is preferable to natural corundum<sup>1</sup> (which it resembles) in the manufacture of pottery, for which purpose it is mixed with clay and burned. It is claimed to be especially useful for making chemical apparatus which may be subjected to great changes in temperature without fracturing.

---

<sup>1</sup> Corundum is crystallised alumina containing traces of ferric oxide.

## SECTION LIX

# THE CALCAREOUS CEMENTS INDUSTRY

BY ERNEST A. DANCASTER, B.Sc. (Lond.)  
*Consulting and Analytical Chemist*

### LITERATURE

- E. A. DANCASTER.—“Limes and Cements.” London, 1916.  
 E. C. ECKEL.—“Cements, Limes and Plasters.” London and New York, 1913.  
 G. REDGRAVE and C. SPACKMAN.—“Calcareous Cements.” London, 1905.  
 A. H. HEATH.—“A Manual on Lime and Cement.” London and New York, 1893.  
 E. CANDLOT.—“Ciments et Chaux Hydrauliques.” Paris, 1891.  
 E. LEDUC and G. CHENU.—“Chaux, Ciments et Plâtres.” Paris, 1912.  
 P. C. H. WEST.—“The Modern Manufacture of Portland Cement.” London, 1910.  
 C. NASKE.—“Die Portlandzement Fabrikation.” Leipzig, 1909.  
 D. B. BUTLER.—“Portland Cement. Its Manufacture, Testing and Use.” London and New York, 1913.  
 R. K. MEADE.—“Portland Cement.” London, 1911.  
 A. C. DAVIS.—“Portland Cement.” London, 1909.  
 B. BLOUNT.—“Lectures on Cement.” London, 1912.  
 M. PEDROTTI.—“Der Gips und seine Verwendung.” Leipzig, 1901.  
 F. QUIETMEYER.—“Zur Geschichte der Erfindung des Portlandzementes.” Berlin, 1912.  
 H. LE CHATELIER.—“Sur la Constitution des Mortiers Hydrauliques.” Paris, 1904.  
 H. SEGER and E. CRAMER.—“Apparate und Gerate zur Prufung von Portlandzement, Beton und Zementwaren.” Berlin, 1908.  
 C. H. DESCHE.—“The Chemistry and Testing of Cement.” London, 1911.  
 F. G. GATEHOUSE.—“A Handbook for Cement Works Chemists.” London, 1908.  
 W. A. RICHARDS and F. B. NORTH.—“Manual of Cement Testing.” London, 1913.  
 G. R. BURNELL.—“Limes, Cements, Mortars, etc.” London, 1910.  
 C. MARSH and W. DUNN.—“Reinforced Concrete.” London, 1905.  
*Transactions of the Concrete Institute.*  
*Concrete-Cement Age.*  
*Cement and Engineering News.*  
*Concrete and Constructional Engineering.*  
*Il Cemento.*  
*Ferro-Concrete.*  
*Beton und Eisen.*  
*Tonindustrie-Zeitung.*

THE calcareous cements are compounds of calcium. They are divided into limes and cements according to their composition and behaviour towards water, but the division is only a matter of convenience, because they are all cements. The **limes** consist of more or less pure calcium oxide, CaO, and the **cements** consist of salts, such as silicates and aluminates. Limes “slake” or crumble to powder, with more or less evolution of heat, when treated with a little water, the action being very energetic in the case of pure lime, and very slow in the case of hydraulic limes. Cements, on the other hand, do not slake when in contact with water, but “set” or solidify without any perceptible change of volume, and with little evolution of heat. The hydraulic limes also possess the property of setting under water, but are distinguished from the cements by their power of slaking. The whole group of calcareous cements may be classified as follows:—

LIMES.  
Common lime.  
Hydraulic limes.

CEMENTS.  
Puzziolanic and slag cements.  
Natural cements.  
Portland cement.  
Plaster cements.

This classification, however, can only be considered as approximate, because some of the classes merge into one another by imperceptible degrees. Thus, there are limes of every degree of hydraulicity between pure common lime and the true hydraulic limes, and the latter gradually pass into the puzzuolanic cements. Again, there is no hard and fast line between Portland cement and the natural cements, some of the latter being known as **natural Portland cements**, on account of their similarity to the artificial product.

## COMMON LIME

The chemical properties of common lime, CaO, are discussed under **Calcium Salts**, Vol. I., p. 341. We here deal solely with its manufacture and its use as regards the cement and mortar industry. The lime is obtained by calcining calcium carbonate, CaCO<sub>3</sub>, at a red heat, so as to drive off the water, which is generally present, and to expel the carbon dioxide, CO<sub>2</sub>. The reaction takes place according to the equation—



The calcium oxide thus obtained is known as **quicklime**, **caustic lime**, or **common lime**. On adding a little more than the correct amount of water (18 parts by weight of water to 56 parts by weight of pure calcium oxide) chemical combination takes place. Owing to the heat of the reaction some of the water is expelled as steam, and the lime crumbles to a perfectly dry powder known as **slaked lime**, which consists of calcium hydrate, Ca(OH)<sub>2</sub>—

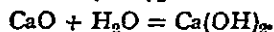

For the chemical properties of slaked lime, see under **Calcium Salts**, Vol. I., p. 341.

**Calcium carbonate** occurs naturally in a number of forms, some of the best known being **marble**, **limestone**, and **chalk**, any of which will yield the oxide on calcination. For the chemical properties of calcium carbonate, see under **Calcium Salts**, Vol. I., p. 341.

**Marble**.—White marble consists of nearly pure calcium carbonate, and therefore yields a very pure lime. It is, however, too expensive to be used for the preparation of lime for ordinary purposes, and the lime produced is too rich to be used for building purposes, unless it be mixed with burnt clayey matter.

**Limestone**.—This is a very abundant, dense form of calcium carbonate, which is less pure than marble, and is sometimes very impure. It usually contains free silica, aluminium silicate, and magnesium carbonate. When the stone contains 5 per cent. or more of the last mentioned constituent it is known as **dolomitic limestone**, and when the amount reaches 23 per cent. it is known as **dolomite** or **magnesium limestone**; as limes containing much magnesia, MgO, slake very imperfectly, dolomites are not used for the manufacture of lime except for special purposes, as for the linings of some furnaces. Those limes which contain much aluminium silicate are used for the manufacture of hydraulic limes (which see, p. 82).

**Chalk**.—This is very similar to limestone, and varies in purity in the same manner. It is, however, much softer, and contains a considerable amount of water when quarried. The upper, or white, chalk yields a pure lime, whilst the lower, or grey, chalk yields a more or less hydraulic lime.

**Other Sources of Lime**.—Amongst other materials **sea shells** are used as a source of lime. The waste shells from the oyster canning industry are thus utilised at Baltimore and other places in America, and also in Holland. The lime obtained from this source is too rich to be used for building purposes unless it be mixed with puzzuolanic matter (see p. 83). A considerable amount of lime is obtained in India from deposits of impure calcium carbonate, known as **kunkur** or **kankar**, which is found in the alluvial soil of the plains. After burning, it is mixed with sand and water, and generally with a little molasses to form the rendering known in India as **chunam**. The only effect of the molasses is apparently to retard the drying, which might otherwise become too rapid in a hot climate.

**Lime Burning.**—The raw material is calcined in kilns at a temperature of not less than  $812^{\circ}$  C. (For dissociative pressures of  $\text{CaCO}_3$  see Vol. I., under **Calcium Salts.**)

The operation is a simple one, as the burner has only to expel the water and carbon dioxide, and there are therefore no complicated reactions involved. It is, however, necessary to remove the products of decomposition, because calcium carbonate can be fused without decomposition in an atmosphere of carbon dioxide, yielding a marble-like mass. The removal of the carbon dioxide is effected by means of the natural draught of the kiln. The decomposition is facilitated in an atmosphere of steam, as was first shown by Gay Lussac, and it is a common practice to inject water or steam into the kilns for this purpose. Where this is not done, the lime burners often wet the material before burning, and thus obtain a certain amount of steam. The carbon dioxide produced during lime burning is usually wasted, although it is a valuable by-product. It is, however, sometimes utilised in condensing plants in Germany and the United States. See under **CO<sub>2</sub> Industry.**

Lime burning is a very ancient industry, the earliest form of kiln being probably a hole in the ground in which the mixed raw material and fuel were placed and ignited, the process being an intermittent one. Many forms of kiln for lime burning are in use at the present time, but they may all be classified under two heads: (1) **intermittent kilns**, in which the calcined charge is withdrawn when it is cold and the kiln restarted with a fresh charge, and (2) **continuous or draw kilns**, in which the raw material is fed in at the top and the lime is removed at the bottom, so that the process is continuous. Continuous kilns are subdivided into two classes, **stationary or vertical kilns**, and **rotary kilns**. The stationary continuous kilns may be of the mixed feed (**running**) or of the separate feed type.

The **flare kiln**, which is shown in Fig. 1, is a kiln of the first class. It is roughly egg-shaped, and, with the exception of a space at the bottom, is filled with lumps of limestone or chalk, supported on a roughly built arch of bigger lumps of the same material. The fuel is burnt on fire-bars in the space at the bottom of the kiln, and the hot gases ascending through the mass of limestone convert it into quicklime.

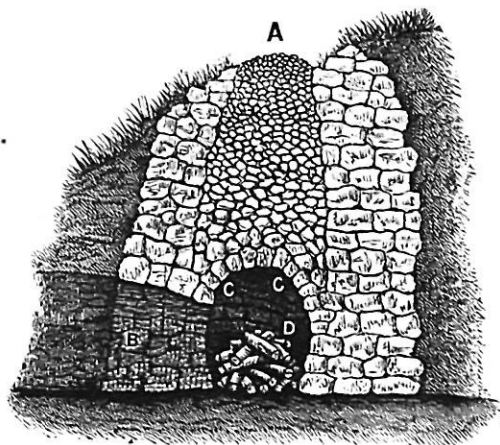

FIG. 1.—Intermittent Kiln.

The kiln has to be emptied and recharged for each batch, so that the process is intermittent. The lime thus produced is known as **flare lime**.

In its simplest form the kiln is built of the limestone itself, but kilns of this type are often constructed of brick or stone work, the inside being generally lined with fire-bricks set in fire-clay. These kilns are usually either cylindrical, with a truncated conical chimney, or they consist of two truncated cones placed base to base. The height of the kiln should be twice the largest diameter.

The raw material may be supported upon an iron grating, as in the **Deplinne & Donop's kiln**, and in some of the modern forms of this kiln producer-gas is used as fuel, in which case it is usual to employ an annular kiln, the raw material being placed in the central space so that it may attain a fairly high temperature before being charged into the surrounding kiln.

A modern form of continuous running kiln consists of a cylindrical or conical shaft with side openings at the bottom. The raw material and fuel are charged in at the top, and the lime and ash removed through the openings at the bottom. The shaft is often more or less egg-shaped.

The process is continuous, fresh supplies of raw material and fuel being added at the top as the charge sinks, and the lime and ash being removed as they are formed. Other kilns of this type are the **Dietzsch kiln** (see p. 104), and a modified form of the **Aalborg** or **Schofer kiln** (see p. 105).

Vertical kilns with separate feed are used to a large extent, especially on the Continent and in America.

The **keystone lime-kiln** shown consists of a steel cylinder lined with fire-brick and resting on a heavy steel base. Beneath the cylinder is an inverted, truncated steel cone called the **cooling**

**cone.** The furnaces are carried on steel platforms which extend beyond the firing doors in order to give sufficient room for working. The cylinder is charged with the raw material and the flames from the furnaces are directed on to the stone through two large openings lined with fire-brick in the walls. After passing through the burning zone the lime falls into the cooling cone, from which it is withdrawn by means of draw-gates in the bottom. The heated air around the cooling cone passes into the ashpit under the grates, thus adding to the efficiency of the furnace, and sometimes a steam jet is placed in the hot air passage in order to provide forced draught. The **Rüdersdorf kiln** shown in section in Fig. 2 is a well-known kiln of this class. It is polygonal in plan and consists of a central shaft about 40 ft. high, to which the fire chambers are connected by means of arched openings. This central shaft is about 10 ft. in diameter at the widest part, just above the fire chambers, and tapers off above and below; at the top, where the raw material is added, it has a diameter of about 7 ft. Many modifications of this kiln are in use, **Rumford's kiln** being one of

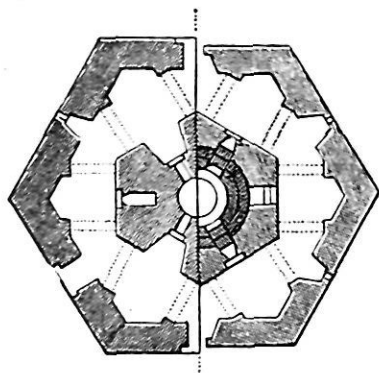
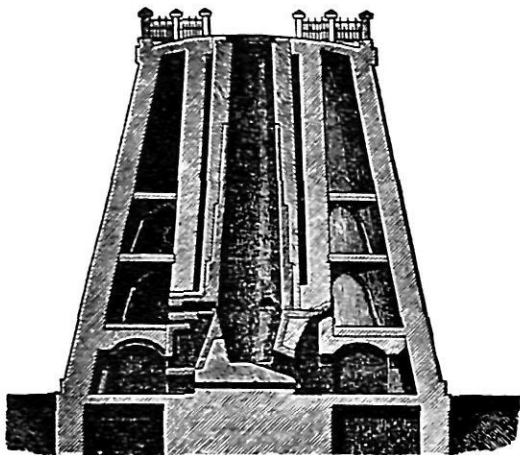

FIG. 2.—Rüdersdorf Kiln.

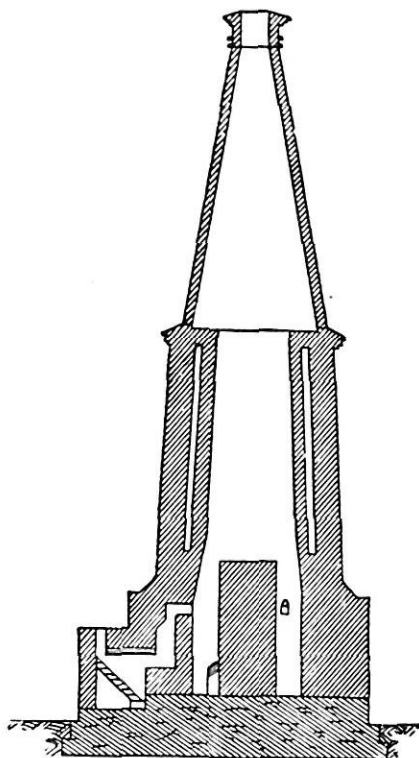

FIG. 3.—Fahnehgelm Kiln.

the best known. In the most recent type of this kiln, such as the **Fahnehgelm kiln** shown in section in Fig. 3, generators for producer-gas take the place of the fireplace in the older form, and the shaft is provided with a conical chimney. Another gas-heated kiln of this type is **Schmatolla's kiln**, which is shown in Fig. 4. It is a common practice in many parts of Europe to burn bricks and lime in the same kiln.

The **Hoffman ring kiln** (see pp. 217 *et seq.*) may be regarded as forming a connecting link between the intermediate and continuous types of kilns; because although it is continuous as a whole, each of the chambers into which it is divided acts as an intermittent kiln.

**Rotary kilns** similar to those used for the manufacture of Portland cement (see p. 99), but worked at a lower temperature, are also employed for burning lime. They cannot be used where the lime is required to be in large lumps.

During recent years a considerable amount of attention has been given to the production of a stable hydrated lime, several products of this nature having been on the market for some time. In some cases the lime is simply sprinkled with water and then ground, but in the more modern methods comparatively elaborate

processes of complete saturation with water followed by air separation are employed.

The **Kritzer hydrator** is used for this purpose in some modern plants. This consists of six cylinders connected to a chimney which is water jacketed for 30 ft. so that the water becomes heated to about 110° F. by the hot gases. The burnt lime is fed into the cylinders, each of which is provided with a screw which conveys the material along in the opposite direction to the gases, and is discharged in the hydrated state. It is finally screened and air separated. It is claimed that by using this process the plasticity of the lime particles is not interfered with, and there is no risk of crystallisation due to excessive heat.

Relatively pure limes, which slake rapidly with a considerable evolution of heat, and yield a large volume of powder, are called **fat** or **rich** limes, whilst those which slake slowly and with little evolution of heat, yielding a comparatively small volume of powder, are called **lean** or **poor** limes.

These poor limes do not "set" under water, and must therefore not be confounded with the hydraulic limes which also slake slowly and with little change of volume, but which sooner or later set under water. The poor limes either contain too little clayey matter to form hydraulic limes, and too little calcium lime to make a good caustic lime, or they are "overburnt" or "deadburnt." A good sample of common lime should contain from 85-90 per cent. of calcium oxide. The following are some typical analyses:—

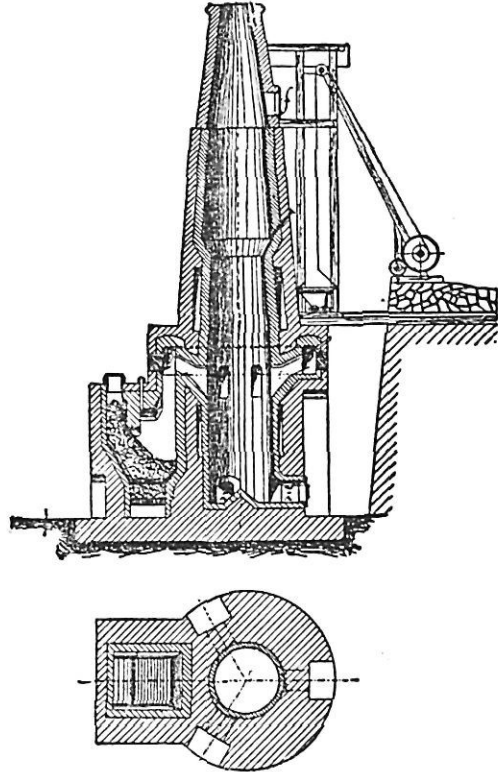

FIG. 4.—Schmatolla's Kiln.

	Buxton Lime.	Building Lime.	Blue Lias Lime.	Dolomitic Lime.
Lime (CaO) - - - -	98.72	51.10	63.43	46.72
Insoluble residue - - -	} 0.71	13.20	2.39	} 2.94
Combined silica (SiO <sub>2</sub> ) - - -		10.34	14.17	
Magnesia (MgO) - - -	0.46	1.04	1.54	32.60
Alumina (Al <sub>2</sub> O <sub>3</sub> ) - - -	} 0.11	1.64	6.79	} 1.90
Ferric oxide (Fe <sub>2</sub> O <sub>3</sub> ) - - -			2.34	
Sulphuric anhydride (SO <sub>3</sub> ) - - -	...	0.21	1.63	0.92
Carbonic anhydride (CO <sub>2</sub> ) - - -	...	8.00	3.64	3.27
Water (H <sub>2</sub> O) - - - -	...	} 14.47	2.69	} 11.65
Alkalis loss - - - -	...		1.38	
	100.00	100.00	100.00	...

For building purposes lime is made into mortar (see p. 117). In addition to this use, however, it is employed for softening water, as a dehydrant, in the defecation of sugar, and in all chemical industries where a cheap base is required.

<sup>1</sup> *Cement and Engineering News*, 1913. 25, 371.

## HYDRAULIC LIME

Limes containing from about 15-30 per cent. of clayey matter (aluminium silicate) are called **hydraulic limes**, those containing over 20 per cent. being known as **eminently hydraulic**.

When treated with water these limes slake slowly and the increase in volume is small. When a paste made from such a lime is immersed in water it sets after a few days and then slowly hardens to a stony consistency. It is because of this property of setting under water that these limes are known as hydraulic. If the amount of clayey matter is only about 8-14 per cent. the lime is termed **moderately hydraulic**; such limes slake rather more readily than the true hydraulic limes, and with a greater evolution of heat and a greater increase in volume; when made into a paste they set under water after two or three weeks, but never become very hard.

These hydraulic limes owe their peculiar properties to the formation of calcium silicates, aluminates and perhaps aluminosilicates during calcination. It is necessary that the silica in the raw materials should be in a state of combination, preferably with alumina, because free silica, such as quartz and sand, does not combine with lime at the comparatively low temperature of the kiln.

A pure lime may be converted into a hydraulic lime by adding suitable substances containing naturally or artificially roasted silicates. Thus such materials as burnt clay, roasted shales and brick dust may be used for this purpose, but the most important substances employed for the purpose are naturally occurring siliceous materials of volcanic origin, such as **puzziolana**, **trass**, and **Santorin earth**. **Puzziolana** is a volcanic tufa found in various parts of Italy, including Puzzuoli, near Naples, from which it derives its name. The colour varies from white to nearly black, and the composition is also very variable. Part of the silica is capable of readily combining with lime in the presence of water, forming a durable silicate. **Trass** is a similar material which is found in the Eifel district, on the west bank of the Rhine. It is largely used in Holland. **Santorin earth** is also a volcanic ash which occurs in the island of Santorin, in the Greek Archipelago. It contains a larger proportion of silica than puzzuolana or trass.

Hydraulic limes are prepared in the same manner as common lime, but limestones containing siliceous and clayey matter are used for the raw material. Care must be exercised in the choice of kiln employed, because such clayey limestones readily become partly fused and spoilt. The temperature must therefore be carefully regulated, and the kiln must be one which will permit of this regulation.

**Chaux de Theil**.—This eminently hydraulic lime has been very largely used by French engineers, especially for marine work, such as the harbours of Port Said and Suez.

It contains about 62-65 per cent. of calcium oxide, 15-22 per cent. of silica, 2.5 per cent. of alumina, 1.5 per cent. of magnesia, and small quantities of iron oxide, alkalis, etc.

**Grappier Cements or Ciment Grapier**.—In France hydraulic limes are slaked at the lime works and then passed through sieves. The hard lumps (*grapier*) which are left on the sieve consist partly of still unchanged limestone and partly of calcium silicates, and perhaps aluminosilicates. They are collected and finely ground, the resulting cement being known as **ciment grapier** in France and as **grappier cements** in England.

The composition and quality of these cements are very variable, for they depend upon the proportion in which the two kinds of material exist in the original lumps, the calcium carbonate being valueless as a cementing material. **La farge cement** is one of the best of these cements. The following analysis of a grappier cement is due to **Le Chatelier**.

## ANALYSIS OF A SAMPLE OF GRAPPIER CEMENT. (Le Chatelier.)

SiO <sub>2</sub>	-	-	-	-	-	26.5
Al <sub>2</sub> O <sub>3</sub>	-	-	-	-	-	2.5
Fe <sub>2</sub> O <sub>3</sub>	-	-	-	-	-	1.5
CaO	-	-	-	-	-	63.0
MgO	-	-	-	-	-	1.0
Alkalis	-	-	-	-	-	n.d.
SO <sub>3</sub>	-	-	-	-	-	0.5
CO <sub>2</sub> and H <sub>2</sub> O	-	-	-	-	-	5.0
						100.0

**Scott's Selenitic Cement (Scott's Cement).**—This cement is prepared from feebly hydraulic limes by the addition of plaster of Paris or sulphuric acid by adding 5 per cent. of ground plaster of Paris to the lime, and finely grinding the mixture.

Sulphates have no effect upon pure lime; eminently hydraulic limes, however, are considerably improved by this treatment, though the feebly hydraulic limes are the best to employ for the preparation of selenitic cement. According to Schott's<sup>1</sup> theory the gypsum in solution is deposited upon the lime particles, thus retarding the access of water to the lime, so that the hydration of the latter takes place much more slowly than it would otherwise do, and with but little evolution of heat or increase of volume.

Selenitic cement, when prepared according to Scott's process, has a warm buff colour, sets rapidly, and soon becomes hard. Although it is an improvement upon ordinary hydraulic lime, its use has not become general because it is unsuitable for work which is exposed to the weather, and especially to the action of salt water, and also because of the superior qualities of Portland cement.

## PUZZUOLANIC AND SLAG CEMENTS

**Puzzuolanic cements** are prepared by mixing slaked lime with certain natural or artificial burnt siliceous materials, and finely grinding the mixture. They are not burned at any stage of the process of manufacture, and are simply mechanical mixtures.

The ancient Roman cements belonged to this class, but the modern so-called Roman cement (see p. 85) is of quite a different character.

The most important naturally occurring siliceous substances used for this purpose are volcanic ashes, such as **puzzuolana**, **trass**, and **Santorin earth** (see p. 82). Many artificial materials, such as **burnt clay**, may be used instead of these natural substances, but by far the most important of these materials is **blast furnace slag**, and **slag cement** is therefore the most important cement of this class at the present time.

The slags used for the purpose of making cement are fusible silicates and aluminate, and perhaps aluminosilicates, formed by the combination of the fluxing materials with the gangue of the ore during iron smelting operations. The composition varies considerably so that all slags will not serve for the manufacture of slag cement, but only those of certain types can be employed for the purpose. Slaked lime may or may not be mixed with the ground slag, the former being the older practice.

In order to manufacture slag cement by the old method the slag must be granulated and dried, then mixed with the slaked lime and the mixture finely ground.

**Granulating the Slag.**—This is usually carried out by allowing the molten slag as it issues from the furnace to fall into a rapidly running stream of cold water, by which means it is broken up into fine particles known as **slag sand** and rendered hydraulic, and a part of the sulphur is removed as sulphuretted hydrogen.

This sudden cooling of the slag is necessary because if the latter were allowed to cool slowly and then ground to powder by mechanical means, it would not possess such high hydraulic properties as when suddenly chilled in water.

**Drying the Slag.**—The wet granulated slag must be thoroughly dried before grinding or mixing with the lime. Various forms of drier are in use for this purpose.

The **Ruggles-Coles** drier shown in Fig. 5 consists of two concentric steel cylinders capable of revolving about their slightly inclined common axis. The cylinders are connected at the middle by means of cast-iron arms, and at each end by means of adjustable arms. The inner cylinder projects beyond the outer at the upper end, and passes into a stationary air chamber which is connected to the hot air flue of the furnace. The lower end of the cylinder is also connected,

<sup>1</sup> Schott, *Dingler's Polytechnische Journal*, 1873, 159, 30.



by means of an opening in the bottom, to a second stationary air chamber, which is provided with a damper in order to regulate the temperature. The hot gases are drawn by means of an exhaust fan through the inner cylinder, then back through the annular space between the two cylinders, and finally through a flue leading to the exhaust fan, the direction of the current being shown in the figure by means of arrows. The wet granulated slag is charged through a shoot into the space between the cylinders, and as the latter revolves, it is carried around by means of scoops attached to the inner surface of the outer cylinder, and to the outer surface of the inner cylinder, and is dropped from the surface of one cylinder to that of the other, the process being repeated over and over again as the material gradually descends to the lower end of the drier when it is discharged dry. The Holst drier consists of a cylinder in which a helical screw revolves on a hollow central shaft. The slag is automatically fed into the cylinder, and is slowly carried along by means of the revolving screw. The drier is heated by means of a fireplace beneath one end, and the hot gases pass under the cylinder to the other end, and then through the hollow shaft of the screw in the opposite direction to the slag to the stack. Similar driers are shown under *Manures*, p. 35.

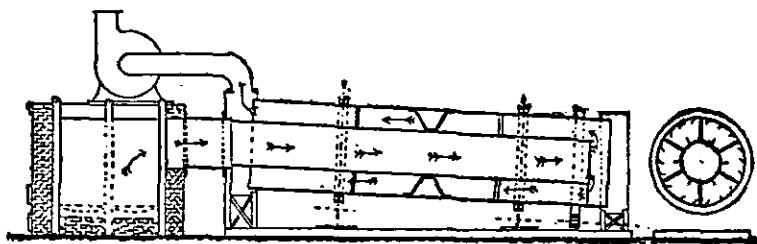

FIG. 5.—Ruggles-Coles Drier.

**Mixing and Grinding.**—The granulated and dried slag is now mixed with carefully slaked lime, the proportions taken depending upon the composition of the slag. The lime used is generally common lime, but hydraulic limes are employed at some American, French, and German works. The lime must be slaked and sieved before mixing with the slag, and all material which fails to pass through the sieve should be rejected.

In some works these lumps have been ground and resieved, but this is bad practice, because they either consist of inert matter which can only be considered as an adulteration, or of unslaked lime, in which case they are actually harmful.

The mixture is then ground to an impalpable powder. The usual practice is to pass the mixture of dried granulated slag and slaked lime into the mixer, from which it is conveyed to the tube mills (p. 94) to be ground.

At Vitry, in France, the slag is granulated by impinging a jet of water against the molten slag as it issues from the furnace. The granulated slag is then dried and sieved, after which it is passed through six grinding mills of different types and again sieved, and is finally mixed and ground with the slacked lime in ball mills. In *Bosse & Wolter's* method of preparing slag cement, the grinding is carried out in a closed ball mill, called the *Homogeniser*, of the usual construction (see p. 94). The charge, consisting of one part by weight of dry slaked lime and three parts of dry granulated slag, is passed into the drum through a hollow trunnion. The aperture is then closed, and the drum slowly rotated about its axis until the materials are thoroughly mixed and ground, when a door in the outer lining is opened, and the finished cement ejected into bags or barrels. The cement does not need any further treatment, but is then ready for market.

**Passow's slag cement**, which was patented in 1901, is prepared by blowing air into the liquid slag as it issues from the blast furnace, by which means it is granulated. The material thus obtained is finely ground. Only very basic slags can be employed for this purpose.

It is claimed by Dr Passow that the silicates are partially decomposed by this treatment, part of the dicalcium silicate ( $2\text{CaO} \cdot \text{SiO}_2$ ) being broken up in monocalcium silicate ( $\text{CaO} \cdot \text{SiO}_2$ ) and free lime, and part into free lime and silica, according to the equations—

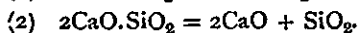
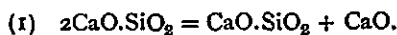

So that, according to the inventor, the resulting cement consists of a mixture of dicalcium silicate, monocalcium silicate, free lime, and free silica, the part played by the alumina being entirely overlooked.

A process of preparing cement has been devised by **Snelus**, in which the slag is calcined in a furnace after being granulated in the usual manner, by which means part of the calcium sulphide is oxidised to sulphate, and part decomposed with the evolution of sulphuretted hydrogen.

Modifications of these processes are used at the present time for the preparation of slag cements, slags from either white or grey iron being employed for the purpose. Instead of granulating the molten slag by letting it fall into water, it is often sprayed with a solution of alum or other salt, and then allowed to fall upon rapidly rotating drums, the fine globules of slag which are thrown off by centrifugal force being cooled in air. The granulated slag is then finely ground in ball and tube mills (see p. 94), a little lime and gypsum being added in order to regulate the setting. A German cement, which is composed of 70 per cent. of Portland cement (made from slag and limestone) and 30 per cent. of granulated slag, is known as **Eisen-Portland-Zement**, or **Iron Portland Cement**. Highly basic slags are employed for its manufacture.

Cements are also prepared from blast furnace slag by calcining an intimate mixture of the slag and lime to incipient fusion, and finely grinding the clinker thus produced. These cements, however, although made from slag, are true Portland cement (see p. 87), and cannot therefore be classed with the puzzuolana or slag cements.

Puzzuolana or slag cements are generally a pale bluish grey in colour, but those made from slag may sometimes be brown on account of the presence of manganese in the slag. They contain a much smaller proportion of lime than does Portland cement. The specific gravity is low, never exceeding 2.8, and the tensile strength is considerably less than that of Portland cement. These cements are slow setting, generally taking at least five hours for the final set to take place, but they attain their greatest hardness in less than a year, sometimes, indeed, within the first month.

The setting time can be hastened by the addition of puzzuolanic materials, such as burnt clay, or by adding caustic soda, potash, common salt, etc., either in the form of an aqueous solution or in the dry stage, at any stage of the process of manufacture. The latter method is due to **Whiting** (United States Patent, No. 544,706, 1895).

They stand the boiling and steaming tests very well. These cements are excellent for subaqueous work such as sea walls.

## NATURAL CEMENTS

The natural cements are obtained by burning naturally occurring clayey or argillaceous limestones, and finally grinding the burnt material, a preliminary mixing and grinding sometimes being necessary before burning.

The first of the natural cements was prepared by **James Parker** towards the end of the eighteenth century. It was known at first as **Parker's cement**, but was afterwards called **Roman cement**, by which name it is still known.

**Roman cement** is made from the septaria nodules found in the London clay off the isle of Sheppey, and at other places along the Kentish coast. Later on similar nodules were obtained from the Hampshire coast, Harwich, Yarmouth, and other places. These septaria consist of an argillaceous limestone traversed by fissures filled with calcareous spar. The composition is very variable, the nodules from Sheppey and Harwich containing about 60-70 per cent. of calcium carbonate, 18-20 per cent. of silica, 6-10 per cent. of alumina and small amounts of magnesia and iron oxide. The nodules are first calcined at a temperature below the clinkering point in conical kilns, and the clinker thus obtained is then crushed and very finely ground, when it is ready for use.

The cement clinker may be kept unchanged for a considerable time, but after it has once been ground it deteriorates rapidly in contact with moist air, and should therefore be used as soon as possible after manufacture. **Medina cement** is a variety of Roman cement which is made from a stone found in the Isle of Wight.

**Roman cement** is reddish brown in colour. The specific gravity is about 2.5-3. When mixed with water it sets very rapidly, a good neat cement taking about ten minutes to set in air, and from a quarter of an hour to an hour to set under water, but it does not become so hard and stony as Portland cement.

It is a good hydraulic cement, and, on account of its property of rapid setting, is very useful for the protection of slow-setting Portland cement concrete, etc., from the action of waves in marine work. For most purposes, however, it has been almost entirely superseded by Portland cement.

**Continental Natural Cements.**—About the same time that Parker introduced his cement in England a French military engineer named **Le Sage** prepared a similar material, which he named **plaster cement**, from the nodules found at Boulogne-sur-Mer. This cement must not be confounded with the true plaster cements which consist of calcium sulphate (see p. 113), as it was of practically the same composition as Parker's Roman cement. Similar cements have since been prepared at **Pouilly** (1829), **Vassy** (1831), and other places. These French quick-setting cements are prepared in much the same way as Roman cement, which they closely resemble. **Vassy cement** is very dark in colour on account of the large amount of iron which it contains, and is very quick setting when freshly burned.

In addition to these cements of the Roman cement type natural cements are also made in most European countries from naturally occurring argillaceous limestone rock of very variable composition. The stone is burnt without any preliminary treatment, and the resultant cement is consequently very variable in composition and quality. These cements are known as **natural Portland cements** and resemble true Portland cement both chemically and in physical properties. They are, however, of lower specific gravity (about 2.1-3.10), more quick setting and less strong.

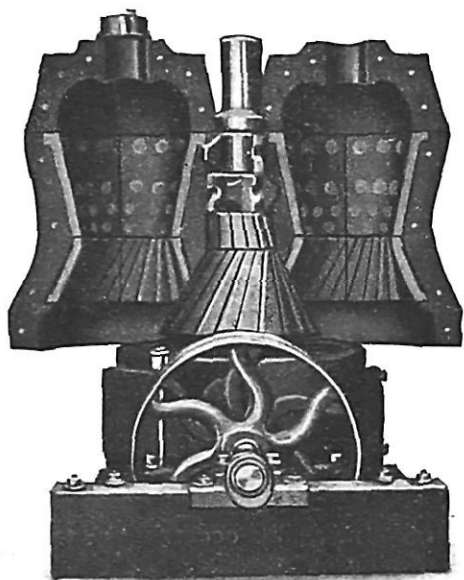

FIG. 6.—Cracker of the Coffee-Mill Type.  
A rotary fine crusher supplied by the Sturtevant Engineering Co. Ltd., London.

usually contains from 10-15 per cent. less lime than does modern Portland cement. Of the cements of the second, or trisilicate, class, the best known is **Rosendale cement**. The raw material from which this cement is made is an argillaceous magnesium limestone which extends along the Appalachian range. The stone is blasted and conveyed in trucks to the continuous draw-kilns, which are charged with alternate layers of the cement rock and small coal; a portion of the charge is withdrawn every twelve hours, and fresh layers of stone and fuel added as the charge descends the kiln. The burnt stone is carefully picked over and any underburnt lumps returned to the kiln. The properly calcined material is broken up into small pieces about the size of a hazel nut in rotary mills of the coffee-mill type, known as **crackers**, such as that shown in Fig. 6, and then ground to such a degree of fineness that about 95 per cent. will pass through a sieve containing 2,500 meshes per square inch. The cement is finally packed in paper-lined casks, when it is ready for use.

Rosendale cement contains a large amount of magnesia, whilst the silica and alumina are comparatively low. Thus, samples of this cement contain from about 15-18 per cent. of magnesia, about 18-25 per cent. of silica and about 2-4 per cent. of alumina. According to Gillmore<sup>2</sup> the average tensile strength of the neat cement is 104 lbs. per square inch after seven days, and the average crushing strength after the same period is 546 lbs. per square inch.

**Louisville cement** is made from the cement rock obtained at Louisville, in Kentucky. It is

The district of Tournai, in Belgium, is the most important centre of this industry. True Portland cement is also made from the same rock by adding the required amount of limestone, calcining to incipient fusion, and grinding the clinker thus obtained.

**American Natural Cements.**—Before the introduction of the manufacture of Portland cement these natural cements were of great importance in America, but their manufacture has to a large extent fallen off. The raw material from which they are made is a clayey limestone containing about 13-35 per cent. of clayey matter and known as **cement rock**. According to **Cummings**<sup>1</sup> the American natural cements may be divided into two classes according to whether they contain a preponderance of bisilicates or of trisilicates. Those of the first class are calcined at a higher temperature than those of the second class (which resemble Roman cement), and more or less ordinary limestone is generally added to the cement rock before calcination. The cements of the first class are known in America as **natural Portland cement**, but the term is inappropriate because the composition of Portland cement is practically the same whatever the raw materials from which it is made, so that when limestone is added in order to bring about a correct composition, a true Portland cement is obtained, and when no limestone is added the resulting cement

<sup>1</sup> Cummings, "American Cements," 1898.

<sup>2</sup> Gillmore, "Prac. Treatise on Limes, Hyd. Cements, and Mortars," 1874.

similar to Rosendale cement, but contains less magnesia, averaging about 9 or 10 per cent. of this constituent. With the exception of the temperature of calcination, the method of manufacture of all the American natural cements follows much the same course as that of the Rosendale cement.

### PORTLAND CEMENT

Portland cement was first made by **Joseph Aspdin** (Patent No. 5,022, 1824), a bricklayer of *Leeds*, who gave it the somewhat misleading name by which it is

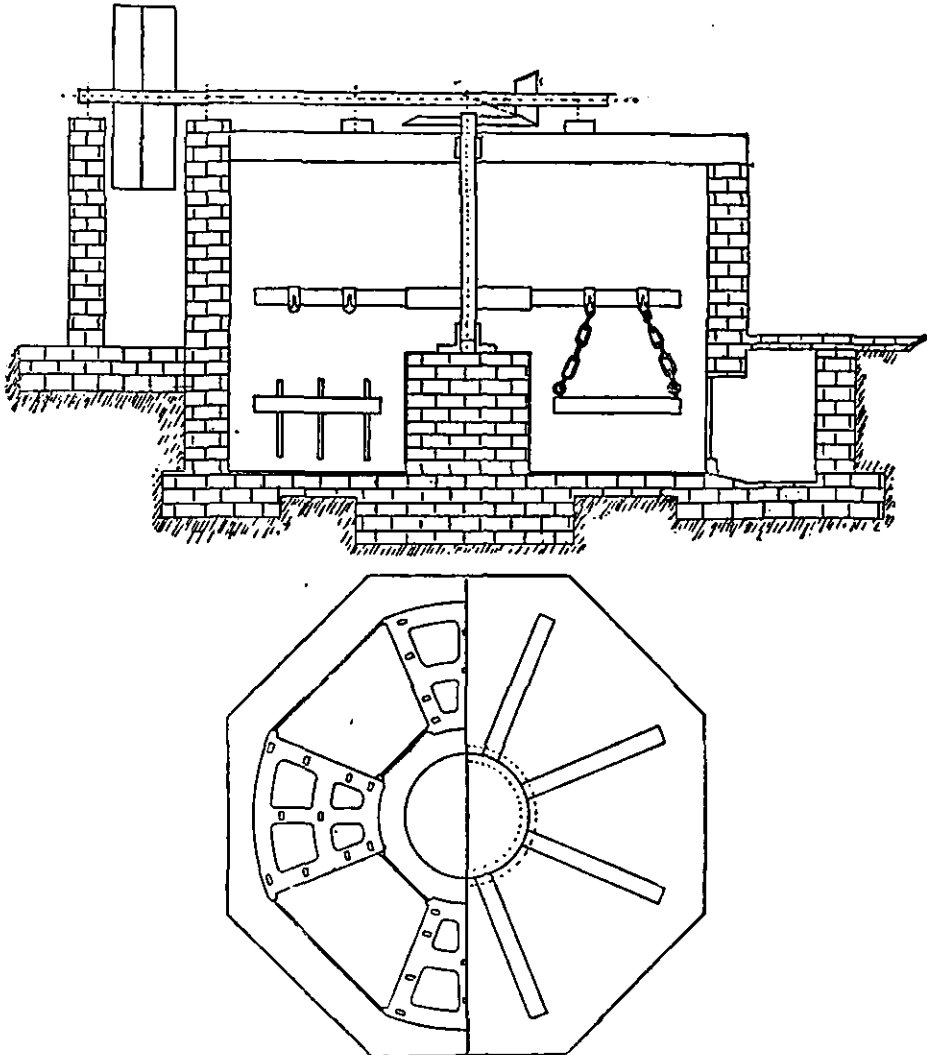

FIG. 7.—Wash Mill.

still known, probably from a fancied resemblance to Portland stone. The cement was originally prepared by lightly calcining a mixture of lime and clay, and grinding the product, and it was therefore a very different material from that made at the present time. The manufacture of this cement has been developed by a large number of investigators, and is at the present time by far the most important of the hydraulic limes and cements, its superiority over all the others, both as regards strength and durability, having led to its use becoming greatly extended. This cement is the finely pulverised product obtained by heating an intimate mixture of calcareous and argillaceous materials to incipient fusion, and grinding the resulting

clinker. There is a very wide range of raw materials available for this purpose, such as limestone, chalk, cement rock, marls, clay, shale, slate, blast furnace slag and so forth. The proportion of the materials taken must, however, be so adjusted as to yield a mixture containing about 75 per cent. of calcium carbonate and 25 per cent. of aluminium silicates and free silica.

**Mixing the Raw Materials.**—The raw materials must not only be mixed in the correct proportions, but the mixture must also be uniform and in a fine state of division. This is brought about by one of three systems known as the **wet**, **semi-wet**, and **dry** processes.

**The Wet Process.**—This is the original process, and is now almost obsolete. It is, however, still used at some works which employ soft, wet, raw materials, such

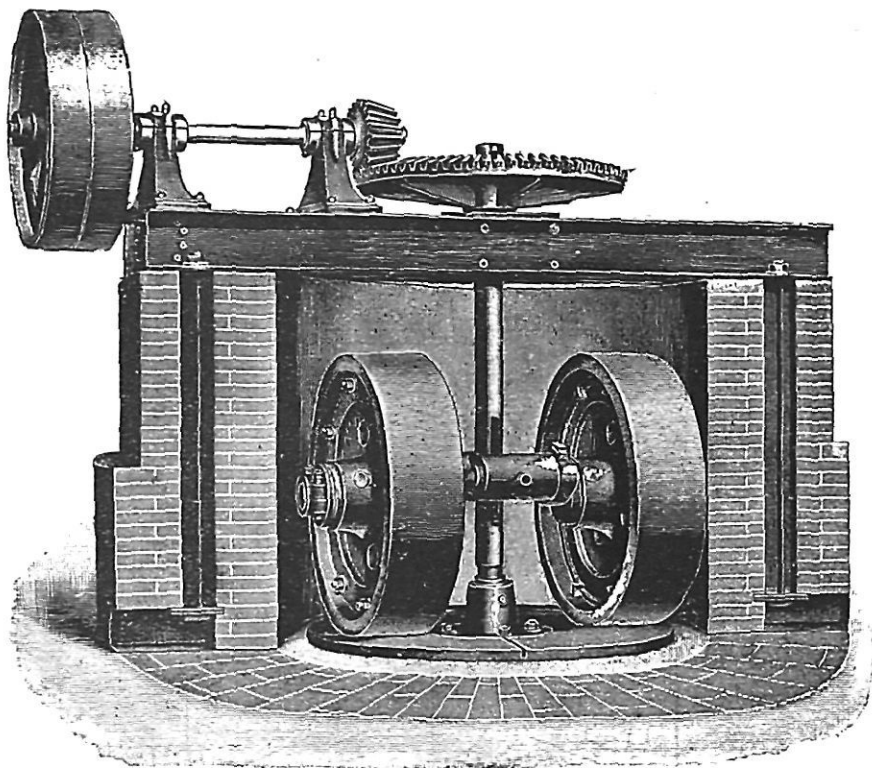

FIG. 8.—Wet Edge-Runner.

as chalk and river mud or clay. The materials, without any previous drying, are mixed in the proper proportions with a sufficient quantity of water, and reduced to a fine mud, called the **slip** or **slurry**, which contains about 80 per cent. of water.

This mixing is usually carried out in a **wash mill**.

This consists, as shown in Fig. 7, of a circular or octagonal brickwork (or concrete) tank, at the bottom of which is a short central pier supporting a vertical shaft. This shaft is rotated by means of a pair of bevel wheels, and carries radial arms from which are suspended iron or steel harrow frames, joined together by means of tie-rods, and carrying the steel tines. Finally, there are outlets fitted with gratings or sieves for the passage of the slurry at intervals around the circumference of the tank. A modern mill of this type usually has a diameter of about 15 ft., and the harrows perform twenty-four revolutions per minute. In a less common type of wash mill the harrows are held in frames which are secured to the central shaft. The raw materials are usually charged into the mill from skips or tipping waggons, and the water is run in through a pipe.

After having been churned to the correct consistency, the slurry is run off through the gratings or sieves into troughs leading to large reservoirs or **backs**, where it is

allowed to settle, a process taking some weeks. The water is got rid of partly by soaking a way through the soil, partly by an evaporation, but mainly by drawing off the clear supernatant liquid at intervals through a perforated board, known as the **peg-board**. When the slurry has become sufficiently dry it is dug out from the backs and dried ready for the kilns.

In modern practice the waste heat from the kilns is used to dry the slurry for the next charge. When the wet process is used on the Continent the slurry is left in the backs until it is stiff enough to be plugged and made into bricks, and the latter are dried in **tunnel driers** (see p. 213).

**The Semi-wet Process.**—In this process, which is also known as the **semi-dry** or **Goreham process**, the slurry only contains about 40 per cent. of water, and is therefore known as **thick slurry**; it is, however, sufficiently wet to allow of its being pumped.

This method has been in use for over a century at Meudon, near Paris, for the preparation of hydraulic lime, but was only introduced into this country by **Goreham** in 1870. In America, where the old wet process has scarcely ever been employed, this method is known as the "wet" process, the term "semi-wet" or "semi-dry" not being used in that country.

Wash mills are employed in the semi-wet process as in the original method, but the final reduction is usually carried out in mills of other types. Backs are not required, as the slurry passes at once to the kilns. Sometimes, especially when one of the raw materials is much harder than the other, a separate wash mill is employed for each ingredient, and frequently the harder substance is ground in a wet edge-runner, or more usually in a ball mill. If both materials are of a hard nature they are both submitted to this treatment.

The **wet edge-runner**, shown in Fig. 8, consists of a brickwork or concrete pit, the bottom of which is laid with thick, chilled cast-iron plates. A vertical shaft at the centre of the pit is rotated by means of bevel wheels, and carries the two runners, each of which consists of a heavy cast-iron boss, to which the chilled iron or manganese steel tyre is secured by means of bolts. The runners are carried on the pins of two cranks, so that they have independent vertical motion, thus diminishing the strain on the central shaft. The slurry is discharged through coarse grids, fixed at the circumference of the pans. **Ball mills** for wet grinding are very similar to those used for dry grinding (see p. 93). They are discussed under **Manures**, pp. 24, 25, but they are not provided with sieves.

As there is no separation of the large particles by subsidence in the semi-wet process, the slurry is not usually sufficiently ground as it comes from the wash mills to pass at once to the kilns. It is therefore conveyed by means of a **scoop wheel** or **belt elevator** to a small feeding tank, from which it passes to the wet mills, which are either mills of the ordinary flour-mill type fitted with French burr stones, or tube mills.

In the modern type of mill with stones the lower stone is the runner, and the upper stone is fixed. Sometimes rock emery is used instead of burr stone for the face, and in some cases chilled iron facings are employed. **Tube mills** (p. 93) are largely used for wet grinding on the Continent, and also in America, and their use is spreading in this country. When tube mills are used, the product has to be reground in another mill. In order to avoid the use of these finishing mills, recourse is sometimes had to various expedients. Thus, in some works, a series of wash mills is employed, and in others some form of sieve is used. In **Margett's process** the slurry escapes from the wash mill through an iron plate perforated with circular holes  $\frac{3}{8}$  in. in diameter, and is then passed through a rotating sieve. This sieve is shaped like an inverted pyramid, and contains from 400-900 meshes per square inch. As the slurry travels up the sides of the sieve the finer particles pass through the meshes and flow away to the pumps, whilst the coarser particles are driven upwards and over the outer edge of the sieve into an annular channel, from which they are returned to the wash mill. Very fine slurry is obtained by this method, and the sieve requires very little power. A more recent sifting device is **Clarke's mill**, which is shown in Fig. 9. This mill is provided with a brush fastened to a rapidly rotating iron plate. The slurry is fed into the tank at the top, after passing through a perforated plate which prevents any large pieces of material from entering the mill, and is thrown by the centrifugal action of the brushes against the periphery of the tank, where the finer portion passes out through a number of sieves into an annular trough from which it is conveyed to the mixing tank, while the coarse particles are swept away from the sieves by the revolving brush, and are discharged through an opening near the bottom of the tank back to the grinding mill. As in the case of Margett's sieve, very little power is required to drive this mill. The wash mill is not often used in America, the mixing being usually carried out in heavy edge-runners, and the fine grinding in tube mills.

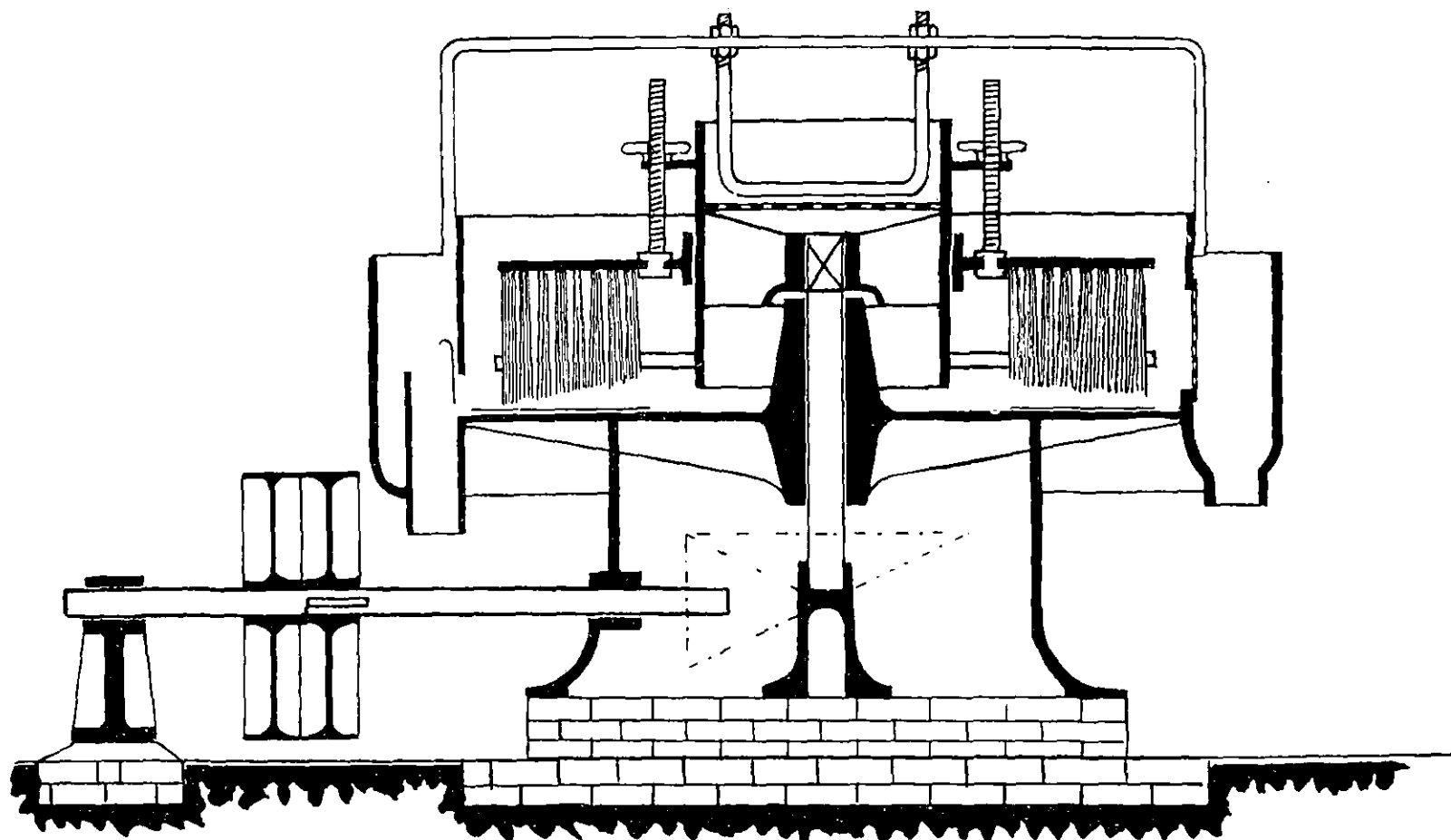

FIG. 9.—Clarke's Mill.

The finished slurry is usually run into tanks called **mixers**, where it is kept stirred, in order to keep the composition constant, until wanted. The slurry in the mixer is tested, and if the proportions are found not to be correct the required addition is made from one of two smaller tanks, one of which contains a slurry made entirely from chalk, whilst the other contains a slurry of clay.

A good type of mixer is shown in Fig. 10. This consists of a brickwork or concrete tank containing three stirrers, the arms of which rotate at different levels. Some large mixers are circular in plan, and the stirring apparatus is arranged on the sun and planet system. Compressed air has been recently introduced for stirring the slurry in the mixers. In this case the latter consist of large circular iron tanks which are funnel shaped at the bottom. Through the bottom of each tank pass

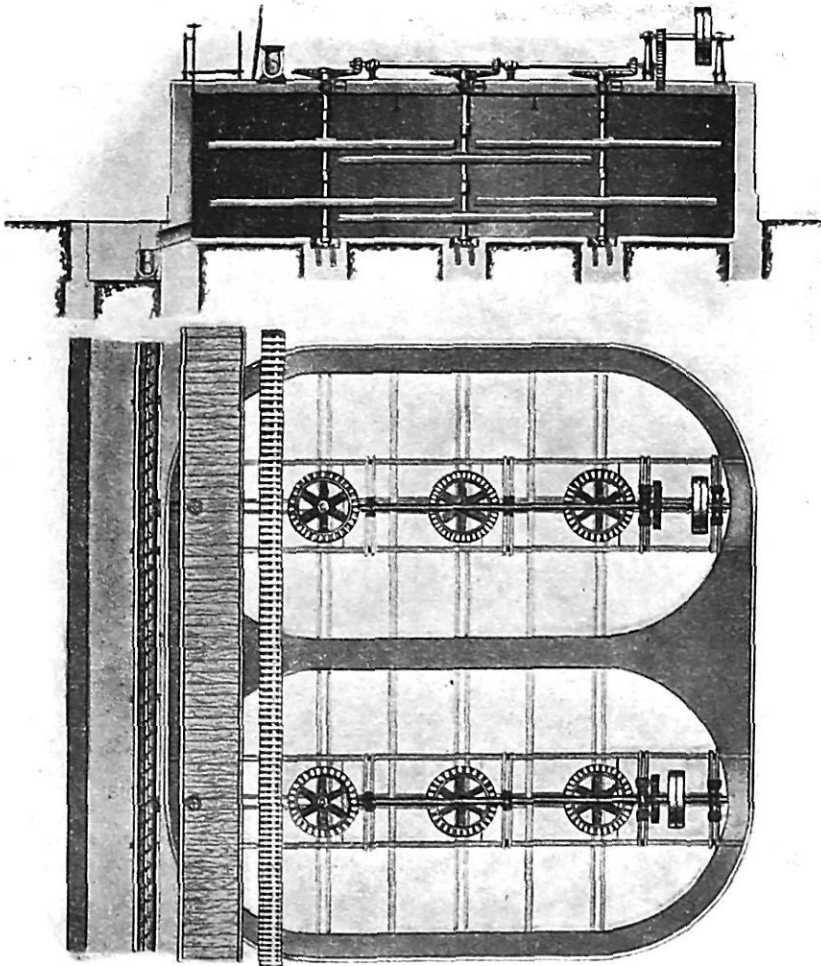

FIG. 10.—Mixer with Three Arms.

several iron pipes about  $1\frac{1}{2}$  in. in diameter, which are connected with the compressed air chamber. On admitting the compressed air the contents of the tank begin to "boil," and become very thoroughly mixed.

**Ram pumps** of the three-throw type are usually employed for pumping the fine slurry from the mixers to the kiln, or to the drying floors if it is to be formed into bricks. Sometimes, however, worm conveyers are used for this purpose, especially on the Continent.



**The Dry Process.**—This process was originated in England for the purpose of dealing with limestones and shales of the Lias formation, but its greatest development has been made abroad, and especially in America. The process is principally employed where hard materials such as limestone, shale, and slate are used, but it is also applicable to soft materials. In this process it is necessary to crush and dry the raw materials before passing them on to the mixer, as they must not contain more than 2 per cent. of water or the mills will become clogged.

**Crushing.**—Whenever possible, the crushing is carried out before drying, because this facilitates the latter process, but very wet, soft materials have to be dried first and crushed afterwards. The type of crusher used depends principally upon the character of the raw material. If the latter be hard and fairly dry it is usually crushed to about the size of a walnut, either in a machine of the **swing-jaw stonebreaker** type or in a **gyratory crusher**, whilst if it be soft and moist it is usual to employ a **rotary crusher** of the **coffee-mill** (see Fig. 6) type or else a mill with **toothed hedgehog rolls**.

The swing-jaw stonebreaker is the oldest type of crusher, and most of the forms at present in use are modifications of the **Blake's stonebreaker** shown in section in Fig. 11. In this crusher, one of the jaws A is fixed whilst the other I is hinged; both jaws are faced with grooved plates of chilled iron or manganese steel J and K<sup>1</sup> K<sup>2</sup>, and the hinged jaw is caused

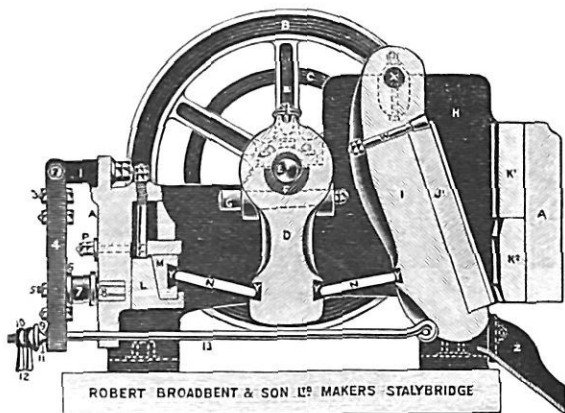

FIG. 11.—Section of Broadbent's Improved Blake Stonebreaker.

to swing backwards and forwards through a very small arc by means of a pitman D, which is alternately raised and lowered as the eccentric shaft E rotates. The size of the crushed material is regulated by railings or lowering the wedge L, and the return of the swing-jaw by the drawback motion, P, Q, R, S, T, U, V. In another design of this crusher, the **Blake-Marsden "frictionless lever" crusher**, the movable jaw is swung by means of a pitman and rocking lever. In another type of jaw crusher the movable jaw is worked by means of a lever and cam. The Wheeling Mould and Foundry Co. have recently introduced a modified swing-jaw crusher called the **Wheeling forced feed crusher**, in which a rolling motion is imparted to the jaws, thus increasing the crushing power and output. Gyratory crushers are generally used in America, but are not so popular in this country. A sectional perspective view of **Hadfield's gyratory crusher** is shown

in Fig. 12. This crusher consists of a hopper-shaped shell N, beneath which is an inverted cone A, supported on a casting which also carries the driving machinery. The crushing cone R is attached to the hollow shaft T, which is supported on the spindle I by means of the ball and socket arrangement P, 12. The crushing cone is caused to gyrate by means of a bevel wheel with an eccentric boss G. The cone mantle S and the plate O which line the shell N are made of manganese steel. The stone is fed into the hopper where it is crushed by the gyrating cone, and then drops into the inverted cone A, from which it escapes from the crusher. The size of the product can be regulated by raising or lowering the central spindle I by means of a worm and worm-wheel at the bottom of the machine. Rotary crushers or **crackers** of the coffee-mill type (see Fig. 6) are sometimes employed for crushing comparatively soft materials and also for reducing the size of the lumps of hard material as it comes from the more powerful crushers described above, but their use is not at all general in the manufacture of Portland cement. The most suitable mills for crushing soft materials are those with toothed rolls such as that shown in Fig. 13. This mill has two hedgehog rollers placed opposite one another; one of these is supported by sliding bearings in order that the distance between the rolls may be regulated. The size of the teeth used depends partly upon the character of the material to be dealt with and partly upon the size of the product.

**Drying the Raw Materials.**—At the present time **rotary driers** are almost universally employed. The simplest form of rotary drier is described under **Manures** (see p. 35).

The **Ruggles-Coles drier**, which is used to a large extent, is described on p. 84. When rotary kilns (see p. 99) are employed the waste gases from the latter are generally used to heat the

driers instead of employing a separate furnace. Taking advantage of the hot dry atmosphere, the Californian Portland Cement Co. dry their wet clay without any artificial aid. During the summer the clay is ploughed up in patches and left to dry, after which it is brought to the works by rail and stored in bins.

**Grinding.**—The crushed and dried material is next submitted to fine grinding, the usual modern practice being either to submit the material to a preliminary grinding in mills of various types, and then to finish pulverising the grit thus obtained in finishing mills, or to complete the grinding in a single operation and to pass the grit through sieves.

**Edge-Runners** (see fig. 8) are sometimes employed for preliminary reduction, the type most frequently used in the dry process having a rotating pan.

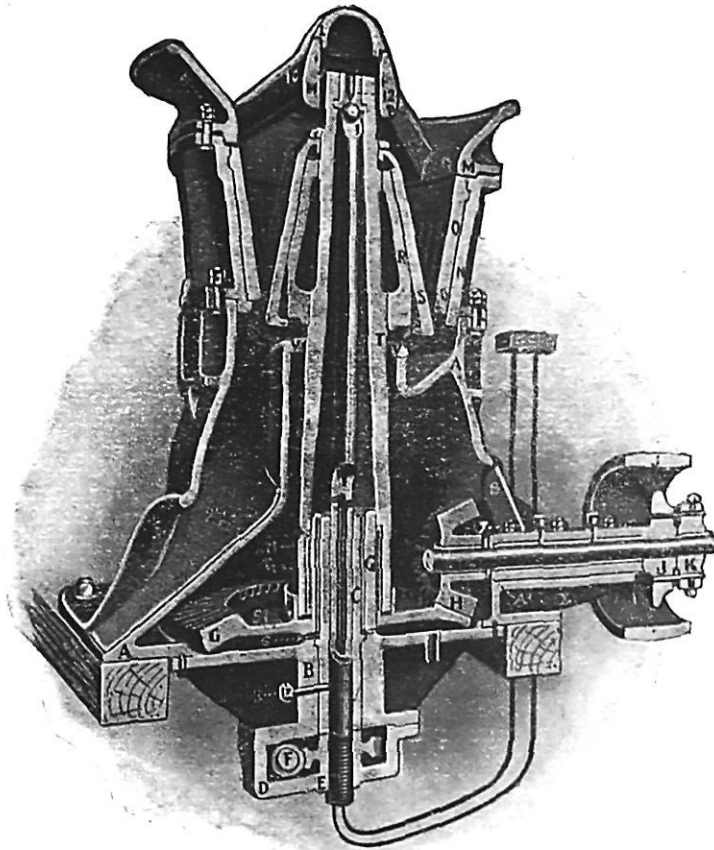

FIG. 12.—Hadfield's Gyratory Crusher.

When edge-runners are not followed by finishing mills, the ground material is passed through sieves or air separators (see p. 28), the coarser particles being returned to the mill for further reduction.

Soft lumpy material, such as clay, is sometimes submitted to a preliminary reduction in machines of quite a different type. **Bar disintegrators**, described under *Manures*, p. 26, are in use. A machine which is capable of dealing with harder materials is the **Jeffrey pulveriser** in which the material to be ground is carried around by a spider, to which the hammers are attached, and crushed against the breaking plate until it is sufficiently reduced to pass through the grating at the bottom of the machine. Sometimes a **roller mill** is employed as an intermediary grinder between the edge-runner and the finishing mill. These mills are furnished with feed rolls which deliver the material at a uniform rate to the grinding rolls.

The **ball mill** was first introduced in Germany, and was originally intended for fine grinding, for which purpose it has not proved perfectly satisfactory, as it does not produce a sufficient quantity of

very fine flour. It is, however, one of the best mills for primary reduction of the crushed material, and will probably supersede most of the other types of mill at present in use for this purpose.

Ball mills vary considerably in constructional details, but the principle has been explained on p. 24 under **Artificial Manures**, the **Abbé ball mill** being there described. The **Krupp ball mill**, shown in Fig. 14, has a circular drum composed of two wrought-iron side plates carried on a horizontal shaft. The inner circumference of the drum is built up of perforated plates of tough cast steel arranged so as to form steps. A perforated steel plate surrounds these grinding plates, forming a coarse sieve, outside which there is a fine sieve of brass or steel wire, the whole being enclosed in a sheet-iron case. The drum is charged with forged steel balls, and the material, which is fed in through a hopper at the side of the drum, is crushed by the balls which fall from step to step as the drum rotates. The ground material passes through the holes in the grinding plates on to the coarse sieve, which retains the larger particles, and allows the finer portion to pass through to the fine sieve, where the same process is repeated. The portion which succeeds in passing all the sieves then falls into the iron casing and is removed, whilst the coarser particles retained by the fine or coarse sieves are returned to the interior of the drum, where they are further reduced. The **Jenisch ball mill**, made by Messrs Jenisch & Löhner, is very similar to the foregoing, but the fine sieves form the sides of a polygon. In the **Kominor mill** the grinding

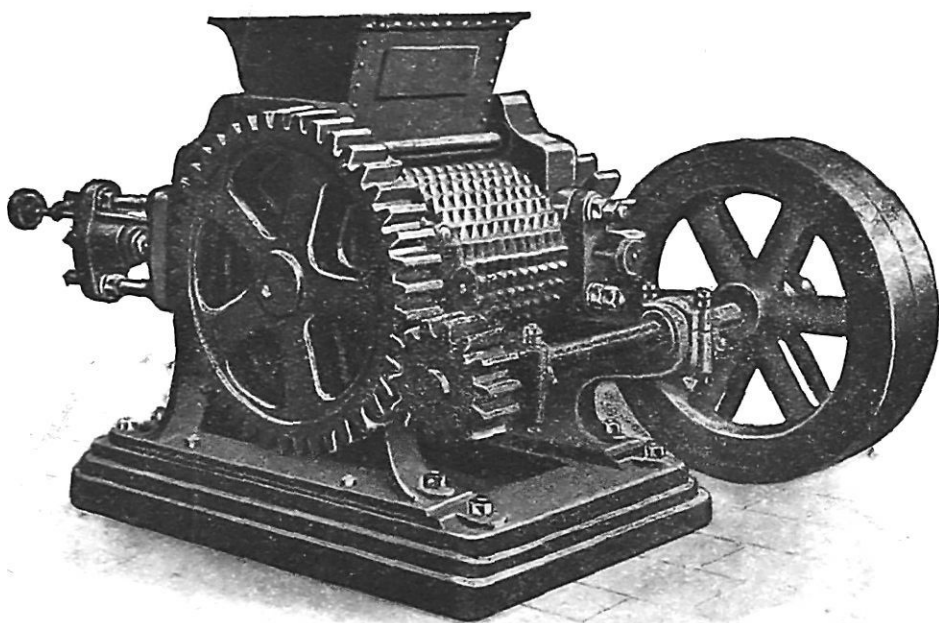

FIG. 13.—Roller Mill with Toothed Rolls.

plates are not perforated. The material is fed in through a hopper at the side, and, after traversing the drum, passes through three ports in the opposite side to the coarse and fine sieves, which form the frustum of a cone. The finer portion escapes, as in the ordinary ball mill, but the coarser particles are returned through shoots into the drum, which they have to retrace before they again reach the sieves. This mill is a considerable improvement on the ordinary ball mill because the material receives a much more thorough grinding between each sifting. One disadvantage which this mill shares with the ordinary ball mill is that it is necessary to remove the sieves and screens whenever the grinding plates have to be inspected, changed, or repaired. This difficulty is obviated in an improved form called the **Kominor Fasta mill**, in which the coarse and fine sieves are in the form of concentric cylinders. Another mill of a somewhat similar type is the **cementor**. Some ball mills, such as the **Molitor ball mill**, are made without the fine sieves. In this mill the ground material is discharged through gratings between the steps. The **Molitor ball tube mill** is a short tube mill which is lined with steel step plates in a similar manner to that of the ordinary ball mill. The material is fed into the mill through one of the trunnions, which are hollow, and discharged at the other end on to a screen surrounded by a dust casing, into which the fine portion passes, whilst the coarse particles retained by the screen are returned to the drum. Short tube mills called **crushing tube mills** or **pregrit mills** are sometimes used instead of ball mills for the preliminary reduction of the material. **Krupp's pregrit mill** is of this type. It consists of a short wrought-iron tube lined with steel plates and charged with steel balls. The material is fed in at one end and discharged at the other, through the hollow trunnions. The sieveless ball

mill may also be used for grinding raw materials, in which case the use of a coarse and fine mill is avoided.

Various kinds of centrifugal roller mills are used for grinding the raw materials. In most cases the grinding is completed in one stage, the mill thus taking the place of the combined ball and tube mills.

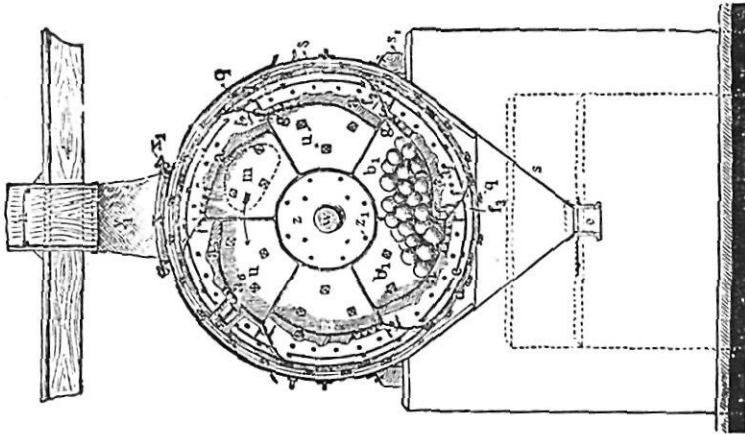
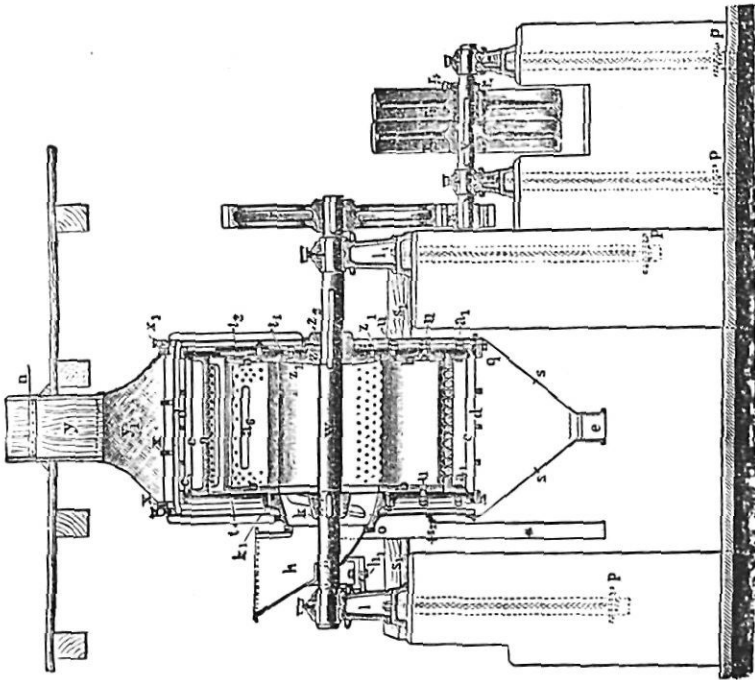

FIG. 14.—Krupp Ball Mill.



The Griffin mill, which is manufactured by the Bradley Pulverizer Co., is shown in section in Fig. 15. In this mill the roll 31 is attached to the shaft 1, suspended from the universal joint 9, which is connected to the horizontal driving pulley 17 by means of sliding bearings. The grinding chamber, in which the roll swings and rotates, consists of a base pan 24 containing a grinding ring, and a sieve frame 44 carrying a cylindrical sieve surrounded by a sheet-iron dust casing. Attached to the top of the sieve frame there is a conical shield 25 through which the shaft passes. The raw material is fed into the hopper 50 and is conveyed by means of the worm 49 into the base pan, where it is ploughed up by the shoes or ploughs attached to the bottom of the roll, and ground between the latter and the grinding ring. The finer particles are winnowed by the fans 7 and, after passing through the sieve, fall into a receptacle below, from which they

are removed by means of a worm conveyer. A larger and more powerful form of this mill is known as the **giant Griffin**. The **Bradley three-roll mill** is described on p. 26, under **Manures**.

In the **Kent mill**, the **Maxecon mill**, and the **Sturtevant ring-roller mill**, the grinding pressure is produced by means of powerful springs; the last-named mill is described under **Manures** on p. 25.

In the case of all these mills, the ground material must either be further reduced in a finishing mill or passed through a separate sifting device, and the coarser particles returned to the mill for further grinding. The **Roulette mill**, which is shown in Fig. 16, is a centrifugal roller mill of a different type, in which the rollers are replaced by balls. These balls 8 are driven by the lugs 7 of the driving disc 6 around the grinding ring, which is made in two parts 9 and 10. The material

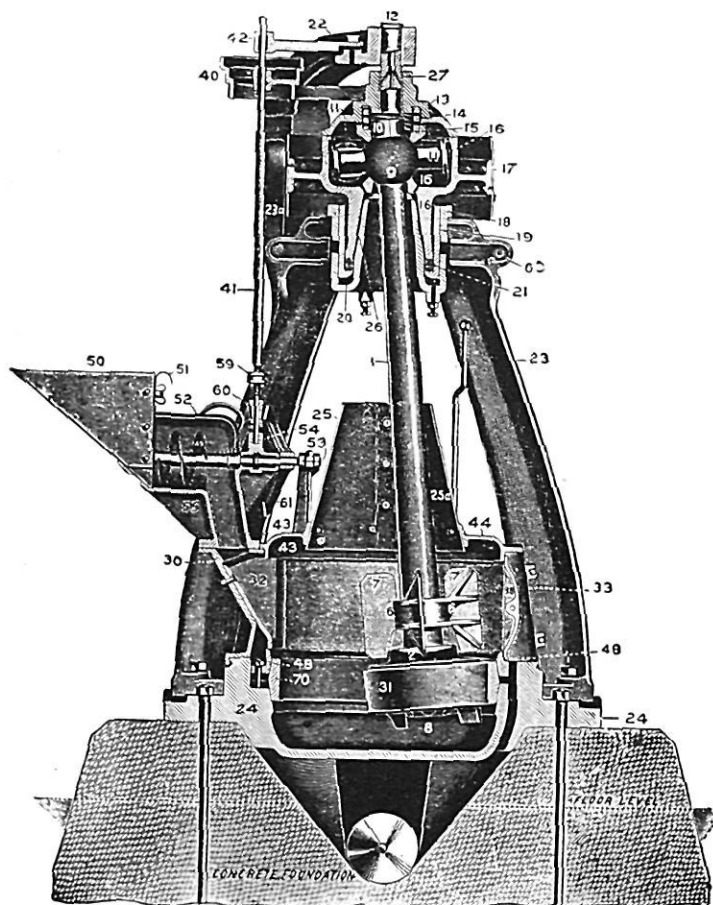

FIG. 15.—Section of Griffin Mill.

is fed by means of the automatic feed 31 through the shoot 32 into the mill and ground between the balls and the grinding ring. The spider 3, attached to the shaft 2, carries the blades 4 and 5, which form a fan and throw the ground material against the coarse sieve 11, thus separating the coarser particles. The material is then sifted by the fine sieve 12. The coarse particles retained by the sieves fall back and are reground, whilst the fine meal passes through the hollow standards into the receptacle below, and is finally removed by a worm conveyer. One of the latest mills used in the cement industry is the **Fuller Lehigh mill**. This is also a centrifugal mill in which balls are used instead of rollers. It is sometimes used for both fine and coarse grinding, but the manufacturers only recommend it for the former.

By far the most common form of finishing mill at the present time is the **tube mill**, which was introduced into the cement industry about 1895. This is described under **Manures** on p. 24. Among the types used in the cement industry may be mentioned the **Dauidsen tube mill**, **Krupp's tube mill**, and

he **Polysius tube mill**. The most usual method of rotating the cylinders of tube mills is by means of a spur wheel, but sometimes bevel gearing is used instead, and other systems, such as the **Lenix drive**, are also occasionally employed. In

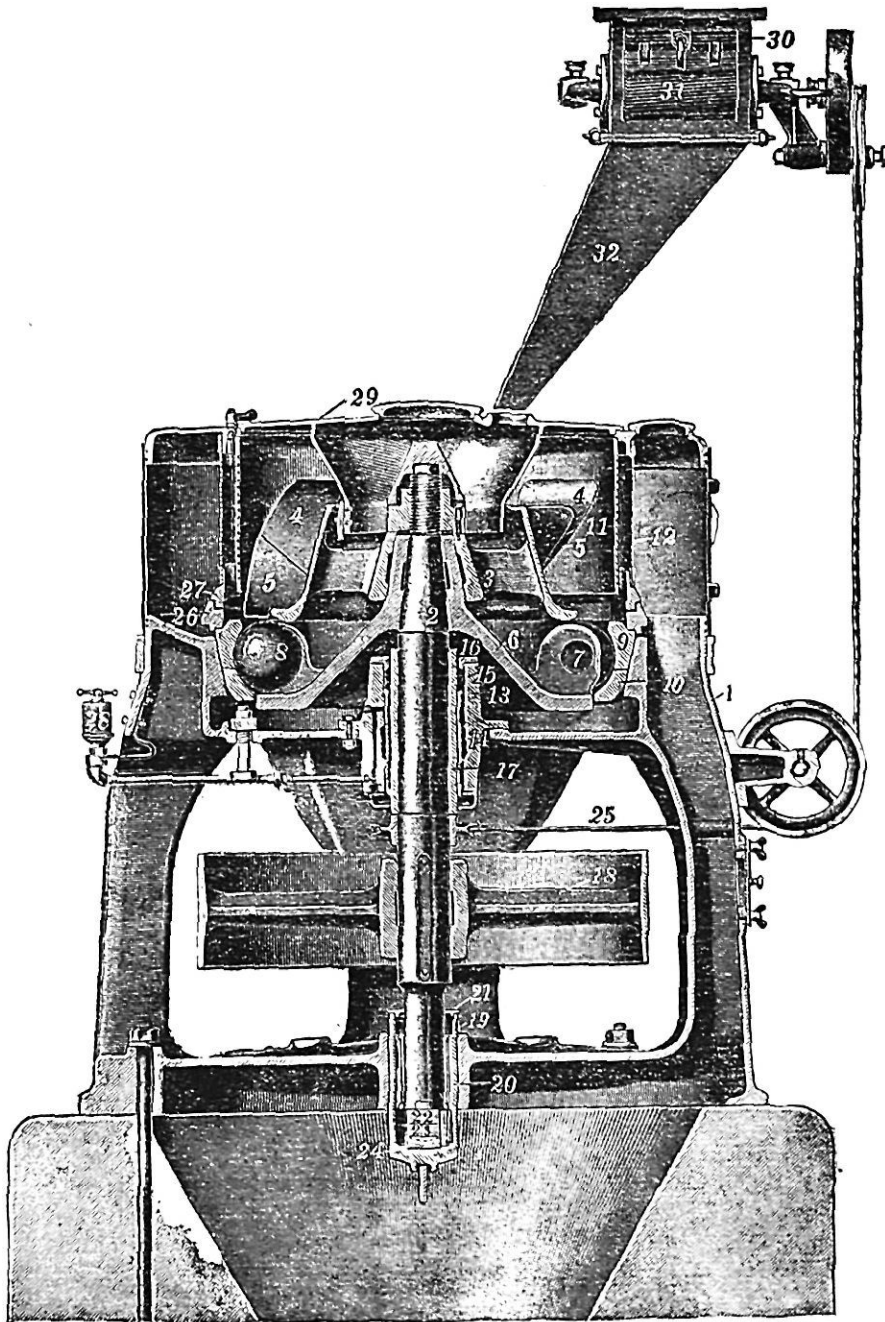

FIG. 16.—The Roulette Mill.

the Lenix drive a weighted jockey pulley causes the driving belt to pass around nearly three-quarters of the circumference of the small pulley on the driving shaft.

**Compound mills**, in which the ball mill is combined with the tube mill, are also employed.

Löhnert's compound mill is shown in Figs. 17, 18. The material, reduced to about the size of a hazel nut, is fed in through the hollow trunnion at the ball mill end, which is lined with stepped grinding plates and charged with steel balls. The coarsely ground material then passes through the ports to the coarse screen, where the larger particles are returned to be further reduced, and the remainder passes through to the cylindrical fine screen enclosed in a steel casing arranged concentrically with the drum. The portion which passes through this screen is conveyed by means of shoots to the central opening of a diaphragm placed between the two sections of the mill into the tube mill portion, where it is reduced to fine flour, and discharged through openings in the end plate into the dust casing. The tube mill portion is lined with plain steel plates, and is supported at the discharge end by means of a tyre bearing on friction rollers. The mill is rotated by means of a spur wheel attached to the end plate at the feed end. The solo mill made by Messrs Polysius is somewhat similar in principle.

In suitable cases, as when the raw materials are fairly pure and of regular composition, they are mixed in the required proportions after drying and ground

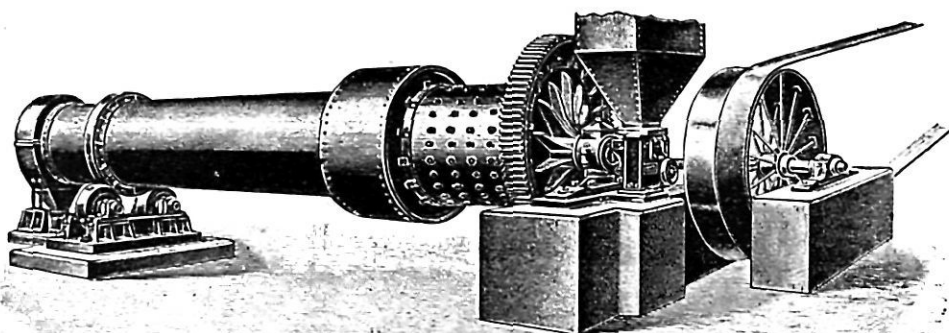

FIG. 17.—Löhnert's Compound Mill—External View.

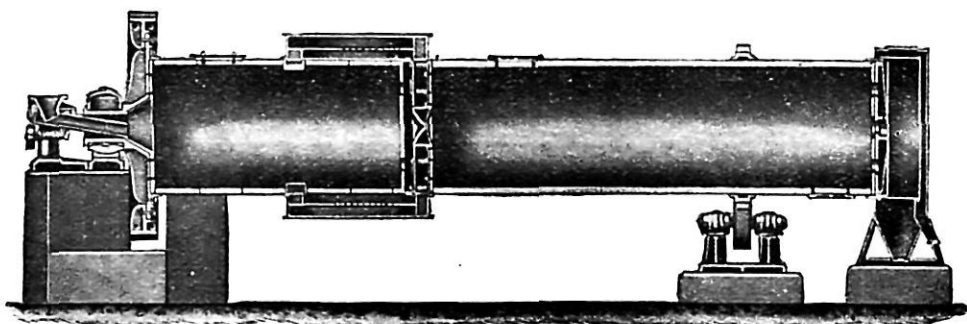

FIG. 18.—Löhnert's Compound Mill—Section.

together. In most cases, however, the materials are passed separately through the coarse grinding stage and stored in separate bins, from which they are withdrawn by means of worms, weighed in automatic weighing machines, and discharged into a conveyer which mixes and carries the mixture to the finishing mills. The finely ground material from the finishing mills is technically known as **raw flour**, **raw meal**, or **compo**. It is conveyed to the storage bins or **silos** by means of spiral or other conveyers, and is tested on its way for fineness and composition, the necessary corrections being made in the latter if required.

In order to render the composition uniform the contents of the silo are kept stirred by means of some mixing device. The silo shown in Fig. 19 consists of a shell with a hopper-shaped bottom. The material is fed into the cell by means of a worm conveyer situated at the top, distributed by means of rollers along the trough of a second spiral conveyer situated at the bottom of the silo, and then returned to the upper conveyer by means of an elevator, the process being continued over and over again

When rotary kilns (see p. 100) are employed the dry raw flour is conveyed direct to the small storage bins which supply the kilns, but where stationary kilns (see p. 103) are used the raw flour from the mixing silos is made into *briquettes*.

In one method of briquetting the flour is conveyed from the silos to a pug mill, where it is ground up into a very stiff paste containing about 18-25 per cent. of water, and as it leaves the mill the paste is cut off into short lengths by means of wires, and moulded in a plastic brick-making machine, one of which is shown in Fig. 20. The briquettes thus obtained are dried, generally by the waste heat from the kilns or in *tunnel driers*. In the latter method, which is chiefly used on the Continent, the bricks are stacked on waggons and slowly conveyed through tunnels from 100-120 ft. in length, through which a large volume of hot air is passed in the opposite direction to the waggons (see p. 213).

In another method of briquetting the flour is converted into a much drier paste containing about 8-10 per cent. of water, and this is made into bricks by stamping or pressing, in special briquette-making machines, such as those described in Vol. I., p. 22, under **Briquette Making**. Among machines used in the cement industry may be mentioned the **President Dry Press** and the **Eggette** moulding machine. The latter produces spherical blocks.

Sometimes the raw material and fuel (usually coke breeze) are mixed together and formed into briquettes. In some cases a little lime is added to the raw material in order to increase its binding power, and natural cement has also been used for this purpose in America. Sometimes a combination of the wet and dry processes is employed, a dry flour being prepared from the hard material and a wet slurry from the soft. The two materials are then mixed in the correct proportion in a pug mill and made into briquettes.

**Burning to Clinker.**—The mixed dry raw materials are now heated to the point of incipient fusion (*i.e.*, almost to white heat) in **kilns**. The modern kilns employed for this purpose vary considerably, but they may be classified under two heads, **rotary** and **stationary**

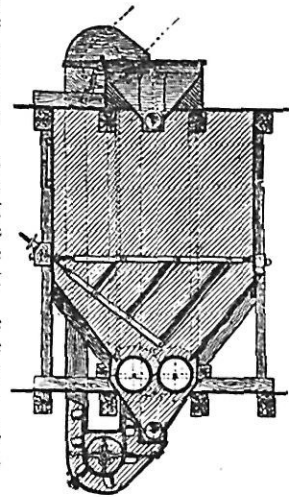

FIG. 19.—Mixing Silo

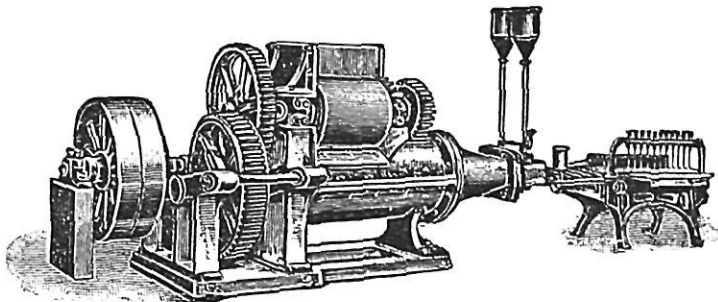

FIG. 20.—Plastic Brick-Making Machine.

or **vertical** kilns. The latter are usually of the *continuous* type, but *stationary* intermittent kilns are still used in some old works. The rotary kiln is the most popular type at the present time, and will therefore be described first.

## THE ROTARY KILN

The **rotary kiln** is the most modern form of cement kiln and also the most popular, especially in America, where it is rapidly becoming universal. It consists essentially of a steel cylinder, lined with fire-brick, which is capable of being slowly rotated about an axis slightly inclined to the horizontal. The raw material is fed in at the upper end, and the fuel and air are injected at the lower end. The burnt clinker is also discharged at the lower end. The raw material may be prepared by wet or dry methods, but the latter is usually employed when one or both of the materials is of a hard nature. It is more economical to use a longer kiln when wet



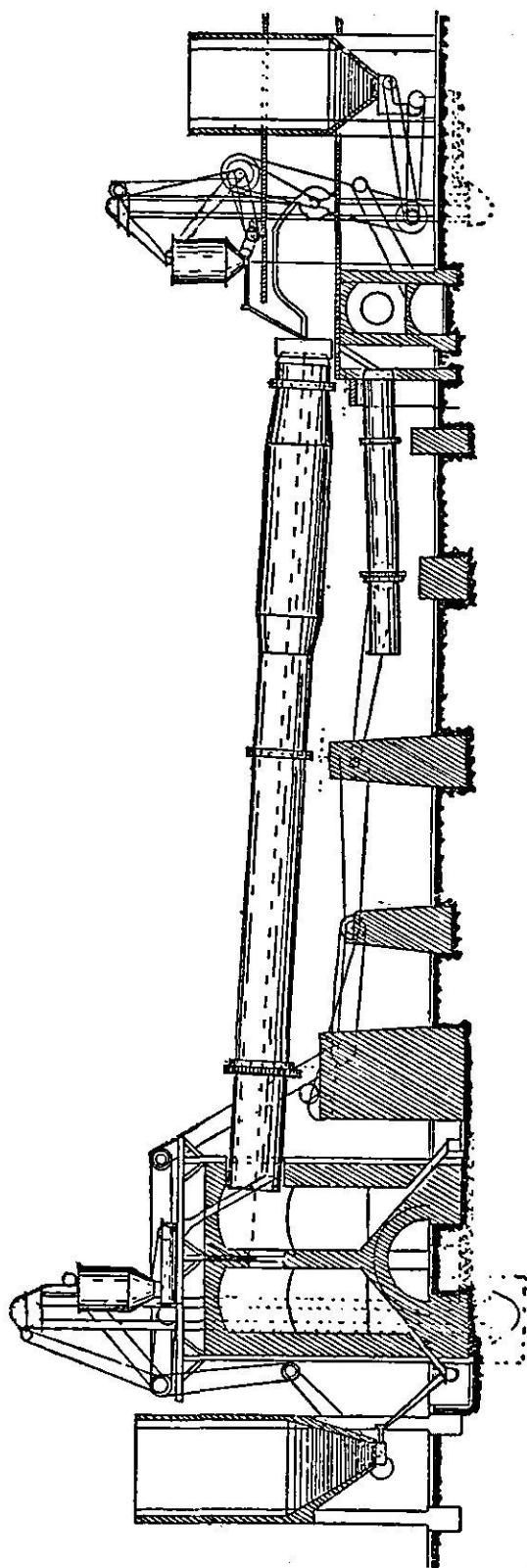

FIG. 21.—General Arrangement of Rotary Kiln Plant.

material is employed than when the latter is dry, because the waste gases can be utilised to remove some of the water.

At the present time the usual length of the cylinder is from 100-150 ft., and the diameter is from 6-8 ft., the largest in use being about 250 ft. long, and 9 ft. 9 in. in diameter. Although the cylinders usually have parallel sides, they are occasionally made tapering at the end where the kiln enters the flue, and, frequently, one portion is made of larger diameter than the rest, as shown in Fig. 21. Although this form of cylinder was first made with the simple object of utilising two short cylinders of different diameters, which would otherwise have had to be scrapped, it has been proved to give a larger output with a greater economy in fuel than the ordinary parallel-sided form, and the tendency of the clinker to adhere to the lining is also decreased.

The cylinders are usually made of steel plate riveted to butt straps and lined with a suitable material. Ordinary stock bricks may be used to line the comparatively cool upper end of the cylinder, or this portion may be left unlined, and common fire-bricks may be used for the central portion, but for the hot lower end or burning zone these will not do, as, owing to the large percentage of silica which they contain, they behave as an acid towards the basic cement clinker, with the result that the lining is soon destroyed. Bricks containing about equal proportions of alumina and silica are often used for this portion of the lining; magnesia bricks have been employed, but although of a highly basic nature, have had to be abandoned because of their tendency to crack and shrink. Bauxite bricks have also been used to a limited extent, but have been found weak and friable. A cheap and efficient lining which is often used is a concrete made with about 2 parts of hard burnt clinker, and 1-1½ parts of cement. The clinker must be, at least, small enough to pass through a sieve with a half-inch mesh. A layer of asbestos has occasionally been employed behind the fire-bricks, but the plan is of doubtful value, and has not received much favour. It is usual to spread a protective coating of the clinker itself over the lining when starting the kiln. The cylinder is carried on two or

three pairs of roller bearings, placed at a convenient distance apart. The roller bands or tyres, which are of steel, may be riveted directly to the cylinder, but, in order to allow for the expansion

of the latter, it is more usual to make them about 3 or 4 in. larger in diameter, and to attach them to the shell by means of steel bridge pieces supported on blocks. The rollers upon which the tyres bear are fastened to sole plates. It was formerly usual to employ two pairs of rollers to support each tyre, but the modern plan is to use two single rollers (see Fig. 22).

The kiln is rotated by means of a split toothed wheel, which is usually attached to the cylinder in the same manner as the roller bands, or sometimes by means of tangential steel strips. The toothed wheel is actuated by a worm-wheel driven by means of a suitable reduction gearing. The speed of rotation depends partly upon the slope of the kiln—which may vary between  $3\frac{1}{2}$  and 7 per cent.—partly upon the nature of the raw materials, and partly upon the thermal conditions inside the kiln; it usually varies between 20 and 60 revolutions per hour. In order to enable the feed, etc., to be under proper control, it is the common practice to employ some means of regulating the

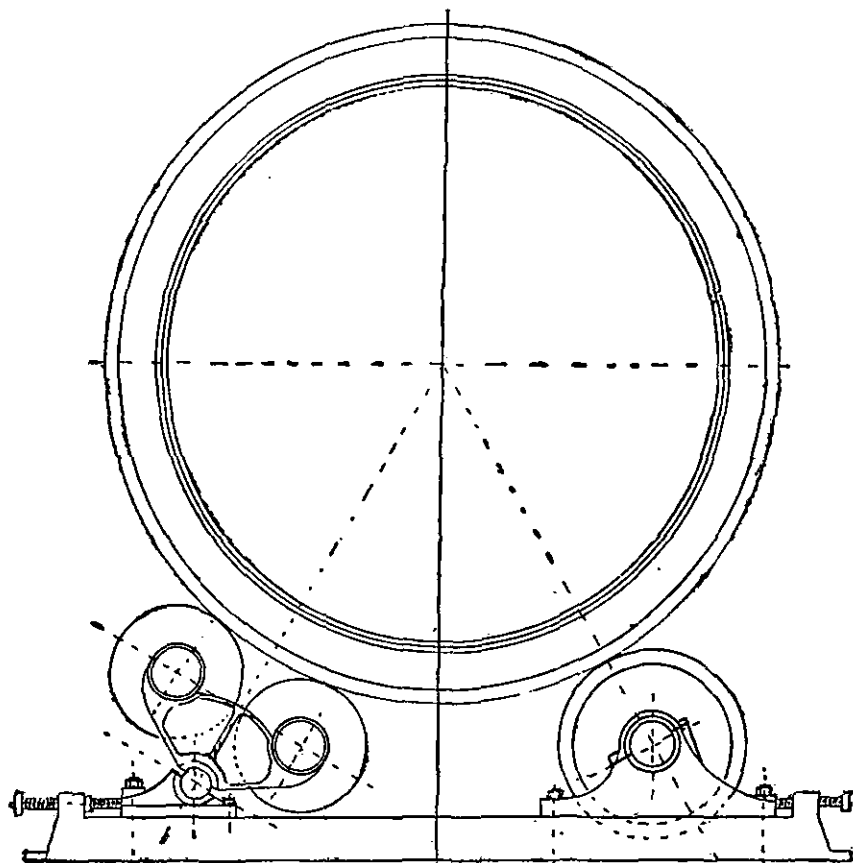

FIG. 22.—Forms of Bearing for Rotary Kiln.

speed at which the kilns are driven. This may be done by means of separate motors provided with controllers for each kiln, but it is more usual to employ a three-speed gear, or to have pulleys of different diameters on the driving shaft.

At the upper end the cylinder terminates in a flue leading to a chimney. As the kiln gases are heavily laden with dust, it is necessary to pass them through some form of dust chamber in order to collect the dust before they reach the chimney. This dust collector usually consists of two chambers separated by means of a wall, in the bottom of which are openings. The gases are caused to pass downwards in the first chamber and through the openings into the second chamber, from which they pass to the flue leading to the chimney. The dust may be removed from the chamber either continuously or periodically.

The apparatus for the introduction of the raw material into the kiln is placed above the dust chamber. When the material is prepared by the semi-wet process the slurry is pumped from the mixers into a large storage tank, from which it passes into a small receiver, and hence along the feed-shoot into the kilns. In some cases, however, the large tank is dispensed with. But when the material is

prepared by the dry process, the flour may be fed in from the storage tanks by means of a worm conveyer in a water-jacketed case, as in the usual American practice, or it may be fed by means of a worm into a trough, along which it is carried by means of knives or arms attached to a rotating shaft. As the material travels along it is wetted by means of a perforated pipe placed over the trough, and finally falls in small lumps into a shoot leading into the kiln.

At the lower end of the cylinder is the **kiln hood**, which in modern plants is usually mounted on wheels, so that it can be run back when required, thus giving easy access to the interior of the kiln.

The hood is usually made of steel plate lined with fire-brick, and is provided with a door, two or three sight holes, and the burning attachments.

The **fuel** used in modern practice is almost always fine bituminous coal dust, though natural gas, producer-gas, and petroleum are used to some extent. The coal must be thoroughly dried and very finely ground so that it only leaves a residue of about 15 per cent. on a sieve containing 180 meshes to the linear inch.

As this finely divided coal is very explosive, great care has to be taken in handling it, and it cannot be stored, but must be used as soon as it has been ground. When an initial crushing is required before drying this is usually carried out in hedgehog rolls (see p. 94), but sometimes the swing-jaw crusher (see p. 92) or crackers of the coffee-mill type (see p. 86) are employed. The coarsely powdered coal is then dried in a drier, which is generally an inclined rotating drum similar

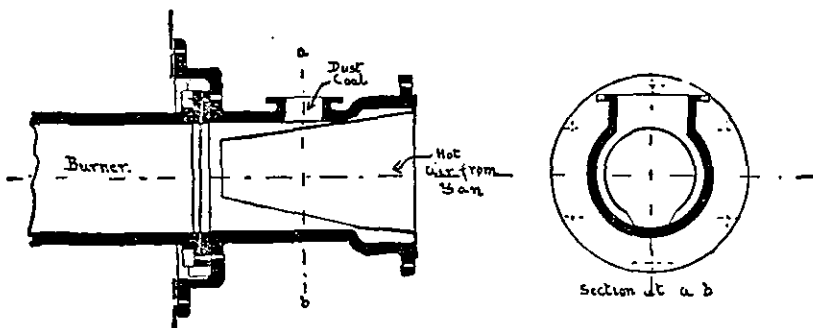

FIG. 23.—Coal Dust Burner Attachment.

to that described on p. 84; it may be heated by means of the hot air from the clinker coolers, or by a separate furnace. The dry coal is then ground in mills in the same manner as the raw materials in the dry process (see pp. 92 *et seq.*) the most usual mills employed for the purpose being the Griffin mill (see p. 96) and the ball and tube mills (see pp. 24, 96).

The powdered coal is conveyed to hoppers placed over the lower end of the kiln, from which it is fed by means of a variable speed gear into the hot air tube. In most modern plants the coal dust falls through a shoot to the hot air pipe at a zone near the kiln hood. The hot air blast is usually obtained by means of a fan. The main object of this air blast is to disperse the coal dust and cause its rapid ignition, the greater portion of the air required for the combustion being conveyed into the kiln through the coolers by way of the clinker discharge shoot. When the kiln is started the coal dust is ignited, and the temperature of the lower end of the cylinder is raised to white heat. As the raw material gradually descends the kiln it first gives up any water which may be present; when about half-way down it evolves carbon dioxide, then becomes heated to the clinkering temperature and forms into little balls, when it reaches the lower third of the kiln, and is finally discharged through a shoot at the lower end into the **cooler**.

In most European plants the cooler is an inclined rotating cylinder about 30-50 ft. in length, and 4-5 ft. in diameter, the interior of which is provided with a number of channel irons. As the cylinder rotates, the clinker is continually lifted up by these irons and caused to fall, thus being exposed to the current of air which passes through the cooler on its way to the kiln. The cooler thus serves the double purpose of cooling the clinker and heating the air supply of the kiln. The cooling cylinders are supported and rotated in a similar manner to the kiln. The **Smidth cooler** is horizontal, and is surrounded for half its length by a second cylinder. The hot clinker first passes through the

inner tube, and then travels backwards through the annular space between the cylinders, after which it is discharged into a hopper. Vertical coolers are very popular in America. The older forms consist of a vertical tower, the interior of which is provided with conical surfaces. The hot clinker is discharged from the kiln into a pit, from which it is raised by means of an elevator to the top of the cooler, in descending which it is spread over the conical surfaces, and thus exposed to a current of cold air supplied through branches from a central blast-pipe. The clinker may also be partially cooled by sprinkling with water as it descends into the elevator boot. The whole of the heat given up by the clinker is lost when coolers of this type are used, but a portion of the heat may be utilised in some forms of the vertical cooler, such as the Mosser cooler shown in Fig. 24. The cold air enters through the central blast-pipe, and passing through holes arranged in rings at intervals of 5 ft. along the pipe, enters the inner cylinder, where it cools the clinker. The heated air then passes through holes in the wall of this cylinder into the outer one, from which it is conveyed to the coal feed. The holes in the blast-pipe and inner cylinder are protected by shields in the manner shown in the figure. In **shaking coolers** the hot clinker from the kiln falls into an enclosed inclined tray, the bottom of which is formed by a series of steps. The tray is kept in motion by means of cams carried on a revolving shaft, and the shaking motion thus imparted to the clinker gradually spreads it over the steps and carries it to the lower end, where it is discharged. Cold air is drawn in at both ends of the tray, and, after cooling, the clinker is discharged into the hot air chamber from which the kiln is supplied.

The rotary kiln is very economical in labour, but not in fuel, as it requires from 30-35 lbs. of coal per 100 lbs. of burnt clinker. The output depends upon the size of the kiln, the process by which the raw materials are prepared, the fusibility of the raw materials, the quality of the coal, and the experience of the burner.

### STATIONARY OR VERTICAL KILNS

The old-fashioned **dome or bottle kiln** resembles the common lime-kiln, but has a conical chimney in order to increase the draught. It is quite obsolete, but there are several modifications still in use in some old works. In the **Johnson kiln** (Patent No. 1,583, 1872), which is shown in Fig. 25, there is a long horizontal arched flue connecting the kiln, which is of the bottle-shaped type, to the somewhat lofty cylindrical chimney. This flue is of the same width as the kiln, and is of sufficient length to hold enough wet slurry for the next charge.

The somewhat similar **Gibbons kiln** has two or more drying chambers which are used alternately; the hot gases pass both over and under the wet slurry, thus giving a larger heating surface. In the **Batchelor kiln** there are two arched chambers placed one above the other with flues beneath the lower tier. The hot gases from the kiln pass through the drying chambers and flues, thus drying the slurry from above and below, and are finally discharged through a chimney at the rear. In many cases one powerful shaft is made to serve several kilns. **Spackman's kiln** is designed for the use of slurry which is made into bricks. The kiln is of the ordinary form with a conical shaft, and a rectangular drying chamber is arranged alongside at a convenient level for loading. The mouth of the conical chimney is provided with a damper, which is closed when the combustion is nearly completed, whilst the dampers of the underground flues leading to a lofty

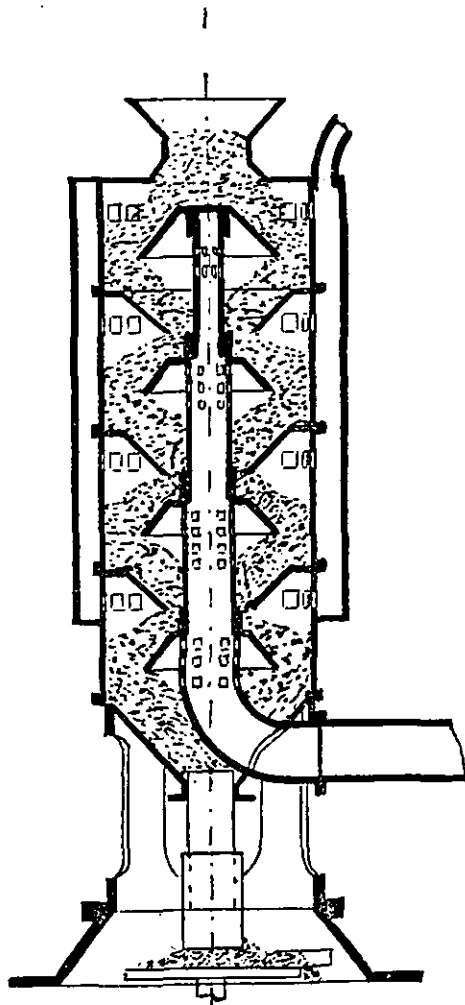

FIG. 24.—Mosser Vertical Cooler.

chimney are raised. These flues pass under the drying chamber, and the hot gases enter the latter through holes in the floor, thus drying the contained bricks, the heat of the cooling kiln being quite sufficient for this purpose.

The Hoffman ring kiln (described under Brickmaking, p. 218), was originally introduced for the burning of bricks, but it is also used for burning lime and Portland cement clinker.

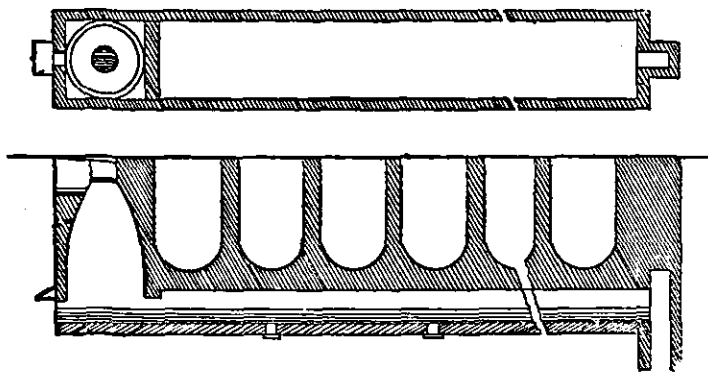

FIG. 25.—The Johnson Kiln.

This kiln is very economical in fuel, but expensive in labour. It is largely used on the Continent, but has not proved very successful in England.

Most of the continuous stationary kilns are very narrow in proportion to their

height, and are therefore known as shaft kilns; they are also known as stage kilns (*Etageofen*), because they are sometimes divided into zones or stages. These kilns are better suited to the dry process of manufacture than the wet, the raw meal being made into briquettes which are dried in separate drying floors or tunnels. They are more common on the Continent than in this country. In some of the modern forms forced or induced draught is employed, as this leads to more rapid production and greater economy. In this case the chimney need not be so high as in the older types; there is, however, more risk of over-burning and fusing the clinker.

A modern form of the Dietzsch kiln is shown in Fig. 26, which represents two kilns placed back to back, this being the usual arrangement.

The kiln consists of four zones or chambers placed one above the other and surmounted by the chimney-shaft. At the top is the pre-heating zone A, into which the dry slurry in the form of half bricks is introduced through the loading eye E, and gradually heated to redness by the hot gases as they pass from the lower part of the kiln on their way to the chimney. The pre-heating zone is inclined at its lower end towards the burning zone B, where the fuel is fed in through the doors F. The mixture of cement material and fuel is drawn down by means of rakes passed through openings in the shaft into the clinkering zone C, from which it passes into the cooling zone D, any masses which remain stuck to the walls being pushed down by means of iron tools thrust through the openings G. The burnt clinker in the cooling chamber is cooled by means of air entering the grate H, and is withdrawn at regular intervals, more raw material and fuel being added through E and F to take its place.

The fuel is usually small coal, which should be of good quality, the amount used being about 17-20 per cent. of the weight of the clinker produced. The output of the double kiln is from 20-30 tons per day.

The Aalborg kiln, shown in Fig. 27, is of Danish origin, and is now extensively used throughout the world. The clinkering zone is considerably constricted, and the cooling zone is conical in section with the larger diameter downwards. The raw material is fed in at A, and the fuel (coal) through a number of channels which slant downwards so as to enter the kiln below the clinkering zone. These firing holes are closed by means of iron covers when not in use. This kiln is very economical, the output is from 12-14 tons per day, and the coal consumption is only from 12-15 per cent. of

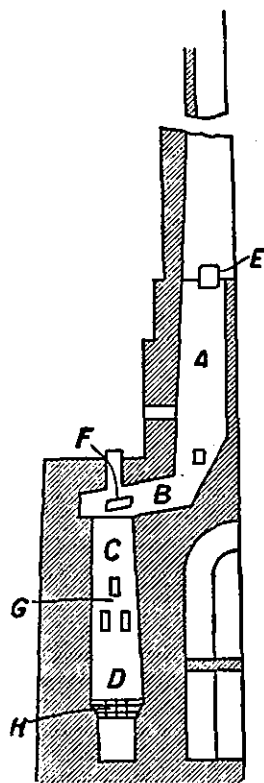

FIG. 26.—The Dietzsch Kiln.

the weight of burnt clinker. The "R" kiln is somewhat similar to the Aalborg, but there are two pre-heating chambers with a passage between, the floor of which is perforated for the introduction of the fuel (small coal); these holes are closed by covers when not in use. There are also openings in the walls of the shaft for assisting the descent of the clinker. The kilns are arranged in groups surrounded by a kiln house, which usually has four floors besides the ground floor. The top floor is the charging floor, the next is the firing floor and the other two are for gaining access to the clinkering and cooling zones. The output of this kiln is 18 tons per day, and the coal consumption about 16 per cent. of the weight of clinker produced. The Stein ribbed kiln differs considerably from the shaft kilns already described. It consists of a cylinder from 6 ft. 6 in. to 8 ft. in diameter, and from 23-30 ft. in height, built up of cast-iron rings with channels on the outside. The cylinder is supported on short columns of masonry, and the top is covered by a conical iron hood furnished with four holes, which may be closed by means of doors for the purpose of charging. Above this hood is the chimney, which is provided with a damper at the top in order to regulate the draught. The kiln has a special form of basket grate which facilitates the operation of drawing the clinker. It is claimed for this kiln that, owing to the rapid cooling of the walls, the clinker shows no tendency to adhere to the sides. The output of a kiln of the largest size is about 15-16 tons per day.

Among other well-known kilns may be mentioned the Schneider, the Hauenschild, and the Hotop kilns, all of which possess some advantage.

**Storing and Grinding the Clinker.**—The clinker may be ground as soon as it is cool, or it may be stored for a time before grinding. In the case of **rotary clinker**, storing for a period of about two to six weeks is sometimes resorted to in order to soften the clinker; the effect of this treatment depends, however, upon the degree of burning, and the composition of the clinker.

Low-limed clinkers readily fall to powder, and those which are higher in alumina crumble more readily than those which are more siliceous. The storing may also be carried out for the purpose of having a reserve of clinker upon which to draw when required, or for other reasons.

The clinker from **vertical kilns** always contains some under-burnt and over-burnt material, the former being known according to its colour as **half-burnt, slack, or pink**. Under-burnt clinker is a comparatively soft material and generally has a greenish-grey colour, but is often yellow or pink, and may even possess a reddish or purple tint. Over-burnt clinker is a dense, hard, non-porous material with a metallic appearance, and is generally of a dull bluish-black colour. Properly burnt clinker is a dark brown or greenish black, more or less porous substance, somewhat resembling coke in appearance. Before the clinker is ground it is necessary to pick out carefully all the under-burnt material, which is thrown aside to be reburnt. The over-burnt material should also be removed, but this is of less importance, as it is merely an inert substance, whilst the under-burnt clinker is actually harmful. The clinker from **rotary kilns** is in the form of small rounded lumps which are much harder, and usually much darker in colour, than that produced in vertical kilns, and like the latter it usually contains some under-burnt and over-burnt material, though, as the kiln is under more complete control, these should only exist in comparatively small amounts.

It is sometimes necessary to add a little gypsum or plaster of Paris to the clinker in order to regulate the setting time. This is especially the case with **rotary clinker**, which sets almost instantaneously if it is ground as it comes from

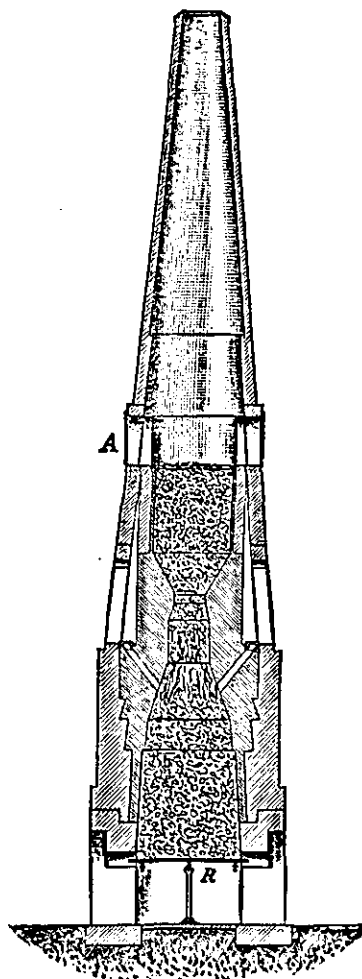

FIG. 27.—Aalborg Kiln.

the coolers without any further treatment. The setting time may also be regulated by watering the clinker, or a combination of the two methods may be employed. **The clinker from vertical mills** is first crushed to about the size of a hazel nut in a coarse crushing machine. The crushed material is then ground fine in the ball mill, followed by the tube mill.

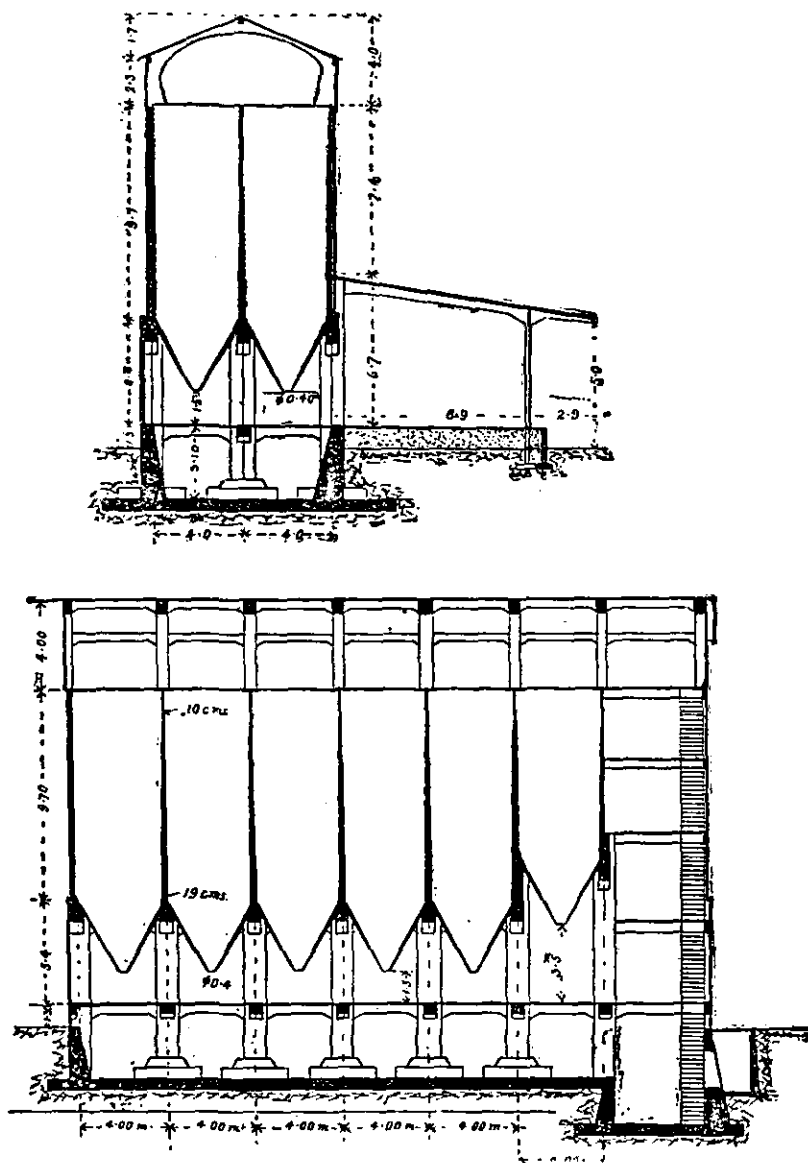

FIG. 28.—Silos with Hopper-Shaped Bottoms.

In Germany a sieveless ball mill has been recently introduced, in which the finer particles are removed from the mill almost as soon as they have been produced by means of a selector sifting machine. The output of this mill is said to be about 20 per cent. higher than that of any other type for cement of standard fineness, or a superfine cement known as selector cement may be prepared at the same cost as ordinary Portland cement. This cement is, of course, in no way superior to any other Portland cement ground to the same degree of fineness.

Rotary clinker is usually small enough to go straight to the grinding mills without any previous crushing, and is therefore usually conveyed by means of shaking or tray conveyers from the cooler to an elevator, which delivers it to the hopper of the grinding mill or to the clinker store. It is, however, sometimes necessary to pass it through the crushing rolls in order to crush any large balls which it may contain, or these balls may be separated by means of a coarse

sieve or grid placed at the end of the cooler. On account of its extreme hardness rotary clinker is more difficult to grind than that from vertical kilns. The tube mill is especially suitable as a finishing mill in the case of rotary clinker, as it offers a ready means of regulating the setting time by adding steam during grinding. This method, which is due to Bamber,<sup>1</sup> consists in passing steam under a suitable pressure into the mill through the hollow trunnion at the feed end; the time of setting of the finished cement will depend upon the pressure of the steam admitted.

When edge-runners are employed for grinding the clinker the ground cement is conveyed from the mills to an elevator which raises it to the sieves, by which the coarser particles are retained and returned to the mills for further reduction, whilst the fine flour passes on and is conveyed to the warehouse, where it is

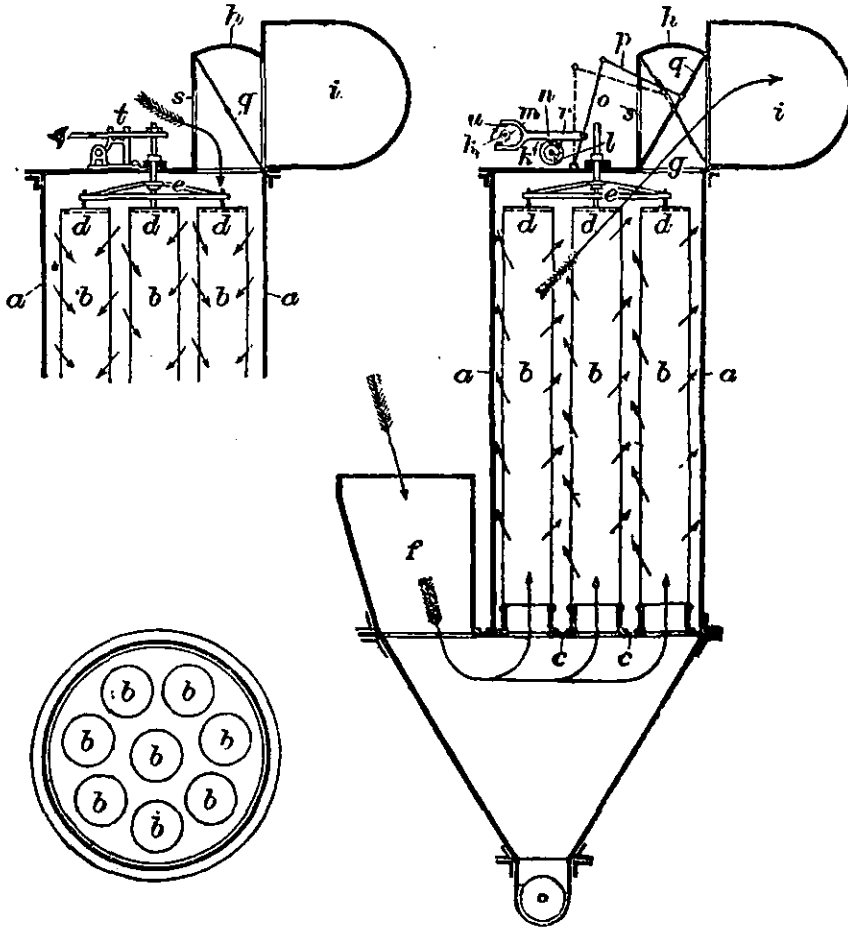

FIG. 29.—The Beth Dust Collector.

deposited in bins or silos. The sieves used are of various kinds and shapes. Revolving sieves which are circular, hexagonal, or octagonal in cross section are often used, as are also flat shaking sieves. Air separators are often employed instead of sieves for separating the cement, and their use is rapidly increasing. The air separator is described under **Manures**, p. 28.

**Storing and Packing.**—The finished cement is conveyed by means of elevators and conveyers to the storage bins or silos, where it is usually kept for a few weeks before packing.

<sup>1</sup> H. K. G. Bamber, *Trans. Concrete Inst.*, 1909, I, 106, 132.



Most works in this country employ flat-bottomed bins, the floors of which are level with the loading platform, and the cement is dug out from these and packed by hand. In some Continental works, silos with hopper-shaped bottoms are used, as shown in Fig. 28. The cement is discharged through a spout into sacks or barrels placed beneath, the packing often being done by means of automatic machines. In most American works the silos have slightly sloping floors, and automatically discharge their contents into a common tunnel. The cement is transmitted by means of a screw conveyer placed in the tunnel to the packing room, where it is elevated to a hopper beneath which the automatic filling machines are arranged. Portland cement is packed in sacks or barrels, shaking machines often being employed in order to ensure the cement being well shaken down.

**Dust Collectors.**—As might be expected, a large amount of dust is generated at most of the stages of the process of cement manufacture, and as this dust is not very objectionable, but represents a considerable financial loss, it is very advantageous to collect it by some means. Expansion chambers are the only means available for separating the dust from gases at a high temperature, as in the case of the air from the driers, kilns, and coolers. They may also be used for collecting the dust from the crushing and grinding mills, but filters and collectors depending upon centrifugal force are also employed. In the first case the air is usually drawn by means of a fan through one or more sheets of cloth held in light frames. Often, as in the case of the **Beth dust collector**, shown in Fig. 29, the filters are in the form of cylindrical sleeves, which are automatically cleaned of adhering dust, and sometimes the filter itself is caused to revolve. Those collectors which depend upon centrifugal force are less satisfactory than the dust filters.

**Weighing Machines.**—The use of weighing machines at various stages of the manufacture of cement is indispensable in modern practice. These are often of the steel-yard type, such as the ordinary platform weighing machine, or the hopper weighing machine, in which the material is fed into the hopper until the required load is obtained, when it is discharged by means of a lever which operates on the door in the bottom of the hopper. In most cases, however, automatic weighers are to be recommended. **Avery's automatic hopper weigher** is much used. The **rotating weigher** and the **Blake Denison automatic weighers** are also good machines.

Automatic weighing machines are also employed for weighing the material into sacks or barrels. In **Simon's dustless sack filler and weighing machine** the sack is attached to a trunk which is suspended from one arm of the balance beam, whilst the weights are suspended from the other. On working a lever the filling operation commences, and as soon as the sack contains the required amount, the supply is automatically cut off. Four bags per minute can be filled with this machine. An automatic cask-filling machine is also on the market.

**Composition of Portland Cement.**—Although, as stated on p. 88, Portland cement may be made from a great variety of raw materials, the composition of the finished product is practically constant. The essential constituents are lime, alumina, and silica; less important components are magnesia, oxide of iron, and the alkalis, whilst sulphur is usually found in small quantities, being either derived from the raw materials or the fuel, or added intentionally in the form of gypsum or plaster of Paris. Carbon dioxide and water do not exist in any notable quantity, except in old or improperly burnt samples. It is usually stated that there should be no free lime present, or the cement will "blow" and disintegrate after setting, but it is very improbable that ordinary free lime is ever found in true Portland cement. According to the British Standard Specification for Portland cement (1915), the proportions of lime to silica and alumina (calculated in chemical equivalents) must not be greater than the ratio  $\frac{\text{CaO}}{\text{SiO}_2 + \text{Al}_2\text{O}_3} = 2.85$ , or less than the ratio  $\frac{\text{CaO}}{\text{SiO}_2 + \text{Al}_2\text{O}_3} = 2.0$ , and according to the German "Normen" the ratio of lime to silica and alumina must not be less than 1.7, the ratio being based on actual weights.

**Magnesia** is nearly always present in small amounts, being derived from the raw materials. Free magnesia behaves in a similar manner to free lime, but slakes much more slowly, the time taken being proportional to the temperature to which the material has been exposed in the kiln. Magnesia combines with silica and alumina to form silicates and aluminates similar to the corresponding calcium compounds, but which become hydrated much more slowly, so that a cement con-

sisting of a mixture of calcium and magnesium silicates and aluminates is likely to suffer disruption after setting. According to Messrs Newberry<sup>1</sup> the silicates and aluminates of magnesium possess no hydraulic properties, and magnesia is incapable of replacing lime in cement mixtures. The British Standard Specification (1915) does not permit more than 3 per cent. of magnesia in Portland cement, whilst the German "Normen" allows as much as 4 per cent.

Portland cement owes its colour to the oxides of iron which it contains. At the clinking temperature these combine with the lime to form ferrites which, according to Le Chatelier, slake and decompose in the presence of water, but do not set. If any calcium sulphide should be present in the cement, this reacts with the iron compounds with the formation of ferrous sulphide, which is afterwards oxidised to ferrous, and finally to ferric oxide.

The only alkalis usually found in Portland cement are soda and potash, which are mainly derived from the clays and clay shales. They are usually present to the extent of about 0.5-1 per cent. in the form of silicates, some of which are soluble in water, and may therefore play an important part as carriers of silicic acid during the setting of cement.

The sulphur in Portland cement is derived partly from the calcium sulphate and iron pyrites (iron sulphide, FeS<sub>2</sub>) present in the clay and clay shales, and partly from the fuel. In addition to this sulphur, a small amount of calcium sulphate, in the form of plaster of Paris or gypsum, is frequently added after calcination. The British Standard Specification (1915) allows a maximum of 2.75 per cent. of sulphur trioxide (sulphuric anhydride, SO<sub>3</sub>), and the German "Normen" fixes the limit at 2.5 per cent. The action of these small amounts of added calcium sulphate is beneficial, as it retards the setting of the cement, which would otherwise be too rapid. In larger amounts it is injurious, partly because it is a much softer substance than cement, and partly because it is liable to be washed out of the mortar on account of its comparative solubility in water. The presence of sulphur in the raw materials is always objectionable, because it leads to the formation of calcium sulpho-aluminate, which is highly expansive, and also because of its tendency to become reduced to sulphide in the kiln. Thus, calcium sulphate is liable to become reduced to calcium sulphide, which then decomposes the iron compounds with the formation of iron sulphide.

The following are typical analyses of Portland cement :—

	No. 1. <sup>2</sup>	No. 2.	No. 3.
Lime - - - - -	62.50	61.92	61.07
Silica - - - - -	24.00	20.94	21.74
Alumina - - - - -	6.10	7.56	8.01
Ferric oxide - - - - -	2.44	5.02	4.35
Magnesia - - - - -	1.16	1.20	1.04
Alkalis - - - - -	0.41	0.91	0.83
Sulphuric anhydride - - - - -	1.40	0.92	0.94
Water and carbon - - - - -	1.55	0.95	0.81
Dioxide - - - - -	...	...	...
Insoluble residue - - - - -	0.44	0.64	1.08
	100.00	100.06	99.88

The properties of Portland cement do not, however, depend so much on the proportions of the constituents mentioned above as on their state of combination, and a great deal of work has been done on the composition of cement clinker and the process of setting and hardening. At the clinking temperature lime combines with silica, alumina, and oxide of iron to form calcium silicates, aluminates, and perhaps aluminosilicates, such as—

Tricalcium silicate? - - - - -	3CaO.SiO <sub>2</sub> ?
Tricalcium aluminate - - - - -	3CaO.Al <sub>2</sub> O <sub>3</sub> .
Tricalcium aluminoferrite - - - - -	3CaO.Al <sub>2</sub> O <sub>3</sub> .Fe <sub>2</sub> O <sub>3</sub> .
Dicalcium silicate - - - - -	2CaO.SiO <sub>2</sub> .
Dicalcium aluminate - - - - -	2CaO.Al <sub>2</sub> O <sub>3</sub> .
Monocalcium silicate - - - - -	CaO.SiO <sub>2</sub> .
Monocalcium aluminate - - - - -	CaO.Al <sub>2</sub> O <sub>3</sub> .

The first three of the above mentioned compounds were until recently considered to be the most important constituents of good Portland cement, but this view has had to be considerably modified, and, indeed, the existence of tricalcium silicate is somewhat doubtful. According to Le Chatelier<sup>3</sup> who was one of the earliest investigators in this field, tricalcium silicate is the constituent to which

<sup>1</sup> S. B. and W. B. Newberry, *Journ. Soc. Chem. Ind.*, 1897, 16, 887.

<sup>2</sup> Privately communicated by Messrs The Associated Portland Cement Manufacturers (1900) Ltd.

<sup>3</sup> Le Chatelier, *Compt. rend.*, 1882, 94, 867, 1883, 96, 1056; *Annales des Mines*, 1887 (8), 11, 345; "Sur la Constitution des Mortiers Hydrauliques," 1904.

the hardening of Portland cement is due. It cannot be formed by the direct combination of lime and silica, but is produced in the cement clinker by the fusion of lime and silicate. The dicalcium silicate forms twinned crystals, which, owing to the unequal contraction of the opposed faces, separate on cooling and thus cause the spontaneous disintegration of cement clinker, whilst monocalcium silicate is unacted upon by water, and therefore can have no effect upon the hardening of cement. The initial setting of cement is principally due to tricalcium aluminate, but also to di- and monocalcium aluminates, as all three compounds set in water. These views were generally accepted until recently, although **S. B. and W. B. Newberry**<sup>1</sup> found that when powdered tricalcium aluminate was mixed with water it cracked after setting and completely disintegrated when immersed in water. They also claimed to have prepared tricalcium silicate by the direct union of lime with silica. According to these investigators the most important constituents of Portland cement are tricalcium silicate and dicalcium aluminate. More recently, however, **Day and Shepperd**<sup>2</sup> have shown that tricalcium silicate cannot be prepared from lime and silica alone, and that calcium oxide occurs in cement in a crystalline form, in which, although not indifferent to water, it is much more slowly acted upon than the ordinary amorphous variety. They consider that the substance obtained by Messrs Newberry consisted of a solid solution of calcium oxide in dicalcium silicate. The same investigators together with **Rankin**<sup>3</sup> have shown that probably the only calcium aluminate occurring in Portland cement is the tricalcium salt,  $3\text{CaO} \cdot \text{Al}_2\text{O}_3$ . **Shepperd, Rankin, and Wright**<sup>4</sup> have since found that tricalcium silicate can be obtained by adding alumina to a mixture of lime and silica, but that it is unstable at its melting point, and neither takes up calcium orthosilicate nor lime in solid solution, nor forms eutectics with these compounds. The composition of cement clinker has also been investigated by means of the microscope by methods similar to those employed in metallography. At least four different kinds of crystals have been observed, for which **Törnebohm** has proposed the names "alite," "belite," "celite," and "felite" (see p. 125). According to **Richardson**<sup>5</sup> cement clinker should be regarded as an alloy. In the case of pure cement the "alite" is a solid solution of tricalcium silicate in tricalcium aluminate, and the "celite" a solid solution of dicalcium silicate in dicalcium aluminate, whilst commercial Portland cement is a more complex alloy containing compounds of iron oxide and lime corresponding to the aluminates. The magnesia, alkalis and sulphuric anhydride are regarded as non-essential constituents. **Rohland**<sup>6</sup> considers that the hardening of cements also consists in the formation of solid solutions, or adsorption compounds, whilst **Rebuffat**<sup>7</sup> attributes the hardening mainly to the hydration of the calcium orthosilicate. According to **W. and D. Asch** there is not one Portland cement, but a number of closely allied cements consisting of the calcium salts of highly complex aluminosilicic acids. From the results of a thermal investigation of the quaternary system,  $\text{CaO} - \text{SiO}_2 - \text{Al}_2\text{O}_3 - \text{Fe}_2\text{O}_3$ , **Jänecke**<sup>8</sup> concludes that ferric oxide only occurs in combination with lime and does not form solid solutions, and that a single ternary compound is formed of the composition



He regards this compound as being identical with "alite," and considers that its existence explains why the presence of alumina is necessary in Portland cement. Finally, he concludes that "belite" probably has the composition  $2\text{CaO} \cdot \text{SiO}_2$ , "celite" the composition  $3\text{CaO} \cdot \text{Fe}_2\text{O}_3$ , and "felite," which is often absent, the composition  $\text{CaO}$ . **Jänecke** and **Shumann**<sup>9</sup> found that the compound  $8\text{CaO} \cdot 2\text{SiO}_2 \cdot \text{Al}_2\text{O}_3$  forms the principal component of Portland cement clinker, in which it is readily detected, but according to **Rankin and Wright**,<sup>10</sup> **Jänecke's** supposed compound is really a mixture of calcium silicates and aluminates, containing at the ordinary temperature the compounds  $3\text{CaO} \cdot \text{SiO}_2$ ,  $2\text{CaO} \cdot \text{SiO}_2$ , and  $3\text{CaO} \cdot \text{Al}_2\text{O}_3$ .

In 1893 **Michaëlis**<sup>11</sup> suggested that the hardening of calcareous hydraulic cements—including Portland cement—was mainly due to the formation of colloidal calcium hydro-silicates. This theory was disregarded by most cement chemists for some years, but is generally accepted at the present time as it is strongly supported by a considerable amount of experimental evidence. **Michaëlis** has also shown that the strength of the hardened colloid is increased by the crystallisation of calcium hydro-aluminate and hydro-ferrite, and, when sufficient gypsum is present, of calcium sulpho-aluminate. **Ambronne**<sup>12</sup> has shown that when a little powdered cement is mixed with water under suitable conditions the formation of a gelatinous coating around the cement grains can be observed

<sup>1</sup> S. B. and N. B. Newberry, *Journ. Soc. Chem. Ind.*, 1897, 16, 887.

<sup>2</sup> Day and Shepperd, *Carnegie Inst. Publ.*, 1906; *Amer. J. Sci.*, 1906 (4), 22, 265.

<sup>3</sup> Day, Shepperd, and Rankin, *Amer. J. Sci.*, 1909 (4), 28, 293.

<sup>4</sup> Shepperd, Rankin, and Wright, *J. Ind. Eng. Chem.*, 1911, 3, 211; *Zeitsch. anorg. Chem.*, 1911, 71, 19.

<sup>5</sup> Richardson, *Tonind. Zeit.*, 1903, 27, 942.

<sup>6</sup> Rohland, *Zeitsch. Elektrochem.*, 1904, 10, 893; *Zeitsch. Chem. Ind. Kolloide*, 1911, 9, 21.

<sup>7</sup> Rebuffat, *Gazzetta*, 1898, 28, ii. 209.

<sup>8</sup> Jänecke, *Zeitsch. anorg. Chem.*, 1911, 73, 200; 1912, 76, 357.

<sup>9</sup> Jänecke and Shumann, *Zeitsch. anorg. Chem.*, 1912, 74, 428.

<sup>10</sup> Rankin and Wright, *Zeitsch. anorg. Chem.*, 1912, 75, 63.

<sup>11</sup> Michaëlis, *Chem. Zeit.*, 1893, 17, 982; *Cement and Eng. News*, 1907, 19, 140; 1909, 21, 298 and 338.

<sup>12</sup> Ambronne, *Tonind. Zeit.*, 1909, 33, 270.

under the microscope. Rohland<sup>1</sup> and Stern<sup>2</sup> have shown that the colloidal constituent in hardened cement can be dyed by immersion in a dilute solution of an eosin or other dye. Keiserman<sup>3</sup> has more recently investigated the specific absorption capacity of the chief constituent of cement for a number of dyes, and finds that patent blue is the best for the detection of alumina, alcoholic anthropurpurin for free lime, a solution of methylene blue in acetic acid for combined silica, and a neutral methylene blue for free amorphous silica. Employing this staining process, this investigator has made a microscopical examination of cement, from the results of which he concludes that Portland cement clinker is a conglomerate of dicalcium silicate and tricalcium aluminate, the presence of alumino-silicates being considered improbable. The proportions in which the constituents exist in the clinker correspond to the formula

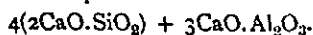

The hardening of the cement is due to the dicalcium silicate being started by the formation of fine, needle-shaped crystals, which are embedded in and cemented by the surrounding colloidal mass. The tricalcium aluminate accelerates the process of hydration but does not contribute towards the hardening process. Michaëlis<sup>4</sup> takes exception to Keiserman's formula but otherwise agrees with his view and points out that tricalcium silicate had long since been shown to have no existence, and that the presence of free lime in solid solution in the dicalcium silicate had been established beyond doubt.

From what has been said above, it will be obvious that the composition of Portland cement and the phenomena of setting and hardening have not been finally settled, and that much more research is required before the conflicting theories can be reconciled. On adding water to the cement the "alite" is partly decomposed, the calcium aluminates being attacked first, and the supersaturated solution thus obtained deposits tricalcium aluminate, partly in the form of crystals and partly in the form of a colloid. The calcium silicate is much more slowly attacked, and, owing to its insolubility, separates from solution as a colloid which forms a gelatinous coating around each cement grain. The hardening of the mass is brought about by the gradual desiccation of the colloid, and is increased by the adsorption of the lime liberated during the hydrolysis. This view is supported by the fact that when hardened cement is polished and etched it is found to consist of a number of grains of unaltered cement clinker embedded in a matrix, the colloidal nature of which is shown by its power of absorbing dyes.

According to Rohland<sup>5</sup> the part played by gypsum or plaster of Paris in the setting of Portland cement is that of a catalyst. Other salts may be used instead of calcium sulphate in order to modify the setting time, and those salts which accelerate the hydration of pure lime also accelerate the setting cement, whilst those which retard the hydration of the one also retard the setting of the other. Also when two salts which have an accelerating effect, such as sodium carbonate and aluminium chloride, are used together, the effect is greater than the sum of their individual effects when used separately, and, on the other hand, when two salts which have a retarding effect, such as potassium dichromate and borax, are allowed to act together, the retardation obtained is less than the sum of their individual effects. H. K. G. Bamber<sup>6</sup> has shown that the retarding effect of gypsum passes off when the cement to which it has been added is stored, but that the retarding effect obtained by passing steam into the tube mill during grinding is much more permanent.

**Adulteration of Portland Cement.**—The adulteration of Portland cement was at one time somewhat extensively practised. The choice of adulterants was limited, as only very cheap substances, which resembled Portland cement in colour and general appearance, could be used; the most usual materials employed for this purpose were Kentish rag (a siliceous limestone) and blast furnace slag, but other limestones, sandstones, old fire-bricks, etc., were also used. Such adulteration is rare at the present time, at least so far as British and German cements are concerned, and the most serious fraud is the substitution of cheap Belgium natural cements, or slag cements, for Portland cement.

**Action of Sea Water on Portland Cement.**—Sea water has sometimes been found to have a deleterious action on Portland cement. This was early attributed to the dissolving out of some of the lime from the cement, and the precipitation of salts of magnesium, and later on was considered to be due to the formation of sulpho-aluminates. According to Rebuffat,<sup>7</sup> however, when cement is immersed in sea water sulpho-aluminates are only formed to a very slight extent,

<sup>1</sup> Rohland, *Zeitsch. anorg. Chem.*, 1907, 56, 46.

<sup>2</sup> Stern, *Zeitsch. anorg. Chem.*, 1909, 63, 160.

<sup>3</sup> Keiserman, *Koll. Chem. Beihefte*, 1910, 1, 423; *Cement and Eng. News*, 1911, 23, 6 and 56.

<sup>4</sup> Michaëlis, *Cement and Eng. News*, 1911, 23, 61.

<sup>5</sup> Rohland, *Zeitsch. Angew. Chem.*, 1903, 16, 622; 1906, 19, 327.

<sup>6</sup> H. K. G. Bamber, *Trans. Concrete Inst.*, 1909, 1, 106 and 132.

<sup>7</sup> Rebuffat, *Gazzetta*, 1901, 31, i, 55.

and their existence is only transitory. On the other hand Poirson,<sup>1</sup> who has investigated the action on powdered cement of solutions of salts found in sea water, finds that calcium sulpho-aluminate,  $3\text{CaO}\cdot\text{Al}_2\text{O}_3\cdot 3\text{CaSO}_4$ , is the only stable compound formed.

**Physical Properties of Portland Cement.**—Commercial Portland cement should be of a cold bluish-grey colour, a brownish, "foxy" appearance indicating an excess of clay, the use of an unsuitable clay, or an under-burnt cement. The specific gravity is comparatively high (at least 3.10), and the cement should be very finely ground, as only the finest particles are of use as a cementing material. The tensile strength and resistance to crushing are higher than those of any other calcareous cement.

**Iron-Ore Cement.**—Many attempts have been made to prepare a Portland cement in which ferric oxide entirely replaces the alumina, but so far without success. Cements in which a large portion of the alumina is replaced by ferric oxide are, however, made.

In 1901 Krupp introduced a cement under the name of "sidero cement," in the manufacture of which iron ores are wholly or partially substituted for the clay usually employed. The cements of this class are called iron-ore cements, and must be distinguished from the iron Portland cements (see p. 85). They are employed in marine work on account of their supposed resistance to the action of sea water. These cements contain a large proportion of iron, as is shown by the following analysis, which is due to Michaëlis<sup>2</sup> :—

ANALYSIS OF AN IRON-ORE CEMENT (Michaëlis).

Silica	-	-	-	-	-	23.26 per cent.
Alumina	-	-	-	-	-	1.67 "
Ferric oxide	-	-	-	-	-	8.20 "
Lime	-	-	-	-	-	64.84 "
Magnesia	-	-	-	-	-	0.66 "
Sulphur trioxide	-	-	-	-	-	1.08 "
						99.71 per cent.

They are slow setting, and have a specific gravity of about 3.25-3.44

**White Portland Cement.**—There has been placed on the market a Portland cement which complies with the requirements of the British Standards Specification (1910), but which, owing to the absence of iron compounds, is white in colour. It was originally introduced in America, but is now used to some extent in this country.

It is very expensive, and is therefore unsuitable for ordinary building purposes, but finds many useful applications, among which may be mentioned cement plaster or stucco, repairing and joining marble pillars and blocks, the manufacture of tiles and mosaic work. For the latter purpose the cement may be coloured by means of venetian red, yellow ochre, and many other mineral colouring matters.

**Super-Cement.**—This cement was originally intended to be a waterproof Portland cement, that is to say, an ordinary Portland cement to which material was added in order to render it waterproof (see p. 118). It has been shown, however, that the treated cement not only makes a waterproof mortar, but that the latter is much stronger than that made with ordinary Portland cement. The increase in strength is especially marked in the case of cement and sand mortar, and the difference increases with time.

The author has carried out a number of tests with this material, and has found the tensile strength after ninety days of a mortar made with one part of treated cement to three parts of standard sand to be about 50 per cent. greater than that of a similar mortar made with the same, but untreated, Portland cement. Other tests, carried out elsewhere, have shown that after six months the tensile strength of the mortar made with the treated cement and sand is at least double that of a similar mortar made with untreated cement.

<sup>1</sup> Poirson, *Zentr. Hydraul. Zemente*, 1910, 1, 151.

<sup>2</sup> Michaëlis, *Cement and Eng. News*, 1907, 19, 140.

**Sand Cement.**—This is only Portland cement diluted with sand. It is prepared by mixing together equal weights of Portland cement and sand, and finely grinding the mixture.

## THE PLASTER CEMENTS

The plaster cements are prepared from **gypsum**, or the hydrated calcium sulphate,  $\text{CaSO}_4 \cdot 2\text{H}_2\text{O}$ , by driving off all or part of the water of hydration, and therefore consist essentially of more or less dehydrated calcium sulphate.

The occurrence, properties, processes of mining, and the chemistry of **gypsum** have been fully discussed in a separate article by James Shelton, Vol. I., p. 345.

In the following pages, therefore, we confine ourselves to the description of the processes employed in the manufacture of the various cements which have gypsum as their basis.

If fairly pure gypsum be heated to a temperature of about  $100^\circ$ - $200^\circ$  C. it becomes partially dehydrated, yielding a sulphate of the composition  $2(\text{CaSO}_4), \text{H}_2\text{O}$ , which is known as **plaster of Paris**. If the gypsum be heated much above  $200^\circ$  C. it loses all its water, yielding the anhydrous sulphate  $\text{CaSO}_4$ . It is then said to be "**dead-burnt**," and is useless for plaster of Paris, as it has lost the power of readily combining with water. If, however, such over-burnt plaster be very finely ground, hydration will take place, although very slowly, and when prepared under certain conditions it is employed under the names of **flooring plasters** and **hard-finish plasters**. When gypsum containing a large amount of impurities is heated to between  $100^\circ$  and  $200^\circ$  C. the product resembles plaster of Paris, but sets much more slowly, and the same result may be obtained by adding certain materials to plaster of Paris after burning. These slow-setting impure plasters are known as **cement plasters**, although they are quite different from the plasters made from the hydraulic cements, which are also known as "**cement plasters**" (see p. 82). From what has been said above it will be seen that the plaster cements may be classified as follows:—

Plaster of Paris	}	Prepared at temperatures below $200^\circ$ C.
Cement plasters		
Flooring plasters	}	Prepared at temperatures considerably above $200^\circ$ C.
Hard-finish plasters		

**Plaster of Paris and the Cement Plasters.**—The processes of manufacture of these plasters are so similar that they may be treated together, the only difference being that a pure gypsum is employed for the manufacture of plaster of Paris, whilst the cement plasters are prepared either from impure materials, or by adding a retarder during or after manufacture. Only two operations are necessary, calcination and grinding, and the latter may either follow or precede the former, according to the method of calcination employed. In Europe it is usual to calcine first, but in America, where the "**kettle process**" is employed, the opposite is the case, though the European plan is followed where rotary calciners are used. Great care has to be taken that the temperature does not rise too high or fall too low, and also that the material does not come in contact with the fuel, as this would lead to the formation of calcium sulphide.

**Calcining in Kilns.**—The oldest and simplest method of preparing the plaster is to burn the stone in a kind of shed enclosed on three sides by brick or stone walls, and covered with a rough tiled roof. The large pieces of gypsum are arranged on the floor so as to form a series of rough arches parallel to the main walls of the shed; and the remainder of the stone is placed on these arches, the larger pieces at the bottom, and the size gradually decreasing until at the top there are only dust and sweepings. Wood fires are then lighted in the arches; the hot gases rising through the interstices between the stones gradually heat the mass, driving off the water of hydration, and finally escape through openings in the roof and upper parts of the walls. Sometimes coal is used as fuel, in which case the

floor of the kiln is hollow, and the fires are lighted in these spaces, the flames passing into the kiln through holes left in the rooves of the arches. This crude kiln or shed is still employed on the Continent, but it is very wasteful, and the product is never uniform, as the lower layers receive more heat than the upper ones.

In the neighbourhood of Paris a kiln is employed which somewhat resembles the common lime-kiln (see p. 79), but has a cavity beneath the floor which serves as a fireplace. The flames and heat pass through openings in the floor into the kiln.

The **Dumesnil kiln**, shown in Fig. 30, is a great improvement on older kilns, as the heat is much more under control, and is evenly distributed over the whole mass of plaster-stone.

This kiln is circular in plan, and has an arched roof LL, in which are four small flues oo, and one large central one P, all of which can be closed by means of dampers. At the bottom of the kiln there is a central furnace D, the flames of which pass through flues EE into the fire-chamber G, and hence through twelve openings FF into twelve radiating arched flues MM built of the largest pieces of plaster-stone. There is a door at the side of the kiln for the purpose

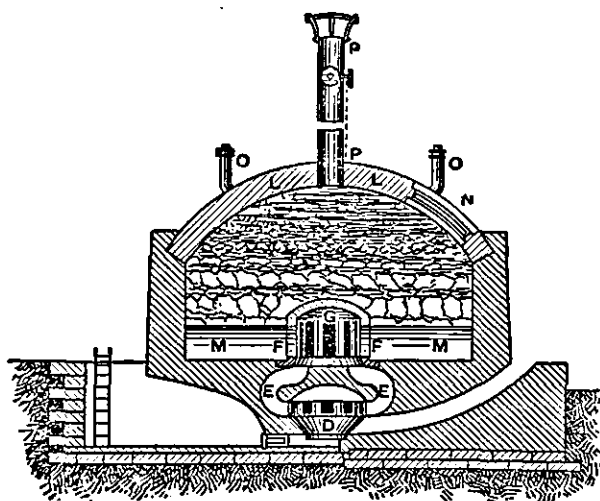

FIG. 30.—Dumesnil Kiln.

of emptying and unloading, and an opening N in the roof which serves for filling the top of the kiln. In working the kiln, the charge is calcined by means of a moderate fire; and then about 6 or 7 cub. yds. of unburnt stone are added at the top, and all the openings are closed, when the second lot of stone is dehydrated by the heat still contained in the first charge.

Although this kiln is expensive to build it is economical in working. Sometimes the plaster-stone is dehydrated by means of the waste gases from coke ovens. For this purpose the kilns and ovens are arranged thus.

The hot gases from ordinary coke ovens pass first into a flue, and then into a second flue, which leads to the kilns through holes in the floors of the

latter. The hot gases may be shut off from any of the kilns by means of dampers. The water-vapour and gases finally escape from the kilns through the chimney F.

Superheated steam has also been employed for dehydrating gypsum.

A jet of steam, at a temperature of about 200° C., is blown alternately into each of two chambers charged with the raw material, when the water of hydration is rapidly absorbed by the steam, leaving the plaster ready for grinding.

It is a common practice in this country to prepare the plaster by a continuous method in a kiln resembling a baker's oven, in which the stone does not come in contact with the fuel, but is dehydrated by means of hot gases which pass from a furnace through a flue passing round and round the oven.

Best plaster is sometimes prepared on a small scale by the moulders by a process known as **boiling**. They first grind the raw stone to a fine powder and then spread the latter in a layer, about 2 or 3 in. in depth, upon a metal plate or shallow dish placed over a fire, care being taken to avoid too high a temperature. The water vapour given off from the lower layer appears to raise the remainder of the material, and keep it in suspension with a peculiar motion to which the process owes its name of "boiling," and small craters are soon formed from which the steam escapes. The mass is stirred from time to time until no more water is given off, when the plaster is ready for use.

**Rotary kilns** for calcining plaster-stone have been in use for a number of years both in Europe and America. The process is a continuous one. In the **Mannheim calciner** there is a fire-box placed in front of a chamber containing a rotating cylinder, the interior of which is furnished with shelves or buckets. Above the cylinder, and connected to it by a pipe, is the **forewarmer**, which consists of a chamber through which a worm conveyer passes from one end to the other. The crude

gypsum is first crushed, but not finely ground, and is then conveyed by means of a bucket elevator to a bin placed above the calciner from which it descends into the forewarmer, where it is carried along by the worm conveyer, and then falls into the rotating cylinder. The fire-box is heated to a high temperature, and hot gases driven by a fan connected to it pass through the rotating cylinder, then through the forewarmer, and finally through a dust chamber to the chimney. The strong draught of hot gases causes the fragments of gypsum to travel in the same direction with a velocity inversely proportional to their size, so that the largest pieces are exposed to the heat for a longer period than the finer particles. The heat is so well utilised that the temperature of the gases passing to the chimney is only about 80° C.

The **Cummer rotary calciner** is much used in the United States. The raw material, which is first crushed and screened until it will pass through a 1-in. ring, is fed through a hopper into a cylinder, which is mounted on trunnions, so that it rotates about a slightly inclined axis. As the material passes down the cylinder it is picked up and again dropped by the lifting blades attached to the inner surface of the latter, thus being thoroughly exposed to the action of the hot gases. The latter are drawn by means of a fan into the brick chamber which surrounds the cylinder, and sufficient cold air is introduced through two registers to cool them to the required temperature, after which they are drawn into the cylinder through an opening, and, passing along in the opposite direction to the raw material, escape through the other end to the chimney. Pyrometers are inserted through the holes in order to control the temperature. The calcined material is immediately conveyed by means of an elevator to the calcining bins, where the heat still remaining in the material completes the calcination, and the cool plaster is finally ground, passed through sieves, and placed in sacks.

**Calcining in Kettles.**—This is the most common method of preparing plaster of Paris in the United States, but although superior to the old-fashioned European processes, it is slow and expensive, and is therefore being gradually abandoned in favour of rotary kilns.

The gypsum is first ground and then charged into cylindrical iron kettles about 8-10 ft. in diameter and 6-8 ft. high, through which pass two or four horizontal flues about 12 in. in diameter. The "kettle bottom" usually consists of a concave-convex iron casting with the convex side placed upwards, but in modern plants sectional kettle bottoms are frequently employed. The sides of the kettle are of boiler plate about  $\frac{3}{8}$ - $\frac{1}{2}$  in. thick, and the top is covered in by means of a sheet-iron cap provided with a door which serves for the introduction of the raw material. The kettles are supported on and enclosed by masonry, and a fire space, shaped like an inverted cone, is left underneath each kettle. The first floor of the mill is about a foot from the top of the kettles, which are usually arranged in pairs, with a shoot for supplying the raw material, and a pit for the calcined material to each pair. As it is necessary that the contents of the kettles should be kept constantly stirred, each of the latter is provided with paddles driven from an overhead shaft.

On starting a kettle, the heat must be gradually applied whilst the raw material is being fed in, and the contents must be kept constantly stirred. As the temperature rises to about 105°-110° C. the contents appear to boil violently until the mechanically held water is driven off through a stack passing through the sheet-iron cover, after which they settle down. On heating to 143° C., however, the boiling commences again as the combined water begins to be driven off. When the water of hydration has been driven off, the hot, finished material is run into the fire-proof pit until it has slightly cooled, when it is passed through a revolving wire screen in order to separate all large particles and coarse foreign matter, and is finally conveyed to the storage bins.

**Grinding.**—The grinding may be carried out either before or after the calcination, the latter being the most usual method in Europe, and also being used in America where rotary calciners are employed.

In either case the grinding is a simple matter. When the plaster-stone is ground before calcination the operation is usually carried out in three stages. The stone is first crushed to lumps about 2-4 in. in diameter in a coarse crusher. The roughly crushed material is then passed on to crushers of the coffee-mill type, which reduce it to about  $\frac{1}{4}$ - $\frac{1}{2}$  in. in diameter, and is finally ground in fine grinding machines, until about 55-65 per cent. will pass through a sieve containing 100 meshes to the linear inch. It is then ready for calcination. When gypsum-earth is used for the raw material the rough crushers are not needed, and the grinding is carried out in two stages. When the grinding is carried out after calcination it is usually done between millstones, but sometimes edge-runners or rollers are employed. The ground plaster should be kept from contact with air, as it readily absorbs moisture and deteriorates; unfortunately, however, but little attention is usually paid to this detail, and the plaster is placed in sacks after grinding. It is sometimes the practice in France to preserve the plaster in heaps by slightly wetting the surface, so that the crust thus formed protects the remainder of the heap. This plan is at once simple and effective.

Pure plaster of Paris consists of the hydrated calcium sulphate,  $\text{CaSO}_4 \cdot \frac{1}{2}\text{H}_2\text{O}$ , and therefore contains 93.8 per cent. of anhydrous calcium sulphate and 6.2 per cent. of water. The less pure forms, however, and especially the cement plasters,



contain various amounts of silica, alumina, ferric oxide, calcium carbonate, magnesium carbonate, and other impurities.

Le Voisier<sup>1</sup> was the first to show that the change from gypsum to plaster of Paris during calcination was due to the loss of water, and that the hardening of the plaster after gauging was due to the absorption of water to reform the original compound. Le Chatelier<sup>2</sup> has proved that plaster of Paris is a definite hydrate,  $2\text{CaSO}_4 \cdot \text{H}_2\text{O}$ , and has shown that when water is added to the calcined plaster a solution is obtained from which the hydrated sulphate soon crystallises out, thus allowing more of the plaster to be dissolved; this alternate solution and crystallisation continues until the whole of the plaster has become hydrated, the two processes going on simultaneously at different parts of the mass. According to Rohland,<sup>3</sup> the hardening of calcined plaster with water is a colloidal process.

The specific gravity of plaster of Paris is about 2.58. The tensile strength is about 300-400 lbs. per square inch for neat plaster, and 100-200 lbs. per square inch for a mixture of one part by weight of plaster to three of sand.

**Retarders and Accelerators.**—Plasters made from impure gypsum are usually sufficiently slow setting, but pure plaster of Paris sets with extreme rapidity, and, in order to moderate this action, it is a common practice to add various substances known as **retarders** to the cold calcined plaster.

The materials mostly employed for this purpose are glue, sawdust, blood, and other substances of animal or vegetable origin. There are also many patent retarders which consist essentially of the same or similar substances. It is usual to add from 2-15 lbs. of the retarder per ton of plaster, the mixing being carried out in a mixing machine, such as the Broughton mixer. Sometimes it is required to hasten the setting of an impure plaster, in which case an accelerator is employed. These are crystalline salts, one of the most efficient being sodium chloride (common salt).

**Hardening Plaster.**—Plaster of Paris may be hardened by the addition of various substances. A solution of glue or gum arabic may be employed, as in the preparation of "stucco" (see p. 118), or the plaster may be mixed with a little freshly slaked lime, and the casting dipped in a strong solution of magnesium sulphate. Another method is to use a solution of sodium silicate (water-glass), but the most usual plan is to use a solution of alum, as in the preparation of the "hard-finish" plasters (see below, and on p. 118).

The casting may be placed in the alum bath for some weeks, and then slowly dried, or the plaster may be soaked in the solution, dried, and again calcined. Still another method consists in mixing the plaster with a little finely ground mallow root, and kneading the mixture in water, or in gauging the plaster with a decoction of mallow root.

**Flooring Plasters.**—Flooring plasters (*Estrichgips*) are employed to a very large extent in Germany, as they give a hard and durable surface which is very suitable for floors, etc. They are prepared by coarsely crushing a relatively pure plaster-stone, and calcining it in a vertical kiln at a temperature of about 400°-500° C. for not more than four hours. If the heating be continued for a longer period than this the plaster becomes entirely deprived of its setting properties. The fuel employed is generally coal, and is burnt on a grate at the side of the kiln, the hot gases passing through the mass of the gypsum. The calcined stone is then very finely ground. The flooring plasters set with extreme slowness, but finally acquire great hardness. They consist essentially of anhydrous calcium sulphate,  $\text{CaSO}_4$ .

According to Van't Hoff when gypsum is completely dehydrated its ability to combine with water is at first only retarded, but gradually becomes lost either by prolonged exposure to a high temperature or by submission to more intense heat. Hence the necessity for keeping the temperature at 400°-500° C., and for discontinuing the calcination after four hours.

**Hard-Finish Plasters.**—These plasters resemble the flooring plasters in consisting essentially of anhydrous calcium sulphate, but they are calcined at a higher temperature (sometimes at a red heat) and are usually treated with various

<sup>1</sup> Le Voisier, *Oeuvres Completes*, 17, 3, 122.

<sup>2</sup> Le Chatelier, *Compt. Rend.*, 1883, 96, 715; *Annales des Mines*, 1887 (8), 11, 345; "Rech. Expt. sur la Constitution des Mortiers Hydrauliques," 1904.

<sup>3</sup> Rohland, *Kolloid Zeitsch.*, 1913, 13, 61.

chemicals, such as alum, during the process of manufacture. The calcination is carried out in two stages, the plaster-stone being first calcined, then dipped in a solution of alum, borax, or other salt, and again calcined at a high temperature, after which it is finely ground.

**Keene's cement** is now the general name for a number of different plasters prepared by various manufacturers, the original patent having expired. It is usually prepared by first calcining the plaster-stone to plaster of Paris, dipping this in a solution of alum or aluminium sulphate, drying, and recalcining at a much higher temperature. Sometimes, however, the first calcination is carried out at a high temperature, even red heat, and sometimes other salts are used instead of alum; indeed in some cases the plaster is prepared without dipping in any solution, when it is of course really a flooring plaster.

**Mack's cement** is prepared by adding calcined sodium sulphate or potassium sulphate to completely dehydrated gypsum. It sets rapidly and becomes very hard and durable. **Martin's cement** is similar to Keene's, but the solution of alum is replaced by one of potassium carbonate.

**Parian cement** may also be prepared in the same manner as Keene's cement, employing, however, a solution of borax in place of alum; or it may be manufactured by burning an intimate mixture of powdered gypsum and dry borax and finely grinding the product. All these plasters set quickly and become hard and durable.

## MORTAR, CONCRETE, PLASTER, AND STUCCO

**Mortars.**—Mortars are divided into **common mortar**, which is made with lime, and **cement mortar**, which is made with Portland, natural, or slag cement. **Common mortar** is prepared by mixing lime with water and sand; the proportions taken vary somewhat with the quality of the lime, but are usually one part by measure of slaked lime to three parts by measure of sharp sand, with enough water to make a somewhat stiff paste.

Small quantities of mortar are mixed by hand, but when large amounts are required it is usual to employ some form of mixing machine. The sand used should be free from clayey matter or vegetable earth, and should consist of sharp angular fragments of silica, though sands derived from granites and containing a large proportion of feldspar are also valuable. Sand which is much water worn, and blown sand, are not suitable, because they consist of more or less rounded fragments, and blown sand is also too finely grained. Sea sand is also unsatisfactory because of the deliquescent salts which accompany it. These salts may, however, be washed out by prolonged exposure to the weather or by washing in running water. Artificial sands, such as crushed sandstone, quartzite, granulated blast furnace slag, etc., are also used for mixing in mortar. The sand is mixed with the lime in order to reduce the shrinkage and prevent the consequent cracking which takes place when a paste of lime and water alone is allowed to dry, to render the mass more porous—thus facilitating the absorption of the carbon dioxide upon which the ultimate hardening of the mortar depends, and to somewhat increase the resistance to crushing. It also lessens the cost of the mortar, because sand is cheaper than lime. Sometimes trass, puzzuolana, or other natural or artificial puzzuolanic material is mixed with the lime (see p. 83).

**Cement mortar** may consist of a mixture of natural slag or Portland cement, sand and water, but as this does not spread freely it is a common practice to add more or less lime, or sometimes loam, although these materials (especially the latter) are detrimental to the strength of the mortar.

Cement mortar is employed for masonry structures, which are exposed to the action of running water or of waves, as a coating to cover masonry or concrete walls, and for other purposes.

**Concrete.**—Concrete or **Béton** consists of a conglomerate of pebbles, broken stones, gravel, blast furnace slag, or sometimes cinders, known as the aggregate, embedded in a matrix of mortar, the amount of mortar employed being sufficient to fill all the voids between the stones. The mortar may be either hydraulic lime mortar, as in the case of ancient or mediæval concrete, or cement mortar as in most modern work.

A distinction is sometimes made between the terms concrete and **béton**, the former term being used when the lime or cement is mixed with the gravel before adding water, as is usually the case in this country, whilst the latter term is employed when the lime is worked into a paste before adding the gravel. Concrete is used for making blocks of artificial stone of various sizes for building purposes and for paving, for the production of monolithic work, and as a backing for coursed masonry. As in the case of mortar, it may be mixed by hand or by machinery, a great variety of machines for this purpose being in use.

**Armoured or Reinforced Concrete.**—For some years it has been the practice to employ concrete in which iron rods, wire netting, or perforated iron plates are embedded. The material thus obtained is known as *armoured, reinforced* or *ferro concrete* (see also p. 129).

It is used to a large extent in the construction of arches, pillars, beams, floors, etc., and also for making pipes and tiles.

**Plasters.**—The ceilings and inside walls of buildings are usually given a smooth coating of plaster.

In France, plaster of Paris is employed for this purpose, but in England it is more usual to employ a lime mortar to which cows' or calves' hair is added. The various "hard-finish" plasters (see p. 116), such as Keene's and Parian cements, are also used and, especially for outside work, cement mortar.

**Stucco.**—Stucco is a special hard plaster which can be polished. It is usually coloured so as to imitate various kinds of marble.

There are two principal kinds of stucco, that made from plaster of Paris, and that made from lime. **Plaster stucco** is mixed with a lukewarm solution of size, fish-glue, or gum arabic. When required of any particular colour, the colouring matter is dissolved in the solution before gauging. **Lime stucco** is generally mixed with chalk, plaster, or other materials; the colours are usually obtained by mixing metallic oxides and salts with the lime. Cement plaster is also known as **cement stucco** when it is employed for coating the surfaces of walls, pillars, etc., white Portland cement being particularly suited for this purpose.

**Staff.**—For temporary buildings of an ornamental character, such as those required for exhibitions, etc., it is usual to employ a plaster which is toughened and bound together by means of tow, or sometimes by asbestos or slag wool. This material, which is known as **staff** or **fibrous plaster**, is fixed upon a backing of very coarse, open canvas called "scrim."

## WATERPROOFING CEMENT MORTAR AND CONCRETE

It is often necessary that cement concrete should be impermeable to water, as in the construction of reservoirs, sewers, and so forth. In such cases it is usually quite possible to make the concrete watertight by using a properly graded aggregate, and completely filling the voids with mortar made with cement and fine sand, but it is a common practice to have recourse to some method of rendering the cement waterproof.

Sometimes cement work already in existence also often has to be rendered watertight, and in this case it is necessary to add a coating of some waterproofing material. This may be done by covering the surface with some impermeable material, such as asphalt, tar or paint, or by applying alternate coatings of soap and alum solution by means of a brush, as in **Sylvester's process**, the object being to fill the pores of the concrete or mortar with an insoluble precipitate. In the case of new work the materials—soft soap, alum, potash, etc., are sometimes mixed in with the mortar, and since **Moyer**<sup>1</sup> has shown that when mineral oil is mixed with cement mortar a waterproof mixture is obtained, this method of waterproofing is sometimes employed. Animal or vegetable oils should not be used in place of the mineral oil because they are liable to decompose, with the liberation of free fatty acids.

A large number of compounds of very varying efficiency have been introduced for this purpose under more or less fancy names,<sup>2</sup> such as "ceresit," "driwal," "impervite," and "cement-kote." So far as the author is aware all the compounds hitherto introduced fail when exposed to water under a high pressure, and many have a more or less harmful effect upon the cement, a reduction of as much as 30 per cent. in strength being sometimes found. A large number of these compounds consist essentially of calcium carbonate, alum and calcium soap, sometimes with more or less free oil or fat. They are usually sold either in the form of a powder to be mixed with the

<sup>1</sup> A. Moyer, *Concrete and Constructional Engineering*, 1910, 5, 166.

<sup>2</sup> W. L. Gadd, *ibid.*, 1908, 3, 154; *Journal of the Concrete Inst.*, 1912, 4, 503.

dry cement before adding the water, or in the form of a paste to be mixed with the water used for gauging. One of the best compounds of this water-repellant type which has come under the author's notice is known as "medusa." When mixed with proper care this compound, which is a fine, white, extremely water-repellant powder, proves satisfactory for the purpose for which it is intended. Another class of water repellants which has been recently introduced consists of mineral oils.

Some waterproofing compounds consist of solutions of sodium silicate (water-glass) or silicofluoride, and other silicofluorides, such as those of zinc, magnesium, and aluminium, are also used, being sold under the name of fluates.

One compound consists essentially of a mixture of alum and zinc sulphate in a quantity of water which is insufficient for complete solution, and another consists of a solution of oxalic acid. The object in all these cases is to form insoluble compounds of calcium in the pores of the mortar or concrete.

Other compounds depend upon the presence of, or are stated to contain asphalt, or some other bituminous substance for their waterproofing properties.

A waterproofing compound of still another type is sold under the name of "ironite."

This consists essentially of finely powdered iron and a soluble salt which brings about the rapid rusting of the iron in the presence of moisture. It is made into a paste with water, and well rubbed into the surface to be waterproofed by means of a stiff-haired brush, two or three coats being usually necessary. The author has found this compound to be efficient when properly applied. The ironite paste has considerable bonding power, a broken briquette after being joined with the paste frequently showing a tensile strength of over 400 lbs. per square inch. A special variety of "ironite," which consists of a coarser iron powder and which does not contain the salt, is mixed dry with cement to make hard floors, etc.

The recently introduced **super-cement** (see p. 112) not only produced a waterproof mortar or concrete without any further treatment, but the latter is much stronger than that obtained with ordinary cement.

## CHEMICAL ANALYSIS OF LIMES AND CEMENTS

**Common and Hydraulic Limes.**—The water and carbon dioxide in these limes are determined by igniting a weighed amount in a platinum crucible, and ascertaining the loss of weight. The carbon dioxide is then determined by any of the usual methods, that of Fresenius<sup>1</sup> being very suitable; the difference between this value and the loss on ignition gives the amount of water present. In order to determine the lime and magnesia, which is frequently all that is necessary, a weighed amount of the sample is dissolved in hydrochloric acid, the solution rendered alkaline with ammonia, boiled, and the precipitate of silica, alumina, and ferric oxide filtered off, dried, ignited, and weighed. The lime is then precipitated from the filtrate in the form of calcium oxalate, filtered off, dried, ignited to the oxide, cooled, and weighed. The magnesia in the filtrate from the calcium oxalate is determined as magnesium pyrophosphate,  $Mg_2P_2O_7$ , in the usual manner.

The calcium oxide in common lime may be determined by boiling about 0.5 g. of the sample in about 250 c.c. of air-free distilled water, cooling and titrating the cold solution with  $\frac{N}{10}$  HCl, using phenolphthalein solution as an indicator.

$$\frac{\text{No. of c.c. } \frac{N}{10} \text{ HCl used} \times 0.0028 \times 100}{\text{Weight of sample}} = \text{percentage of calcium oxide.}$$

**Portland Cement.**—A weighed amount of the dried cement is placed in an evaporating dish and triturated with a little water until all tendency to set has ceased. Hydrochloric acid is then added and the contents of the dish evaporated to dryness, then baked at a temperature of 200°C. for about an hour and allowed to cool. More acid is added, and the process repeated, after which the dry mass is treated with dilute hydrochloric acid, boiled, filtered, and washed, the filtrate and washings being made up to 250 c.c. at 15°C. The residue consists of silica and insoluble matter, which are separated in the usual manner by fusion with sodium carbonate. A known volume of the 250 c.c. of solution is now transferred to a beaker, rendered alkaline with ammonia, warmed, filtered, and the precipitate, which consists of ferric oxide and alumina, washed, dried, and ignited. These oxides may be separated and determined gravimetrically, but owing to the difficulty of carrying out a complete separation, it is better to dissolve up the weighed precipitate and then

<sup>1</sup> Fresenius, "Quantitative Chemical Analysis," 1900, I, 340.

estimate the iron volumetrically by means of potassium permanganate or dichromate, and take the difference as the amount of alumina.

If it is required to determine the **ferrous iron**, this is done by triturating a few grammes of the cement with an excess of water until all tendency to set has ceased, adding a little sodium bicarbonate, and washing the mixture into a flask fitted up in the usual manner for solution in absence of air, dissolving the cement in hydrochloric acid, and determining the iron by titration with potassium bichromate.

The **lime** and **magnesia** in the filtrate and washings from the combined precipitate of ferric oxide and alumina are determined in the same manner as in the analysis of lime (see above).

The **sulphur** in the form of **sulphuric anhydride** is determined by adding a solution of barium chloride to a known volume of the 250 c.c. of solution (see above), and collecting the precipitated barium sulphate, which is dried, ignited, and weighed. The sulphur present, in the form of sulphides, may be determined by dissolving a known amount of the sample in hydrochloric acid in the absence of air, passing the evolved gases through a solution of cadmium chloride, and weighing the precipitated cadmium sulphide.

The **alkalis** may be determined by **Laurence Smith's method**,<sup>1</sup> and the **carbon dioxide** and **water** may be determined in the same manner as in the analysis of lime. **Free silica** can be separated by the method of **Fresenius**,<sup>2</sup> and many methods have been described for the separation of **free lime**, among which may be mentioned those of **Enright**<sup>3</sup> and **Brandenburg**,<sup>4</sup> but so far as the author is aware there is no satisfactory method known either for the detection or estimation of this substance in cement, and its existence in the ordinary form in Portland cement is very doubtful. The addition of limestones may be detected by the high loss on ignition, due to the liberation of carbon dioxide, and that of siliceous materials by the determination of the insoluble residue, which should not be above 2 per cent. According to the British Standard Specification (1910) the insoluble residue must not exceed 1.5 per cent.

**Natural and Pozzuolanic or Slag Cements.**—These are analysed in the same manner as Portland cement. Slag cements may be distinguished from the latter by **Seger and Cramer's method**.<sup>5</sup>

**Plaster of Paris.**—Plaster of Paris, and the related "flooring" and "hard-finish" plasters, are analysed in much the same manner as Portland cement (see Vol. I., p. 348, **Gypsum**, for fuller details).

## PHYSICAL AND MECHANICAL TESTS

Portland cement, being the most important of the calcareous cements, is the one most frequently submitted to physical and mechanical tests, and when other cements are tested they are treated in much the same manner. The chief physical and mechanical tests are:—

Specific gravity.	Crushing strength.
Fineness.	Setting time.
Tensile strength.	Constancy of volume and soundness.

Before carrying out the tests for tensile and crushing strength, setting time and soundness, the cement should be spread out for a depth of 3 in., and kept at a temperature of 15°-18° C. for twenty-four hours.

**Specific Gravity.**—Although this test is almost universally carried out in England its utility is more than doubtful, and a knowledge of the specific gravity is no guide whatever to the quality of a cement. This fact is recognised in France and Germany, the specific gravity being omitted in the French and German standard specifications. According to the British Standard Specification (1915), however, the specific gravity of Portland cement, when presented by the manufacturer, must be not less than 3.10. The determination may be carried out in an ordinary specific gravity bottle, but it is more conveniently made in a special flask such as that introduced for the purpose by **Stanger and Blount**,<sup>6</sup> or in **Leipper's** modification of **Le Chateleur's** flask. The British Standard Specification (1915) approves the bottle shown in Fig. 31. The flask is charged with about 100 c.c. of dry petroleum, turpentine, or other suitable liquid, and placed in a bath of water, which is maintained at a temperature of 15°-18° C. (58°-64° F.), and allowed to remain therein until the level of the contained liquid is constant. This level is read off, and the reading noted on the lower ground glass space. Exactly 100 g. of the cement are then added, the stopper is inserted, and the bottle is gently tapped on a soft pad in order to get rid of any entangled air. The flask is now replaced in the water bath, which must be retained at the original temperature, and when the level of the liquid is constant, the reading is again taken, a note of it being made on the upper ground glass space.

<sup>1</sup> Crookes, "Select Methods of Chemical Analysis."

<sup>2</sup> Fresenius, "Quantitative Chemical Analysis," 1900, 2, 259.

<sup>3</sup> Enright, *Journ. Amer. Chem. Soc.*, 1904, 1003.

<sup>4</sup> Brandenburg, *Chem. Zeit.*, 1909, 33, 880.

<sup>5</sup> Seger and Cramer, *Chem. Zeit.*, 1903, 27, 879.

<sup>6</sup> Stanger and Blount, *Journ. Soc. Chem. Ind.*, 1894, 13, 456.

The volume of liquid displaced by the cement is given by the difference between the two readings, and the specific gravity of the cement is calculated from the equation—

$$\frac{100}{\text{Volume displaced}} = \text{Specific gravity.}$$

A convenient method of ensuring that the petroleum or turpentine is quite free from water is to add a little freshly dried cement to the liquid some time before transferring it to the bottle.

**Fineness.**—The degree of fineness of the cement is of the utmost importance, and during recent years far more attention has been paid to this point than was formerly the case. The fineness is tested by means of sieves of brass wire cloth, which must be woven and not twilled. According to the British Standard Specification (1915) the residue left on a sieve containing 32,400 meshes per square inch must not exceed 14 per cent., when 100 g. of the sample is continuously sifted for a period of fifteen minutes, and that left on a sieve containing 5,776 meshes per square inch must not exceed 1 per cent. under the same conditions. According to the German "Normen" the residue must not exceed 5 per cent. on a sieve containing 900 meshes per square centimetre, the width of the mesh being 0.222 mm.

**Tensile Strength.**—Tests for tensile strength were among the first to be carried out in the mechanical testing of Portland cement, and they are still almost universally employed in this country, although a knowledge of the tensile strength is comparatively useless because, in the great

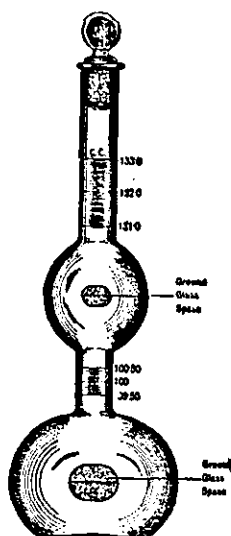

FIG. 31.—Specific Gravity Bottle.

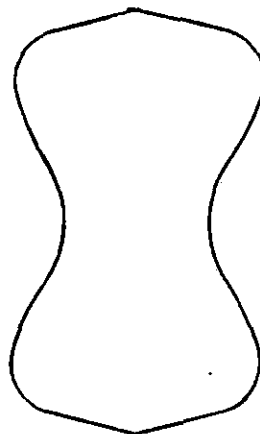

FIG. 32.—Briquette.

majority of cases, it is only the compressive strength that matters. The cement is mixed with such a proportion of water as to form a plastic mixture after filling the mould. It is then moulded in brass or gun-metal moulds, which should be wiped with an oily cloth before filling. The shape of the briquettes employed at different times has varied considerably, but that shown in Fig. 32 is the usual modern form, and the one recommended by the British Standard Specification (1915). The briquettes are kept in a damp atmosphere for twenty-four hours after gauging, and are then placed in clean water at a temperature of 15°-18° C. (58°-64° F.) until required for breaking; if they are to be kept for more than a week the water must be changed every seven days. They are tested for tensile strength immediately after being removed from the water. The machines for breaking the briquette vary very considerably in design, one of the oldest and best being the Adie Testing Machine, shown in Fig. 33. According to the British Standard Specification (1915) the briquettes are to be prepared without ramming or hammering in any form, and are to be tested at seven and twenty-eight days. The average breaking stress of six briquettes must not be less than 450 lbs. per square inch at seven days, and at twenty-eight days the average breaking stress of six briquettes must not be less than the number of lbs. per square inch arrived at from the formula—

$$\text{Breaking stress at seven days} + \frac{40,000 \text{ lbs.}}{\text{breaking stress at seven days}}$$

In addition to the test with neat cement, similar tests are carried out with a mixture of 1 part by weight of cement and 3 parts by weight of dry standard sand. According to the British Standard Specification (1915) the average breaking stress of six of the cement and sand briquettes must be not less than 200 lbs. per square inch at seven days, and at twenty-eight days the average breaking stress of six briquettes must be not less than the number of lbs. per square inch arrived at from the formula—

$$\text{Breaking stress at seven days} + \frac{10,000 \text{ lbs.}}{\text{breaking stress at seven days}}$$

The tensile strength, both of neat cement and of a mixture of cement and sand, is omitted in the German "Normen."

**Crushing Strength.**—The compression test is of much greater importance than the tensile test, although it is not so frequently employed, at any rate in this country. Cubes of specified dimensions are moulded and kept in the same manner as the briquettes described above, and are then tested for resistance to compression. The machines for carrying out this test are almost as variable in design as those employed for the tensile test, but as in most Portland cements the crushing strength is about ten times as great as the tensile strength, the machines have to be much more powerful. **Amsler and Laffon's** press is a very popular form, and another machine which is very convenient and satisfactory is that manufactured by the **Associated Portland Cement Manufacturers (1910) Limited**, which is shown in Fig. 34. Notwithstanding its importance, the

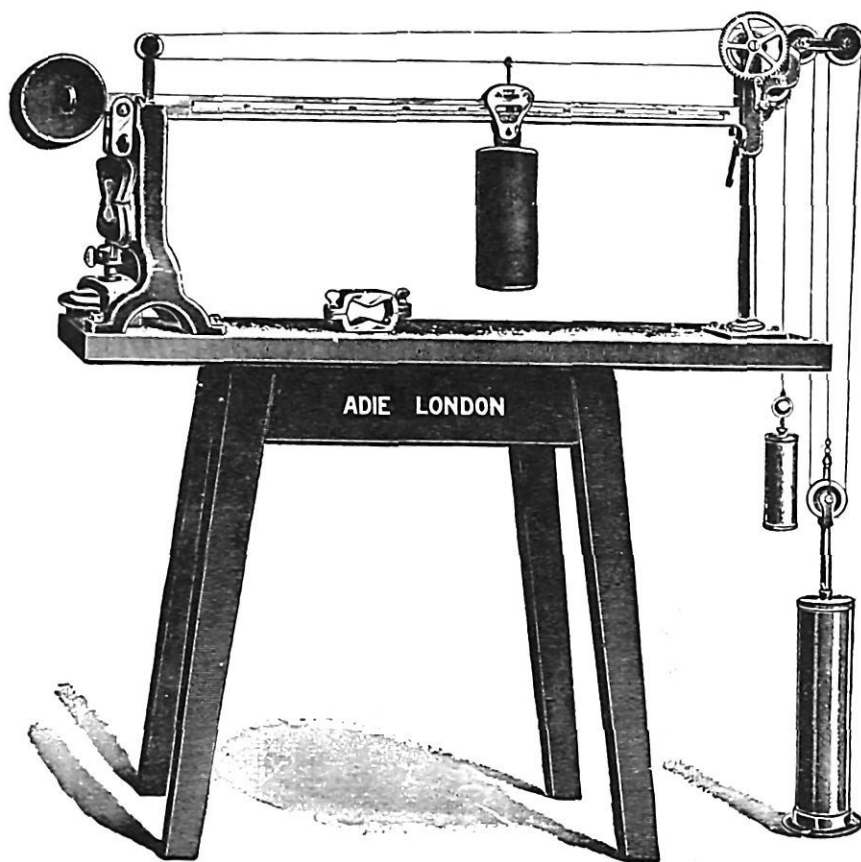

FIG. 33.—The Adie Testing Machine.

compression test has so far been omitted in the British Standard Specification for Portland cement. According to the German "Normen," however, a mixture of 1 part by weight of Portland cement to 3 parts by weight of standard sand must have a compressive strength of at least 120 kg. per square centimetre after seven days (one day in moist air and six days in water), and a compressive strength of at least 250 kg. per square centimetre after a further twenty-one days in air at a temperature of 15°-20°C. Portland cement intended for use under water must show a compressive strength of at least 200 kg. per square centimetre after twenty-eight days (one day in air and twenty-seven days in water).

**Setting Time.**—The setting time of cement is not usually of great importance, except in the case of quick-setting cements, when it is an indication of the length of time during which the cement may be worked during gauging. It is divided into two periods, known respectively as the **initial set**, and the **final set** or **set hard**. The time of the initial set is the period between the addition of the water and the moment when the mass loses its fluid condition, and the final set is the period between the addition of the water and the moment when the cement is sufficiently hard to withstand a specified pressure. The initial set is sharply defined in quick-setting cements, but is very vague and ill-defined in those which are slow setting. As the setting time is affected by

the amount of water used and the temperature of the room in which the test is carried out, the paste must be made of a specified consistency, and the test should be carried out at a definite temperature, usually at  $15^{\circ}$ - $18^{\circ}$  C. Both the initial and final setting time are determined by means of the **Vicat needle**, shown in Fig. 35. The needle is 1 mm. square, and is loaded to 300 g. The cement is contained in a split ring 8 cm. in diameter and 4 cm. high, which rests on a glass plate. The consistency is often considered correct when the mixture is plastic after being filled into the ring, as in the British Standard Specification (1915), but a modification of the Continental method is frequently used. In this method the consistency is considered **normal** when a plunger 1 cm. in diameter and weighted to 300 g. penetrates to within 6 mm. of the bottom of the pat. The initial set is considered to have taken place when the 1 mm. needle no longer penetrates to the bottom of the mould, and the final set when the needle fails to make any impression upon the surface of the cement. Various automatic devices for the determination of the setting time of cement have been introduced. **Tetmajer** used flowing water to depress the needle

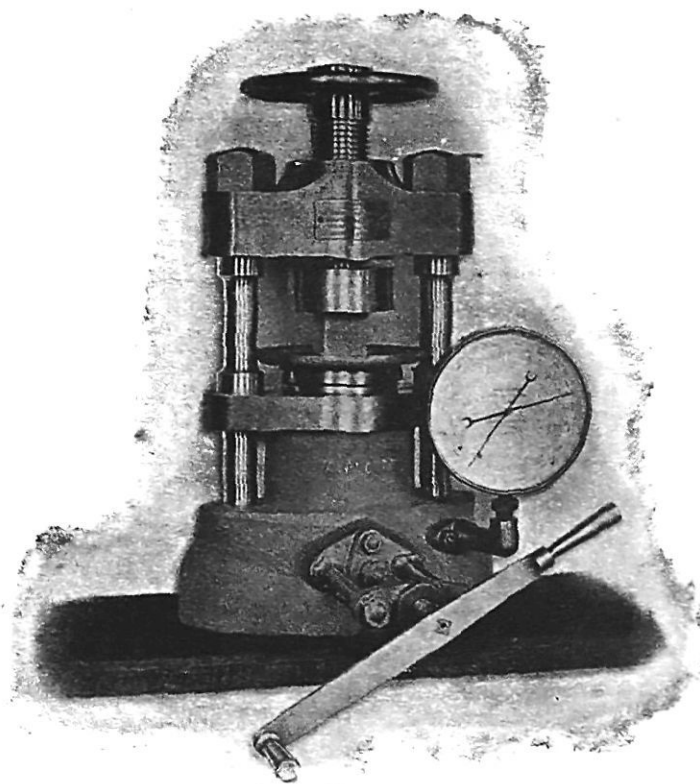

FIG. 34.—Compression Test Machine made by the Associated Portland Cement Manufacturers.

at regular intervals, and recorded the distance through which the needle moved at each stroke by means of a pen on a rotating disc. Goodman employed a small wheel instead of a needle. A rolling motion was imparted to this wheel, which dipped into a trough containing the cement, and a pencil attached to the axis of the wheel traced the setting curve. **Perin's** instrument has a needle driven by clockwork, and the record is taken as a series of arcs on a drum. None of these instruments has proved satisfactory. In **Marten's** apparatus there are three needles placed side by side, which are held up by means of magnets, and caused to descend at intervals by means of a cam which cuts out the sustaining magnets. After an interval of half a minute the needles are again raised, and the table carrying the cement moulds moved forward ready for the next impression. Although this instrument is superior to the others, the results obtained with it are said to be less trustworthy than those obtained by hand. In 1908 Woodcock patented an automatic apparatus (Patent, No. 17,245, 1908). This apparatus is actuated by means of clockwork, and consists of two Vicat needles which are gently lowered on to two semicircular pats of cement of standard thickness, held in moulds resting on a turn-table which moves onward one space every ten minutes, so as to bring a fresh portion of the pat under the needle. The whole is enclosed in a case in which the temperature can be kept under control. Once started, the apparatus needs no further attention, the time of setting in minutes being ascertained by counting the number of impressions and multiplying by ten. This apparatus has been in use



since 1908 at the laboratory of Mr F. Woodland Toms, official analyst at Jersey, and has proved quite satisfactory, giving results which are more consistent than those usually obtained by hand. Another automatic machine is Nicol's **Spissograph**.

Gary<sup>1</sup> has introduced a thermometric method of determining the setting time of cement, in which the evolution of heat during the process of setting is ascertained by means of a thermometer embedded in the cement, which is held in a rubber ring placed in a glass vessel and packed round with sawdust in order to avoid loss of heat. The initial set, as indicated by this method, is somewhat earlier than that obtained by the usual Vicat needle test, and, in the case of slow-setting cements, frequently cannot be detected at all, on account of the dissipation of the heat of hydration taking place as fast as its evolution. Also the results obtained with different quantities of cement vary. For these reasons the use of this instrument has been abandoned, at anyrate in this country. There can be little doubt, however, that this is a more scientific method of ascertaining the setting time than that usually adopted, since it indicates a real point of chemical change in the cement, instead of an arbitrary point depending upon the weight of the needle chosen, and when it has been further developed it will probably supplant the older method.

In the British Standard Specification (1915) Portland cement is classified in three groups as follows:—

**Quick Setting.**—When the initial setting time is not less than two minutes, and the final setting time is not less than ten minutes, or more than thirty minutes.

**Medium Setting.**—When the initial setting time is not less than ten minutes, and the final setting time is not less than thirty minutes, or more than three hours.

**Slow Setting.**—When the initial setting time is not less than thirty minutes, and the final setting time is not less than three hours, or more than seven hours.

In addition to these grades, specially slow cements, of which the minimum time of setting has been specified, may also be supplied. According to the German "Normen" the initial setting of normal Portland cement must not take place in less than an hour after gauging, but for special purposes a quicker setting cement may be prepared, which must be marked as such. The final setting time is not specified.

**Constancy of Volume and Soundness.**—The tests for constancy of volume and soundness are the most important of the mechanical tests. Soundness was formerly attributed to the presence of free lime, due to over-liming or under-burning, which slaked and expanded after the setting of the cement, causing the latter to "blow." At the present time this view is somewhat modified by most cement chemists. Ordinary quicklime undergoes immediate hydration on the addition of water, and therefore, even if present, could not be the cause of any subsequent expansion; but when the lime exists in a more or less crystalline form the hydration takes place much more slowly. The expansion of cement after setting may therefore be due to the presence of lime in a more or less crystalline form, in excess of that which the alite is capable of holding in combination or in solid

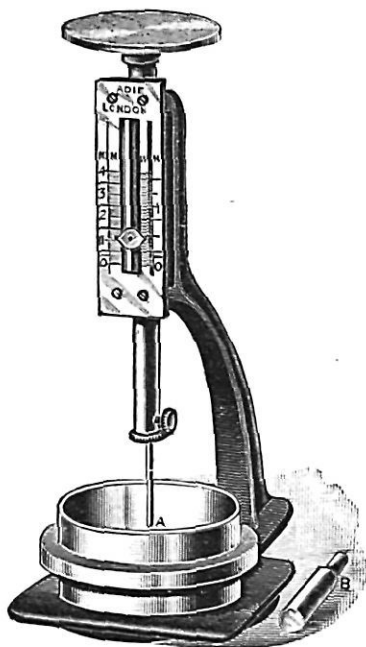

FIG. 35.—The Vicat Needle.

solution, or it may be due to the presence of an excess of magnesia, or to an excessive proportion of sulphates. The expansion in the latter case is considered by **Candlot** to be due to the formation of calcium sulpho-aluminate. Many methods have been proposed for carrying out the test for change of volume and soundness; at the present time an accelerated test is generally employed. In the **Faija test** a freshly gauged pat, placed on a glass plate, is subjected to a temperature of 40.5°-43° C. in a moist atmosphere until set, and is then immersed in water at a temperature of 46°-49° C. for the remainder of twenty-four hours. If the pat does not show any cracks or blisters on the surface next the glass the cement is considered to be sound, otherwise the sample is spread out in a thin layer in a cool dry place for a day or two and the test repeated. If this second pat does not show any cracks or blisters the cement is considered sound when properly aerated. The **Le Chatelier test** is usually employed. The apparatus consists of a split brass ring 30 mm. in diameter and 30 mm. deep, to which two pointers, 150 mm. in length, are soldered (one on each side of the split). The ring is placed on a glass plate, filled with the cement paste, covered over with a second glass plate, and the whole placed in water at 15°-18° C. for twenty-four hours to set. The distance between the ends of the pointers is then measured and the apparatus is placed in cold water, which is then gradually raised to the boiling point, and kept boiling for six hours. After cooling, the distance between the ends of the pointers is again measured, the increase in the distance being termed the **expansion**. According to the British Standard Specification (1915) the soundness of Portland cement must be determined by the Le Chatelier method, and the

<sup>1</sup> Gary, *Concrete and Constructional Engineering*, 1907, 1350 and 431.

expansion must not exceed 10 mm. when the sample has been aerated for twenty-four hours in the manner described on p. 124. If the expansion is greater than this limit the test must be repeated, with the difference that the sample is aerated at 15°-18° C. for seven days before testing. In this case the expansion must not exceed 5 mm.

## MICROSCOPIC EXAMINATION

A microscopic examination of cement is often of value for detecting the presence of adulterants. Thus, Kentish rag can be distinguished from clinker by its light colour and smooth appearance when examined under the microscope. The microscope has played an even more important part, however, in the investigation of the constituents of cement clinker and hardened cement. The earliest attempts to utilise the microscope in this manner were due to Le Chatelier and Törnebohm, the names "*alite*," "*belite*," etc., by which the constituents of cement clinker are known, being due to the latter investigator. The microscopic examination of the clinker may be carried out in two ways: (1) One side of a thin chip of clinker may be ground and polished, the smooth surface cemented to a piece of glass by means of Canada balsam, and the other side then ground until the section is sufficiently thin and polished. The thin section is then removed from the glass, mounted on a microscopic slide, covered with a cover glass, and examined under the microscope by transmitted light. (2) A chip of the clinker is ground and polished on one face only, and examined under the microscope by reflected light, in the same manner as metals and alloys are examined by metallographists. Owing to the difficulty of obtaining sections of sufficient thinness, the second method is to be preferred. The objective should be corrected for use without a cover glass, the most convenient power being a 6 mm., and the eyepiece should be of moderate power so as to give a magnification of about 300 diameters.

In order to polish the clinker it is rubbed on a series of carborundum blocks, or sheets of carborundum cloth or paper, each successive block or cloth being of finer grain than the last; the final polish is then obtained by means of rouge or alumina (diamantine powder) on a piece of stretched cloth. Water must not be used, as it attacks the clinker. When examined under a lens the finished surface should be free from scratches, and should present a mirror-like polish. In order to bring out the structure it is necessary to etch the polished surface by rubbing it on a stretched cloth moistened with water, or by means of a 1 per cent. alcoholic solution of hydrochloric acid.

The following constituents are found in cement clinker:—

**Alite.**—This constituent is in the form of nearly colourless, well-defined crystals, belonging to the rhombic system. It appears to be the principal product of the chemical reaction between the materials in the kiln, and the quantity found in the clinker increases with the proportion of lime present. According to Richardson, alite is a solid solution of tricalcium silicate in tricalcium aluminate (see p. 110). Crystals of pure alite have been prepared, and these were found to contain lime, silica, alumina, ferrous oxide, and magnesia.

**Belite.**—This is similar to alite, but has a darker colour, and usually shows fine striæ. It appears to contain less lime than alite. It is by no means always present in all cement clinker, but is usually found in cements which are poor in lime.

**Celite.**—Celite and alite are the principal constituents of cement clinker, and are probably the only ones which are essential. Celite is darker in colour than alite, probably on account of the larger proportion of iron which it contains. In the clinker it forms a matrix between the grains of alite, so that it appears to be the more fusible portion of the clinker, which has actually melted at the clinkering temperature and then solidified as a eutectic mixture. An increased amount of ferric oxide in the clinker causes an increased proportion of celite. According to Richardson, celite is a solid solution of dicalcium silicate in dicalcium aluminate (see p. 110).

**Felite.**—This constituent does not often occur in cement clinker, but is found in blast furnace slag. It forms rhombic crystals, and may contain magnesia when this is present in the clinker. Belite and felite are probably two forms of the same solid solution. According to Kappen<sup>1</sup> the proportion of belite to felite in cement clinker depends upon the temperature of the kiln, the production of felite being favoured by a high temperature.

When clinker is etched with 1 per cent. alcoholic hydrochloric acid, and examined by reflected light, it presents the appearance of a number of grains embedded in an intercrystalline matrix. The grains, which are attacked by the etching reagent, consist of *alite*, whilst the intercrystalline portion appears to be mainly *celite*, but often contains more or less of a hard, white, porcelain-like material. A number of gas cavities are always seen, showing that the clinker has an open, pumice-like structure. Clinker from rotary kilns generally presents a much finer structure than that from stationary kilns, otherwise it is essentially the same.

Hardened cement may be polished, etched, and examined in the same manner as clinker. Two constituents are found, the first of which exists in small, irregular grains, embedded in a matrix of the second constituent. The grains consist of unaltered cement clinker, as may be proved by etching with 1 per cent. alcoholic hydrochloric acid, when their structure may be seen. The matrix may be dyed by immersion in an aniline dye, thus showing its colloidal nature (see p. 111). The fact that hardened cement contains unchanged clinker explains why it will again set if reground and gauged with water, and also why extremely fine grinding improves cement.

<sup>1</sup> Kappen, *Tonind. Zeit.*, 1905, 29, 370.

## SECTION LX

# SOREL CEMENT

BY JAMES SHELTON, F.I.C.

### LITERATURE

- DAINS.—“Magnesite Deposits of India,” *J.S.C.I.*, 1909, XXVIII., p. 503.  
 ECKEL.—“Cements, Limes and Plasters.” 1905. New York. “The Mineral Industry.”  
 1909.  
 GEUTHER.—Dammar’s “Technologie der Neuzert.”  
 PREUSSNER.—*Tonindustrie Zeitung*, XXV., p. 2115.  
 LUHMANN.—*Chem. Zeitung*, XXV., Report 345.  
 SCHEERER.—“Der Magnesit.” 1908. Wein and Leipzig, Hartleberi’s Verlag.

It has been found that a paste made by mixing lightly calcined magnesia with a concentrated solution of magnesium chloride sets to a hard mass owing to the formation of a hydrated basic chloride, the composition of which may be expressed by the formula  $MgCl_2 \cdot 5MgO \cdot xH_2O$ , the value of  $x$  being about 17. This compound is one of the strongest binding materials known, and the mixture of chloride and oxide is technically employed under the name of **Sorel- (or Magnesia-) Cement**.

The magnesia is obtained<sup>1</sup> by calcining **magnesite**,  $MgCO_3$ , at a temperature of about  $800^\circ C$ .

The magnesite was formerly burnt in contact with the fuel in shaft kilns, but the modern practice is to employ regenerative gas-fired furnaces. The calcined magnesia should be free from carbonate, as during the setting of the cement the carbonate is decomposed with evolution of carbon dioxide and the production of an unsound cement. The standard quality stipulated for by Continental consumers at Leipzig in 1908 contains 85-90 per cent. of magnesium oxide and less than 4 per cent. of lime.

The **magnesium chloride**,  $MgCl_2$ , is obtained as a by-product from the mother liquor obtained in the extraction of potassium chloride from the deposits of **carallite**,  $MgCl_2 \cdot KCl \cdot 6H_2O$ , at Stassfurt.<sup>2</sup>

The mother liquor, on evaporation at boiling point to a specific gravity of 1.34, deposits magnesium sulphate with chlorides of sodium and potassium. The hot liquor is separated from the crystals and is run into casks in which it solidifies on cooling, and in this state is put on the market as magnesium chloride. *Bittern*, the mother liquor after extraction of common salt from sea water, is another source of magnesium chloride.

For the preparation of sorel cement a solution of magnesium chloride,  $MgCl_2$ , of specific gravity 1.16-1.26, is employed. Sulphate should have been removed previously by precipitation with barium carbonate. The magnesia is intimately

<sup>1</sup> See, however, this work, Vol. I., p. 366.

<sup>2</sup> See this work, Vol. I., p. 329, **Stassfurt Industry**, also **Weldon and Deakin Process**.

mixed with the aggregate, and the mixture is then moistened with magnesium chloride solution and filled into moulds.

Mixtures of chloride and oxide of magnesia are sometimes made and sold under the name of dry sorel cement. These are prepared either by simple mixture of chloride crystals with magnesia or by heating the crystals of  $MgCl_2 \cdot 6H_2O$ . At temperatures above  $186^\circ C$ . water and hydrochloric acid are evolved from this chloride, and, by judicious heating, a mixture of oxide and chloride in the correct proportions may be obtained (see Patent, No. 8,307, of 1908). The dry sorel cements deteriorate on exposure to the atmosphere and should therefore be packed in soldered tinned iron vessels.

**Magnesium oxychloride** is one of the strongest cements known. A mixture of 1 part of this cement with 4 parts of sea sand gives a crushing strength of over 8,000 lbs. per square inch. One part of the oxychloride will serve to cement 8 parts of sand. The cement is not appreciably affected by exposure to frost, rain, or occasional flooding, and therefore finds extensive application in the manufacture of artificial stones for building purposes, especially window sills and door-steps, but it is not suitable for stones constantly exposed to water. Owing to its great mechanical strength, this cement is used in the manufacture of abrasive wheels which can be run at a considerable velocity, but such wheels are by no means reliable unless they can be kept quite dry. If employed for wet grinding they soon crack and become dangerous. Silicate cement is not open to this objection (see **Grinding and Polishing Materials**, p. 415). Sorel cement is sometimes employed in the manufacture of **artificial marble** as it is capable of taking a very fine polish.

Many patent flooring compositions contain magnesia cement (see British Patents, Nos. 14,173 and 14,297, of 1906), and a material known as "xylolite" is composed of sawdust united with this cement. In Hamburg a flooring which is much in vogue is made by using magnesium oxychloride to cement sawdust which has been impregnated with oil. Such a floor 1 in. thick costs 8s. per square yard.

The cost of sorel cement is considerably higher than that of Portland cement: during the year 1909 the price of calcined magnesia, its principal ingredient, was \$14 to \$16 per ton at the Californian magnesite deposits and \$13 in Greece, whilst the average price of Portland cement throughout the United States during the same year was \$5 per ton.

## SECTION LXI

# ARTIFICIAL STONE

BY JAMES SHELTON, F.I.C.

### LITERATURE

- MIDDLETON.—“Building Materials.” London, 1905.  
 — “Patent Victoria Stone.” London, 1883.  
 DIBDIN.—“Lime, Mortar, and Cement.” London, 1909.  
 KUHL.—“Chemische Technologie der Neuzert.” 1910, pp. 764-767.  
 FRODE.—“Das Konservieren der Baumaterialien.” Wien, 1910.

ARTIFICIAL stones are produced by cementing together rock fragments such as quarry waste, sand, mining tailings, etc. Because of their relative cheapness and freedom from flaws, these artificial stones compare favourably with the natural product. The size and shape of the blocks can be varied at will, and ornamental stones are now manufactured which equal in appearance the carved natural stone.

There are several kinds of artificial stone, and as they do not readily admit of classification, they may be described briefly as follows:—

**Concrete.**—Under the name of concrete, building stones and paving blocks, steps and window sills are manufactured from a mixture of one part Portland cement with three to nine parts of mineral fragments (or **aggregate**), varying in size from fine sand to large pebbles. Steel rods are often embedded in the material in such a position as to take the tensile stresses, the concrete itself being capable of bearing considerable compression (see **Concrete**, p. 118).

**Victoria stone** is a concrete made of finely crushed granite with a third of its weight of Portland cement. It is usually made from Leicestershire granite which has been washed free from soluble salts, dried, mixed with cement, and the mixture wetted and compressed into moulds. The blocks, when set, are hardened by immersion in a bath of sodium silicate for about a fortnight. Exposure to air effects a further hardening of the blocks, but the hardening is seldom, if ever, complete.

This stone has a crushing strength of over 8,000 lbs. per square inch, and shows a porosity of 1.3 per cent. when immersed for twenty-four hours in water. Iron oxide is often added to impart a red colour to the stone. “Imperial Stone,” “Empire Stone,” and “Indurated Stone” are concretes of a similar nature.

**Ward’s stone** is a concrete composed of oolitic limestone and Portland cement, and is utilised for ornamental stairways. Another variety of stone sold under this name is composed of granite and Portland cement. **Stuart’s granolithic stone** and **Globe granite** are of similar composition.

A concrete made of crushed York stone chippings and Portland cement, hydraulically pressed into moulds, is sold as a paving material under the name of **non-slip stone** (see also Patent, No. 383, of 1902).

**Clinker and Slagblocks.**—In certain districts mixtures of lime with natural puzzuolanic materials, destructor refuse, or granulated blast furnace slag, are utilised for the preparation of building and paving blocks, but they are only used to a limited extent, generally by municipal authorities, or large firms who can find a definite use for them.

**Ford's silicate of lime stone** is produced by pressing a mixture of burnt lime and sand into a perforated mould. The lime is slaked with boiling water and the stone hardened by exposure to superheated steam for a few hours at a pressure of 120 lbs. per square inch.

**Ransome's artificial stone**—one of the earliest of this class of material—is described under **Sodium Silicate** (p. 134).

**Plaster cements** are used as the binding material in many artificial stones and imitation marbles which are very suitable for interior decoration, but are of little use in situations exposed to the weather. The veinings of natural stone are imitated in various ways. A common method is to render plaster slow setting by gauging with size water, and to colour it by the addition of such substances as graphite, pyrolusite, cinnabar, litharge, chromium oxide or zinc white. This mixture is then kneaded together on a glass plate so as to form a paste. For the preparation of **Marezzo marble**, fibrous materials dipped in a cream, or slip of Keene's cement (p. 117), coloured to the tint desired for the veining, are arranged on a glass plate. A thin coat of slip, tinted to the body colour of the marble, is then poured on the plate. The threads are picked out, leaving some of their coloured slip in the place they occupied, and dry Keene's cement is added to absorb the superfluous moisture. A backing of cement is then added to give rigidity to the slab.

According to Czermak (British Patent, No. 9,376, of 1901), marble may be copied in the following manner: A thin slip of coloured plaster is cast on a glass plate. The plaster is allowed to set and is then broken and the fragments separated slightly from each other. Plaster of another colour is then applied so as to fill up the interstices and produce veinings. See also British Patents, Nos. 7,081 and 18,744, of 1901; Patent, No. 17,700, of 1905.

**Scagliola** is the trade name of a stone manufactured from Keene's cement mixed with colouring matters, to which is added water containing dissolved glue or isinglass.

**Sorel cement** is employed for the manufacture of stones of great mechanical strength. Particles of carborundum or corundum cemented with this material form abrasive wheels, but these are not of the best quality (see p. 415). Stone stairways and stair treads are prepared with sorel cement, and in some localities this material is used in the manufacture of building blocks and window sills. Unfortunately, it is not very resistant to the weather.

This cement is sometimes employed as the binding material for artificial marbles, as the cement sets to a hard mass capable of taking a very fine polish. See Patents, Nos. 8,556 and 16,640, of 1901; No. 20,492, of 1902.

Other binding materials utilised in special cases for artificial stones are asphalt, pitch, wax, casein, powdered talc, sulphite cellulose (Patent, No. 11,830, of 1904), etc. A stone may also be prepared by mixing sand with linseed oil and flowers of sulphur. On heating the mixture, vulcanisation takes place and a solid block is produced.

**Reconstructed stone** is manufactured from the debris of limestone quarries. This is crushed, mixed with dolomitic lime, and charged into retorts in which it is heated to 1,000° C. The calcined mixture is then slaked and consolidated in moulds under pressure. The blocks are exposed to the drying action of air at about 40° C. and are placed in steel tanks. The tanks are then closed, the contained air is pumped out, and carbon dioxide, driven off from a further supply of

raw material in the retorts, is pumped into the tanks ; the lime is thus recarbonated, yielding fairly hard blocks.

Blocks of stone similar to marble may be produced by compressing slaked lime and carbonic acid snow into moulds made of fusible metal. If clay is added, a stone suitable for lithographic purposes may be obtained (see Patents, No. 13,467, of 1900, and No. 20,070, of 1905).

**Moreau marble** is prepared by immersing soft amorphous limestone in a bath of zinc sulphate so as to harden it. The limestone blocks are cut to size and stained before immersion. Afterwards they are dried by hot air, and in some cases the blocks themselves are heated.

The material has a crushing strength of over 4,000 lbs. per square inch and, on polishing, gives a surface equal to that produced on natural marble.

**Lime-sand bricks** (p. 223) are sometimes made in larger sizes, and the material is then classed as an artificial stone (see Patent, No. 2,605, of 1906).

**Blast furnace slag** is cast in iron moulds and then allowed to cool slowly in an annealing oven. Bricks so produced make a good paving material. See also "Clinker Bricks" (*ante*).

## SECTION LXII

# SODIUM SILICATE, WATER-GLASS, SOLUBLE GLASS

BY JAMES SHELTON, F.I.C.

### LITERATURE

- BERNHARDT.—“Das Wasserglas.” 1893.  
 FRODE.—“Das Konservieren der Baumaterialien.” Wein, 1910.  
 OST.—“Lehrbuch der Technischen Chemie.” 1911.  
 ORDWAY.—*American Journal of Science*, 1861, 2nd Series, XXXII., 153, 337; 1862, 2nd Series, XXXIII., 27; 1863, 2nd Series, XXXV., 185.  
 BURNELL.—*Journal Society of Arts*, 1860, VIII., 240.

A SOLUTION of sodium carbonate or hydroxide slowly dissolves silica. The rate of solution may be accelerated by boiling under pressure, and this is one of the methods employed for the manufacture of sodium silicate. Flint is commonly used as the source of silica; it is reduced to a fine state of subdivision by heating to redness, then quenched by tipping it into a large mass of water and grinding the cracked mass to a fine powder. In some districts infusorial earth is used instead of silica. The silica powder is digested with caustic soda in an iron boiler for about twelve hours at a pressure of about 60 lbs. per square inch. An almost neutral liquor is thus obtained, and this is concentrated until it has a specific gravity of about 1.7. The syrupy solution containing about 50 per cent. of sodium silicate is put on the market under the names **sodium silicate, water-glass, soluble glass**, etc.

An alternate process involving the fusion of a mixture of silica and sodium salts is also commonly employed. The silica, pulverised as above, is mixed with a little charcoal powder and the sodium carbonate, or sometimes hydroxide or sulphate. The mass is then fused in a reverberatory furnace for about eight hours, at the end of which time it is run off into moulds. The blocks so produced are crushed and then dissolved by boiling with water in closed vessels under pressure.

The composition of the commercial article is shown approximately by the formula  $\text{Na}_2\text{O} \cdot 4\text{SiO}_2$ , but many samples have a greater or less amount of silica than this formula indicates.

A mixed silicate of soda and potash is sometimes prepared, and it is claimed that with an equal percentage of silica this mixture has a greater fluidity than a solution of sodium silicate.

Sodium silicate is decomposed by carbon dioxide, gelatinous silica being deposited, but with bases such as lime and magnesia insoluble silicates are produced. Because of these properties water-glass is largely employed as a cementing material and for reducing the porosity of stones (see Patent, No. 12,980, of 1908). It is also employed as a rust-proof coating for metals, for the preparation of silicated soaps, for impregnating wood or cloth to reduce inflammability, and as a fixing agent for various dyes, especially in stereochromic work. An insulating material for covering



steam-pipes is manufactured by mixing sodium silicate with mica or asbestos and heating the mixture to a bright red heat.

**Ransome's artificial stone** is prepared by mixing sodium silicate with sand, moulding the mixture to shape, and then immersing the product in a solution of calcium chloride. A cement of calcium silicate is thus produced, and the sodium chloride formed is removed (though not completely) by prolonged washing with water. Samples of this stone have attained a crushing strength of 2 tons per square inch. This process, owing to the expense of the skilled labour required, has been discontinued (see also Patents, No. 11,715, of 1901, and No. 1,339, of 1908).

**Uralite** (Patent, No. 6,016, of 1902) is made by compressing asbestos pulp into sheets which are then sprayed with a weak solution of sodium silicate and bicarbonate.

After drying, the sheets are ready for use.

## SECTION LXIII

# LUTES AND MISCELLANEOUS CEMENTS

By GEOFFREY MARTIN, Ph.D., D.Sc.

THE more important cements have been described above in the preceding articles. There remain, however, a considerable number of miscellaneous lutes and cements which are of the greatest possible use to the chemical engineer and works chemist, and a brief account of these will not be out of place here.

**Lutes and Cements to Resist Sulphuric and Nitric Acids.**—(1) Powdered pumice is mixed with silicate of soda solution of 50° Bé. If the lute is required to set hard add a base like red lead, or lime, or magnesium oxide.

(2) A mixture is made of 2 parts of powdered asbestos, 1 part of barium sulphate, and 2 parts of silicate of soda solution of 50° Bé. density if the acids acting on the surface are concentrated, and 130° Bé. if they are dilute. In any case the surface of the cement should be painted with acids.

Another good lute much used for **nitric acid retorts** consists of blue asbestos fibres, blue asbestos powder, sodium silicate solution, together with a little tallow and boiled linseed oil.

(3) A cement which will resist hot nitric acid consists of a mixture of 1 part of asbestos, 1 part of sand, and 2 parts of silicate of soda.

(4) Acid pipes are usually luted with wet blue asbestos fibres, pressed together so as to form a paste or mat, and moistened with sodium silicate solution.

**Lute Proof against Nitric and Hydrochloric Acid Vapour.**—Mix together 1 part resin, 1 part sulphur, 2 parts brick dust. Then melt together.

**Lutes for Chemical Retorts.**—(1) The following is a very ancient one:—Mix together 2 parts of fine lime, 2 parts of fine flour, and 1 part of potter's earth. Beat up the white of egg with an equal bulk of water, and make the solids into a paste with the liquid.

(2) A well-known recipe, which is also used in melting pots, is this:—Mix sifted brick dust with an equal amount of red lead. Rub the mixture with boiled linseed oil and coarse sand to the stiffness of cement. To cover vessels, apply the paste and then dust sand over it.

(3) For large pots use a mixture of 3 parts litharge, 2 parts freshly burnt pulverised lime, 1 part white bole; linseed oil.

(4) Freshly slaked lime is mixed into a concentrated solution of borax. The mixture is applied with a stiff brush and allowed to dry. When heated the cement fuses to a glaze.

See also above under "Lutes and Cements to resist Nitric and Sulphuric Acids."

**Crucible Lutes.**—(1) Powdered clay and brick dust are mixed with a solution of borax in water.

(2) Freshly slaked lime and a concentrated solution of borax are made into a paste and allowed to thoroughly dry after applying.

**Crucible Cements.**—(1) Mix powdered clay and brick dust with water or a solution of borax. With the borax the lute fuses to a compact vitreous mass in the crucible.

(2) 2 parts slaked lime, 2 parts borax, and 1 part of litharge and water are made into a paste.

**Cement for Furnaces.**—Fire-clay, 1 part; burnt fire-clay, 1 part; mixed with sufficient silica of soda to make it plastic.

**Cement to Resist White Heat.**—Plumbago, 1 part; manganese dioxide, 1 part; salt,  $\frac{1}{2}$  part; borax,  $\frac{1}{2}$  part; iron filings, free from iron oxide, 2 parts; pulverised clay, 4 parts. Mix with water to form a thick paste; use immediately, and heat slowly to nearly whiteness.

**Water-Glass, Zinc, and Pyrolusite Cement.**—Mix quickly together 100 parts zinc white, 80 parts pyrolusite, 20 parts water-glass, and apply at once. This cement hardens in a short time, and is adapted for cementing the joints of pipes exposed to a red heat. When fused it forms a glass-like joint of great adhesive power.

**A joint which will resist great heat** is made by mixing asbestos powder into a thick paste with liquid silicate of soda.

**Non-conducting Cement for Covering Boilers and Steam-Pipes.**—Mix together Portland cement, 1 part; flour, 2 parts; sawdust, 4 parts; fine sand, 1 part. Next mix in clay, 4 parts; plasterer's hair,  $\frac{1}{2}$  part. Mix well with water to consistency of mortar, and apply with a trowel to the thickness of 1 in. When dry apply successive coats of 1 in. thickness until a depth of 5-7 in. thickness of composition is applied. Each coat must be dry before the next is applied. Finally, give two to three coats of tar.

Many such compositions are sold, the main basis being asbestos.

**Cement for Fixing Tiles in Fireplaces and Grates.**—Mix equal parts of plaster of Paris, sand, and hair mortar.

**Cement for Fixing Iron Bars into Stone.**—Use a compound of equal parts of pitch and sulphur.

**Cement for Seams and Joints of Stone Cisterns.**—Use 6 parts of powdered brick; 1 part of white lead; 1 part of litharge. Mix to a paste with boiled linseed oil.

**Cement for Steam and Water Joints.**—(1) Powdered litharge, 10 lbs.; plaster of Paris, 4 lbs.; red lead, 2 lbs.; yellow ochre,  $\frac{1}{2}$  lb.; hemp cut into  $\frac{1}{2}$ -in. lengths,  $\frac{1}{2}$  oz. Mix with boiled linseed oil to consistency of putty.

(2) White lead, 10 parts; manganese dioxide, 3 parts; litharge, 1 part. Mix to a putty with boiled linseed oil.

(3) The following is a good cement for faced steam joints:—White lead, 1 part; red lead, 1 part. Mix with linseed oil to a putty. When great heat has to be resisted add 1 part of plumbago to above mixture.

**Cement for Cisterns and Watercourses.**—Mix together powdered burnt clay, 50 parts; powdered fire-brick, 40 parts; litharge, 10 parts. Stir in boiled linseed oil until the mass becomes of the consistency of a paste. Wet with water the parts to be covered before applying.

**Rust Joint Cement for Cast-Iron Cisterns.**—(1) Cast-iron borings, 5 lbs.; powdered sal ammoniac, 1 oz.; flour of sulphur, 2 oz. Mix with water.

(2) A slower acting but better cement consists of cast-iron borings, 6 lbs.; powdered sal ammoniac, 1 oz.; flour of sulphur,  $\frac{1}{2}$  oz. Mix with water.

The weight in pounds of dry iron borings to be used in making a joint is obtained by dividing by five the cubic contents in inches of the joint.

(3) Another much used mixture consists of iron filings, sal ammoniac, and acetic acid. Used for joining together the sections of cast-iron nitric acid stills.

**Enamel Glaze Cement for Coating Iron Pans.**—Flint glass, 130 parts; sodium carbonate, 20.5 parts; boric acid, 12 parts. First dry at 100° C., then heat to redness, and carefully anneal.

**Cement for Marble.**—(1) Fine sand, 20; litharge, 2; dry slaked lime, 1; plaster of Paris, 1. Make into a putty with boiled linseed oil.

(2) **Keene's Marble Cement** consists of baked plaster of Paris, moistened with a saturated solution of alum, recalcined and reduced to powder.

**Cements for Joining Metals and Woods.**—(1) Melt resin and stir into it calcined plaster of Paris until the mass is pasty. Add boiled oil until the paste is thinned somewhat, and apply hot.

(2) Dissolve in boiling water, glue,  $2\frac{1}{4}$  lbs.; gum ammoniacum, 2 oz. Add in small quantities 2 oz. sulphuric acid.

**Cements for Joining Metals to Earthenware.**—Mix together washed fine sand, 20 parts; litharge, 2 parts; powdered quicklime, 1 part; mix with boiled linseed oil, and colour with pigments.

**Cements for Joining Metals to Glass.**—(1) Mix 2 parts of powdered litharge and 1 part of white lead. Then stir this powder into the liquid formed by mixing 3 parts boiled linseed oil with 1 part of copal varnish.

(2) Melt together with stirring on the water bath, copal varnish, 15; drying oil, 5; turpentine, 3. Then add 10 parts slaked lime.

**Turner's Cement.**—Bees' wax, 2 parts; resin, 1 part; pitch, 1 part. Melt together and stir in fine brick dust.

**Cement for Plumbers.**—Black resin, 1 part; brick dust, 2 parts. Melt together.

**Cement for Joining Porcelain Heads to Metal Bars.**—Mix Portland cement with hot glue.

**Cement for Fixing Pyrometers into Furnaces.**—A mixture of litharge and glycerine is much used.

**Composition Insoluble in Benzene and Petroleum.**—Gelatin mixed with glycerine yields a liquid when hot, but which solidifies on cooling, forming a tough elastic material which much resembles indiarubber, and is quite insoluble in petroleum or benzene.

Casks can be made impervious to benzene or petroleum by painting on the inside with this compound.

The material is also used for printers' rollers, and also buffers for stamps.

It should be noted that ordinary soap is insoluble in benzene, and forms a good lute. Therefore also a good lubricant for pumps working benzene, and for threads of screws.

**Joints which will resist benzene** may be made of a mixture of plaster of Paris and hot liquefied glue. Apply hot. Litharge and glycerine also form a good lute.

**Lute for Neck of Bottles with Glass Stoppers.**—Take equal parts of linseed meal and whiting, and make into a stiff paste with water. Apply round stopper.

**Dental Cements.**—(1) 1 part of finest pulverised glass is mixed with 3 parts of calcined zinc oxide (which must be kept in well-stoppered bottles). 1 part of borax is dissolved in the minimum amount of water, and mixed with zinc chloride solution of 1.5 sp. gr., which must also be kept in a well-corked bottle. For use, the powder is mixed with some of the liquid to form a putty, which soon hardens to a stone-like mass. The material is an excellent, tenacious, quick-binding cement.

(2) 5 parts of oxide of zinc, 2 parts silica (silex), 1 part borax, are moistened with a solution of 1 oz. zinc chloride in 6 drachms water. It sets in thirty minutes.

## SECTION LXIV

# CLAYS AND ALLIED MATERIALS

BY ALFRED B. SEARLE

*Analytical and Consulting Chemist, Sheffield*

### LITERATURE

THE literature on clays is very prolific, but most of the information is scattered through scientific and technical journals not readily accessible. The following books will give all the information required by those who are not specialists in clays:—"British Clays, Shales, and Sands," by A. B. Searle; "The Natural History of Clay," by A. B. Searle; "Treatise on Ceramic Industries," by E. Bourry, translated and revised by A. B. Searle; "Clays: their Occurrence and Use," by H. Ries; "The Silicates," by W. and D. Asch, translated and revised by A. B. Searle; "Handbuch der gesammten Tonindustrie," by Bruno Kerl; "Notes on Pottery Clays," by J. Fairie; "Die feuerfesten Tone," by C. Bischof; "Science of Brickmaking," by G. Harris; "Gesammelte Schriften," by H. Seger; "The Clayworker's Handbook," by A. B. Searle.

Most books on applied geology also deal with clays, though usually in a somewhat superficial manner. Further information on clays will be found in the literature listed under such headings as Pottery, Earthenware, Porcelain, Bricks, Tiles, Furnace Linings and Refractory Materials in the present volume.

GEOLOGICALLY, clays are regarded as the product of the action of the weather on granitic (felspathic) rocks, but the term is also applied to most minerals which possess the property of being plastic when mixed with a suitable amount of water. The materials included as "clays" by geologists, therefore, comprise many mixtures of clays and other minerals, and no classification of clays from the geological point of view is wholly satisfactory to those engaged in the industries in which clays are used.

So far as their **chemical constitution** is understood, clays appear to consist essentially of one or more aluminosilicic acids, that is, of complex acids containing silica and alumina combined with the elements of water, the whole forming a definite chemical compound of an acid character.

For many years it has been understood that there is in all clays a certain essential and characteristic material—for which the term "clay substance" is usually employed, but a careful study of the products obtained by purifying various natural clays inevitably leads to the conclusion that the term "clay substance" is not one single chemical compound, but is applicable to a number of different substances, all of which are very closely related to each other. Just as in organic chemistry there is a large class of alcohols (ranging from the simple methyl alcohol to the highly complex sugars and benzene derivatives), so the term "clay substance" covers an enormous number of different substances of the same general properties and closely allied to each other, their chief characteristic being that they are all aluminosilicic acids. It should, however, be observed that the term "clay substance" is used somewhat loosely by some writers, and is often applied to crude clays which cannot be further purified than by the elutriation they have received. Such clays not infrequently contain a considerable proportion of rock flour of a highly siliceous or ferruginous character, together with extremely fine particles of mica and other minerals, which are clearly not of the nature of clay.

Failure to recognise the definite nature of true clays has created an enormous amount of confusion, and the number of erroneous statements in the literature of clays and allied substances is so great that it is exceedingly difficult for the student to know what is true and what is incorrect.

The difficulties experienced in the investigation of the constitution of clays are enormous, and are due quite as much to the stable nature of the "clay molecules" as to the complexity of their constitution. Indeed, it is difficult to find any other group of substances of so definite a character which leads so easily to the drawing of wrong conclusions. Thus, the action of alkalis on clays leads to the conclusion that clays are colloidal in character, and this appears to be confirmed by the

power they possess of adsorbing dyes; yet there is ample evidence to show that the action of alkalis is to form new compounds, and that the adsorption of dyes is not a true adsorption, but a definite chemical combination of the acid (clay) with the dyestuff. In a similar manner, the fact that clays do not melt sharply (like most definite chemical compounds), but over a range of temperature (like mixtures and the so-called "solid solutions"), is often thought to show that clays do not possess a definite character so far as their chemical constitution is concerned. This conclusion overlooks the remarkable resistance of clays to the action of heat and their resultant low conductivity, and it is by no means improbable that the range of fusion they exhibit is due to this resistance and not to their chemical constitution at all.

The difficulty of purifying clays without seriously altering their composition is a source of endless trouble to those who are investigating their nature and properties. The minerals with which all natural clays are contaminated can only be removed to a very limited extent by elutriation and deposition, for the finest particles of rock flour have a specific gravity so close to that of the true clay as to render complete separation by this means impossible. Chemical reagents will not remove these adventitious minerals without simultaneously attacking the clay, nor is any solvent for the clay known which does not either decompose it or attack the impurities present in it. The usual methods of purification by crystallisation are inapplicable, and the formation of soluble or insoluble compounds which can afterwards be reconverted into the original clay has not yet been accomplished. Several investigators have attempted this method of purification, only to find that the clay itself was converted into an isomeric aluminosilicic acid from which the original substance could not be obtained.

Clays behave precisely like other complex, insoluble acids; that is to say, they combine with definite stoichiometric proportions of bases when heated with solutions of the latter, but the "clay molecule" is so complex, and it has so strong a tendency to form isomeric and simpler compounds, that it is exceedingly difficult to separate the aluminosilicates thus obtained. By fusing clays with alkalis or carbonates the complex aluminosilicates formed by the action of solutions appear to be produced, but on treating these with such acids as acetic or hydrochloric acid, the complex salt is decomposed, and on evaporation and gentle ignition all the silica separates out in a free state.

When heated for a long time with concentrated sulphuric acid, clays are converted into soluble aluminosilicic acids with loss of silica, or silica and alumina. Unfortunately the reaction which occurs is so complex that this treatment cannot be made the basis of a method of determining the proportion of true clay in a sample, though it has been erroneously used for this purpose ever since Seger's classical research on the subject more than thirty years ago. Unfortunately, Seger overlooked the fact that the action of the strong sulphuric acid is to effect a partial decomposition of the clay, and the formation of a more stable aluminosilicic acid. The precise acid formed depends on the molecular constitution of the original clay, and where the sample contains free silica, mica, feldspar, and other siliceous minerals, the composition of the portion soluble in the sulphuric acid does not give any clear indication of the composition of the original clay. With very pure clays—such as the finest grades of kaolin or china clay—fairly consistent results are obtained, but even these usually show a larger proportion of free silica than is actually present, and the method is therefore liable to be seriously misleading.

The action of heat on true clays (aluminosilicic acids) is equally complex. At a temperature of about 500° C. the acid is converted into an anhydride with consequent loss of water. As the anhydride is far more stable than the acid, it will readily be understood that on heating to a lower temperature some slight loss of water occurs, but the reaction or dehydration only occurs with appreciable rapidity at temperatures approaching 500° C. and above. The amount of water formed by the decomposition depends upon the particular aluminosilicic acid present; with the best kaolin or china clay it averages about 13 per cent. The anhydride thus formed is far more readily soluble in acids than is the original clay, unless the heating has been carried out at so high a temperature that decomposition or polymerisation occurs, and an insoluble (except in hydrofluoric acid) anhydride is produced. If the temperature is sufficiently high (above 1,200° C. in most cases), and the cooling is carried out under favourable conditions, the decomposed or polymerised anhydride will form crystals which are not readily attacked by hydrofluoric acid, and have a crystalline form and ultimate composition greatly resembling sillimanite ( $\text{Al}_2\text{O}_3 \cdot \text{SiO}_2$ ). Whether these crystals are really sillimanite or whether they are a highly complex aluminosilicic anhydride, in which the alumina and silica are in similar proportions, remains to be proved.

It has been suggested that the action of heat on clay is to decompose it into free silica, free alumina and water, but strong as is the evidence in favour of this theory, that opposed to it appears to be equally so, if not stronger.

From the foregoing statements, it will be understood that the proximate composition of natural clays cannot be ascertained from the results of an ultimate analysis, nor is it possible to state with entire accuracy the mineralogical composition of any clay. The best that can be done is to separate the coarser particles by washing the sample on a sieve with 200 meshes per linear inch, and treating the portion which passes through the sieve in a Schoene's elutriator with a stream of water flowing at the rate of 0.18 mm. per second. This will remove all the clay particles, together with a variable proportion of the finest particles of other minerals.<sup>1</sup> The "clay substance" thus removed must then be analysed in order to ascertain its ultimate composition.

---

<sup>1</sup> If the sample being examined is a shale or indurated clay it will be necessary to disintegrate it by boiling it with water to which a little ammonia has been added.

When the purest clays are examined in this way they approximate to the composition represented by the formula  $H_4Al_2Si_2O_9$ , or as it is commonly but erroneously written,  $Al_2O_3 \cdot 2SiO_2 \cdot 2H_2O$ . This formula has a simplicity which is probably misleading—so far as can be ascertained at the present time it would be more correct if multiplied by six, so as to be represented by  $H_{24}Al_{12}Si_{12}O_{54}$ . If Asch's theory as to the constitution of aluminosilicates is correct, and the evidence in its favour is very extensive—clays are ring compounds analogous to those of the aromatic series in organic chemistry, and contain the aluminium and silicon atoms arranged in groups or rings, each containing five or six atoms, whilst the hydrogen atoms, and some of the oxygen ones, are in the form of side chains. The number of possible compounds corresponding to this formula, and to such variations of it as may readily be conceived, is exceedingly large, and as each different type may be further modified by the replacement of some of the OH-groups by OK- or OCa-groups, etc., it will readily be understood that the number of theoreticaly possible clays is almost beyond the limits of enumeration. The chief types of clay formulæ are the following:—

[In each case,  $\hat{Si} = 6Si(OH)_4$ ,  $\bar{Si} = 5Si(OH)_4$ ,  $\hat{R} = 6R(OH)_3$ ,  $\bar{R} = 5R(OH)_3$ ,]

- (a)  $\hat{Si} \cdot \hat{R} \cdot \hat{Si}$ ,
- (b)  $\bar{Si} \cdot \hat{R} \cdot \bar{Si}$ ,
- (c)  $\begin{array}{c} \hat{Si} \\ \diagdown \quad \diagup \\ \hat{R} \quad \hat{Si} \\ \diagup \quad \diagdown \\ \hat{Si} \end{array}$
- (d)  $\begin{array}{c} \hat{Si} \\ \diagdown \quad \diagup \\ \hat{R} \quad \bar{Si} \\ \diagup \quad \diagdown \\ \bar{Si} \end{array}$
- (e)  $\hat{Si} \cdot \hat{R} \cdot \hat{R} \cdot \hat{Si}$ ,
- (f)  $\hat{Si} \cdot \bar{R} \cdot \bar{R} \cdot \hat{Si}$ ,
- (g)  $\hat{Si} \cdot \hat{R} \cdot \hat{Si} \cdot \hat{R} \cdot \hat{Si}$ ,
- (h)  $\bar{Si} \cdot \hat{R} \cdot \hat{Si} \cdot \hat{R} \cdot \bar{Si}$ ,
- (i)  $\hat{Si} \cdot \bar{R} \cdot \hat{Si} \cdot \bar{R} \cdot \hat{Si}$ .

The foregoing formulæ show a higher proportion of water than is found in some clays of the same alumina-silica ratio; this is due to the replacement of some of the hydroxyl groups by alkali or alkaline earth hydrates, as already explained, and partly to the fact that clays easily lose some of their hydroxyl groups and form anhydrides in which the relationship of the aluminium and silicon atoms is not affected, the elements forming the water set free being liberated from the outside of the rings. Where the whole of the hydroxyl is present in a clay, its formula shows all the valencies to be satisfied. Thus, the clay *e* (above) would be represented briefly by  $(\hat{Si} \cdot \hat{R} \cdot \hat{R} \cdot \hat{Si}) (HO_{20})$ , or if shown fully, by

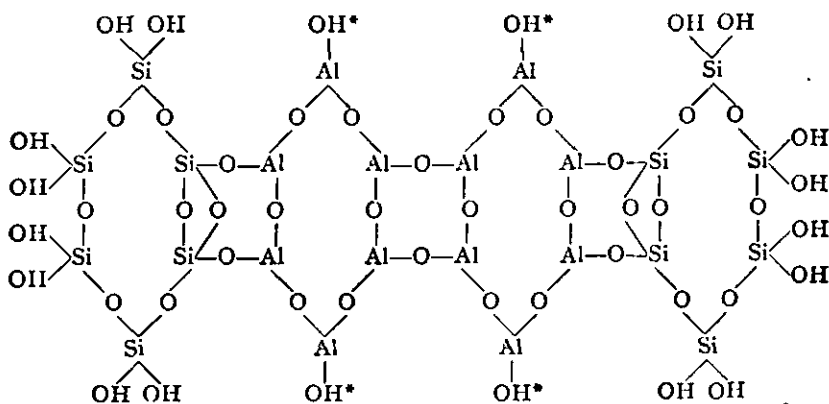

As no perfectly pure clays are found in nature, these formulæ are modified by the inclusion of bases present in combination with the clay and replacing the OH-groups marked with an asterisk by OK or by OCa. The proportion of basic and alkaline oxides in the purer clays is, however, so small that they may generally be neglected in classifying these clays according to their composition. In less pure clays there is so great a difficulty in preparing pure samples of the aluminosilicic acid present that any attempt at the allocation of a formula is little more than guess-work, supported by a large amount of evidence which it is difficult to apply with accuracy.

Thus, the ordinary brick clays of commerce produce bricks of a characteristic red colour when burned, and it is usually considered that this red colour is due to the presence of free ferric oxide in the original clay. Yet the evidence as regards the chemical constitution of the raw clay is that it contains ring compounds of both iron and alumina, which are of a yellowish or grey colour

according to their composition, and, in accordance with this evidence, the red colour of the burned bricks may be due either to a decomposition of the complex ferro-aluminosilic acid (clay) with the formation of free ferric oxide or of a complex anhydride of a reddish colour. At present there is not sufficient data to decide which of these two compounds is present; indeed, it is not improbable that in some burned clays they may both exist simultaneously.

The **plasticity** of clays is almost as complex as their constitution, and though many theories have been published concerning the cause of it, none of them are entirely satisfactory.

That plasticity is an inherent property of the clay molecule and a characteristic of aluminosilic acids, seems to be unquestionable, though the production of some amount of plasticity (or what is regarded as such) in very fine powders of various substances seems to throw some doubt on the statement just made. When an attempt is made to define plasticity in such terms as will render its measurement possible, it is soon found that this property is not of an elementary nature, but that it unites within itself such properties as cohesion, adhesion, elasticity, tensile strength, etc., and that any basis of measurement of the plasticity of a clay paste must include all these properties, and possibly some others. For this reason, any attempt to measure plasticity in terms of water or dyes absorbed, tensile strength, or linear extension when subjected to measured tensions, must prove incomplete, and the suggestion of Zschokke, amplified by Rasenow, to express plasticity in terms of the water required, multiplied by the percentage of linear extension, and the product multiplied by the tensile strength, is by no means as reliable as is desirable. At the same time it forms the best means of measuring the plasticity hitherto suggested. The suggestion of Ashley, that the plasticity of clay may be expressed in terms of the percentage of dye adsorbed, does not place a series of clays in the same order of relative plasticity as would agree with the experience of practical potters, and appears to be unreliable.

Apart from all questions of measurement, plasticity may be defined as that inherent force which permits a substance to be altered in shape with the application of only a small force, the new shape being retained when the force no longer acts upon the material. In practice, an experienced potter, or other clayworker, will ascertain the relative plasticity of a number of clays by "feeling" them, but this method does not appear to be susceptible of accurate measurement.

The various theories relating to plasticity, together with much other information on this very interesting property of clays, will be found in some of the books mentioned in the list on p. 139.

The **shrinkage** which articles made of clay paste undergo when allowed to dry is another characteristic property of most clays.

When a highly plastic clay is moulded and allowed to dry, the shrinkage is often so great that the piece is unable to withstand the internal strains produced and cracks into a number of smaller pieces. In very pronounced cases it may fall to a powdery mass. If the drying be carried out rapidly (especially with the aid of heat) the strains will be all the more intense, and it will be impossible to keep the goods whole. If, on the contrary, the drying is effected with extreme slowness, and care is taken to avoid irregular drying and draughts, it will not be difficult to obtain sound goods. The slow drying and the accompanying precautions are, however, so tedious as to make such "tender" clays of little commercial value, unless they can be treated with some non-plastic material. Thus, the addition of sand before making the clay into a paste, will reduce its tendency to shrink, and will consequently stop the cracking and disintegration. There is a limit to the proportion of sand which can be added; this limit is characteristic of each individual clay, and must therefore be ascertained by actual trial. There are large areas of valuable brick clays in the South of England which are quite useless commercially, because they are too plastic, and shrink too much. If sand could be added to them in reasonable proportions, such clays would be very useful, but the absence of sand in the localities in which these clays occur, and the cost of taking it to them being prohibitive, the clays must remain unused until some other method of reducing shrinkage has been found. Heating the clay to a temperature of 200°C. will effect a result similar to that of adding sand, but the cost of this treatment is prohibitive for ordinary brick and tile clays.

All colloidal substances have a characteristic shrinkage, and there is good reason to suppose that the suggestion of Schloesing—revived more recently by Rohland—that clays contain considerable proportions of colloidal matter is correct.

At the same time, the constitution of clays is such that it is impossible to be certain about this, as the evidence of a colloidal structure is far from complete, and may be capable of quite a different interpretation.

What appears to take place in the drying of a plastic clay is that the particles are at first separated by a film of water; as this evaporates, the particles draw closer



to each other until they are in intimate contact. This may occur before all the water has been evaporated, for there are still some pores in the mass even when the particles are as close together as they can be.

If clay is a colloidal material, a somewhat different explanation may be given; all colloids swell when exposed to water, and absorb a considerable quantity of it in the process. The action of dry glue when soaked in water is typical. On again drying the swollen colloidal mass, the water evaporates, and the solid particles draw nearer together, until finally a hard dry substance is produced. As colloids, like clays, appear to be complexes of very high molecular weight, the relationship between the two is interesting in many ways.

The practical difficulties which arise in the manipulation of clays in consequence of the shrinkage are numerous and complicated; they are described in the works named on p. 139.

The **impurities** in clays are chiefly of a mineral character and are due to the origin of the clay.

As already stated, clays are primarily formed by the decomposition of felspar and other aluminosilicates (these minerals being the salts, and clays the corresponding or derived acids), and when first formed are associated with numerous other minerals. The remarkable smallness of the particles of clay soon causes them to be removed by the action of water, and as the stream enters a lake or has its speed of flow reduced by some other means, the clay particles are deposited and a secondary clay is formed. Some clays have been gathered up by water and deposited again and again, and are now found many miles from the place of their original formation.

In the course of their travels clays may become associated with many kinds of mineral and vegetable impurities, the most important of which are stones, sand, rock flour and silt, and vegetable matter derived from living or decomposed plants. The coarser particles may be separated by washing in a slow stream of water as already described, but the finest particles and much of the matter of vegetable origin cannot be removed in this way, but must enter into the composition of the material of which the bricks, pots or other goods are made. The organic (vegetable) matter is removed when the goods are burned in the kiln, but its presence in the earlier stages of the burning often has a marked effect on the colour of the goods, as it exercises a strong reducing action on some of the oxides to which the clays owe their colour.

A process invented by Graf von Schwerin for the purification of clays consists in the subjection of a clay slip to the action of an electric current. Many of these impurities remain behind whilst the purified clay collects in a sheet at the cathode and is removed by a scraper. This method has been "pushed" vigorously recently, but has not proved sufficiently attractive in practice for any well-known firms to adopt it. Moreover, its limitations are very great and preclude its use in many cases. More recently, the addition of ammonia or some other electrolyte followed by a process of centrifugal grading has been successful.

To describe the effects of all the impurities in clays would necessitate a small volume, and as they have been dealt with in some of the volumes mentioned on p. 139, there is no need to do more than indicate the most important ones very briefly here.

Impurities containing soda, potash, lime, magnesia or other similar oxides or carbonates combine with the clay at temperatures above 700° C. and produce aluminosilicates, which are more readily fusible than the clay itself. Hence, if a clay containing these impurities is heated sufficiently, a temperature will be reached at which some fusion will occur, the fused mass filling up some of the pores in the material. As the mass cools it will be found to be much stronger than if it had not been heated so intensely, for the fused, glassy matter will have bound the other particles together with great firmness. If the heating be continued at a still higher temperature, a point will be reached at which the mass has undergone so much fusion as to begin to lose its shape; this is the point of maximum practicable strength, or, as it is usually termed, the point of complete vitrification. It is the point aimed at, but purposely never reached, by makers of engineering bricks, porcelain and other impervious ware. If the heating is carried beyond this point a fusion of the whole mass occurs and the articles are irretrievably spoiled. Any substance which facilitates this fusion is termed a **flux**, and as this property is possessed by most metallic oxides and carbonates and by many sulphates and chlorides, a large number of the impurities in clay are fluxes.

**Limestone** is an impurity which is very common in boulder clays, and its presence is very inconvenient, especially in the manufacture of bricks. The

difficulties caused by it may, however, be overcome by fine grinding and burning at a proper temperature. **Chalk**, on the contrary, is often added to clay to reduce the shrinkage and to increase the binding power.

**Sand** is a convenient term which includes all small mineral particles, no matter what their composition. Hence the action of sand on clay is complex. Fortunately most sands are composed chiefly of silica, and may largely be regarded as impure forms of this oxide. The first action of sand on clay is to reduce its plasticity and shrinkage, and its presence is therefore a desideratum in many cases.

If coarse, sand prevents the clay from being used for work requiring a very fine finish, but this coarse sand can usually be removed by treating the clay in a wash mill. In the kiln, the sand may combine with some of the fluxes previously mentioned, and as simple silicates are usually more fusible than the more complex ones, the presence of sand may bring about an early vitrification of the material, and give it an undesirably low fusing point. At the same time, sand is, of itself, a refractory material, though not so resistant as pure clay, and the addition of it to a fusible clay will increase the heat resistance of the latter. On the other hand, the addition of sand to a pure clay will lower the fusing point of the clay.

The **metallic oxides and silicates** contained in clays in the form of sand or rock dust behave like the impurities just mentioned, and reduce the shrinkage and the resistance of the material to heat. At the same time they may determine the colour of the burned material.

Thus, clays containing more than 3 per cent. of iron oxide or its equivalent will usually burn red, but if reducing conditions prevail in the kiln, a dark grey (technically regarded as "blue") or a black mass will be produced from such clays. The action of each of the metallic oxides and silicates cannot be described here. Readers desiring it will find further information in the books mentioned on p. 139.

## CLAYS OF COMMERCIAL IMPORTANCE

The following clays are of considerable technical importance. More information concerning them, together with a more complete list of valuable clays, is given in "British Clays, Shales, and Sands," by A. B. Searle.

**Adobe clay** is a silty clay which is used in some countries, notably Spain and South America, for the erection of walls of dried mud. It is seldom used in Great Britain.

**Alluvial clay** is used for brickmaking in localities where no more suitable clay is obtainable; its irregular composition prevents it from being of great value.

**Alum shales** are indurated clays from which alum is obtained. The sulphides in the clay are oxidised by exposure to the air or roasting, and the sulphates produced are washed out, the solution being evaporated until the crystallisation stage is reached.

Any clay or shale sufficiently rich in pyrites or other readily oxidisable sulphide may be used for the production of alum. (See the **Alum Industry**, p. 54.)

**Ball clays** are relatively pure white-burning clays which are characterised by their great plasticity. The term is used to include clays differing greatly in quality and composition, many ball clays burning to a light brown colour instead of white. British ball clays are characterised by the relatively low temperature at which vitrification (p. 143) occurs, though the mass does not begin to lose its shape until a temperature beyond the usual working limits of the kilns used by potters is reached. This property, combined with the high degree of plasticity, makes ball clays extremely valuable for the manufacture of earthenware and stoneware (*q.v.*).

By the judicious use of white-burning non-plastic ingredients and of minute quantities of cobalt oxide, the potter is able to neutralise the colour of the burned ball clay and to produce a ware of sufficient whiteness. For stoneware, the vitrification which occurs on heating ball clays produces a mass of great strength and imperviousness to liquids; the colour of the product is regarded as of

minor importance. The most valuable deposits of ball clay in the British Isles are in Dorset and Devonshire.

**Boulder clay** is a term used by geologists to distinguish the clays deposited by glacial action. Broadly speaking, the boulder clay extends over the whole of northern England and over much of the Midlands and Ireland, but much of it is quite useless owing to the stones and sand deposited with it. The cleaner portions of the boulder clay are used for the manufacture of bricks and roofing tiles, and in a few isolated cases coarse glazed pottery is made from it.

The stones and gravel which are a characteristic feature of this clay may be removed by screening or washing, or they may be crushed to powder; the former method is the more effective but the latter is cheaper and for common bricks gives a useful product, provided that limestone is not present in large proportion.

The limestone becomes converted into lime in the kiln, and when the bricks are exposed to the air, the lime hydrates and expands, cracking the bricks or breaking them to pieces. The only remedy consists in either removing the limestone, as indicated, or in grinding it so fine and heating the bricks to such a temperature that the lime enters into combination with the clay, forming a glassy compound which does not expand appreciably on exposure.

**Brick clays and brick earths** are those specially suitable for the manufacture of bricks, though the latter term is usually confined to superficial clays which are suitable for hard-made bricks and is specially used in connection with certain clays in the London Basin.

For brickmaking, a clay or earth must contain sufficient sand to reduce the shrinkage in drying and burning to within reasonable limits (usually about 1 in. per linear foot), as otherwise the clay will crack or twist unduly. To mix sand with a highly plastic clay necessitates the use of powerful machinery or the expenditure of much time and labour, so that those clays pre-eminently suited for brickmaking are the ones which naturally contain sufficient sand, and would be more correctly termed loams than clays.

The chief characteristics required in a brick earth are moderate shrinkage, great strength when burned, and good colour when taken out of the kiln. If these requirements are satisfied, the composition and other properties may be regarded as of secondary importance.

**Cement clays** are those specially suitable for the manufacture of Portland cement and similar substances (see p. 87). They must be very siliceous, but free from more than a very small percentage of magnesia. High class shales are generally used for the purpose, as plasticity is of no importance, and is, in fact, an objectionable property.

The cement works on the Thames and Medway use alluvial mud which is mixed with chalk, but in Cambridgeshire a naturally occurring mixture of clay and chalk (Marl) is preferred.

**China clay** is a white burning clay of low plasticity which is usually found close to the place of its original formation by the decomposition of igneous rocks. The only deposits of importance in Great Britain are in Cornwall, though small quantities are found in other localities. The term *kaolin*<sup>1</sup> refers to any clays having the general characteristics of china clay, quite independently of their origin, so that unless care is taken, confusion may easily arise. When separated from the coarser rock particles, by washing, china clay and the purer kaolins contain about 90 per cent. of true clay and, so far as composition is concerned, a carefully selected and refined china clay approaches more nearly to a pure clay than any other clay known. Such a clay is exceedingly resistant to heat (corresponding to Seger cone 34 which has a softening point of 1,750° C.) but its low plasticity prevents it being used for many purposes for which the somewhat less pure, but highly plastic, ball clays are eminently useful.

China clays and kaolins are used in the manufacture of porcelain (p. 183) and owe their name to the fact that they are the chief clay used in the manufacture of china ware (p. 185). Still larger quantities are used in the manufacture of paper, and the very finest qualities are used for the manufacture of ultramarine. In the manufacture of earthenware, china clay gives an added whiteness to the body, whilst being more plastic than flint—the other agent used for the same purpose.

<sup>1</sup> See also Sections LXV., LXVI., and LXVII.

**Crucible clays** are selected fire-clays, mixed with burned fire-clay or grog and sometimes with 3-30 per cent. of plumbago or blacklead to increase their resistance to sudden changes in temperature, and to secure more complete reducing conditions when melting metals and reducing ores. The quality of a crucible depends very largely on the mixture employed having the requisite characteristics, and it is seldom that good crucibles of large size can be made from a single clay.

It is customary to use several clays of similar origin, but of slightly different properties, the low cost of a local fire-clay (where such is obtainable) causing it to be used in some instances even when better crucibles could be made by substituting a slightly more expensive clay. The mixtures used vary with the purposes for which the crucibles are to be employed, and the temperatures to which they are to be heated. It is therefore useless giving special recipes here, as each crucible manufacturer has to adapt his mixtures to the needs of his various customers.

**Fire-clays** are those which have a notable resistance to the action of heat. It is not customary to include clays under this term unless they are at least as resistant as Seger cone 26 ( $1,580^{\circ}$  C.).

The fire-clays occur chiefly in the coal-fields and in close association with coal, the most famous being those near Stourbridge, around Leeds and in Yorkshire generally, and the fire-clays in West Scotland, of which Glenboig is commonly regarded as typical. For export purposes the fire-clays in the Northumbrian and Durham coal-fields are particularly well known. Other deposits of fire-clay occur in other localities and have a local reputation, especially in Derbyshire and Wales.

Apart from resistance to heat, the most important characteristic of fire-clays is the production of goods devoid of shrinkage with sufficient resistance to abrasion and corrosion and of accurate shape.

**Fuller's earth** is a term applied to any earthy matter which will act as a grease absorbent, but true fuller's earth is not unlike a china clay, though it differs from the latter in several respects, notably in composition, being more allied to a marl.

Careful analyses suggest that fuller's earth is related to the clays, but does not correspond exactly to any one of them. The most important deposits occur in Surrey, Kent, and Bedfordshire. At the present time, large quantities of china clay are sold as fuller's earth, especially for toilet purposes.

**Ganister** is a rocky mineral with a composition corresponding to a pure silica mixed with about one-tenth of its weight of clay. It is used in the manufacture of siliceous fire-bricks (p. 223) and for lining furnaces.

**Grog** is a burned clay which is added to raw clay to reduce the shrinkage of the latter. In refractory wares it also serves as a skeleton which preserves the general shape of the articles in the kiln. Its properties vary with the clay from which it has been made by simple calcination.

**Kaolinite** is not a clay in the usual sense of the term, but a crystalline mineral of the same composition as the purest clays (kaolins) yet isolated, viz.,  $H_4Al_2Si_2O_9$ .

It has, for this reason, been regarded as the essential constituent of all clays, but this is improbable. For reasons already given, clays appear to form an important branch of the aluminosilicic acids, but it is clear that there may be a number of aluminosilicic acids which do not possess the characteristic properties of clays. Kaolinite appears to be one of these acids. The conditions which occur in the formation of clay are not favourable to crystallisation, so that kaolinite appears as a rare constituent in clays; at the same time its general properties are such as to make it resemble very closely the purest china clays obtainable, though it is not plastic.

**Loams** are natural mixtures of clay and sand, and are useful for the manufacture of bricks, tiles, and similar articles. They play an important part in agriculture.

**Marls** are natural mixtures of clay and chalk, and are specially suitable for the manufacture of cements and for certain kinds of bricks.

Many of the stock bricks used in London are made of artificial marls or malms, prepared by mixing chalk and clay together with water in a wash-mill. The term marl is also applied to friable earths which are devoid of chalk, as in Staffordshire, where the so-called marls used for the famous blue engineering bricks are clays occurring in the Upper Coal Measures.

**Pipeclay** is primarily any clay suitable for the manufacture of clay tobacco pipes, but it is now applied to all whitish clays.

It occurs in small quantities in many localities, but the chief deposits are in Devonshire and North Derbyshire.

**Puddling clay** is any plastic clay which will form a waterproof backing or lining to a reservoir or similar structure.

It is important that puddling clays shall dry without cracking, and if very plastic they must usually be mixed with sufficient sand to prevent this defect.

**Red-burning clays** are those which are red in colour after being heated to 800° C. or above. They are chiefly used in the manufacture of bricks, tiles and terra-cotta. The colour is due to iron compounds, the precise nature of which has not been satisfactorily explained. The composition varies within wide limits, and even the percentage of iron present appears to bear no simple ratio to the intensity of the colour produced.

The best red-burning clays are the Midland marls, the Welsh clays typified by Ruabon, and the Lancashire clays typified by Accrington, but such excellent red-burning clays can be found in other parts of the country that it is probably more correct to say that the localities mentioned owe their reputation rather to the size of the works and the skill of the men engaged in them than to any very exceptional quality in the clays themselves.

In the production of terra-cotta, bricks and tiles from red-burning clays, the chief requisites are uniformity of colour, quality of colour, strength or resistance to crushing, and accuracy of shape. **Slowness of heating**, combined with an ample supply of air, is the chief means of obtaining a good red colour; if the temperature rises too rapidly, and there is a lack of air, the iron compounds in the clay become reduced to the ferrous state and then rapidly combine with the clay, forming vitrified and slag-like compounds of a dark blue, grey or black appearance. Usually these darker tones are more abundant near the centre of the bricks, and are then known as **hearts** or **cores**; if very extensive, the gases produced in connection with these cores will cause the bricks to swell, and will give them a partially molten appearance, rendering them almost useless for structural work. If the heating is effected very slowly, and sufficient air enters the pores of the bricks or other articles, the iron compounds will remain oxidised, even when any carbonaceous matter in the clay is being burnt out, and the bricks will retain their true shape, and will have the desired colour. As slow heating is expensive, the tendency of all brickmakers is to hurry the heating, but in proportion as they do so with close textured clays, so do they increase the risk of dark coloured and swollen goods. If the plasticity of the clay is sufficiently great for sand to be mixed with it, this will open the pores and so shorten the time required for the heat and air to penetrate the bricks. The proportion of sand which can be added is, however, limited, as it depends on the binding power of the clay. An excess of sand will make the bricks so soft that they can be rubbed to pieces by rubbing them against one another. For the erection of specially shaped arches, such soft bricks are made on purpose, and are termed **rubbers**.

Many attempts have been made to improve the colour of red-burning clays by the addition of red oxide of iron; such attempts usually end in failure, as the colouring matter must be in a far finer state of division than commercial iron oxide, and it must be distributed throughout the clay in a far more uniform manner than is possible with an ordinary mixer. The addition of ochreous clays is more satisfactory, but is too costly, and the only means of making a poor-looking clay into a good red brick is to apply a dip or cream, composed of good clay and water, to the defective brick before it enters the kiln. If the composition of the dip is correctly adjusted, the bricks will then have a good red exterior; inside they will, of course, be as unpleasant as before, but this will not matter so long as the bricks are not chipped or broken.

**Refractory clays** have been described under **Fire-clays** (p. 146).

**Sagger clays** are fire-clays specially suitable for making cases or sagers in which pottery is placed when in the kiln or oven.

The requirements of a sagger clay are similar to those of a crucible, but as the sagers are

usually much larger and shallower, it is even more important that they should not lose their shape when heated. The best saggars are made of a mixture of fire-clay and grog.

**Shales** are indurated clays which have lost their original texture, and have become hardened into a stony mass, the chief characteristic of which is the curious laminations of which it is composed.

Many shales are so siliceous as to be almost devoid of clay, but the clay shales as a whole are excellent brickmaking materials. They require to be ground to powder before use; this grinding reduces them to something like their original condition, so that when the ground shale is mixed with water it becomes plastic. Some shales are almost as refractory as fire-clays, but the majority of British clay shales produce ordinary red or buff bricks.

**Oil shales** contain a sufficient proportion of bituminous matter to permit oil to be distilled from them in commercially profitable quantities (see **Martin's "Industrial Chemistry: Organic"**). Some of the richer shales produce no less than 40 galls. of crude oil per ton of shale.

**Alum shales** have already been described (p. 144).

**Slates** are hard clayey rocks, often very dark in colour on account of the carbonaceous matter present, and may be regarded as shales which have been subjected to some amount of heating.

They are extensively used as a roofing material, and the refuse from the slate quarries is occasionally ground and used for the manufacture of bricks. Its hardness and lack of plasticity are, however, against its use for this purpose in most localities, and it may be regarded as of little value.

The chief British slates occur in the Lake District, Wales, and in various parts of West Scotland and Ireland.

**Soils** are essentially mixtures of clay and sand, but calcareous soils or marls (p. 146) are also of importance in agriculture.

The composition of soils varies very greatly, and in spite of the vast amount of research carried out on the subject, there is still but little known as to what really constitute the desirable qualities of soils for many crops. The productiveness of a soil appears to depend on its porosity or means of introducing air and water to the roots of the plant, and on the proportion of soluble salts contained in it in a form in which they are useful to the crops. As these soluble salts are removed the soil becomes impoverished, and its food-content must be renewed by the addition of fertilisers and manures. The decay of vegetable and animal matter in the soil induces acidity which must be neutralised by the addition of lime, but the subject of lime fertilisers is too complex to be dealt with here. Most virgin soils are too heavy to be used without some preparation, and must therefore be broken up mechanically. Many soils must also be made more porous by the addition of non-plastic matter such as chalk, sand or lightly burned clay. For further information on soils, the reader should consult some of the many excellent text-books on the subject of agriculture.

**Surface clays** are those which occur on the surface of the ground or immediately below the soil.

They vary enormously in character according to their origin and mode of deposition, and in some localities are weak and sandy, whilst in others they are strong, tough, and highly plastic. The latter are useless for manufacturing purposes unless a suitable sand is available, and a mixture of sand and clay can be made at a sufficiently low cost.

**Tender clays** are usually highly plastic, and consequently they cannot be used for the manufacture of bricks or pottery without the addition of some non-plastic material.

They are termed "tender" because when ordinary methods of manufacture are used, these clays crack or twist, or otherwise cause trouble on account of their apparent inability to withstand the ordinary treatment. This tenderness may usually be overcome by the addition of a suitable material, but the effect of this addition is, usually, to change the properties of the clay to such an extent as to make it unsuitable for the purposes for which it was proposed to use it. Thus, many tender clays burn to a delightful colour, but the addition of sand converts them into very "ordinary" bricks, and the specially attractive colour is lost. Where such special characteristics are to be retained, the services of an expert in clay working must be requisitioned, for the recent advances in this direction are beyond the powers of the average brick maker, machine manufacturer or kiln builder. With the right treatment, it is now possible to retain almost all the good qualities of tender clays and to overcome their tenderness.

**Vitrifiable clays** are those which are impervious to water after they have been burned in a kiln or oven. This imperviousness is valuable in itself as enabling articles of such clays to be used for containing liquids of various kinds, without the necessity of using glazed ware, but the vitrifiable clays are chiefly valued on account of the strength of the ware made from them. If a pure clay is heated it remains porous until a temperature beyond the reach of commercial kilns is reached, when it gradually melts and loses its shape. With a vitrifiable clay, on the contrary, there is a sufficient proportion of fluxing material present for some of the constituents of the clay to commence to fuse at a dull red heat. As the temperature rises more and more fused matter is produced, and this gradually fills the pores in the clayey mass. Finally, a stage is reached when all the pores are filled, and if the heating is continued still further the mass will lose its shape. In some cases the corrosive action of the fused constituents is so great that the mass loses its shape even before all the pores are filled; such clays are less valuable for commercial purposes.

The best vitrifiable clays (so far as British clays are concerned) are the ball clays occurring in Dorset and Devonshire, but artificial mixtures are frequently made by the judicious use of fire-clay and felspar or some other suitable flux. Lime compounds are undesirable for this purpose, as they are too violent in reaction, and bring about a premature loss of shape. Magnesia compounds, on the contrary, give a long range of vitrification, and produce impermeable wares at a temperature considerably below that at which loss of shape occurs.

The vitrified mass produced when vitrifiable clays are burned at a suitable temperature consists essentially of a skeleton of refractory clay, the particles of which are bound together by a glassy magma formed of the fused constituents. Bricks and other articles made of clay must usually contain some vitrified matter, as without it they would be so weak as to be useless, but the term "vitrified" is usually restricted to those articles which do not absorb more than 1 per cent. of water on immersion for twenty-four hours. The enormous resistance to crushing which is so characteristic of blue bricks is due to the large proportion of vitrified material in them, this material being increased by the reducing conditions under which such bricks are burned. As previously explained, the ferric compounds in a brick heated under oxidising conditions only act as colouring agents, but in a reducing atmosphere the ferrous compounds form a vitrified mass with a long range of vitrification, and yield a material which is fully as valuable as magnesia for this purpose.

**Yellow or Buff-Burning Clays** are usually fire-clays, but some vitrifiable clays in the Midlands produce yellow bricks, and some mixtures of red-burning clay and chalk used for bricks in various parts of the South of England produce bricks which are of a pale primrose tint.

Ordinarily a clay which has more than 3 per cent. of iron (expressed as ferric oxide) will produce red or terra-cotta ware when burned, but if a sufficient proportion of calcium carbonate is present or is added in the form of chalk, this will combine with the iron and clay and will form a white brick, a yellow tinge being produced if the lime has not combined with all the iron. Clays with less than 3 per cent. of iron as ferric oxide will, if sufficient true clay be present, burn to a buff or primrose colour, but if much fluxing material is present a dark-coloured brick may be produced.

## ANALYSIS OF CLAYS

From what has been stated on previous pages, it will be understood that the published analyses of clays are of minor value, inasmuch as most of them are very incomplete. To omit an actual determination of the "alkalis" (potash and soda compounds) and to fill in the blank thus caused by deducting the sum of the other constituents determined, is almost unpardonable, for a difference of only  $\frac{1}{4}$  per cent. in the amount of alkalis present will make all the difference when a selection is to be made between two clays of similar composition, or where a clay of exceptionally high resistance to heat is needed. In most published analyses all that is shown is the relative proportions of alumina and silica with those of such oxides as iron, lime, and magnesia. For non-refractory clays this information tells little or nothing of value; for refractory clays it is almost useless unless an accurate statement of the percentage of potash and soda is also present. There is little information to be derived from an analysis which cannot be known equally well by determining the fusing point of the clay (relative to Seger cones), and from the appearance of the raw and fired samples, and analysis is only of value in comparing clays where the composition must be known with considerable accuracy in order to make the necessary adjustment of the

mixtures used in porcelain or earthenware bodies. For most purposes for which analyses of clays are made, however, it would be better first to examine the clay in the manner indicated above and to leave the analysis to a later stage in the investigation. By this means many unsuitable clays can be sorted out at a small cost, whereas an analysis, if it is to be of any value, is a tedious and costly piece of work. Some of the precautions required are stated in J. W. Mellor's "Quantitative Inorganic Analysis" (London, 1913).

In various text-books a method is described which purports to show how clay may be separated from the other constituents of a mixture. This consists in treating the clay with hot sulphuric acid, which is supposed to dissolve the clay and to leave felspar, mica, and other associated minerals (sand) unattacked. Seger devoted much attention to this process, and with a limited number of kaolins it yielded useful but erroneous results. The reason for this has already been explained on p. 140. There is, at the present time, no definite means of ascertaining accurately the proportion of "true clay" in a sample, and the best that can be done is to eliminate other coarser particles by careful washing or elutriation, and then to make an analysis and microscopical examination of the finest particles. As few other substances are so finely divided as clay, this method gives results which are more accurate than would generally be supposed. An analysis of a clay may be expressed in terms better understood by the average man by recalculating the "ultimate analysis" of the finest particles into clay, felspar or mica, and free silica, on the basis that all the lime, magnesia, and alkalis are in the form of felspar or mica, the remainder of the alumina and a proportionate quantity of silica are in the form of kaolinite or other clay of the same composition; any silica then left over being regarded as present in the free state. This calculation, which is purely empirical, and is open to numerous objections, is, at present, the nearest approach to a proximate analysis of clay which has yet been devised. If taken in conjunction with a microscopical and petrological examination of the clay it will give results which are at least intelligible to the clay-worker, even though not of the highest scientific value. The serious error in such a method lies in the assumption that the true clay actually present is of the same composition as kaolinite; in reality many aluminosilicic acids (especially those in fire-clays) appear to be richer in silica. The error caused by understating the clay and overstating the free silica does not, however, prove serious in practice. In some cases the assumption that the oxides are present as mica or felspar is more serious, but with the present state of knowledge it is difficult to avoid this error. There is a large field for research with a view of finding some substance of definite characteristics (especially insolubility or solubility), synthesisable from the various aluminosilicic acids in a quantitative manner. The present writer has examined a large number of likely compounds, but has hitherto failed to find one which is satisfactory; in most cases the action of heat on them has been too powerful, and has effected a separation of some of the silica from the clay molecule, whilst the treatment of a clay with a strong acid or alkali brings about a complex decomposition of the molecule and completely prohibits the production of a definite compound by simple double decomposition. The various zeolites, which are simple salts of aluminosilicic acids, are not difficult to prepare, but they cannot be produced quantitatively and sufficiently free from other constituents of the clay; it is, however, highly probable that in the formation of some zeolite at a temperature not exceeding that of boiling water, that the determination of the proportion of true clay in a sample is most likely to be successful, and a number of chemists interested in clays have, for some time, been assiduously working in this direction.

Physical tests of clay are of considerable importance, but are too numerous, and require too lengthy a description to be included here. Readers interested in them will find detailed descriptions in "The Clay-Worker's Handbook," and in "British Clays, Shales, and Sands" (see Literature, p. 139).



## SECTION LXV

# POTTERY

BY ALFRED B. SEARLE

*Analytical and Consulting Chemist, Sheffield*

### LITERATURE

A very complete Bibliography of Pottery is contained in—

- A. B. SEARLE.—“The Clay-Worker’s Handbook.” London, 1911.  
M. SOLON.—“Ceramic Literature.” London, 1910.

The following are useful where a less comprehensive list suffices :—

- C. F. BINNS.—“Manual of Practical Potting.” London, 1901.  
— “Ceramic Technology.” London, 1897.  
R. BORRMANN.—“Moderne Keramik.” Berlin, 1902.  
E. BOURRY (Trans. SEARLE).—“Treatise on Ceramic Industries.” London, 1911.  
A. BRONGNIART (Trans.).—“Colouring and Decoration of Ware.” London, 1898.  
W. BURTON.—“Porcelain.” London, 1906.  
— “English Earthenware and Stoneware.” London, 1906.  
A. DEMMIN.—“Keramik Studien.” Berlin, 1885.  
W. J. FURNIVAL.—“Leadless Glazes.” Stone, Staffs, 1904.  
A. GRANGER.—“Céramique Industrielle.” Paris, 1905.  
H. HEGEMANN.—“Herstellung des Porzellans.” Berlin.  
W. JACKSON.—“Ceramic Calculations.” London, 1904.  
B. KERL.—“Handbuch der Gesammten Tonindustrie.” Berlin, 1907.  
C. LANGENBECK.—“Chemistry of Pottery.” New York, 1895.  
H. RIES.—“Clays: their Occurrence, Properties, and Use.” New York, 1908.  
E. SANDEMAN.—“Manufacture of Earthenware.” London, 1901.  
J. SCHAMBERGER.—“Keramische Praxis.” Berlin, 1901.  
H. SCHUHMACHER.—“Keramischen Tonfabrikate.” Berlin, 1884.  
A. B. SEARLE.—“Clay-Worker’s Handbook.” London, 1906, 1911.  
— “Natural History of Clay.” Cambridge, 1911.  
— “British Clays, Shales, and Sands.” London, 1911.  
H. SEGER.—“Gesammelte Schriften.” Berlin, 1908.  
S. SHAW.—“Chemistry of Pottery Materials.” London, 1837 (reissued 1910).  
G. STEINBRECHT.—“Steingutfabrikation.” Berlin, 1891.  
G. VOGT.—“La Porcelaine.” Paris, 1893.  
G. ZOELLNER.—“Natur des Porzellans.” Berlin, 1909.

The leading British journals are *Pottery Gazette*, *British Clay-Worker*, *Brick and Pottery Trades Journal*, and the *Transactions of the English Ceramic Society*.

POTTERY has always held an important place among the essential requirements of life, and its use has now extended to such an extent that it is difficult to realise the dependence of the industrial world upon it.

Without pottery there could not be the convenient employment of electricity we now enjoy; the production of the highest grades of steel and of most other products of the furnace would be impossible; there would be no bricks or tiles; the production of corrosive chemicals, with all that depends thereon, would be reduced to an insignificant quantity; the use of crucibles for testing and for refining purposes would remain unknown. In short, a modern industrial state without many diverse forms of pottery is almost inconceivable.

There is, in fact, as Brongniart has remarked, “no industry that affords in its practice, in its theory, or in its history, so many interesting considerations in the wealth of its scientific and economic application as the ceramic art or the manufacture of vessels and utensils out of baked

earth. Nor do I know one that offers productions more simple, more varied, more easy to make, or more durable in spite of their fragile construction. In no other human product are so many qualities united."

**The Classification of Pottery.**—The term "pottery," like several others which are equally familiar, is almost incapable of exact definition. It is generally understood to include all articles made of earthy materials, as in the use of the word "earthenware," but so broad a definition gives but little idea of the nature of pottery. As soon as a more precise definition is attempted, however, difficulties arise which are so serious as to render such attempts at a general definition quite unsatisfactory.

It is frequently stated that "pottery" is definable as "articles made of clay," but in view of there being no really satisfactory definition of clay, and the existence of a large amount of pottery in which clay is by no means the largest constituent, this statement becomes unreliable.

A similar difficulty is experienced when it is desired to classify the various kinds of pottery, and no entirely satisfactory classification has yet been devised.

In many respects a modification of Knapp's classification is the best; it may be summarised as follows:—

- |  |  |
|--|--|
| 1. <i>Porous Pottery.</i>                              | 2. <i>Non-Porous Pottery.</i>              |
| (a) Unglazed pottery.                                  | (c) Earthenware.                           |
| (b) Terra-cotta, bricks, tiles<br>and refractory ware. | (d) China and porcelain.<br>(e) Stoneware. |

There are several anomalies in this, as in all other classifications of pottery; *e.g.*, the porosity may be understood as relating to the general substance or *body* of the article, quite apart from the use or absence of a glaze. Thus, earthenware which is glazed is, to all intents and purposes, non-porous, though apart from the glaze it is highly porous.

(a) *Unglazed pottery* consists of a plastic, earthy material which has been made into the required shape, and then heated in a kiln or oven until it has been converted into a stone-like mass of medium hardness and great durability. Strictly speaking, the term "unglazed pottery" includes the articles mentioned in group (b), but it is more convenient to confine it to hollow-ware articles.

(b) The *terra-cotta*,<sup>1</sup> etc., group includes all solid articles, made of earthy materials, which are of a porous nature. The members of this group are usually soft enough to be scratched by iron, but some of them are so hard, or have a superficial hardness so great, that they cannot be scratched by steel.

The pottery in the two foregoing groups consists typically of burned clay, its colour varying from light yellow to red, reddish brown, and finally to a colour so dark as almost to approach black. If the raw materials used are exceptionally pure or are rich in lime, the pottery may be quite white.

If the temperature to which the pottery is heated in the kiln or oven is sufficiently high, the material of which the goods are made will begin to fuse and to lose its porosity and shape. With most clays this occurs at a temperature of about 1,000°-1,350° C., but if a pottery material can withstand the action of a kiln at a temperature of 1,600° C., or above, it is usually placed in a separate class as a heat-resisting or refractory material. Such refractory ware is usually soft enough to be scratched by iron, though parts of the surface may be harder, and especially if the temperature of the kiln has been very high.

When a piece of porous ware has been heated to such a temperature that the fused matter formed commences to fill the pores, the article will generally begin to lose its shape and to become twisted or warped. If it does not do this, it should be classified among the non-porous pottery. Thus, a brick clay will ordinarily be used for porous ware such as bricks and tiles, but by heating it in the kiln to a higher temperature than usual, a crude kind of (non-porous) stoneware may be obtained.

(c) *Earthenware* consists of porous pottery covered with a coating of glaze. It is, therefore, impermeable so long as the glaze remains sound and whole, but

<sup>1</sup> *Terra*, earth; *cotta*, baked. The term is used in the arts with reference to a particular colour, but in pottery its original significance of baked earth is retained, and is quite independent of the colour of the ware (see Sections LXIX. and LXX.).

any damage to the glaze will simultaneously increase the porosity. It is customary to use a thin covering of white-burning clay on the ware, immediately below the glaze, so as to give the article an appearance of having been made throughout of the more expensive clay. In some instances an opaque glaze or enamel serves the same purpose of covering any defects of colour or texture in the clay of which the earthenware is made (see also Section LXVI.).

The term "earthenware" is very elastic, and comprises pottery of widely different values, including the crude efforts of peasants in semicivilised countries, as well as the most elaborate work of the most gifted earthenware manufacturers in the world—work for which the British potters have been famous for many years, and for which they continue to maintain their reputation.

On the Continent, the term *faience* is used for all glazed articles other than stoneware and porcelain, and is therefore applied to earthenware. The term *majolica* is used to indicate a faience or earthenware in which the body is covered with an opaque glaze or enamel; this term is used somewhat loosely, and is occasionally, but erroneously, applied to ware covered with an opaque body over which is a transparent glaze.

*Chinaware and porcelain* are the most valuable forms of pottery so far as beauty of form, texture, and decoration are concerned. It is, indeed, a cause for perpetual wonder as to how it has been possible for such lovely objects to be manufactured (see Section LXVII.).

The term "porcelain" is applied by collectors and others to so many kinds of pottery that it cannot be defined at all accurately, though all true porcelains possess certain clearly recognised characteristics. Amongst these are the imperviousness of the body, the fineness of finish, and the whiteness of the undecorated portions of both the body and the glaze, the general hardness of the ware, and the translucency of the thinner portions of it. But the chief characteristic which distinguishes the porcelains from all other kinds of pottery is the manner in which the light is reflected from their surface. Some of the best specimens of earthenware and stoneware attain a translucency and hardness quite equal to that of porcelain, yet they cannot compare with the subtle and beautiful effect produced by the play of light on porcelain because of the difference in the texture and surface of the latter. This is due to the glaze in a true porcelain having a composition and nature very similar to that of the body to which it is applied, so that the transition from the outer surface of the glaze to the body of the ware is delicately gradual instead of being abrupt as in other forms of pottery. When the light falls on the surface of a piece of true porcelain it is reflected back by myriads of tiny crystals, each surrounded by a glassy substance, so that it emerges, softened and subdued, in a manner which is exquisitely beautiful, and is quite impossible of attainment in any other kind of ware.

There are many kinds of porcelain—indeed each different works must perforce produce a porcelain differing slightly, yet recognisably, from the others, and a perfect imitation is almost as impossible as it would be undesirable. Hence, the products of all the well-known firms may readily be identified by the expert without any reference to makers' marks. Yet, notwithstanding the multiplicity of the porcelains, they may be classified in three main groups according to their composition, viz. :—

(a) *The natural or true porcelains* consisting essentially of a mixture of clay and felspathic material with a glaze of similar composition, but more fusible; represented by the Chinese and Japanese porcelains as well as by the "hard paste" porcelains of Continental Europe.

(b) *The artificial or glassy porcelains* which were made from a mixture of clay and fused silicate or frit in the eighteenth century in various parts of Europe.

These porcelains are known as "soft" or "tender" and were difficult to produce because of the low plasticity of the raw materials and the liability of the articles to warp or lose their shape when in the oven.

(c) *Chinaware or bone porcelains*, invented in England but now made in America and in various parts of Europe. These consist of a mixture of clay with calcined bones and a naturally occurring mixture of felspar and quartz known as china stone.

The product is intermediate in properties between the other two groups of porcelain, though bearing a closer resemblance to the natural porcelains than to the artificial ones.

These three groups of porcelain may also be sold in an unglazed state, forming a number of wares of which *Parian* or *statuary porcelain* is the best known.

Both the tender porcelains and the chinaware are incapable of the beauty of the finest specimens of hard porcelains because, in the former, the glaze used is fired at a temperature much below that required for the ware itself, whereas in the true porcelains the glaze and the body are both finished at the same temperature and a far more homogeneous product is obtained.

The manufacture of true porcelain has never proved commercially profitable in Great Britain, and by far the greater part of English porcelain is of the bone-porcelain or chinaware type. The British Government has, however, voted a large sum of money to be spent in endeavours to produce a good, hard porcelain from British materials.

For further details, see Section LXVII.

*Stoneware* consists of a non-porous body which may, or may not, be covered with a glaze. It is distinguished from porcelain by its lack of translucency, by its colour and by its coarse nature, and from earthenware and terra-cotta by its imperviousness to water. This impermeability is never absolute, and most unglazed stoneware will absorb a fraction of one per cent. of water; hence there is no sharp dividing line between stoneware and terra-cotta, though in practice little confusion arises in classifying these wares.

The term "stoneware" is frequently applied to coarse glazed ware used in sanitation (such as kitchen sinks and drain-pipes), although such ware has a porous body which has been made externally impervious by a coating of glaze. The more correct appellation is "sanitary earthenware." Some of the finest stoneware has some resemblance to the cruder porcelains, but is readily distinguishable by its different texture and action on light.

For further details, see Section LXVIII.

The physical properties of pottery differ according to the nature of the ware and cannot well be considered in general terms.

For *domestic and sanitary purposes*, pottery must be convenient in shape, entirely impervious to water, milk and the various fluids used in cookery, and sufficiently strong to withstand ordinary wear and tear and such sudden changes in temperature as are ordinarily experienced in its use. It should also be pleasant in appearance and capable of such decoration—both in carved work and in colouring—as will increase the pleasure felt in using or in seeing it.

For *technical purposes*, pottery must be capable of withstanding ordinary usage, and must be sufficiently resistant to the fluids to which it will be subjected. The glaze (if any) must be tough enough to last for a reasonable time, and the ware as a whole must be strong enough to carry any loads or to resist any electrical current to which it is likely to be subjected. In some branches of manufacture, pottery must be capable of being repeatedly heated and cooled without any cracks forming in the glaze or body and, in the case of drain-pipes, it must be sufficiently tough to permit a small amount of ground settlement without fracture.

For *architectural work*, a number of other characteristics are required. Building bricks and terra-cotta must be sufficiently strong to carry the loads imposed on them; the more refractory bricks and slabs used in the fireplaces and chimneys must be capable of resisting any probable temperature, whilst flooring tiles and paving bricks must be intensely hard and tough so as to withstand the wear and tear of traffic over them. In addition to strength, most architectural pottery (including bricks and tiles) must have a pleasing appearance, especially that which will be seen when the building is completed. For interior brickwork, the colour and appearance are of minor importance, but for exterior work they are first qualities sought by the architect, although strength and resistance to crushing are equally important in large structures.

For *purely decorative purposes*, the clearness and quality of the colours, brightness of the glaze (if any), and the texture of the visible surfaces of the ware are of the greatest importance, and it not infrequently happens that physical defects which result in an attractive appearance are not merely tolerated but are actively welcomed. The cracked glaze in "crackle ware," and the irregular flow of coloured glaze on tiles and vases, are two typical examples of defects of this character which are used for the purposes of ornamentation and decoration.

In many pieces of decorative pottery, properties of importance for other purposes are deliberately neglected in order to obtain beautiful effects not otherwise procurable. Thus, an article for indoor use need not possess the durability and resistance necessary in ware intended to be exposed to the weather and it is, therefore, possible to use colours and to obtain effects which are quite impossible when weather-resisting pottery is required.

The decorative value of pottery depends almost entirely on the technical skill and on the æsthetic feeling possessed by those engaged in its manufacture. Its beauty is not confined to colour, design or form, for pottery offers greater possibilities to the artist and sculptor than does any other material. Each year the number of available colours increases, each year an increased

mechanical exactitude in manufacture is obtained. It is still true that pottery is one of the most conservative as well as one of the most progressive arts, yet the progress made in manufacture during the last half century is remarkably great. The modern potter with more precise technical and scientific knowledge of the materials used, and better methods of heating them than was possessed by his predecessors, is continually finding new materials and new effects with simpler and more reliable methods of manipulation. At the same time, the increasing demands of other departments of industry are opening out fresh fields of service to the manufacturer of pottery, and are increasing the value of this material both industrially and æsthetically.

The manufacture of pottery has undergone many changes during the last few decades, and the modern custom in Continental Europe of building very large factories and working them in the most up-to-date and progressive manner possible is making it increasingly difficult for the smaller firms both in this country and abroad. The rapid increase in American potteries is also tending to close one of the best markets open to British potters. In the newer countries, competition amongst British, French, and German potters is very keen and the progressiveness of French and German potters has made their influence felt on the home trade of this country.

It must be clearly understood that British potters have greatly improved the quality of their wares, and the secession of English earthenware from its monopoly of many foreign markets is not due to the quality of the ware produced in this country, but to the development of pottery manufacture in other lands, the greater appeal to local tastes made by many Continental potters, the lower costs of manufacture due to State subsidies, the amalgamation of small firms, the economies and, most of all, to the improvements effected by the intensive application of scientific investigation to the requirements of individual works. In England, on the contrary, potters have endeavoured to meet competition by direct economies in manufacture, *i.e.*, by avoiding wastage as far as possible, but without making much effort to reduce costs by working on a very large scale. Instead of employing trained men to undertake scientific investigations in their own works, they have been content with "experiments" of an amateur nature, carried out by their foremen and other workmen. The French and German potters have sunk enormous sums of money in work of a purely investigational nature; that money is, to all intents and purposes, lost, but it is being regained in the form of rapidly increasing trade. The British potter, on the contrary, is unwilling to spend large sums of money in this manner, and so is faced with an increasing competition. The British Government is endeavouring to assist potters in various ways, but the existence of many small firms with no surplus capital, rather than a few large and rich ones, prevents much progress being made against foreign competition.

Both policies have much to be said in their favour, but there can be no doubt that a firm of pottery manufacturers willing and able to spend money in properly arranged investigational and organisational work will have a far better chance of succeeding than those which continue on the present lines.

As a single instance of the two different points of view, it may be stated that whilst America has five schools for clay-working connected with its universities, Germany has six such schools all heavily endowed, and Great Britain has part of one small building, which, until recently, was of a wholly temporary character; it is under the control of a committee whose interests are purely local.

Yet, in spite of all their disadvantages, the best productions of British potters are still unrivalled in beauty and design, in quality of workmanship, and in technical excellence.

## SECTION LXVI

# EARTHENWARE

BY ALFRED B. SEARLE  
*Consulting Technologist, Sheffield*

LITERATURE.—(See under **Pottery**, p. 151)

THE term *earthenware* comprises a large number of different kinds of pottery, all of which consist of a porous body (or biscuit) covered with a suitable glaze. It is sometimes applied to unglazed hollow ware such as flower pots, but it is better to include all unglazed ware under a different term. For domestic earthenware the glaze is essential; without it the ware would become dirty and unsightly in use.

Earthenware may be divided into :—

(a) *Coarse earthenware*, composed of a red or buff-burning clay covered with a simple and somewhat crude glaze.

(b) *Fine earthenware*, composed of an almost white body covered with a fine glaze, the ware being made and finished in such a manner as shall increase its intrinsic beauty. It is generally agreed that, for the price, there is no pottery better for ordinary use than fine English earthenware, though, when price is important, porcelain has some advantages not obtainable with earthenware.

In the classification of earthenware it is often convenient to group it according to the glazes used, thus :—

1. Ware with a transparent glaze of—

(a) *Alkaline* nature, as in Persian faience.

(b) *Plumbiferous* nature, as in most English earthenware and faience.

(c) *Boracic* nature, as in leadless glazed ware.

2. Ware with an opaque glaze or enamel, as in majolica, Della Robbia and Delft wares. As the enamel usually contains tin compounds as opacifiers, this ware may be termed *stanniferous faience*.

It is, however, desirable to group the various kinds of earthenware according to the composition of the body used, viz. :—

1. *Coarse earthenware* made of a single clay, or of two or more local clays, with the sole addition of sand or crushed pottery. This ware is usually covered with a plumbiferous or an alkali-boracic glaze, and is chiefly used for very coarse pottery, architectural faience (sometimes euphemistically termed glazed terra-cotta), glazed bricks, hearth and wall tiles, sanitary ware, cheap vases and other decorative articles.

2. *Calcareous earthenware* made of marl, or of a mixture of clay and chalk. This is the basis of enamelled ware (majolica, Moorish, Spanish, Delft, Della Robbia ware, etc.). This group of earthenware is largely used for tiles, fireplaces, and for decorative objects. The chalk present is essential to the correct adhesion of the enamel or other glaze used. The glaze is usually opaque, *i.e.*, an enamel, but alkali-plumbiferous glazes, or glazes consisting of alkaline earths and boracic acid, are sometimes used. Calcareous earthenware is not manufactured on a large scale in England at the present time.

3. *Siliceous earthenware*, consisting of sandstone covered with plumbiferous glaze, was made by the ancient Egyptians and Persians, but is no longer manufactured.

4. *Fine earthenware*, consisting of a mixture of fine clays with flint and a felspathic material known as "Cornish stone." The glaze is composed of similar materials, in different proportions, together with various lead and boron compounds.

Many attempts have been made to use glazes free from lead for this purpose, but only with very limited success. There is a considerable field for extensive experiment in this direction, but so far no substance has been formed which possesses the same power as lead of producing a rich and brilliant glaze at temperatures suitable to the body of the ware. The number of leadless glazes now in use indicates the great progress made, but the uses of these glazes are very limited, and they lack the brilliance and ease of working possessed by plumbiferous ones.

As previously stated, fine earthenware forms the bulk of domestic, culinary and table ware, and its use for decorative objects is rapidly increasing.

The body of earthenware may be red, yellow, or white according to the clays used. As it is completely covered by the glaze its colour is unimportant, but at the same time, it must be observed that the term earthenware, as ordinarily used, refers exclusively to fine earthenware. The glaze can be scratched by steel and is more readily chipped than porcelain, but is very resistant to changes in temperature.

The better qualities of earthenware are sufficiently dense to "ring" when struck, though the body is highly porous before glazing; it is closer in texture than most of the commoner wares. In appearance and usefulness the best earthenware approaches the ordinary chinawares or porcelains, though the latter, having an impervious body, are preferable for many purposes. Hence, the increased production of cheap chinaware and porcelain tends to displace the use of earthenware for domestic and hotel use.

**The Constituents of Earthenware.**—All pieces of earthenware are composed of two parts—(a) the body of which the article is made and (b) the glaze which covers it either partially or completely, and is intended to render it non-porous, cleanly in use and, in some instances, to add to its beauty. A third constituent—the engobe—forms part of some earthenware. The chief object of the potter is to produce a paste from which he may form the body<sup>1</sup> of the articles, this body being required to possess certain characteristics. It must be, for instance, sufficiently plastic to permit its being moulded or worked by hand into any desired shape. When dried carefully it must not twist or warp or otherwise lose its shape. It must also be sufficiently strong not to be damaged by reasonably careful handling. When taken from the kiln it must be strong enough to be employed for all the customary purposes for which it was designed, and it must, therefore, contain sufficient fusible material to bind all the particles strongly together. At the same time, the amount of fusion which occurs must not be sufficient to cause the article to lose its shape. The materials used for the body must be in so fine a state of division that they do not spoil the surface of the ware. Thus, delicate modelling and carving cannot be done satisfactorily if the body contains large grains or gravel-like pieces of material. At the same time, it must not be so fine as to make the ware unduly dense, or it will cause cracks. In the crudest and cheapest wares the cost of grinding the material to a very fine state is prohibitive and not infrequently compels the use of coarse clays, to the detriment of the product.

The colour of the fired body must be agreeable for the purposes for which it is to be used. In the case of fine earthenware it must be white, or nearly so. In many instances a body of undesirable colour may be covered with an engobe of a satisfactory nature and the disadvantage thereby overcome.

The glaze must be sufficiently fusible to flow satisfactorily over the surface of the ware to which it is applied, but it must not be so fluid as to run down sloping or vertical portions of the ware, leaving them scarcely covered with glaze.

---

<sup>1</sup> The term *body* is used by potters to mean (a) the substance of which the article is mainly composed, *i.e.*, the article itself apart from its decoration and glaze and (b) the paste or other material from which the potter forms his ware. The term is also applied to a thin coating of clay between that of which the article is made and the glaze. It is preferable to use the term *engobe* for this kind of body (see p. 173).

Too infusible a glaze will be deficient in glossiness, and may contain numerous air-bubbles; too fusible a glaze will be clear and brilliant in places, but it will be unevenly distributed and will be too thin in various parts of the ware.

An *engobe* or *slip* is frequently placed between the body and the glaze. Its sole purpose is to cover the form and to give a finer surface to which the glaze may adhere. On account of its position, an engobe must naturally partake of the properties of both body and glaze, and it usually consists of a mixture of relatively pure clays with some of the glass-forming constituents of the glaze. Engobes are particularly useful when the clay used for the body of the ware is of an undesirable colour, or is of such a nature that the effect of applying the glaze to it is unpleasant. If an ordinary red brick is covered with a transparent glaze, the finished product would always be of a reddish-brown colour. By covering the surface of the brick with an engobe composed chiefly of white-burning clays, however, white glazed bricks can be produced. If coloured bricks are required, the colours may be added either to the engobe or to the glaze.

This use of a thin layer of superior or more costly clay is generally cheaper and more satisfactory than the use of an opaque glaze—especially if the body of the ware is strongly coloured. It also serves as a convenient means of reducing the cost of the materials used, for large articles may be made of a comparatively cheap clay which, when covered with an engobe, will appear to be made of the superior clay used in the latter. The chief disadvantage of engobes is their liability to spall or crack off on exposure; this can only be avoided by skilful attention to details in manufacture, and on the correct adjustment of the body, engobe, and glaze to each other. It is in this careful adjustment that the remarkable skill of the potter chiefly lies, and it is in this direction also that he derives the greatest benefit from the employment of a skilled ceramic chemist.

When a piece of heated, glazed or engobed ware is cooled, the body, engobe, and glaze will all contract at different rates, and if the stresses developed by these contractions are sufficiently great the ware will be spoiled. The engobe and glaze being very thin, relative to the body, the effects of irregular contraction are most observable in them, with the result that a large variety of defects—cracking, peeling, formation of a wavy surface, etc.—are produced in the glaze.

The differences in the coefficients of contraction of the body, engobe, and glaze are usually very minute, and it requires special training and skill to measure them.

The **raw materials** used in the manufacture of earthenware may be arranged in five groups:—(i.) Clays; (ii.) Fluxes or glass-forming materials; (iii.) Refractory or heat-resisting materials; (iv.) Diluents; and (v.) Colouring materials.

The **clays** used for earthenware differ greatly in character, according to the purposes for which the ware is employed. For the coarsest ware a very low grade clay or brick-earth may be used, but for the finer table ware the clays employed must be carefully selected, and must be free from all impurities which would materially affect their colour when burned. Intermediate between these two types of ware is a large number of others for which a correspondingly large variety of clays may be employed.

In order, however, to keep the subject within limits suitable to the present volume, the nature of the clays used for the coarser earthenware are described under **Sanitary Ware** (p. 193), **Bricks** (p. 199), and **Tiles** (p. 225), the present section being limited to the manufacture of table and decorative earthenware, in which only superior clays are used.

The *blue* or *ball clays* which occur in the tertiary deposits of Devonshire and Dorsetshire form the basis of the finer English earthenware.

These clays vary from a light bluish-grey colour to brown or black when first mined, the colour being due to organic matter. They are peculiarly plastic, unctuous to the touch, and the better qualities are quite free from all gritty matter. These clays occur in the form of an exceedingly stiff paste which is very difficult to cut, and they are, therefore, quarried or mined by a slow process of hand-digging, in which great precautions are taken to prevent dirt getting into the clay. Considerable variations occur in the nature or composition of the ball clays from each quarry or pit, and it is therefore necessary, when purchasing, to state the purpose for which the clay is required. Otherwise, a clay may be supplied which is only fit for the manufacture of common ware or drain-pipes. The firms supplying ball clay can usually be relied upon to make the necessary selection with great care.



When heated to dull redness, a suitable quality of ball clay will become white and very porous, but when heated to a temperature of 1,100° C. or over its colour changes to yellow, sufficient fusion occurs to entirely fill the pores, and the mass, when cold, is so hard that only the hardest steel will scratch it. This yellow tint is detrimental to the colour of the finished ware, and though it is weakened by the other substances comprising the body of the ware, it is usually necessary to add a little cobalt oxide, the blue colour of which optically neutralises the undesirable tint of the clay.

The chemical composition of ball clays as shown by analyses gives very little idea as to their value for earthenware, as a percentage of impurity so small as to be scarcely recognisable on analysis will, in some cases, render a clay quite useless. The following figures are, however, typical of this kind of clay :—

	Blue Ball Clay (Wareham).	Blue Ball Clay (Newton Abbot).	Black Ball Clay (Dorset).
Silica - - - - -	48.99	47.00	52.23
Alumina - - - - -	33.75	38.00	28.25
Lime - - - - -	0.43	1.50	1.30
Magnesia - - - - -	0.22	0.50	0.25
Potash and soda - - - - -	3.31	...	1.23
Iron oxide - - - - -	1.34	1.50	2.54
Water and loss on ignition - - - - -	11.96	11.50	14.20
	100.00	100.00	100.00

Commercial ball clays usually contain about 18-20 per cent. of water in the form of absorbed moisture, and an additional 12 or 13 per cent. of water is evolved when the clay is heated in a kiln. This latter water appears to form a part of the clay molecule and, on its separation, the clay loses its plasticity and other distinguishing properties. In consequence of the loss of these portions of water, all clays shrink when heated.

The chief purpose of ball clay in earthenware is to form the bulk of the body, any defects in the clay being corrected by the addition of other substances. Thus, flint increases the whiteness of the material, but reduces its plasticity, and it is, therefore, necessary to add a white clay such as china clay, if large proportions of flint are used. Ball clays are so highly plastic that they will stand the addition of very large amounts of non-plastic material such as flint and Cornish stone. Further information on clays will be found on pp. 139-150.

*China clays* or *kaolins* of good quality are quite white when burned, and they are, therefore, added to ball clays to counteract the yellow tinge of the latter, and also to decrease the plasticity. China clays are the essential constituent of porcelains, and are therefore described more fully on pp. 145, 183.

If china clay enters largely into the composition of a piece of earthenware, the latter will have a *more refractory and stronger body than would otherwise be the case, and it would be less affected by sudden changes in temperature.* Hence it is a useful constituent of such ware in spite of its peculiar characteristics.

*Buff-burning clays* occurring near to the works are sometimes added to the body mixture when an inferior grade of earthenware is being made. They serve as an inferior substitute for the ball clay, and usually lower the value of the ware in which they are used.

*Red-burning clays* used for coarse pottery are closely related to the brick and terra-cotta clays (Sections LXIX. and LXXI.).

**Fluxes or Glass-Forming Materials.**—In order that the particles may be strong when the ware is drawn from the kiln it is necessary that a certain amount of fusion should have occurred, as the fused matter, on cooling, forms a kind of matrix or cement.

When earthenware is made of materials deficient in flux, the ware will be unduly weak and porous, and will not "ring" properly when struck, as its particles will not be sufficiently well bonded together. Many clays contain materials of a sufficiently fusible nature (see Stoneware), but in the manufacture of the better qualities of earthenware it is usually necessary to add such a substance, which is then termed a flux.

In the production of *glazes*, fluxes play a highly important part as they form the chief constituents of all glazes and glasses. The chief characteristics of a glaze are that it must melt completely to a glassy mass free from air- and gas-bubbles, and that it must have sufficient fluidity to allow these bubbles to escape, and to permit the glaze to flow uniformly without an excessively high temperature being reached in the kiln. To meet these requirements, it is usually necessary to use a large proportion of flux in the preparation of a glaze.

Fluxes are of two kinds: (*a*) those which are, in themselves, fusible, as glass, Cornish stone, and felspar; and (*b*) those which are only fusible in the presence of certain other materials with which they combine.

Lime is typical of this second kind of flux for, alone, it is practically infusible, yet when mixed with clay it forms a readily fusible material. The chief "impurities" in clay, and most metallic oxides and carbonates, are of this nature.

*Cornish stone* is a granitic rock, occurring chiefly in Cornwall, which is rich in felspathic material of a sufficiently fusible nature to make it the best flux for the earthenware manufacturer. Its composition resembles a mixture of orthoclase felspar and a highly siliceous clay, but artificially prepared mixtures of these materials cannot be satisfactorily substituted for *Cornish stone* in pottery manufacture. In addition to this, *Cornish stone* is somewhat softer than felspar, and can be ground at rather less cost.

Typical *Cornish stone* shows on analysis—

Potash	-	-	-	6 per cent.
Lime	-	-	-	1 "
Alumina	-	-	-	18 "
Silica	-	-	-	75 "

The mineral varies so greatly in composition that no single analysis adequately represents it. The best method of comparing different samples is to note their colour when fired in a potter's kiln, and also their fusing points and relative hardness or resistance to crushing.

When heated alone, *Cornish stone* does not fuse sufficiently to lose its shape at temperatures below  $1,300^{\circ}$  C., but when it forms part of a body-mixture it appears to fuse at about  $1,100^{\circ}$  C.

*Jersey stone* and *pegmatite* are other felspathic rocks similar to, but not identical with, *Cornish stone*.

*Felspar* is the name given to a number of alumino-silicates of well-defined crystalline form and composition which occur in the older rocks. The felspar chiefly used by potters is that known as *orthoclase*, which is a potash alumino-silicate containing about 16 per cent. of potash, 18 per cent. of alumina, and 65 per cent. of silica.

Calcium, sodium and other alumino-silicates of a similar composition are less fusible than orthoclase and are, therefore, of less value.

Felspar occurs chiefly in granitic regions; that used by British potters is largely imported from Norway.

On prolonged heating, at a temperature of about  $1,310^{\circ}$  C., potash felspar (orthoclase) melts, but does not form a clear transparent glass unless heated to a higher temperature, or it is mixed with another substance which can lower its melting point. When used in a glaze, felspar gives "depth of tone" and brilliancy, but it is only used to a small extent in the manufacture of earthenware. The colour of felspar varies from green to yellow, but the material usually preferred by potters is a pale yellowish brown or buff.

*Glass* is not much used as a flux in earthenware manufacture, but a little glass is sometimes employed for this purpose in glazes. Its composition is usually irregular and its employment inadvisable.

*Frits* are specially prepared glasses made by fusing together various constituents of a glaze (usually the alkali oxides or carbonates and some form of silica or clay) so as to form an insoluble and readily fusible glass.

The use of soluble substances in an unfritted state in a glaze greatly complicates the application of the latter. Many glaze recipes contain the direction to use a stated quantity of "frit"; unless the composition of this frit is stated in the recipe it will be impossible to follow the directions as there are hundreds of different frits (see p. 178).

*Borax*, or sodium borate (Vol. I., p. 355), is an important source of soda, but all soda and potash compounds have the serious disadvantage of needing to be fritted or fused with other materials in order to make them insoluble before they can be used. When heated alone, borax fuses to a clear glass, but as this is soluble it cannot usually be employed unless it is combined with silica.

Borax is an exceedingly valuable material for reducing the melting point of a glaze and for increasing fluidity and brilliance, so that it is used extensively in earthenware glazes. It should be free from iron and aluminium compounds and from common salt, and, like all the raw materials used in earthenware and porcelain manufacture, it should be tested before use. On heating, borax loses nearly 34 per cent. of its weight of water.

*Tincal*—an impure form of borax—is now seldom used. Commercial borax is much purer, more uniform in composition, and is in every way preferable.

Of the second kind of fluxes (p. 161) *lime*, *magnesia*, *potash*, *soda* and other metallic oxides are used so seldom as body-fluxes in earthenware that for this purpose they may be neglected.

It is, however, necessary to remember that they occur in all clays and that their influence is often sufficiently great to make a considerable difference in the quality of the ware unless the clays are specially carefully selected.

In the manufacture of glazes for earthenware, soda ash and pearl ash (sodium and potassium carbonates) are largely used.

*Whiting*, or calcium carbonate, is the form in which lime is usually introduced into a glaze. It is converted into quicklime on heating to about 750° C., but has the advantage over the latter of being insoluble in water.

Alone it is infusible, but when mixed with suitable proportions of clay, silica, alumina and most silicates, it enters into combination and produces a fusible mass.

Its special function in a glaze is to reduce the fusing point, and to increase the durability and clearness.

For some of the cruder forms of earthenware a *marl* (or natural mixture of clay and chalk) is used as a flux. It cannot be employed for fine earthenware on account of the iron compounds present in all marls.

*Plaster of Paris* (calcium sulphate) (Vol. I., p. 345, also this Vol., p. 113) is sometimes used as a means of introducing lime, but cannot be recommended, as the presence of sulphates is a serious disadvantage.

*Baryta* (Vol. I., p. 351) is sometimes added to glazes to increase their brilliance. It replaces lead whose action it resembles.

*Magnesia* and *magnesium carbonate* are used by some potters. They resemble the corresponding lime compounds in their action.

*Soda* is preferably used in the form of sodium carbonate. The sulphate may be used, but as sulphates are undesirable in glazes they should seldom, if ever, be employed.

Common salt is occasionally used, but is troublesome as it decrepitates when heated. All soda compounds (except soda felspar) must be fritted before use to render them insoluble.

*Potash*, or pearl ash, is similar in many ways to soda, but generally behaves with greater power notwithstanding its greater molecular weight. It is best used in the form of potassium carbonate, as the less pure form (pearl ash) sometimes introduces too large a proportion of iron into the glaze and stains it an unpleasant yellow.

Potash compounds must usually be fritted to render them insoluble but, where the nature of the ware permits, this fritting may be avoided by the use of potash felspar (orthoclase).

*Boracic acid* may be used as a substitute for silica when glazes of a very low melting point are required.

Some potters prefer a fritted mixture of boracic acid and soda to the use of borax, though the reason for this is difficult to explain. It is probably due to the fact that a mixture of potash, soda, and lime, or any two of these, has a greater fluxing effect than the same weight of soda.

*Lead compounds* are invaluable fluxes, as they combine with silica and various aluminosilicates to form a very large number of glazes with a wide range of fusibility.

*White lead*, or basic lead carbonate, is one of the most useful fluxes known to the potter, as it gives a transparent glaze at a low temperature, and the lead compound is insoluble in water.

*Litharge*, or monoxide of lead, is also used as a flux and has similar properties, but being less bulky it is not quite so satisfactory.

*Red lead*, or minium, is a brilliant red powder consisting of tri-plumbic tetroxide. It fuses at a slightly lower temperature than white lead, but is more dense and is considered to give a yellowish tinge to the glaze.

*Galena*, or plumbic sulphide, is only used in glazing coarse earthenware as the sulphur and other impurities in this ore prevent its employment in fine glazes. It is the only lead compound which is excluded from the provisions of the Factory Acts for Potteries. This exclusion is due to the great insolubility of galena, which renders it practically non-poisonous.

With this exception, all the lead compounds used by potters are insidious poisons, which are all the more dangerous because their action is so slow and cumulative. Many attempts have been made to avoid the use of lead compounds, but for the majority of earthenware goods no adequate substitute has yet been found.

**Refractory substances** used in the manufacture of earthenware bodies are usually represented by *flint*. This is a concretionary form of silica which occurs in the Chalk formation, and consists of almost pure silica. Such substances must be able to withstand the heat in all parts of the kiln without appreciable fusion; they must be perfectly white after the burning of the ware, and must be used in grains of sufficiently small size not to disturb the uniformity of the composition of the body.

*Calcined flint* is prepared by heating the flints found in the Chalk formation to redness, quenching them suddenly in cold water, and afterwards grinding the product to an exceedingly fine powder. Flints from near Dieppe are deemed of special value for pottery. Calcined flint has a composition equivalent to that of pure silica with about 5 per cent. of lime and 1 per cent. of other impurities.

*Grog* or calcined clay is occasionally used for the same purposes as flint, but as it is of the same colour as the clays used in the body, it does not aid in whitening the mixture like a good quality of flint.

*Sand*, if sufficiently fine and pure, may be used as a substitute for flint as may also Geyselite and Kieselguhr; it is, however, very difficult to get these materials in a high state of purity and fineness.

**Diluents** are substances which are used on account of their cheapness. They are not employed extensively at the present time, but may be so in the near future on account of the increased cost of the raw materials now commonly used. Such diluents consist of cheaper varieties of clay, the substitution of some other form of silica for flint, or the replacement of some ball clay and flint by a leaner clay.

**Colouring Materials.**—These are usually metallic oxides or glasses made from them, and are known in the trade as *stains*. They may be (a) mixed with the body of which the articles are made, or (b) with a specially prepared body or engobe with which the articles are covered, or (c) they may be applied direct to the surface of the article as in underglaze decoration, or (d) mixed with the glaze, or (e) applied to the glazed article as in overglaze decoration. On some articles the colours are applied in two or more of these ways in order to produce special decorative effects.

The original colour of the "stain" gives little or no indication of its appearance when the decorated articles are withdrawn from the kiln, as the colour is due to chemical changes which occur during the heating of the ware.

The number of different stains on the market is exceedingly large and few potters now manufacture their own stains. In the majority of cases, the stains purchased are mixtures of the colouring oxide with a diluent or some material to effect a desired modification of the tint. Thus, the addition of zinc oxide or alumina to cobalt oxide affects the colour of the latter far more than if it were merely a diluent. In each case, however, the essential ingredient of a colour or stain is a metallic oxide, such as one or more of the following :—

*Cobalt oxide* gives a strong blue colour. A very small proportion of cobalt oxide added to an earthenware body will counteract the tendency to yellowness, and will make the ware whiter. The use of cobalt oxide for this purpose is precisely similar to that of powder blue by the ordinary laundress in washing household linen, etc. Its action is purely optical and depends on the neutralising power of the blue and yellow colours on each other.

In large proportions—up to 4 per cent.—cobalt oxide colours both bodies and glazes a brilliant blue, the tone of which is made lighter and richer by the addition of zinc oxide or alumina. Cobalt blues are used so extensively in pottery manufacture that many special preparations of it are sold for the production of definite shades such as “willow blue,” “mazarine blue,” “ultramarine blue,” “celeste,” “sky blue,” etc.

*Cupric oxide* is a black powder used for the production of blues and reds, and is usually added to the glaze or to an engobe of a glaze-like nature. In neutral or acid glazes and an oxidising atmosphere, cupric oxide gives green colours, but in glazes rich in alkali various shades of turquoise blue are produced.

Under reducing conditions and with alkaline glazes, it forms brilliant reds which are usually attributed to free cuprous oxide, but are more probably a highly complex copper-sodium aluminosilicate with some metallic copper. This is the source of the colours known as *rouge flambé*, *aventurine* and *sang de bœuf*.

*Iron oxide*, as used by potters, is a reddish powder of variable composition which, when added to a white body and fired, usually produces a reddish brown or yellow colour, but if there is a shortage of air in the kiln, greenish blue, dark grey, or an imperfect black may be produced.

There appears to be an unlimited number of hydrated ferric oxides, the composition, texture, size of grains, and behaviour of which depend on the manner in which they have been prepared. *Crocus martis*, *ochre*, *sienna*, *rouge* and other iron colours are of this nature.

If the equivalent of about 5 per cent. of iron oxide is present, the ware may be a good terra-cotta red, a much smaller proportion producing a dirty yellow or buff tint. It has been repeatedly shown, however, that the proportion of iron oxide ascertained by analysis bears no definite relationship to the intensity of the colour, and there are good reasons for supposing that the best terra-cotta clays do not contain free iron oxide, but some complex compound such as nontronite, which is decomposed on heating, ferric oxide being then set free. The size of the particles of iron oxide also has a great influence on the resulting colour.

In the presence of lime, the red colour ordinarily produced by iron compounds is destroyed, but if the ware is heated almost to fusing point it becomes a pale “bottle-green.”

The range of colours produced in earthenware bodies by iron compounds is very great, but great accuracy of tint is almost impossible to obtain. There is room for much further research in this direction.

When added to glazes, the behaviour of iron oxide is quite different from that just described. At temperatures below 1,000° C. a reddish-brown glaze is formed which, with slight reducing conditions, may become purple or black owing to the production of complex ferrous aluminosilicates. At higher temperatures it forms brown glazes, the colour of which is apt to be irregular, but can be made more stable by the introduction of manganese and certain other oxides. With plumbiferous glazes iron oxide tends to form various yellow colours, but becomes green in the presence of an alkaline glaze.

*Chromic oxide* is chiefly added to the glaze, as with bodies the effects produced are less pleasing. When burned in a kiln with an ample supply of air, alkaline or simple plumbiferous glazes containing chromic oxide become intensely yellow, but if both alkali and lead are present an orange glaze is produced. If, as is usual in the hotter parts of the kiln, the conditions are reducing, chromic oxide forms beautiful green glazes which are very popular; the simultaneous use of chromic oxide, cobalt and copper enabling a large range of shades to be produced.

In the presence of oxide of tin and lime, chromic acid (or potassium bichromate) forms a brilliant series of tin-pinks which have been extensively used in spite of their true composition being imperfectly understood.

With iron and manganese oxides, chromic acid forms "blacks"—a little cobalt oxide being generally added—but in this connection it must be remembered that there are no true blacks in pottery.

*Manganese oxide* when added to glazes gives brown colours which are usually more pleasant if both iron and manganese oxides are used. If the glaze is rich in alkali, a violet colour is produced.

*Nickel oxide* has proved unreliable for earthenware manufacture, but at temperatures of 1,300° C. with felspathic glazes it gives beautiful broken tints of brown and green. The colours produced in the presence of lead and borax are far from pleasing, though when carefully prepared it may be successfully used in the production of some of the newer shades of apple-green.

*Lead antimonate* is a bright yellow pigment (Naples yellow) which can be distributed uniformly through any plumbiferous glazes without decomposition. It is the basis of the most brilliant yellows; like other lead compounds it cannot be used at temperatures above 1,200° C.

*Antimonic acid* in a lead glaze forms the Naples yellow just described.

*Uranium oxide* produces a number of bright yellow glazes which can be fired at low and high temperatures. It is more expensive than antimony yellow, but is available under conditions where the latter cannot be used.

*Gold chloride* mixed with tin chloride forms *Cassius' purple*, which produces brilliant rose, purple and carmine colours in glazes at temperatures between 850° and 1,100° C.

*Metallic gold* is applied to the glazed ware in the form of a specially prepared mixture, which is "fixed" by gentle heating in a suitable kiln. The gold may also be burnished by rubbing it with agates, if desired.

Other precious metals such as silver and platinum are occasionally used to produce a lustrous effect.

*Tin oxide* (stannic oxide) remains suspended in most transparent glazes, and thus converts them into white, opaque masses resembling some kinds of porcelain. It is the opacifying medium of most enamels.

*Tin ash* is a stannate of lead made by roasting lead and tin together. It is being rapidly replaced by tin oxide which is a purer and better preparation.

*Zinc oxide* and *antimony oxide* behave in a similar, but far less efficient, manner.

*Fluorspar*, *cryolite*, *alumina* and various other substances are used as opacifying and colouring agents, and new preparations are continually being invented.

There is, in fact, a continual demand for new colours in bodies and glazes, and a detailed investigation as to the causes of the formation of several colours is much needed. Many of them are now prepared by purely empirical methods which could, probably, be simplified and improved if the reactions involved were better understood.

*Testing Raw Materials.*—At the present time very few earthenware manufacturers carry out systematic tests on their raw materials; even the most progressive of them do little more than "run a test batch of ware" when a new supply of material is received. Consequently, there is room for considerable economies and improvements in this direction, though the matter is far more complex than appears at first sight. The tests which should be made must be of a physical as well as a chemical nature, for in many cases variations in the fineness of the material are even more important than in its composition. The fusing points and the speed of reaction with other substances are also matters of importance which are difficult to test precisely.

The influence of apparently unimportant factors, and the difficulty in ascertaining the real causes of various phenomena observed, make the testing of raw materials a tedious task and one which is usually fraught with but small return for the labour spent. Yet this is precisely one of the chief reasons why testing should be systematically carried out, for in no other way can difficulties be overcome so readily or progress made in the industry.

Comparatively small variations in the raw materials used are frequently the cause of very serious losses, so that some examination of all raw materials is absolutely essential to success, if a works is to be well managed on really economical lines.

**Earthenware Bodies.**—The body of earthenware articles is prepared by mixing two or more clays with sufficient glass-forming material, or flux, to form a

material which, when burned, will have a sufficiently close texture, a good ring, and will possess the usual characteristics of unglazed earthenware.

The kind of clays selected for this purpose have been described on pp. 159, 160; the fluxes on pp. 160-163. It is usually necessary to add a considerable proportion of non-plastic refractory material (such as flint) to reduce the shrinkage which the mixture undergoes on drying, and to produce as white a ware as possible. Any tendency to yellowness may be corrected by the addition of a suitable preparation of cobalt.

The proportions of the different materials used differ considerably in different works and according to the kind of earthenware required. In all cases, the *ball clay* is the chief ingredient, and usually forms almost half the weight of the raw materials used. The *china clay* added increases the whiteness of the ware and reduces shrinkage and liability to fracture under sudden changes of temperature. The amount usually present is about half that of the ball clay, but equal parts of each are sometimes used. The larger the proportion of china clay the whiter and better will be the ware. *Flint* is added in quantity about equal to, or rather less than, that of the china clay, and *Cornish stone* to about half that of the flint. A typical earthenware is therefore composed of:—

Ball clay	-	-	-	46 per cent.
China clay	-	-	-	23 „
Flint	-	-	-	21 „
Cornish stone	-	-	-	10 „
				100

Recipes for earthenware bodies are of small value, for the conditions vary in each works and in the manufacture of each kind of ware, so that each potter has to modify the composition of his mixtures to suit his special requirements.

In practice, the materials are not weighed out, but are converted into a fluid state by mixing them with water, the required quantities of the *slip* or *slurry* so produced being then measured in order to obtain the mixture desired.

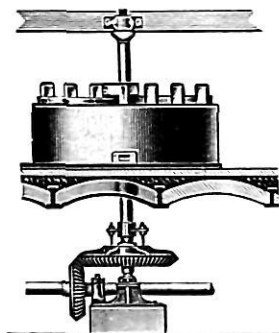

FIG. 1.—Wet Grinding Mill.

(By courtesy of Messrs T. Willett & Co.)

This arrangement overcomes the difficulty which would otherwise be caused by variations in the proportions of moisture in the different materials, and saves the necessity of determining the proportion of such moisture and allowing for it.

As it is essential that the composition of the body should be as uniform as possible, all the raw materials must be in an extremely fine state of division. The particles composing the clays are, naturally, so small that no crushing is necessary, but the flint and Cornish stone, and any other materials used, must be ground in mills kept exclusively for this purpose.

In the Staffordshire potteries the grinding of these materials is a trade to itself, the millers supplying both flint and Cornish stone in the form of a slip of which each pint weighs 32 oz. (= sp. gr. 1.60). When this is the case these slips do not require to be blunged, but are stored in tanks until required.

Each raw material, with a suitable quantity of water, is measured out roughly and discharged into a vertical tank termed a *blunger* (Fig. 2). This machine is fitted with a vertical shaft carrying horizontal blades which, when rotated, effect a thorough mixing of the materials and water, and produce a creamy slip. This is then run into a storage tank or into a mixing ark.

The thoroughness of the blunging, and the uniformity of composition of the slips, will depend on the correct design and construction of the blungers. These should be hexagonal in shape, and the internal blades should be of such a shape, and set at such an angle, as will give the most thorough mixing motion. It is much better to buy them from a firm of pottery engineers than to attempt to design them and have them made elsewhere.

The blunged material must be tested as to its specific gravity. This is usually done by measuring out exactly one pint of the slip and weighing it accurately. It is important not to have too dense a slip as it will tend to settle too rapidly; too watery a slip, on the contrary, will not mix readily with other slips.

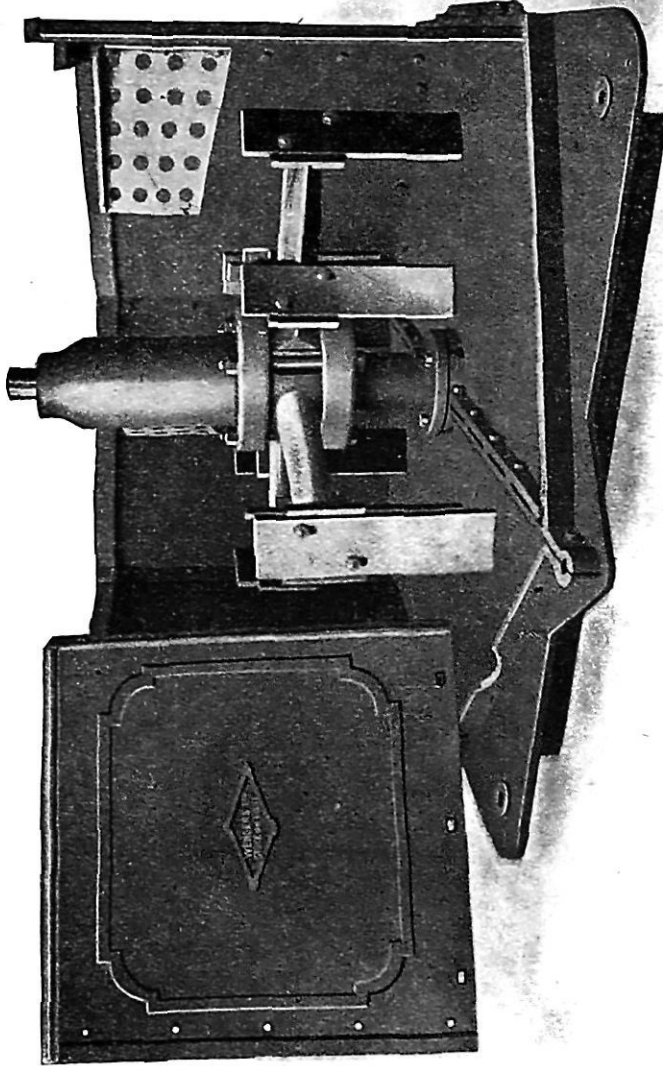

FIG. 2.—Blunger (showing Interior).  
(By courtesy of Messrs Wengers Ltd.)

The following densities have been found by long experience to be the most generally suitable:—

Ball clay slip, weighing	-	-	24 oz. per pint.
China clay slip, weighing	-	-	26 „ „
Cornish stone slip, weighing	-	-	32 „ „
Flint slip, weighing	-	-	32 „ „

It is generally desirable to blunge the materials to a slip of slightly greater density than those given, and to make the final adjustment by adding water and again blunging for a few moments, the operations being repeated until the desired “weight per pint” is obtained. As much depends on the density of the slips being accurately known, great care should be taken in this stage of the manufacture.



The various slips, in suitable proportions, are next run into a mixing ark, or light blunger, the quantity of each being usually measured in inches of depth of slip in the ark.

As the sides of the mixing ark are vertical, it is clear that the volumes of the slips added will be proportional to their depth in the ark, and a lath marked in inches and immersed vertically in the latter will serve to measure the volumes with sufficient accuracy.

The order in which the various slips are run into the ark is of some importance; the most satisfactory order is ball clay, china clay, flint, stone and stain. Scraps of body which have been blunged up into slip may also be added, if desired; this is frequently done as it appears to facilitate the working of the body and to increase its plasticity.

The various materials are now mixed together by rotating the blades in the mixing ark—which resembles a blunger—and when a uniform slip is obtained, it is pumped on to sieves termed *lawns*. These usually consist of tiers of rectangular wooden trays, the bottoms of which are made of silk or phosphor bronze wire gauze.

Three lawns are employed, one above the other, the coarsest being at the top. The usual meshes are those known as 14's, 16's, and 18's, but the latter—being very fine—is sometimes omitted. In order to increase the speed of sifting, the lawns are given a "to-and-fro" motion by means of a crank and eccentric.

The slip which has passed through the lawns is next allowed to flow through a trough containing a number of electro-magnets which retain any particles of metallic iron which may become adventitiously mixed therewith.

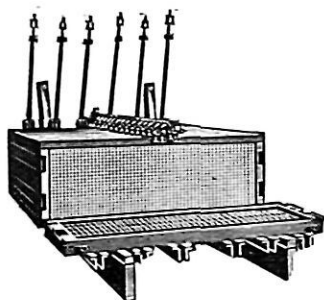

FIG. 3.—Filter Press.  
(By courtesy of  
Messrs T. Willett & Co.)

Unless these particles are removed, the ware will become yellow and spotty. The magnets must, of course, be cleaned periodically.

The slip is next run into a *finishing ark* where it receives its final mixing before going to the filter presses.

The slip usually weighs about 26 oz. per pint, and so is far too fluid to be used by the potters—except in the process of casting—and must have a considerable proportion of its contained water removed without "unmixing" the other materials. The best means, known at present, for effecting this is by means of a filter press, but the process is so clumsy and intermittent that an improved method is greatly to be desired.

In the filter press (Fig. 3) the slip is pumped or run into cotton bags which are then subject to pressure so as to squeeze out most of the water whilst still retaining the clay. When as much water as possible has been removed, the cloths are opened and the cakes of clay, measuring about 5 ft.  $\times$  1 ft. 6 in.  $\times$   $\frac{3}{4}$  in., are taken out and rolled up.

In order to produce a homogeneous mass the cakes are placed in a pug mill which resembles a large sausage machine. In this, the clay is cut, squeezed and mixed until it emerges from the machine in a solid, uniform pasty mass, which is cut into lumps by means of a tightly stretched brass wire and is taken to the workmen, or to the clay store, as may be required.

In some works, the older process of *wedging* is still used, the cakes being dashed hard on one another, sliced with wire and the pieces again dashed on each other, this being continued until a uniform paste is obtained. This method is slow and tedious and depends for its success on reliable men who can be trusted not to shirk the hard work involved; except for special work, therefore, it is largely being replaced by the more rapid and, in most cases, equally efficient pug mill.

*Consistency.*—There is for each mixture of clays, etc., a definite consistency at which it is easiest to manipulate, and the potter must, therefore, take care that the correct amount of water is present in the pugged paste.

If too much water is present, the body will be too soft and adhesive, whilst if it is too dry it will not fit well into the moulds and will fall to pieces during later stages of manufacture. The consistency which is generally suitable is that at which the clay paste is sufficiently soft to be easily worked into any desired shape without it adhering to the fingers of the workman. An experienced potter can immediately tell by the "feel" of a piece of clay paste whether its consistency is what he desires.

The chief property possessed by all earthenware bodies of being capable of formation into any desired shape by the mere pressure of the fingers is termed *plasticity*. Little is known at present of the causes of plasticity, but it is a characteristic of most clays and is one of the most important distinctions between them and other substances. Further information on the subject will be found in the section on *Clays* (p. 142).

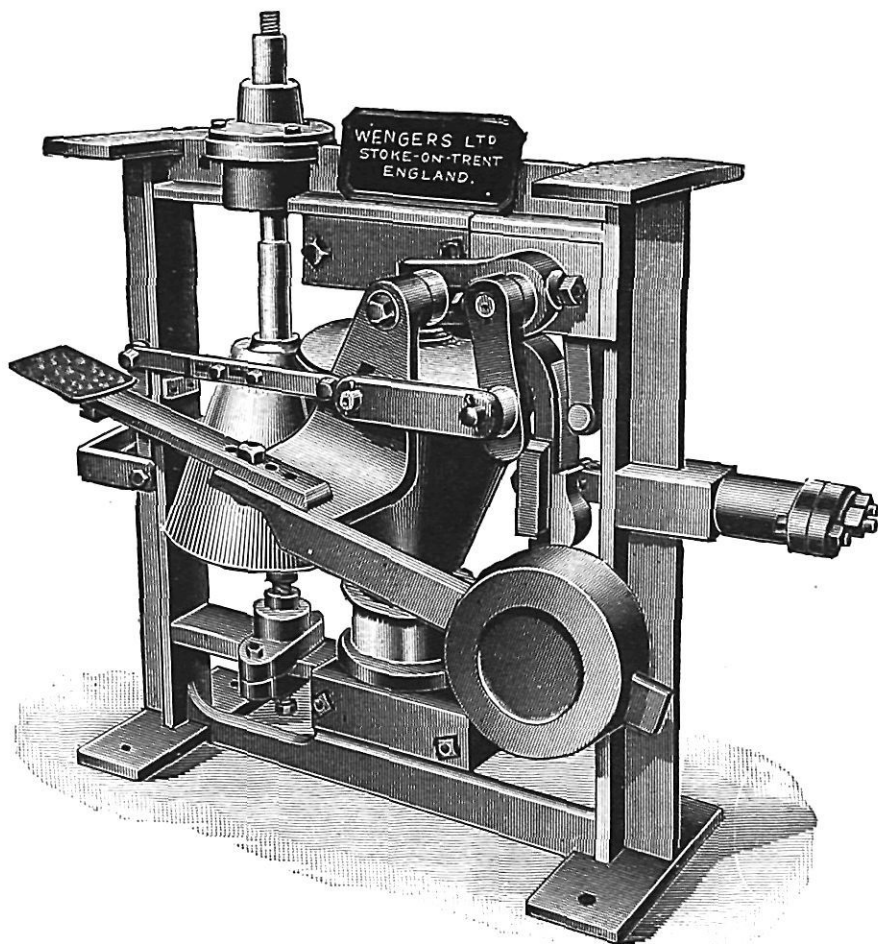

FIG. 4.—Potter's Wheel (Power-Driven).  
(By courtesy of Messrs Wengers Ltd.)

**Methods of Shaping Ware.**—In the production of earthenware, a number of processes may be used singly or in combination according to the articles to be produced. The most important of these methods are as follows:—

*Modelling*, which consists in giving a pasty mass of body the desired shape by cutting, pressing, and pulling portions of it. This is, in some ways, similar to the work of a sculptor in carving stone, but the greater softness and plasticity of the body enables the fingers and small wooden tools to take the place of the sculptor's hammer and chisel. Moreover, pieces of fresh paste can be added to the main mass whenever desired—a property that is only possessed by plastic substances.

Modelling is only used when a single article is to be made, or when a mould is to be produced. It is slow and somewhat tedious work, even when ample facilities are provided, but it is the starting point of all methods of manufacture.

*Throwing* is a special form of modelling in which the potter uses a rotating plate—the well-known “potter’s wheel”—on which to form the article. The earliest wheels were simply flat wooden discs mounted on an upright spindle and kept in motion by occasional blows administered by the hands or feet of the potter, but the modern wheels are more complex and are driven mechanically (Fig. 4).

In making symmetrical articles, such as vases and most domestic vessels, the use of a wheel greatly facilitates the shaping of the mass. The potter dashes a pasty lump of body on to the wheel and starts the latter rotating. He then wets his fingers in a bowl of water and applies them to the mass in such a manner that it rises and falls in a conical shape until it is well mixed and free from air-bubbles. He then forces his thumbs down on the centre of the mass, and with his fingers converts it into the desired shape, the final touches being given with various small tools made of wood, horn, or metal. The surfaces are then cleaned with a wet sponge, the article is cut from the base, by means of a stretched wire, and passed on to the next workman.

Throwing is skilled work and many precautions must be taken by those engaged in it, but these need not be mentioned here. It is sufficient to state that an incompetent thrower may produce articles which appear to be quite satisfactory when they leave his hands, though at a later stage they become twisted and warped through irregular strains and pressures applied by the thrower.

Many vessels may be finished by the thrower, but if great accuracy of shape is desired it is usual to have them “turned.” Unfortunately, throwers are being displaced by mechanical contrivances (presses) which produce similar results more rapidly and cheaply, though with less artistic value than those possessed by articles thrown by a clever potter.

Articles of complex shape are sometimes thrown in two or more pieces which are afterwards joined together.

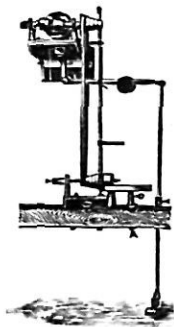

FIG. 5.—Lathe.  
(By courtesy of  
Messrs T. Willett  
& Co.)

*Turning* is a modification of throwing, and consists in treating the dried piece of ware on a lathe in a manner precisely similar to that employed by engineers in turning wood, steel or iron to a desired shape. The chief difference is that the dried body is so soft that very little power is needed for driving the lathe, so that a small treadle-lathe is generally used.

The turner is usually supplied with ware which has been “thrown” to almost the desired shape, and his work consists chiefly in finishing the ware, and giving it an accurate shape. In the manufacture of electrical fittings the degree of accuracy required is sometimes almost as great as that for metal, notwithstanding the great differences in the materials used.

By means of special attachments to the lathe, elaborate devices may be turned with ease and rapidity, and the demand for accurate and complex ware is such that much of the ware made mechanically in presses, etc., is now finished by turning it on a lathe. The finish given by turning is better, and the shape is more accurate than those obtainable by any other process of shaping. A crude form of turning is used for rough pottery, and is known as *fettling*.

*Moulding* is now the most usual method of shaping earthenware articles. The paste is placed in suitable moulds made of plaster of Paris, and is pressed into them either by hand or by some mechanical means, the surplus material is removed, and the mould is then set aside to dry. After some time, the contents are taken out and a replica of the article or model is thereby produced.

For some complex articles, the moulds must be made of many parts, but the principle is the same.

Potters do not usually employ the term “moulding,” but include this operation under “pressing,” even though no presses are used.

The simplest form of moulding is when the paste is pushed well into every part of the mould by hand, and after the article has been removed from the mould its surface is finished as may be required. This process is used for all articles which cannot be made on rotating machines.

An ordinary ewer, or jug for toilet use, is typical of the kinds of ware which are made in moulds. For plates, etc., the mould consists of a single piece, but for most hollow ware it is made of at least three pieces, the handle being made in a separate mould and attached later. The inside of the moulds is sponged with clean water, and the various parts are filled separately with a flat cake or bat of body, which is somewhat larger and rather thicker than the portion of the ware to which it corresponds. The body is carefully pressed well into the mould, and any excess is carefully removed. The various parts of the mould are now fastened together, and the "joints" or spaces between each piece of body are carefully obliterated by working with the fingers, more body being added if necessary. When the various pieces of body have been properly united, the inside surface is trimmed to shape with a small scraper, and is finished with a sponge and clean water, until it is as smooth as possible. The mould with its contents is then set aside until the body is sufficiently stiff for the mould to be emptied with safety. After this, the article is trimmed externally, the handle is attached by means of a little body slip, and the whole surface of the article is then finished with a wet sponge and a piece of leather or linoleum until it is quite smooth.

The article is then taken to the "stove" or drying chamber. Each workman will require a large number of moulds to keep him fully occupied.

The moulds soon become "sick," and will not deliver the ware properly; they must then be cleaned by carefully scrubbing the interior with a wet brush. If this and a thorough drying does not revive them, they must be discarded.

*Jollying* is a form of moulding which is more rapid and requires less skill than hand pressing. The jolley consists of a mould fitted on to a kind of potter's wheel (Fig. 6), and the lump of body is thrown into it. A piece of pottery, wood, or steel—termed a profile—attached to a suitable framework—termed a jigger—is then brought down on to the paste, and the pressure it exerts, in combination with that of the rapidly rotating jolley, rapidly converts the lump of body into an article of the desired shape.

Jollying is, therefore, a combination of processes whereby the exterior shape of the article is moulded, and the inside is simultaneously turned. This process is sometimes reversed, as in the manufacture of plates, which are made upside down, the profile forming the "bottom" of the plate, and the mould the face or interior.

It is often convenient to use two machines, one to form a flat disc or *bat* of paste, and the other to give this the final shape desired.

*Presses* of various patterns are used for wares required in large quantities, the most usual form for earthenware being a jolley or jigger. For hearth tiles and other wares not readily formed by jolleys and jiggers, toggle-levers or screw presses (Fig. 10) are largely employed. These presses are provided with metal moulds consisting of two chief parts—the *box* which is attached to the bed of the machine and the *plunger*, or moving part, which fits into the box.

A suitably sized lump of paste is placed in the box, and the plunger brought down forcibly by means of the mechanism provided. The body, being under great pressure, is thus made to occupy all the interstices in the mould, and any excess of material is forced out through an escapement. On reversing the machine, the plunger is raised and the article may then be taken out of the mould.

As these metal moulds are costly, and only applicable to articles of comparatively simple shape, the use of presses is limited to certain wares, such as tiles, which are required in enormously large numbers. Many manufacturers are now, however, preferring to use dust instead of a plastic body when such presses are employed.

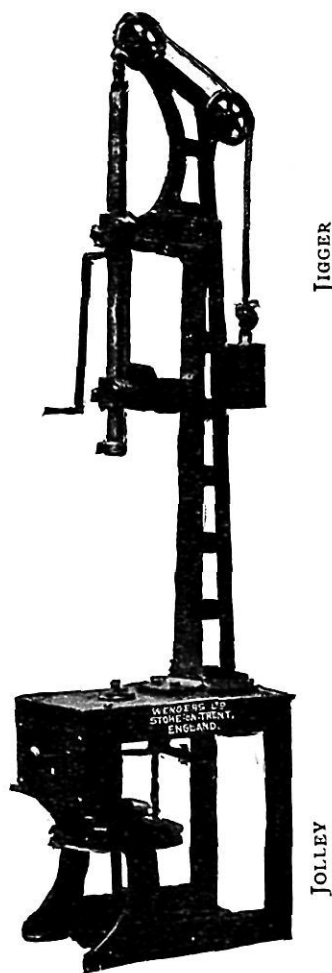

FIG. 6.—Vertical Jigger and Jolley.

(By courtesy of Messrs Wengers Ltd.)

*Casting* is a form of moulding which is specially suitable for very thin ware, though in some instances it may be used for thicker articles. The moulds used for this purpose are of plaster, and a body slip—carefully lawned to free it from grit—is poured gently into the moulds. The plaster absorbs most of the water from the slip, and after a short time the mould is inverted, any remaining slip is poured out, and the mould is left for the body within it to dry and shrink. This does not take

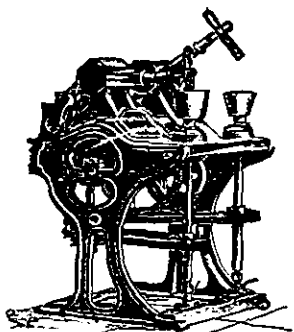

FIG. 7.—Automatic Cup-making Machine.  
(By courtesy of Messrs  
T. Willett & Co.)

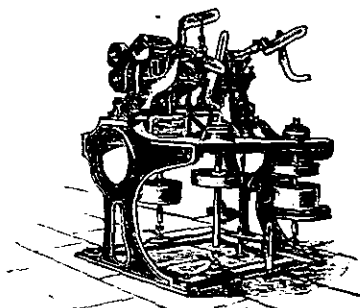

FIG. 8.—Automatic Machine for making Wash Bowls, etc.  
(By courtesy of Messrs  
T. Willett & Co.)

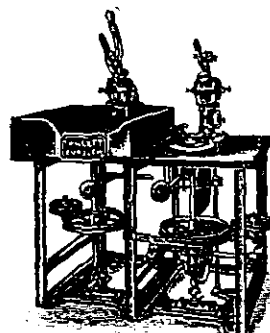

FIG. 9.—Plate-making and Batting Machine.  
(By courtesy of Messrs  
T. Willett & Co.)

long, and the body can then be taken out of the mould in the form of an article which usually requires retouching.

For successful casting the slip must be very fluid, but must contain only a little water. The addition of a small percentage of alkali, and particularly of baryta, to the clay reduces the proportion of water needed to make the slip fluid, by 40-45 per cent.

Cast ware is very porous, and shrinks greatly on drying; it is more largely used for porcelain than for earthenware, though there are many earthenware articles, such as spouts for tea and coffee pots, which cannot be made so easily in any other way. This method is also of special value for thin ware of a complicated pattern.

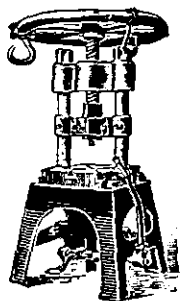

FIG. 10.—Screw Tile Press.  
(By courtesy of Messrs  
T. Willett & Co.)

*Expression* of the body through a die or mouthpiece fitted on to the exit end of a pug mill is only used for the cheaper handles and similar solid parts of articles. In the manufacture of bricks and tiles, on the contrary, this is one of the most important methods of manufacture; it is described in the section on Bricks (p. 208).

*Finishing*.—There are a number of minor processes through which the articles must pass before the shaping can be considered to be complete. The surface may be *scraped* and *polished* in order to remove blemishes; some portions may require to be *carved* or *undercut*; others must be *repaired* by the addition of a little fresh body followed by gentle trimming and polishing.

*Slipping* and *sticking up* are terms employed for fastening handles, feet, spouts, and other accessories on to articles; it is generally advisable that distinct projections such as these should be moulded separately, and afterwards stuck on to the article; to mould the whole at once greatly complicates the manipulation, and prevents the ware being made so satisfactorily. *Sticking* consists primarily in moistening and pressing together the two parts to be joined, and uniting them by working in a small roll of plastic body. *Slipping* is used for less plastic bodies; it consists in covering the surfaces to be united with body-slip and then pressing them together.

*Engobing* consists of the application of a coating of a body different from that of which the article is made. Thus, earthenware articles may, for the sake of

cheapness or for some special reason, be made of a body whose colour, when fired, is undesirable. Such a body can be covered with an engobe of superior clay, and in this way can be made to resemble first-class earthenware.

Engobes are, usually, of the same composition as the best earthenwares, but it is sometimes convenient to add a little extra flux or glaze to them, in order to increase their adhesion to the body of the ware. Where a coloured engobe is required, the appropriate stain (p. 163) is added to it before use. They are applied in the same manner as glazes, but occasionally the engobe is placed in the mould in which the article is to be made, and the coarse material is then used to form a "backing."

*Drying Earthenware.*—Owing to the large amount of moulds and of space which would otherwise be occupied, and the necessity of avoiding draughts, it is almost imperative that some form of artificial drying should be employed, and

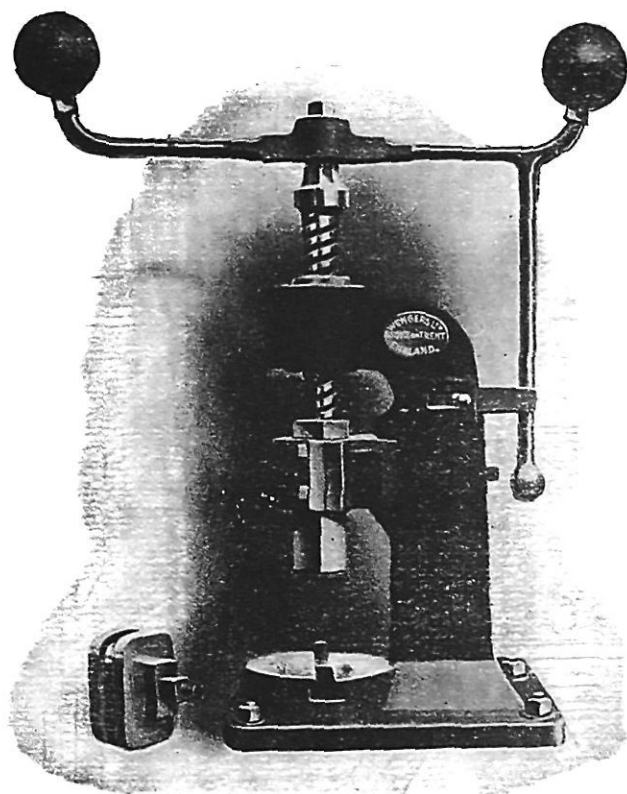

FIG. 11.—Screw Press for Small Ware.  
(By courtesy of Messrs Wengers Ltd.)

*drying stoves* are generally used for this purpose. Each mould must be dried before its contents can be removed, so that the stoves must have ample capacity for all goods that each maker can produce. Many stoves now in use will hold a thousand or more moulds.

The ordinary drying stove for fine earthenware consists of a series of shelves about 10 ft. high and 12 ft. square, arranged on the axes of a hexagonal frame (Fig. 12) with just sufficient space between each shelf for it to accommodate the moulds. The frames carrying these shelves are mounted on vertical shafts so that they can be rotated slowly. They are enclosed in compartments which are heated by steam or hot-water pipes near the floor, several frames being placed in each compartment. Opposite the centre of each frame there is a door of just sufficient width to enable the moulds in one arm of the frame to be put on or removed, as desired. The use of an enclosed stove of this pattern, with a narrow doorway, enables the heat to be used to the best advantage, whilst also allowing ready access to all the goods in the stove.

For very large articles fixed shelves around the walls of the drying room are generally employed.

When the articles in the moulds are sufficiently dry they are removed, placed on a revolving table, termed a *whirler*, and carefully sponged or rubbed with a piece of leather to give them the necessary finish. Wares of a specially fine nature sometimes receive a further polishing by means of flannel or tow, applied to the almost dry body. If necessary, they are replaced in the stoves and the drying completed.

The finished goods are then ready to go to the kilns or ovens. Plates are placed in bungs consisting of twelve plates placed one above the other.

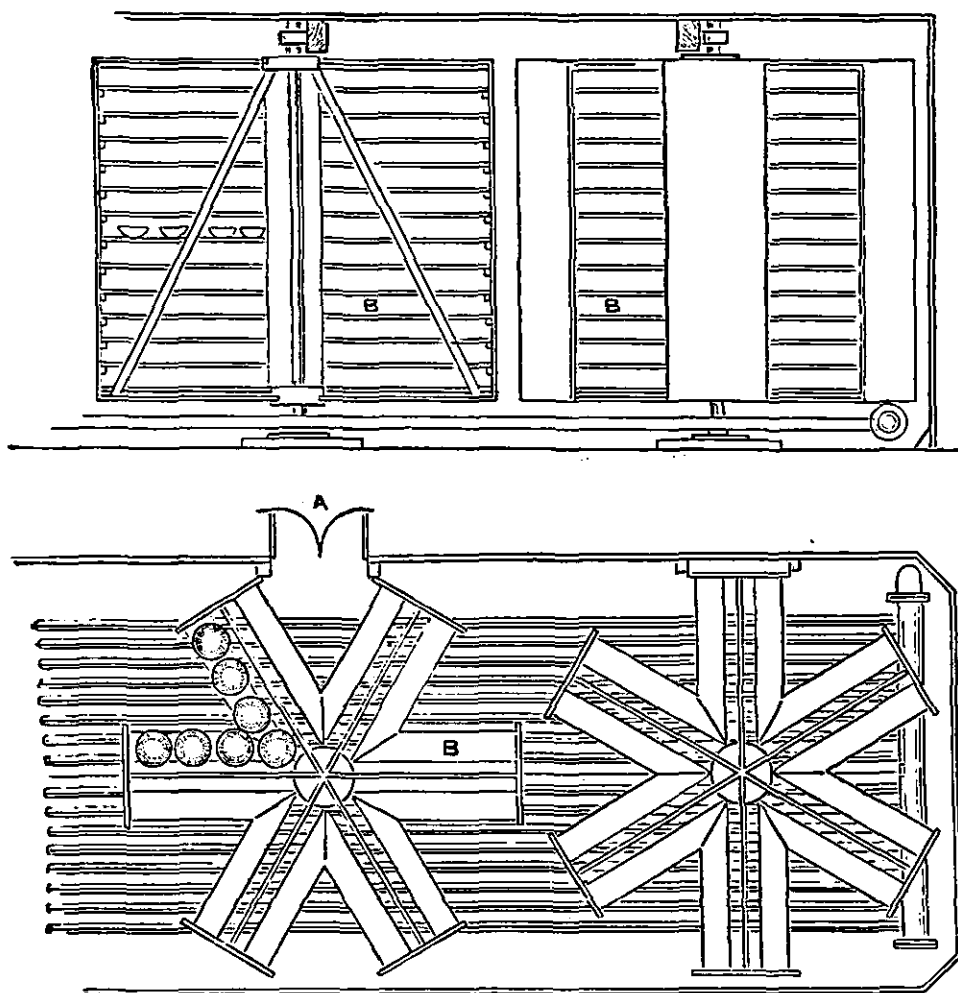

FIG. 12.—Section and Plan of Drying Stove.

**Shrinkage.**—During drying, the water present in the pasty body is removed in two ways: (*a*) by absorption by the plaster, the pores of which are too fine to allow the clay to pass through them, and (*b*) by evaporation. In each case the removal of the water produces a reduction in the size of the articles, and allowance must, therefore, be made for this shrinkage. The amount of contraction differs with different bodies, but is usually about one-twelfth of each dimension of the article, except in cast ware in which it may be much larger.

Bodies with a high shrinkage on drying usually have a strong tendency to warp and crack, so that it is desirable to keep the shrinkage as low as possible. This may be done by substituting china clay for some of the more plastic clay or by the addition of flint. A certain amount of plastic clay is, however, essential; without it the particles cannot be kept together. Hence, all articles made from a plastic body invariably shrink during drying.

In small, thin pieces, the shrinkage and drying do not usually present great difficulties, but in larger and thicker ware the greatest possible care is needed, and the drying must be exceedingly slow.

Further information with respect to shrinkage will be found in the section on Clays (p. 142).

**Ovens.**—For burning earthenware, round vertical kilns, or *ovens*, are chiefly employed. In shape they resemble a large, but stumpy, bottle, and consist of a cylinder of brickwork about 8 ft. 6 in. high, above which is a high dome surmounted by a chimney. Around the circumference of the oven is a number of fireplaces, the flame and gases from which enter the interior of the oven and pass partly up small chambers or *bags* and amongst the contents, and partly down through the floor or *sole*. Both sets of flame and gases eventually rise up through the kiln and finally pass out through the chimney at the top.

Sometimes the oven proper is quite independent of its chimney. The latter is then built in the form of a large bottle-shaped structure which completely surrounds the kiln and is termed a *hovel* (Fig. 15).

This arrangement prevents the wind from blowing the fires and so disturbing the heat of the oven: it forms, however, a very hot and confined space in which the firemen work and the draught is liable to be feeble and irregular.

Down-draught ovens (Fig. 16, p. 215) have long been used on account of the even temperature which can be produced in them. They are of various patterns and often differ considerably in their constructions, but in all cases the flame and hot gases from the fuel first rise up inside the walls of the oven until they reach the dome; they are then turned downwards and, passing through one or more openings in the floor of the oven, they travel through a series of flues to a separate chimney.

In order to economise fuel, two ovens are sometimes built on top of each other (Fig. 14), the waste gases from one then passing into the next oven.

Many attempts have been made to use tunnel ovens, into which the goods are introduced at one end, heated slowly until they reach the centre of the oven—where they attain their highest temperature and then cooled gradually until they pass out at the further end. With few exceptions, tunnel kilns (Fig. 16) have not proved successful for earthenware, but are useful for gilding, overglaze firing and patching defective ware (see p. 181).

There appears to be much room for improvement in the design and construction of ovens for earthenware, but large scale experiments are far too costly for most potters to be able to attempt them. Thus an application of Hoffman's continuous kiln would prove highly economical in fuel, but such a kiln has never been used on a large scale for earthenware in this country.

The use of gas instead of coal also offers several important advantages, but no gas-fired kiln for earthenware has yet been built in Great Britain.

The conditions and changes which occur inside a large potter's kiln are highly complex, and as a small variation in the manner of working the kiln may spoil the whole of its contents, it will easily be understood that very few potters are willing to risk thousands of pounds on a doubtful economy in fuel or a small improvement in their ovens. That large improvements are possible is beyond all doubt, but the great difficulty is the serious loss which would probably have to be faced before the improved kiln was a commercial success.

**Setting or placing** are terms used for what, in less technical language, would be designated as "filling the oven." The earthenware is first placed in oval or

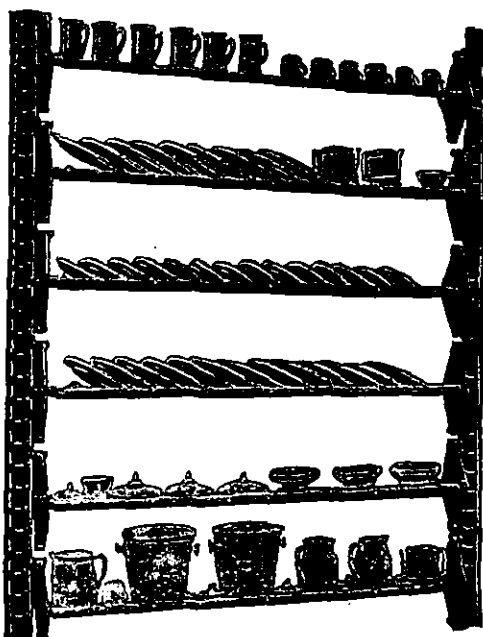

FIG. 13.—Movable Shelves in Vertical Drier.  
(By courtesy of Messrs T. Willett & Co.)



round boxes made of fire-clay (termed saggars), and these are then piled one on top of the other until the oven is "filled."

The earthenware is so tender that it requires great skill and care to place it properly in the oven. A single sagger full of plates is a heavy and difficult article to manipulate, especially as many of them have to be carried up ladders.

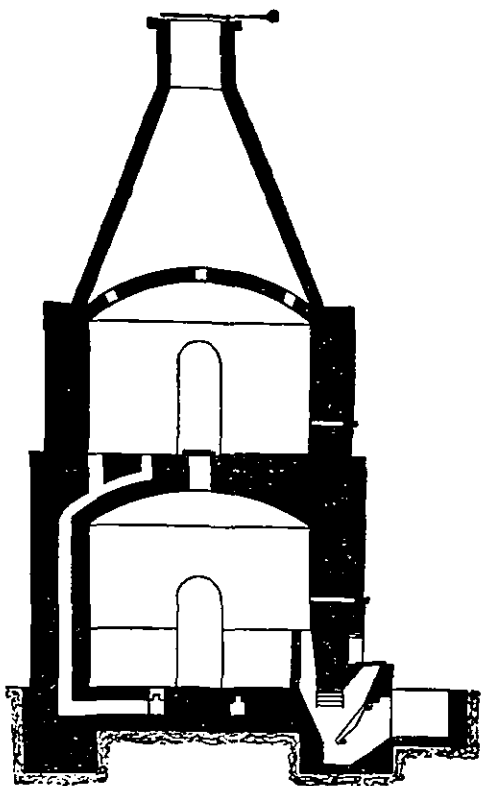

FIG. 14.—Vertical Section and Plan of Double Oven.

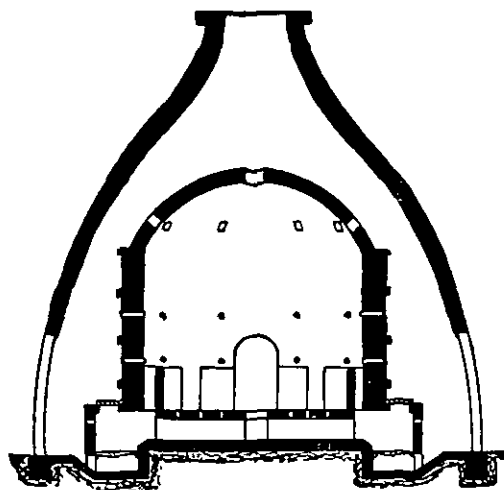

FIG. 15.—Section and Plan of Hovel Oven.

*Biscuit* or unglazed ware is easier to place because the pieces can be laid on each other so long as there is not too much weight on any portion of the ware. The skill of the setter in biscuit placing consists, therefore, in placing the largest quantity of ware in the kiln.

In placing *glazed ware*, or *glost*, the glazed surfaces must, as far as possible, be kept out of contact with any other surface, and the ware is therefore supported on "pins," "spurs," "thimbles," and other specially shaped pieces of fire-clay, the sharp edges or points of which are designed not to spoil the appearance of the glazed surface of the ware.

Much ingenuity has been exercised in devising means of placing glost ware in saggars; detailed descriptions of these devices are given in Bourry's "Treatise"<sup>1</sup> and other technical works.

The number of saggars in an oven is very large, being usually above 2,000. They are arranged in a series of *rings*—usually five—and are piled on one another until the oven is filled. Sufficient space must be left between the piles or *hungs* of saggars to permit the proper circulation of the fire gases.

To prevent the flame entering the saggars and discolouring the ware, they are luted with sand or clay—preferably the latter. The lute also affords a means of properly bedding the saggars on each other; if this is done carelessly the loss resulting from the breakage of saggars will be serious.

**Firing.**—The firing of earthenware biscuit requires great care and skill. It is necessary to heat steadily and slowly, so that the water evolved on the decomposition of the clay may not escape too rapidly and so damage the ware. The ware shrinks as the water is removed, and if the heating is irregular the ware will twist and warp to such an extent that it becomes useless.

This second, or kiln shrinkage, is only about one-third of that on drying, but if the rate at which it occurs is excessive the possibilities of damaging the ware are very large.

The temperature finally attained in the biscuit oven is about 1,200° C., the ware being heated until it has attained the desired hardness and density rather than to any definite temperature. Some potters find it better to heat for a long

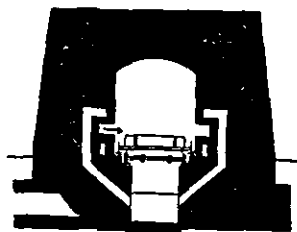

FIG. 16.—Cross Section of Tunnel Kiln.

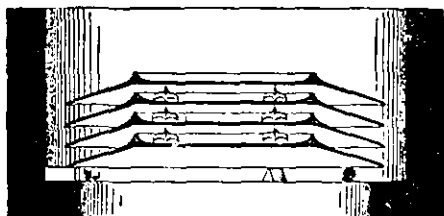

FIG. 17.—Plates in Sagger.

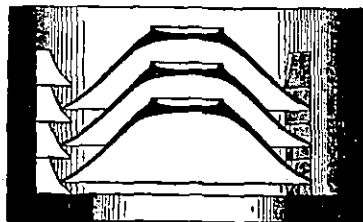

FIG. 18.—Basins in Sagger.

time at a somewhat lower temperature, others prefer a higher temperature and a shorter heating.

*Trials* made of pieces of earthenware, are placed in convenient parts of the oven, and are drawn out through special trial-holes. By drawing out trials at regular intervals from various parts of the oven, the extent of the action of the fire on the ware can be ascertained. Various pyrometers—including the very ingenious shrinkage-gauge of Wedgwood and the Seger cones (Vol. I., p. 74)—are also used for ascertaining when the firing of the ware is likely to be finished.

Skilled firemen can judge the temperature of a kiln by looking at it carefully, and when accidents have happened and part of the inside or contents of the kiln have slipped, the fireman is frequently compelled to rely entirely on his experience of the "colour" of the kiln to enable him to finish the burning.

In order that the ware may be burned economically, the fireman must heat it as rapidly as is consistent with safety, and in order that the heat may be uniform he must carefully regulate his fires and the quantity of air admitted. The coal used should be long-flamed and of fairly good quality; it costs more to use a poor coal than a better one on account of the longer time needed for heating.

<sup>1</sup> Figs. 12, 14, 15, 17, and 18 are from Bourry's "Treatise on Ceramic Industries."

There are many opinions as to the best methods of heating ovens for earthenware biscuit, but the most satisfactory ovens are those in which the temperature is raised steadily until the finishing point of the ware is reached, and in which this temperature is maintained as long as may be necessary. Flat ware, such as plates, dishes, etc., requires a long time to gain the temperature of the oven, and holding the fire at the finishing temperature—a process technically known as *soaking*—is almost essential. Soaking at a temperature much below the finishing point is almost useless with earthenware.

For thirty hours, the oven requires little attention beyond steady firing, but, about twelve hours before the end, difficulties commence. The most critical time of all is the last firing or *baiting*; at this point the temperature must be raised with great care, and the indicators, trials, etc., must be very carefully observed.

When the firing is finished, the oven is luted up and left for at least twenty hours so as to cool uniformly. After this it may be partly opened, and eventually it may be emptied, *i.e.*, *drawn*.

The product is biscuit or unglazed earthenware; it must usually be glazed before use.

**Glazes.**—In the manufacture of earthenware a glaze or glassy covering is essential, as the body of the ware is porous, and easily becomes dirty. Earthenware glazes are fired at a somewhat lower temperature than the body, but very soft glazes fired at an exceptionally low temperature are undesirable, as they are very liable to crack and peel off, and are apt to be poisonous because of the soluble lead salts formed. Readily fusible glazes which are free from lead have not, as yet, proved commercially satisfactory.

As already noted (p. 160), the glazes used for earthenware are chiefly composed of some of the following: borax, soda, potash, china stone, flint, whiting, china clay, and one or more lead compounds. As some of these substances are soluble in water, they could not be used in the ordinary methods of applying the glaze to the ware (*i.e.*, by dipping), and such substances must, therefore, be converted into insoluble ones. This conversion is affected by fusing certain ingredients of the glaze together, thus forming insoluble silicates, alumino-silicates or boro-silicates, according to the substances present. This process is known as *fritting*, and the fused product is termed a *frit* (p. 162).

The following are typical mixtures for making frits for earthenware glaze:—

#### MIXTURES FOR FRITS.

	A	B	C	D
Borax . . . . .	30	36	39	24 <sup>1</sup>
Cornish or china stone . . . . .	30	20	23	21
China clay . . . . .	5	6	7	10
Flint . . . . .	15	20	18	20
Whiting . . . . .	20	18	13	14
Soda ash . . . . .	...	...	...	11

The frit mixture is placed in a reverberatory kiln and, when fused, is run into water which granulates it. If the granulation is properly effected there is no need to grind the frit before preparing the glaze.

*Earthenware glazes* are usually made of the following ingredients mixed in proportions similar to those stated on the next page:—

<sup>1</sup> Boracic acid.

## MIXTURES FOR GLAZE.

	A	B	C	D
Frit - - - - -	50	36	58	55
Cornish stone - - - - -	25	40	16	25
White lead - - - - -	25	24	22	20
Flint - - - - -	...	..	4	...

The glaze or tube-mixture is ground with water to an extremely fine powder in a ball-mill, Alsing cylinder or chert-lined mill, and is carefully sifted through *lawns* of silk or phosphor bronze. It is then run into a blunger, the arms of which are fitted with electro-magnets so as to remove any adventitious particles of iron, or these particles may be removed by running the glaze-slip through a trough fitted with powerful magnets.

It is necessary to adjust the composition of the glaze accurately if the best results are desired, and this is all the more important as glazes do not appear to be definite chemical compounds, but are of the nature of one solid dissolved in another ("solid solution"). If conditions are favourable, crystals of definite compounds will form in the glaze, but as these destroy its value, the glaze maker is careful to avoid forming such crystals.

The effect of the various ingredients on each other has already been mentioned (p. 162), and their constitution and composition are so complex as to form one of the chief subjects which a ceramic chemist must study. Usually, the greater the proportion of metallic oxides or of boracic acid or borax in a glaze, the lower will be its melting point, but much depends on the nature of the other constituents. White lead is the chief and most useful flux employed by potters in the production of earthenware glazes, and though many attempts have been made to avoid its use this has only proved possible when the glossiness or some other important characteristic of the glaze has been partially sacrificed. The use of barium compounds has proved valuable, but not sufficiently so to enable the use of lead to be discarded. There is scope for an extensive investigation as to what element, if any, can replace lead in earthenware glazes; at present, no substance is known which is entirely satisfactory for this purpose.

Glaze is applied to earthenware which has been fired (biscuit) by dipping the article into the glaze slip. The earthenware is porous and absorbs the water in the slip, leaving the article covered with a thin coating of glaze mixture. Mechanical dipping and glazing appliances are sometimes used, but skilful handwork is better.

The ware is allowed to dry and is then taken to the kiln, placed in saggars, and fired until the glaze has fused to a uniform glassy covering. Any support coming in contact with a glazed surface will spoil the latter at that point, and it is therefore necessary to keep these points of contact as small as possible (see "Setting").

During the second heating in the kiln—which is known as *glaze-firing*—the materials forming the glaze fuse to a molten glass and combine sufficiently with the body of which the ware is made to form a strongly adhesive and impervious coating. If this coating, or glaze, has a coefficient of expansion appreciably different from that of the body, strains will be set up in both body and glaze, and the latter will crack or peel off. Ordinarily, glazes are transparent, but opaque glazes (enamels) are sometimes used in the production of white ware from a coloured body. The usual opacifying medium is oxide of tin.

The kilns used for firing glazed earthenware are of the same type as those used for burning earthenware biscuit, but a lower temperature is required for the glaze.

## THE DECORATION OF EARTHENWARE

The decoration of earthenware may be effected in various ways. The body of the article may be modelled, carved, or moulded so as to form an attractive design. Coloured clays may be used to form some portions of the article, or designs may be "painted" or sprayed on the ware with suitable pigments. Where large quantities of ware with the same designs are required, it is customary to mix the colours with a special oil, then to use this mixture to print the designs on suitable paper and to transfer it to the ware. This is known as "printing."

The application of the colours may be made (*a*) to the body and below the glaze—*underglaze* decoration, (*b*) in the form of a stained glaze (p. 163), or (*c*) to the glazed earthenware—*overglaze* decoration.

Of these, the first is the most permanent, as the design is completely covered by the glaze, and the overglaze decoration is the least durable because it is on the surface of the ware.

The colours used for underglaze decoration are more limited than those for overglaze work, because the former must resist the temperature and conditions of heating produced in burning the biscuit and glost ware. The overglaze colours, on the contrary, can be fired at any temperature which may suit them, and the widest possible range is thus obtained.

For *underglaze painting* the colours are finely ground, and mixed with turpentine or with gum arabic and water. They are then painted with brushes, or with small pieces of sponge cut to

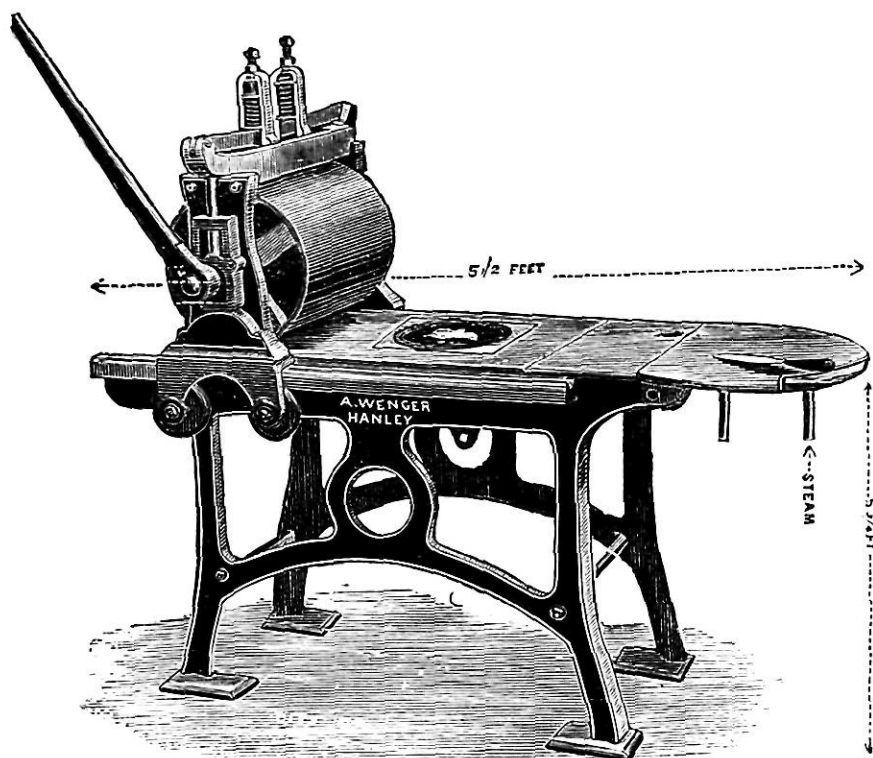

FIG. 19.—Printing Table.  
(By courtesy of Messrs Wengers Ltd.)

a convenient shape. The colour is “dabbed” rather than painted, and as there is no definite relationship between the colour, as used, and that which is seen when the ware comes out of the oven, underglaze decoration requires great skill, especially where the effects of light and shade are desired.

The decorated ware is next heated to a dull redness in a hardening chamber or kiln so as to burn off the turpentine and any other organic matter present, after which it is dipped in glaze, and then sent to the glost oven.

In *overglaze decoration* the same methods are employed, but they are applied to the glazed ware instead of to the biscuit. Owing to the wide range of colours required, these are seldom heated to more than 900° C. The colours are finely ground, and then mixed with a flux such as:—

Red lead	-	-	-	3 parts.
Borax	-	-	-	2 „
Flint	-	-	-	1 part.

This flux is really a readily fusible glaze, and its purpose is to fix the colour to the ware so as to cover and protect it, and to give a glossy finish where this is required.

The painting of overglaze work is easier than that of underglaze as the colours change but slightly in the oven, and losses in firing are very small. It is specially used for heraldic ware, gilding, and for many classes of pottery bearing elaborate chromo-lithographic designs.

Overglaze decorated ware is usually fired in muffles, but several firms who have used a simple form of tunnel kiln (Fig. 16) have found it more economical and satisfactory. In this kiln the goods are placed in iron baskets or on small cars at one end of the tunnel, and are moved forward until they reach the centre. This is the hottest part of the kiln, and as soon as the ware is "finished" it is moved forward towards the other end of the kiln. The temperature of the ware then falls gradually, and on removing it from the kiln it can be handled without inconvenience.

The heating is effected in such a kiln in a remarkably uniform and economical manner, and the gradual rise and fall in the temperature of the ware is conducive to satisfactory results coupled with a large output. Such kilns are better than the ones ordinarily used for this class of work, but they require a large output if they are to be worked economically. Tunnel kilns are also used to a small extent for other classes of ware at which much higher temperatures are required, and some potters consider that they will be used very extensively in the near future.

For further particulars on overglaze decoration see the section on *Porcelain* (p. 189).

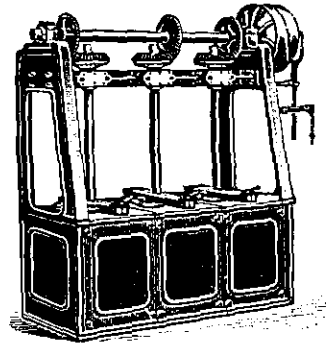

FIG. 20.—Colour Mill.

(By courtesy of  
Messrs T. Willitt & Co.)

## PROBABLE FUTURE PROGRESS

So far as can be ascertained, progress in earthenware manufacture will be in the direction of more economical and uniform heating of the ovens, and in the standardisation of existing methods. The increasingly keen competition in foreign markets necessitates the reduction of all waste to the lowest possible limits, and may not improbably result in a series of "amalgamations" whereby full advantage can be gained from the use of a large number of ovens connected together in such a manner that the best possible use is made of the fuel.

With existing (single) ovens placed some distance apart this waste is unavoidable. Improvements in grinding and other machinery and in the trades subsidiary to the manufacture of pottery, such as colour makers, etc., tend to the elimination of individuality in different firms, and induce conformity to a limited number of standards. This will further tend to reduce the costs of production, but will simultaneously lessen the value of the ware by robbing it of some, at least, of its individuality.

The large amount of research work now being carried on in connection with earthenware and other pottery tends to increase the number of colours and wares available, and also to reduce the proportion of defective ware. It is, however, so costly and so risky to make any appreciable alteration in the modes of manufacture that few firms are prepared to do this, so that progress, though steady, is necessarily very slow.

The amalgamation of existing firms into groups, or their replacement by much larger ones, is necessary if full advantage is to be taken of continuous (tunnel) kilns and other modern appliances, especially as very large outputs appear to be essential to low costs of production.

## SECTION LXVII

# PORCELAIN

BY ALFRED B. SEARLE  
*Consulting Technologist, Sheffield*

### LITERATURE

A very useful list of books and journals on the technical side of porcelain manufacture is given on p. 151; a more complete list is published in:—

A. B. SEARLE.—“*The Clayworker’s Handbook.*” London, 1906, 1911.

The decoration of porcelain from an æsthetic point of view is dealt with in an enormous number of papers and volumes, the most important of which will be found in:—

M. SOLON.—“*Ceramic Literature.*” London, 1910.

PORCELAIN is the noblest kind of pottery, its distinguishing feature being the possession of a vitrified, impervious, and translucent (or semi-transparent) body. There are many varieties of porcelain, some of them differing very widely from the others, the chief ones being (*a*) hard porcelain, (*b*) soft or tender porcelain, (*c*) china or bone porcelain, and (*d*) Parian ware—a variety of unglazed porcelain used for statuary, etc.

The general characteristics of the various porcelains have been briefly described under **Pottery** (p. 153).

**Raw Materials.**—*China clay or kaolin* is one of the chief constituents of porcelain, and the quality of the ware will vary according to the particular clay or kaolin used.

Even when the same material is used in two works, slight differences in the proportion of flux or in the heating of the ovens, will produce marked differences in the resultant porcelain, and the skill of the porcelain manufacturer lies chiefly in making the best possible use of the materials available to him.

Deposits of kaolin occur in various parts of the world, the most famous being those near Berlin and Meissen in Germany, at St Yrieux near Limoges in France, and the Cornish china clays in England. The German kaolins are largely derived from porphyry though some are of granitic origin. The French kaolins are derived from a species of gneiss (pegmatite), and the Cornish china clays have been formed by the decomposition of granite. Chinese and Japanese porcelains have been famous for many centuries.

Kaolins are white soft earths which differ from each other slightly in composition and texture, and even more so as regards the porcelain produced from them, but their characteristics are sufficiently marked for them to form a distinct variety of clay. When washed free from the coarser impurities, kaolin and china clay consists chiefly of an aluminosilicic acid,  $H_4Al_2Si_2O_9$ , the crystalline form of which occurs as the mineral kaolinite. In most kaolins the particles are so minute that it is almost impossible to ascertain whether they are crystalline or amorphous, and the length of time they remain in suspension in water has led to the conclusion that they are partly colloidal in nature.

Most kaolins are almost devoid of plasticity, but this property differs greatly in those of various origins. This lack of plasticity distinguishes the kaolins from the plastic clays and necessitates the employment of somewhat different methods of manufacture.

The chief impurities in kaolins and china clays are quartz, felspar, mica and various igneous rocks, some of which contain iron compounds. These may be largely removed by washing or

elutriation, but even the refined product contains upwards of 10 per cent. of impurities. Some of the kaolins used by the Chinese contain 25-30 per cent. of mica.

*Felspar*—chiefly from Norway—is a typical constituent of porcelain, in which it forms the chief flux and thereby gives translucency to the ware. It is a hard rocky material composed of 64.8 per cent. silica, 18.3 per cent. alumina, and 16.9 per cent. potash or an equivalent base such as soda or lime (see p. 161).

There is a considerable variety of felspars of similar characteristics but different compositions. The figures just mentioned refer to the variety known as orthoclase, which is the one chiefly used in pottery manufacture, though plagioclase felspars are also used to a small extent.

*Cornish stone or china stone* is a felspathic material occurring in Cornwall and used in the manufacture of English china and of some glazes. It is supposed to be similar to the Chinese *Pe-tun-tse* and to the French *pegmatite*, but differs from them very considerably in several important respects, and especially in fusibility.

The varieties of Cornish stone chiefly used have a composition corresponding to 6 per cent. potash, 18 per cent. alumina, and 76 per cent. silica and may be regarded as a mixture of felspar and quartz, though artificial mixtures of these two minerals do not produce quite the same results.

*Quartz* in the form of white sand, powdered quartz, or ground flint is used to reduce shrinkage in the ware and to provide the requisite amount of free silica (p. 163).

*Steatite*—a complex magnesium silicate—is used in the production of some porcelain such as insulators. It acts as a flux and also increases the plasticity to a small extent.

*Chalk* or some other form of calcium carbonate is largely used in the manufacture of hard or true porcelains. It has a powerful influence in effecting the fusion or vitrification of the body (see p. 162).

*Magnesite*, or magnesium carbonate, is occasionally used as a partial substitute for chalk.

*Grog*, or ground biscuit ware, is conveniently used in some porcelain glazes. It is also convenient for introducing clays into a body without altering the plasticity and moisture of the other materials. It consists simply of clean pieces of unglazed ware which have been crushed to powder (see p. 163).

*Bone ash* is prepared by heating the cleaned bones of oxen until a white mass is obtained which is then ground to powder. It consists chiefly of calcium phosphate with a little calcium carbonate and is a powerful flux.

As a constituent of porcelain it gives to the paste a plasticity fully as great as that of hard porcelain combined with the same range of colours as are available for the glassy porcelains.

**Porcelain Bodies.**—As stated on p. 153, there are many varieties of porcelain, and their compositions vary correspondingly. It is therefore necessary to consider each type of porcelain separately.

**Hard porcelain** is made with a body composed chiefly of kaolin, felspar and quartz, the proportions of each being adjusted to produce the desired effect.

Typical mixtures consist of—

	Sèvres.	Berlin.	Chinese.
Kaolin - -	38	77	47
Felspar - -	38	23	15
Quartz - -	24	...	38

The large proportion of clay and the absence of quartz in the figures given for Berlin porcelain are due to the fact that the Senewitz kaolin used there is so rich in mica. This mixture really corresponds to a porcelain made of clay substance 53 per cent., felspar 23 per cent., and quartz 22 per cent. From this it will be seen that the proportions of felspar and quartz used depend on the proportion of clay substance in the kaolin. The less quartz and felspar the harder will the porcelain be to burn, but the more resistant will it be to changes in temperature. For chemical ware



more clay is used. For very large articles, ground biscuit porcelain may be added so as to reduce the shrinkage without altering the composition. If the proportion of the last-mentioned material is large it may be necessary to add a little plastic clay to bind the particles together.

For electrical purposes (insulators, etc.), hard porcelain is extensively used. For this purpose, it must be fired at the highest temperature possible, and the ware must be rich in sillimanite or similar crystals. Owing to the demand for specially efficient insulators, the best of these are now made exclusively of china clay or of steatite, and, in the case of Marquardt porcelain, of china clay to which alumina has been added to make it more refractory.

Porcelain used for electrical and some other engineering purposes must be made with special care, and screws and other fittings must be almost as accurate as if made in metal.

The *glazes* used for hard porcelains are composed of the same ingredients as the body, but in different proportions, and chalk or marble is sometimes added so as to obtain a more fusible product.

A typical glaze for hard porcelain is that of Sèvres, which is made of—

Ground hard porcelain (grog)	-	-	-	25 parts,
Quartz	-	-	-	42 "
Chalk or marble	-	-	-	33 "

or that of the Royal Berlin Works, which is made of—

Felspar	-	-	-	8 parts.	Quartz	-	-	-	57 parts.
Kaolin	-	-	-	28 "	Marble-	-	-	-	7 "

**Glassy porcelains** are of little or no industrial importance.

Those made in France were composed of a calcareous clay or marl with a large proportion of fusible material, and closely resemble glasses of a complex character. In some cases so little clay was used that dextrin had to be mixed with the body to give it the necessary cohesion. The famous *pâte tendre* of Sèvres was made by fritting (p. 162) together—

Sand	-	-	-	60.0 parts,	Alum	-	-	-	3.6 parts,
Nitre	-	-	-	21.8 "	Gypsum	-	-	-	3.7 "
Salt	-	-	-	7.2 "	Soda	-	-	-	3.7 "

and mixing the frit thus formed with chalk and Argenteuil marl in the following proportions:—

Frit	-	-	-	-	-	-	-	75 parts.
Chalk	-	-	-	-	-	-	-	17 "
Marl	-	-	-	-	-	-	-	8 "

The composition of this porcelain closely resembles that of plate glass.

The *glazes* used for glassy porcelains are much more fusible than those for hard porcelains, and resemble the glazes used for earthenware. For French or glassy porcelain a typical glaze may be made by fusing together—

Litharge	-	-	-	38 parts,	Potash	-	-	-	15 parts,
Fontainebleau sand	-	-	-	27 "	Soda	-	-	-	9 "
Flint	-	-	-	11 "					

grinding the product and mixing it with water to form a slip.

For **bone china** or **English china**, the body is now composed of—

China clay	-	-	-	-	-	30 parts.
Bone ash	-	-	-	-	-	35 "
China stone	-	-	-	-	-	35 "

Wide variations occur in china obtained from different works, particularly with regard to the proportion of bone ash and china stone. A little ball clay is also added by some potters in order to increase the plasticity of the material.

Some of the earliest English chinaware bore a close resemblance to French porcelain, and it was only when Spode, about the year 1800, abandoned the use of glass that true English china was manufactured.

At one time or another almost every variety of porcelain has been manufactured in England, but what must be regarded as true English chinaware is made, as stated above, of china clay, Cornish stone and bone ash.

A typical glaze for such English or bone china is made of—

FRIT.				GLAZE.			
China clay	-	-	12 parts.	Frit	-	-	65 parts.
Quartz or flint	-	-	15 „	Cornish stone	-	-	11 „
Cornish stone	-	-	20 „	Flint	-	-	11 „
Chalk or whiting	-	-	18 „	White lead	-	-	13 „
Borax	-	-	35 „				

From this it will be observed that the glaze on English chinaware bears a very close resemblance to that used for the finest English earthenware. It differs less from the composition of the body, but the presence of lead, borax, and whiting have so great an influence that it is difficult to find any resemblance between the composition of the French and English glazes, and those used on the hard porcelains of the Continent and the East.

It is, in fact, largely owing to this difference in the composition and behaviour of the glaze that English and French porcelains possess so few of those special characteristics which render hard porcelains so valuable both æsthetically and for scientific and other purposes. The glaze on a hard porcelain so closely resembles the more fusible portions of the body to which it is attached that it has been aptly compared by W. Burton to the skin of the human body; the same writer comparing the glaze of French and English porcelain to a tight-fitting garment of an entirely different composition from the body which it clothes, or to a varnish covering applied to an article.

**Parian ware** is an unglazed porcelain which is admirably suited to the production of statuary. It has, however, also been glazed with a mixture similar to that used for earthenware or bone china, and then used with great success in the manufacture of table ware and vases. **Beleek porcelain**—the only porcelain made on a commercial scale in Ireland—is a glazed Parian ware.

According to W. Burton, glazed Parian ware corresponds exactly to the so-called Chinese soft paste porcelain, for which fabulous prices were at one time paid.

Parian body should be made of the same material as true porcelain, though the proportion of felspathic material is much higher.

A widely used recipe recommends—China clay, 1 part; felspar, 2 parts.

This is much more fusible than true hard paste porcelain. Some makers use the foregoing with an equal weight of white sand, and other potters have used glass and other fluxes in the manufacture of Parian ware. In one firm, the Parian body consisted of equal weights of hard paste and glaze. Great care is, however, required in the use of fluxes, or the ware will have an unpleasant greasy appearance, due to the excessive vitrification.

Like other porcelains, Parian body has so little plasticity that it is difficult to manipulate, and the best results are most readily obtained by casting (p. 172).

The shape of the articles must be within certain limits; some projections may be supported by pieces of raw body in the kiln, but this is always difficult in the case of the extended legs of prancing horses and of other figures with projecting parts.

**Chinese and Japanese porcelain wares** are frequently made of naturally occurring mixtures. Thus the Japanese Imari ware is made of a material containing 49 per cent. clay substance, 14 per cent. quartz and 37 per cent. felspar.

The ancient Chinese were, however, well acquainted with the use of felspathic material as a means of adjusting the composition of their raw material, and termed the latter *Kao-lin* and the former *pe-tun-tse*. The best examples of Chinese porcelain are of the hard paste or true porcelain type already described.

## PROCESSES OF MANUFACTURE

**Preparation of Porcelain Bodies.**—The mixing of the various ingredients composing the porcelain bodies is effected in a manner very similar to that used in earthenware (p. 166), and consists essentially in reducing the various materials into the state of a fine powder, suspending them in water in the form of a slip or cream, mixing the various slips thoroughly together in the desired proportions, and then removing the surplus water by means of a filter press.

On the Continent, the filter-cakes are stored in cool cellars for much longer periods than is usual in this country, this storage being intended to develop as much plasticity as possible. When the cakes are ready for use they are passed through a kneading machine or mixer. Magnets for removing adventitious particles of iron are also employed (p. 168).

It is necessary that the material used for the manufacture of each kind of porcelain should be mixed in the requisite proportions and with the necessary thoroughness, as, otherwise, the shrinkage in drying and burning will be excessive or irregular, and the ware will not have the properties characteristic of good porcelain.

The methods of producing articles from porcelain paste vary considerably in different countries, but they are usually modifications of those previously described in connection with earthenware (p. 169), and comprise **moulding** or pressing by hand in plaster moulds, **throwing** or shaping on a potter's wheel, and **casting** or pouring a slip into a porous mould.

As porcelain bodies are usually deficient in plasticity, and the demand for thin, translucent pieces is very large, they are difficult to throw or mould, so that casting is the most suitable process where a sufficient number of articles is required. Additional parts, such as handles, are attached in the same way as to earthenware (p. 172). The bodies used in the production of French or glassy porcelain are exceptionally difficult to shape on account of their lack of plasticity, and this, coupled with the hazard and uncertainty of the effects of heating in the oven or kiln, has prevented this class of porcelain from becoming commercially profitable.

In order to obtain very thin ware without casting, the ancient Chinese were compelled to throw the vessels much thicker than was required, and subsequently to scrape them down to the required thinness.

Variations in minor details naturally occur in different works and at different periods, but these are beyond the scope of the present book. There is a general inclination to use labour-saving machinery, and to limit the number of shapes made.

When a porcelain vessel has been produced by any of the foregoing methods it may be decorated by modelling or carving as desired, and any inaccuracies in shape may be remedied.

It is precisely at this stage of the manufacture that the individuality of the potter is revealed, though under the conditions prevalent in many modern factories much individuality is prohibited.

The ware is next allowed to dry slowly, without cracking or warping, after which it is sent to the biscuit oven to be fired for the first time.

The object of the first firing is to harden the body of the ware and to facilitate the application of the glaze. This is accomplished, in the case of the Japanese, French, and German **hard porcelains**, at a temperature of 600°-700° C.; the Copenhagen porcelain is first fired at 950° C.

It is not intended to produce any other effect than those mentioned, as the best porcelains are those in which the changes effected by heat in both body and glaze occur simultaneously, the final temperature, which is between 1,200° C. and 1,500° C.,<sup>1</sup> having similar influence on both body and glaze. The Chinese have long been well aware of this fact, and most of their porcelain is glazed previous to its being fired, though some colours obtained by them could only have been produced by firing the unglazed ware (biscuit) to a very high temperature, and then using a more readily fusible glaze.

The **glassy porcelains** are fired to a temperature of 1,100°-1,150° C. before glazing, and English **chinaware** (bone china) to about 1,250° C., but in both these classes of porcelain the glaze is fired at a lower temperature than the unglazed body—usually below 1,100° C.

In other words, the properties of the body in glassy porcelain, bone china, and glazed Parian ware are completely developed in the first firing, and the glaze forms an outer covering of an entirely different nature.

The temperature of the kiln or oven must be raised very slowly and cautiously at first—even more so than for earthenware (p. 177). At 500°-600° C., when the clay begins to decompose, the heating must also be very cautiously managed; after a temperature of 850° C. has been reached, however, the rise may be more rapid. As the finishing temperature is approached the greatest possible care is required, as a slightly excessive temperature will cause a large quantity of the ware to collapse from over-heating. To obtain the best results, the ware must be maintained at an almost constant temperature for some time towards the close of the firing.

If the ware is to be decorated "underglaze" it is taken, after the first firing, to the decorators; otherwise it is ready for glazing. For information on decorating see p. 188.

<sup>1</sup> See footnote on p. 188.

The atmosphere should usually be reducing, so as to prevent the discoloration of the ware by any iron compounds which may be present.

The burned ware is sorted carefully, the proportion of damaged and useless material being large, except in the most carefully managed works.

On burning, the felspathic material melts first, and the molten portion then attacks the other constituents, forming less fusible substances. As the temperature rises, more fusion occurs and a point would, in time, be reached at which there would be so much fused material that the articles would begin to collapse. Firing is stopped just before this stage is reached, so that thin sections of hard porcelain, when viewed under a microscope, are seen to consist of particles of calcined clay united together by means of a glassy substance. Minute needle-shaped crystals of sillimanite ( $\text{Al}_2\text{O}_3\text{SiO}_2$ ) are formed at a temperature of about  $1,200^\circ\text{C}$ ., and are a characteristic constituent of hard porcelains.

The application of the glaze to porcelain is usually effected by dipping the once-fired article in a suitable slip or slurry, as in the glazing of earthenware (p. 179).

The Chinese preferred sprinkling the body with the glaze-slip, and obtained some of their finest effects in this manner, though with infinite labour and unparalleled dexterity and skill. A modification of the Chinese method of spraying is now used in Europe for producing certain colour effects, a special form of aerograph being employed for this purpose.

Where dipping is impracticable the glaze is painted on with a brush, some eight or ten coats being usually needed. As each coat must be allowed to dry before the next is applied this operation occupies a considerable time, and does not yield so even a coating as that on articles which have been dipped.

A perfect glaze adheres tightly and uniformly to the body; it has the same coefficient of expansion as the body, and shows no bare cracks or flakes. The glaze must not fuse too readily, or it will collect in drops instead of being uniformly distributed. The necessary conditions are best fulfilled when the glaze is not too low in alumina, as glazes which are free from alumina adhere badly to porcelain.

The glaze must be glossy, it must be completely fused whilst in the kiln, or when cooled must be transparent, free from bubbles and spots, and so hard that it is not scratched by steel. Porcelain owes most of its beauty, gloss, and cleanliness in use to its glaze, and to the great similarity between the glaze and the body. These characteristics can only be obtained in the most complete manner by the use of specially selected materials, and by firing both body and glaze at a much higher temperature than is used for earthenware.

When the coating of glaze is quite dry it is carefully rubbed, so as to remove any inequalities, and the ware taken to the placers, who fix it carefully and skilfully in saggars (p. 177) by means of suitable supports, so that none of the glaze is removed and the glazed parts are kept as free as possible from contact with other surfaces. The saggars, after being filled, are piled one above another in the oven.

The temperature to which the glaze must be fired depends, as already explained, on the nature of the porcelain. For hard porcelains it is the same as that of the body—about  $1,200^\circ$ – $1,500^\circ\text{C}$ .—but for chinaware and French porcelain it is much lower—about  $1,050^\circ$ – $1,100^\circ\text{C}$ .<sup>1</sup>

The time required for firing in the glost kiln is naturally much less than if the ware had not been previously heated. Even with the hardest porcelains it seldom exceeds forty hours, and a much shorter time is usually sufficient.<sup>2</sup>

**Decoration.**—The colours used in the decoration of porcelain are similar to those used for earthenware (p. 179), but for underglaze porcelain the range of colours is severely limited by the high temperature at which the ware is fired.

The best underglaze colours used for porcelain are cobalt oxide for blues,

<sup>1</sup> The reason for the great variation in the finishing temperature stated for hard porcelain is to be found in the composition of these materials. For most hard paste porcelains the temperature in the glost oven does not exceed  $1,250^\circ\text{C}$ ., but several Continental works insist that they invariably finish at Seger cone 18 ( $1,500^\circ\text{C}$ .).

<sup>2</sup> The kilns or ovens used are similar to those described for burning earthenware (p. 176), though small variation in the efforts made to enable the higher temperature to be more readily reached are the cause of the ovens in different works being distinct in several important details. These are, however, matters for the manufacturer and expert rather than for those for whom the present volume is intended.

chromium oxide for greens, uranium oxide for black and yellows, copper for red, and platinum, vanadium, and titanium for other colours. These various oxides are applied in the form of a thick fluid made by mixing them with turpentine, or they may be added to the glaze in the proportion of 2-5 per cent. of the latter.

If the oxide is precipitated along with alumina, and the product thus obtained is used as a colour, the tints produced are entirely different from those obtained by the direct use of the oxide.

It is not usual to add colouring metallic compounds in the form of a *solution*, though there are some advantages in this form. Solutions of cobalt, chloride, and nitrate in water are occasionally employed; they are added to the glaze or to the body, but are of greater value in neutralising an undesirable yellow tint than as direct pigments. In underglaze colours it is difficult to get graduated tints, as the biscuit absorbs the colour so rapidly.

This may largely be overcome by the use of aerographs (described on p. 188).

The **overglaze** or muffle colours used on porcelain can be fired at temperatures to suit the tint required, and as they are quite independent of the ware a very wide range of colours is possible. These overglaze colours are usually prepared by fusing the colouring metallic oxide with a flux, such as a mixture of 6 parts of red lead, 2 parts of quartz, and 1 part of borax. The fused mass is ground to a fine powder, mixed with fat, oil of turpentine, and then painted on the glazed porcelain.

The chief colouring oxides are similar to those used for earthenware, and include:—

*Blue overglaze*—1 part cobalt oxide, 2 parts zinc carbonate, and 5 parts of flux. Other cobalt mixtures are also used.

*Green overglaze*—chromium or copper oxide.

*Yellow overglaze*—lead antimoniate, titanium oxide, uranium oxide.

*Red overglaze*—iron oxide or hydroxide prepared in various ways.

*Carmine overglaze*—purple of Cassius, *i.e.*, metallic gold precipitated on tin oxide or alumina.

*Pink overglaze*—chromium oxide precipitated on tin oxide or alumina.

*Dark brown overglaze*—manganese oxide.

*Black overglaze*—uranium oxide or metallic iridium.

*White overglaze*—tin oxide.

*Silver overglaze*—a mixture of gold and platinum. Metallic silver cannot be used.

*Gold* (as in *gilding*) may be produced by two methods: (a) A mixture of powdered metallic gold, bismuth oxide, and oil is rubbed into a thin paste, and is applied to the ware with a brush. After burning, the gold is dull, but becomes glossy if rubbed with a burnishing tool. (b) A cheaper method consists in preparing a 15 per cent. solution of gold in a sulphurous oil (gold balsam). This material produces a bright gold when burned, and therefore requires no burnishing.

The burning of overglaze colours is effected in muffle ovens or small tunnel kilns (p. 181). The goods are carefully watched, and the heating is stopped or the goods are removed as soon as the glaze is sufficiently fused.

Excessive fusion must be avoided or the colours will run into each other. The temperature reached is between 800° and 1,000° C., but must be suited to the particular colours in the oven. Where several colours requiring different temperatures are used in the same piece of ware, it will be necessary to apply colours one at a time in the order of their ability to resist high temperatures, the most refractory being applied first. Some pieces of ware must be fired six or more times.

**Crackled ware** is a variety of porcelain in which the surface of the glaze is traversed by innumerable small hair-like cracks. This is due to the glaze having a coefficient of expansion higher than that of the body; ordinarily it is regarded as a defect and is then termed *crazing*, but when effected purposely—as in Chinese crackle ware—it is usually produced by means of a calcareous slip applied between the body and the glaze, or by replacing some of the lime in the glaze by an alkali and reducing the proportion of alumina.

**Crystalline glazes**, known to the ancient Japanese, were first introduced into Europe (at Sèvres) in 1850. Since then they have become increasingly popular, especially those in which the surface of the ware is so completely covered with minute crystals as to present a *matt* appearance. Larger isolated crystals are more difficult to control, but sometimes produce very beautiful effects.

The crystals are due to the glaze being supersaturated with one or more oxides which form readily crystallisable silicates—zinc and titanium oxides being the most used. Molybdenum, tungsten, vanadium, uranium, copper, manganese, and chromium compounds also assist in the production of crystals if the glaze is, otherwise, suitable. The coating of glaze must be rather thicker than usual, and it is not unusual to apply a highly siliceous glaze containing the special oxide after the ware has been covered with the ordinary glaze. If colouring oxides are present their crystals sometimes exercise a selective action, and produce very beautiful colour effects.

*Matt glazes* may also be produced by adding a body to the glaze—equal volumes of each being frequently used.

**Flowing glazes** consist of one or more coloured glazes which are applied to the unfired surface of other glazes of a slightly less fusible nature. On firing, the uppermost glaze sinks partially into and flows partly over the underglaze, and produces characteristic and beautiful blendings of colour.

The best results are obtained with a copper or manganese glaze on a black background, or with a cobalt oxide glaze on a yellow or red glaze.

The term "flowing glaze" is also applied to the effect produced by chloride of lime placed near to the glazed surface in the oven. Volatilisation occurs and a "blush" effect is produced. As the result is difficult to control it is better to produce the same effect by spraying the colour on to the ware.

**Rouge flambé** is a bright red glaze produced by the action of reducing gases on a glaze containing copper oxide.

It was known to the ancient Chinese, but its production on hard European porcelains is a relatively recent discovery.

**Lustre glazes** are characterised by the beautiful sheen and iridescence which they exhibit. These effects are largely due to momentary changes in the atmosphere of the kiln.

At one time, potters depended almost entirely on accidental variations in the firing to produce lustrous glazes, but it is now possible to make them in a reasonably reliable manner. The work is one requiring exceptional skill, as the metallic films producing the lustre are extremely thin, and it is very difficult to get them reduced so as to give a pleasing effect. Some firms have been particularly successful with this kind of ware.

# ARTIFICIAL TEETH

BY GEOFFREY MARTIN, Ph.D., D.Sc.

## LITERATURE

M. MAURICE PICARD.—“La fabrication des Dento Artificielles Minérales.” *Bull. Soc. d'Encouragement pour L'industrie Nationale*, 1913, 119, p. 523.

**History.**—Pierre Fauchard (1728) suggested the use of enamel. Duchateau (1774) used porcelain instead of ivory. Later de Chaumant suggested the addition of pipeclay to the porcelain, brought the industry to England, and in 1791 patented his process. In 1808 Fouzi of Paris used platinum pins for fixing the teeth to the artificial plates. M. Planton in 1817 manufactured artificial teeth in America. England and America at present predominate in this manufacture.

**Manufacture.**—Felspar and silica are ground to an impalpable powder, together with a certain amount of kaolin. The mixture is made into a thick paste, and is tinted a variety of colours by means of titanium oxide or by the use of salts of cobalt, uranium, manganese, etc. The paste is next pressed into moulds in which are inserted platinum pins. The teeth are then burned in saggars until well vitrified, a temperature of about 480° C. being required. They are then covered with an enamel made of the same materials as the body of the tooth, but mixed in slightly different proportions.

The composition of artificial teeth is that of a hard paste porcelain and they are manufactured in the same manner as the hard paste porcelains described on p. 186.

In order to secure a satisfactory match with a patient's natural teeth, the dentist sometimes applies a small additional quantity of glaze of a suitable tint to the front of the teeth and refires them in a special muffle.

## SECTION LXVIII

# STONEWARE AND SANITARY WARE

BY ALFRED B. SEARLE  
*Consulting Technologist, Sheffield*

### LITERATURE

- H. ANSELL.—“*Manufacture of Glazed Bricks and Sanitary Ware.*” London, 1898.  
 E. BOURRY (translated by A. B. Searle).—“*Treatise on Ceramic Industries.*” London, 1911.  
 W. BURTON.—“*English Earthenware and Stoneware.*” London, 1906.  
 A. DEMMIN.—“*Keramik Studien.*” Vol. III. Berlin, 1885.  
 A. GRANGER.—“*Cèramique Industrielle.*” Paris, 1905.  
 M. HEIM.—“*Steingutfabrikation.*” Berlin, 1910.  
 B. KERL.—“*Gesamten Tonindustrie.*” Berlin, 1907.  
 H. SEGER.—“*Gesammelte Schriften.*” Berlin, 1908.  
 G. STEINBRECHT.—“*Steingutfabrikation.*” Berlin, 1891.  
 B. TENAX.—“*Steingut- und Porzellan-Fabrikation.*” Berlin, 1879.

A very complete list of books and technical journals dealing with the manufacture of stoneware and sanitary ware is published in the following works:—

- A. B. SEARLE.—“*The Clayworker's Handbook.*” London, 1906, 1911.  
 M. SOLON.—“*Ceramic Literature.*” London, 1910.

THE term **stoneware** should strictly be confined to pottery whose chief characteristic is an opaque vitrified and an almost impervious body, but many articles described as stoneware have a porous body, and to some impermeable ware (such as porcelain) the term stoneware is never applied. Stoneware is, however, distinguished from porcelain by its opacity, *i.e.*, its lack of translucency, and from terra-cotta, earthenware and faience by its almost impermeable body. Good stoneware should “ring” when struck; it should be too hard to be scratched by steel and should be highly resistant to acids.

The finer varieties of stoneware have long been extensively used as pottery—as in the ware made by the Brothers Elers, John Dwight, Josiah Wedgwood, and Doulton & Co. For sanitary appliances, including drain-pipes, and for vessels resistant to acid used in various trades and chemical manufactures, a somewhat coarser stoneware is employed. The roughest kind of stoneware made is that used for paving stables and other areas where impervious blocks or tiles are required. Some years ago, when the demand for sanitary articles made of stoneware was much greater than the supply, a large number of firms used fire-clay for the manufacture of these goods, and placed articles with a porous body covered with a resistant glaze on the market as “stoneware.” Hence the dual meaning of the term and a certain amount of confusion as to its true nature.

The chief object in making **sanitary ware** is to produce an article which will afford no resting-place for germs, or from which germs can be readily removed.

So long as a glazed surface remains whole and the article is completely covered thereby, the texture of the body is of minor importance. Unfortunately, however, sanitary appliances are often used rather roughly, and are particularly liable to accidental blows which are strong enough to remove part of the glaze and to expose the body beneath; it is then impossible to keep such exposed portions hygienically clean unless the body is impervious to water and other fluids with which it is



likely to come into contact. A porous body will absorb undesirable fluids and may become a serious menace to health, and for these reasons the demand for impervious stoneware for sanitary appliances tends to become stricter than it was some years ago. The present tendency is to specify ware with an impervious body for all better-class work, leaving the ware with a porous body for instances in which cheapness is considered to be of great importance. In examining samples of stoneware as to its suitability for a given purpose it is, therefore, essential to consider the effect if a piece of the glazed surface were to be accidentally removed. It is, in fact, the slight damage to ware which must necessarily occur in its use which determines the necessity or otherwise of an impervious body.

**Fine stoneware**, used for domestic pottery, vases, etc., is really a variety of porcelain which is more fusible and less translucent than what is commonly understood by porcelain. This finer stoneware is made by mixing ball clay, china clay and flint, with about an equal weight of Cornish stone, the ball clay being used to produce a highly plastic mass.

If the colour of the body is unimportant the whole of the china clay may be replaced by ball clay. In Wedgwood's Jasper stoneware a large proportion of barium carbonate was used in place of most of the Cornish stone just mentioned. The colour of stoneware may be due to impurities in the clay, or to cobalt or other oxides added to the body.

The great plasticity of stoneware enables it to be used in the production of many designs for which porcelain is entirely unsuitable; and the fine texture and

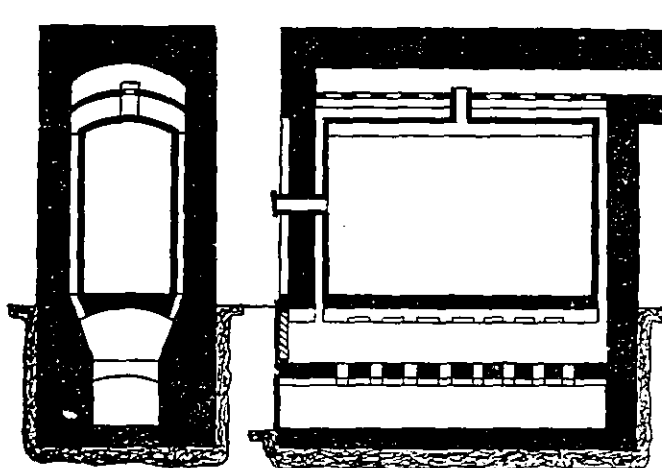

FIG. 1.—Sections of Muffle Kiln.

close compact body possessed by fine stoneware has rendered it invaluable in the manufacture of pottery in which a sharply defined and complex design is required. The texture and appearance of stoneware is such as to make this material more suitable for relief designs and decorative shaping, but some very beautiful colour effects can also be obtained. The size of the articles is usually limited by the tendency of the vitrifiable body to twist in the kiln, yet notwithstanding this limitation some very large articles have been successfully made in stoneware.

Fine stoneware is prepared, shaped, glazed, and burned in a manner so similar to that of earthenware (p. 169) that no further description is needed here. Where the ware will stand the high temperature necessary, the use of a leadless glaze (including salt glaze, p. 197) is advantageous. Much fine stoneware is, however, unglazed, as the slight glaze formed on the surface by the vitrification of the body is sufficient for most purposes.

The greatest difficulty in manufacture is in the firing; if under-heated, the ware will have a porous body, but if over-heated it will twist or otherwise lose its shape.

**Sanitary Ware.**—As already explained, much of the sanitary ware now on the market, and in use in Great Britain, consists of a fire-clay or similar porous body covered with a leadless glaze. On the Continent, and to an increasing extent in this country, the use of a true stoneware is preferred.

The clay is crushed, mixed with water to form a soft paste, and is then moulded in plaster moulds, the work being done almost exclusively by hand. On removal

from the moulds, the surface is smoothed with wooden and steel tools, any supplementary parts are fastened on by means of clay paste, and the goods are set aside to dry.

Some makers burn them in this state and apply the glaze to the once-burned goods, but others apply the glaze to the unfired articles. There is much to be said for and against each of these methods; in some cases the first is preferable, and in others the second one is advisable.

The glaze is usually leadless, and may be (a) salt glaze, or (b) composite glaze. A salt glaze is not applied directly to the goods, but is formed by throwing salt into the kiln towards the end of the firing (see p. 196).

Salt glazing usually produces dark brown ware. It requires a temperature of at least 1,100° C.

A composite glaze is applied directly to the goods, either by dipping them into it, or by painting, pouring or spraying it upon them.

There are many suitable glazes; one which is largely used consists of—

Cornish stone	-	-	-	3 parts.	Whiting	-	-	-	1 part.
Felspar	-	-	-	1 part.	Flint	-	-	-	1 "

When such a composite glaze is applied direct to stoneware the colour of the finished ware is commonly termed "cane," but in order to produce an agreeable tint it is usually necessary to add a little iron or manganese oxide to the glaze.

If white ware is required on a stoneware body, an intermediate slip or engobe is used between the stoneware and the glaze. This engobe is composed of white-burning clays, with sufficient Cornish stone or felspar to enable it to adhere properly. The white engobe effectually covers the coloured stoneware, and makes the article appear as if made of white clay.

The use of engobes is accompanied by a number of difficulties, the chief of which are an irregular appearance of the surface and a tendency to peel or adhere badly. To avoid these, some firms of sanitary ware manufacturers add tin oxide to an otherwise transparent glaze, such as that mentioned on the previous page. By this means they produce a white opaque glaze, which serves the same purpose as an engobe and transparent glaze, with the advantage of better adhesion and appearance, and, in some cases, a lower cost of production.

Much attention has been paid to the production of sanitary ware by machinery, but with only a very limited amount of success. The articles made are so large that it is difficult to deal with them mechanically, and the variations in design, coupled with the enormous cost of such powerful presses, is against their extensive use.

A method of casting large pieces of sanitary and other ware which has rapidly sprung into favour (Weber's German Patent, 158,496) consists in the addition of a suitable alkali to the clay, agitating it mechanically with sufficient water to form a fluid slip, and then allowing this mixture to flow into a mould (see *Casting*, p. 172). By the use of a very small quantity—a fraction of 1 per cent.—of a suitable alkali (or baryta) a mixture of clay with a considerable quantity of grog<sup>1</sup> can be cast into vessels half-an-inch or more in thickness.

The use of alkali, including the use of baryta, for facilitating casting is very old, but its special adaptation to large vessels, and especially in connection with mixtures containing a large proportion of grog, is the subject of the patent by Weber mentioned above.

**Chemical and culinary stoneware** is that used in the manufacture of acids and other chemicals, and for the preparation of food, etc. Its chief property is its ability to resist corrosion by chemicals, and to stand comparatively sudden changes in temperature. It is usually made of a natural clay without admixture, certain Dorset and Devonian ball clays being particularly suitable for the purpose. The clay must be carefully selected and prepared so that the ware may be uniformly vitrified. Where a suitable natural clay cannot be obtained, a more refractory clay is mixed with felspar, Cornish stone or other suitable flux.

The preparation of the clay is similar to that for bricks and tiles (p. 203), the material being crushed (if necessary), and mixed with water so as to form a uniform

<sup>1</sup> Grog is clay which has been calcined and then crushed to a coarse powder.

a paste as possible. It is pressed by hand into plaster moulds, or it may be worked on the potter's wheel if the shape of the ware permits. Great care is required to ensure the various joints being properly made, as some of the vessels made of this kind of stoneware are very complex in shape. Taps made of this material require special care in order that the parts may fit accurately.

Although properly made chemical stoneware is sufficiently impervious without any glaze, the cost of glazing is not great, and it gives a better appearance to the ware. It is effected by throwing salt into the kiln towards the conclusion of the heating. The salt is decomposed, and combines with the alumina and silica of the ware, forming a hard and impervious glaze.

This ware is usually dark brown in colour owing to the iron compounds present in the clay.

Various kinds of kilns are used, but those of the rectangular or down-draught type (p. 215) are considered to be the best.

**Drain-pipes** are used for the transmission of water and other fluids. In agricultural districts the ones used for land drainage are short pipes of porous clay placed several feet below the surface of the ground, but in towns the term "drain-pipe" usually refers to **glazed pipes**. The best glazed drain-pipes are made of vitrifiable clay or of a mixture of fire-clay and Cornish stone or other felspathic material, but a large number of such pipes are in use which have a porous body, and are made from a clay which has not been heated to vitrification.

If a true stoneware pipe (*i.e.*, one with an impermeable body) has the glaze removed from part of its surface, it is still as sound as before, but pipes with a permeable body readily "seep" or leak if damaged in this manner. Sanitary engineers are becoming increasingly stringent in their demands for pipes which will stand water under great pressure; it is not unusual to specify that each pipe must be tested by means of water at 100 lbs. per square inch pressure.

A vitrified body is invaluable when such tests are to be made, though many pipes with a porous body will, if properly glazed, stand this severe test very well.

Glazed pipes are usually made by crushing the clay or other materials to powder, mixing with water to form a stiff paste (see **Bricks**, p. 204), and then passing this paste into a pipe press. This press consists of a strongly built vertical cylinder, at the lower end or mouth of which is placed a steel core of the same diameter as the inside of the pipe. Into the cylinder a large piston is fitted, and this is forced downwards by the direct action of steam from a boiler. The cylinder is filled with clay paste, which is forced downwards by the piston, and emerges through the mouth of the machine in the form of a pipe. The socket end is moulded by an accessory fitting at the same time as the pipe is being made. The pipe, as it emerges, is received on a table placed immediately below the press, and when a sufficient length of pipe is extruded it is cut off with a stretched wire. The pipe is then removed, and the machine is ready to make another. Whilst one man is attending to the machine another is employed "fettling" the pipes, straightening any that are misshapen, and removing any inequalities in the surface. This is done in a special form of lathe termed a "fettler."

Various other types of pipe presses are in use, particularly for small pipes. The latter are frequently made in a brick machine of the "expression" type (p. 208), which has been fitted with a special mouthpiece. In this machine two or more pipes may be produced simultaneously.

Pipes of special shape, such as elbows, junctions, etc., are made by hand moulding or by cutting two or more pipes and fitting them together.

The pipes are dried carefully on floors heated by steam (p. 212), and are placed in round down-draught kilns (p. 215) to be burned. In these kilns, the pipes are stacked vertically one above the other, the smaller ones being placed inside the larger pipes so as to save space. Some skill is required in arranging the pipes so that the kiln gases can reach inside them, as otherwise they will not be properly glazed.

The earlier stages of the burning are similar to those in burning bricks (p. 214) or earthenware (p. 177), but the **Salt-glazing** is quite different. As soon as the pipes are sufficiently heated, the burner sees that his fires are burning brightly; he then lowers the damper, so as to reduce the draught in the kiln, and into the back of each fireplace he throws a shovelful of wet salt. The salt begins to decrepitate or jump about inside the kiln, and as soon as it comes into contact with silica or

clay a combination of the sodium of the salt with the silica and alumina of the clay occurs, and a glaze is formed with evolution of hydrochloric acid fumes. The intense reaction which ensues causes a rapid drop in the temperature of the kiln, which must, therefore, be reheated in order that a uniform coating of glaze may be produced. It is usually necessary to treat the goods a second or even a third time with salt, the temperature of the kiln being raised between each salting.

If, during the salting, the kiln is heated under reducing conditions, the pipes will be darker in colour than if oxidising conditions prevailed throughout. The quantity of salt used varies with the arrangement of the goods, but averages about 1 oz. for each cubic foot of kiln space. It is important to observe that, for the production of a good salt glaze, the ware must be sufficiently siliceous and refractory; highly aluminous ware will not glaze well in this manner, and unless the ware is sufficiently refractory to stand prolonged heating at 1,100° C. or above, it is extremely difficult to obtain a good salt glaze.

Glazed pipes are tested by plugging each end and pumping in water until the desired pressure is reached inside the pipe.

The pressure should be applied steadily, and should be maintained for at least an hour. Some engineers specify that the test must be made on several pipes joined together, and that the pressure must be maintained for twelve hours. Tests in which the pressure is increased until the pipe bursts are of little value; what is needed is a test which will show that the pipes are strong enough to resist any pressure to which they are likely to be subjected.

**Paving blocks and tiles** are used far less extensively in Great Britain than in America. This is partly due to the accessibility of suitable stone at prices which compare favourably with other road materials, especially when durability is considered.

It has been proved by numerous "test roads" that properly made paving bricks are the most durable of any material except Aberdeen granite, and that they are far superior in this respect to macadamised roads. The relatively small extent to which they are used is due more to lack of initiative than to any inherent disadvantages.

For stable yards and other floors which require frequent washing, paving bricks form a durable material which is easily kept clean, and they are largely used for this purpose.

Paving tiles and bricks must be sufficiently hard to resist the abrasive action of traffic passing over them. They should be made of clays which vitrify readily and uniformly, as well vitrified clays form the strongest of all artificial stones.

Suitable clays occur in various convenient parts of Great Britain—particularly in Staffordshire and South Yorkshire—so that the Continental practice of adding a flux to a refractory clay is seldom, if ever, used in this country.

As the chief flux in the best clays used for paving bricks is ferrous oxide, it is necessary to fire the kiln under reducing conditions. All vitrifiable clays rich in iron compounds become more fusible when the iron is reduced to the ferrous state than when it remains as ferric oxide.

In all stoneware, but particularly in paving bricks and tiles, it is essential that the material should have a long range of vitrification. In other words, a considerable time must elapse between the commencement of vitrification and the point at which the goods begin to lose their shape.

Potash, soda and lime are unsuitable fluxes as they cause a collapse too soon after the commencement of vitrification, whereas with magnesia and iron oxides the interval is much longer, and the pores in the goods may be completely filled with molten material without serious loss of shape occurring, providing that the temperature does not rise too rapidly. It is impossible to state very definite limits for these constituents, but a maximum of 2 per cent. of alkalis will generally be found satisfactory. The iron present may amount to as much as 15 per cent., and should not be below 5 per cent., expressed as ferric oxide.

The quality of the goods will depend on the texture and composition of the clay used, and on the skill with which they have been burned. It is essential that a sufficient proportion of coarse, refractory material should be present in order to form a support or skeleton for the fused material. If this refractory constituent is absent, or if it is spoiled by being ground too fine, the range of vitrification will be shortened, and the goods will collapse and twist.

In the best vitrifiable clays this refractory portion is usually in the form of relatively coarse grains of silica; to others a suitable proportion of crushed fire-bricks may be added. If the refractory particles are too large they will prevent the material being properly vitrified, and it is therefore necessary to test very carefully any fresh clays which it is proposed to use for the manufacture of vitrified bricks, blocks, or tiles.

The colour of paving bricks and tiles may be pale yellow, as some of the Bytham bricks, but more frequently they are a bluish grey. "Staffordshire blue bricks" are typical vitrified bricks, though they are not—unless specially prepared—particularly suitable for paving purposes; with a little modification, however, paving bricks and tiles of the best quality can be made from the same material.

The "blue" colour is due to the reduced iron compounds combining with the alumina and silica in the clay, but its intensity is sometimes increased by the simultaneous deposition of carbon in the pores of the material.

**Testing.**—Paving blocks and tiles may be tested for porosity by weighing them, immersing them in water for some hours, wiping the surplus water rapidly from the surface, and re-weighing. The increase in weight will be due to the water absorbed by the pores, and may be expressed as a percentage of the weight of the original article, or preferably in terms of a percentage by volume.

Well-made goods for paving should not show a greater absorption than 1 per cent. of their weight, and, preferably, the amount of water absorbed should be less than this. This porosity test is only of indirect value as serving to distinguish non-porous from porous articles.

For testing the durability of the brick paving tiles in use, various methods have been suggested, though none of them are completely satisfactory.

In the United States—where many miles of brick-paved roads are in existence—the standard test consists in weighing a number of bricks, placing them in a drum with a suitable weight of iron balls, and rotating the drum for several hours. The bricks are then removed, fragments of less than 2 in. diameter are rejected, and the remainder is weighed. The loss of weight is taken as an inverse measure of the value of the goods.

Another test, largely used in Germany, consists in fixing a sample brick or tile just above a rotating plate containing sand. The amount of material ground away in a prearranged time is considered to indicate the durability of the article tested.

Both these tests are quite empirical, and their results are of only limited value.

## SECTION LXIX

# BRICKS

BY ALFRED B. SEARLE  
*Consulting Technologist, Sheffield*

### LITERATURE

- E. DOBSON and A. B. SEARLE.—“Bricks and Tiles.” (12th edition.) London, 1911.  
 A. B. SEARLE.—“Modern Brickmaking.” London, 1911.  
 —“Clayworker’s Handbook.” London, 1906, 1911.  
 —“Kilns and Kiln Building.” London, 1916.  
 —“Refractory Materials: their Manufacture and Use.” London, 1917.  
 —Cantor Lectures on “Brickmaking,” 1911.  
 B. KERL.—“Gesamten Tonindustrie.” Berlin, 1907.  
 K. DÜMMLER.—“Handbuch der Ziegelfabrikation.” Berlin, 1900.  
 G. HARRIS.—“Science of Brickmaking.” London, 1897.  
 H. ANSELL.—“Manufacture of Glazed Bricks.” London, 1898.  
 A. E. BROWN.—“Hand Brickmaking.” London, 1902.  
 E. BOURRY (trans. A. B. Searle).—“Treatise on Ceramic Industries.” London, 1911.  
 P. HASLUCK.—“Bricks and Brickmaking.” London.  
 R. B. MORRISON.—“The Brickmaker’s Manual.” Chicago.

A particularly complete list of books and technical journals dealing with the manufacture of bricks is published in “The Clayworker’s Handbook.”

THE literature relating to the manufacture of bricks is very extensive—though much of it has only become available during the last few years—and the various machines and processes employed are now so numerous that they cannot be described within the space available in the present volume.

Briefly, there are six chief groups of bricks: (*a*) Building bricks, (*b*) engineering bricks, (*c*) refractory or fire-bricks, (*d*) paving bricks, (*e*) glazed bricks and (*f*) lime-sand bricks.

**Building bricks** are of various shapes and sizes, the most important being parallelopipedons or prisms measuring about 9 in.  $\times$  4½ in.  $\times$  2½ or 3 in.

Bricks used for exterior work are known as **facing bricks**, and must be of pleasing colour and accurate in size and shape. For interior work, and where they are covered with plaster, stucco or rough-cast, less accuracy is needed, and colour is of little or no importance; such bricks are known as **common** or **stock bricks**,<sup>1</sup> and they constitute the greater part of the bricks manufactured at the present time.

For ornamental purposes, bricks of special shape are employed, for details of which the reader should consult works on building construction, or one of the treatises mentioned at the head of this section.

Building bricks are usually of a uniform red or buff colour, but some with irregular markings in blue and brown are much prized for special work. Stock or common bricks are usually very irregular in colour, no pains being taken to secure uniformity. Some of the Suffolk bricks are quite white.

<sup>1</sup> In some localities, stock bricks are considered as equivalent to facing bricks, and superior to common ones; in such localities they are the “selected” bricks—chosen on account of their superior appearance.

Most building bricks are very porous, and will absorb one-tenth to one-eighth of their weight of water on simple immersion, but bricks made in certain localities and by exceptionally powerful presses—as the Fletton bricks made by the “semi-dry” process—are much less absorbent on account of their dense surface. Where specially light bricks are required they are usually made by mixing Kieselguhr or sawdust with clay; the sawdust burns out and leaves a very porous mass.

The chief characteristics of building bricks are strength, colour, and accuracy of shape. No definite standards exist for any of these, and architects and builders each have their own ideas on the matter.

In 1904 the Royal Institute of British Architects defined the standard size as within the following limits: length between  $8\frac{3}{8}$  in. and 9 in. Breadth between  $4\frac{1}{8}$  in. and  $4\frac{3}{8}$  in. Thickness between  $2\frac{3}{8}$  in. and  $2\frac{1}{2}$  in.

The method of measuring the bricks as set out in the standard is as follows:—

(1) The length of the bricks should be double the width, plus the thickness of one vertical joint.

(2) Brickwork should measure four courses of bricks, and four joints to a foot.

Joints should be  $\frac{1}{4}$  in. thick, and an extra  $\frac{1}{8}$ , making  $\frac{3}{8}$  for the bed joint, to cover irregularities in the bricks. This gives a standard length of  $9\frac{1}{4}$  in. centre to centre of joints.

The bricks laid dry, to be measured in the following manner:—

A. Eight stretchers laid square end and splay end in contact in a straight line to measure 72 in.

B. Eight headers laid side by side, frog upwards, in a straight line to measure 35 in.

C. Eight bricks, the first bricks frog downwards, and then alternately frog to frog, and back to back to measure  $21\frac{1}{2}$  in.

A margin of 1 in. less will be allowed as to A, and  $\frac{1}{2}$  in. less as to B and C.

The standard has been agreed upon between the Royal Institute and the Institute of Clay-workers, and has been drafted in consultation with these bodies and with representatives of the Institution of Civil Engineers.

Great variations in crushing strength are observable in bricks made in different parts of the country. These are partly due to differences in the clays, partly to the method of manufacture, and partly to the variation of opinion as to what constitutes “best quality” bricks.

The following table gives some idea of the strength of some well-known bricks:—

	Crushing Strength.	Tons per Square Foot.
London grey stock bricks	- - - -	89
Suffolk white bricks (Gault)	- - - -	135
Essex red sand stocks	- - - -	96
Leicestershire red bricks (wire cut)	- - - -	269
Fletton bricks (semi-dry process)	- - - -	250
Staffordshire blue bricks	- - - -	785
South Yorkshire bricks (stiff-plastic process)	- - - -	540
Dutch clinkers (blue bricks)	- - - -	587
Rubber bricks and cutters (very variable)	- - - -	70

The strongest bricks can usually be distinguished by the clean ringing sound they emit when two are struck together.

**Engineering bricks** are made of clays which become more vitrified when burned than do building bricks, and are consequently stronger than more porous bricks. Engineering bricks are used for bridges, reservoirs, and other important engineering structures where great strength is required.

They are usually blue or grey in colour, but some vitrified bricks manufactured in the Midlands, which are excellent for engineering purposes, are primrose tint. Staffordshire has long enjoyed the reputation of making the best engineering bricks in the United Kingdom, but smaller quantities of equally good quality are manufactured in the north. They closely resemble paving bricks (p. 197).

**Refractory or furnace bricks** are used when great resistance to heat is required. Their nature and manufacture are described on p. 229.

**Paving bricks** are described on p. 197.

**Glazed bricks** are usually made of a buff- or cream-burning refractory clay (fire-clay) as the application of glazes containing lead compounds to bricks is not wholly satisfactory, and the use of a porcelainous or felspathic glaze (p. 195) is scarcely possible on red bricks on account of their fusibility. The method generally

adopted is precisely the same as for glazing sanitary ware (p. 195), the bricks—either in a raw or biscuit state—being dipped in a felspathic glaze, dried, and burned in a kiln at a temperature between  $1,200^{\circ}$  and  $1,300^{\circ}$  C.

There are ever-recurring attempts to purchase bricks ready-made and to glaze them, but such attempts must usually fail for one simple reason: in all glazed brickwork sharp edges are essential, and the greatest pains must be taken not to have the bricks chipped or damaged previous to the application of the glaze. It is, therefore, imperative that they should be made and glazed on the same works, as to cart them indiscriminately from one place to another would damage them irretrievably.

Attempts to glaze red bricks are almost equally unsatisfactory for another reason: it is exceedingly difficult to heat the whole of the bricks in a kiln uniformly, yet the limit of variation permitted by the glaze is such that it is almost impossible to obtain a sufficiently large proportion of well-glazed red bricks to make the process remunerative. With the harder glazes used on bricks made of fire-clay this difficulty is far less serious, as the variation in temperature permitted by the glaze is much greater than is the case with plumbiferous glazes. The argument that the temperature in potters' ovens varies as greatly as in a brick kiln is inapplicable, as the potter is able to arrange for a much greater variety of colours than can be applied to bricks, and the necessity for uniformity of tint and tone is not so great as in the case of bricks.

**Sand-lime bricks** are made by heating sand mixed with a small quantity of freshly slaked lime in an autoclave with steam under pressure. At the temperature reached in the autoclave, the lime combines with a portion of the sand and forms a cementitious silicate which binds the particles of sand together.

Sand-lime bricks are really a form of artificial sandstones and are referred to in the section on **Artificial Stones** (p. 131), being more fully described on p. 223.

The **raw materials** used for building bricks are the various clays, marls, sands and shales which occur in almost every part of England and Ireland. Stone occurs in such accessible forms in Scotland, that bricks are only used to a limited extent in that country.

Apart from the cost of preparation, almost any clay can be made into bricks, but this very facility constitutes a serious danger to the would-be manufacturer. Thousands of pounds have been lost through people with insufficient knowledge of the subject attempting to manufacture bricks from a material which is, in many respects, suitable, but for which the financial conditions are unfavourable. For this reason a consultation with a reliable and impartial expert—one who is entirely free from the obligations of selling plants or kilns of a particular design—is always advisable and usually saves much waste of money. Many instances of this might be given, but one must suffice: What is known as the "London clay" is largely an excellent material for the manufacture of bricks and tiles provided that it is mixed with a suitable non-plastic substance, such as sand. Alone, the London clay is extremely difficult to use, but in those parts of the country where it occurs in close proximity to a suitable sand it is a valuable material. Elsewhere it is of little or no value, as the cost of purchasing sand and carting it to the brickworks would be prohibitive. Failure to realise this has been the ruin of many brick manufacturers.

The characteristics of the various clays used in brick-making are very briefly outlined in the section on **Clays** (p. 139), but the reader who requires further details should consult the literature at the head of that section, and particularly the volume on "British Clays, Shales, and Sands" there mentioned.

Broadly speaking—though the special characteristics of certain earths make any general statement unsatisfactory—a material to be made into "clay" bricks should contain at least half its weight of true clay, the remainder being chiefly siliceous matter, so that its ultimate analysis will not show much less than 20 per cent. of alumina, nor above 75 per cent. of silica. It is, however, possible by the use of special processes to produce excellent bricks from almost pure silica, so that too much reliance must not be placed upon the figures given. It is only fair to remark that silica bricks cannot be manufactured by the same methods as those used for ordinary "clay" bricks, so that the figures mentioned are sufficiently accurate for most purposes, special cases being decided after a separate consideration of their individual merits.

Some clays are too rich in clay substance to be satisfactory for brick-making; these must be mixed with sand or some other suitable non-plastic material.

Very rich or "fat" clays shrink so much when made into bricks and dried that they crack and twist to an extent which makes their use without admixture almost impossible.

Of the various **impurities** in clays, the one most dreaded by the brick-maker is granular particles of **limestone**. These are distributed irregularly in some clays, and when bricks are made, burned and ready for use, the lime in them absorbs



moisture from the air and, in many instances, will break the bricks to pieces. Bricks of this character may usually be recognised by the white spots distributed through them.

In order to remove the particles of limestone, various clay-cleaners have been devised, but they only take out particles of  $\frac{1}{8}$  in. or more diameter, whereas particles as small as  $\frac{1}{16}$  in. can do a large amount of damage to bricks containing them. The chief use of such clay-cleaners is, therefore, to remove so large a proportion of the limestone that the remainder will do but little



FIG. 1.—Steam Navy Digging Clay.

(By courtesy of Messrs Ruston, Proctor & Co. Ltd.)

harm. Two other remedies for this troublesome difficulty are in use: the first consists in heating the bricks in the kiln to such a temperature that the lime combines with the clay and forms an insoluble aluminosilicate, which is harmless; the second method consists in dipping the bricks, as they come from the kiln, into water so as to quench the lime quickly before it has time to swell and break the bricks. There are obvious objections to both these methods, and, wherever possible, clays containing granular particles of limestone should be avoided.

**Chalk**, on the contrary, is a useful constituent of some clays, and is largely used in the South of England in place of sand as a non-plastic diluent for the clay.

*Red bricks* owe their colour to **iron** compounds, the precise nature of which is not well understood. The red tint is commonly stated to be due to free ferric

oxide in the clay, but this is improbable; if ferric oxide is the colouring agent, it must be produced as the result of some decomposition occurring in the kiln.

The addition of ferric oxide to clays to improve their colour has frequently been suggested, but the results obtained do not usually warrant the cost; moreover ferric oxide added in this way behaves in a very erratic and far from satisfactory manner.

*Buff bricks* are obtained by burning clays containing only a very small proportion of iron compounds, such as the fire-clays or the vitrifiable clays of Bytham.

*White bricks* are made of either natural or artificial mixtures of chalk and ferruginous clay; such mixtures are termed **malms** or **marls**, and the white colour is due to a reaction which takes place between the iron compounds and the chalk. The white bricks of Suffolk are particularly well known.

**Preparation of Material.**—Having obtained a suitable material, or one which is considered sufficiently suitable to warrant experiments on a large scale being carried out, the next question which arises is, "Which is the most suitable process for making this material into bricks?" A full answer to this question involves many considerations, the most important of which can only be judged by an expert. Hence, in the following pages no more than the barest outline

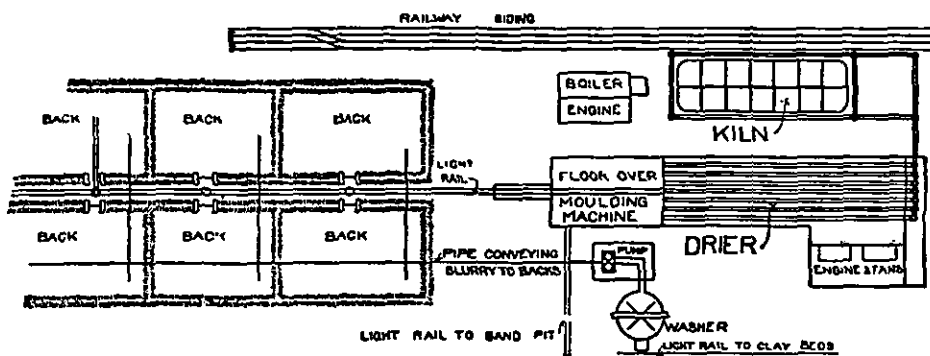

FIG. 2.—Arrangement of Washing Plant (after Middleton).

is given of the various processes, and readers wishing for further information may consult the special books and treatises upon the subject, such as those mentioned on p. 199.

The clay for brick-making is usually quarried, but the "refuse" from coal mines is also used in some localities. It is seldom that clay for building bricks can be mined by underground methods at a remunerative rate. The clay is usually dug by hand labour (spade work) with the aid of blasting where the nature of the material permits. Where a sufficiently large quantity is needed, a steam navy (Fig. 1) may be employed with advantage, as when worked at its normal capacity it will dig clay for about one-sixth of the cost of hand labour.

In many brickyards the clay is permeated by numerous seams or veins of unsuitable material, so that the digging requires skilled supervision and the use of a navy is impossible.

As typical examples of the two extremes of clay-getting, mention may be made of the use of a steam navy at the works of the London Brick Company at Peterborough, where a bed of Oxford clay, 20-60 ft. in depth, is dug and put into waggons at the rate of a ton a minute—and the ordinary small brickyard in the Isle of Wight, where the composition of the material completely changes every few feet, and, in some instances, layers of clay, sand and other materials are found superimposed on each other (no single layer being more than a foot in thickness), thus necessitating the greatest care on the part of the men getting the clay, as some of the other materials would be very injurious were they allowed to enter into the composition of the bricks.

The uppermost layer or subsoil (frequently termed **callo** or **overburden**) must usually be rejected. As a whole treatise could be written on each of the chief methods of getting material for brick-making, whether by quarrying or by mining, and as a detailed description would take us too far from our main subject of the manufacture of bricks, we must assume that some sufficiently satisfactory method of obtaining a supply of material has been found, and now consider its treatment.

After the clay has been dug it may be sent direct to the plant or it may be set aside to enable the weather to act upon it. "Weathering" has a marked effect on many clays and shales, enabling them to be much more readily treated in the machines, and, in some cases, freeing them from undesirable impurities.

The demand for large numbers of bricks at very low prices has led to the discontinuance of weathering in many works; this is to be regretted, as in almost every case weathered clay makes better bricks than that which is used within a few minutes of its being dug.

The clay is next sent to the cleaning plant, if it is of such a nature as to require a rough purification. Two types of machinery are used for this purpose: the first consists essentially of a screen or riddle against which the pasty clay is forced; the clay passes through the perforations or slots in the screen, and the stones and gravel remain behind (p. 202).

Such an arrangement is obviously crude, and will not remove anything smaller than  $\frac{1}{8}$  in. diameter, so that it is useless except for clays containing coarse impurities.

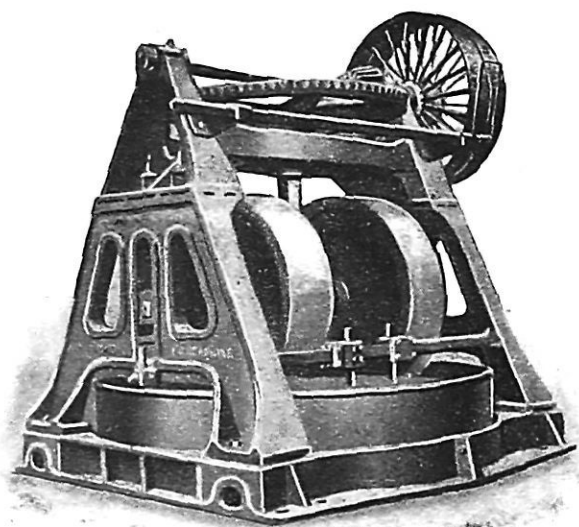

FIG. 3.—Edge-Runner Mill.  
(By courtesy of Messrs Sutcliffe, Speakman & Co. Ltd.)

The second type of clay-cleaning plant is known as a **wash mill**, and consists of a circular well in which a series of vertical harrows is rotated (see **Cement**, p. 87, Fig. 7). The clay is thrown into this well, a large quantity of water added, and the harrows set in motion so as to churn the clay and water together. After some minutes, the harrows are stopped, and the fluid portion is run off to large settling tanks.

The stones and gravel remain behind in the mill, and are removed when a sufficient quantity has accumulated. When a mixture of chalk and clay is used for brick-making, the mixing is usually effected in a wash mill.

The clay in the settling tanks gradually sinks to the bottom, and after a sufficient time has elapsed the clean supernatant water is run off, and the soft clay is cut into rough blocks and allowed to dry somewhat before being taken to the pug mill.

The cleaning or washing of clay is an expensive process, and is avoided wherever possible, but it is largely used in Kent and Essex (Fig. 2).

In some localities the clay is mixed with the siftings from domestic ashes, partly to reduce the plasticity and shrinkage of the clay, and partly as a convenient means of introducing the fuel into the very centre of the bricks, and so secure as

complete a burning as possible. This is the case with the clamp-burned stock bricks sold in London.

In most methods of brick manufacture, the raw material must be converted into a paste by mixing it with water. In the case of soft clays this is effected by means of a pug mill, but hard clays and shales must first be reduced to powder.

Clays may be crushed by (a) crushing rolls, or (b) edge-runners. **Crushing rolls** are usually mounted in pairs, and the clay or shale allowed to fall on top of them is passed between them and crushed in the process. If necessary, several pairs of rolls may be used, each pair being set rather closer together than the preceding ones, so as to effect a gradual reduction of the material.

**Edge-runner mills** resemble those used for mixing mortar, but are heavier and more powerful. They consist of two mill-stones which rotate on a horizontal shaft above either a fixed bed or a revolving pan. Perforations or slots in the bed or pan permit the crushed material to pass out of the mill into a receptacle beneath, from which it is raised by a bucket elevator to the screens. The coarse

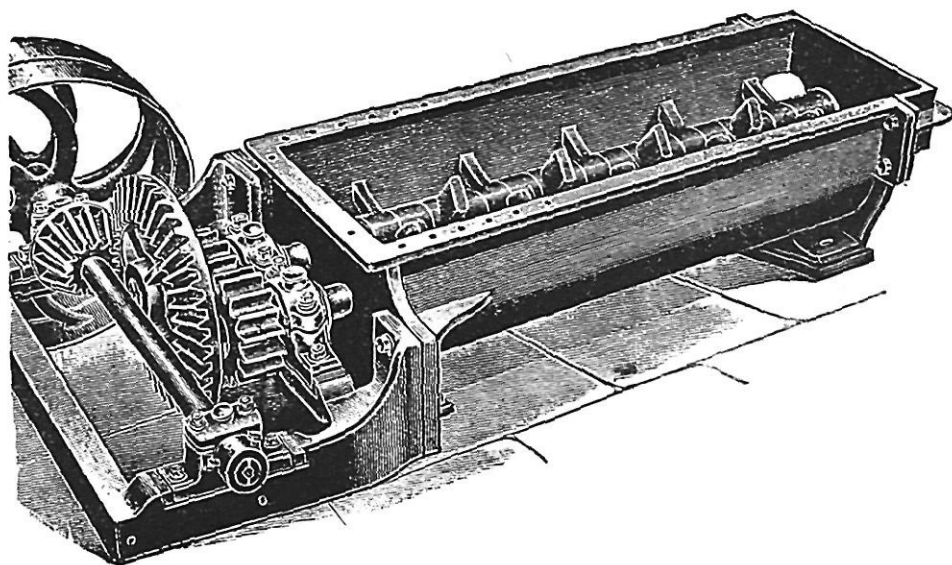

FIG. 4.—Open Mixer.

(By courtesy of Messrs Whitehead & Co. Ltd.)

material is returned to the mill for further treatment, and the powder which has passed through the screen is taken to the pug mills or mixing machines.

If a clay is very tough it is sometimes necessary to pass it first through an edge-runner mill with large slots, and then through several pairs of rolls. Some shales and other rocks used for brick-making must be broken into small lumps in a *stone-breaker* before they are passed to the edge-runner mills.

Broadly speaking, tough, pasty clays are best reduced by crushing rolls, and shales or rocky clays are best treated in edge-runner mills, but each material requires separate study and must be dealt with accordingly.

**Tempering** is the term used to indicate the conversion of a clay or powdered shale into a homogeneous paste suitable for the manufacture of articles. It consists essentially in the addition of water and its thorough incorporation into the mass.

Tempering was, at one time, effected by men treading the material with naked feet, but the advent of mixing and pugging machinery has caused the abandonment of "treading," except in the case of crucibles for melting steel. Another method—still used in some out-of-the-way districts—consists in turning the clay over and over by means of wooden spades.

Two kinds of tempering machines are in use. The first is an open trough in which is one or more shafts carrying blades or knives set at an angle to it. Such

a machine is known as an **open mixer**. A similar machine, but closed except for an opening at each end, is also used, and is known as a **pug mill**; in addition to mixing the clay and water it also compresses the material, and if the outlet end is made of a suitable shape—as when fitted with a **mouthpiece**—the clay paste issues from the machine in a compact column which can be cut into bricks.

In this way a pug mill serves not only as a mixer, but as a brick-making machine, and bricks so made are said to be produced by the “expression” or “wire-cut” process (p. 208). Where hand-moulded bricks are made the clay issues from the pug mill in so soft a state that no mouthpiece is needed.

Clays which are difficult to mix with water require the use of a long open mixer, followed by a pug mill of equal length and capacity, but for most of the south country clays used for hand-moulded bricks a single vertical pug mill is sufficient.

Pug mills may be of either the vertical or horizontal type, the former being generally used for mild clays and the latter—in conjunction with other machinery—for tough or hard clays.

**Moulding** bricks by hand is one of the earliest methods of manufacture, and it is still used to an enormous extent in the South of England. In the Midlands and North, where the climatic conditions are less favourable, bricks are usually produced by mechanical means.

A brick mould consists of a wooden frame which is large enough to surround a freshly made brick. This mould has no top or bottom, and must, therefore, be laid on a table or bench when in use.

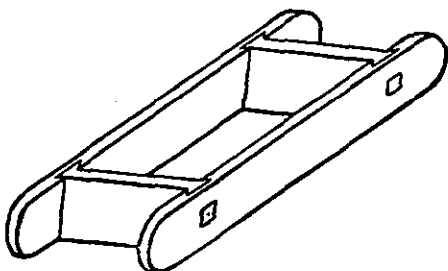

FIG. 5.—Brick Mould.

In **slop moulding**, the workman dips the mould in water so as to wet it thoroughly. He then places it on a prepared part of his working bench, and throws into it, with great force, a mass of clay paste rather more than sufficient to fill it. He next presses the clay well into the corners of the mould and removes any superfluous clay by drawing a straight piece of wood—termed a *strike*—across the top of the mould. He then, with a sudden turn of his wrists, lifts the mould with its contents and holds it sideways, and either hands it to a boy assistant or places it on a part of the bench ready for him. The boy carries the mould away to the drying floor or ground, and carefully placing it down, he empties out the soft brick without spoiling the shape.

In **sand moulding**, the interior of the mould is covered with sand instead of water previous to making each brick, and instead of a boy taking away the mould, the maker empties it on to a small board—termed a pallet—and a boy carries the brick away between two pallets to the drying floor. In addition to giving the bricks a pleasant appearance (sand face), the method of sand moulding is about four times as rapid as slop moulding, but cannot be used for all clays.

The bricks are carried on light spring barrows of special shape (Fig. 6).

One reason why brick-making machinery has made so little progress in some localities, is that a man and a boy can turn out 36,000 bricks a week by hand moulding, and this is sufficiently cheap for machinery to effect no appreciable saving where the clay is suitable for hand moulding.

If hand moulded bricks are required to be specially accurate in shape they are allowed to become partly dry, and may then be pressed in a portable press, operated by a strong youth.

The moulding of bricks by hand requires great skill, and as the work is also laborious, it is becoming increasingly difficult to obtain good moulders. This has led to the introduction of machinery to imitate the hand-made article, but such machines have never become really popular in this country. In the United States a large number of these “**soft mud**” machines are in use at the present time.

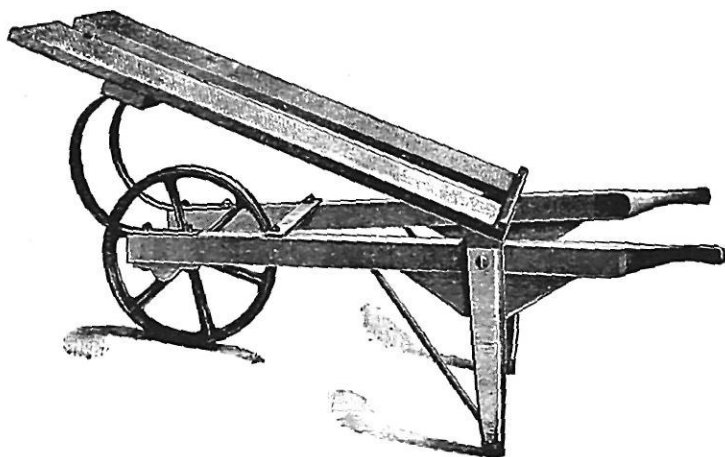

FIG. 6.—Barrow for Carrying Hand-Made Bricks.

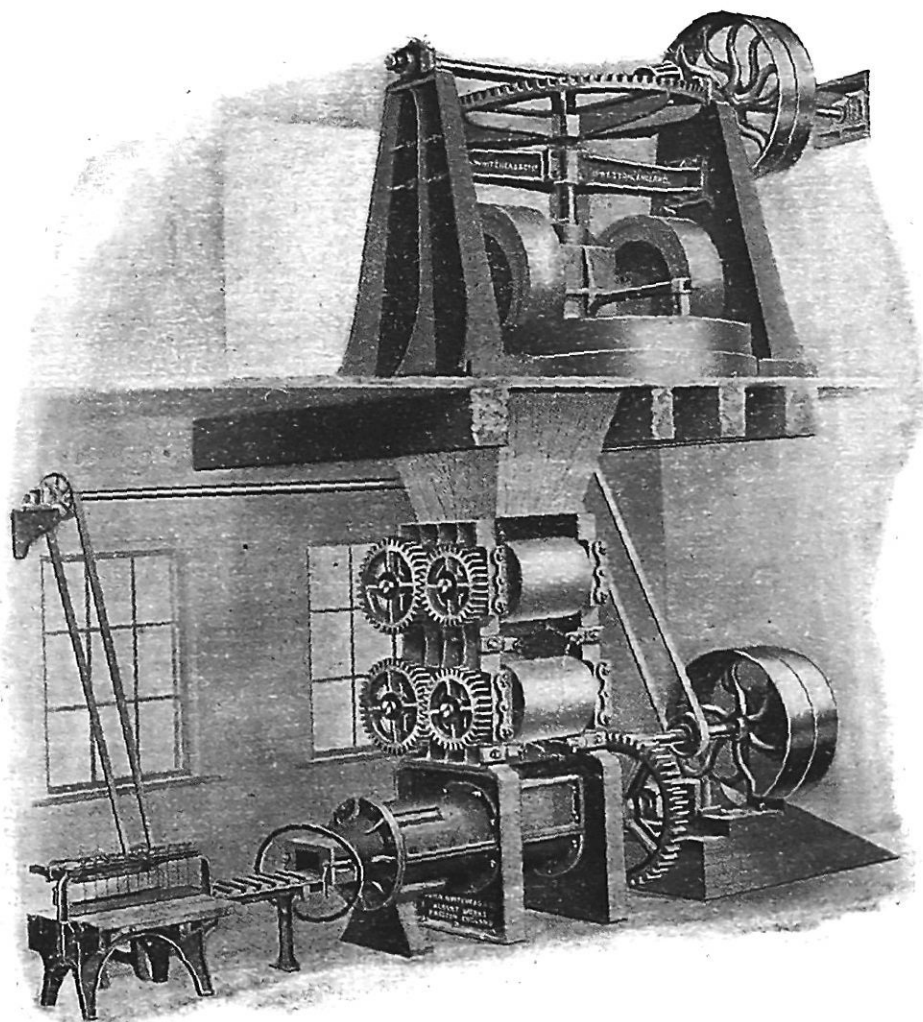

FIG. 7.—Plant for "Wire-Cut" Process.  
(By courtesy of Messrs J. Whitehead & Co. Ltd.)

Most bricks made by machinery are produced by one of the following methods: (a) Expressing the clay through a mouthpiece and then cutting it into bricks; (b) forming a preliminary clot or rough brick and repressing this to shape (stiff-plastic process); and (c) placing the moist powder or shale into a metallic mould and compressing it to shape in a powerful mechanical press (semi-dry process).

The special advantages of processes *b* and *c* are to be found in the greater stiffness of the bricks produced by the machines. Owing to the water being present in only a small proportion, such bricks can be taken direct to the kilns without any previous drying. This materially reduces the cost of manufacture, but it must be observed that mechanically made bricks are very different in many respects from those moulded by hand.

**Expressing** clay through a mouthpiece attached to the end of a pug mill, and then cutting the extruding clay column cross-wise into bricks, is a method of manufacture which can be applied to almost any clay capable of being made into bricks. As wires tightly stretched on a frame form the means whereby the clay column is cut, this method of manufacture is commonly known as the **wire-cut process**. It is equally applicable to the production of pipes, hollow blocks, and a variety of other articles. As in the hand-moulding method, the clay must be in the form of a soft paste, and as the column is usually cut into several bricks at a time, these are

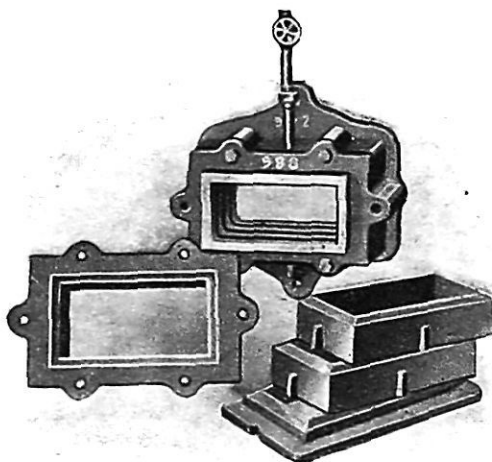

FIG. 8.—Mouthpiece—Assembled and in Pieces.

carried on a large board or pallet to the drying floor or on to the cars, which are then run into a drying tunnel. If desired, wire-cut bricks may be pressed after they have been partially dried.

Where a clay is difficult to work by this process, the insertion of a pair of **expression rolls** between the pug mill and the mouthpiece will often facilitate the manufacture. These rolls also tend to reduce lamination and other troubles incidental to the wire-cut process when it is applied to some clays.

In the **stiff-plastic process** of brick-making, the clay paste must be very much stiffer than for hand moulding, and as such a paste is difficult to obtain with some clays, the stiff-plastic process has been most successful when applied to shales and other dry clays which are capable of being reduced to powder. This powder is then mixed with a very small proportion of water in a powerful pug mill, and the stiff paste is forced into a clot-mould which makes it roughly of the desired shape.

Various ingenious devices have been patented for producing the clot or rough brick, but only two are now extensively used. The first of these consists of a horizontal steel disc or table fitted with moulds; the clay is forced into one of these moulds by means of a fixed vertical pug mill, and the table then makes a partial rotation, placing an empty mould beneath the pug mill. After the table has rotated sufficiently, one of the moulds is emptied automatically by means of a rising plunger,

and the clot is then ready for the repress. This arrangement is the basis of the Bradley & Craven brick machine (Fig. 10).

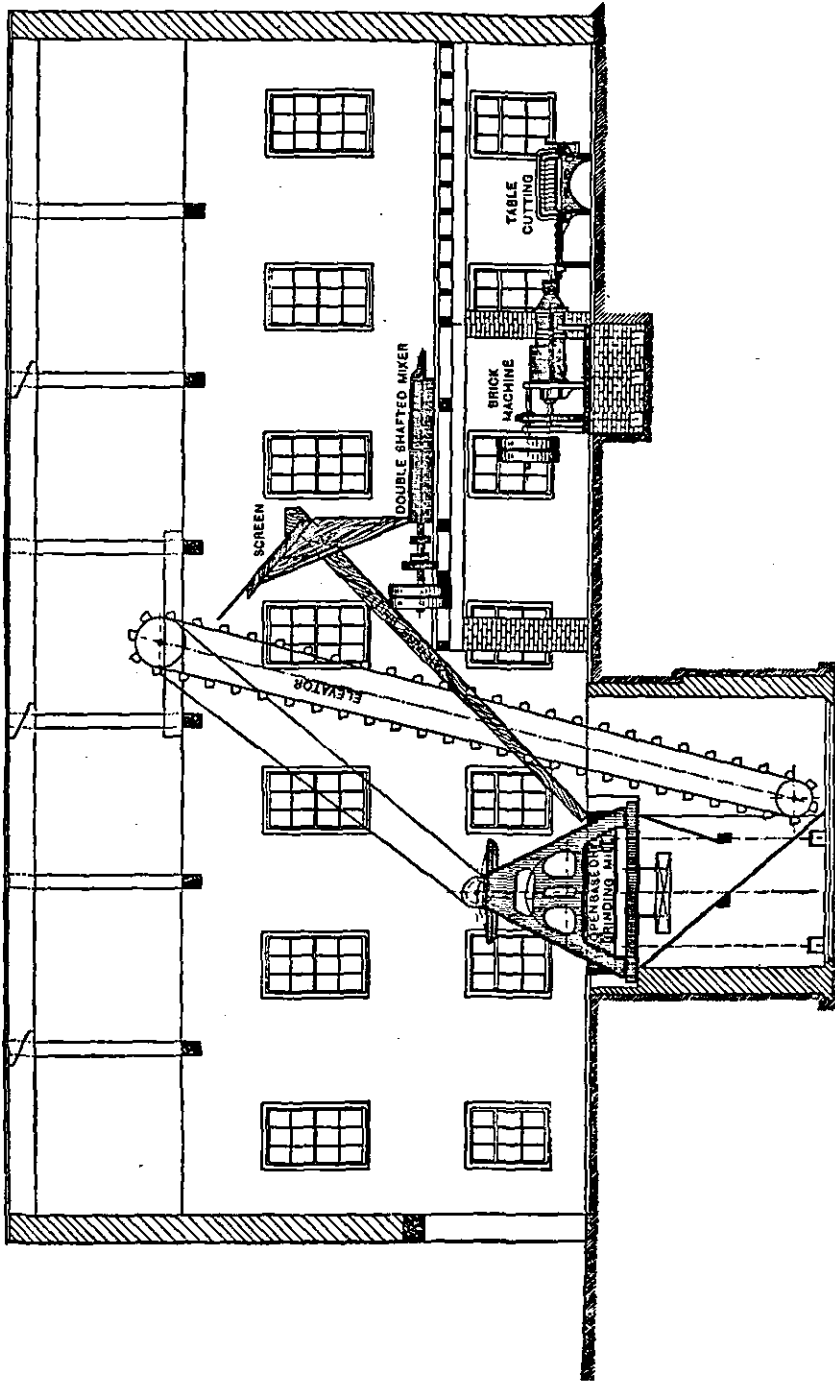

FIG. 9.—Plant for Making Plastic Bricks from Dry Clay or Shale.  
(By courtesy of Messrs J. Whitehead & Co. Ltd.)

The second method of making a clot from stiff-plastic clay consists in forcing it with a ram or pug mill into the spaces between the cogs of a specially shaped wheel, these spaces forming the clot mould, and temporary ends being formed by the framework in which the wheel revolves. As the wheel revolves, the clay in the



mould is eventually raised to the level of the repress, and the clot is pushed out sideways by means of a lever which takes it direct to the press. This arrangement is the essential feature of the machines made by T. C. Fawcett Ltd., and R. Scholefield respectively (Fig. 11).

As the clots are only roughly shaped, it is necessary in each case to employ a press in connection with the clot mould, and the machines mentioned are so arranged that powdered clay is delivered into one part of the machine and the properly pressed bricks are obtained from another. This is effected by combining a pug mill, clot mould, and press in one framework.

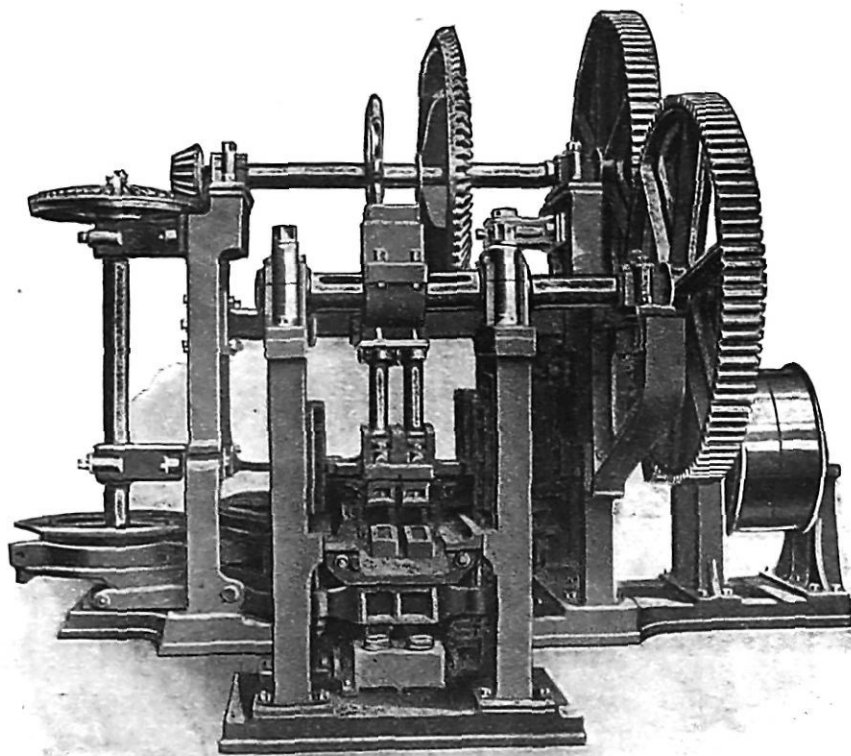

FIG. 10.—Machine for Making Bricks by the Stiff-Plastic Process.

(By courtesy of Messrs Bradley & Craven Ltd.)

Although the final pressing in a stiff-plastic machine really constitutes a repressing of the clot, some makers use an additional repress machine for the manufacture of facing bricks, the bricks being passed into this immediately after leaving the ordinary machine or after they have been partially dried. Unless, however, the material is peculiarly difficult, it is unnecessary to subject them to this treatment. If, through lack of adjustment, the machine produces unsatisfactory bricks, it is better to adjust the machine rather than to give the bricks additional pressings, though with some clays this cannot be avoided.

The average output of a stiff-plastic machine is 10,000 to 12,000 bricks per day of ten hours.

The stiff-plastic process, whenever it can be properly used, is the most satisfactory of all methods of brick-making, as it combines most of the advantages of the fully developed plastic clay, with a reduced cost in drying the bricks. Stiff-plastic bricks may go direct into continuous kilns, but it is usually better to dry them first in a tunnel drier, or on a steam-heated floor, as the moisture is then more satisfactorily removed than in the kiln, and the loss by improperly dried bricks is much less.

**The Semi-Dry Process.**—Where the material is sufficiently dry to be in the form of a powder which readily “balls” on leaving the grinding pan, it is often economical to work it up without any addition of water at all. As the material is not completely dry, this process is known indifferently by the terms “semi-dry”

and "semi-plastic," both being equally unsuitable, but used in the absence of more accurate terms.

Bricks made by this process are quite distinct in character from those in which the plasticity of the clay has been more fully developed, and though they were much used a few years ago, they are rapidly being displaced (except for common work near London) by stiff-plastic bricks.

Where the material is of a suitable nature, the semi-dry method of working effects marked economies in the cost of production, as it dispenses with the cost of pugging and drying, and the friction of the material in the plant is also materially reduced. Against this must, however, be set the added power required to compress the material into bricks; this, in some instances, being very great.

The semi-dry process is carried out in its most perfect form in the neighbourhoods of Accrington and Peterborough, where a suitable material extending to

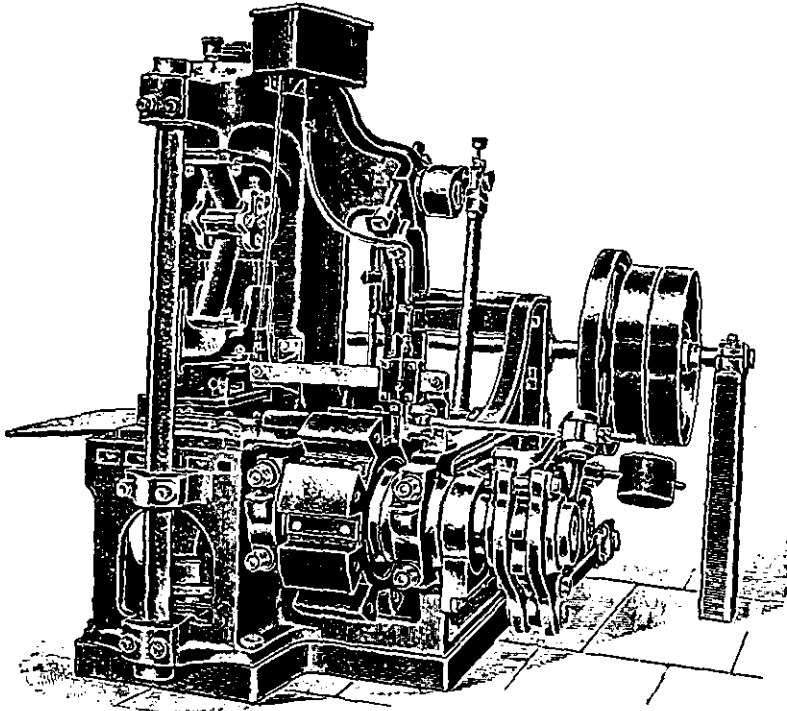

FIG. 11.—Machine for Making Bricks by the Stiff-Plastic Process.

(By courtesy of Messrs T. C. Favcett Ltd.)

great depths is found in such large quantities as to facilitate the manufacture of bricks on a colossal scale.

To be worked to advantage the material must be cleared of surface soil, or "callow," and must be then worked vertically, so that several strata may be mixed together in definite proportions. This is best effected by using powerful steam or electric navvies, which are capable of excavating a ton of material at a single stroke. The material is then taken in waggons to the grinding pans, and the fine product is separated by means of screens. It is then carried away by spiral conveyers, which mix it and convey it simultaneously, the coarse material being meanwhile returned to the mills to be reground. The powder falls down a small chute to a Whittaker press, which fills first a sliding feed-box, and thence the first mould. The amount of material received into the mould can be instantaneously adjusted to allow for variations in the moisture in the material. The pressure is applied through descending plungers, the driving mechanism being so arranged as to give two distinct nips or pressures on the bricks.

The object of this is to liberate as much air from among the particles as possible, so that when the final pressure of not less than 80 tons is exerted, there may not be any air imprisoned, as this would cause cracks in the bricks.

It is necessary in Peterborough to repress the bricks, so that four distinct pressures are applied, viz., two in the first mould and two in the second.

Bricks made in this way are so dry that they may safely be taken direct to the kilns and burned in the ordinary manner.

The chief advantages of this process, for shales and other hard material, are the great pressures which may be employed, whilst yet using less power than is needed in other processes, the absence of drying arrangements and consequent saving in fuel, and the accuracy in the shape of the bricks. As these are not plastic, they shrink so little in burning that there is but little liability of twisting or warping. The disadvantages of this class of brick are their surface density, which often makes them difficult to lay rapidly, as mortar does not readily adhere to them, the absence of a peculiar texture to which plastic-made bricks owe their durability, and the difficulty experienced in obtaining a perfectly sound brick which is of equal density and strength throughout.

This last-named defect is specially characteristic of semi-dry bricks, and though many attempts have been made to remove it, there is no machine at present in use which entirely overcomes it with certain clays, which are otherwise quite suitable for manufacture by this process.

From the foregoing very brief descriptions it will be seen that the method to be employed in shaping the bricks must depend very largely on the nature of the clay, a plastic clay requiring a treatment quite different from that which is best suited to a shale or hard clay.



FIG. 12.—Barrow for Carrying Machine-Made Bricks.

In order to meet the requirements of clays in various localities numerous patterns of machines are in use, but for a fuller description of these the reader may refer to "Modern Brick-Making" (see Literature on p. 199).

Machine-made bricks are carried on stout barrows similar to that shown in Fig. 12.

**Drying.**—As already explained, it is usually necessary to dry the bricks before they can be placed in the kilns. The necessity of a careful and thorough drying becomes more apparent when it is realised that from an ordinary brick at least 1 lb. of water must be removed.

Articles made of clay are so delicate before they are burned, and are so sensitive to draughts and sudden changes in temperature, that they must be dried with exceptional care. In many parts of the country the bricks are stacked in long rows or hacks in the open air, and are protected from the direct rays of the sun and from the wind by covering boards, and by cloth, hurdles or lloo boards placed along their sides. If carefully treated, many bricks may be dried satisfactorily at very little cost, but the process is very slow—requiring several weeks—and the uncertainty of the climate is also a serious disadvantage.

Where bricks are made by machinery, it is usual to dry them by artificial heat in a building constructed for the purpose, and termed a **drier**. Some driers consist merely of large sheds, beneath the floors of which are flues heated by coke or steam. The bricks are laid on the floor, and the latter is then heated gently at a rate suitable for the particular clay in use. This arrangement is quite satisfactory for most clays, but is slow, requires a large amount of space, and consumes a considerable amount of fuel. If, however, the floor is heated by exhaust steam, the last-named consideration is of little importance.

Where the output is sufficiently large, bricks may be dried more expeditiously, with less loss and with less fuel, by passing them through a **tunnel drier**. This consists of a wooden or wood-and-brick structure of great length, which is just large

enough to hold a series of cars loaded with the bricks to be dried. Warm air is drawn into this tunnel by means of either a chimney or fan, and is distributed in such a manner that the bricks are dried as rapidly as possible with the least risk of cracking.

In the best forms of tunnel drier, the bricks are dried (*a*) by contact with warm air circulating through the tunnel in a prearranged manner, and (*b*) by radiation from a false ceiling and from the heated walls and pipes in the tunnel.

The construction of tunnel driers is in itself simple, but with delicate clays so many matters have to be taken into consideration as to make the designing of a really satisfactory tunnel apparatus a matter of great difficulty. Consequently, there are many tunnel driers in use, but only a small number of them work with reasonable efficiency. This is largely due to the principles underlying the physics of drying bricks being very imperfectly understood by most brick manufacturers and builders of driers. The physical changes which occur in drying bricks are highly complex, and until they are better known than is at present the case, an "ideal" drier cannot be designed. Nevertheless there are at least two patterns of tunnel drier in use, which appear to meet all requirements except that they are costly to instal and troublesome—though not expensive—to maintain.

In drying bricks it is essential to bear in mind that the interior must dry at the same rate as the exterior; any reversal of this will usually result in cracked bricks.

The difficulty is commonly found in heating the interior of the bricks sufficiently for the water in them to be vaporised without, at the same time, drying the exterior at such a rate as to cause cracking.

The use of warm air containing a definite and regulable proportion of water appears to be

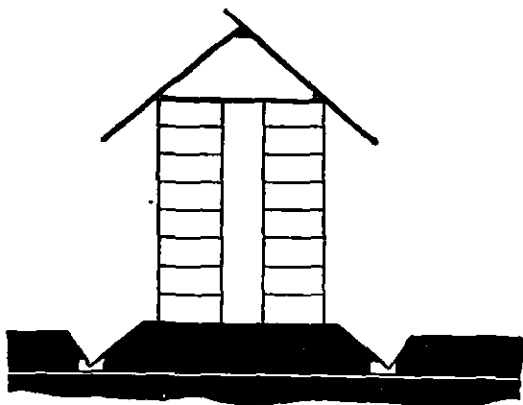
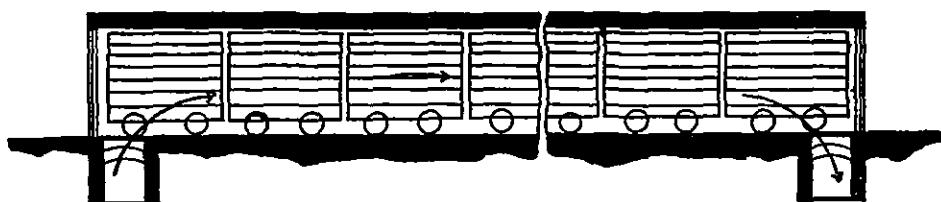
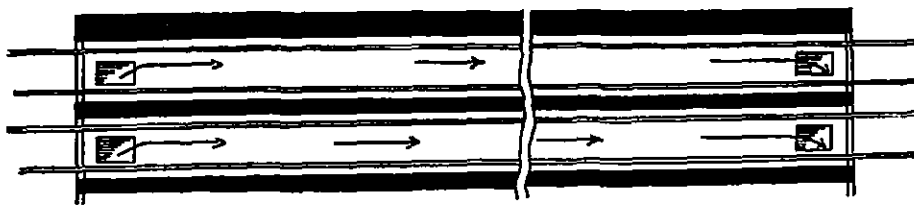

FIG. 13.—Hack or Open-Air Drier.



Longitudinal Section.



Plan.

FIG. 14.—Tunnel Drier.

the best solution of the problem, and is an important feature of all the most successful forms of tunnel drier.

All bricks have two critical periods during the drying: the first is during the removal of the first portion of the water—when the outer particles tend to shrink more rapidly than those in the interior and so cause surface cracks; and the second is when the bricks have a hardness about equal to that of leather. In the latter stage, they are often exceptionally sensitive to sudden changes in temperature, and to draughts, and also to too rapid heating. Many existing tunnel driers cannot be worked at their full capacity with certain clays because of their inability to deal with this second stage in the drying, and it will usually be found that only those driers in which the current of air travels in the same direction as the bricks are satisfactory in this respect.

The great advantage of all tunnel driers is that the goods are taken from the brick machine and are placed on cars; these cars then travel slowly through the drier, and eventually reach the kiln, without any direct handling of the bricks being necessary. On the other hand, a well-filled tunnel drier will usually cost over £1,500, if it is to be really efficient, and the interest and depreciation charges on this capital sum are sufficiently large to make many brick manufacturers prefer to use the older and more wasteful hot floor.

**Burning.**—Bricks which have merely been dried are too friable and weak to be of value. The object of burning them is to convert this weak mass into a strong stony one, which is capable of resisting all kinds of weather.

It should be noted that when bricks "baked" or heated to a point where the plasticity is destroyed, but not sufficiently for many of the particles to fuse and, on cooling, makes a strong cementitious mass, the bricks are more durable and porous and are useful for certain purposes, but they will not last as long as those which have been properly burned, *i.e.*, in which the heating has been carried to such an extent that the finished bricks consist of certain rock-like particles

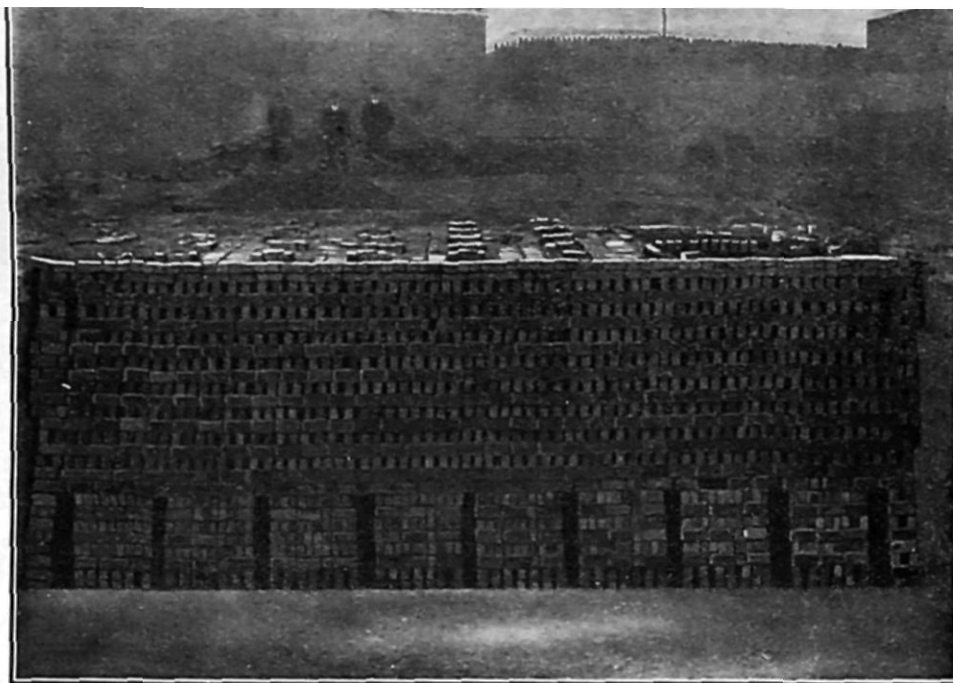

FIG. 15.—Archless Kiln.

(By courtesy of Mr H. Harrison.)

firmly bound together by a species of slag or glass. Such vitrified bricks are much valued by engineers on account of their great strength and durability, but for ordinary buildings their lack of porosity makes them difficult to lay, and many bricklayers therefore object to use them.

When a clay is worked up in a plastic condition, there is not the same necessity to burn it completely, as the bricks are usually strong and durable enough without this, the fineness of the particles and the felting nature of the clay being sufficient; but shales, rock-clays and other materials in which the plasticity has not been fully developed in the manufacture into bricks, require to be very fully burned in order that they may derive from the vitrified material the strength which they do not otherwise gain owing to their lack of plasticity.

The temperature to which a given brick must be heated in order that it may be satisfactory depends, therefore, on the nature of the material, the method of manufacture, and the purposes for which the brick is to be used. For example, a brick which is to be rubbed down to a particular shape, as in the construction of arches, etc., must be sufficiently soft for this treatment, and cannot be more than baked, whilst an engineering brick must be as hard and strong as possible. It is useless, therefore, to attempt to determine a standard temperature at which bricks shall be fired, and each brick manufacturer must decide for himself the one most suited for his customers' particular needs.

**Kilns.**—In consequence of the great variety of properties required in bricks, it

is necessary to burn them in different ways, and, therefore, to use different types of kilns.

At the present time, there are so many patented kilns for brick-burning that even a list of them would be too lengthy to be given here, and many of these patents contain ideas and features of little or no commercial value. (Details are given in some of the volumes mentioned on p. 199.)

At the same time, there are certain kilns which are of the greatest importance, and the improvements in bricks during the last thirty years, and especially in the great reduction in cost of high quality bricks, is due in great measure to the modern types of kiln now in use.

At the present time, there are five distinct types of kiln in use for brick-burning, each with its special advantages, and the brick-maker must choose according to his technical requirements and to the capital at his disposal. If his works are small, with an output of less than a million bricks per annum, he may not have sufficient output to erect a fuel-saving kiln, and must be content to suffer the disadvantages of a high cost of manufacture and burn 10-18 cwt. of coal, where, with a better kiln, 3-5 cwt. would suffice. It is commonly argued by many brick manufacturers that only a certain type of kiln can be used for their bricks, but a large experience as a consultant in brick manufacture has convinced the author that this is incorrect in most cases, and that if the output is sufficiently large to justify its erection, one of the more recent continuous kilns, in which a minimum of fuel is employed, can be used for every kind of brick and architectural terra-cotta now on the market, with a saving of 30-70 per cent. of fuel as compared with single kilns.

Great care is, however, necessary in the selection of a modern fuel-saving kiln, as several are now in use which are comparatively worthless, because the money laid down, plus the cost of repairs, overbalances the saving effected in the fuel. This is particularly the case with kilns which are too short.

In out-of-the-way districts, and for temporary purposes, the simplest form of kiln is that known as a "Clamp." This consists of a structure of unburned bricks and fuel, the latter being placed at the base, or, alternatively, between the courses of bricks. The bricks are so arranged that sufficient air can pass between them to burn the fuel and for the resulting hot gases to heat the bricks sufficiently.

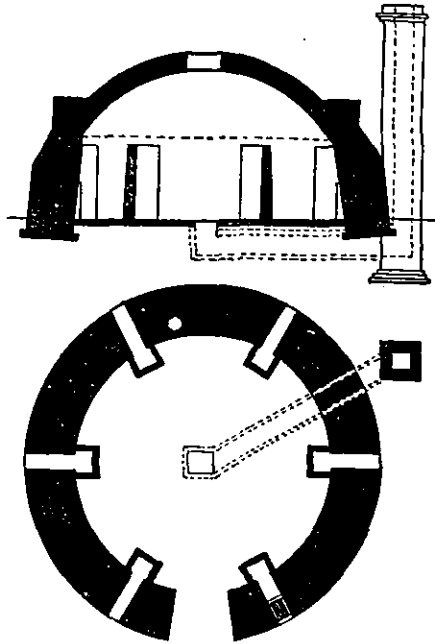

FIG. 16.—Cross Section of Round Down-Draught Kiln.

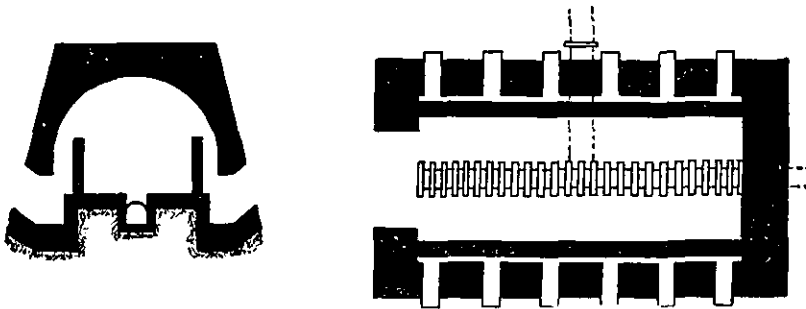

FIG. 17.—Cross Section and Plan of Down-Draught Kiln.

In such a kiln, the temperature is very irregular, but if the bricks are properly arranged it is not difficult to obtain a sufficiently large proportion of saleable bricks to meet local needs. Where a better brick is required, however, some form of kiln in which the bricks do not come in contact with the fuel, and in which the heat is under better control, must be used.

The construction of a clamp kiln requires so much skill that a detailed description of it is undesirable at this time, especially as this kind of kiln is chiefly used

for temporary work, and equally good, and often better, results may be obtained by constructing an **archless kiln** (Fig. 15) and substituting a fan for the ordinary chimney.

Such a kiln can be erected at a very small cost, and whilst the product is not so good nor the kiln so durable as when properly covered in, the bricks are more evenly heated than in a clamp, and are as saleable as common bricks in almost any district.

**Single kilns** are much used for brick-burning (Fig. 17). In these, the fuel is burned in special fire-boxes or furnaces, the hot gases passing through and around the bricks and heating them to the desired temperature.

Single kilns may be of three types, according as the general direction of the flames is upward, downward, or horizontal when in contact with the goods. **Up-draught kilns** usually have several fireplaces at each side or somewhat beneath the floor, whilst the chimney (if one is used) is at the top of the kiln. Up-draught kilns for bricks may be either circular or rectangular in shape, the latter being preferable, as they may be built of almost any capacity. In their simplest form, they consist of a space enclosed by one circular or four straight walls, the bricks to be burned being placed within the space in such a manner that the hot gases from the fires ascend through them and out at the top of the kiln.

Some up-draught kilns are covered with permanent brickwork on which a short chimney or series of chimneys is erected. As the heat enters the kiln through the fire-boxes, which are placed some distance apart, it rises irregularly in a series of different streams which do not completely mingle and consequently the goods are irregularly heated.

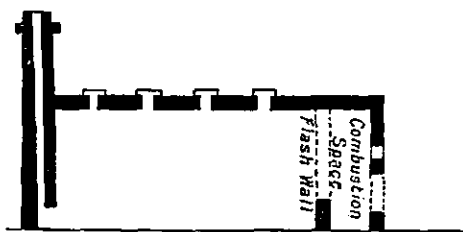

FIG. 18.—Newcastle or Horizontal Kiln.

In **down-draught kilns**, the general construction is similar, but the hot gases and flames first rise through an annular space to the top of the kiln, and are deflected downwards on to the bricks to be burned, spreading themselves fairly evenly throughout the mass, and passing through a central "well" or other openings in the

floor to the main flue, and thence to an independent chimney (Figs. 16 and 17).

The heating of such a kiln is much more regular than that of an up-draught one, and some of the best bricks ever made have been produced in kilns of this type. Their chief disadvantage is the amount of fuel required per thousand bricks burned, which is seldom less than 8 cwt., and is often much higher than this. Consequently, they are being rapidly replaced by continuous kilns in which the gases, after heating one set, are used for heating a further set of bricks, more and more bricks being used until the temperature of the gases is reduced to a point below which it is useless to employ them. Even in such a kiln, the principles of the down-draught type may be utilised in almost their original form, and for the best facing bricks the most suitable kiln for large outputs is virtually a series of down-draught kilns connected together so as to make the fullest possible use of the heat in the fire-gases.

**Horizontal kilns** (Fig. 18), with the fires at one or both ends, the flue gases being taken away at the centre, or at the end opposite to the fires, are much used in the neighbourhood of Newcastle.

They are specially suited to the production of very high temperatures, such as are needed for burning fire-bricks, but though very efficient in many ways, they are extravagant in fuel unless connected together so as to form a continuous kiln.

**Semi-continuous kilns** (Fig. 19) are intermediate between the kilns just described and those with a continuous firing. They are more economical in fuel than the former, but less so than the latter, and so are chiefly used where the output is not sufficient for a completely continuous kiln.

Though sometimes regarded as a distinct type of kiln, those working semi-continuously are really incomplete kilns which must be worked as well as the circumstances permit, and completed when trade warrants the erection of additional chambers. If it is probable that the output of the yard will only be small, it is far better to build a small continuous kiln, of the usual length, but only half or one-third the usual width, as by this means better results can be obtained. The draught in them may be chiefly horizontal or down-draught, according to the design of the kiln.

In all the foregoing types, the bricks to be burned are placed in the kiln, arranged in such a manner that the hot gases may circulate among them as freely and evenly as possible. The fires are then lighted and the temperature raised, at first with extreme care and slowness, but later more rapidly, until the goods have been sufficiently heated.

The reason for great caution at first is the necessity for avoiding a rapid evolution of water from the bricks, as, if heated rapidly, the steam formed could not escape, and would crack the bricks, rendering them useless. Even when the greatest care is taken, some bricks are usually damaged by being heated too rapidly at first. Even when the bricks appear to be thoroughly dry they may contain one-seventh of their weight of "combined water," which must be removed before the bricks have reached a temperature much above 500° C.

During the first two or three days the bricks are in the kiln, therefore, the heating must be extremely gentle, and as this necessitates the use of fires which are only allowed to smoulder or smoke and not to burn brightly, the term "smoking" is usually applied to this stage of the firing. This very gentle heating must be continued until the bricks show no signs of giving off steam, this being usually tested by putting a clean, cold poker into the kiln, leaving it there for a short time, and examining it immediately it has been withdrawn. If the bricks are still damp, the steam in the kiln will condense on the cold metal, and will reveal itself in the form of a dew. This test is only a rough one, but it suffices for most brick-makers. Others, especially on the Continent, prefer to continue the heating for a definite number of hours with the kiln at a temperature of, say, 120° C.

It is highly advantageous to have a separate flue for the gases and steam evolved at this stage, and not to pass them into the main flue. The use of such a supplementary flue improves the quality of the bricks, and reduces the amount of fuel required.

As soon as all the moisture has been removed at this temperature, the temperature is raised rather more rapidly, but still steadily, until a dull red heat is obtained. It will then be found that a further evolution of steam often takes place. This is due to the decomposition of the clay, and the liberation of the combined water in it. At this higher temperature the remains of plants which may be contained in the material begin to burn, and time is required for the complete combustion of these and of any carbon which may be in the pores of the bricks. If this stage of the burning is hurried the bricks will be discoloured towards the centre, and will have black cores or hearts.

The temperature is again raised when all the carbonaceous matter has been destroyed, and the heating is continued until the bricks have gained the necessary characteristics, when the kiln is allowed to cool, any openings being closed by slabs of fire-brick, luted up with clay paste, so as to prevent cold air impinging on the hot bricks, and so cracking them. When the kiln is sufficiently cool, the bricks are taken out, and the kiln may then be refilled with fresh ones.

After the bricks being burned have reached a red heat, the fire gases passing in a single kiln to the chimney are, naturally, very hot, but this heat is wasted in most cases. Many attempts have been made to connect single kilns together by means of flues, so as to utilise this heat as well as that given off by the cooling bricks, but they have not, as a rule, been successful unless the kilns were placed side by side. It was this desire to economise heat which eventually led to the invention of the **continuous kiln**, which consists essentially of a number of single kilns built side by side, with openings in the partition walls.

F. Hoffman went even further than this, and abolished the intervening walls, so that his continuous kiln—which may be regarded as the basis of all modern continuous ones—consisted of an annular space in which the goods were burned (see Figs. 20-22).

The original **Hoffman kiln** is equivalent to a horizontal one of infinite length, the heat being applied to the goods at one end, and passing along them horizontally until the gases are too cold to be of any further use. In practice it is not convenient to have a long narrow kiln, so that the two ends are joined and make a large annular space. It is very important that such a kiln should be sufficiently long, as if the distance travelled by the fire is too short, fuel will be wasted.

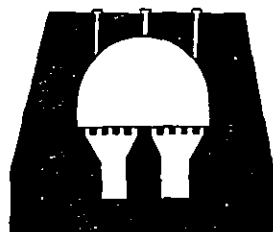
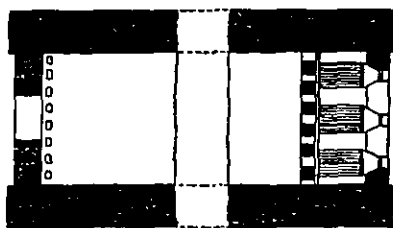

FIG. 19.—Semi-Continuous Kiln.



On this account it has been customary in recent years to alter the original design of the Hoffman kiln, and to make it either very long with rounded ends (Fig. 20), or to construct it in the form of a series of short tunnels, which turn on each other in a kind of zigzag, so as to produce a kiln, the outside walls of which are almost square in plan (Fig. 21).

In this way much less land, or that of a convenient shape, is used for the construction of the kiln, without reducing its efficiency.

For a kiln containing fourteen chambers, and a total inside chamber length of 196-200 ft. as a minimum, satisfactory results may usually be obtained, but it is

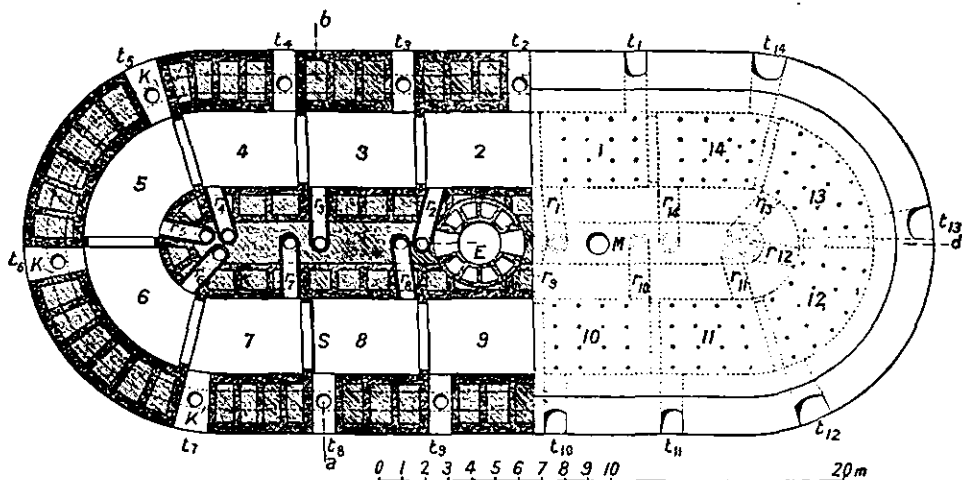

FIG. 20.—Plan of Hoffman Continuous Kiln.

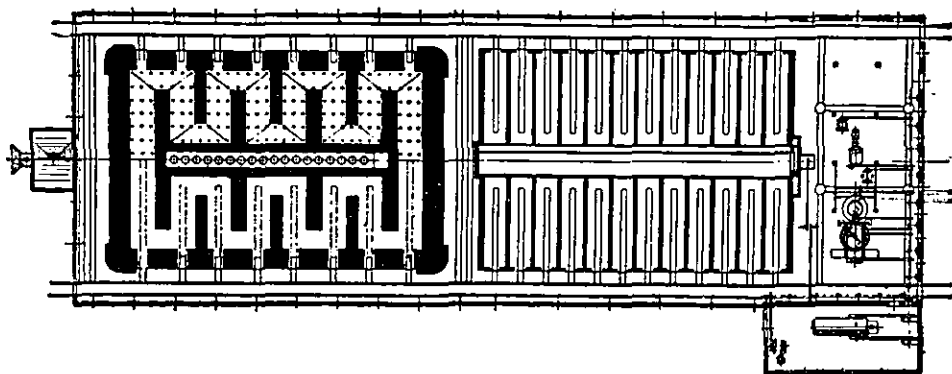

FIG. 21.—Plan of Bühler Continuous Kiln and Drier.

necessary to keep all the parts of the kiln in full work if the fullest economy in fuel is to be realised. Hence, when the output of a brickyard is likely to be small, two courses are open to the brick-maker: he may construct only half or a quarter of a continuous kiln (thus making a so-called "semi-continuous" kiln), or he may construct a complete kiln with such narrow chambers that the whole can be used, and the chambers widened as the output increases.

The former is the cheaper of the two, so far as the cost of erection is concerned, but is wasteful in fuel; the latter is much more expensive to erect and alter for enlargement, but the fuel burned is reduced to a minimum.

The method of working a continuous kiln of the simplest type is, briefly, as follows. For convenience it may be assumed that the kiln is in full working order, and contains fourteen chambers. No. 14 is being filled with bricks from the drier or machine house. No. 1 is being "smoked" by a small fire contained in a

portable stove, or in a fireplace built in the doorways of this chamber, a partition of iron or of paper separating it from the remainder of the kiln, and making it temporarily into a single kiln. No. 2 is dry Nos. 3 to 6 are being slowly heated without the direct use of fuel, by passing the hot gases from Nos. 7 and 8 (which are being heated by coal) through them. In this way the heat from Nos. 7 and 8, which would, if they were single kilns, be allowed to pass up the chimney and so be wasted, is utilised in the preliminary heating of four other chambers full of bricks, and as the gases pass from one chamber to another they gradually lose their heat, so that by the time No. 3 is reached they are at a temperature of only 150°-200° C. It is then useless to carry them through any more chambers, so they are taken direct to the chimney stack through the main flue. The fuel is supplied through feed holes in the roof of the chambers, and falls into hollow pillars made of bricks, in which it burns. No. 8 is at such a temperature that it constitutes the finishing point of the kiln; the higher numbers are those containing the finished but hot bricks. In order to cool these and so enable them to be taken out of the kiln, the doorway in No. 12 (the last chamber) is opened and air admitted. This air is drawn from No. 12 to No. 9, becoming gradually hotter by reason of its contact with the bricks, so that by the time it reaches No. 8, in which some bricks are being fired, it is hot enough to assist

13 <i>Being Emptied</i>	12 <i>Cool</i>	11 <i>Cooling</i>	10 <i>Cooling</i>	9 <i>Cooling</i>	8 <i>Being Fired</i>	7 <i>Being Fired</i>
14 <i>Being Filled</i>	1 <i>"Smoking" or "Drying"</i>	2 <i>"Dry"</i>	3 <i>Hot</i>	4 <i>Black Hot</i>	5 <i>Nearly Red Hot</i>	6 <i>Red Hot</i>

FIG. 22.—Showing State of Goods in Continuous Kiln.

greatly the combustion of the fuel. In this way the heat contained in the cooling bricks is used over again for the heating of a further lot. Taking the chambers in the order given, it will thus be found that the temperature in each gradually rises, Nos. 1 and 2 being at something below 120° C., Nos. 3 to 7 from 120°-900° C., and No. 8 about 1,100° C., or less with some clays. From Nos. 9 to 13 the temperature gradually falls again from 1,000° C. to the temperature at which the bricks are taken out of the kiln—usually about 25° C., or as hot as they can be handled comfortably.

When No. 8 has been heated sufficiently the connection between No. 3 and the chimney is closed and the partition between No. 2 and No. 3 is removed (if it is paper it is simply torn with a poker), so that the hot gases now enter No. 2. Fuel is next fed into No. 6, but no more is added to No. 8, which therefore begins to cool. In No. 1 (which should now be filled with fresh bricks) the "smoking" process is begun so as to drive out the water in the bricks. In this way the whole process of heating is moved on one chamber, and the bricks in No. 12 will now be cool enough to be taken out and it refilled. In this way the action of the kiln is quite continuous so long as there is a sufficient supply of bricks to be burned, as the fire travels forward, usually at the rate of one chamber per day, and the kiln being circular in principle, whatever its apparent form, it acts as though it were of infinite length.

Although a kiln with only fourteen chambers has been described, as this represents the size generally used, the author considers it too short for convenience and prefers a kiln with at least

sixteen chambers. The larger the number of chambers (within certain limits) the more satisfactory will be the burning. Some kilns have forty chambers.

Many variations have been made in the design of continuous kilns, though the general principle first applied by Hoffman is continued in each of the newer kilns. The alterations consist chiefly in means used to produce a better colour in the goods by keeping them out of contact with the fuel, and to effect the preliminary drying in the kiln.

The chief variations, therefore, consist in some means of burning the fuel in special fire-boxes and in effecting the drying and smoking by means of warm air derived from the kiln itself instead of from separate fires.

For producing bricks in which the colour is an important consideration the fuel is most conveniently burned in fireplaces built across the kiln between each two chambers, the kiln being usually, though not necessarily, divided by partitions of permanent brickwork. These partitions absorb a certain amount of heat, and so reduce the efficiency of the kiln as a whole, but the small loss from this cause is more than counterbalanced by the improved colour of the goods. There is much divergence of opinion as to the relative values of fire-boxes with solid bottoms and those with grates. Much depends upon the nature of the fuel, and when this will burn on a solid bottom the labour of cleaning the grates is obviously avoided. For other coals, a grate may be essential to good combustion.

In the original Hoffman kiln, the fuel is burned in small shafts left in setting the bricks in the kiln, and corresponding to openings in the top, through which the fuel is fed in small quantities at a time every fifteen or twenty minutes. When fire-boxes or fire-grates are used, however, the fuel is added either from the front of the kiln or through openings in the top and above the grate or fire-box, and larger quantities may be added at a time. The hot gases and flames from the burning coal then rise upwards, but are rapidly drawn horizontally by the draught of the kiln until they circulate throughout the whole width and height of the chamber, the bricks being placed in such a manner that there is an appropriate space around each for it to be properly heated by the gases. If it is desired to produce bricks which are of a specially clear colour, a permanent flash wall may be built alongside the fire-box or grate, so as to force the flame and hot gas upwards to the top of the kiln, where combustion is completed before the goods are reached, and all chances of the flame coming into contact with the bricks are avoided. In this way, a series of down-draught kilns may be worked on the continuous principle, the gases being taken out at the floor of the chamber, instead of at the side as usual. This alteration involves a more complex flue construction, but has certain advantages which need not be detailed here (see Fig. 23).

The use of hot air produced by the kiln itself for the smoking or preliminary warming and drying of the goods has not met with the appreciation it deserves. This is due to a variety of causes, the chief of which is the general attitude of the burners who prefer what, to them, is the simpler method of using stoves or special fires, though the latter are far from economical. The position of the flues used to convey the hot air in certain kilns is also very bad, and has caused this method of economising fuel and labour to fall into disrepute. Not a few designers of continuous kilns have ignorantly placed the hot-air flues in the positions where they are most likely to be influenced by changes in the temperature of the kiln, and by the movement of the masonry, with the result that, after a short time, these flues leak and become practically useless. They should, obviously, be placed where they will be most stable, as a leak of comparatively small dimensions may be impossible to locate or repair, and yet may be fatal to the use of the flue.

The object of using warm air in place of special stoves or fires is two-fold, viz., the economy in fuel effected and (what is usually more important) the absence of white or grey deposits on the bricks due to the condensation on them, whilst in a damp state, of sulphuric acid derived from the burning fuel. When the goods are at a temperature above that of boiling water such condensation cannot occur, and direct heating may then be used, but for raising them to this temperature it is usually desirable to employ air free from products of combustion.

This pure, warm air must not, as a rule, have a temperature above 300° C., and at the commencement of the heating of the freshly set bricks it should be much cooler, though its most suitable temperature cannot be stated definitely, but must be ascertained by experiment, as it differs with different materials, some being more open and so drying more readily.

The warm air used may be obtained from various sources, and can seldom be all obtained from only one. The most obvious part of the kiln from which it may be obtained is the chambers containing the cooling bricks, as by connecting these to the ones containing the freshly set goods, by means of temporary or permanent flues, it is easily possible to draw air of any desired temperature through the latter. The details of the various systems of pipes and flues used for this purpose are too complex to be given here, but it may be stated that permanent flues are usually better so far as the economy of heat is concerned, though they are more liable to leak than the temporary ones, which are generally made of metal.

The heat obtainable from the chambers of cooling bricks is seldom sufficient, and it must, therefore, be supplemented by air heated specially in some other part of the kiln. Many devices have been patented for the supply of this additional air, the two most successful being to construct a series of flues either below the floor or above the arched top of the kiln, and to draw air through these at such a rate that it may gain the desired temperature before it enters the chambers to be warmed. As much of the heat in the brickwork is usually lost by radiation, it will readily be seen

that flues arranged in these places will really save a certain amount of heat which would otherwise be lost, so that by no means all the heat thus supplied to the air passing through these flues can be considered as involving an additional consumption of fuel, though there is necessarily a slight increase in the amount of fuel burned in the firing proper when these flues are used. This is so much less than that required in the stoves or special fires that a distinct saving on the whole kiln is effected.

The hot air (from whatever sources) is led through flues to the cold chambers which require to be warmed, and enters them by suitable flues and openings. There is much divergence of opinion as to the best position in which to admit this air, some authorities preferring to allow it to enter at the top and work downwards, whilst others adopt the opposite direction. Personally, the author prefers to use an entirely upward direction for the gases during the smoking, or to dry and warm at least the lower contents of the kiln by means of an up-draught. The reason for this preference is the fact that when the warm air or gases enter at the top of the kiln they gradually become saturated with water removed from the bricks themselves, and at the same time they become cooler, with the result that by the time they reach the lower portion of the kiln they cannot contain all the moisture, and deposit some of it in the form of a dew on to the bricks. The deposition of this water softens the bricks, and, owing to the pressure of the bricks above them, makes them lose their shape. When, on the contrary, the hot air or gas rises in an upward direction, the moisture deposited on the bricks still softens them, but as they have but little weight to bear no change in shape occurs. The upward movement has the additional advantage that must occur from allowing the warm gases to travel in their natural direction, and if they are not overlaid with moisture a better draught is produced owing to the reduction of the internal friction of the kiln.

The substitution of a fan for a chimney has not been appreciated to any great extent, because most existing brickworks have chimneys, and their owners do not see that any saving would be effected by the substitution of a fan, especially if they are not working at their full capacity.

In some parts of the Continent, however, and in several instances in this country, the use of a fan has effected a considerable saving in the amount of fuel burned, as it enables the draught of the kiln to be kept constant instead of being affected by climatic conditions, as is invariably the case with a chimney.

The object of a chimney, or fan, is to draw the necessary amount of air through the fuel and gases through the kiln. It is commonly supposed that a chimney does this without cost, whereas a fan requires power to drive it. As a matter of fact, however, a chimney requires the expenditure of a certain amount of fuel, as the gases passing up the chimney must be hot, and this fuel is more than sufficient, in most cases, to drive the fan. In calm weather and under good conditions the fan and chimney, therefore, cost about the same for running expenses, but in rough weather the amount of fuel needed to keep the chimney working is greatly increased, whilst the fan is not affected; and, further, the interest on capital needed for the erection of a chimney or the installation of a fan is much in favour of the latter. For continuous kilns, therefore, a fan should be used whenever possible. In single kilns, where no use can be made of the hot gases produced, a fan is not desirable.

In an ordinary kiln of the continuous type it is seldom that the fire travels forward more than 15 ft. per twenty-four hours, and a rate of 1 ft. per hour is considered high. In the Bühler kiln, however, thanks to its enormous relative length and the use of a fan, the fire travels forward at the rate of 8 or even 10 ft. per hour, and the amount of fuel saved is, therefore, considerable. So rapid a rate and so long a kiln could not be obtained when a chimney is used; hence it was only on the introduction of a fan that this method of working became possible. Its success is due to the fact that although the rate of travel of the fire is so rapid this is counterbalanced, so far as its deleterious effects are concerned, by the length of the kiln, for most bricks can be heated very rapidly when once they have reached a dull red heat, provided that they are supplied with sufficient air to burn out the carbonaceous matter in them, and to oxidise the iron compounds. The length of the kiln enables the "waste heat" to be used to warm the goods very effectively without any danger of cracking them. Clays very rich in carbonaceous matter might require a somewhat slower treatment.

The great length of the kiln is not apparent in the actual buildings, because it is so designed that it really forms a more compact structure than similar kilns of the ordinary type.

For burning facing bricks, ornamental bricks, terra-cotta, and other similar goods in which the colour and appearance are of very great importance, difficulties have often been experienced when continuous kilns are used, and it has been generally maintained that single down-draught kilns were essential for the production of articles of good colour.

This is quite a mistake, for by arranging a continuous kiln specially for the purpose, goods equally beautiful in appearance to any produced in single kilns may be obtained.

It is quite true that an ordinary continuous kiln will not do for this purpose without alteration, for it is designed chiefly with a view to economical working, but with a suitable arrangement of fires and flues (Fig. 23), especially those for the introduction of warm air and the removal of steam, the best results may be obtained with an expenditure of fuel not more than three-quarters, and frequently less than half, that needed in a single kiln.

The most suitable kiln for this class of work is one in which the draught is partly horizontal and partly downward, fireplaces being provided for burning the fuel, and each chamber separated from the others by permanent partitions, in which, however, damper-controlled openings may be made so that the "waste" gases pass direct from one chamber to another.

The production of a good colour in bricks depends primarily on the material used; but assuming that this is suitable, the most important requirements are (1) that the goods shall not come into contact with the flame or ashes from the fuel; (2) that the goods shall be raised to a temperature above that of boiling water before coming into contact with gases produced by burning fuel; and (3) that the goods shall be supplied with sufficient air at certain stages of the burning, this air supply being capable of accurate regulation.

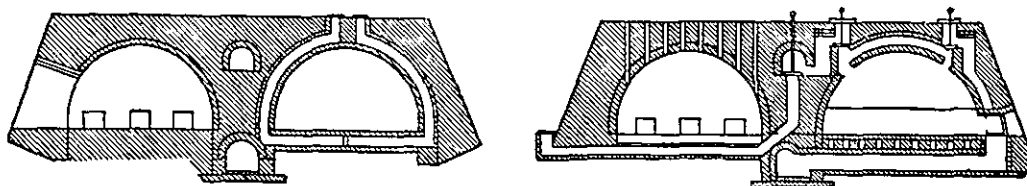

FIG. 23.—Cross Sections of "Staffordshire" Kiln showing Hot-Air Flues.

(By courtesy of Messrs Dean, Hetherington, & Co.)

To fulfil these conditions it is necessary, chiefly, to warm the goods thoroughly with pure air before connecting the chamber containing them to the circuit of the kiln, and the key to the whole position lies, therefore, in the means supplied for the provision of hot air in any quantity, and at any time it may be needed (p. 220).

### FUTURE PROGRESS

In **building bricks**, the chief progress made by the introduction of machinery and modern methods has been in the direction of producing bricks of more accurate shape, or greater strength, and of more regular colour and pleasing appearance, and yet all these advantages, great and notable as they are, have been accompanied by such remarkable reductions in the cost of production that in some districts good bricks could be obtained in 1914 for sixteen shillings per thousand. The average cost in other parts of the country is little more than half what it was some thirty years ago. Future progress will probably result in the still further replacement of human labour by mechanical devices, in an extension of the use of continuous kilns, and in endeavours to secure large outputs throughout the year, instead of closing down during the winter months as so many brickworks now do. The great increase in the number of Associations, whose chief object is to regulate selling prices, may also have an important influence on the future development of brick-making.

## SECTION LXX

# LIME-SAND BRICKS

BY JAMES SHELTON, F.I.C.

### LITERATURE

- PEPPEL.—“Manufacture and Properties of Artificial Sandstone.” *Trans. American Ceramic Society*, 1903, IV. and V.
- ECKEL.—“The Annual Convention, National Association of Manufacturers of Sand-Lime Products.” *The Clay-Worker*, Indianapolis, 1904, XLII., 582-591.
- OST.—“Lehrbuch der Technischen Chemie.” 1911, p. 426.
- MARSTON.—“Tests of Sand Lime and Sand Cement, Brick and Concrete Building Blocks.” *Engineering News*, 1904, LI., pp. 387-389.
- CRUME.—“Present Condition of Sand-Lime Brick Industry, Rock Products.” Chicago, 1913, XII., p. 48.
- “Manitoba Sand-Lime Brick Manufactory.” *The Clay-Worker*, 1905, XLIV., pp. 586-587.
- “Iowa Granite Brick Company.” *The Clay-Worker*, 1906, XLV., pp. 63-64.
- SMYTHE.—“Sand Lime Brick.” *The Clay-Worker*, 1907, XLVII., pp. 532-534.
- MAUSER.—“Some Tests on Wisconsin Sand Lime and Claybrick.” *The Clay-Worker*, 1907, XLVII., pp. 534-538.
- SEARLE, A. B.—“Modern Brickmaking.” London, 1911.
- “Bricks of Non-Plastic Materials.” London, 1913.

There are frequent articles in *The British Clayworker* and in the *Brick and Pottery Trades' Journal*; also a brief, but exhaustive, German literature on this subject.

**Lime-Sand Bricks.**—It has been known for many years that a mixture of slaked lime and sand will dry to a solid mass which hardens very slowly on exposure to the atmosphere, owing to recarbonation of the lime. Partial combination between lime and sand can be induced by submitting an intimate mixture to the action of steam under high pressure. This production of a calcium silicate (or aluminosilicate) cementing together the grains of sand is the essential feature of the process for the manufacture of lime-sand bricks.

**The sand** should be free from more than 5 per cent. of clay and dark particles, but 1 or 2 per cent. of clay is advantageous.

It was at one time considered desirable that the sand used should contain soluble silica, but this has since been found to be unnecessary. Hence quartz sands are now used extensively, and it is no longer considered that felspar sands containing 5-7 per cent. of soluble silicic acid are the best raw materials for lime-sand bricks.

At least 10 per cent. of the sand should pass a sieve of 150 mesh, and all of it should pass a 20-mesh screen. With increasing percentages of fine sand the compressive strength of the bricks is diminished, whilst their tensile strength is increased. To obtain the best results, however, it is necessary to grade the material very thoroughly, as the preponderance of many particles of any one size is deleterious.

**The lime** should be as pure as possible. Magnesia if present combines with silica to form a silicate, which is said to have less mechanical strength and to be

less resistant to frost. Further tests are necessary on this point, as many excellent bricks have been made using dolomitic lime.

Bricks made with hydraulic limes (see p. 82) are inferior, this form of lime being quite unsuitable, as it does not slake properly.

The slaked lime is mixed with 10-30 parts of sand in mills similar to those used for mortar mixing.

In the Schwartz process (*Engineering News*, 1903, XLIX., p. 179) sand is dried and mixed with unslaked lime in a vacuum mixing machine. Water is then added to slake the lime and make a plastic mixture. It is claimed that this process increases the strength of the bricks.

The wet mixture of lime and sand is moulded into bricks under a pressure of from 1-1½ tons per square inch. The bricks are then placed on waggons and are run into the hardening chamber where they are submitted, for about eight hours, to steam at 180° C. and 10 atmospheres pressure. The autoclave or hardening chamber is 30-45 ft. long and 5-6 ft. in diameter, and is constructed of boiler plate. The bricks, after leaving the boiler, are then quite ready for the market, but they are usually allowed to remain in stock for a short time.

Specifications for lime-sand bricks of the best quality require an average crushing strength of 2,580 lbs. per square inch with a minimum of 2,560. Second quality bricks should have an average crushing strength of 2,130 lbs. per square inch with a minimum of 1,920. It is interesting to compare these with an ordinary lime-sand mortar (1 lime to 3 sand) which rarely has a crushing strength over 200 lbs. per square inch.

Lime-sand bricks are more fragile and in some ways inferior to bricks made of clay, but they are stronger than London stock bricks, and being readily made in districts devoid of clay, they are very useful for most building purposes. Their porosity is similar to that of bricks made of clay, with the exception of engineering bricks, which are purposely made non-absorbent. Sand-lime stone, if well made, possesses great homogeneity and can be easily worked by the mason.

The cost of manufacture of lime-sand bricks is slightly less than that of bricks made of clay, but the difference is not appreciable unless the works are exceptionally well managed.

The manufacture of lime-sand bricks in the United States and in Germany is very extensive. In Great Britain it is small on account of the phenomenally low prices at which clay-bricks are sold in consequence of competition. In sandy districts where clay is not abundant, lime-sand bricks offer great possibilities, provided that the plant is properly devised and constructed. Most of the failures have been due to ignorance or to a wilful departure from the recognised essentials in order to produce them at a lower rate. When rightly made, lime-sand bricks serve the same purposes as clay building bricks.

Their manufacture is described fully, and the most important precautions necessary are mentioned in the only book in English devoted to the subject—"Bricks of Non-Plastic Materials," by A. B. Searle.

## SECTION LXXI

# TILES AND TERRA-COTTA

BY ALFRED B. SEARLE

### LITERATURE

"Treatise on Ceramic Industries," by E. Bourry (Translated by A. B. Searle); "Leadless Decorative Tiles, Faience, and Mosaic," by W. J. Furnival; "Roofing Tile Manufacture," by A. T. Ackworth; "Bricks and Tiles," by E. Dobson and A. B. Searle; "Das Gesammten Tonindustrie," by Bruno Kerl; "Industrie Céramique," by Albert Granger.

### TILES

TILES are used for three entirely different purposes—(a) for roofs and exterior walls; (b) for pavements and floors; and (c) for interior decorations. In each case a different material is employed, roofing tiles being made of plain clay burned to a moderate degree of hardness, but many of them being somewhat porous, whilst paving tiles must be as hard as possible, and should be completely impervious to water. Decorative tiles are almost invariably glazed, and are really earthenware or porcelain products (see sections on **Earthenware** and **Porcelain**).

**Roofing tiles** bear a very close resemblance to bricks (p. 199), and are manufactured in a very similar manner, the processes being merely modified to suit the production of thin articles. Such tiles are made of the same clays as bricks, but only the finer varieties are used, as the very coarse particles present in some brick clays would prove detrimental to tiles on account of the thinness of the latter.

No detailed description of the manufacture of roofing tiles is needed here; the reader who requires further information should consult the literature mentioned above.

**Paving tiles** bear a close resemblance to stoneware (*q.v.*), and to the vitrified or blue bricks of Staffordshire (p. 200), and are made in a similar manner.

They are usually either terra-cotta red, blue, or black in colour, but some buff or yellow tiles are occasionally used for the purposes of decoration. Such tiles are made in a manner similar to bricks or roofing tiles, but require special care in burning; if insufficiently heated they will be soft, and will wear badly, but if overheated they will twist and warp. The chief skill of the paving tile manufacturer is, therefore, employed in the selection of suitable raw materials and in heating them in a suitable manner.

The nature of the raw materials is described under the caption **Stoneware**, but for paving tiles materials of a lower grade and containing more impurities than those employed for the better qualities of stoneware may be used.

In order to obtain highly decorative inlaid patterns, **encaustic tiles** are made. These are produced in moulds with separate divisions. Clay slip or powder of one of the colours to be used is placed in the desired divisions of the mould, and other clay slips or powders of different colours are placed in other divisions, this process being repeated until all the divisions are filled with the appropriate colours and pressed if necessary. After the tile has been removed



from the mould and its surface cleaned, the pattern (in colours) will be visible, and on burning will be clearly defined.

As different clays shrink differently it is necessary to use skilfully prepared powders and slips in order that all may have the same shrinkage on drying and burning.

**Glazed tiles** are used in increasingly large quantities for decorative and hygienic purposes. Most glazed tiles are of an earthenware character and are made in a manner very similar to earthenware (p. 157).

It is possible to glaze red-burning clays such as those of which bricks are made, but the difficulties connected with the use of such clays are usually sufficiently great to render the employment of the mixtures used in earthenware manufacture preferable for glazed tiles.

For hospital use and for some technical purposes, it is necessary to use tiles made of fire-clay and glazed with a hard-fired, leadless glaze, as such tiles are more resistant to acids and variations in temperature than are those made of earthenware and covered with a more fusible, plumbiferous glaze.

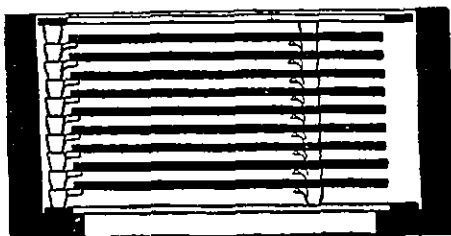

FIG. 1.—Tiles in Sagger.  
(After E. Bourry.)

Very large tiles (*i.e.*, those measuring more than 12 × 12 in.) are also made of the same materials, further particulars of which are described under "Glazed Bricks" (p. 200), or "Sanitary Ware" (p. 194).

The manufacture of very large slabs of glazed ware is accompanied by many difficulties, the chief of which are due to the tendency of clay to twist or warp when heated in the kilns. For this reason it is essential that such slabs should not be too thin to resist this twisting action. Unglazed slabs may sometimes be kept flat by weighting them when in the kiln, but as

nothing must be allowed to touch a glazed surface when the goods are being fired, this method cannot be applied to glazed slabs or large glazed tiles.

## ARCHITECTURAL TERRA-COTTA

There is, at the present time, an enormous demand for large masses of burned clay—both plain and ornamental—for the exteriors of large and semi-public buildings, particularly in industrial centres. In some localities the natural colour of the burned clay is preferred, and **terra-cotta** is therefore used; but in other places a light coloured or almost white glazed surface is desired, and for this purpose what is known as **glazed terra-cotta** is employed.

Ordinary terra-cotta is made of any clay which has a sufficiently uniform and pleasing colour when burned. The better kinds of brick and roofing tile clays (p. 145) are, therefore, used in its manufacture.

Ordinary terra-cotta blocks are, in fact, exceedingly like large bricks, and are made in a very similar manner, the chief differences in manufacture being the moulding by hand or the direct carving or modelling of the block from a mass of clay paste instead of using mechanical means for its production, and the special precautions required in order to prevent irregular shrinkage, twisting, or a blotched appearance of the blocks. These details are, however, outside the scope of the present work, and the reader who requires further information must consult an expert on the subject or read some of the works mentioned under the caption Literature on pp. 151, 199, and 225.

Glazed terra-cotta must usually be made of a more refractory clay than that used for unglazed terra-cotta, as the only glazes applicable to the latter are seldom able to withstand the action of the British climate, especially the atmosphere in large towns with a manufacturing interest. Hence the general use of glazed terra-cotta made of fire-clay or covered with a hard-fired glaze similar to that used for sanitary ware, but of a less glossy character.

For exterior work, a highly lustrous glaze would not be pleasant, so that the glazes actually used are purposely made deficient in fusible matter or fluxes, and in this way they produce a semi-opaque,

dull, or even matt glaze. The essential constituent of these glazes is felspathic material, the fusibility of which is modified so as to suit the requirements of the case by the addition of various fluxes, such as whiting, or of opacifying and shrinkage correctives such as clay and flint.

**Hollow partition blocks** are a form of architectural terra-cotta which has met with very extensive application during the past few years. They are chiefly used for the filling of wall spaces in buildings of steel or concrete, and are economical in erection as well as possessing other advantages such as lightness combined with highly sound-proof properties. Such hollow partition blocks are made by expressing the clay paste through a special die in a manner similar to the manufacture of sausage, the hollow portions being formed by cores inserted in the mouth-piece and the blocks being cut to a suitable length. In order that the walls may be sufficiently soft and tenacious for nails to be driven into them, the clay is usually mixed with a considerable proportion of fine sawdust; this burns away in the kiln, leaving a porous material which is very light and is admirably suited for inside work.

**Flooring blocks** of terra-cotta are extensively used in concrete construction. They closely resemble the hollow partition blocks just mentioned, and are made in a similar manner. Their shape varies greatly according to the ideas of the architect or engineer using them, some preferring rectangular blocks whilst others prefer pipes of triangular or half-round section. As the terra-cotta is buried in concrete its appearance is of small importance, and so long as it possesses the required strength it is immaterial of what clay it is made. In the majority of cases, however, such flooring blocks are made of plastic red-burning clay with or without the addition of sawdust.

## SECTION LXXII

# FURNACE LININGS AND OTHER REFRACTORY MATERIALS

BY ALFRED B. SEARLE

### LITERATURE

"British Clays, Shales, and Sands," by A. B. Searle; "Modern Brickmaking," by A. B. Searle; "The Clayworker's Handbook," by A. B. Searle; "Refractory Materials: their Manufacture and Use," by A. B. Searle; "Treatise on Ceramic Industries," by E. Bourry (Translated by A. B. Searle); "Feuerfesten Tone," by C. Bischof; "Fabrikation der feuerfesten Steine," by F. Wernicke; "Handbuch der gesammten Tonindustrie," by Bruno Kerl; "Tonindustrie im Glashüttenbetriebe," by H. Schnurpfeil; "Gesammelte Schriften," by H. Seger.

American refractory clays are described in "Clays, their Occurrence and Properties," by H. Ries.

*The Journal of the Society of Chemical Industry, The British Clayworker, The Brick and Pottery Trades' Journal, The Journal of Gas Lighting,* and the *Gas World* contain the most recent publications on refractory materials with abstracts from the chief foreign books and journals. The *Transactions* of the English and American Ceramic Societies also contain occasional papers on the subject. For further references Branner's "Bibliography" or Solon's "Ceramic Literature" should be consulted.

**Raw Materials.**—The essential characteristic of any refractory material is that it must withstand the action of high temperatures for as long a time as the purposes for which it is used may render necessary.

Bricks are not considered to be fire-bricks if they begin to melt at a temperature lower than  $1,580^{\circ}$  C.

In practice, however, other considerations are also to be taken into account. Thus, a fire-brick may, of itself, be able to resist the highest temperature to which it is exposed, but it may be less valuable, for some purposes, because it is unable to resist the cutting action of the furnace gases or slag like another fire-brick which is less resistant to a high temperature alone. For this reason many fire-bricks are in use at the present time which are not distinguished for their remarkable refractoriness when heated in a clean atmosphere, but which do possess an exceptional resistance to the actual conditions which prevail in the furnaces or other structures in which they are employed.

One of the first considerations in selecting a fire-brick or other refractory article should therefore consist in ascertaining precisely what are the conditions under which the brick or other article will be used, and the various forces to which it is desired it shall be resistant.

Thus, a metallurgical furnace will usually involve the production of a considerable amount of slag of a basic character, and this will rapidly attack any purely siliceous lining, but will have a far smaller action on a lining made of a highly aluminous clay. If the nature of the operation involves the production of acid or neutral products, on the contrary, a more siliceous clay (which is cheaper), or even a comparatively pure silica or ganister may be used. In the construction of flues and boiler settings, on the other hand, the chief difficulty is to find a material which will resist the cutting action of the dust in the gases and the reducing action of the gases themselves. For such purposes it is therefore more important to have a close-surfaced brick of a hard and strong nature rather than a soft and porous surface made of a material somewhat more resistant to the action of heat alone.

The selection of a refractory material must therefore depend on the purposes for which it is to be

used, and in cases of doubt it is wise to obtain expert advice upon the subject, or at least to inform the manufacturers of the bricks of the purposes for which they are intended. Thus, coke ovens and cement kilns are lined with bricks rich in alumina, glass tanks are made of siliceous clays, and basic furnaces must be lined with basic bricks.

The raw materials used in the manufacture of refractory goods such as fire-bricks, gas retorts, glass makers' pots, furnace linings and crucibles, etc., must necessarily possess a sufficient resistance to heat to enable them to be used for the desired purpose. It is, in fact, generally recognised that no material which shows distinct signs of fusing when heated to a temperature of  $1,580^{\circ}$  C. should be regarded as refractory, and should therefore be excluded from the mixture of which refractory goods are made. The one exception to this is when the goods are made of non-plastic material and a binding agent is necessary to unite the particles together; this binding agent cannot as a rule be refractory, as its purpose is opposed to the properties possessed by refractory substances. The ideal binding agent is, however, one which is affected by heat until in a state when it binds the particles together, but after this it combines with the particles themselves in such a manner that the action of heat upon it is no longer observable.

The basis of all refractory articles is either fire-clay, one of the various forms of relatively pure silica which occur in nature, or an infusible oxide such as alumina, lime, or magnesia. The fire-clays occur chiefly in the Coal Measures, in intimate association with the coal seams, but those in some districts, such as around Stourbridge, in central Yorkshire and in the West of Scotland, are superior to most of the fire-clays found in other localities. As already remarked, however, it is not necessarily the most infusible clays which are the most resistant under given technical conditions. Fire-clays are distinguished by their relative freedom from lime, magnesia, potash, soda compounds and iron, though they usually contain small proportions of each of these substances.

No direct connection has yet been found between the composition of a clay and its resistance to heat, but this may be due to the difficulties experienced in accurately measuring the effect of heat rather than to the absence of such relationship. Several investigators have found an approximate connection between the composition of the purer fire-clays and their softening temperatures, but the difficulty of ascertaining the temperature at which a fire-clay begins to melt and the ease with which erroneous conclusions may be drawn on account of the complexity of the clays and their low conductivity of heat, prevent any accurate relationship being found at the present time. There is, in fact, considerable scope for investigation of this relationship, but the research would have to be taken up by men sufficiently well acquainted with the difficulties and peculiarities of the problem, or erroneous conclusions would almost certainly be drawn. For instance, it is commonly understood that clays do not possess a single melting point, but fuse over a range of temperature, instead of sharply, as do substances of definite chemical composition. That this statement is incorrect is by no means impossible, notwithstanding its apparent agreement with experience, for if it be postulated that the conductivity of clay is so low that an abnormally long time is required for the whole of the mass to attain to a given temperature, it will readily be understood that the apparent range of fusion is entirely due to the low conductivity of the clay. The abnormal behaviour of very small pieces of clay rather confirms this postulate, though the difficulty of avoiding irregularities in composition, when very small fragments are examined, increases the difficulty of drawing accurate conclusions.

Whilst, therefore, the composition of a fire-clay as revealed by analysis will not necessarily indicate its refractoriness, it may be generally understood that all the more refractory clays do not contain more than 3 per cent. of basic oxides such as lime, magnesia, potash, and soda (the last two being commonly considered together under the term *alkalis*). Iron compounds behave peculiarly in fire-clays but it is seldom that more than 2 per cent.—calculated as ferric oxide—is permissible, and a much smaller proportion is generally more desirable.

In consequence of the small proportion of iron present (and that usually in the form of pyrites), fire-clays do not burn red as do most building bricks, but produce goods of a pale buff or cream colour, their appearance being often spoiled by small black spots due to the reaction of the ferrous sulphide, derived from the pyrites, on the clay.

These spots are not produced unless the clay has been heated to a somewhat high temperature and some makers of fire-bricks therefore burn their goods at temperatures not exceeding  $1,200^{\circ}$  C.; users are, however, gradually realising that the black spots which disfigure the surface of bricks

burned at higher temperatures are really an index of the temperatures reached in the kiln and are thus, indirectly, a testimonial to the refractoriness of the bricks. This is particularly noticeable in the case of the Glenboig bricks which are among the most heat-resisting bricks known.

Instead of an analysis, it is preferable for the purchaser of fire-clays or refractory goods to have the results of the action of heat on the material; this usually takes the form of a statement as to the "softening point" (often, but inaccurately, termed the "fusing point" or "melting point"). This is determined by making the material into the shape of a small pyramid whose height is about five times its base and heating it slowly in a suitable furnace. The temperature at which the apex of the pyramid bends over and touches the base is regarded as the softening point.

To obtain the best results it is necessary to make the pyramid of a special shape and it is advisable, instead of measuring the temperature, to compare the behaviour of the sample with that of Seger cones and to report the softening point in terms of Seger cones. The Institute of Gas Engineers, in their official specification, adopt a somewhat different definition, inasmuch as they regard the softening point as that at which the first signs of fusion can be observed in the sample, especially by a rounding of the edges. There is no very definite relationship between this and the bending just described, though the latter usually occurs at a temperature about 60° C. higher than the former with the purer fire-clays.

Other tests, which reproduce the conditions likely to be experienced in actual use, are very important. Among these, are the behaviour of the articles at 1,350° C. when under a load, when rapidly cooled, when cut with an emery wheel, and when covered with slag and re-heated.

**Fire-clay bricks** and similar articles are made by moulding a paste prepared by mixing the finely ground fire-clay with powdered calcined fire-clay and water. The grinding is accomplished in edge-runner mills similar to those used for building bricks (p. 204) and the mixing is usually effected in open mixers (p. 205) or even in pug mills (p. 207), the vertical pattern being generally preferred to the horizontal ones used for ordinary bricks.

The calcined clay or **grog** is used to keep the shrinkage of the brick as low as possible, and also to give an open texture so that the fire-bricks will resist the disruptive action which sudden changes in temperature have on fine-textured masses. On the Continent, it is the custom to use a very large proportion of grog and only a small proportion of plastic clay, but the makers of refractory goods in Great Britain adopt the opposite procedure and claim that the Continental method is inapplicable to British clays. Extensive investigations of both methods by some of the most eminent specialists in Germany have convinced the Continental makers that their method gives the best results, and lead to the conclusion that the opinion held by British manufacturers is due to lack of initiative rather than to the absence of suitable clays in Great Britain. Attempts by several enthusiasts in this country to adopt what they thought were German methods (though in reality they were defective imitations) have made other manufacturers unwilling to investigate the matter on a sufficiently extensive scale (see p. 234).

Fire-bricks are moulded in wooden frames, the bottom of the mould being formed by the table on which the frame rests, and the method used is precisely similar to slop moulding (p. 206) as used in some localities for ordinary building bricks.

The fire-bricks or blocks are dried on steam-heated floors in a similar manner to plastic made building bricks, but if the blocks are very large it is necessary to exercise unusual care in drying them. They are burned as described on p. 232.

It is exceedingly difficult to make large numbers of blocks measuring more than 2 ft. × 2 ft. × 2 ft. and above this size the cost (largely due to risk and difficulty in manufacture) soon grows out of proportion to the size of the blocks produced. Large hollow blocks are somewhat easier to produce than solid ones, as they dry more uniformly and regularly and are less subject to cracking.

**Gas retorts** are "built up" around an internal core, which is lifted as the work proceeds. They are built vertically, and great care and skill are needed to join the fresh clay on to the old, as the construction of a single retort occupies several days, and each length of 2 ft. or so must be allowed to stiffen before the next portion can be added.

**Glassmakers' pots** are made similarly to gas retorts and like them require several weeks to dry. The drying cannot be hurried without serious risk of damaging the goods by the internal strains induced by irregular drying, and many precautions have to be taken, particularly during the earlier stages, to secure such large articles being dried uniformly.

Considerable improvements have been made in methods of drying retorts and glass pots during the past few years, but even with these the removal of the water is a slow and anxious process.

**Crucibles** are made from a paste of similar composition to that used for fire-bricks, moulded in either hand-operated moulds or in a press similar to that used for pottery.

For many purposes the addition of carbon (in the form of coke, coal dust, plumbago or graphite) is added to increase the thermal endurance of the crucible and also to prevent undue oxidation of the contents.

The **burning** of fire-clay goods must usually be effected at a much higher temperature than that necessary for common bricks or terra-cotta. Some fire-bricks are burned at as low a temperature as  $1,180^{\circ}$  C., but for all except the lower grades of fire-bricks a higher temperature is desirable. The precise temperature must depend partly on the clay and partly on the purpose for which the goods are to be used, the wisest plan being to heat the goods in the kilns to such a temperature so that they will not contract appreciably when in use.

This means that the manufacturer must usually heat the goods to a higher temperature than that they will experience when used. Unless this is done, the goods will shrink or contract, and this will tend to loosen the bricks if used for a furnace lining or to cause cracks in a glass pot, retort, or other large vessel.

The **kilns** employed for refractory goods are usually single kilns of the horizontal ("Newcastle") or down-draught type (pp. 215-222), as these permit of the very high temperatures being attained with comparative ease.

At the same time, the use of single kilns from which the hot gases escape to the chimney at a temperature of  $1,100^{\circ}$  C. or above are, obviously, far from economical in fuel, and chamber kilns on the continuous principle devised by Hoffman (p. 218) are being increasingly used in the larger works, as they save half or even three-quarters of the fuel required by the single kilns.

**Silica bricks** are made of **ganister** or other convenient form of silica rock or sand; the method of manufacture is, however, quite different from that used in making bricks of fire-clay. The material is crushed to powder (unless it occurs in the form of a sand, as in some parts of Wales), and is then mixed with a small quantity of milk of lime, the quantity added being such as to introduce not more than 2 per cent. additional lime into the bricks. The silica, lime, and water are mixed together in a tempering mill, which resembles a mortar mill, but is more strongly constructed, and by this means a sandy paste is produced. This paste is almost devoid of plasticity, and requires to be handled with some skill by the men engaged in moulding the bricks.

The bricks are moulded by hand, in wooden moulds, or in metal ones, the material by compressing by means of a small plunger operated by a foot-treadle.

Many attempts have been made to utilise mechanical presses in the production of fire-bricks (both of silica and fire-clay), but many such bricks are inferior to those made by hand.<sup>1</sup> The greater pressure exercised by the machine gives the bricks a denser surface, and makes them liable to shell or spall when exposed to varying temperatures. It is highly important that fire-bricks should have as open a texture as the conditions to which they are exposed will permit, and this is almost impossible when mechanical power-driven presses are used. In the case of silica bricks the throwing of the material into the moulds (as practised with fire-clay) is not sufficient to form a consolidated mass, but the pressure given to it must on no account be more than is sufficient to fill the mould uniformly.

---

<sup>1</sup> Mechanically pressed fire-bricks are very accurate and strong, so that they are excellent for purposes, where these properties rather than a superlative degree of refractoriness, are required.

Owing to the absence of plasticity, silica bricks may be dried quite rapidly on steam-heated floors (p. 212), or in a tunnel drier (p. 213), and are then placed in a kiln to be burned. The kilns used for this purpose are the same as those used for fire-clay (p. 232), but a considerably higher temperature is reached, silica bricks seldom being burned at a temperature below 1,400° C., and a temperature of 1,500° C. being generally preferable.

Silica bricks do not contract in use; on the contrary, they expand (owing, it is understood, to the conversion of the silica into tridymite), and it is, therefore, necessary to heat them in the kilns for a sufficient time, and at a sufficiently high temperature to prevent any further appreciable amount of contraction occurring when the bricks are in use. The remarks made on p. 232 with regard to the finishing temperature of fire-clay bricks applies with equal force to those made of silica.

During the burning, the lime added to the silica, together with any lime, magnesia, and "alkalis," present in the material, combine with the silica and form fusible silicates which bind the less fusible particles into a strong mass. If ganister is used, the small proportion of bond it contains (about 10 per cent.) also aids in the binding of the refractory particles, and, in some cases, does away with the necessity of adding milk of lime.

Only certain quartzites can be used for the manufacture of silica bricks: others split up too readily when heated. The physical properties of suitable forms of quartzite are, therefore, more important than the results of a chemical analysis.

**Basic bricks** are made by calcining magnesite to the point of incipient fusion, and mixing it with lightly calcined (or caustic) magnesia, forming it into bricks in a manner similar to that described for silica—but without using any lime—and burning in similar kilns and at a similar temperature. Dolomite bricks are cheaper, but not quite so refractory.

Magnesia bricks are chiefly used in furnaces where the slags are strongly basic, and would rapidly corrode linings made of silica or fire-clay, as in the Thomas & Gilchrist process for steel-making. Bricks made of lime have been tried, but are more difficult to produce, and more costly than those of magnesia; moreover, they are more friable and less able to withstand the treatment to which furnace linings are necessarily subjected.

**Neutral bricks** are sometimes preferred to those which are definitely basic (as magnesite bricks), or acid (as silica or fire-clay bricks). They are usually made of **bauxite**—a crude form of alumina which contains a considerable proportion of iron—or of chrome iron ore (**chromite**). The **chromite bricks** are made in a similar manner to silica bricks, various bonds being used instead of lime, and clay being the most generally successful. **Bauxite bricks** are made in a similar manner, but as the bauxite contains a large proportion of combined water it must be calcined before use. The calcined bauxite is then crushed to a rough powder, mixed with sufficient clay to bind it, and is then made into bricks by hand moulding (p. 206). The dried bricks are afterwards burned in kilns at a temperature dependant on that in the users' furnaces, but seldom below 1,400° C.

Bricks made of zirconia and of magnesium aluminate do not fuse below 2,000° C., but are very costly. Blocks made of coke and tar compressed in moulds, and burned hard in a kiln, are also used for some furnaces. If they could be obtained at a sufficiently cheap rate, bricks of fused pure alumina would be almost ideal, and far superior to the best bricks now made.

There is much difference of opinion as to the relative values of different refractory materials for furnace linings, but the scientific evidence available is exceedingly small. In some instances there is no choice. It is, of course, impossible to use a siliceous or even a fire-clay lining for furnaces employed in the Thomas & Gilchrist process of steel-making—but in many cases where a choice does exist it is almost impossible to say which material is the most suitable for the purpose.

As a general rule, the best fire-clays are more resistant both to heat and to corrosion than are bricks made of silica, but silica bricks are often better than those made of inferior or "second quality" fire-clay. Silica bricks are also more capable of resisting pressure at a high temperature than are some of the close textured fire-clay bricks now on the market, and are therefore better adapted for some metallurgical furnaces. On the other hand, fire-bricks of good quality and suitable texture will not spall or break up so readily as silica bricks when exposed to sudden changes in temperature.

Various attempts have been made to devise standards for fire-bricks of different kinds, but none of these can be regarded as satisfactory, and for the present, at any rate, experience must be regarded as the best guide in the selection of refractory materials.

It should be observed that what is quite suitable for one part of a furnace is not necessarily suited to another, and it is the practice among the better furnace builders to use different kinds of bricks in the various parts of the structure. Thus, the outside of many furnaces may usually be faced with good building bricks, which are more weather-resisting than fire-bricks, and the upper part of the furnace may be built of a cheaper fire-brick than those used for the hearth or the parts which come into intimate contact with the hot metal or slags. In some cases the furnace is lined with dolomite and tar, or with ground ganister, rammed into position like concrete, this giving a more satisfactory result than a fire-brick lining, and one which can be more cheaply renewed or patched.

### Future Progress

At the commencement of the war in 1914, British manufacturers of refractory materials were making slow progress and had only just begun to realise the extraordinary success obtained by the German manufacturers in similar materials. When the German supplies were cut off and the demand for refractory materials was increased very largely, the matter was taken up by the Ministry of Munitions and by numerous committees, with the result that manufacturers determined to act in greater unison than heretofore, and considerable progress was made within the next two years.

In order that this progress may continue it is necessary that the manufacturers should be properly organised and that they should be provided with sufficient capital to enable them to carry out the necessary, yet highly complex, researches. The existence of many small firms with antiquated equipment limits the amount of progress which can be made in this branch of industry.

The matter is fully discussed in a paper, "Refractory Materials and the War," published in the *Journal of the Royal Society of Arts* in 1915, and still more fully in "Refractory Materials, their Manufacture and Use" (see list of books on p. 229)



## SECTION LXXIII

# GLASS

BY ALFRED B. SEARLE

### LITERATURE

- L. APPERT.—“Conférence sur le Verre, son Histoire et ses procédés de Fabrikation.” 1885.
- L. APPERT and J. HENRIVAUX.—“Verres et Verreries.” 1894.
- H. E. BENRATH.—“Die Glasfabrikation.” 1875.
- L. COFFINNALL.—“Verres et Emaux.” 1900.
- F. CREMER.—“Fabrikation der Spiegel.” 1887.
- D. DIAKONOW and W. LERMANTOFF.—“Bearbeitung des Glases.” 1912.
- R. DRALLE.—“Glasfabrikation.” 1911.
- F. E. FISCHER.—“Die Kunst der Glasmasse-Verarbeitung.” 1892.
- P. E. FONTANIEU.—“The Art of making Coloured Crystals to imitate Precious Stones.” (Trans. by W. Drew.) London, 1877.
- GESSNER.—“Glassmaker’s Handbook.” 1897.
- R. DRALLE.—“Anlage und Betrieb der Glasfabriken.” 1886.
- H. HOVESTADT.—“Jena Glass and its Applications.” (Trans. by J. D. and A. Everett.) 1902.
- W. MERTENS.—“Sandstrahl-Gebläse in Dienste der Glasfabrikation.” 1890.
- W. ROSENHAIN.—“Glass Manufacture.” London, 1908.
- Cantor Lectures on “Optical Glass.” London, 1915.
- SCHOTT and ABBE.—“Glasindustrie in Jena.” 1909.
- W. A. SHENSTONE.—“Methods of Glass-blowing.” London, 1897, 1913.
- E. TSCHUSCHNER.—“Handbuch der Glasfabrikation.” 1885. (5th edition.)
- C. WETZEL.—“Herstellung grosser Glaskörper bis zu neuesten Fortschritten.” — “Bearbeitung von Glaskörpern.” 1904.
- W. and D. ASCH.—“The Silicates.” (Trans. by A. B. Searle.) London, 1913.
- J. CALLINGHAM.—“Glass Embossing.” London.
- L. F. DAY.—“Stained Glass.” London, 1909.
- E. DILLON.—“Glass.” London, 1907.
- M. A. GESSERT.—“Treatise on Staining Glass.” London, 1900.
- ANON.—“Recipes for Flint Glass Making.” London.
- E. R. SUFFLING.—“Treatise on the Art of Glass Painting.”
- A. L. GUTHRIE.—“Decorative Glass Processes.” London, 1908.
- P. G. H. BOSWELL.—“Sands Suitable for Glass Making.” London, 1916.

GLASSES are bodies which have been cooled somewhat rapidly from a high temperature at which they existed in the molten state, so that on cooling they remain amorphous in form, and partake of the nature of “solid fluids.”

That is to say they behave in many respects like a fluid though apparently solid. For some purposes it is convenient to regard glasses as fluids of remarkably high viscosity, so that they flow with extreme slowness and in many ways are indistinguishable from solids. The fact must not be overlooked that the glassy state is purely physical, and may have little relationship (if any) to the composition of the glasses, though commercially valuable glasses show striking analogies in composition.

Hence, the term glass is now largely confined to a group of silicates of well-known (ultimate) composition.

Most of the glasses used in commerce are made by fusing silica (sand) with two bases, one of which is usually soda or potash, and the other lime, lead oxide or other oxide of a divalent metal.

Much confusion of thought exists as to the chemical constitution of glasses; by many people they are regarded as mixtures of various silicates, but there is much evidence in favour of regarding them as definite chemical compounds. The chief reason they have not been regarded as definite compounds is the fact that few glasses show a composition in which the various elements are contained in strict stoichiometrical proportions, but even this objection is largely overcome if it is realised that the molecular weight of glasses may be exceedingly high. In the ordinary calculation of formulæ, it is customary in inorganic compounds to reduce the molecular proportions of each element or oxide to the smallest possible numbers, and to round off any fractions so as to facilitate comparison. Thus, analyses of many glasses correspond *roughly* with such simple formulæ as  $\text{Na}_2\text{O} \cdot \text{CaO} \cdot 6\text{SiO}_2$ ,  $\text{K}_2\text{O} \cdot \text{CaO} \cdot 6\text{SiO}_2$ ,  $\text{K}_2\text{O} \cdot \text{PbO} \cdot 6\text{SiO}_2$ , etc., but the variations from these definite formulæ become less if the molecular weight be conceived as considerably greater than those indicated by the formulæ. When the simplest conceivable formulæ are used, the number of silica molecules varies between 2 and 6, and it is frequently difficult to understand why so considerable a difference in the proportion of silica should make so little difference in the properties of the various glasses. If, on the contrary, glasses are conceived as having a much higher molecular weight (as, for instance, by assuming that there are 36 molecules of silica in each molecule of glass) many of the difficulties ordinarily experienced in the study of glasses disappear at once, the unsatisfactory "rounding off" of the variation between the analytical figures and the ones corresponding to whole atoms is less important in its effect on the result, and the general physical properties of the glasses can be more readily predicted. Moreover, such a conception at once removes the glasses from their otherwise anomalous position in the classification of silicates, and facilitates their further study.

Those glasses which correspond in composition to definite chemical compounds are known technically as **normal glasses**, but it was for a long time thought that no truly normal glasses could exist, but that they would rapidly crystallise (*i.e.*, devitrify), and lose their characteristic properties. Later investigations, including those by Hovestadt, Zulkowski, and Fischer, have shown that many truly normal glasses can be prepared, if only the molecular weight is sufficiently high, and that these normal glasses have numerous advantages over those of merely approximately normal composition. Numerous normal glasses of the following compositions have been prepared, and have proved quite permanent and satisfactory:—

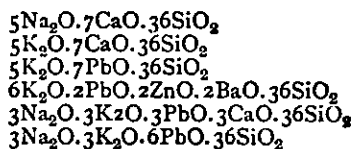

It is important to observe that Benrath, so long ago as 1875, showed that most useful glasses (other than optical ones) are included between the limits—

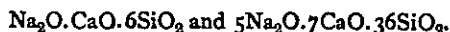

It is a matter of general experience that the simpler the composition and the smaller the number of atoms in the molecule, the more readily will the substance crystallise. This is equally true of the silicates, and is a further proof that the number of atoms in each molecule of glass must be much larger than is commonly supposed by those who represent the composition of glasses by the smallest possible number of atoms.<sup>1</sup>

One of the most fruitful theories yet proposed in relation to the chemical constitution of glasses is that of W. and D. Asch, who suggest that glasses are complex silicic acids or the corresponding

<sup>1</sup> As substances of low molecular weight crystallise readily whilst those of high molecular weight are difficult to obtain in a crystalline form, it is obvious that the properties desired in glasses will be obtained much more completely in a compound of very high molecular weight than in one of simple constitution. This is particularly the case with the defect known as "devitrification," in which a simplification of structure occurs and crystals are produced.

salts with 32, 36 or more silicon atoms in the molecule. For the primary acid with 36 silicon atoms in the molecule they suggest the formula—

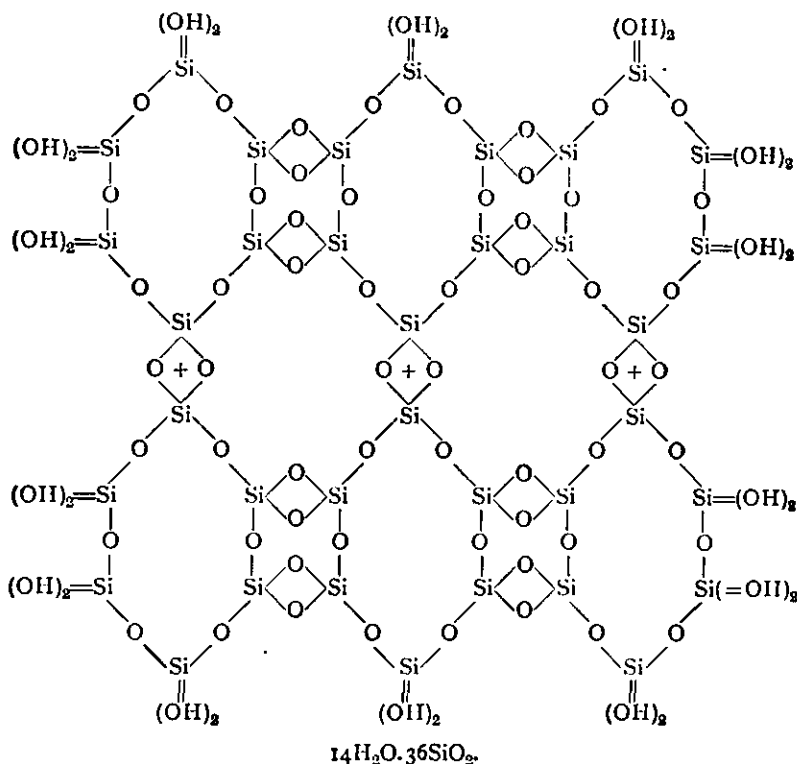

In this formula the positions marked with a + are either direct bonds between the silicon rings<sup>1</sup> or are those to which dibasic and sesquioxide-forming elements may be attached. In this formula the maximum number of OH groups is shown, but a series of acids with fewer OH groups is also theoretically possible, and the H atoms in the OH groups can be replaced either in part or completely by sodium, potassium, calcium, magnesium, and various other metals. As these replacements occur exclusively outside the hexite rings formed by the silicon atoms, the formula may be simplified and its possibilities studied more readily by representing each  $\text{Si}_6\text{O}_6$  group

by the symbol  $\left[ \text{Si} \right]$ , which reduces the formula to—

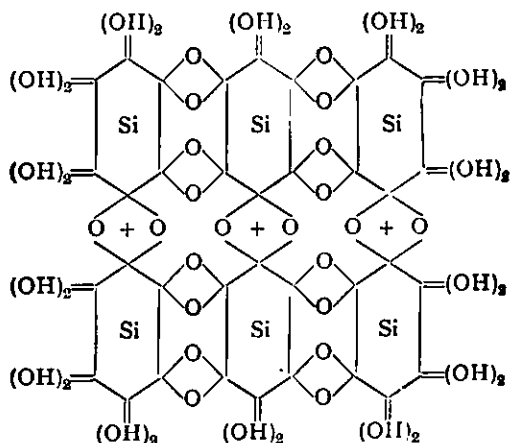

<sup>1</sup> There cannot be direct bonds between silicon atoms, as G. Martin, *Trans. Chem. Soc.*, 1915, 107, 1044; *Chem. News*, 1915, 112, 61, has shown that such unions are destroyed with evolution of hydrogen when substances containing them are treated with caustic potash, and glasses do not

This may be still further simplified by omitting the hydroxyl groups but leaving the "bonds," and representing the complex group  $\text{Si}_{36}\text{O}_{88}$  (which includes all the hexite rings and the connecting oxygen atoms) by

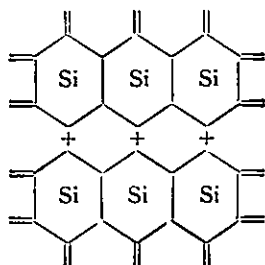

which, if fully hydrated, corresponds to the formula  $14\text{H}_2\text{O}.36\text{SiO}_2$ .

Using this diagram, the formula of a typical soda-lime glass is represented by

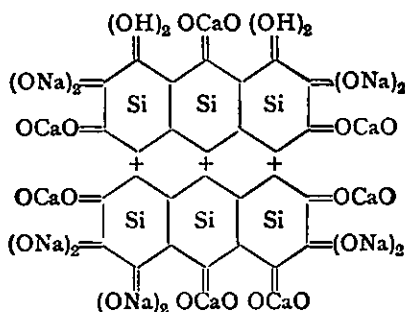

which corresponds to

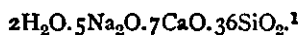

It is clear that many isomers of this substance are theoretically possible, and the precise arrangement of the various calcium, sodium, and hydrogen atoms must determine the properties of the glass, these properties being deducible from such formulæ, and confirmed by those actually found in the glass itself. For instance, it is clear that in the above formula some of the calcium atoms must behave differently from the others, and the same remark applies to the sodium atoms.

These formulæ also show why a good glass cannot consist of sodium and potassium as the sole metals, and that a monovalent and a divalent metal are both necessary.

Some of the silica rings can also be replaced by analogous ones of boracic, phosphoric, stannic, and other acids and their anhydrides, and various silica groups can be replaced by the anhydrides of stannic, titanic, zirconic and analogous acids. In this way a number of glasses of special properties may be produced, many of them being particularly valuable for optical purposes.

A considerable amount of further research is necessary before the precise positions of some of the various metallic atoms can be settled. This research must necessarily follow in directions analogous to those used with such conspicuous success in the study of the constitution of the benzene derivatives and other aromatic carbon compounds.

The positions marked with a + in the foregoing formulæ are highly important inasmuch as acid groups and metallic oxides (either in the ous or ic form) can enter the molecule there with remarkable effects on the properties of the glass, particularly as regards its colour and the action of light upon it. These positions are, in fact, the ones to which coloured glasses owe their special properties (see p. 268).

behave in this manner. Geoffrey Martin has shown experimentally that precipitated silica, when dehydrated, has a cyclic formula corresponding to—

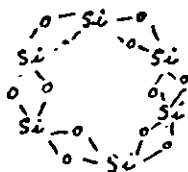

<sup>1</sup>The action of heat during the clarification of the glass may cause the separation of the  $\text{H}_2\text{O}$  groups here shown; the bonds thus set free unite with and satisfy each other, leaving the formula  $5\text{Na}_2\text{O}.7\text{CaO}.36\text{SiO}_2$ .

If alumina is introduced into a glass mixture, it will usually occupy the positions marked with a +, as in the formulæ:—

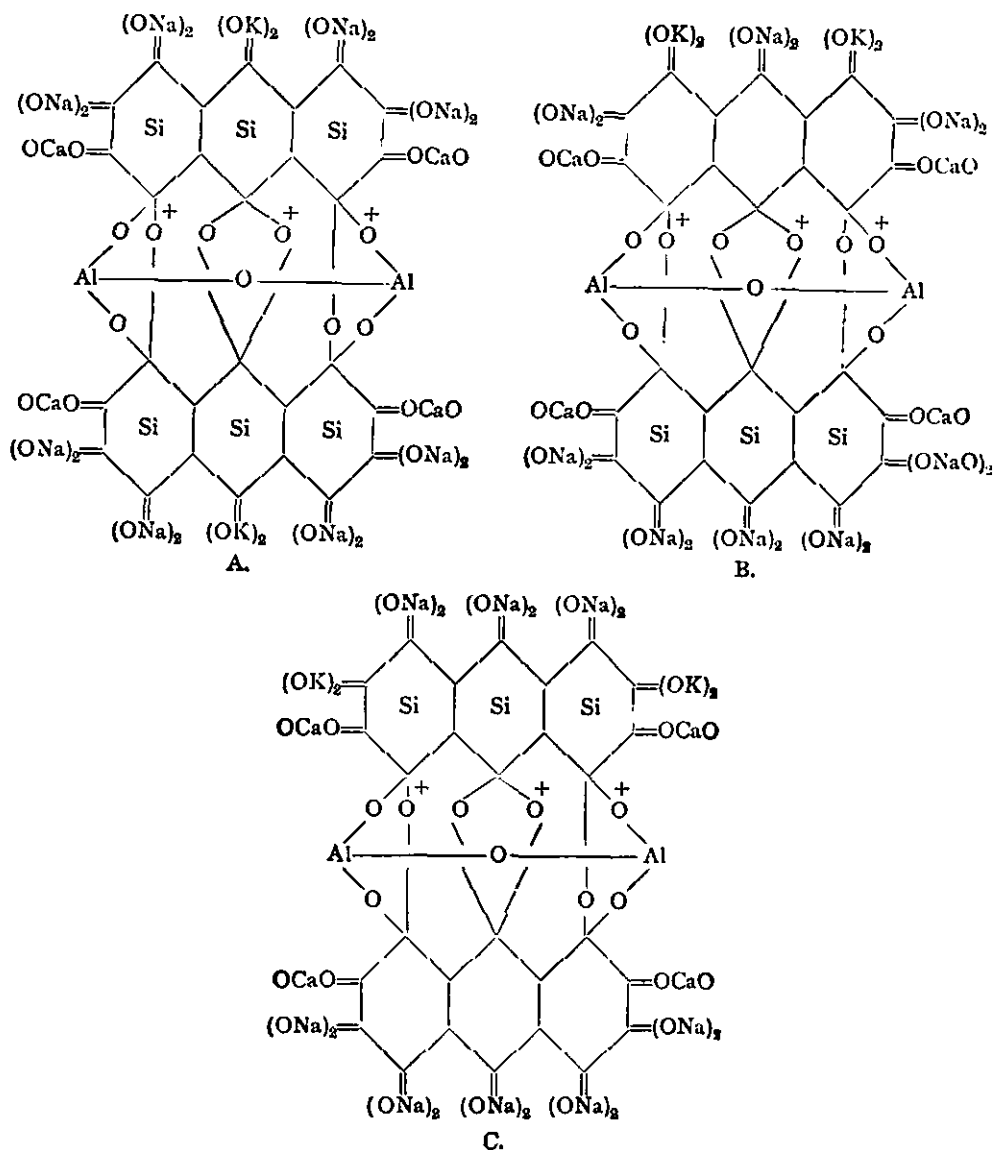

These are isomeric variations of the formula corresponding to the composition of "Best Thuringian Glass," the three foregoing formulæ being considered by W. and D. Asch to show the three isomers formed by Schott by keeping "Best Thuringian Glass" for two years, by heating it to 100° C. and by heating it to the softening point and re-annealing it. It is probable that on heating to the softening point, the compound A is formed, as the symmetrical distribution of the metallic atoms in it would account for its better quality and greater stability than compounds B and C.

It is here assumed that on storing or heating, the alkali groups alone change places and that the dibasic and alumina ones are more strongly bound. That there is some truth in this assumption is shown by the researches on the depression point of thermometers made of various glasses by Schott and others, indicating a change in the nature of the glass when stored or repeatedly heated and cooled. In particular, Schott found that glasses containing potassium but no sodium showed little or no depression, and the absence of depression in glasses which contain sodium but no potassium. According to the formulæ given above, such glasses do not permit the alkali groups to replace each other, as would be possible if both sodium and potassium atoms were present, and the changes in the nature of the glass are thereby prevented.

The effect of alumina on glass has been shown by Schott to increase the facility with which the

glass can be worked in the blowpipe. Seger also studied the effect of alumina very thoroughly and found that it increases the fusibility, makes the glass easier to work, and greatly reduces the tendency to devitrify or crystallise. Many manufacturers have also found that the presence of a small proportion of alumina greatly improves the working power of the glass. It has hitherto been difficult to explain satisfactorily how so small a proportion of alumina (seldom more than 3 or 4 per cent.) could make so much difference. Various theories of catalytic action, etc., have been proposed, but the position of the two aluminium atoms in the foregoing formulæ explain the effect of the alumina on the glass far more simply and satisfactorily than any previously published theories: it binds the silicon rings together in a firmer manner than when no alumina or corresponding sesquioxide is present.

The use of these formulæ also explains the curiously anomalous behaviour of alumina in glass. All the earlier writers on glass manufacture protested strongly against the use of alumina as making glass more difficult to fuse and increasing its tendency to devitrification. Later writers have expressed a different opinion, and Schott's experiments have shown that some alumina in a glass greatly increases its working properties and gives it special facilities for being worked in a blowpipe. The fact is that if the alumina present is sufficient to occupy the positions marked with a + in the foregoing formulæ, the presence of it will be advantageous, but if it is otherwise combined it will facilitate the formation of alumino-silicates, and these are of an entirely different character to glass and have a much stronger power of crystallisation, as well as a higher fusing point. With very small proportions of alumina the + positions are occupied by this oxide, but with larger proportions other substances of an undesirable character are formed. The maximum proportion of alumina permissible can be calculated from the formula of the glass; experimentally, it is found to be less than 10 per cent. of the weight of the sand used.

These formulæ also explain why glasses containing a small proportion of alumina are less attacked by chemical reagents than are alumina-free glasses. The form in which the alumina is added to the glass-mix is important; clays are unsuitable, the best form being felspar or sands containing felspathic matter. Pure alumina may also be used, if desired, but is more costly.

The well-known fact that glass is attacked by pure water more strongly than by acids, and more by weak acids than by strong ones, may be explained by the use of the foregoing formulæ. It is probable that water alone causes primary alkali to be separated from the molecule, and this free alkali then reacts on the molecule and removes some of the silica, forming one or more five-atom rings or pentites, this reaction having been frequently observed by W. and D. Asch in other complex silicates. With strong acids, on the contrary, the alkali is immediately neutralised, and the secondary action is prevented.

The cause of the devitrification or crystallisation of glasses has long been a subject of investigation and theorising, but without much satisfaction. Gröger examined the devitrified glasses produced at a large Austrian works very thoroughly and found that the chemical composition of the amorphous and crystalline portions were identical. Other investigators have also proved experimentally that the theory, which was at one time very popular, that the crystalline portion was more siliceous than the original glass, is untenable, and that no change in composition (as represented by analysis) occurs on devitrification. At the same time the physical properties of the two portions differ greatly; the crystalline portion is less fusible and more soluble in acid than the original glass. The use of the foregoing or analogous formulæ enables the cause of devitrification to be explained in accordance with all the experimental evidence available, as the formation of a stable compound from an unstable one by the loss of a simple constituent, such as wollastonite (calcium silicate) and not as a mere rearrangement of the atoms within the molecule as suggested by Pelouze and others.

That an almost endless series of glasses of similar composition may exist is shown by the enormous number of possible isomers deducible from the formulæ previously given. The series may be further increased by the replacement of one or more of the silicon rings by a similar ring composed of boron atoms or by the existence of rings containing only five instead of six silicon or boron atoms.

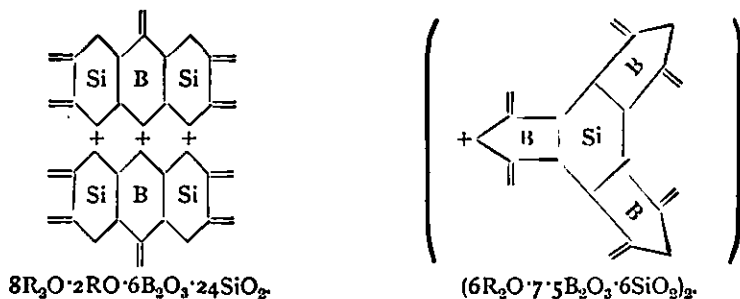

In addition to this, the fact that the materials used in the manufacture of glass are seldom quite pure, and therefore introduce other elements into the glass, still further complicates the composition of the material finally produced, and lends much colour to the belief generally held that glasses are mixtures and not definite chemical compounds. A thorough study of the whole of the available experimental evidence appears to indicate that most, if not all, glasses consist essentially of definite compounds of considerable complexity, and that the influence of the so-called impurities in the raw materials is only to increase the complexity of the ultimate compound so far as they are not removed

during the manufacture of the glass or separate from it on prolonged storage, simultaneously causing devitrification. At the same time, the manner in which many commercial glasses are made, and the imperfect way in which most of the published analyses have been carried out, render it exceedingly difficult to calculate the precise formulæ to which the glasses really correspond. The impossibility, at present, of separating the chief substance of definite chemical composition from the others present in an ordinary glass of good quality still further increases the difficulty of deciding how far glasses are definite chemical compounds with other substances included in them in small proportions and how far they are complex mixtures of simple silicates. This has led to glasses being regarded as mixtures or "solid solutions."

The ordinary "mixture" or "solid solution" theory is based on three chief arguments:—  
 (1) That mixtures of definite silicates melt below the mean melting point of the several silicates used, and sometimes below the melting point of any one of them. In reality, however, a lower melting point may equally well indicate the formation of a fresh compound. (2) The separation from a siliceous melt of various crystals at different temperatures. Doelter has, however, expressly warned investigators against the fallacy of applying this method to silicates, as the prolonged action of heat necessary to secure the requisite quantity of crystals effects serious changes in the constitution of the material, and permits reactions to proceed which are unrecognised unless specially sought. Besides, the formation of crystals at a certain temperature is, of itself, no guarantee that the compound forming the crystals was actually present in the fused mass; it was more probably produced by secondary reactions during the time required for the material to reach the given temperature. (3) The electrical conductivity of a glass decreases uniformly with the temperature, there being no break between the fluid and solid state as is the case when crystals are formed. This fact merely shows, however, that no separation of crystals occurs under the conditions of the experiment, and cannot be regarded as showing the absence of a definite compound as the preponderating constituent of the glass.

Recent investigations have shown that when glass is warmed to 300° C. and subjected to a current of electricity, it becomes electrolytically dissociated into its respective electrons. Glass is so poor a conductor that the amount of dissociation is very small, though it is quite perceptible when mercury electrodes are used, sodium amalgam being formed at the cathode. The composition of the anode-ions has not been ascertained; but it has been proved that no gas is evolved at the anode, so that the most probable result of the electrodes is merely to remove some of the sodium leaving a more refractory glass. On heating the electrolysed glass *in vacuo* to its softening point it becomes turbid and an evolution of oxygen occurs equivalent to about one molecule of gas to three molecules of sodium at the cathode. If glasses are solid solutions a far larger proportion of oxygen should be evolved.

When a glass is heated, it passes through all degrees of viscosity until it becomes quite mobile, there being no sharply defined temperature at which it changes definitely from solid to liquid. Even at temperatures at which they appear to be solid, glasses are deformed gradually under severe stresses, though under a sudden stress they act as brittle solids. Parker and Dalliday have found that the rate of deformation under constant stress is an exponential function of the temperature, the equation representing it containing an expression which varies with the composition of the glass. This absence of a well-defined melting point merely indicates that the constituents of glass have been under-cooled; it does not necessarily show that glass contains more than one essential constituent as the supporters of the "mixture" theory suggest. Phenol and many fused organic compounds of known constitution behave like glass if cooled too rapidly for crystallisation to occur, or in the presence of small proportions of impurity, yet it is never suggested that such compounds are "mixtures" or "solid solutions."

If the whole of the evidence is examined impartially, it will be seen that the "mixture" or "solid solution" theories only explain a very small proportion of the facts observed with regard to the constitution of glasses, and that they hinder rather than help the further progress of investigation of these substances. The theory that they consist essentially of definite chemical compounds, usually with an indefinite proportion of impurities and possibly of secondary compounds, on the contrary, permits a number of prognoses to be made which are fulfilled by the results of experiments based upon them, and this theory also enables a considerable number of the properties of various glasses to be explained in a more satisfactory manner than hitherto. It is not claimed that *all* commercial glasses are completely composed of a single compound in each case, though such a statement applies to most of the better qualities of the glasses now in use. In comparing the analyses of glasses with the theoretically possible formulæ deducible from them, it is important to bear in mind the extreme complexity of the compounds known as glasses, and the influence of included impurities in many of the lower grades. This fact, coupled with the enormous number of possible compounds of similar but not identical composition, has been the chief difficulty in the way of recognising the definite nature of glasses as distinct chemical compounds, and has given rise to the erroneous, but generally held, view that they are mixtures of various simpler compounds.

The following are the average analyses of a number of typical glasses:—

	SiO <sub>2</sub>	B <sub>2</sub> O <sub>3</sub>	Na <sub>2</sub> O	K <sub>2</sub> O	CaO	MgO	BaO	PbO	ZnO	MnO	Al <sub>2</sub> O <sub>3</sub>	Fe <sub>2</sub> O <sub>3</sub>	As <sub>2</sub> O <sub>3</sub>	P <sub>2</sub> O <sub>5</sub>
Best table glass - - - -	70.70	...	10.02	8.62	10.02	...	...	...	...	...	0.43	0.21	...	...
St Gobin glass - - - -	77.15	...	15.38	...	7.47	...	...	...	...	...	...	...	...	...
Venetian glass - - - -	73.40	...	18.58	...	5.06	...	...	...	...	...	2.50	0.46	...	...
English sheet glass - - - -	72.42	...	13.13	...	11.97	...	...	...	...	...	2.13	0.35	...	...
Best plate glass - - - -	71.80	...	11.10	...	15.70	...	...	...	...	...	1.26	0.14	...	...
Pressed glass - - - -	70.68	...	19.08	...	5.45	...	4.17	...	...	...	0.33	0.24	...	...
Bohemian glass - - - -	71.70	...	2.51	12.74	10.32	...	...	...	...	...	0.22	0.51	...	...
Ordinary flint glass - - - -	53.17	...	...	...	13.88	...	...	32.95	...	...	...	...	...	...
Champagne bottle glass (A) - - -	58.40	...	9.90	1.80	18.60	...	...	...	...	...	2.10	8.90	...	...
Champagne bottle glass (B) - - -	56.68	...	9.40	1.13	19.87	6.42	...	...	...	...	4.67	1.93	...	...
Common bottle glass - - - -	63.51	...	9.50	...	14.32	3.87	...	...	...	2.90	2.54	2.36	...	...
Jena laboratory glass - - - -	65.30	15.06	...	...	...	...	12.23	...	...	...	3.80	0.41	3.20	...
Jena thermometer glass - - - -	67.50	2.00	14.00	...	...	7.00	...	...	7.00	...	2.50	0.50	...	...
Jena boro-flint (S 57) - - - -	...	58.00	...	...	...	...	...	32.00	...	...	10.00	...	...	...
Jena phosphate crown (S 40) - - -	...	3.00	...	...	...	28.00	...	...	...	...	8.00	...	1.50	59.50
Good Thuringian glass - - - -	67.74	...	16.01	3.38	7.38	0.27	...	...	...	...	3.38	...	...	...
Bad Thuringian glass - - - -	69.90	...	16.50	6.60	3.80	0.10	...	...	...	0.40	2.40	0.60	...	...



At first sight these analyses do not appear to indicate very definite compounds, but a careful calculation of the formulæ will show that (allowing for included impurities) the majority of them correspond fairly closely with one of the following formulæ:—

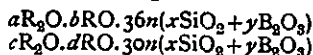

(where  $n$  indicates unity or any multiple of the numbers 30 or 36 respectively).

It is interesting to compare these analyses with the formulæ given on pp. 237-239. It is also well to bear in mind that the presence of a small proportion of impurity will often prevent a substance from crystallising; this well-known fact is largely used in glass manufacture, and the strict adherence to the proportions of raw materials likely to produce glass of completely "normal" composition is, therefore, avoided by many glass-makers. This does not alter the fact that glasses are definite chemical compounds, though it does make a study of glass analyses more difficult than would otherwise be the case.

From the formulæ shown above and on previous pages it follows that the proportions of the various ingredients used in the manufacture of glasses must be confined within somewhat definite limits, and experience has shown this to be the case. Thus glasses containing more than 80 per cent. of silica are of no commercial value, as they are very difficult to fuse and devitrify readily; the successful production of articles from a fused mass of almost pure silica suggests, however, that a more extended research on these highly siliceous glasses will show that the devitrification is largely due to the use of an excess of metallic oxide rather than the impossibility of producing glasses with more than the percentage of silica just mentioned. That certain proportions of metallic oxide and silica will produce an unstable glass which readily devitrifies into a stable crystalline compound and a stable amorphous glass is readily prognosticated from the formulæ mentioned, but this can occur with any proportion of silica and is not confined to those glasses in which the proportion of silica is unusually high. Experience has shown that the composition of the mixtures used for glass-making must be accurate within narrow limits, though the results of analyses of the finished glass do not correspond to the proportions of the raw materials used, it being almost impossible to make due allowance for the removal of scum, the action of the glass on the pots or furnace and the losses which occur through volatilisation. This last will usually amount to about 6 per cent. of the alkali used, apart from the more readily recognised volatile constituents.

It is now generally admitted that the following molecular ratios express the limits between which most commercially useful glasses fall:—

	Alkali ( $R_2O$ ).	Lime, Lead, etc. ( $RO$ ).	Silica ( $SiO_2$ ).
White glass for table ware -	5.9	6	30-60
Bohemian crystal glass - -	Under 12	6	30-90
Plate glass - - - -	4.6	6	24-36
Flint glass - - - -	2.6	6	20-36
Bottle glass - - - -		(Limits very variable. <sup>1</sup> )	

The **properties** of glasses are greatly influenced by the treatment they receive during various stages of manufacture and in the subsequent storage. If cooled too rapidly, glass becomes brittle and liable to fall to powder of its own accord on account of the internal strains to which it is subject.

This is well shown by the behaviour of **Rupert's drops** which consist of drops of glass which are cooled very rapidly by allowing the molten glass to drop slowly into water. The interior of the mass is in a state of intense strain owing to its dilation having been prevented by the more rapidly cooled outer layer. Hence the breaking off of even a minute portion of the drop will cause the remainder of the material to fall to powder with almost explosive violence.

<sup>1</sup> The recognised limits for champagne bottles (see p. 242) correspond to 0.6 $R_2O$ , 12-18 $RO$ , 1-6 $R_2O_3$ , 36 $SiO_2$ . Glass for common bottles is not so rich in lime, and the usual limits for it correspond to c.6 $R_2O$ , 6-18 $RO$ , 1-3 $R_2O_3$ , 36 $SiO_2$ .

Some glasses crystallise when cooled very rapidly. If, on the contrary, glass is cooled too slowly it may devitrify.

This is particularly noticeable if the glass is maintained for a long time at a temperature just below its softening point; it will then crystallise out in small needles which will be found under the microscope to consist largely, if not entirely, of wollastonite<sup>1</sup> ( $\text{CaSiO}_3$ ), the residual glass having a composition dependent on that of the original mixture and on the duration and temperature of the heating of the glass. A refusion of the mixture, followed by a normal annealing, will usually effect the reformation of the original glass (see p. 240 and "ambitty" below).

Hot glass is so **viscous** that it may be rolled like dough; it may be blown into hollow vessels by the pressure of the human breath or by mechanically compressed air; it may be moulded into various shapes by placing it in an iron mould and blowing into the glassy mass so that it expands and occupies the whole of the mould (this operation of shaping by means of moulds is technically known as pressing; it may be effected by means of a plunger where solid articles are desired). Hot glass is also so ductile that it can be drawn out into extremely fine threads of a beautiful silky lustre and capable of being woven into a fabric. These extremely fine filaments are known as **spun glass**. If the mass of glass is hollow before being drawn, tubes or pipes will be produced; these are used for a variety of purposes, particularly in chemical laboratories.

The working power of glass depends on its tendency to crystallise, its viscosity, temperature curve, and its surface tension. The most satisfactory glasses remain pasty over a long range of temperature, lead-glasses being superior to lime-glasses in this respect.

According to Asch's theory the working power of glass is dependent on the groups occupying the positions marked with a + sign in the formulæ already given. It also depends to some extent on the number of the silica groups in the molecule. Thus a well-known English crystal glass corresponds very closely to the formula  $12.5\text{K}_2\text{O} \cdot 12.5\text{PbO} \cdot \text{Al}_2\text{O}_3 \cdot (36\text{SiO}_2)_2$ , and a Rhenish crystal glass of even greater popularity corresponds to  $20\text{K}_2\text{O} \cdot 22\text{PbO} \cdot \text{Al}_2\text{O}_3 \cdot (36\text{SiO}_2)_4$ . Both these glasses are noted for their remarkable working powers as compared with the normal crystal glass ( $6\text{K}_2\text{O} \cdot 6\text{PbO} \cdot 36\text{SiO}_2$ ), and it appears highly probable that their superiority is due to the greater complexity of their molecular construction as well as to the alumina occupying the peculiar position it does. The well-known properties of lead, barium, and certain other divalent metals of high molecular weight, in increasing the refractive index of glasses containing them, and the greatly admired metallic "ring," are apparently due to the complexity of the molecule of the glass which these elements are able to produce.

**Homogeneity** is an essential characteristic of all good glass. It is exceedingly difficult to secure, particularly in furnaces arranged to give a continuous supply of glass, though much may be done by carefully adjusting the sizes of the melting pots or tanks and by heating the glass to a sufficiently high temperature.

A prominent characteristic of glass is its **transparency**, though this differs greatly with different specimens, some being purposely rendered opaque by the addition of infusible matter, whilst others are opaque to certain rays of light. Most ordinary glass is opaque to ultra-violet and infra-red rays; especially if it is rich in lead. Other glasses are now made which are transparent to particular parts of the spectrum, and to X and other definite rays. It is well known that the transparency or opacity of such glasses depends upon their composition. The optical properties of glass are largely due to its transparency, but are more conveniently considered separately (p. 263).

The effect of prolonged heating on glass is to tend to make certain compounds crystallise out. This fact is used technically in the production of a semi-opaque glass known as **ambitty**, which consists of ordinary glass permeated with micro-crystalline matter in such a manner as to deprive the mass of its normal transparency, and to render it semi-opaque.

The **density** or specific gravity of glass varies with the molecular weight of the constituents, and ranges from 2.25 for the lightest borate glasses to 6.5 for the specially dense lead-barium glasses. Ordinary glass has a specific gravity of 2.45 to 3.00, and does not vary appreciably with the composition, so long as lead and barium are not among its constituents.

<sup>1</sup> The suggestion that this simple silicate is present in the molten glass is not well founded. It is most probably formed by the prolonged heating at a moderate temperature.

On heating, the specific gravity is reduced, but the **expansion** of glass is very irregular and varies greatly with different types of glasses.

For soda-lime glasses the mean coefficient of expansion lies between 0.000023 and 0.000027 per 1° C. The expansion of glass becomes important in the manufacture of thermometers and some other scientific apparatus, and also in the manufacture of lenses and other articles in which two different glasses are fused together. It is even more important in the manufacture of flashed window glass, enamelled glass, and in those cases (*e.g.*, electric lamps) where metal is fastened to glass. Various methods of reducing the irregularity of expansion are now used in the manufacture of scientific apparatus, but a description of these is beyond the scope of the present article.

Glass of low expansion is very viscous, and if boric oxide is used to overcome this, it tends to make the glass soluble in water.

The **strength** of glass has seldom been tested, and the published figures relate exclusively to special and little known glasses. The brittleness of the material, and the changes induced by prolonged pressure, make any figures misleading.

The **thermal endurance**, or resistance to sudden changes of temperature or to prolonged heating, possessed by glasses appears to depend partly on their composition and partly on the treatment they have received.

Readily fusible glasses are the most sensitive, and the nearer a glass approaches the composition of pure silica the more readily will it endure thermal treatment. In this respect, glasses resemble the more refractory clays and siliceous rocks, though the endurance of the latter is much greater than that of glass.

The mean specific heat of glass is 0.177 from 0°-100° C., and 0.190 from 0°-300° C.

Glass is a particularly bad conductor of heat, and therefore requires a considerable time for it to become heated uniformly. This is one cause of its cracking: it is so difficult to secure a uniform distribution of the heat unless the glass is exceedingly thin.

The **melting point** of glasses varies with their composition, but their conductivity is so low that it is difficult to obtain a sharp melting point, and this difficulty is increased by the presence of impurities and by the atomic changes glasses undergo on prolonged heating at a temperature near to their melting point.

For most commercial purposes, glasses must melt between 1,300° and 1,500° C., but they must remain pasty or viscous at temperatures far below this in order that they may be worked conveniently into the articles it is desired to produce. Where cheapness is the chief consideration, a readily fusible glass is preferred, but such glasses lack the permanency of those of a more refractory character, and tend to devitrify and to be unduly corroded by water and other fluids. The most infusible glass<sup>1</sup> is pure silica which can only be fused in the oxy-hydrogen blowpipe flame, or in an electric furnace at a temperature of 1,800°-2,000° C., though it becomes soft and viscous at 1,600° C.

Glasses which contain both soda and potash are more readily fusible than those which contain only one of these oxides.

The **hardness** of glass depends partly on its composition and partly on the rate at which it has been cooled. Generally speaking, the higher the proportion of silica, lime, and alumina the harder will be the glass, but glasses rich in lead and soda or potash are frequently soft. Curiously enough, the soda glasses are usually harder than the potash ones. All glasses which have been cooled rapidly are covered with a film of harder material than the interior, but this is accompanied by such severe strains in the glass as to make the latter almost useless.

These strains may be avoided, as suggested by Schott, who surrounds the glass with another of less expansibility, so that both the exterior and the interior glasses are hardened. Another method, much in use at present, consists in placing the glass between two metal plates, so as to secure a rapid and uniform loss of heat from every part of the surface and to prevent the edges cooling first. Copper sheets give the hardest glass, iron sheets being inferior for this purpose.

In 1874 M. de la Bastie published a method of hardening glass which has not, however, become

---

<sup>1</sup> Some authorities object to fused quartz being regarded as a glass, and it is therefore treated separately on p. 270.

popular. It consisted in immersing the hot glass in oil at a temperature of 300° C., and then allowing it to cool very slowly to the ordinary temperature. Such glass can be dropped without breaking and is capable of standing very sudden changes in temperature. Its weakness lies in its unreliability, for if the smallest particle of glass is removed from the surface, as by a minute scratch, the internal forces in the glass are set free and it falls to pieces with explosive violence (*cf.* Rupert's drops, p. 243). Such glass cannot be cut or ground.

**Brittleness** is a defect in many glasses; it can only be avoided by cooling them extremely slowly, *i.e.*, by very skilful and careful annealing.

If the cooling is too slow, however, the glass will be liable to devitrify (p. 240).

**The Chemical Properties of Glass.**—A most important feature of the technically valuable glasses is their inertness and resistance to chemical action. At the same time, no glass is completely resistant, the actual decomposition taking place depending on the reagent to which the glass is exposed, the composition of the glass, and whether it is in a state of powder or a polished surface is alone exposed.

In this connection, some very unexpected results may be obtained; thus, as previously mentioned, glass is more resistant to strong acids than to weak ones, and more resistant to weak acids than to water (p. 240). Glasses with a large proportion of soda or potash (some authorities say 15 per cent.) are unsuitable for chemical purposes on account of the ease with which they are attacked. Many excellent optical glasses suffer somewhat from the ease with which they are decomposed by moisture condensing on them. Boro-silicate crown glasses are the most resistant to chemical action, and are therefore of special value for laboratory ware. Superheated water has a powerful action on all glasses, decomposing most of them to such an extent that all the contained alkali is removed, and leaves a calcium or lead hydro-silicate. It is difficult to understand the behaviour of superheated water if the ordinary theory that glass is a mixture of simple silicates is maintained. If, on the other hand, glasses are ring compounds similar to those for which formulæ are given on p. 238, the action of water is readily explained. The sodium and potassium groups are replaced by hydroxyl ones, but the calcium groups, being more firmly bound to the molecule, are not attacked.

**Strong acids** have little or no appreciable action on most glasses, though some optical and other glasses rich in alkali are readily attacked. The only exception to this is hydrofluoric acid, which unites with the silica to form a volatile silicon fluoride, and brings about a complete decomposition of any glass. Highly basic glasses are less attacked by dilute acids than glasses richer in silica; this is only true, however, if the basicity of the glass is due to oxides of the RO type, and not to those of the R<sub>2</sub>O group.

**Alkaline solutions** attack some glasses more energetically than water or acids, as they displace some of the weaker bases, and break up the glass molecule into simpler silicates.

**Atmospheric influences** have an important effect on window and other glasses unless special care is taken to produce a sufficiently resistant material. The most potent factor is the action of condensed moisture on the glass, but the use of soaps containing alkali for cleaning the glass is also important in effecting its deterioration.

The precise influence of the atmosphere on a given glass is very difficult to determine. It is usually tested, as suggested by Mylius,<sup>1</sup> by exposing a carefully cleaned sample of the glass to the action of water for a definite period, and then treating it with an ethereal solution of iodo-eosin. The intensity of the red deposit produced by the alkali set free is dissolved in water, and the colour of the solution is compared with that produced by the use of known quantities of alkali. Another method consists in determining the loss of weight suffered by the glass when treated with water or with N/1 acid, and affords another indirect means of determining the resistance of the glass. Mylius and Förster found that 20 g. of glass powder, from which the finest particles had been removed, when boiled with 70 c.c. water for five hours lost the following weights:—

---

<sup>1</sup> *Zeits. f. anorg. Chemie*, 1910, 67, 200.

6Na <sub>2</sub> O.6CaO.36SiO <sub>2</sub>	-	-	-	-	-	-	-	7.4 mg.
9Na <sub>2</sub> O.3CaO.36SiO <sub>2</sub>	:	:	:	:	:	:	:	42.4 "
10.5Na <sub>2</sub> O.1.5CaO.36SiO <sub>2</sub>	:	:	:	:	:	:	:	507.6 "
6Na <sub>2</sub> O.6CaO.30SiO <sub>2</sub> (Rhenish window glass)	-	-	-	-	-	-	-	8.4 "
5Na <sub>2</sub> O.0.5K <sub>2</sub> O.8CaO.3.5MgO.34SiO <sub>2</sub> (green window glass)	-	-	-	-	-	-	-	6.5 "
0.5Na <sub>2</sub> O.3.5K <sub>2</sub> O.3CaO.34SiO <sub>2</sub> (Bohemian chevalier glass)	-	-	-	-	-	-	-	10.1 "
4Na <sub>2</sub> O.K <sub>2</sub> O.CaO.34SiO <sub>2</sub> (defective Thuringian glass)	-	-	-	-	-	-	-	91.4 "
6K <sub>2</sub> O.6PbO.36SiO <sub>2</sub> (lead glass from Ehrenfeld)	-	-	-	-	-	-	-	8.5 "
7Na <sub>2</sub> O.4CaO.3ZnO.36(SiO <sub>2</sub> +B <sub>2</sub> O <sub>3</sub> ) (Jena thermometer glass)	-	-	-	-	-	-	-	6.4 "

## THE RAW MATERIALS USED FOR GLASS-MAKING

As will have been understood from the foregoing remarks on the composition and general properties of glasses, the raw materials are essentially of two kinds: (a) substances of an acid nature such as silica and boric acid, and (b) substances of an alkaline or basic nature such as soda, potash, lime, magnesia, baryta, zinc oxide, lead oxide, etc. Some glasses also contain other materials, the behaviour of which it is less easy to define, such as alumina and oxide of iron, both of which attach themselves to the glass molecule, but in a different position to those occupied by the substances previously mentioned (see the formulæ on p. 238). Various decolorising and opacifying agents are also added when desired.

Glasses are essentially salts of complex silicic acids, the combination of the acid and base occurring only at a temperature of 1,300° C. or above. At this temperature, however, many other acids combined with such alkalis and bases as soda and lime are decomposed, so that it is possible, in the manufacture of glass, to use the cheaper salts of the alkalis and bases rather than the bases themselves. Thus chalk or limestone are both decomposed at a temperature of about 700° C. into free lime, and as chalk and limestone are much cheaper than quicklime they are used by the glass-maker as a source of the latter material. This fact must be borne in mind in considering the raw materials employed.

**Silica** is used in the form of sand, the purest available sands being used for the better qualities of glass, and somewhat less purer sands for the cheaper bottle glasses.

The purest English sands are obtained from Lancashire, Bedfordshire and King's Lynn; the cheaper sands may be used from the locality in which the works are situated. The French glass-makers use Fontainebleau sand, which contains 99.98 per cent. of silica; the best English sands are slightly inferior to this, but selected portions reach this very high standard. In Bohemia, crushed quartz is used.

It is very important that the sand should be sufficiently pure, as even a small proportion of some ingredients will prevent good glass being made from it. Thus for sheet glass for windows not more than  $\frac{1}{2}$  per cent. ferric oxide is permissible, and for coarse bottle glass 2 per cent. or more will do no harm, but for the finest white crystal and plate glasses the iron in the sand ought not to exceed 0.1 per cent.

**Soda** is usually employed in the form of **sodium sulphate**, a little carbon being mixed with it to facilitate the reduction of the sulphate, except in the case of lead or flint glass.

**Sodium carbonate** is equally satisfactory for the purpose but is more costly, though the wise glass-maker keeps a sharp look-out on the relative prices of these two forms of soda. Sodium sulphate requires a higher temperature than the carbonate before it begins to react with the silica, and more of it is required (about seven parts of the sulphate are equivalent to five parts of the carbonate), so that it is only when the sulphate is less than half the price of the carbonate that its use is profitable. The sulphate and carbonate radicles play no part in the manufacture of the glass, as it is only the metallic radicle which is important. Common salt (sodium chloride) cannot be used on account of its great volatility which makes it commercially too expensive: otherwise it reacts with silica quite as effectively as the other sodium compounds just mentioned.

Sodium sulphate should never be used in highly coloured glasses as these require a larger proportion of colouring agent than when sodium carbonate is used.

**Potash** is used in the form of **potassium carbonate**, as this is the cheapest and most available form. In lead glasses (flint glasses) and in some coloured

ones where an oxidant is required, some potash is introduced in the form of **nitre** (potassium nitrate), but this is too expensive for general use.

Substitutes for nitre have recently attained considerable importance. The most suitable are barium peroxide (see p. 249), potassium chlorate and perchlorate.

**Lime**, as already mentioned, is used in the form of carbonate (either **limestone** or **chalk**), but the **hydrate** is occasionally employed.

It is important to avoid the use of dolomitic limestone, as this contains magnesia which increases the viscosity of the glass, and prevents it being so clear as when a purely calcareous limestone is used. During the heating of the mixture, each of these lime compounds forms free lime, and it is the latter which attacks the silica (see below).

Lime (and its compounds) is the most uncertain ingredient of all glasses, and it is responsible for a large proportion of losses in manufacture.

**Magnesia** is not a common constituent of glasses, except in minute quantities as an impurity. When purposely added it is introduced in the form of lightly **calcined magnesia**.

In French hollow-ware, the proportion of magnesia is sufficiently large to be important. It is not added purposely, but is due to the use of dolomitic (magnesian) limestone instead of a pure calcareous stone. Magnesia makes the glass more difficult to melt but increases the range of temperature through which it can be worked. The great objection to its use in large proportions is that glasses containing it are difficult to heat sufficiently to make them properly fluid in the refining stage, so that they do not "clear" properly unless special precautions are taken. Magnesia also increases the tendency of glass to devitrify. In proportions of less than 10 per cent., the effects just mentioned are unimportant, and are counterbalanced by the strength and resistance to water possessed by glasses containing magnesia.

The magnesia molecules occupy the same positions in the glass molecule as those of lime, but if the lime is entirely replaced by magnesia a glass is obtained which has so rapid a rate of crystallisation that it devitrifies too much to be commercially valuable.

**Zinc oxide** may be used to replace lime and occupies the same positions in the glass molecule. It increases the refractive index of glasses, but not nearly so much as lead or baryta. Zinc oxide produces glasses with a small coefficient of expansion, great strength, and very low solubility in water and is, therefore, valuable as a constituent of laboratory glass and for thermometers. It cannot be used in large proportions, as zinc glasses devitrify with great rapidity.

In this connection it is interesting to notice that the addition of zinc oxide to pottery glazes is one of the easiest means of producing the beautiful crystalline effects which are so much admired. Zinc oxide tends to produce a yellow colour in glass, especially if the latter is overheated; this can be neutralised by a small proportion of nickel oxide.

The presence of zinc oxide in a glass lightens the labour of working by making the glass more ductile; it gives sharper outlines to moulded or pressed glass and a better finish. At the present time, however, it is chiefly confined to laboratory and optical glass and to that for thermometers.

**Barium oxide** or **baryta** is characterised by the high atomic weight of the metal it contains, and in consequence of this it gives density and lustre to glasses in which it occurs. It raises the melting point of mixtures in which it is present, so is not used for the commoner kinds of glass, but is greatly valued for special ones.

Baryta was first used in glass mixtures in 1829 by Dobereiner, but it is only recently that its valuable qualities have been recognised. It is chiefly used in hollow-ware, crystal-ware, special glasses, and for pressed glass. For the last named it confers just those qualities which are most desired, and is specially used to replace part of the lead. For plate glass, its use is accompanied by difficulties which have not, at present, been overcome. The chief drawback to the use of baryta is its tendency to devitrify in the absence of zinc oxide, and to settle to the bottom of the molten glass.

It is customary to employ precipitated **barium carbonate** as the means of introducing barium, as the sulphate induces an opaque frothiness which is not easy to remove. At the temperature of reaction, the carbonate and sulphate have both decomposed, and the active material is barium oxide. In many ways baryta behaves like lead oxide in the glass and may replace lead or lime but not alkali.

**Lead oxide** is one of the chief constituents of flint glasses. Several oxides and carbonates of lead exist, but the one generally used by glass-makers is red lead,  $Pb_3O_4$ .

It is often contaminated with brick dust and other adulterants and should be tested before use. Lead compounds are easily reduced, and in the manufacture of flint glass it is necessary to avoid reducing conditions in the furnace. For this reason the addition of oxidants (such as nitre, p. 248) is usual. Lead glasses are improved by chilling in water and re-melting (*dragading*), as the additional heating converts them into more stable ones, possibly isomeric with those produced in the first heating.

**Barium peroxide** ( $BaO_2$ ) has proved to be a very satisfactory substitute for nitre. It has the advantage of evolving oxygen at a higher temperature than nitre. Owing to the high atomic weight of barium, barium peroxide should be used for each part of nitre it replaces.

**Boracic or Boric Acid.**—The chief characteristics of boracic acid are similar to those of silica, but the glass produced is much more fusible than a pure silicate glass.

Like silica, boracic acid at a red heat liberates lime from calcium sulphate and displaces other strong acids. Boracic acid is even stronger than silica in this respect, and so is a valuable refining agent. By producing a more fusible glass, boracic acid also facilitates the "clearing" of the molten glass. Its chief disadvantage is that it is volatile in the presence of steam and should therefore be added after all the combined water has been driven from the glass mixture, the boracic acid being added in a calcined state. Another disadvantage is the avidity with which borate glasses attack the pots or tanks in which the glass is melted, producing a turbid or seedy (p. 260) glass.

Although boracic acid in many ways behaves exactly like silica—occupying the same position in the glass molecule and even forming boric rings—it can produce an increase in hardness and fusibility similar to the effect of alkalis; this is merely a coincidence.

The low melting point of borate glasses is of great value in the production of glazes, fusible colours and enamels.

Schott's boro-flint optical glass, S7, composed of 12 per cent. alumina, 32 per cent. lead and 56 per cent. boric oxide, contains no alkali, lime, or silica—three substances generally considered to be essential constituents of glass—and shows that the borate glasses are in several respects quite different from the silicate glasses.

Boracic acid is used in four forms: (*a*) as boracic acid,  $H_3BO_3$ , (*b*) as boric anhydride,  $B_2O_3$  (see Vol. I., p. 355), (*c*) as crystalline borax or sodium borate,<sup>1</sup>  $Na_2B_4O_7 \cdot 5H_2O$ , or  $Na_2B_4O_7 \cdot 10H_2O$ , and (*d*) as calcined borax,  $Na_2B_4O_7$ , which may be in the form of a powder or as fragments of "borax glass." Each of these forms is equally useful though they contain widely different proportions of boracic acid. Borax cannot be used in glasses which are to be free from soda.

There is much confusion among writers on glass-making with respect to these forms of boracic acid and great care must be exercised in studying their works. Thus, it is not uncommon to see boracic acid prescribed when borax is meant, and vice versa. The water present also varies greatly and, as this is of no use in the manufacture of the glass, it is important to have the boracic acid or borax tested before use.

In small proportions, boracic acid increases the refractive index of glass, though it is much more feeble in this respect than lead oxide. Hence boracic acid or borax equivalent to  $\frac{1}{8}$  of the weight of sand used in the glass mixture will appreciably increase the gloss and lustre of the glass, but it is not used for the best hollow-ware or crystal glass, as it imparts a slightly yellow tinge. Above 20 per cent. boracic acid lowers the refractive index. Contrary to potash, soda, and fluorine, the blue portion of the spectrum is reduced in glasses containing boracic acid. Lenses made of a combination of boro-flint and of phospho-crown glasses are exceptionally achromatic.

Borate glasses have a low coefficient of expansion, and so have a high thermal endurance and are very suitable for ware subject to sudden changes in temperature such as lamp chimneys and ornamental glasses decorated by fusing several glasses on each other.

Boracic acid also resembles silica in reducing the tendency of a glass to devitrify.

Glasses which contain free boracic acid, or in which this is the only acid constituent, are attacked by water, so that a high proportion of boracic acid is recognised as a disadvantage. Some borate glasses are highly resistant to air, water and acids, but are strongly attacked by alkalis. Thus, a Jena Gerate glass with 15 per cent. boracic acid is specially resistant to sudden changes of temperature, and to chemicals, and Jena lamp-chimney glass with 24 per cent. is exceptionally resistant to sudden changes in temperature.

Boracic acid in coloured glasses produces brighter and more uniform colours.

<sup>1</sup> The first formula is that of octahedral borax, which is formed when a supersaturated solution of borax is evaporated slowly. Commercial borax is chiefly composed of  $Na_2B_4O_7 \cdot 10H_2O$ .

**Phosphoric acid**, when combined with lime (as bone ash), is a well-known opacifying agent, but the free acid behaves like silica, though producing glasses more readily attacked by water and so only capable of use for optical purposes.

Boro-phosphate glasses are slightly more resistant than silico-phosphate ones. Schott made many experiments with phosphate (crown) glasses but without any strikingly successful results.

**Arsenic and Antimonic acids** are used for two different purposes in glass-making: (*a*) as opacifying agents (p. 269) and (*b*) as refining or clarifying agents. For the latter purpose, only small proportions are used, and most of the arsenic volatilises and escapes in the manufacture of the glass.

**Alumina** is present to a small extent in most glasses, but is introduced unavoidably as an impurity in the sand, etc., used. When added purposely, the hydrate (p. 49) is generally employed, though cryolite,  $\text{AlF}_3 \cdot 3\text{NaF}$  (p. 51), is used when opaque glass is desired, as it simultaneously introduces fluorine.

Alumina is a valuable constituent in many glasses, as it increases their viscosity and enables them to be worked over a longer range of temperature. It also makes glasses containing it in appreciable quantity more resistant to sudden changes in temperature, and is therefore valuable where high thermal endurance is necessary. Only a limited amount of alumina can be introduced for this purpose; if more than 3 molecules to each 36 molecules of silica are present, the excess of alumina will cause opacity by remaining uncombined. Such aluminous glasses can then be cleared by forming a glass of an entirely different chemical constitution, viz., an alumino-silicate ring compound instead of a silicate ring compound with alumina in the side chain position. Such alumino-silicates do not, however, make good technical glasses, though invaluable in the form of glazes for bricks, tiles, and pottery.

**Cullet** is broken glass, and is usually added to a mixture of raw material as a means of using up scrap glass, and also to start the reaction between the other materials.

Chemical reactions depend for their intensity on the intimacy of the contact between the reacting substances. This is increased when the reaction occurs in a fluid medium, and the use of cullet (which melts before the reaction of the other materials has proceeded very far) facilitates the production of the glass by providing a medium in which the combination of the silica with the various bases may occur.

Some manufacturers of bottles use nothing but cullet of flint glass which they collect from various dealers.

Mixed cullet (*i.e.*, cullet composed of several different kinds of glass) is almost useless, especially if it contains much common bottle glass, but cullet from works making only high class glasses is a valuable material.

**Decolorants** are substances added to glass in order to remove an objectionable colour which it would otherwise possess. Thus, iron gives a green or brown colour, which can be removed by the addition of **manganese dioxide**.

Normally, iron gives a greenish shade, but this becomes yellow or brown on account of the oxidising action of the manganese on the iron. Any oxidant of sufficient power would do equally well, but manganese dioxide has an additional advantage inasmuch as it gives a slight pink tinge to the glass, and as this pink is complementary to the yellow colour of the iron compound, the two colours neutralise one another, and a whiter glass is produced.

Only about 10 per cent. of the manganese dioxide added to the glass acts as a decolorant; the remainder forms colourless silicates and is wasted. There is, consequently, room for great improvement in this direction—possibly by the substitution of another more stable compound of manganese.

In flint glasses, the **red lead** and **nitre** are both oxidants, and so act as decolorants of the iron compounds. **Nickel compounds** form reddish glasses and thus act as decolorants where the proportion of iron is only small, as in plate and mirror glasses. **Selenium compounds** have been extensively used during recent years as decolorants by forming pinkish glasses, and in addition to this they also improve the lustre of the glasses to which they are added. Arsenic acid,  $\text{As}_2\text{O}_5$ , is also useful as a decolorant in certain glasses.

**Colouring agents** are used in the manufacture of opaque and coloured glasses. The latter are considered separately on p. 267.



## TECHNICAL CLASSIFICATION OF GLASSES

The glasses of chief importance may conveniently be classified as follows :—

I. **Crown glasses**,<sup>1</sup> composed of soda, lime and sand, but with a composition varying according to the oxides which are used to replace those mentioned. Thus potash may replace the soda in whole or in part, and baryta may replace a portion of the lime. Crown glasses are used for a variety of purposes, and specially for sheet glass, plate glass, and for optical work.

II. **Bohemian glasses**, composed of potash, lime and sand, or quartz, used chiefly for hollow-ware.

III. **Flint glasses or lead glasses**, composed of potash, red lead and sand, used for hollow-ware, bottles of superior quality, and for optical work. These glasses are known in France as **crystal**.

Where sand of sufficient purity is difficult to obtain, flints crushed to fine powder may be used instead, but such glasses ought not to be known as *flint glass*.

IV **Bottle glasses**, usually composed of soda, lime, alumina and sand, the latter being less pure for the commoner bottles.

The alumina is seldom added purposely, but is a useful constituent of the sand employed.

V. **Boro-silicate crown glasses** resemble crown glasses, but part of the silica is replaced by boric acid, so as to confer special properties. These glasses are chiefly used for optical purposes, laboratory ware, and for thermometers.

VI. **Boro-silicate flint glasses** resemble flint glasses, but part of the silica is replaced by boric acid. These glasses are chiefly used for optical work, enamelling, and for artificial gems.

VII. **Phosphate glasses** may be of either the crown or flint type in which part of the silica has been replaced by phosphoric acid. They are used almost exclusively for optical purposes.

VIII. **Silica-free glasses** are those in which the whole of the silica is replaced by boric or phosphoric acid. They are so costly as only to be suitable for special optical purposes.

IX. **Water-glass** and other simple silicates are not usually included among the glasses, as they are unsuitable for the technical purposes for which glasses are used. For **Water-Glass**, see p. 133.

X. **Opaque and coloured glasses** are made from the glasses mentioned above by the addition of opacifying or colouring agents (see also p. 266).

Glasses are also classified according to the processes used in their manufacture or working ; thus **blown glass** is that which can be shaped by the pressure of the human breath, applied by means of a blowpipe or pontil ; **plate glass** is that which is capable of being rolled into a plate or sheet ; **sheet glass** is that which can first be blown into cylinders, and then flattened into a sheet ; **table glass**<sup>2</sup> is that which is specially suitable (on account of its brilliancy) for the manufacture of hollow-ware for table use.

For **hollow-ware**, a light flint glass is generally used on account of its lustre and brilliant appearance. It is sometimes parti-coloured by flashing, that is by gathering a little glass of another colour on the outside of the main piece of glass, and working the two together.

If the ware is to be moulded, it must be plastic over only a short range of temperature ; this is

<sup>1</sup> The term "crown glass" should, strictly, be applied to glass articles produced in a special manner (p. 260), but it is also largely used as the name of a type of glass, as indicated in the text.

<sup>2</sup> In reading German books on glass manufacture (and some translations of them) it is important to remember that the word *Tafelglas* does not mean "table glass," but plate glass.

attained by the use of a small proportion of alkali, or by using a mixture of soda and potash instead of one of them, in an alkali-lime (crown) glass, and keeping the lime as low as possible.

In **bottle glass**, cheapness, strength, and resistance to the fluids likely to be used are the chief desiderata, and they are usually secured by the employment of glasses low in alkali, high in metals of the RO group, and with alumina up to 10 per cent. A considerable proportion of iron is no objection in bottles used for many purposes, especially as it provides a coloured glass without extra cost. A low alkali content is specially necessary in glasses which are blown mechanically.

Glass used for the manufacture of bottles containing fermented liquors must be resistant to the action of such liquors and the gases produced during fermentation. Champagne bottles must be very strong as the pressure of the gas produced sometimes reaches five atmospheres.

Colour being of minor importance, much interest is taken in the numerous attempts which have been made to use the **slag from blast furnaces** as one of the principal ingredients of a bottle glass. By placing a glass tank, heated by a Siemen's regenerative furnace, close to the blast furnace, and allowing the molten slag to run direct into this tank, more than half the material necessary for the glass is obtained in a molten state. The addition of a suitable quantity of soda and sand will produce a glass of a quality quite good enough for common bottles, and a few works are using this method satisfactorily. The great drawback is the necessity of the glass-blowers being subsidiary to the men working the furnaces, and the large amount of slag wasted, because the glass is not made and used as fast as the slag is produced. There is, however, room for further work in this direction as a good means of disposing of blast-furnace slag in a hot state is a great desideratum.

**Bead glass** is not a special variety of glass, though it is stated to be so in some books.

The glass is usually a crown glass to which a little alumina has been added (in the form of impure sand), and the beads are made by drawing tubes, chopping these into small pieces, and rounding the edges by placing the pieces on a tray and heating them to redness in a furnace.

## MIXING AND PREPARING THE GLASS

In order to obtain the best results it is essential that the composition of the mixture or **batch** and the conditions under which it is heated shall be as uniform as possible.

Glass manufacturers are, therefore, loth to change either their furnaces or their fuel, and adhere as closely as possible to one source of supply for each of their raw materials. With improved methods of analysis and of testing raw materials, it is now possible to cheapen the cost of production by providing a wider range of ingredients; but the serious results which may follow a mistake in the proportions, or in the nature of any of the materials used, are sufficiently important to prevent most manufacturers from availing themselves of the best scientific information on the subject. This slowness, whilst quite understandable, is none the less regrettable, for the French and German manufacturers are more willing to avail themselves of recent investigations, and consequently have been able to produce several new glasses of considerable commercial value.

The **proportions** of the various ingredients cannot be determined entirely from the composition of the finished glass, owing to the loss of material in the form of scum (known technically as **sandiver**<sup>1</sup> or **glass gall**), and to the loss of alkali, etc., by volatilisation. Moreover, the yield of the definite compound which is the essential constituent of the glass is not perfect, and small, but varying, proportions of other compounds are formed and included in the material of the glass. The following **recipes** are fairly representative of the glasses mentioned, but it must be understood that each glass-maker has his own recipes, based on the materials and conditions to which he is accustomed. Moreover, each different sand requires some modification in the composition of the batch, so that recipes can only be indicative of the proportions used, and can seldom be followed implicitly:—

**Crown Glass.**—Sand, 100 parts; chalk, 24 parts; sodium sulphate, 50 parts; charcoal, 4 parts; cullet (broken glass), 200 parts.

---

<sup>1</sup> It is composed almost exclusively of calcium and sodium sulphates, with about one-tenth their weight of glass.

**Window Glass.**<sup>1</sup>—Sand, 100 parts; chalk, 28 parts; sodium sulphate, 42 parts; cullet, 100 parts; arsenic acid, 1 part; charcoal, 3 parts; manganese dioxide,  $\frac{1}{2}$  part.

**Plate Glass.**—Sand, 100 parts; chalk, 30 parts; sodium carbonate, 32 parts; potassium carbonate, 6 parts; cullet, 100 parts; manganese dioxide,  $\frac{1}{2}$  part; nitre, 2 parts.

**Flint Glass or Crystal.**—Sand, 100 parts; potassium carbonate, 33 parts; red lead, 67 parts; manganese dioxide,  $\frac{1}{2}$  part; potassium nitrate, 7 parts; cullet, 100 parts.

**Baryta Glass.**—Sand, 100 parts; sodium carbonate, 30 parts; barium carbonate, 90 parts; red lead, 65 parts.

**Bottle Glass (Green).**—Sand, 100 parts; sodium sulphate, 38 parts; chalk, 33 parts; charcoal, 2 parts; manganese dioxide,  $\frac{1}{2}$  part; cullet, 50 parts.

**Bottle Glass (Brown).**—Sand, 100 parts; sodium sulphate, 35 parts; chalk, 34 parts; cryolite, 10 parts; charcoal, 2 parts; manganese dioxide, 8 parts; cullet, 50 parts.

The following recipes were published in 1915 by the Institute of Chemistry as the result of an investigation, made under the auspices of that body, into the best methods of producing glasses in Great Britain to replace those hitherto imported from Germany:—

	1	2	3	4	5	6	7	8	9	10	11
Sand	67.0	67.0	67.0	68.2	68.2	65.0	65.0	65.5	72.0	68.0	68.0
Alumina	6.5	8.3	10.0	6.2	6.2	1.0	1.0	2.5	10.0	4.0	4.0
Sodium carbonate	34.2	29.0	17.0	5.5	5.5	14.0	...	10.2	11.2	26.0	26.0
Calcium carbonate	11.6	9.6	12.5	13.0	14.2	0.6	...	...	11.0	12.8	12.8
Calcium fluoride	...	1.6	...	1.0	...	...	...	...	...	...	...
Barium carbonate	...	...	...	8.8	8.8	...	...	...	...	...	...
Magnesia	...	...	0.5	...	...	...	...	5.0	0.5	...	...
Potassium nitrate	...	...	1.0	4.3	4.3	3.0	3.0	...	3.0	14.5	...
Borax (anhydrous)	...	...	...	...	...	...	26.68	13.0	7.2	...	...
Boric anhydride	...	2.0	8.0	5.5	5.5	24.0	5.5	...	...	...	...
Antimony oxide	...	...	...	...	...	1.0	1.0	...	...	...	...
Arsenious oxide	...	...	...	...	...	2.0	2.0	...	...	...	...
Zinc oxide	...	...	...	...	...	...	...	8.0	...	...	...
Potassium carbonate	...	...	...	...	...	...	...	...	...	...	10.0

1 is a soft glass, not readily soluble or easily devitrified, and works well in the blowpipe.

2 is a soft glass of higher quality.

3 is a glass suitable for pharmaceutical purposes; it is highly resistant to chemical action, withstands changes of temperature well, and should be a very suitable glass for high class beakers, flasks, etc.

4 and 5 closely resemble Jena combustion tubing.

6 and 7 are glasses for miners' lamps, and withstand rapid changes in temperature.

8 is a glass almost identical in its general behaviour with Jena resistance glass; withstands changes of temperature well, but, like Jena, is not suitable for working before the blowpipe. It darkens and tends to devitrify; operations—such, for instance, as sealing side tubes into flasks—are difficult, if permanent and neat joints are required. For some purposes, No. 3 may be substituted as it works well in the blowpipe and is highly resistant chemically.

9 is an alternative mixture for combustion tubing, and does not become cloudy so readily as Nos. 4 and 5.

10 and 11 are soft glasses specially suitable for tubing and X-ray bulbs. 10 being the better of the two, when used for X-ray bulbs, gives a blue phosphorescent glow; if a green glow is desired a little manganese dioxide should be added to the batch mixture.

It is essential that all the materials should be finely ground before weighing. They should be weighed as accurately as possible, and then mixed by means of a wooden shovel, or preferably, in a mixing machine, so as to secure as uniform a product as possible. The batch or mixture is then placed in the hot pots or pans in small quantities at a time until the vessels are almost full of molten material. The actual melting usually occupies ten to twelve hours, but depends on the quantity to

<sup>1</sup> Window glass is also known as sheet glass.

be made and on the type of furnace used. There is a large evolution of gases during this operation, and these form a froth or scum which must, from time to time, be ladled from the surface. Fire-clay rings are placed on top of the molten glass or metal when open pots are used, these rings serving to collect the scum or gall, and facilitating the operation of clearing the surface of the glass.

When the frothing has ceased and the scum has been removed, the glass must be refined or **planed**. This may be accomplished in various ways: one consists in throwing in potatoes or apples, or stirring with a strip of green wood so as to effect a reduction of any matter which may be removed in this manner, and also to produce a further volume of gas which will help in the stirring of the molten glass.<sup>1</sup> The usual method of planing, however, consists in stirring the glass with a fire-clay cylinder attached to a long iron rod. During the refining process it is necessary that the glass should be very intensely heated, so that it is very fluid and mobile; its temperature sinks gradually during the stirring, and towards the end of the process the glass is quite viscous. The glass-maker draws trials or test portions from the furnace and examines these; when they show that the glass is clear and can readily be drawn into long threads, the stirring is stopped, and the glass is allowed to cool still further until it is sufficiently viscous for use.

If one "planing" is insufficient it must be repeated as often as may be necessary. Three such

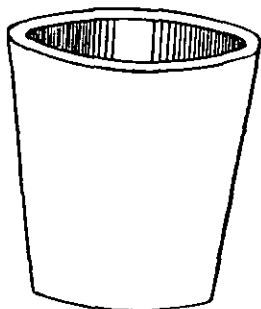

FIG. 1.—Open Glass Pot.

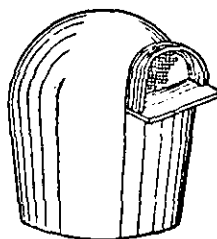

FIG. 2.—Covered Glass Pot.

treatments will usually suffice if the glass has been rapidly melted, and is sufficiently fluid. The use of a recording pyrometer (Vol. I., p. 68) to ascertain the temperature of the glass is advantageous.

It is generally thought that the stirring of the glass is a purely mechanical means of securing uniformity, but Zulkowski has carried out experiments which seem to show that the intense heating, followed by prolonged stirring, are the means of effecting chemical changes within the molten mass, and that without this treatment the substances which form the essential constituents of the glass are not produced.

The melting of optical and of most other special glasses is effected in closed pots, the stirring of which is difficult and sometimes impossible. Such glasses must therefore be broken up, and the cleanest fragments selected and remelted, in order to obtain the best results.

The vessels in which glasses are melted are of several types. Where large quantities of glass are manufactured, open tanks are used, but for special glasses or those which require to be kept particularly clean, pots (Figs. 1 and 2) are employed. Where it is particularly necessary to prevent portions of the brickwork from the top of the furnace, or other extraneous matters, from falling into the glass, the pots are provided with tops, and the glass is withdrawn through small openings at the side. Both tanks and pots are made of fire-clay of the best quality. They require great skill in their manufacture, especially the larger ones, which hold 12-18 cwt. of glass. They must be annealed carefully before use, and when once heated they must never be allowed to become quite cold again. With careful use a glass pot will last three months or more,<sup>2</sup> but sometimes a pot will break after

<sup>1</sup> In some works the potatoes or apples are inserted on the pointed end of an iron rod, which is then used to stir the glass.

<sup>2</sup> When special skill and care are exercised in the manufacture and use of glass pots, they may last a year or more. There is ample scope for a full investigation of glass-house pots; at the time of writing those having the longest "life" are made in the United States.

two or three days' use. Some pots have a vertical partition, so that the scum is automatically separated.

The use of direct, coal-fired furnaces for heating the pots or tanks is diminishing, as gas-firing is more economical and more satisfactory. Several pots are usually heated simultaneously.

Producer-gas is used, and the main feature of the furnaces is the employment of a regenerator of the type devised by Siemens (see Vol. I., pp. 43 and 54). This regenerator consists of a series of passages filled with checkered brickwork through which (a) the products of combustion and (b) fresh air for burning the fuel pass in opposite directions. In the regenerator, the outgoing gases heat up one series of bricked chambers, and, by changing a valve, the gases are turned into another set of chambers, the ones previously heated being then used to warm the incoming air required by the furnace. By this means an intense heat is obtainable without using an exorbitant amount of fuel.

For heating small quantities of special glasses, wood is superior to coal, and for many years was the only fuel used in glass-making. The improvements effected in gas-fired furnaces during recent years, have now, however, resulted in the disuse of wood except in a very few instances.

In a glass tank-furnace arranged for a continuous supply of glass, it is necessary to secure: (i.) complete and rapid fusion of the glass mixture; (ii.) a suitable rate of charge and discharge; (iii.) the withdrawal of the molten glass before it has

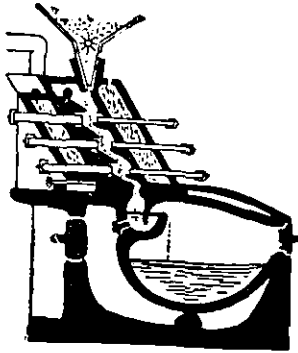

FIG. 3.—Diagrammatic Section of Voelker's Electric Furnace.

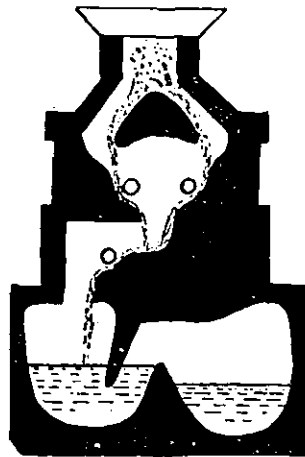

FIG. 4.—Diagrammatic Section of Becker's Electric Furnace.

been overheated and so begun to devitrify. The chief drawbacks of a continuous furnace is the glass-gall produced by the sodium sulphate (Glauber salt), which floats on the surface of the molten glass, spoiling it and corroding the sides of the tank very rapidly. Tanks having two or more compartments are not durable, as the partitions are rapidly corroded.

Several attempts have been made in recent years to utilise electric furnaces for glass-making, with a fair amount of success. The two most successful types of furnace for this purpose are the Voelker (Fig. 3), and the Becker (Fig. 4), respectively. In each case the batch mixture flows between rows of carbons which convey the electric current, and the glass, as it melts, flows into a lower receptacle. Scumming is avoided by the use of baffles. For bottle, sheet, and plate glass these furnaces have proved quite satisfactory, but some users complain of difficulty in obtaining a sufficiently homogeneous glass. Electric furnaces do not appear to be well adapted for optical glass, and as they have not proved cheaper than gas-fired furnaces of the tank type in localities where coal is not above the normal price, the field of usefulness appears to be limited to those places where water-power or other special facilities suggest the preference for electricity as a source of heat.

## GLASS-WORKING

Various methods are employed in making articles of glass, but the majority of them are based on the production of a hollow flask by **blowing** (blown glass), or on the production of a plate made by **casting** the glass and then **rolling** it.

What is known as **pressing** is the use of moulds as a means of forming the outer shape of the article; it may be employed in combination with either casting or blowing.

The **blowing** of glass not only requires the possession of much strength and good lungs, but also a considerable amount of dexterity and skill, particularly for some of the more elaborate and delicate wares. The chief tools required are a pontil or iron (Fig. 5), which consists of a pipe some 5 ft. in length, and a number of tongs, shears, and other simple tools. The workman dips one end of his pontil into the viscous glass in the furnace, and withdraws it with a suitable quantity of glass on the end. Some skill is required in "gathering" the correct amount of glass, and in coiling it round the end of the pipe in the position desired. The men work in gangs of four, as a considerable amount of assistance is required in some of the operations. Boy labour is increasingly used in many of the works.

Two systems of working are in use. In the **old** one the glass on the end of the pontil is rolled on a polished iron plate or **marver**, and is then slightly hollowed by blowing. Its shape is regulated by a continuation of the blowing, accompanied by a swinging motion of the pipe, and, frequently, by the use of small iron tongs (Fig. 6). Accuracy in shaping is dependent almost entirely on the skill of the workman, and it is precisely because of the difficulty in obtaining sufficiently skilled men that this method of working is falling into disuse where many articles of the same shape are to be made. In the case of a wine-glass, the bowl is shaped as just described, and the leg is made by pulling out the thickened mass at the end of the bowl, or by attaching a fresh piece of glass to the bowl and pulling this out to the desired shape. Meanwhile an assistant has

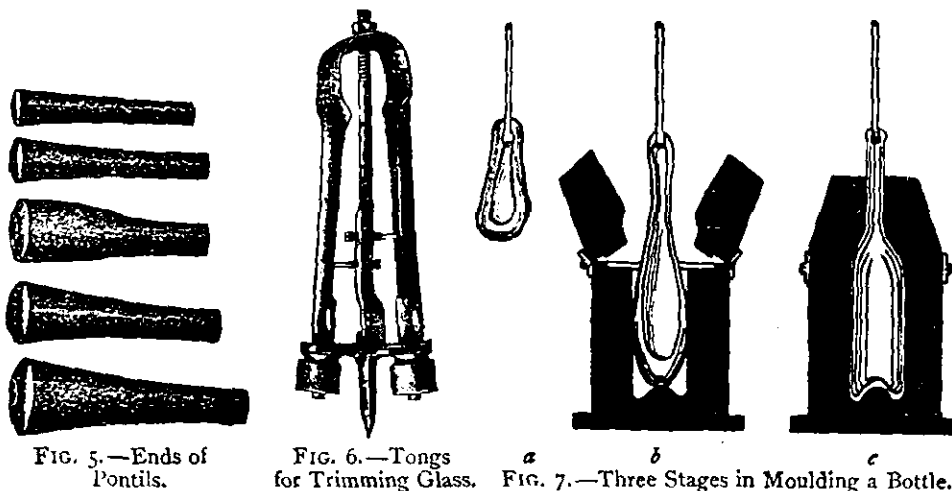

FIG. 5.—Ends of Pontils.

FIG. 6.—Tongs for Trimming Glass.

FIG. 7.—Three Stages in Moulding a Bottle.

been blowing a separate piece of glass, at the same time twirling his pipe rapidly, so as to cause the glass to move centrifugally and produce a flattish disc instead of a spherical bulb. This disc is then heated momentarily in the furnace, and is then attached to the leg of the wine-glass on the first pontil, so as to form the foot of the glass. Some men prefer to attach the foot when it is in the shape of a bulb, and to rotate it to shape after breaking it off the pontil to which it was first attached. When this is done, the glass must be cut from its original pontil and mounted, by means of its foot, on a second pipe. The mouth of the glass is then trimmed smooth and even with shears, and by holding it in the mouth of the furnace its final shape can be given by means of a tool resembling a large pair of sugar tongs.

The foregoing system is the one by means of which the beautiful glass ware of ancient times was made. It is, however, slow and requires an enormous amount of skill, so that for many purposes it has been replaced by a method in which the shape of the vessel is given by means of a mould. The use of this mould reduces the amount of skill required, it increases the speed at which the men can work, and it ensures all the vessels being of the same shape and size.

The **new** method is illustrated in Fig. 7. The mass of glass is gathered on the pontil and rolled on the marver as before, but instead of being blown to shape, it is placed inside an iron mould and then blown. The mould prevents the glass from taking any other shape than that intended, and greatly facilitates the working. The mould is lubricated by means of a splinter of wood which is ignited by the hot glass,<sup>1</sup> and by revolving the pontil all seam-marks in the mould are prevented from being transferred to the glass. In the case of bottles, the neck is usually finished by means of a pair of tongs, the ends of which form a supplementary mould. This is considered to be more convenient than the use of a larger mould which forms the neck at the same time as the

<sup>1</sup> A better lubrication is secured by painting the inside of the mould with a pasty mixture of pitch, wax and sawdust, and then heating the mould in a furnace until the lining is carbonised.

bottle, and is certainly much cheaper, as one pair of tongs will serve for several moulds. Where long-necked bottles are desired, the mould must be supplemented by a second (Fig. 7, *b*), as otherwise it would be difficult to withdraw the bottle from the mould. In the case of a wine-glass made by this system, the bowl is shaped by means of the mould, the leg is made as on the old system, and the foot attached in the same manner. The glass is then cut off the pontil and sent to the annealing lehr. The mouth is finished in the annealed glass, by cutting and grinding, instead of working the glass in a viscous state at the furnace. Handles and decorative work, such as threads or beads, must be applied to the hot glass, and such articles are, therefore, best made by the old system, as the glass is cooled by the mould and is difficult to heat again without risk of devitrification. Much skill is shown in the way some glasses have been decorated by simultaneously gathering two or more kinds of glass on the pontil and then proceeding with the working. In this way, elaborated coils and other designs are made in a comparatively simple manner.

Combinations of both the old and new methods are largely in use. Thus, in some works instead of using the marver, the bulb of glass is shaped by pressing it on a wet wooden dish. Wooden tongs for flattening the feet of wine-glasses and other simple tools are much more extensively used than formerly.

The enormous demand for cheap bottles has resulted in the invention of numerous machines in which the process of blowing and pressing may be effected mechanically. The machine which has gained the most recognition is that patented by Owens in 1905 in America, and controlled by the European Glass Bottle Syndicate. One of these machines, with the aid of six men, will produce no less than 15,000 to 20,000 bottles a day, whereas a skilled blower will not make more than 350, and few men will exceed 300 bottles in the same time.

The machine is too complex to be described in detail, but briefly it consists of six horizontal arms on a vertical rotating shaft, each arm being fitted with a blast and suction device, so that each arm produces a complete bottle with every revolution of the shaft. When the machine is at work, an arm, carrying a mould, dips into the glass tank, and simultaneously exhausts the air from the mould, thereby filling it with glass. The arm is then raised and moved away from the glass tank, during which motion the suction is stopped, any excess of glass is cut off automatically, and the mould is then removed, leaving the glass hanging from the arm in the shape of a bulb. A new mould is now placed around the glass, and the air blast is turned on so as to make the glass into the required shape, after which the mould and bottle are both removed, and the arm is lowered and ready to commence the making of a new bottle. The bottles must be dressed and freed from sharp edges, particularly at the neck. This is effected by the same machine, which carries the bottles round to a small furnace and holds them in such a manner that the edges are rounded by the heat; they are then sent to the annealing chamber. The glass tank containing the molten glass is preferably made to rotate, so that the cold arm does not always dip into the same part of the tank and so chill the glass unduly. Frequent changes of moulds are necessary, and a fitter must be employed to keep the machine in order. All the men employed may be unskilled as the machine is almost automatic.

Glass of the ordinary composition may be used with this machine, but it is desirable to replace the greater part of sodium sulphate by a corresponding proportion of sodium carbonate. Felspar should be absent, and the glass must be heated sufficiently to make it properly fluid.

The Severin machine is an improvement on that just described, but differs from it chiefly in the manner in which the moulds are filled, a fire-clay vessel being used, in which a plunger fills the mould with glass. The low conductivity of the fire-clay permits the glass being used without undue cooling, and does away with the necessity of a special furnace and glass tank.

The Brühler machine for wide-mouthed bottles, tumblers, etc. (Fig. 8), bears a close

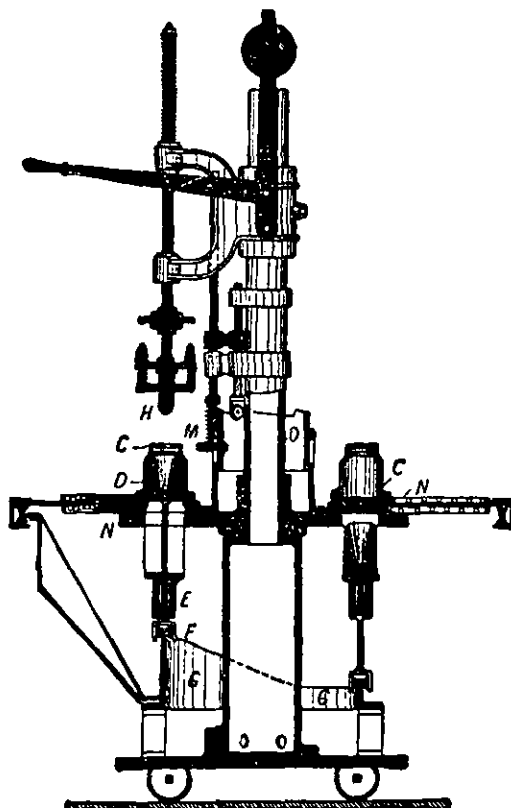

FIG. 8.—Brühler's Glass Machine.

resemblance to the presses used in the manufacture of earthenware and flower pots. It consists of a series of moulds on a rotating table, with a vertical plunger which fits each mould in turn. The fluid glass is poured into the moulds in turn, and is first pressed and then blown by compressed air to the desired shape. When the glass is being poured in, the mould *D* is above the top of the table, and the plunger *H* forms a conical vessel with a wide mouth. The mould *D* is then lowered automatically and its place is taken by a plate *N* (compare the left and right hand sides of Fig. 8). In this position the blast-pipe *M* is applied to the mould, and the bottle is blown to the desired shape. No skilled men are needed.

A considerable number of other machines for the automatic production of bottles and other hollow-ware have been patented, but must be regarded as in the experimental stage. One of the difficulties experienced by inventors of glass-working machines of this kind is the action of the firms using the Owens machine, which prevents the placing of other machines on the market.

Sheet glass is made by first blowing a long bulb on the end of a blowing iron, flattening it until its diameter is sufficiently large, then again blowing it until a long bulb, whose sides are the same thickness as that of the desired sheet, is obtained. The solid end of this bulb is then cut off with a cold iron, and the mouth

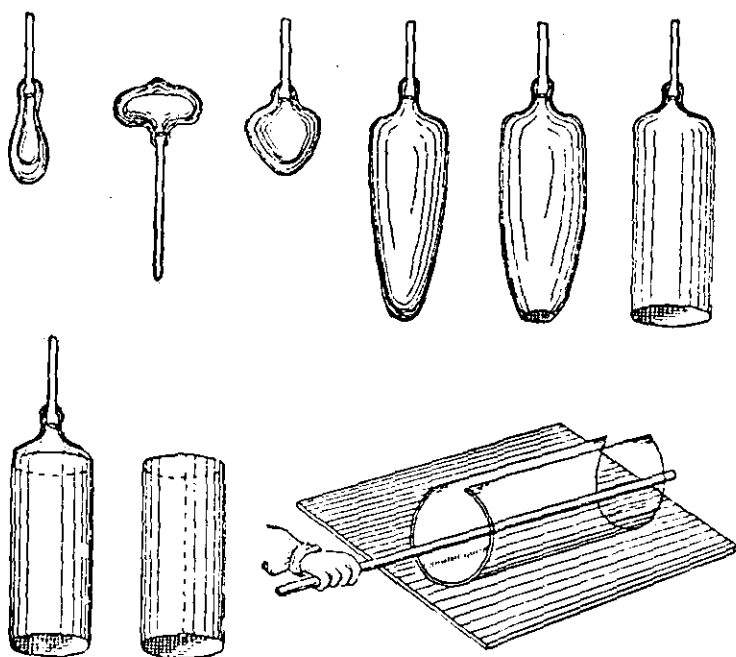

FIG. 9 — Nine Stages in Making a Sheet of Glass.

is widened into a cylinder by means of a pair of spring tongs, the glass being meanwhile rotated somewhat rapidly. The open end of the cylinder is next received on a pontil with an enlarged end, and is attached to it by means of three small pieces of semi-molten glass. The blowing rod is then cut off and the other end enlarged into a cylinder by means of the spring tongs. The cylinder is then slit lengthwise and is placed on a hot fire-clay slab, a polishing iron is then placed inside it, and rolled backwards and forwards so as to flatten the cylinder into a sheet. For this purpose the fire-clay slab must be kept sufficiently hot to soften the glass, but not hot enough to melt it. The various stages of blowing and making into a sheet are clearly shown in Fig. 9.

For sheets 4 ft. to 6 ft. in length the use of the lungs alone will not provide sufficient air, so that compressed air is supplied to the blowing iron.

Various mechanical methods of making sheet glass have been devised, but are not wholly satisfactory.

What, at one time, appeared to be a promising process consists in expressing the viscous glass through a mouthpiece or die and receiving the sheet thus formed on a warm plate. In practice,



however, it is found that the sheet curls badly on account of its surface tension, and the labour of flattening it makes this process more expensive than blowing cylinders and flattening these into sheets.

Better results are obtained by the arrangement patented by Foucault in 1906, in which a fire-clay plunger is fitted into a mouthpiece placed somewhat below the level of the surface of the molten glass in the tank furnace. In the centre of this plunger is a vertical slot, and on the application of pressure the glass is forced upwards through this slot, and is gently drawn out by attaching a sheet of reinforced glass. The glass is drawn upwards in an endless band by means of vertical rollers covered with asbestos and placed in pairs above the slot, the whole arrangement being contained in a chamber which effects the annealing of the glass. The glass solidifies almost immediately on leaving the slot, and on passing the final pair of rollers it is fully annealed and can be cut into sheets. The time occupied from leaving the slot to being cut up is about twenty minutes. Several of these devices can be fitted to each glass tank, so that the space occupied is not large. The method has proved satisfactory in the works where it has been installed.

In E. Rowart's machine (used at Auvclais-Charleroi) a pair of endless metal bands, arranged vertically above a series of pairs of asbestos blocks, is used to withdraw the sheet as it is formed from the molten metal. This arrangement affords a better support to the glass than the rollers used by Foucault; it can produce sheets 2 ft. wide.

In another modification of Foucault's machine, the glass is drawn up in the form of a cylinder which is afterwards slit longitudinally and then flattened as described on p. 258.

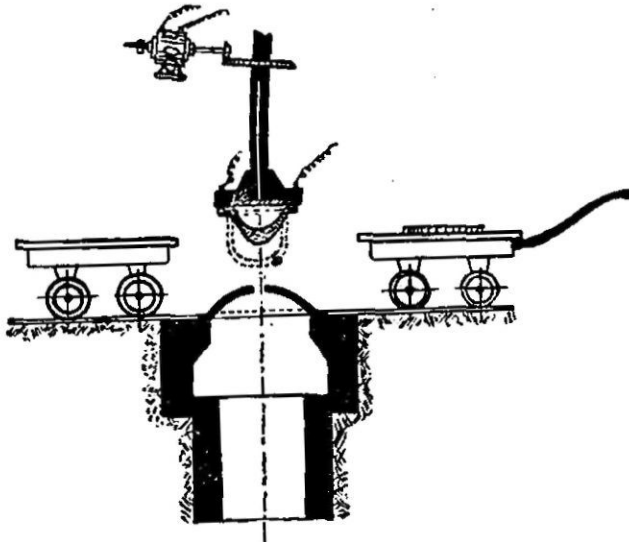

FIG. 10.—Sievert's Process.

In all machines of the foregoing types, the sheet or cylinder of glass must be received in an enclosed and heated chamber, as otherwise the difference in the rate at which the exterior and interior of the glass cools will cause it to crack.

Various machines have been devised for mechanically blowing flasks from which cylinders may afterwards be cut. The mechanism required is necessarily intricate, and the cost of operating these machines is greater than hand-blowing.

A very serious drawback to the use of all mechanical methods of blowing glass is the fact that the work of the glass-blower is not merely mechanical; he must exercise considerable skill in observing the condition of the glass and adapting his movements accordingly.

To be successful, a glass-working machine should have the following characteristics: (a) It must be driven easily; (b) it must be suitable for use with existing furnaces and glass mixtures; (c) it must be strongly built, as repairs involving the stoppage of the machine prove costly; (d) the labour required must be largely unskilled; (e) the articles made must be as durable and possess all the other requisite characteristics of hand-worked glass; (f) the cost of production must compare favourably with that of hand work; (g) the product must be ready for use as soon as it comes from the lehr. Any considerable amount of trimming or other additional work makes the use of mechanical methods of blowing too costly to compete with hand work.

The temperature at which the glass is worked, the width and thickness of the sheet and other minor matters necessarily require modifications in this process. For instance, in France the bulb is heated several times before the unusually long cylinders, customary in that country, can be obtained.

**Large vessels**, such as carboys for the storage of acids, are blown by means of human lungs for the first stage, and afterwards a little water is introduced; this is rapidly converted into steam, and secures the expansion of the glass to the desired size.

Sievert & Co., Dresden, have produced numerous articles by casting a slab of glass on a perforated plate, clamping it down thereon, inverting the plate so that the glass hangs suspended above a mould, and then forcing compressed air through the perforated plate so that the glass is blown to fill the mould.

This arrangement enables large tanks for electric accumulators and other purposes to be made very cheaply. A modification of this arrangement is also used for the manufacture of large cylinders and for sheet glass.

The arrangement was originally patented in 1904, but has since been improved in several respects. The form in which it is at present used by Engels & Cie, Bilm, is shown diagrammatically in Fig. 10. A steel ring, fitted with a rabbeted edge, is laid on a waggon and is filled with molten glass. As soon as this glass has become sufficiently tough the waggon is moved until the ring is exactly under the hollow shaft. The latter is then lowered until its base touches the ring.

An electric current is then applied to the base, and the latter is converted into a powerful magnet, so that when the shaft is raised to the position shown in Fig. 10, the ring is lifted with it. The waggon is now removed, the shaft is lowered into the mouth of the furnace so as to warm the glass thoroughly. The shaft is again raised, a fresh waggon placed beneath it, and air is blown through the hollow shaft whilst it is rotated rapidly. This causes the glass to expand uniformly to the shapes indicated, and when the blowing is complete the shaft is lowered so that the glass rests on the car. The electric current is then cut off, and the glass is thereby freed from the shaft and can be carried away, or the ring can be held by a separate carrier and the glass allowed to remain suspended. Cylinders of large size can be produced in this way much more rapidly than by hand blowing.

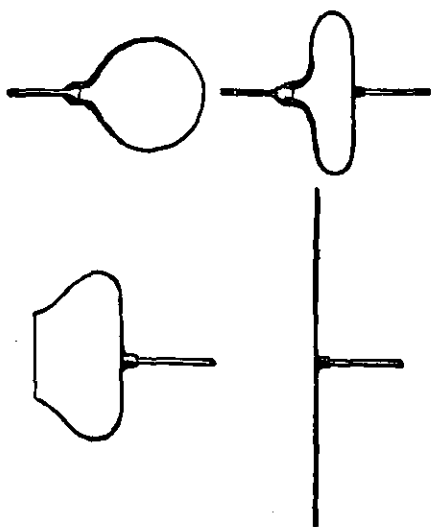

FIG. 11.—Four Stages in the Manufacture of Crown Sheet Glass.

the centre of the flattened portion of the glass, and the blowing iron is cut off. The glass is warmed again and is then revolved rapidly on the pontil, so that under the influence of centrifugal action the glass spreads and ultimately forms a flat sheet, with a "bull's eye" in the centre. This method is costly, and has been replaced by the use of cut and flattened cylinders.

**Fluted sheet glass** is made by blowing the bulb into a mould, the walls of which correspond to the desired flutes. Other patterns may be made in the same way, but it is better to use the process employed for plate glass.

Defects in sheet glass are comprised under four heads: *seediness* when the glass is contaminated with bubbles owing to its not having been properly refined; *stones* or uncombined particles which may be seen on examining the glass with a lens; *colour* due to some impurity in the sand (see "Coloured Glasses," p. 266), or to an insufficient or inaccurate application of a decolorant (p. 250); *stringiness* or *striae*—wavy and irregular markings in the glass, due to its irregular expansion during blowing or flattening, or to its not having been heated sufficiently during manufacture. Other defects are described on p. 266.

The **casting** of glass is chiefly used for two purposes: (a) the direct moulding of thick dishes, basins, and other simple objects, and (b) in the manufacture of plate glass.

**Plate glass** is chiefly used for large windows and mirrors. It is clearer and more transparent than sheet glass manufactured by blowing, but is more costly. The present method of making plate glass does not differ materially from that

used for over two hundred years; the chief improvements have been in means whereby plates of very large size may be produced. Sheets up to 30 ft. by 17 ft. can now be made with comparative ease, and larger ones are occasionally manufactured.

The molten glass in a suitable melting pot is slung over the casting table by means of a crane, and its contents are poured out as evenly as possible on an iron table. An iron roller is then rolled across the viscous glass, reducing it to a uniform thickness throughout. The thickness is determined by two straight-edges placed one on each side of the table at a distance depending upon the desired width of the plate. The glass plate is then taken to the annealing oven, and is afterwards levelled and polished. The casting table must be of stout metal or it will warp and twist under the influence of the heat. The roller is better if heated internally, though many works do not adopt this precaution.

When the cast and rolled plate is removed from the annealing chamber it has a rough, opaque, and undulating surface, but the interior should be quite clear. The plate is examined as to its freedom from defects, trimmed to shape and sent to be ground.

The glass is fastened to a grinding table with plaster of Paris, and the table is rotated about 30 revs. per minute. Two or more ribbed rollers run eccentrically over the surface of the glass, their action being aided by the use of wet sand or emery. The final polish is given with felt and leather rollers and rouge. The polished plate is then cut into pieces by means of diamonds (small steel wheels are now used as a substitute). If bent sheets of plate glass are required for curved windows, etc., the polished plate is bent by heating it in iron moulds of the desired shape.

Small pieces of plate glass are usually rolled by means of a loose hand-driven roller, but for the larger sheets the roller is worked mechanically.

The grinding and polishing removes about half the thickness of the original plate, and as the glass removed is in the form of fine powder mixed with sand or rouge it represents a serious loss. Various attempts have been made to recover the glass from the waste abrasives, but without much success. A further loss is caused by the volatilisation of a large proportion of the soda.

**Reinforced glass** consists of plate glass in which wire netting is embedded. The glass is cast, and is treated by three rollers, the first of which spreads it into a sheet; the wire is laid over this and is embedded by the second roller, after which the third roller covers the wire with a film of glass and rolls the whole together.

The wire prevents the glass from falling, even when the latter is broken, and affords a good protection against stones and other missiles. It also enables the glass to afford a greater protection in case of fire and burglary.

For **figured plate** a pattern is cut on the bed or roller, and this is automatically transferred to the glass.

**Patent plate** is sheet glass manufactured in the ordinary way, but afterwards polished so as to remove the striæ which usually disfigure it slightly.

**Pressed glass** may be made in two ways: (*a*) the glass may be gathered on a pontil, placed in a mould and blown to shape as described on p. 256, or (*b*) the viscous glass may be dropped into a mould and squeezed to the desired shape by means of a plunger as in the Brühler machine (p. 257). Great accuracy is required to allow just the requisite quantity of glass to enter the mould. The hot article may be fire-polished by exposing it to the heat of a suitable blast burner, after which it must be annealed.

**Annealing** or cooling the hot glass under suitable conditions is an essential part of the process of manufacture, as glass which has been cooled too quickly is unstable, and may fall to pieces at any moment. As soon as possible after the article has been made it is, therefore, sent to the annealing chamber.

Two patterns of these are in use: in one the temperature of the oven is raised so as to be close to that of the glass placed in it, and it is then allowed to cool very slowly. In the other method of annealing, the goods are placed at one end of a tunnel or lehr and pass slowly through it until they reach the other end, when they are removed in an annealed condition. This is a more rapid and satisfactory method of annealing, and the temperature is under more complete control. It will, therefore, come into increased use in the course of time. Where glass is blown mechanically the output necessitates a lehr of large capacity, or some method whereby no time is lost in the process of annealing. For many purposes, the best form of annealing oven is a tunnel 90 ft. long by 6 ft. wide, with an endless band running through it. The bottles or other articles are placed on this band and travel through the oven in an automatic manner, the short time for correct annealing in such a lehr being surprising to those who are accustomed to the older type of cooling oven. Indeed, the introduction of large tanks for melting the glass (as in Siemens' regenerative furnace and its modifications), combined with the use of mechanical blowing and moulding machines, would have been useless had it not been for the almost simultaneous discovery of the tunnel annealing chamber.

**Hardened glass** is that which has been cooled very rapidly, so as to produce an exceptionally hard surface (see p. 245), but no method has been found which is completely satisfactory. The best results have been obtained with glasses of high melting point and low alkali content, that is to say, by regarding the hardness as related to the composition of the glass, rather than by endeavouring to treat ordinary glass so as to increase its hardness by physical means. The usual method of hardening glass is to plunge the hot material in oil, but a bath of molten lead and tin sometimes gives superior results.

Hardened glass is practically unbreakable, but if it is scratched it may suddenly fall to powder.

The **bending** of glass is effected by heating it sufficiently to make it soft. Glass tubes may be heated in an ordinary bating gas flame, rotating them carefully so as to secure uniform heating, and then bending them to the desired shape. Sheets of glass are bent by placing them on a bed of whiting or of iron covered with asbestos, and placing them in an oven hot enough to cause the glass to bend to the shape of the bed on which it is placed. Small pieces of glass are usually bent by the makers by holding them in the mouth of the furnace until the glass is sufficiently soft, and then bending it as desired. The secret of satisfactory bending consists in getting the glass of the right softness; it must not be overheated or it will lose its shape, nor irregularly heated or it will give a poor result.

The **cutting** of glass is usually effected by the glass-blower allowing a few drops of water to fall on the hot glass, or by touching it with a cold piece of iron. For cold glass a diamond may be used, or one of the hardened steel wheels now largely used as substitutes for glaziers' diamonds. It is sometimes convenient to make a scratch on the glass with a file, and then to bend it sharply until it breaks, or to draw an imaginary line from the scratch in the required direction, by means of an exceedingly small flame. The flame cracks the glass in its immediate vicinity, and with care the crack can be made to extend in any direction. Small sheets of glass can also be cut by immersing them in a bowl or tank of water and cutting them with scissors. It is necessary that the scissors and hands of the workman shall be fully immersed.

Technically, the term "cutting" relates primarily to the production of lines on the surface of the glass, these being made by means of a rapidly revolving steel disc or wheel, the edge of which performs the operation, being aided therein by sand or other abrasive. For the final polishing a wooden or cloth wheel and putty powder or whiting are used. For smoothing or grinding, wheels made of sandstone or emery are used, the glass and wheel being both kept wet during the operation. In some works a stone or corundum wheel is used for cutting, and some manufacturers prefer to finish the ware by dipping it in a mixture of hydrofluoric and sulphuric acids which leaves a polished surface.

**Ground glass** is made by rubbing the surface with sand or other abrasive and water, but acid sodium fluoride is also used as a corrosive, which acts more rapidly and uniformly than any abrasive. Sand-blasting is also used (see "Frosting").

**Engraving** is similar to cutting, but no abrasive is used, the work being usually done by copper discs revolving in a small lathe. Some engraved glass is extremely costly, and demands the exercise of the highest skill. Cameos are made by uniting two pieces of glass together, the white one forming the front is then cut away where it is not required, leaving a white relief design on a background of a different colour. Quite recently, the demand for very cheap cameos has resulted in the production of moulded designs which are fastened to background pieces with cement. Such a method lacks the accuracy and cannot produce the sharpness and delicacy of cameos cut directly from the glass, and is only useful for inferior work.

**Etching and embossing** are usually effected by means of hydrofluoric acid, which corrodes and dissolves glass exposed to its action. The glass must, therefore, be protected by a covering of wax or other insoluble material in those parts of the design which are not to be etched away. If "flashed glass"—*i.e.*, glass which has a film of glass of a different colour on its surface—is treated in this manner, the design can be in matt or transparent glass on a coloured ground or vice versa. A matt surface may also be produced by painting the appropriate parts of the glass with a mixture of hydrofluoric acid and ammonium chloride.

**Frosting** is usually effected by sand-blasting the glass so as to roughen the surface, then covering it with strong glue and leaving it in a warm room. As the glue shrinks it tears away sufficient of the glass to leave a frosted surface (see also "Ground Glass").

The use of the **sand-blast** in glass-working is very extensive, as it is rapid, cheap, and capable of application in a number of different ways. The process consists essentially in blowing a fine spray of sharp sand on to the surface of the glass, any portions requiring to be left polished being covered with a stencil through which the sand cannot penetrate. The minute angles on the grains of sand cut away fragments of the glass, leaving a surface which is remarkably uniformly roughened if the operation has been properly carried out.

**Iridescent glass** is made by producing tiny flakes on the surface of the glass, these flakes refracting and reflecting the light in such a manner as to produce the phenomena of iridescence. In antique glasses the iridescence is usually due to the prolonged burial, allowing time for the moisture in contact with the glass to have produced the necessary flaking as a result of corrosion. Iridescent glass is usually made by exposing the ware to the action of a 15 per cent. solution of hydrochloric acid under pressure, or by sprinkling stannous chloride on the edge of the furnace, and allowing the fumes to act on the glass.

## MIRRORS

In the manufacture of mirrors a specially made plate glass is used. It must be very free from defects, and if the mirror is to be made of silver the glass should have a faint bluish tinge to neutralise the yellow one due to silver. Two different processes of silvering are used in commerce: the old method in which a mercury-tin amalgam is used, and the newer ones in which silver is employed.

*Mercury mirrors* are considered to be undesirable from a hygienic point of view, and as silver is, at the present time, cheaper to use than mercury, the older type of mirror is gradually passing out of use. The mercury is applied by laying a sheet of tinfoil on a large wooden table provided with a bead or rim, and mercury is poured on to the foil. If necessary, the mercury may be rubbed into the tinfoil before the latter is completely immersed in it. When the mercury is about  $\frac{1}{2}$  in. deep the glass is laid on the mercury by placing the lower edge of the glass on the table and gradually pushing it forward, so as to avoid air-bubbles. When the glass rests on the foil (which is now a mercury-tin amalgam), the table is inclined and the excess of mercury flows away. The glass is now weighted so as to press the amalgam uniformly on to the surface of the glass and to expel any excess of mercury. After forty-eight hours, the glass may be placed vertically in a trough, and after a month the mirror will be ready for use.

A more recent method is Heydon's patent, in which the glass is painted with a paste made by suspending electrolytically atomised mercury in water or alkaline solutions. The mirror is ready as soon as the whole surface is covered uniformly.

*Silver mirrors* are prepared by precipitating metallic silver on the glass. This is a delicate operation, as the solutions used, when once mixed, are in a very unstable condition. A suitable mixture consists of (a) silver nitrate, dissolved in water, to which a little ammonia is added, the solution containing 1 per cent. of silver nitrate, and (b) a reducing solution made by dissolving 20 g. tartaric acid or Rochelle salt, with 20 g. white sugar and 4 g. silver nitrate in water, boiling for half an hour, filtering and diluting to 1 litre. Equal volumes of the silver and the reducing solutions are mixed immediately before use, and the glass is immersed in the solution.

It is essential that the glass surface to be silvered shall be cleaned very thoroughly and rinsed with alcohol. Then, without wiping or allowing it to dry, it should be immersed in the mixed solutions. After about an hour's immersion, the glass is rinsed with warm water and dried in a warm place. If properly made, the deposit will be firm enough to be polished with the ball of the hand. It should be protected with a layer of varnish.

Other similar solutions have been found to be equally satisfactory, the success of the silvering depending more on the skill of the operator than on the solutions used.

Various methods of depositing silver electrolytically on glass have been patented, but none of them has attained full commercial success as the film of silver is too thin to be sufficiently durable. One of the best means of overcoming this difficulty (French Patent, 444,710) consists in applying an electric current simultaneously to a large number of points on the film of silver, moving the cathode so that each particle of silver is in turn brought in contact with it, and thereby depositing a uniform backing of copper.

As the value of a mirror depends on the completeness with which the image is reflected from the surface of the mercury or silver, it is essential that this should form a film as bright and uniform as possible.

## OPTICAL GLASS

The production and working of optical glass differs in many respects from those previously described. Owing to the peculiar requirements of the makers of modern scientific instruments, far more attention has to be paid to the minor characteristics of optical glasses and, consequently, they are much more expensive than other forms of glass. Moreover, at least 60 per cent. of the glass made for optical purposes must be discarded on account of small defects, so that the amount of material made is out of all proportion to that actually entering into the finished instruments.

Defects which would have been overlooked a few years ago are now regarded as of sufficient importance to disqualify glasses for some instruments, and the enormous amount of research carried out by the leading firms of optical glass manufacturers has resulted in the production of glasses of a quality and power quite undreamed of a few years ago. The two chief difficulties with which the manufacturer of optical glass has to contend are the production of a "metal" of complete uniformity and freedom from specks, striæ, tensional and other strains, and the possession by the glass so produced of the requisite optical characteristics to enable it to be used in the instrument for which it is made.

The composition of most optical glasses resembles that of crown and flint glass, respectively, pieces of each of these glasses being used in combination in order

to produce the requisite refraction of the light, and to form an image free from distortion and rings of colour (*i.e.*, **anastigmatic** and **achromatic**).

Light from the blue end of the spectrum, when passing through flint glass, is dispersed more than that passing through crown glass, so that the older combinations were not entirely free from chromatism. The most recently made glasses of the best-known firms are, however, so adjusted by varying the composition of the glasses forming the combination of prisms or lenses as to reduce both dispersion and chromatism to the minimum. Thus the blue end of the spectrum is shortened by replacing some of the silica by boric acid. The use of baryta, magnesia, alumina, and zinc oxide also affects the optical properties of glasses.

The chief optical constants which determine the use of a particular glass are:—

(a) The refractive index for the sodium line (D) in the spectrum,  $=\mu_D$ .

(b) The mean dispersion for lines C to F in the spectrum,  $=\Delta$ .

(c) The ratio of refractive index to mean dispersion,  $\nu = \frac{\mu_D - 1}{\Delta}$ .

The refractive index is closely related to the specific gravity of a glass, and is varied by any changes in the latter. The dispersion varies with the composition of the glass, being lowest with glasses rich in boric and phosphoric acids, and highest in glasses rich in bases. Hence flint (lead) glasses are largely used on account of their high refraction and dispersion, but low ratio. If low dispersion and refraction are required, crown (alkali-lime) glasses are used, though they have a high ratio. Baryta glasses have a high refraction, a low dispersion, and a high value for  $\nu$ . Unfortunately, the optical properties of glasses and combinations are limited by the chemical stability of some of the glasses which can be produced. Thus boric and phosphoric glasses may only contain a small proportion of alkali; otherwise they are hygroscopic and soon become opaque. Some other possible compositions are useless because of their rapid devitrification.

Other qualities desired in optical glasses are:—

**Transparency and freedom from colour:** though the presence of small bubbles and of a decidedly greenish-yellow colour do not interfere with the use of some glasses as lenses, and technical perfection in the glass is often sacrificed to other optical properties and to cheapness.

**Homogeneity** or freedom from **striae** and other irregularities. It is important to test for these by examining the glass in a beam of truly parallel light, when the **striae** appear as alternating bands or lines. For many purposes inclusions and bubbles are less serious than **striae** (see "Defects," p. 260).

**Hardness**, so that the articles made from the glass will not be unduly spoiled by the ordinary processes of cleaning.

**Chemical stability**, in order that the glass may not devitrify or become opaque.

**Absence of internal strain**, so that there may be no undue distortion or tendency to fly to pieces. This is secured by careful annealing.

**Suitable refraction and dispersion.** The refractive index of most glasses lies between 1.4 and 1.9, as outside these limits the glasses are unstable. Several transparent minerals, such as fluorite, have much larger refractive indices.

The **manufacture** of optical glass consists in melting the ingredients which it is expected will produce a glass of the desired characteristics, a crucible with a cover (Fig. 2) being used for the purpose. The molten mass is freed from gall or scum from time to time, and is heated intensely so as to clarify it (p. 254). When test pieces indicate that the glass is satisfactorily clarified, the stirring is begun (p. 254), and is continued until the glass is almost solid, a fire-clay cylinder or a porcelain rod being used for this purpose. Usually the glass is then allowed to cool slowly, and when quite cold the pot in which it was melted is broken up and the best pieces of glass are selected for use or for remelting.

At the Jena works a more elaborate process of cooling is used, the glass being maintained at a temperature of 470°-570° C. for several weeks, and if the glass is required for very special work, such as large lenses, it is remelted and recooled several times, as many as ten such treatments not being unusual. Thus for the objective (36 in. diam.) in the Lick telescope, no less than twenty castings were necessary, and its manufacture occupied four years.

The difficulty of preparation and the enormous amount of experimental work required, particularly in the endeavour to make improvements in the glasses manufactured, make optical glasses of the best qualities exceedingly costly, and it is doubtful if it can be made on a large scale at a profit until melting pots of a much greater refractoriness and resistance to corrosion have been invented. These would enable much higher temperatures to be reached, and would greatly facilitate the manufacture of the glass. At present, electrical furnaces appear to be unsuitable (see p. 255).

## SPECIAL GLASSES

With the development of science, and its increasing application to practical and industrial matters, has arisen a demand for a number of different kinds of glass, each having one or more special properties in addition to those for which glass is generally known. These special glasses are conveniently considered separately.

For **chemical purposes** glasses are required which have a high degree of resistance to chemicals and to sudden changes in temperature.

Such glass is now manufactured by several firms, but was first made on a commercial scale in the famous works of **Schott & Abbe** in Jena, and sold under the term **Geräte glass**; its definite composition has never been published by the manufacturers, and some analyses which presume to give this information are by no means correct. It is, however, admitted to be a baryta glass containing boric acid and alumina, with little or no alkali. For English substitutes see p. 253.

For **steam boiler gauges** and similar purposes the **Schott Verbundglas** is specially useful, and has a resistance to chemical reagents which is five or six times as great as that of ordinary glass.

This glass is sold under the name **Durax**, and is a boro-silicate glass.

For lamp and gas-burner **chimneys** a glass of exceptional thermal endurance is required, as the heat from an incandescent mantle is exceedingly great.

The Jena works have therefore placed on the market chimney glasses made of a boro-silicate which is very infusible, and yet not sensitive to sudden cooling. This glass is reputed to have a composition corresponding to 66 per cent. silica, 24 per cent. boric acid, 4 per cent. antimonious acid and 6 per cent. soda. For an English substitute see p. 253.

Glasses which are **transparent to selected rays** are important in some surgical and other work. Thus, the ultra-violet rays are damaging to some eyes, but protection may be obtained by using glass such as that invented by Sir Wm. Crookes, which is impervious to the rays it is desired to avoid.

For use in mercury vapour lamps and other purposes, where it is desired to utilise the powerfully actinic ultra-violet rays, a glass invented by Zschimmer, and made at the Jena works under the term **Uviol glass**, is valuable. This glass is based on Zschimmer's discovery that the ultra-violet rays are stopped by metallic oxides in the glass, lead being the strongest, soda next, and potash the weakest in this respect as regards a boro-silicate glass. Sackur, on the contrary, has produced a glass which is opaque to all the photographically actinic rays by heating the glass with a mixture of sulphide and sulphate of silver. The silver is reduced to the metallic state and colours the glass brown.

For **electrical insulation**, a boro-silicate glass containing baryta and lime, but free from alkali, has been found by Schott to be highly satisfactory.

For **thermometers**, a whole series of special glasses are now made, according to the particular purposes for which the instruments are to be used.

Most glasses expand slightly on repeated use as thermometers, so that the instruments give a lower reading than they should do. This phenomenon is known as depression. It is most marked in glasses containing both potash and soda; glasses which contain only one of these oxides are better, but two of the glasses made at the Jena works are quite free from this defect. Glass 16 III. consists of 67.3 per cent. silica, 2 per cent. boric acid, 14 per cent. soda, 7 per cent. lime, 7 per cent. zinc oxide, 0.2 per cent. MnO, and 2.5 per cent. alumina. No. 59 III. consists of 72 per cent. silica, 12 per cent. boric acid, 11 per cent. soda and 5 per cent. alumina; it is very refractory, and is largely used for nitrogen thermometers for measuring temperatures up to 500° C. No. 16 III. is used all over Germany for the manufacture of thermometers and hydrometers. Moreover, it is easily worked in the blow-pipe on account of its content of boric acid and alumina.

**Artificial gems** are made of **strass** or **paste**, which is a dense lead (flint) glass with the highest available refractivity, and may be regarded as a special kind of optical glass. Most natural stones are crystalline, and cannot therefore be perfectly imitated by any amorphous glass. By cutting the glass so that it may have similar facets to the genuine stones, however, sufficiently good imitations may be made, though glass can never be as durable as true stones. The raw materials used must be specially purified, so as to obtain the greatest possible transparency, clearness, and freedom from colour, particularly for imitation diamonds.

A typical mixture consists of powdered quartz 100 parts, red lead 157 parts, caustic potash 54 parts, boric acid 5 parts, and white arsenic  $\frac{1}{2}$  part. These are mixed well together, melted in

a covered pot, carefully freed from scum or gall, and then stirred carefully and continuously until the metal is too stiff to stir any more. It is then annealed with great care, and the pot is eventually broken up and the fragments of glass are cut to the shapes desired. For coloured stones, the glass has added to it a small quantity of a suitable metallic oxide (p. 269).

Paste gems may usually be detected by their inferior hardness and by their lower refraction. Chemical tests can seldom be applied, as they would too seriously reduce the value of the gem if it were genuine.

During the past ten or fifteen years the production of gems of the same composition as natural ones, but prepared artificially, has been extensively developed. For these see separate article, p. 63, **Artificial Gems**.

## DEFECTS IN GLASSES

The chief characteristic of ordinary glassware is its transparency, freedom from colour and lustre. In the best modern glasses these properties are retained without difficulty under ordinary conditions, but the ancient glasses—which were necessarily rich in alkali in order to be of the requisite fusibility—suffer from a species of corrosion which is commonly termed **decay**. This is specially noticeable in the antique glasses preserved in museums and elsewhere.

The defects of glasses may be arranged in three groups, as suggested by Pazaureck :—

(a) Glasses which have been badly manipulated by the workmen engaged in their manufacture. Such glasses contain bubbles, inclusions of unmelted particles, particles of reduced lead, caused by stirring a flint glass with a wooden stick, striæ, and other signs of lack of homogeneity. Nothing can be done with such glasses when they have once been made into articles (see p. 260).

(b) Glasses which have decayed by exposure to unsuitable conditions. The most frequent cause of trouble in this respect is the too vigorous cleaning of the glass with strong detergents, such as caustic alkalis or mixtures of soap and fine sand. Some glasses will be corroded if left wet for a long time, as the water has a perceptible action upon them. As the interior of the glass is usually softer than the outside, owing to differences in the annealing, extensive abrasion of the outer film only increases the tendency to decay. Glasses should, therefore, be wiped quite dry and, if valuable, should be stored in dry and dust-proof cabinets.

(c) Glasses of defective composition, this being the cause of their decay. Such glasses will devitrify in course of time, or will develop colours which they did not originally possess. The development of a colour after exposure to intense sunlight, or to some of the more actinic rays produced in electric lamps, is often due to the use of insufficient decolorant (p. 250), but this is by no means invariably the case. The colour may sometimes be discharged by heating the glass to dull redness. The precise cause of this coloration has not been fully explained; it is not probably due to some rearrangement of the atoms within the glass molecule, brought about by the action of the light or other emanation. Some suggestions with respect to this will be found in the section on the "Constitution of Coloured Glasses" (p. 267).

Mattness or turbidity is sometimes due to the production of minute hair-cracks on the surface of the ware; this may be followed by spalling or flaking.

Cut glass tends to decay more rapidly than plain or moulded, as the cutting removes a portion of the harder external film and exposes the softer glass beneath. There is no remedy for this, as an effective reheating and annealing would destroy the beauty of the article by rounding the sharp edges of the design.

The decay of glass is not due to a contagious disease, as is often supposed by the ignorant, but to the fact that all glasses are slowly soluble in water, those which are rich in alkali being the most readily attacked.

## OPAQUE AND COLOURED GLASSES

The production of coloured glasses forms an important branch of the industry of glass-making, though most of the colours employed have been in use for many years, and some of them for several centuries.

The improvements which have made possible some of the most beautiful of modern coloured glasswares are, therefore, due to the use of pure colours, and of improvements in the manufacture of the glass itself, rather than to any striking discoveries in the form of new materials. An exception to this general statement may, perhaps, be found in the case of the selenium compounds, which will be mentioned later.

The question, "What makes certain glasses coloured?" is extremely difficult to answer. It is not sufficient to state that the colour is due to certain coloured silicates, unless the precise compounds are stated, and this is usually omitted, or



expressed in very indefinite language by writers on this subject. The reason is simple, and is due to the general conception of glasses as mixtures of various substances in a semi-fluid state, *i.e.*, in the state known as a "solid solution" (p. 241).

If, on the contrary, glasses are recognised as being definite chemical compounds (though like most commercial compounds they are not in a pure state), much of the difficulty of understanding their constitution is avoided; this is especially the case with coloured glasses. The difficulty of proving in a simple manner that glasses are really definite chemical compounds is, however, very great, as glasses do not all belong to one class of compounds, some being much more complex than others in their composition.

According to W. & D. Asch, most, if not all, glasses are composed of a series of ring compounds (p. 236), and at some of the points of combination various metallic oxides may be introduced into the molecule. These positions are marked with a + in the formulæ on pp. 237-239. It is these metallic oxides in combination with the immediate silica groups which form the chromophore or colouring agent. The structural formulæ of three important glasses—*porpora*, *copper ruby*, and *aventurine*—may be represented as shown on p. 268.<sup>1</sup>

Many facts hitherto inexplicable can be understood by means of such formulæ. Thus the formulæ show that only the *aventurine* contains free copper; this was proved by Wöhler who extracted the metal with mercuric chloride, and by Zulkowski who converted it into cuprous oxide by means of an ammoniacal solution of copper sulphate. Zulkowski has also proved that *porpora* and *copper ruby* glass contain no free copper when properly made. His researches also destroy the foundation for the view that the colour of these last two glasses is due to the glass holding metallic copper in solution. Bontemps, and, somewhat later, Seger found that many different colours can be produced from the same mixture by altering the conditions of firing, and particularly of the nature of the gases entering the crucible or glass-pot. This may be explained by regarding the atoms immediately connected with the copper in the compound as forming a chromophore group; if the glass is exposed to reducing conditions the oxygen is removed from this chromophore group and the glass is converted into a dark grey or black mass, but on treatment with an oxidant the red colour is restored.

It has long been puzzling to understand why so small a proportion of colouring agent could effect so large a proportion of glass. This fact is, however, a direct consequence of Asch's theory and formulæ, and a further consequence is that the maximum possible content of colouring oxide is definite and necessarily small; its amount for any metal is determined by the number of molecules which can be introduced into the formula at the points previously indicated. If analysis shows more copper (or other metal) than can be accommodated at these points, the remainder must exist in the free state (as in *aventurine* glass).

Whilst the application of this theory of the constitution of coloured glasses has not yet been applied individually to many of the products of English glass-works, the success met with on its application to glasses of German and French origin merits its further study in this country. It is not, of course, necessary that a coloured glass should consist exclusively of one kind of compound; on the contrary there is evidence that some coloured glasses consist of a coloured glass mixed with a colourless one. Seger's ruby glass made by adding 1 per cent. of copper to a glass corresponding to  $6\text{Na}_2\text{O} \cdot 0.6\text{CaO} \cdot 6\text{B}_2\text{O}_3 \cdot 30\text{SiO}_2$  appears to be of this kind, as the chromophore group can retain 4 per cent. of copper in the molecule.

Fortunately, the manufacture of coloured glasses has reached a high degree of perfection quite apart from any accurate knowledge of the chemical constitution of the glasses, for the colours can, in most instances, be formed by adding a suitable oxide to the glass mixture and then submitting the contents of the pot or crucible to such oxidising or reducing flames as experience has shown to be necessary. Two methods of colouring are used: the colouring agent is mixed with the whole bulk of the glass which is then known as **pot-metal colouring**, or a little coloured glass may be applied to the surface of the glassy mass, this being known as **flashing**. Flashing is obviously far cheaper in some instances than is pot-metal colouring, but with cheap colouring agents, such as iron, there is little difference in the two methods.

A third method of colouring glass consists in painting pieces of colourless sheet glass with more fusible glass to which suitable colouring agents have been added; this method is used for the **stained glass** employed for windows in churches, etc. After painting, the glass slips are reheated in a small muffle furnace so as to fuse the coloured glass without affecting the background on which it is painted.

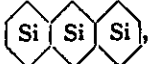
<sup>1</sup> It should be observed that each hexagon in the formula contains both silicon and oxygen atoms, the tri-hexagon, , being equivalent to  $\text{Si}_{18}\text{O}_{36}$ , as explained on p. 237.

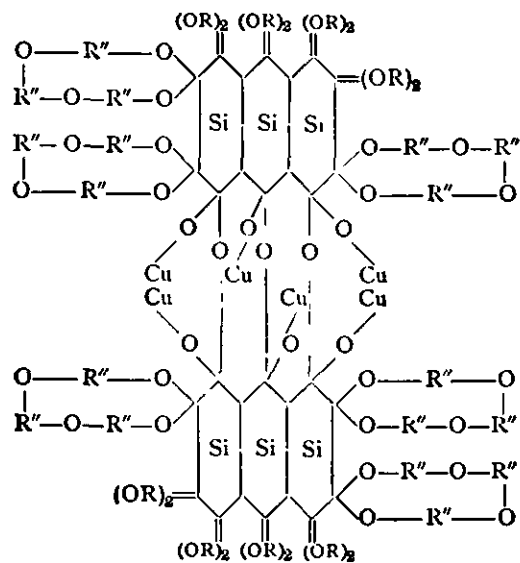
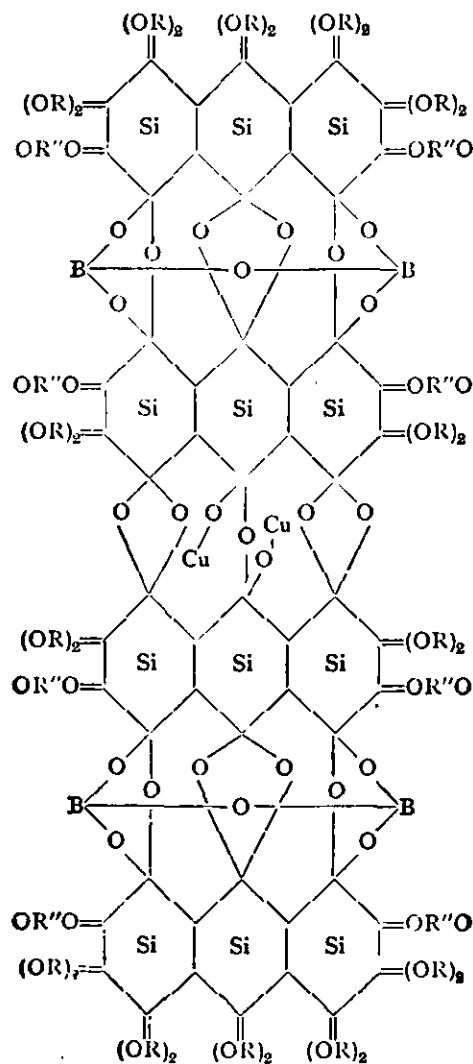
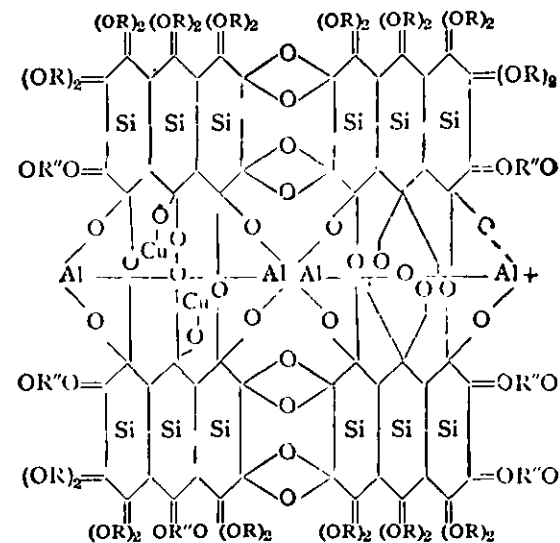
*Porpora Glass.**Copper Ruby Glass.**Aventurine Glass.<sup>1</sup>*

<sup>1</sup> Aventurine also contains a little free copper, distributed irregularly in the form of fine lamellæ. Some investigators attribute the characteristic appearance of this glass to these lamellæ.

The following colours are produced with the oxides named below :—

**Green glass** is usually produced by iron compounds, which form a variety of shades according to the form in which the iron is introduced. Magnetic oxide or a mixture of ferrous and ferric oxides produce the typical "bottle glass green"; purer ferrous oxide produces a bluish green; ferric oxide produces a yellow or yellowish green, the yellow tone being strongest in flint glasses. Under some conditions—possibly with reduction of the iron to the metallic state—a purple-red colour is formed.

Chromium oxide also produces green glasses, but they are more or less yellow if the conditions in the furnace are unfavourable. It is usually added in the form of potassium bichromate, and care must be taken not to add excess or it will render the glass turbid without giving it the desired colour. The so-called **chrome aventurine** is made by using an excess of chrome, which crystallises out in the form of minute green crystals, reputed to consist of chromic oxide. Copper oxide also produces beautiful green glasses, providing it is fully oxidised. Mixtures of chrome and copper were used for the green wine-glasses of the Romans.

**Blue glass** is sometimes made by adding copper oxide to a glass rich in silica and alkali, when a rich sky blue may be obtained, but the chief agent for the production of blue glass is cobalt oxide. So powerful is cobalt that 0.1 per cent. of it will produce a deep blue glass. The colour is changed to violet in the case of soda glass, and to sky blue in the presence of a little iron or copper.

**Violet glass** is usually made with manganese compounds, the composition of the glass affecting the colour; thus soda glasses are reddish violet, potash glasses are bluish violet, and so on. The colouring power of manganese is somewhat weak, and upwards of 6 per cent. is generally necessary. Manganese compounds are very sensitive to reducing agents, and their colour is generally discharged if the glass melt containing them is subjected to reducing gases. They are, therefore, a valuable means of decolorising some glasses. Nickel oxide produces violet glasses, but is somewhat uncertain; the best results appear to be obtained with potash-lead (flint) glass.

**Brown glass** may be produced by nickel in a crown glass, or by a mixture of manganese and iron oxide in other types of glass.

**Yellow glass** is commonly produced by means of iron compounds in the presence of an oxidant, such as manganese, by the addition of an excess of red lead, or by the use of uranium oxide. Finely divided carbon (charcoal) also makes glass yellow, especially in the presence of sodium sulphide. Sulphur compounds are valuable colorants, and the yellow glasses they produce are specially useful inasmuch as they are selective in action, and do not permit ultra-violet rays to pass through them. For this reason, they are valuable in glasses used for storing liquids which are sensitive to light, such as beer, solutions of silver salts, etc. Lead antimoniate is sometimes used for glasses with a yellow opacity.

**Black glass**, like black porcelain, is unknown; the nearest approach to it is a very dark violet or blue with some brown in it. Such a glass may be made by mixing cobalt, manganese, and iron oxides with the glass. A dark hyalite glass is also made by adding ferric sulphide to bottle glass; the sulphur and iron combine to produce a glass which, for many purposes, is sufficiently dark to be regarded as black.

In borax glasses, copper oxide and manganese dioxide give better results than manganese dioxide and cobalt.

**Pinkish shades** are frequently made by flashing with a thin film of red glass, but pot metal can be coloured pink with tellurium, or with selenium compounds.

**Red glass** may be made with either gold or copper as the colouring agent. An extremely small proportion of gold is necessary, and it is commonly understood to be in the form of a colloid or suspension of the metal, the particles of which are so fine as to be distinguished only by the ultra-microscope. Zsigmondy estimates their diameter at 0.00001 mm. One of the best methods of preparing gold ruby glass is to precipitate the gold with colloidal stannic acid, and to add this to the glass. A yellowish glass is usually formed at first, but on reheating it turns to ruby; the heating must then be stopped, as prolonged or excessive heating spoils the colour. Copper red glasses are of several kinds; three have already been mentioned, and their formulæ given on p. 268. The best results are obtained with a flint glass to which a small proportion of cuprous oxide, a little stannic oxide, and a reducing agent are added. The glass produced is almost colourless, but its colour is developed by reheating in a muffle.

**Silver stain** is a term applied to the yellow colour produced on glass which has been painted with a mixture of clay and silver nitrate and then heated in a muffle. The silver penetrates the surface of the glass and produces a permanent yellowish stain. This method is extensively used in the production of yellow signs on a transparent ground.

**White opaque glass** is made by adding an insoluble white oxide to the glass. There are several substances available for this purpose, the chief of which are cryolite, felspar, fluor spar, calcium phosphate (bone ash), tin oxide or even silica. The best opacifying media are those which dissolve completely in the molten glass but devitrify or crystallise out on cooling. The crystals must be extremely minute, and in many cases they are so small as to render it doubtful whether the opaque material is not amorphous. Tin oxide is an exception to the rule just stated, as it is an excellent opacifier, but does not dissolve in the molten glass to form a clear solution. The oxides of antimony and arsenic are also used as opacifiers. *Opal and alabaster glass* have a smaller

proportion of opacifying agent than the more opaque glasses, but otherwise they are of the same nature. **Milk glass**, such as is used for the backs of thermometers, on the contrary, may contain as much as 30 per cent. of the opacifying agent.

**Gilded glass** is an important feature of many articles imported from Bohemia. The gilding is effected by the use of a solution of gold in a special balsam, the mixture being sold by dealers in glass-makers' materials under the term "Liquid Gold." This solution is applied to the parts to be decorated, and they are then heated in a muffle furnace to a dark red heat. This produces a bright gilt which requires no burnishing. The same process is used in pottery manufacture.

**Uses of Coloured Glasses.**—The greater part of the coloured glass made is used in the form of fancy articles, though large quantities are also used in the form of sheet for windows and decorative work. Thin sheets of opaque white glass, cut to the size of bricks, are also largely used as a substitute for glazed bricks for the lining of operating theatres and other buildings where sanitation and cleanliness are of first importance. In many instances it would be better to use much larger sheets, and the success attained by these in a few instances is likely to lead to their extended use.

Articles for table or decorative purposes may have designs worked on or in them by means of coloured glass, applied by the maker during the process of blowing and working. Thus a small piece of opaque or coloured glass may be attached to a wine-glass in course of formation, and by twisting the coloured glass in various ways many intricate and pleasing designs may be produced in a simple manner. Some of the work done in this way by the ancient Venetians has never been surpassed either in the skill of the workmanship or in the taste displayed in the design used. The tendency at the present day is, however, to avoid these delicate designs and to apply the colour in larger and simpler masses.

A comparatively new use for coloured glass is in the production of tiles for walls or floors. These are known by various fancy names, Garchy's **Keramo** being one of the earliest of these terms. The material is made by heating broken glass until it devitrifies, and then more rapidly until it fuses sufficiently to bind the crystals together. The felt-like arrangement of the crystals produces a material as strong or stronger than tiles made of earthenware and of equally good appearance. By cutting the blocks of devitrified glass into irregular blocks and arranging them as a terrazzo or mosaic, an extremely handsome effect may be produced. The blocks may then be united by means of a mortar of powdered fusible glass, the whole being heated until this glass fuses, or Portland cement mortar may be used.

## QUARTZ GLASS OR FUSED SILICA GLASS

### LITERATURE

- J. BRONN'S "Elektrische Ofen in Dienste der keramischen Gewerbe und der Glas- und Quarzglas-zeugung." Halle, 1910.  
 J. F. BOTTOMLEY.—"Seventh Intl. Congress Applied Chemistry," II., 181.  
 C. COLNE.—"Metallurgical and Chemical Engineering," IX., 226.  
 ANON.—*Chemical Trade Journal*, XLVI., 61, LII., 104.

Modern facilities for the production of exceedingly high temperatures permit the fusion of materials at one time considered quite infusible, and amongst other substances now obtainable in commercial quantities, as a result of the existence of these facilities, is quartz or sand which has been brought to a state of semifusion, and, on cooling, forms a substance with many of the properties of a glass.

There is a considerable diversity of opinion as to whether such a material should be termed a "glass," inasmuch as it is a single oxide, and not produced by the fusion of an acid (silica) with a base (soda, etc.). Those who term fused silica a glass refer to its physical properties alone, whilst those objecting to this term do so on the ground of its chemical composition. If, however, glasses are regarded as definite salts of the acid  $H_2Si_2O_7$ , it is clear that the fused silica must be regarded as the anhydride of the same type of acid, which may be closely related to the glasses, but is yet chemically distinct from them. At the present time, however, there is a strong tendency in some scientific circles to regard the term "glass" as conveniently applicable to a number of substances with approximately similar physical properties—the chief of which is that they are amorphous and highly viscous substances obtained by the relatively rapid cooling of a fused mass. Such a definition has its uses, but it tends to cause confusion with the slags—which are widely different from the glasses—and with a number of other substances of an entirely different composition and origin.

"Fused silica" consists essentially of almost pure silica; though often termed "quartz glass" this is incorrect, for the word "quartz" relates to one of the crystalline forms of silica, and on fusion it loses its distinguishing properties, and is therefore more desirably known by a term indicative of its composition. For this purpose, "fused silica" is convenient and suitable.

It is not correct to represent the composition of this fused silica by the symbol  $\text{SiO}_2$ , as it is in all probability a polymerised form of silica for which the symbol  $(\text{SiO}_2)_x$  is more correct.<sup>1</sup> It is not at present possible, however, to state the numerical value of  $x$ , nor the number of silicon atoms in a molecule of either quartz or fused silica.

The glassy nature of fused silica has been known for many years, but the use of an oxy-hydrogen flame for its production was considered to be too costly a process, so that it is only recently that its valuable properties have been recognised.

The earliest recorded production of articles from fused silica is that by Gaudin in 1839, and this was followed in 1869 by Gautier who prepared capillary tubes from this material. The first in this country to recognise the value of fused silica was Professor Boys, who, in 1889, prepared fine threads of the material for use in the measurement of minute forces. In 1901, Shenstone exhibited a number of articles of fused silica in a lecture before the members of the Royal Institution, and in the following year Heraeus quite independently prepared a number of other articles from the same materials.

Since that time enormous progress has been made, and the following firms have gained a world-wide reputation for their products :—

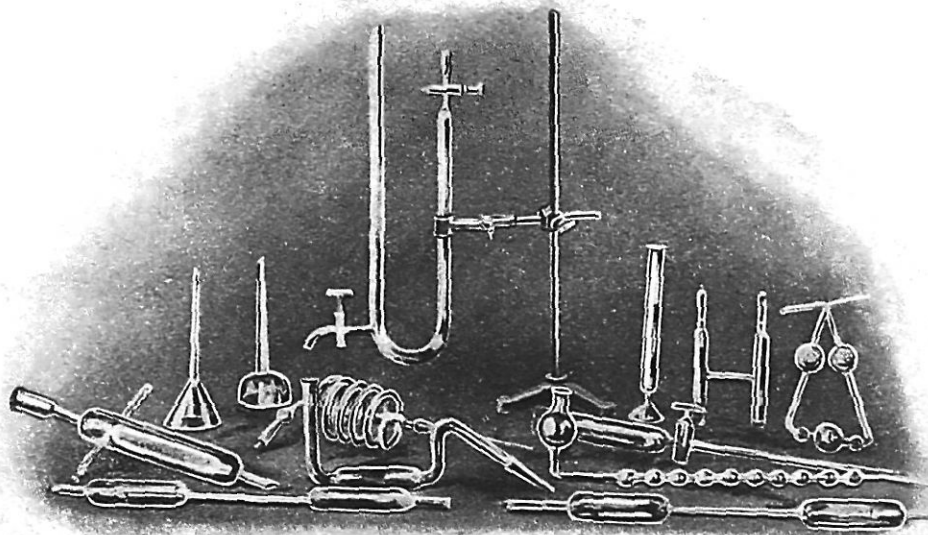

FIG. 12.—Apparatus made of Transparent Fused Quartz.  
(By courtesy of Messrs The Silica Syndicate Ltd.)

The Silica Syndicate Ltd., London, work in connection with an improvement of Shenstone's method, and produce a clear and transparent "glass."

W. C. Heraeus, G.m.b.H., Hanau, uses the method devised by Heraeus, and also produces a clear and transparent "glass."

Deutsche Quarzgesellschaft, m.b.H., Beuel on Rhine, uses Voelker's method (p. 273), in which a cloudy "glass" is produced.

The Thermal Syndicate Ltd., Wallsend-on-Tyne, use J. F. Bottomley's process (p. 273), and also produce a semi-transparent "glass."

Since their first inception, the methods of all these firms have been greatly improved, but for obvious reasons many of the improvements have been maintained as trade secrets, especially as regards the production of the largest pieces of ware. In any case, the production of such ware must be exceedingly difficult, as the

<sup>1</sup> This statement is a natural consequence of the hexite theory previously mentioned, but it has been confirmed experimentally by G. Martin (*Chem. News*, 1915, CXII., 61), who has shown that precipitated silica, when dehydrated, has the minimum formula  $\text{Si}_6\text{O}_{12}$  (see footnote on p. 238).

temperature required varies from  $1,700^{\circ}$ - $2,000^{\circ}$  C. Briefly, the four firms mentioned work as follows:—

In **Shenstone's process** (now obsolete) the quartz is heated to  $1,000^{\circ}$  C. and is then thrown into water; it is then reduced to a very fine state of division without the particles falling to powder. The loose mass is next heated in an oxy-hydrogen flame until the particles melt one after the other and form a solid mass of "fused silica." This mass is wrapped round a platinum wire, and the coils are heated in the oxy-hydrogen flame until they fuse together and a tube is formed.

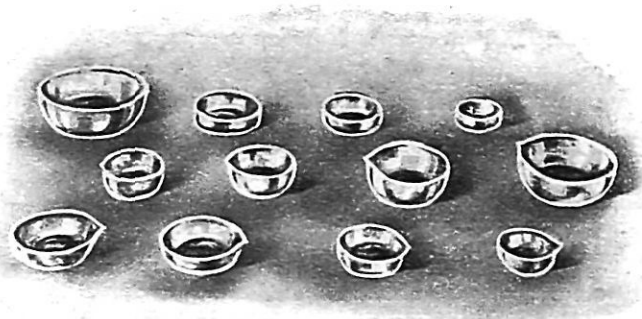

FIG. 13.—Evaporating Basins made of Transparent Fused Quartz.  
(By courtesy of Messrs The Silica Syndicate Ltd.)

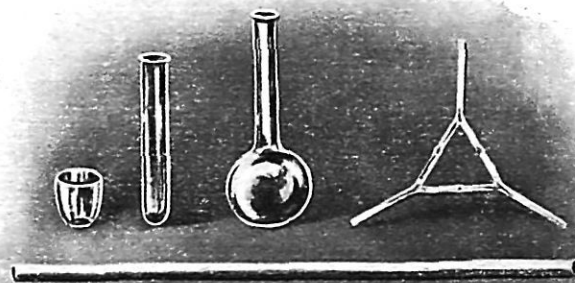

FIG. 14.—Apparatus made of Transparent Fused Quartz.  
(By courtesy of Messrs The Silica Syndicate Ltd.)

This tube forms the basis of all further articles which may be made, as it can be melted together at one end, blown into flasks, etc., and generally worked like glass.

The **Heraeus firm** heats quartz for some time at  $570^{\circ}$  C., which causes it to break up into small pieces, which are afterwards fused in crucibles made of iridium.

As this metal is costly and the crucibles are strongly attacked during the fusion, this method (like that of Shenstone's) is very costly. Quite recently this firm has patented the use of a mixture of zirconia and alumina for crucibles, and is using such a mixture at the present time. Carbon, lime, and clay crucibles cannot be used; the first reduces the silica to silicon, the second and last combine with the silica and form a slag-like material.

The fused material is worked like glass, and flasks of 50 c.c. capacity can be blown without any trouble. Means have also been found for casting the material

in iridium moulds so as to obtain hollow cylinders, which are afterwards blown and worked in the oxy-hydrogen flame.

This firm claims that it can produce in fused silica all articles which can be made in ordinary glass with an ordinary blow-lamp, provided that the dimensions desired are not too large. The largest article made by this firm in fused silica is, so far as the writer is aware, a tube 50 in. long and 2 in. diameter.

The **Quarzgesellschaft** and the **Thermal Syndicate** are able to work much more cheaply than those just mentioned, and the size of the articles they produce appears to be unlimited, coils of piping over 3 ft. high and basins 2 ft. in diameter, having been shown by the latter firm at the International Congress of Applied Chemistry in London in 1910. The Thermal Syndicate use pure quartzose sand, which is heated electrically by means of a specially devised furnace, one electrode of which is embedded in the sand, whilst the sand itself forms its own crucible, as that which is furthest from the electrode remains unfused. The material is never completely fused, but is raised to a state of semi-fusion, so that the material possesses the requisite mobility for it to be worked like glass. Like glass which has been imperfectly cleared, it is cloudy and only semi-transparent, being permeated with numerous bubbles, whilst the surface is very rough. The external roughness may, to some extent, be removed by grinding. The process of manufacture is protected by various patents, of which 10,670 and 18,434 (1904) are the most important.

This ware is known by the trade name of **vitreosil**, and has a pretty pearly lustre in the smoothest parts.

The numerous bubbles it contains prevents it being used for optical purposes and for photo-chemical work, and distinguishes it at once from the perfectly clear ware produced by the Silica Syndicate and the Heraeus processes, the latter being clearer than much of the glass used for laboratory purposes. In addition to its inestimable value in the chemical industries dealing with acids and other chemicals of a corrosive nature, **vitreosil** is useful for many decorative purposes, its pearly lustre being very charming and quite durable.

**Voelker's process** differs from that used by the Thermal Syndicate, chiefly in the construction of the furnace used; details are given in the Patent Specifications, 5,764 (1907) and 18,713 (1909). The fused silica is moulded in iron moulds, a hollow cylinder with one end closed being introduced into the latter, a pellet of wet paper is dropped into the cylinder, and the open end is immediately closed by pressure. The water in the paper immediately causes the production of huge quantities of steam, which exerts sufficient pressure to make the viscous mass fill the mould.

The **Quarzgesellschaft**, working Voelker's patents, claim that transparent fused silica can be produced by them under favourable conditions, though the bulk of their product is only semi-transparent and closely resembles **vitreosil**.

**H. J. S. Sand** (British Patent, 15,629, 1913) obtains quartz glass free from bubbles by enclosing the crushed or quenched crystal in a highly evacuated envelope, and melting the whole mass in the electric furnace.

Apart from the patent specifications, the best descriptions of the various methods of fusing silica will be found in Bronn's "Elektrische Ofen in Dienste der keramischen Gewerbe und der Glas- und Quarzglaserzeugung" (Halle, 1910).

The chief **properties** of fused silica are its complete resistance to **water**, **acids**, and **neutral solutions** (compare **Glass**, p. 246), the only exceptions being hydrofluoric acid and hot phosphoric acid, and their magnesium and ammonium compounds.

All **alkalis** attack fused silica, and **most metallic oxides** do so at a sufficiently high temperature.

Indeed, so sensitive is the clear fused silica to alkalis that the small proportion in human perspiration which is left by touching a clean piece of ware with the fingers and then heating to bright redness is sufficient to leave marks on the ware. For this reason, Heraeus recommends that all the ware should be rubbed with alcohol immediately before use.

Fused silica ware must not be heated in contact with asbestos, as it combines with it, but should be supported on triangles or other supports made of **vitreosil**.

At  $1,000^{\circ}\text{C}$ . fused silica ware becomes pervious to gases, though less so than platinum. At  $1,600^{\circ}\text{C}$ . it softens, and so is unsuitable as a container for substances to be heated above this temperature. Prolonged heating at  $1,200^{\circ}\text{C}$ . induces devitrification, especially in thin ware; short exposure to a much higher temperature will, however, do no harm in this respect.

Fused silica ware is chiefly characterised by its remarkable resistance to sudden changes in temperature; this is due to its exceptionally low coefficient of expansion. Consequently, silica ware may be made white hot and then plunged into cold water without being affected. The coefficient of expansion between  $0^{\circ}\text{C}$ . and  $1,100^{\circ}\text{C}$ . is  $0.5 \times 10^{-6}$ .

Thermometers made of fused silica are stated by Siebert and Kühn to be entirely free from all depression phenomena (p. 265); this is a natural consequence of the absence of metallic oxides, which, by their change of position in the less stable glasses, produce the alteration of the zero point in thermometers in which such glasses are used.

The density of the clear fused silica ware is 2.22; that of the vitreosil and similar ware is only 2.08, on account of the contained air-bubbles. Its refractive index for the D line is 1.4585 according to Abbé, and its dispersion (C-F) is 0.00676. For ultra-violet rays it is more transparent than any other glass—even than Uviol glass (p. 265)—providing that it is clear, but even a scarcely noticeable seediness renders it opaque to these rays. The use of clear fused silica ware in connection with the mercury vapour lamp by Heraeus has provided a source of ultra-violet light of remarkable intensity, and has greatly facilitated the study of photo-chemical reactions, such as the formation of ozone, sulphur trioxide, hydrochloric acid, etc., from their elements.

Considerable advances in making vacuum-tight seals for these silica glass vacuum vessels have been made by Dr Henry Sand of University College, Nottingham.<sup>1</sup>

This process, as worked by the Silica Syndicate, is as follows:—

A quartz tube is shaped as shown in the accompanying sketch, and a molybdenum wire placed loosely in position at A and a piece of lead at B. The air is expelled by means of a current of hydrogen and the glass closed at C. The air is then exhausted from D to a pressure of a few millimetres. The glass at A is now softened and pinched on to the molybdenum wire. The lead in B is then melted and allowed to filter into the space below, which has been highly heated. If necessary, this operation may be assisted by shaking and tapping the tube. The end C is now broken off while the metal is still molten, so that the atmospheric pressure forces it well against the surface of the glass. The tube may then be cut at E before the lead has solidified, and a tinned leading-in wire may be introduced into it.

When made in this manner the seals have, so far, never been known to fail. They have been fitted to cathode-ray tubes and mercury lamps.

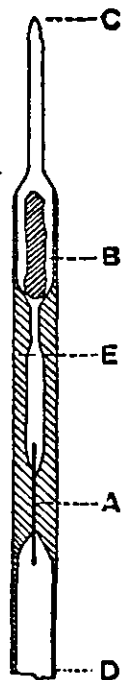

FIG. 15.  
Sand's Seal.

<sup>1</sup> H. J. S. Sand, "Vacuum-Tight Lead Seals for Leading-in Wires in Vitreous Silica and other Glasses," *Proc. Phys. Soc. of London*, Vol. 26, Part 2, Feb. 15, 1914.



## SECTION LXXIV

# ENAMELS

BY ALFRED B. SEARLE

### LITERATURE

- A. FISHER.—“Art of Enamelling on Metals.” London, 1906.  
 H. H. CUNYNGHAME.—“Art of Enamelling on Metals.” London, 1906.  
 L. F. DAY.—“Enamelling.” London, 1907.  
 P. EVER.—“Eisenaillierung.” Leipzig, 1907.  
 P. RANDAU.—“Die Fabrikation des Emails.” 4th ed. Vienna, 1909. A translation of the first edition was published in London in 1900 under the title, “Enamels and Enamelling.”  
 J. GRÜNWARD (trans. H. Hodgson).—“Enamelling on Iron and Steel.” London, 1909.  
 ——— “Iron Enamelling and Tinning.” London, 1912.  
 ——— “Raw Materials for the Enamel Industry.” London, 1913.  
 H. M. CHAPIN.—“How to Enamel.” London, 1911.  
 W. N. BROWN.—“Art of Enamelling.” London, 1913.  
 ——— “Principles of Dipping, Burnishing, and Lacquering.” London, 1914.

There are many patent specifications relating to enamels.

ENAMELS are, strictly speaking, opaque glazes, but the term is used somewhat loosely to indicate many materials which give a glossy surface to any articles to which they are applied. Thus the *japans* form one class of enamels whose basis is entirely vegetable (see “Industrial Chemistry: Organic,” p. 49), and the term **enamel** is extensively used with reference to a number of varnishes applied to articles with or without subsequent heat treatment. In other industries, and among those persons who are careful in the use of terms, the word enamel is only applied to substances to which a gloss is given in consequence of the particles composing the surface being heated to such a temperature that fusion has occurred, and a glass-like material formed. When used with even greater strictness, the word **enamel** relates exclusively to **opaque** substances of a glassy nature. Thus a coating of clear glass or glaze ought not to be regarded as an enamel, though much enamelled jewellery is of this kind, the metallic basis being obscured, but not hidden, by the intensity of the colour of the so-called enamel. The continual misuse of the word enamel, therefore, tends to confusion, and makes it necessary to refer to numerous substances which ought not really to be included under this title. These may be summarised as follows:—

**Vegetable enamels**, including lacquers and varnishes (“Industrial Chemistry: Organic,” p. 49).

**Paint enamels**, either of a cementitious character (*Sorel Cement*, p. 127), or of such a nature that they dry glossy instead of being dull.

**Glassy enamels**, such as are used for enamelled jewellery, etc., and consisting in reality of coloured glasses of very low melting point (highly boracic glasses).

**Glazes** (p. 178), which ought only to be termed enamels when they are opaque.

**True enamels**, or opaque glasses or glazes, made by covering the material to be enamelled with a suitable mixture, and heating both in a kiln until a glossy surface is obtained by the fusion of the glass or glaze. Such enamels are distinguished from stoved lacquers or japans by the fact that the former are of an exclusively mineral character, whilst the latter are of entirely vegetable origin. Only the true enamels are considered in what follows.

The raw ingredients of enamels are the same as those of glasses and glazes, with the addition of some opacifying medium (pp. 269 and 278). If the temperature at which the enamelling can occur is sufficiently high, opaque glasses may be used, though the difficulty of making these with precisely the same coefficient of expansion and contraction as the material to which they are applied is sometimes almost insuperable. Glazes—which are specially modified glasses—are therefore more suitable, as the constituents which they possess, in addition to those of the true glasses, are used with a view to overcoming this difficulty, a difficulty which is particularly great in the manufacture of enamelled iron ware.

The colours used in the production of enamels are the same as those used in pottery (p. 163), but as most enamelling on metal is done at relatively low temperatures it is often practicable to use a greater variety of colours than is possible for the potter, with the exception of what the latter uses in "overglaze" decoration (p. 180).

Broadly speaking, enamels are used for two distinct purposes: to improve the appearance of an article, and to give it an impervious and smooth surface. These two objects are not necessarily inseparable, so that in some cases enamels may be used for purposes of decoration (as on jewellery) which are not resistant to water, and soon decompose on exposure to wet and frost. By far the greater part of modern enamelled metal ware is made with a view to protecting the surface of the metal from the action of weather and water, and to enable the advantages of construction which are offered by iron and steel to be combined with the cleanliness and desirable surface-characteristics which are found in pottery. Much enamelled iron ware is, in fact, an attempt to produce "unbreakable pottery." Where this is the case it will be found, with few exceptions, that the true pottery is better than the enamelled ware, but in some cases pottery would appear to be unsuitable (as, for instance, enamelled iron saucepans) as it cannot be brought into direct contact with flame without being damaged. Decoratively-enamelled iron is often inartistic, and is open to the great objection that it appears to be something different from its true nature. Yet, in spite of these objections, there is an enormous field of usefulness for enamelled metal in the case of those articles where its strength, portability, and the facility with which it may be heated give it an advantage over other materials.

The dangers attending the use of enamelled metal for culinary purposes are seldom realised. Quite apart from the possible poisonous properties of the enamel itself—due to the use of lead compounds—there is a considerable liability to serious illness as the result of small chips of enamel becoming mixed with the food. The difference in the relative expansibility of the enamel and the metal beneath is always sufficient to cause a separation of the enamel after repeated changes in temperature. This is particularly noticeable in culinary articles, such as enamelled saucepans, and these ought not to be used when once any of the enamel has come away from the metal.

The characteristics required for enamels on pottery are practically the same as those for glazes (see p. 178).

The most important properties of enamel for iron and steel are:—

1. It must adhere well to the metal and show no tendency to leave it as by crazing (cracking) or shivering (peeling away).
2. The heat-treatment required by the ground coat and the subsequent coats must be such as to avoid the production of defects in the latter.
3. The enamel must resist the action of dilute acetic acid.
4. The enamel must contain no lead if used for domestic purposes.
5. The finished ware should have a pleasant appearance.
6. The cost of production should be sufficiently low to admit of a profit.
7. The enamel must be capable of being fired at under 1,000° C.

The production of ware covered with such enamels may be conveniently divided into four groups:—

*Cast-iron (sanitary and domestic) ware.*

*Sheet-steel and sheet-iron ware.*

*Ornamental and art wares.*

**Cast-iron wares** are usually large and heavy. The iron is rough in surface and contains numerous impurities which cause difficulties in the enamelling. Strength, with as much beauty as circumstances permit, is the chief feature.

**Sheet iron and sheet-steel wares** are usually small and light; the methods by which the sheets are manufactured gives the metal a smoother surface, and the impurities in it are less objectionable. Utility and lightness are the dominant features.

**Watch dials and art wares** do not require to be so accurately worked, as they are not subjected to the same conditions of strain as are the sanitary and domestic wares, and for the sake of brevity they may be considered as special adaptations of the methods applied to the latter.

The enamelling of metals differs from the glazing of pottery in one very important respect, viz., the potter may vary the composition of both his body and glaze, but the metal-worker cannot materially modify the composition of the metal he is called upon to enamel. It also differs in the fact that the enamelled metals must be brought directly out of the furnace and cooled rapidly, whereas pottery may be cooled as slowly as may be desired. These differences are important, as they necessitate the whole of the permissible variations being made in the enamel itself, there being but little variation possible in the firing temperature. The composition of the enamel is, consequently, of the greatest importance, and ability to adapt it to the requirements of the manufactured articles is absolutely essential to success.

**Mode of Manufacture.**—The surface of the iron or steel is cleaned by means of the sand-blast (or less satisfactorily by pickling), and to the clean metal is applied a ground coat whose chief function is to form a sticky surface to which the powdered enamel will adhere until it has been fused on to the metal.

Different manufacturers have each their favourite mixtures, but their chief ingredient is borax to which sufficient clay has been added to prevent it from flowing too freely. This ground coat is applied in the form of a thick cream or slip, which is dried by gentle heat and is then fused to a somewhat rough glass. Some manufacturers prefer to fuse this coat on before applying the enamel proper, but others consider this first heating to be unnecessary. It is, of course, of the greatest importance that this ground coat should adhere perfectly to the metal, as this is its chief purpose; its appearance is of minor importance.

As soon as the ground coat is fused, the ware is withdrawn from the furnace, and before it has time to cool it is covered with the powdered enamel, applied by shaking it through a sieve of moderate fineness. The ware is again placed in the furnace and kept at the correct temperature (which usually lies between  $980^{\circ}$  and  $1,000^{\circ}$  C.) until the enamel is properly fused. If the first coating of enamel is not sufficiently thick, a second or even a third must be applied. As soon as the enamelling is completed, the ware is allowed to stand in the open workshop until cool. Muffle kilns (preferably semi-gas-fired) are invariably used; each heating takes less than ten minutes.

**Materials.**—The metal used in the enamelled sheet ware must be of high quality, as it must not only stand the necessary shaping processes, but it must be free from sulphur and phosphorus in proportions likely to affect the enamels.

It is essential that it should have a perfectly clean surface, and if oil has been used in the shaping, it will usually be necessary to heat the unglazed ware in the muffle for a short time so as to burn off all the oil and grease. If the heating is continued a little longer it will oxidise the surface of the metal, and a subsequent pickling in acid will then serve to produce a clean metallic surface.

The enamels are usually of a complex composition, and frequently contain all the following ingredients:—Felspar, flint, clay, chalk, sodium carbonate, borax, cryolite, felspar, saltpetre, lead, glass, and a colouring or opacifying oxide. For decorative enamels lead may be used, as its poisonous action is not generally of importance in the purposes for which these articles are used.

Two chief types of enamels are used, their composition being represented by the following "molecular formulæ":—

For cast-iron ware (sanitary ware)—

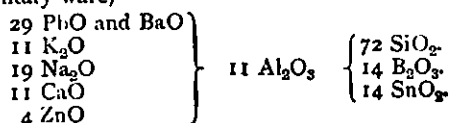

For sheet-steel ware (domestic ware)—

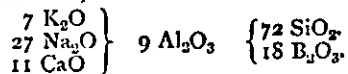

In order to obtain a composition as uniform as possible it is advisable to frit (p. 162) the ingredients of the enamels and to grind the fritted mass to a fine powder. The colours are the same as those used for pottery (p. 163), the "overglaze" colours being preferred, as they agree more closely in the temperatures at which they are to be fired. Opaque white enamels owe their characteristic appearance to the tin oxide used.

In such enamels, **soda** and **potash** may be replaced as desired, but the more potash the greater the brilliance of the enamel, as potash is almost invariably added as felspar. **Lime** appears to be essential, but too much of it makes the enamel too infusible. **Alumina** is added in the form of clay and felspar; it increases the adhesiveness of the enamel and reduces its fusibility. **Silica** is added in the form of flint, clay, and felspar; it hardens the enamel, but too little must not be used or the enamel will crack. **Fluorine** is added as cryolite, and is used to produce opacity and fusibility. **Borax** introduces both soda and boric acid; the latter behaves like silica, but it increases the fusibility of the enamel. It also increases its brilliance.

**Ground Coats.**—It is usually found that, providing an enamel possesses the necessary fusibility and appearance at the temperature at which the burning can be carried out, there will be little difficulty with regard to its composition. The crux of the enameller's work consists in forming a ground coat which will act as a suitable intermediary between the enamel and the metal. Indeed, this coat is the controlling factor in enamelled metal-work, and where failures occur it is almost invariably due to some error in the ground coat. The two properties essential in a ground coat are (*a*) the production of an adequate bond between the metal and the enamel, and (*b*) the suitability of the fusing point. It is now agreed that the ground coat must soften at a lower temperature than the enamels applied to it, but it must not flow at as low a temperature as any of the enamels. It must, therefore, have a long range of fusion. The colour of the ground coat is unimportant; it is usually dark, on account of the metal which it dissolves from the sheet. Some workers believe that an efficient ground coat must contain cobalt, but various experiments have shown that this is not essential, though often convenient on account of the affinity between cobalt and iron.

The composition of the ground coat may be varied within wider limits than that of the covering enamels, and is more difficult to adjust to suit the requirements of any given article. Limits widely recognised are shown in the following molecular ratios:—

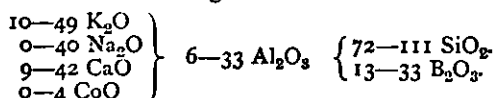

A composition introduced by C. H. Paris in 1850, and still extensively used, consists of broken glass, 130 parts; sodium carbonate, 20 parts; and boracic acid, 12 parts.

**Tests.**—The commonest test of the value of an enamel coating is to hammer it repeatedly. A really good enamel will resist many powerful blows, and where it fails it will pull off some of the steel with it. A poor enamel, on the contrary, will soon crack and peel off, leaving the clean metal below. Bending tests are sometimes tried, but they are unnatural and unfair. Heating tests—made by plunging the red-hot ware into cold water—are almost too severe, yet the best enamels will usually stand such treatment, though not repeatedly.

For domestic purposes, the ware may be tested by boiling dilute acetic acid in it. If the acid attacks the enamel, the latter will lose its gloss; the acid may also be tested to ascertain whether any lead has been dissolved from the enamel. (Strictly speaking, no lead should be used in enamel ware for culinary purposes.)

**Art Enamels.**—Art enamelling is almost invariably executed on gold, silver, or copper. It may be divided into four groups:—**Cloisonné**, in which small divisions or cells made of fine wire are soldered on to a metal basis (usually copper), these cells being afterwards filled with powdered enamels which are fused into position; **Champlevé**, in which the design is hollowed out of a metallic surface, the hollows being filled as in cloisonné; **Limogeic**, in which the enamels are melted direct on to the base without the use of cells or hollows; **pointed enamels**, in which the enamel is dropped on to the base in a semi-molten state, in a manner similar to that used in sealing a letter with wax.

The composition of these different enamels varies greatly, but they are chiefly mixtures of flint, red lead, and nitre, with sufficient borax to give the requisite fusibility, and at the same time prevent excessive crazing or cracking. A much-used recipe for Champlévé enamel consists of—

Flint	-	-	-	3 parts.
Borax	-	-	-	1 part.
Nitre	-	-	-	6 parts.
Red lead	-	-	-	6 „

For silver enamelling, some modification of the following recipe is extensively employed—

White lead	-	-	-	22 parts.
Nitre	-	-	-	17 „
Flint	-	-	-	15 „

Some enamellers of gold and silver start with borax, and modify this by the addition of flint, so as to prevent crazing, but the more complex mixtures just mentioned are preferable and more durable, and correspond closely with the enamels sold ready for use.

Designs may be painted by hand or printed on paper, and transferred as in the decoration of pottery (p. 180). Sometimes the design may be printed directly on the metal, the enamel being mixed with a mixture of oil and wood tar to make it adhere.

## SECTION LXXV

# THE ASBESTOS INDUSTRY

By F. W. PENNY, B.Sc., F.G.S.  
*Economic Geologist*

### LITERATURE

FRITZ ARKEL.—“Chrysotile Asbestos: its Occurrence, Exploitation, Milling, and Uses.”  
(Published in 1910 by the Mines Branch of the Canadian Department of Mines.)  
See also references in text.

**Definition.**—The term “asbestos” is a collective name of no definite mineralogical significance which has been applied to a variety of silicate minerals which differ from each other in chemical composition and physical properties, but resemble one another in their finely fibrous texture and flexibility—quite accidental properties due to the enormous elongation in one direction of the individual crystals that compose the aggregate. The value of these “mineralogical phenomena” depends on the facility with which they are capable of being split up into long and flexible fibres which can be spun like cotton and woven into cloth; on their resistance to the action of heat and acids, and on their non-conductibility with respect to heat.

All that has passed under the name of “asbestos” in commerce can be broadly classified either as fibrous varieties of the amphibole group of minerals, or as fibrous serpentine.

### AMPHIBOLE ASBESTOS

This group is of the lesser commercial importance, since the fibres are not much good for textile purposes on account of the lack of strength and flexibility. But they possess the advantage of being unacted upon by acids and are with difficulty affected by heat. They usually occur closely associated with pyroxene and hornblende rocks of the crystalline metamorphic series, as aggregates or bundles of closely compacted fibres traversing the rock in crevices or veins sometimes many feet in length. The varieties of amphibole asbestos are all anhydrous compounds of silica with an earthy base, and contain very little alumina. The following forms are recognised:—

- |                                  |   |   |   |   |
|----------------------------------|---|---|---|---|
| 1. Tremolite or Italian asbestos | - | - | - | CaO.3MgO.4SiO <sub>2</sub> .                  |
| 2. Actinolite asbestos           | - | - | - | CaO.3(Mg.Fe)O.4SiO <sub>2</sub> .             |
| 3. Anthophyllite asbestos        | - | - | - | 6MgO.FeO.8SiO <sub>2</sub> .H <sub>2</sub> O. |

Tremolite and actinolite asbestos are very similar, both being silicates of magnesia and lime, but the latter having some of its magnesia replaced by a molecular equivalent of ferrous iron.

The following is an analysis of typical tremolite asbestos:—

SiO <sub>2</sub>	-	-	57.2		CaO	-	-	-	13.4
Al <sub>2</sub> O <sub>3</sub>	-	-	.9		K <sub>2</sub> O	-	-	-	.3
Fe <sub>2</sub> O <sub>3</sub>	-	-	.5		Na <sub>2</sub> O	-	-	-	.6
FeO	-	-	2.7		Loss on ignition	-	-	-	2.4
MgO	-	-	22.8						

They are dull green to white in colour according to the amount of the iron present.

Tremolite asbestos has been mined since very ancient times in north Italy<sup>1</sup>—Val d'Aosta and Val Tellina on the southern slopes of the Alps. Only a small percentage of the fibre can be applied to spinning, and then usually mixed with cotton or fine copper wire, on account of its brittleness. Its chief use is in the manufacture of millboard, but a small proportion is exported (571 tons in 1912) and this fetches about £21 a ton.

In Eastern Canada the name actinolite is apparently applied to all asbestos fibres which are wanting in flexibility, independently of their chemical composition. Its value is about £3 a ton.

**Anthophyllite** asbestos differs somewhat from tremolite in chemical composition, all the lime being replaced by magnesia and a part of the magnesia by ferrous iron.

A typical analysis is the following:—

SiO <sub>2</sub> -	-	-	-	57.4	CaO -	-	-	-	.3
Al <sub>2</sub> O <sub>3</sub> -	-	-	-	1.4	K <sub>2</sub> O -	-	-	-	.3
FeO -	-	-	-	7.6	Na <sub>2</sub> O -	-	-	-	.6
MgO -	-	-	-	29.5	Loss on ignition	-	-	-	2.6

It has hitherto been chiefly recognised in the United States<sup>2</sup>—Georgia and Idaho—but there is little doubt that many of the occurrences in other parts of the world usually referred to tremolite will prove to be anthophyllite. It is little used commercially, the fibres being brittle and usually short.

**Crocidolite**, or blue asbestos, Na<sub>2</sub>O.Fe<sub>2</sub>O<sub>3</sub>.4SiO<sub>2</sub>+2FeO.SiO<sub>2</sub>, is a silicate of iron and soda; the following analysis shows its typical composition:—

SiO <sub>2</sub> -	-	-	-	52.11	MgO -	-	-	-	1.77
Al <sub>2</sub> O <sub>3</sub> -	-	-	-	1.01	CaO -	-	-	-	.75
Fe <sub>2</sub> O <sub>3</sub> -	-	-	-	20.62	Na <sub>2</sub> O -	-	-	-	6.16
FeO -	-	-	-	16.75	Loss on ignition	-	-	-	1.58

It is of no commercial importance at the present time since, although it occurs in long silky fibres which can be readily separated and spun, it is very inferior to all the other varieties in fire-resisting power, easily fusing in an ordinary gas flame to a black magnetic glass. It occurs in Griqualand West (N.W. Cape Colony<sup>3</sup>). In 1907 604 tons, valued at £9,060, were exported.

## SERPENTINE ASBESTOS

Chrysotile occurs in veins in serpentine rock, with which it is identical in composition, *i.e.*, hydrous silicate of magnesia, 3MgO.2SiO<sub>2</sub>.2H<sub>2</sub>O, with part of the magnesia often replaced by lime or ferrous oxide.

**Occurrence.**—Serpentine masses, with the included veins of asbestos, are to-day principally exploited in Eastern Canada. In the eastern townships of Quebec<sup>4</sup> the asbestos occurs in certain serpentine masses, running north-east from near Lake Mephremagog for about 150 miles.

In 1912 this district produced about 110,000 tons of asbestos, valued at over £600,000, representing roughly three-quarters of the world's output. A further occurrence—as yet of not much economic value—occurs to the north of Ottawa.<sup>5</sup>

Large serpentine masses, in similar association to the former, occur on the western coast of Newfoundland, but so far nothing beyond exploratory work has resulted.

In Russia asbestos occurs in the Urals. In 1911 nearly 16,000 tons were produced, the rock mined averaging about 14 lbs. asbestos to the ton. Up to the present, owing to economic reasons, only the higher grades of fibre have been exported, the sorted asbestos appearing on the market in an untreated condition like an asbestos concentrate. Recently, however, the idea has been mooted of erecting plant to manufacture the asbestos into textiles, etc., on the spot.

In the United States the southern continuation of the Lake Mephremagog serpentine belt

<sup>1</sup> Fisher, *Trans. Inst. Marine Eng.*, IV., 1892.

<sup>2</sup> Diller, U.S. Geol. Survey, *Bull.* 470, 1910, p. 519.

<sup>3</sup> "Tenth Annual Report of the Geological Commission for Cape Colony," 1906, p. 158.

<sup>4</sup> Dresser, *Jour. Can. Min. Inst.*, XIII., 1910, p. 414.

<sup>5</sup> Cirkel, "Chrysotile Asbestos," Mines Branch, Canadian Department of Mines, 1910, p. 37.

is being exploited in Vermont.<sup>1</sup> In 1912 about 4,000 tons, valued at about £16,000, were produced.

Chrysotile also occurs in Cyprus,<sup>2</sup> Queensland,<sup>3</sup> Western Australia—Pilbana district.<sup>4</sup>

**Preparation.**—The chrysotile occurs in gash-veins varying in width from mere lines to three or more inches across.

The veins are numerous, but they only form a small percentage of the rock mass in which they occur, and therefore the mining costs are somewhat higher than those of the other varieties of asbestos. But this is compensated for by the greater value of the chrysotile. It is stated for the Canadian mines that 100 tons of rock mined yield about half a ton of crude asbestos, and 5·8 tons of fibres.

Since the asbestos veins are of inconstant nature and quite irregularly distributed throughout the serpentine masses and hence difficult to locate underground, the chrysotile is always won by open quarrying. The rock is removed with the aid of machine drills in benches or steps, and a certain amount of the crude asbestos is at once obtained by hand-cobbing direct from the vein. But the fibre obtained in this way forms only a very small part of the output, the major part—in the form of smaller fibres—being separated from the serpentine by an elaborate mechanical process which allows of the rock being dealt with in turn by rock-breakers, driers, rotary crushers, rolls, “fibreisers” (in which the fibres are separated from one another), fans (which remove the fibres by means of air currents), and settling chambers, in which they are collected.

The products thus obtained are classified thus:—

*A. Crude Asbestos.*—Long fibre, usually in compact masses as it occurs in the veins. No. 1 grade, 1 in. or more long, valued £35 to £40 per ton; No. 2 grade,  $\frac{1}{8}$ – $\frac{3}{4}$  in., valued about £25 per ton.

*B. Short Fibre or Finest.*—Comprises the shorter asbestos obtained by mechanical separation from crushing the rock. Three grades are recognised: No. 1, spinning, valued at about £15 per ton; No. 2, spinning, and *paperstock*, so called on account of its use with vegetable matter in the manufacture of paper, worth not more than £4 per ton.

The average value of the whole output of Canadian asbestos for 1912 was about £5½ per ton; the low figure being due to the predominance of lower grades.<sup>5</sup>

**Properties: Chrysotile** is undoubtedly the most important variety of asbestos commercially, in spite of the disadvantage it possesses of being attacked by acids (especially H<sub>2</sub>SO<sub>4</sub>), and comparing unfavourably with the amphibole varieties in its fire-resisting qualities. Notwithstanding the large amount of water it contains in its molecule, the Canadian chrysotile is said to be able to withstand temperatures of from 2,500°–3,000° F., which is probably sufficiently resistant for most purposes. Its great value to the trade lies in the length and fineness of its silky fibres combined with toughness, tensile strength and extreme flexibility. The latter property has been proved by dehydration tests to be due to its combined water (about 13 per cent.).

Therein is its great difference from the nearly anhydrous amphibole asbestos. If dried for some hours at 120° C. and then dipped into a solution of a basic coal-tar dye, such as rhodamine, it is strongly coloured, thereby differing from the amphibole varieties. A typical analysis of the chrysotile asbestos is the following:—

SiO <sub>2</sub>	•	•	-	-	-	41.50
Al <sub>2</sub> O <sub>3</sub>	-	-	-	-	-	1.11
FeO	-	-	-	-	-	1.83
MgO	-	-	-	-	-	41.06
Combined water	-	-	-	-	-	14.37
						99.87

<sup>1</sup> U.S. Geol. Survey, *Bull.* 470, 1910.

<sup>2</sup> *Zeit. für prakt. Geol.*, Vol. XVIII., 1910, p. 340.

<sup>3</sup> *Proc. Royal Soc.*, Queensland, 1890-3, p. 120.

<sup>4</sup> *Cirkel, u.s.*, p. 236; and *Mining Journal*, Vol. LXXXVI., 1909, p. 394.

<sup>5</sup> *Can. Min. Jour.*, XXXIV., 19, p. 609.



## USES OF ASBESTOS

Both **amphibole** and **chrysotile** asbestos have their own uses to which each is well adapted, though the demand for the latter is always much greater than for the former.

Thus the stability towards acids of **tremolite** and **actinolite** asbestos enables them to be used as a filtering material for these corrosive liquids; their good fire-resisting qualities render them quite suitable for use in gas fires. In the manufacture of fireproof objects for the protection of life and property (such as fireproof curtains for theatres, clothing for firemen, ropes for escape from burning buildings, etc.) the **chrysotile** is employed, since tremolite and actinolite asbestos are not sufficiently flexible to be woven, and crocidolite much too fusible. In its extensive employment as a non-conductor of heat, the stability towards heat of asbestos gives it an advantage over other substances—except mica and diatomaceous earth. For packing valves, covering steam-pipes and cylinders, the asbestos, which in the crude form does not rank very high among non-conducting materials, has to be worked up and felted or woven into yarn or rope, thereby increasing the air space included and so the non-conductibility.

Unless liable to come into contact with acids, chrysotile is the most suitable for these purposes on account of its superior softness; but the Italian fibre is very generally employed in the manufacture of millboards for packing the joints of steam-pipes. Inferior grades—short fibre and meal—have become much used for the preparation of all kinds of fireproof material such as flooring slabs, cement slates, composition (paint), and wall plaster. The finer qualities are employed in giving weight to silk, and various other forms of adulteration. The waste asbestos is mixed with powdered serpentine and made into a product known as “asbestic,” a material largely employed in fireproof buildings (see p. 134).

## SECTION LXXVI

# THE MICA INDUSTRY

BY F. W. PENNY, B.Sc., F.G.S.

*Economic Geologist*

### LITERATURE

ADAMS and BARIOW.—Memoir No. 6, Geol. Survey, Canada, 1910.  
 SCHMID.—“Mica.” Report No. 118, Canadian Dep. of Mines, 1912.  
 Also references in text.

**Occurrence.**—Mica is one of the most widely distributed of minerals. It occurs in the form of small scales and plates in the majority of igneous and metamorphic rocks and in many of the products formed from their decomposition. But the mica of commerce is practically confined to the two of these varieties—**muscovite** and **phlogopite**.

Large plates of **muscovite** are almost entirely restricted to those dykes or veins known as **pegmatite** which are usually associated with great granite masses. The commercially valuable mica occurs in rough tabular or tapering six-sided crystals known as “books,” from the facility with which they can be opened up into thin leaves; they vary from a few inches up to several feet in diameter.

Muscovite has been worked principally in India and the United States.

From Eastern Canada comes the world's supply of **phlogopite** mica, which has quite a different genesis. It occurs associated with dykes of basic rock, generally pyroxenites. The mica occurs quite irregularly in pockets, sometimes joined by narrow fissures having no definite direction.

Owing to the impersistent nature of mica deposits, there are few rules or indications by which the miner may be guided. But the mica found at the surface is nearly always soft and cracked, due to the action of weathering and surface movements; clearer and better coloured mineral is found lower down in the solid rock, *i.e.*, the quality improves with the depth.

**Species of Mica.**—The term mica includes a number of allied mineral substances which are characterised by great flexibility, high flexibility, and elasticity in thin films, a hardness of from 2 to 3 (capable of just being scratched with a dry finger-nail), and transparency when in thin plates. The principal species of commercial importance are:—

(a) **Muscovite** or potash-aluminium mica: composition normally—



specific gravity, 2.85.

Typical analyses give the following as the average percentage composition of this species<sup>1</sup>:—

Silica, SiO <sub>2</sub>	-	-	-	-	-	45 to 47 per cent.
Alumina, Al <sub>2</sub> O <sub>3</sub>	-	-	-	-	-	30 „ 37 „
Ferric oxide, Fe <sub>2</sub> O <sub>3</sub>	-	-	-	-	-	0.5 „ 5 „
Ferrous oxide, FeO	-	-	-	-	-	0.5 „ 2 „
Magnesia, MgO	-	-	-	-	-	0 „ 2 „
Potash, K <sub>2</sub> O	-	-	-	-	-	8 „ 11 „
Soda, Na <sub>2</sub> O	-	-	-	-	-	0 „ 2 „
Water, H <sub>2</sub> O	-	-	-	-	-	4 „ 6 „
Fluorine, F	-	-	-	-	-	0 „ 1 „

<sup>1</sup> *Bull. of Imperial Institute*, Vol. II., 1905, p. 279.

If the percentage of the iron oxides rises above 5, muscovite becomes distinctly tinted when plates thicker than 0.5 mm. (0.02 in.) are viewed by transmitted light.

(b) **Phlogopite**, or magnesia mica, approximates to—

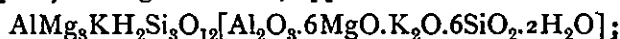

usually contains some fluorine; specific gravity, 2.75.

The percentage composition is usually within the following limits:—

Silica, $\text{SiO}_2$	-	-	-	-	-	39	to	44	per cent.
Alumina, $\text{Al}_2\text{O}_3$	-	-	-	-	-	13	„	15	„
Ferric oxide, $\text{Fe}_2\text{O}_3$	-	-	-	-	-	0	„	2	„
Ferrous oxide, $\text{FeO}$	-	-	-	-	-	0	„	1.5	„
Magnesia, $\text{MgO}$	-	-	-	-	-	26	„	29	„
Potash, $\text{K}_2\text{O}$	-	-	-	-	-	8	„	10	„
Soda, $\text{Na}_2\text{O}$	-	-	-	-	-	0.4	„	2	„
Water, $\text{H}_2\text{O}$	-	-	-	-	-	1	„	5	„
Fluorine, $\text{F}$	-	-	-	-	-	1	„	5	„

As a rule, phlogopite is coloured more deeply than muscovite by the presence of the same proportion of iron oxides. When the total amount exceeds 5 per cent., a plate only 0.1 mm. (0.004 in.) thick is distinctly tinted. When the percentage of iron is under 2, the phlogopite shows a pale yellow colour in a thickness of 0.1-0.5 mm., the colour passing to an amber shade with thicker plates. This is the variety known to the trade as **amber mica**.

(c) **Lepidolite**, a lithia-bearing mica of variable composition, in most cases a mixture of a fluoriferous trisilicate,  $\text{AlF}_2\text{Si}_3\text{O}_8 \cdot \text{R}'_3$  (in which  $\text{R}' = \text{Li}, \text{K}$ ), with molecules of the muscovite type. It is characteristically of a pink or mauve tinge.

It has a very limited use for the production of lithium salts, largely used in the manufacture of lithia water since it contains theoretically about 4 per cent. of lithium.

It is important to be able to distinguish phlogopite from muscovite, and this is easily done with a polarising or petrological microscope. A plate should be peeled until it is as nearly as possible 0.25 mm. (0.01 in.) in thickness; it should then be rotated between crossed nicols. A plate of muscovite under these conditions shows bright colours, whilst one of phlogopite allows only a faint greyish-white light to pass.

Small crystals of mica have been produced in the chemical laboratory at the expense of other minerals (by fusing such natural silicates as hornblende, garnet, or angite with an alkali fluoride at a dull red heat). But the natural crystals undoubtedly required enormous periods of time to form, in conditions which are impossible of reproduction by human agency. Therefore it is unlikely that it will ever be practicable to manufacture sheets of commercially valuable mica.

**Manufacture.**—Mica is usually exploited by open quarrying, waste rock being loosened by very light blasting (hand-drilled holes not more than 4 ft. deep and charged with ordinary powder), and the crystals being taken out with crowbars and chisels.

In a typical Canadian mine about 150 ft. deep the cost of producing a ton of mica from 1 × 3 in. in size upwards is about £36½.

The rough crystals have first to be split into sheets  $\frac{1}{8}$ – $\frac{1}{16}$  in. in thickness, done by hand with short-handled knives, and at the same time all loose and broken edges are torn off with the thumb and forefinger, a process known as “thumb-trimming.” The thumb-trimmed sheets are next cut by hand machines—usually at special works—into rectangular form, so as to yield the largest superficial sizes whilst avoiding all striations, marginal cracks, and other faults. Plates which are broken, unevenly laminated, striated, crumpled, cracked, or much stained are useless, and should be discarded.

As a general rule not 10 per cent. of the mica mined is capable of being cut into sound rectangular plates of size not less than 2 × 3 in. or 4 × 1 in., which are about the economic size-limit. In Canada it is reckoned that 3 tons of scrap mica, yielding 750 lbs. of thumb-trimmed material, must be raised for every 100 tons of rock removed from open quarries; for underground mining (up to 300 ft. deep) 5 tons, yielding 1,250 lbs. of thumb-trimmed mica, must be extracted to make it pay.

The balance of scrap or waste mica is sold for conversion into **ground mica**.

The operation of grinding mica to a fine powder is a rather difficult one to carry out owing to the fact that the mineral has a single perfect cleavage, and cleavage-lamellæ are very smooth, tough,

and elastic. In most cases the details of the processes are kept secret, but a certain amount of information can be obtained from Schmidt, *loc. cit.*, pp. 307 *sqq.* The fineness required for industrial purposes is up to 160 meshes to the inch.

**Uses.**—The uses of sheet mica can roughly be divided into two classes, the first comprising those for which a substance is required that is transparent and impervious to heat—for lamp chimneys, furnace windows, etc.—and the second consisting of those connected with the construction of electrical machinery. For the former purposes muscovite is generally employed, since the material must be clear and transparent. The best kinds show a faint ruby tint in plates approaching a millimetre (.04 in.) in thickness; the plane of cleavage must be quite true and it must be perfectly fissile, films 0.01 mm. (.004 in.) being produced without much difficulty. It must be flexible and elastic in fairly thin laminæ; for instance a plate 0.01 mm. thick would bend without cracking or appreciable buckling round a cylinder 25 mm. (1 in.) in diameter, and on being released after half a minute should regain as nearly as possible its original plane surface. The lustre must be “splendent,” that is to say equal to that of highly polished glass. The standard sizes for the purposes stated above range from  $1\frac{1}{2} \times 2$  in. to  $8 \times 10$  in.: smaller sizes seldom pay for mining and preparation.

Formerly the chief value of mica was for this class of work, but recently a number of very resistant glasses have been put upon the market and these tend to restrict its use in these directions. However, by far the most important use of mica nowadays is in the construction of electrical machinery.

**Phlogopite** has here been found to be the most satisfactory form on account of its incombustible and insulating powers and also because of the fact that for the construction of commutators of direct-current motors and dynamos (which are built up of bars of copper and strips of mica) the phlogopite has about the same hardness as the copper of the commutator segments, and therefore wears down evenly without causing the machine to spark.

The colour of the sheets is of little moment, but very dark mica is not likely to be of much value owing to the iron it contains rendering it useless for insulating purposes, a fairly low percentage of iron being an essential for the latter. Perfect cleavage is of the highest importance, as “electric mica” must be of uniform thickness and is often gauged to the one thousandth part of an inch. The sheets must be absolutely free from cracks, for it is obvious that even microscopic cracks would militate against a material being used as an electric insulator. Lastly, a perfectly flat surface must be secured on splitting the mica into sheets, as mica with “metallic insertions” or “hydration lumps” is useless for insulating.

The sizes most favoured are  $2 \times 4$  in. and  $1 \times 3$  in., or long strips up to  $1 \times 6$  in., but there is nowadays a big demand also for the smaller-sized sheets ( $1 \times 1$  in. and  $1 \times 2$  in.) for the purpose of making micanite, a material built up of small and inexpensive plates about .005 in. in thickness, with an insulating cement such as shellac to form non-conducting sheets on a foundation of longcloth or paper, the made-up material being finally subjected to great pressure under heat to dry out the shellac.

Lastly, a large variety of uses have been found for the ground mica—the finer grades (160 mesh) of muscovite can be mixed with a solution of gum arabic for making a good silver paint; or for producing bronze-like colours which are lighter than metallic bronzes and are not so liable to be tarnished; also for imparting a lustrous appearance to wall-papers, etc. Mixed with shellac or special compounds, the coarser grades can be moulded into desired forms and find employment as insulators for wires carrying high-potential currents: for this purpose the ground mica must be rendered free from metallic particles. It is used in combination with grease, graphite, or oils as a lubricant for axles and other bearings—for which purpose it must be freed from gritty matter. Another application is its use in place of kieselguhr as an absorbent of nitro-glycerine, the explosive thus formed being known as mica powder. But probably a more important use, in connection with scrap mica, is as a non-conductor of heat, especially for packing, and jackets for boilers and steam-pipes, since it will stand any abnormal heating, is practically

free from moisture and acids which attack iron and steel, and if moisture leaks in, the mineral is completely unaffected by it.

**Production.**—The demand for larger mica has increased steadily for some years with the advance of electrical requirements. On the other hand the supply from some of the older localities (Madras) is decreasing owing to the depth to which the mines have already been worked. Localities where in past geological ages the special conditions requisite for the formation of large and uncracked crystals of suitable mica existed, are of limited occurrence, and new ones are not being quickly discovered.

The chief mica-producing countries at the present day are India, Canada, and the United States.

In India the production comes mainly from the Hazaribagh district of Bengal (57 per cent.) and the Nellore district of Madras (31 per cent.).<sup>1</sup> In the former area the industry has been in existence for very many years, while in Nellore mining commenced as recently as 1892. The mica mined is exclusively muscovite, and the following are the principal classes recognised:—

“Bengal Ruby,” and “Madras Ruby,” the latter not having such a good plane of cleavage, but greater fissility than the former.

“Bengal Yellow,” less common, but equally valuable.

“Madras Green Clear,” liable to crack when manipulated.

“Bengal White,” “mealy,” *i.e.*, cloudy from incipient decomposition or interlamellar inclusion of gas; it is softer than the ruby mica.

“Madras Green Hydrated” is softer than the ordinary green mica from that place.

The production from India in 1910 was as follows:—

Bengal	-	-	-	-	-	2,055,872 lbs.
Madras	-	-	-	-	-	401,632 „
Rajputana	-	-	-	-	-	84,784 „
						2,542,288 lbs., or 11,354 tons.

The value in 1910 was £177,152, whilst that for 1911 was £188,642.

From Canada comes phlogopite mica, usually amber-coloured, rarely colourless in thin plates. Since it is used mostly for electrical purposes, the amount of colour is not important, though the darkest varieties are as a rule poor splitters. The best kinds are classified into “light amber,” “dark amber,” and “silver amber,” the latter being the predominant quality produced. The lightest-coloured varieties are not favourably regarded, being as a rule more brittle and less elastic than the “silver amber” mica. In 1912 Canada produced 318 tons of mica in Ontario, and about 850 tons in the Gatineau and Lievre rivers district of Quebec, about a third of the world's output.

The United States in 1911 produced about 380 tons of rough-trimmed and cut mica, chiefly from North Carolina and New Hampshire, and about 3,500 tons of scrap mica, in value about a seventh of the output.

The following countries also contribute a little to the world's supply:—Ceylon,<sup>2</sup> from which clear amber-coloured phlogopite comes; Brazil,<sup>3</sup> where the occurrence is muscovite and apparently very similar to that in India; German East Africa,<sup>4</sup> and Japan. The United Kingdom in 1912 produced 29,962 tons, obtained as a by-product in the preparation of china clay in Cornwall and Devon.

**Value.**—The micas of commerce are usually divided into three qualities for valuation purposes: “clear”—being quite free from spots; “slightly stained”—having, say, one or two stains in four square inches, and “stained” or “spotted.” It has been stated that “slightly stained” mica is worth about half the price of “clear,” other things being equal; and the “stained,” a quarter in the case of small plates and an eighth in the case of large plates.

It is not possible to give absolute prices of manufactured sheet mica from the lists of the dealers, since discounts allowed vary with the nature of the purchases. The prices of the sizes given in the table below are quoted from a standard list for 1911. Discounts ranging from 70-10 per cent. are allowed on the stove mica, and from 60-10 per cent. on the electric mica.<sup>5</sup> The relative values of the various sizes can anyhow be seen.

<sup>1</sup> Holland: *Mem. Geol. Survey, India*, XXXIV., 1902.

<sup>2</sup> Ceylon Administration Reports, 1903; “Mineral Survey of Ceylon.”

<sup>3</sup> *Trans. Inst. Min. Met.*, Vol. XII., p. 357, 1902-3.

<sup>4</sup> See Schmid, p. 46.

<sup>5</sup> “Mineral Resources of the United States,” 1910, p. 919.

Stove Mica.		Electrical Mica.	
Size.	Price per Lb.	Size.	Price per Lb.
In.	\$	In.	\$
1½ × 2	1.20	1 × 3	1.75
2 × 2	2.00	1 × 6	5.50
2 × 3	3.50	1½ × 4	2.75
3 × 3	5.75	2 × 4	3.50
3 × 4	7.00	2 × 7	7.25
4 × 6	9.50	3 × 9	11.00

The value of **ground mica** (amber) at the factory ranges from \$20 to \$30 per ton of 2,000 lbs. according to fineness and quality [c.i.f., New York, from \$45 to \$75 a ton]: for ground white mica \$36 per ton for 40 mesh, and \$46 per ton for 200 mesh can be obtained.

**Scrap amber mica**, free from rust and gangue, can be bought for about \$5 per ton, and scrap white mica for about \$8; but that obtained as a waste product in the preparation of sheet mica fetches a better price than mica which is mined directly in the scrap condition, owing to its greater degree of purity.

## SECTION LXXVII

# THE THORIUM AND CERIUM INDUSTRY

Including the Manufacture of Incandescent  
Mantles and Pyrophoric Alloys

BY SYDNEY J. JOHNSTONE, B.Sc. (Lond.)

### LITERATURE

- C. R. BÖHM.—“Das Gasglühlicht.” Leipzig, 1905.  
 — “Die Fabrikation der Glühkörper für Gasglühlicht.” Leipzig, 1910.  
 — “The Manufacture of Mantles for Incandescent Gas Lighting.” *Journ. Gas Light*, 1913, 121, 33, 100, 181.  
 E. WHITE.—“Thorium and its Compounds.” Inst. of Chem., London, 1912.  
 SYDNEY J. JOHNSTONE.—“Monazites from some New Localities.” *Journ. Soc. Chem. Ind.*, 1914, 33, 56.  
 H. KELLERMANN.—“Die Ceritmetalle und Ihre Pyrophoren Legierungen.” Halle a/S., 1913.  
 GEOFFREY MARTIN.—“Pyrophoric Alloy Industry.” *Chem. World*, 1913, 2, 288.  
 C. R. BÖHM.—“Die Verwendung der seltenen Erden.” Leipzig, 1913.  
 J. H. COSTE and W. E. F. POWNEY.—“The Testing of Incandescent Mantles.” *Journ. Soc. Chem. Ind.*, 1911, 30, 65.  
 C. R. BÖHM.—“Die Darstellung der seltenen Erden.” Leipzig, 1905.  
 H. KELLERMANN.—“Die Darstellung des Metallic Cers und seine Verbindungen.” Berlin, 1910.  
 A. HIRSCH.—“Preparation of Metallic Cerium.” *Journ. Indus. and Eng. Chem.*, 1911, 3, 880.  
 NICOLARDOT.—“Les Terres Rares et l'Éclairage à l'Incandescence.” *Bull. Soc. d'Encour.*, 1910, 109, 436.  
 V. B. LEWES.—“Gas Mantles.” E. Thorpe's “Dictionary of Applied Chemistry,” Vol. II. London, 1912.

### THORIUM

THIS element, in the form of its nitrate,  $\text{Th}(\text{NO}_3)_4 + 4\text{H}_2\text{O}$ , is by far the best known and most widely used of the rare earths. This is due, of course, to its employment in the manufacture of mantles for incandescent gas lighting.

The oxide, thoria ( $\text{ThO}_2$ ), was discovered by Berzelius in 1828, in the mineral now known as thorite, but it was not until 1885, when Auer von Welsbach invented the incandescent mantle, that a commercial use was found for the material.

### Natural Occurrence

At the time when Welsbach invented the incandescent mantle, the only sources of thoria were certain rare earth minerals, such as monazite, thorite, æschynite, samarskite, gadolinite, etc., found chiefly in Scandinavia. As these occurred only in small quantities, it was obvious that this source of supply would not be able

to keep pace with the demand. A search for suitable material led to the important discovery of large deposits of **monazite** on certain parts of the sea-coast of Brazil, which for many years formed the source of practically all the thoria of commerce. Small quantities of **thorianite** and **thorite** are also used for this purpose.

**Monazite** is a mineral composed essentially of phosphates of the cerium and lanthanum earths, together with a small and variable percentage of thoria. Its colour varies from golden yellow to dark reddish brown, and occasionally black. Its specific gravity varies from 4.8 to 5.5; samples having the higher specific gravity usually contain a large percentage of thoria (see Table I.).

Although monazite is known to occur *in situ* in certain gneissic and granitic rocks, the deposits now worked are all of an alluvial character. The most important deposits are those situated on the sea-coast of Brazil, particularly those in **Bahia**, **Espirito Santo**, and **Rio de Janeiro**, where the sands, which occur as the result of the weathering of the monazite-containing rocks, are naturally concentrated by tidal action. This concentration takes place by virtue of the difference in specific gravity between the monazite and the associated minerals, which include quartz, zircon, garnet, rutile, tourmaline, etc. The percentage of monazite in these sands naturally varies between wide limits, and may be as low as 2 per cent. or as high as 60 per cent. The mineral occurs mostly in the form of fine grains, each under 1 mm. in diameter.

Extensive deposits of the mineral also occur inland, but so far these appear to have been but little worked, possibly owing to transport difficulties and the higher grade and greater ease of working of the coastal deposits. These deposits, which are largely covered with dense forest, occur in beds of gravel, 4-6 ft. thick, which contain from 2-4 per cent. of monazite. For accounts of the Brazilian deposits and their working, articles by F. Freise, *Oester. Zeit. für Berg und Hüttenwesen*, 1911, p. 27, and *Zeits. prakt. Geol.*, 1909, 17, 514, should be consulted.

The Brazilian coastal deposits are now worked under a fifteen years' contract, from 1912, from the Brazilian Government, the contractors engaging to export at least 35,000 tons during that period. The Government is to receive a royalty of £120,000 on the first 27,000 tons exported, and 50 per cent. of the net profits on the thorium nitrate manufactured from the sand.

In the past, attempts to obtain the control of these deposits have led to an enormous amount of plotting, and, for many years, the whole output passed into German hands, and so practically the whole of the world's consumption of thorium nitrate was made in Germany. Recently a large proportion has been made in France, and an American company has also obtained a small proportion of the Brazilian output.

In North America, important deposits of monazite have been located and worked in **North and South Carolina**, but owing to the fact that a decrease in the price of thorium nitrate rendered the working unremunerative in many localities, the deposits have not been worked recently to any appreciable extent. The monazite, which occurs in crystals about the size of a pea, is found in gravels lying about 4 ft. from the surface and varying in thickness from 1-10 ft. A full account of these deposits is given by J. H. Pratt in *Economic Paper No. 14, North Carolina Geological Survey*.

In **Travancore**, Southern India, important deposits of monazite, containing nearly twice as much thoria as the Brazilian mineral, have been located and worked near Cape Comorin and Ashtamudi Bar. These deposits now occupy an increasingly important place among the countries producing monazite (see Table V.), and have been described in *Report of State Geologists of Travancore* for 1907-10 (Trivandrum, 1910), and by G. H. Tipper in *Records of Geological Survey, India*, 1914, 44, 186.

The mineral has also been found in several other countries, e.g., Norway, Ceylon, Nigeria, Nyasaland, South Africa, Australasia, Russia, and Malaya, but none of these countries figure as important producers at the present time.

The following are the results obtained by the author in the examination of



Monazites from new localities in Ceylon, Travancore, Malaya, Nigeria, and Nyasaland (*Journ. Soc. Chem. Ind.*, 1914, 33, 56).

These analyses were all made, at the Imperial Institute, on the pure monazite separated from the associated minerals. Results are also given of the examination of samples of pure monazite from two of the more important producing localities in Brazil. In these analyses any uranium present in the mineral is included in the figure for alumina.

TABLE I.—CEYLON MONAZITE

Locality . . . . .		1. Monazite Pebble from Naminkanda Morawak Korle.	2. Monazite Pebble from Muladiwanna Durayakanda, Gilimale.	3. Sand from Niriella Ganga.	4. Monazite Pebble from Ratnapura.	5. Monazite Pebble from Ratnapura.
		Per Cent.	Per Cent.	Per Cent.	Per Cent.	Per Cent.
Thoria - - - -	ThO <sub>2</sub>	9.75	9.49	10.75	10.29	28.20
Ceria - - - -	Ce <sub>2</sub> O <sub>3</sub>	27.51	27.15	26.71	27.37	20.65
Lanthana and allied oxides	La <sub>2</sub> O <sub>3</sub> , etc.	29.59	29.59	30.06	30.13	21.63
Yttria and allied oxides	Y <sub>2</sub> O <sub>3</sub> , etc.	2.54	3.93	1.46	2.14	0.94
Ferric oxide - - -	Fe <sub>2</sub> O <sub>3</sub>	1.27	0.87	1.09	0.81	1.13
Alumina - - - -	Al <sub>2</sub> O <sub>3</sub>	0.61	0.17	0.70	0.17	0.29
Lime - - - -	CaO	...	0.45	0.85	0.41	0.10
Silica - - - -	SiO <sub>2</sub>	1.78	1.67	2.47	1.03	6.09
Phosphoric acid - -	P <sub>2</sub> O <sub>5</sub>	26.12	26.12	24.61	27.67	20.20
Loss on ignition - -	...	0.59	0.48	0.93	0.20	...
Specific gravity - -	...	5.20	5.25	...	5.23	5.47

From these results it is evident that the Ceylon monazite usually contains about 10 per cent. of thoria, which is nearly double the amount found in the monazite of Brazil. It must be mentioned, however, that as little as 5 per cent. of thoria has been found, by the author, in fine grained monazite isolated from certain sands from Ceylon, but material of this character appears to be of somewhat infrequent occurrence. Occasionally, specimens are met with having an unusually high specific gravity and a correspondingly high percentage of thoria, which it will be seen has reached over 28 per cent. (column 5 in Table I.).

TABLE II.—NIGERIAN MONAZITE

Number - - - -	Northern Nigeria.			Southern Nigeria.		
	1.	2.	3.	4.	5.	6.
Locality . . . . .	Ekole.	Kadera, Central Province.	Jarawa River, Naraguta.	Iboboto Stream, Nsan-Oban Track.	Between Iboboto Stream and Ebara River.	Ebara River.
	Per Cent.	Per Cent.	Per Cent.	Per Cent.	Per Cent.	Per Cent.
Thoria - - - -	5.00	3.20	8.00	6.19	2.30	5.50
Ceria - - - -	30.72	36.53	30.50	30.38	34.58	31.40
Lanthana and allied oxides	30.02	30.00	28.80	29.60	29.83	29.20
Yttria and allied oxides	2.74	0.39	1.43	1.33	1.29	2.00
Ferric oxide - - -	3.00	1.20	0.81	1.50	1.80	0.75
Alumina - - - -	0.35	0.10	0.20	0.10	...	0.05
Lime - - - -	0.15	0.21	0.17	0.16	0.19	0.10
Silica - - - -	1.20	0.63	1.79	0.85	0.73	0.82
Phosphoric acid - -	26.29	28.29	28.16	29.70	29.71	29.92
Loss on ignition - -	0.25	0.20	0.21	0.33	0.21	0.44

The above results show that the percentage of thoria in monazite from Nigeria may vary between fairly wide limits. The average thoria content of a large number of Nigerian monazites examined by the author was 5.5 per cent. for those from Northern Nigeria and 5.8 per cent. for those from Southern Nigeria. The results show that these monazites, as a whole, are nearly as rich in thoria as those exported from Brazil.

TABLE III.

Locality . . .	Malayan Monazite.				Travancore Monazite.		Nyasaland Monazite.	Brazilian Monazite.	
	Pabang.	Puchong Babi, River Kenring, Perak.	Kulim, Kedah.	Kelantan.				Espirito Santo.	Alcobaca, Bahia.
	Per Cent.	Per Cent.	Per Cent.	Per Cent.	Per Cent.	Per Cent.	Per Cent.	Per Cent.	Per C.
Thoria - - -	8.38	3.40	3.53	9.41	10.22	8.65	7.10	6.06	6.50
Ceria - - -	25.46	33.74	64.05	60.00	31.90	61.11	32.52	62.12	61.40
Lanthana and allied oxides - - -	32.72	32.53							
Yttria and allied oxides - - -	2.80	0.91	2.40	2.82	0.46	0.62	1.50	0.80	0.70
Ferric oxide - -	0.84	0.65	0.64	1.13	1.50	1.09	1.10	0.97	1.50
Alumina - - -	2.78	0.03	0.07		0.17	0.12	0.20	0.10	0.08
Lime - - -	0.61	0.33	0.17	0.29	0.20	0.13	0.32	0.21	0.30
Silica - - -	0.92	1.45	1.08	2.20	0.90	1.00	1.66	0.75	0.64
Phosphoric acid -	23.92	26.58	27.87	23.71	26.82	26.50	28.16	28.50	28.46
Loss on ignition -	1.28	0.94	0.52	0.94	0.46	0.45	0.25	0.38	0.64

From the results of numerous partial analyses made by the author on other samples of monazite from Nyasaland, it would appear that the average thoria content is about 6 per cent.

The analyses of Travancore monazite show that it contains a high percentage of thoria approaching that of ordinary Ceylon monazite. According to E. White ("Thorium and its Compounds," p. 10), from 6-14 per cent. of thoria has been found in Travancore monazite.

Monazite from South Africa is usually poor in thoria; in some samples the amount of this constituent present is under 1 per cent. Samples of the mineral from Australia often contain only 2 or 3 per cent. of thoria.

**Preparation of the Sand for Export.**—As stated above, the crude sand may contain from 2-60 per cent. of monazite, but in order to be saleable under present conditions, it is necessary for the raw material to contain at least 4 per cent. of thoria. As the pure Brazilian monazite usually contains between 5 and 6 per cent. of thoria, it is evident that the sand must be concentrated so as to contain at least 70 per cent. of the pure mineral, and in practice it is more usual to dress the sand so that it contains about 90 per cent. of monazite. In the deposits, the monazite is usually associated with a large percentage of quartz, together with some ilmenite, garnet, rutile, zircon, hornblende, etc., and the method of concentration employed varies largely according to which of these minerals is present and the average size of the monazite grains. In general, three processes are in use, at the present day, for effecting this concentration. (1) **Wet processes** involving the use of shaking tables of the Wilfley type. (2) **Dry blowing.** (3) **Electromagnetic means.**

In the **wet process** the sand is run, with a stream of water, on to one corner of the rectangular concentrating table (see Fig. 1), which is tilted so that the material travels diagonally across it. The individual minerals, assisted by a jiggling motion which is mechanically imparted to the table, during their passage across the table arrange themselves roughly in order of their specific gravities.

The defect of this and similar wet concentration processes is that small particles of high specific gravity tend to behave in the same way as larger particles of lower specific gravity, and so an efficient separation, in the case of monazite, is difficult to carry out without losing a fair amount of the mineral as tailings.

In Brazil, the **initial concentration** is often performed by a **wet process** and the concentrates are then raised to a marketable grade by means of **electro-magnetic separation**.

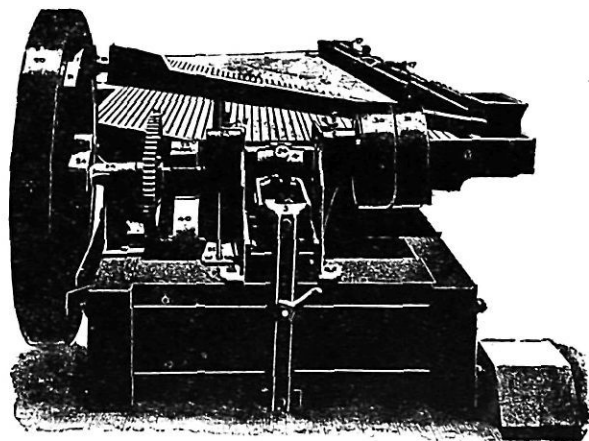

FIG. 1.—Movement End of Wilfley Table.

In **dry blowing**, the principle of concentration by gravity is here also employed as in wet concentration, but a blast of air is used in place of a current of water. This process has been used, with considerable success, in Travancore for concentrating monazite.

A machine, which is in use in Travancore, is illustrated in Fig. 2. Air from a suction blower enters the table from below and passes through the pervious cloth top, forming a film of air, under

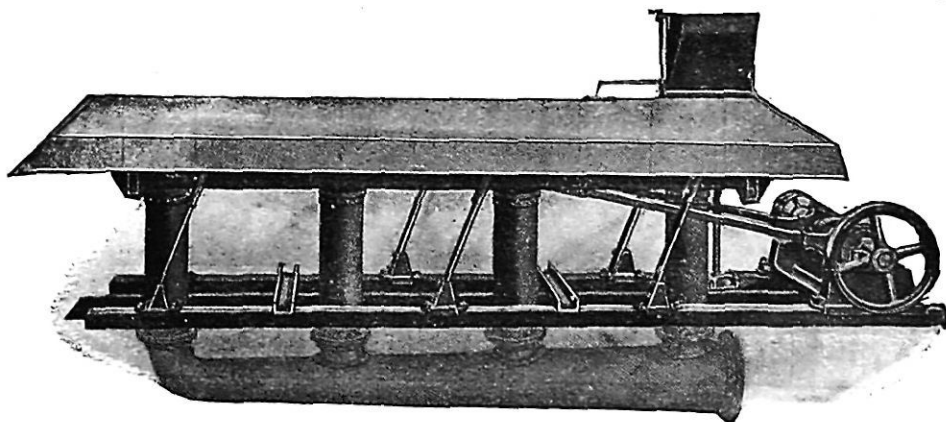

FIG. 2.—Sutton-Steele Dry Concentrating Table.

pressure, on the upper surface of the cloth. This air film causes the minerals to arrange themselves vertically, in order of their specific gravities; the heaviest being at the bottom. A reciprocating motion is also imparted to the table, thus causing the minerals to separate into zones.

A full description of the process of dry blowing is given by R. H. Richards, "Ore Dressing," Vol. II., p. 815 (New York, 1903).

**Electro-magnetic separation** is usually the most satisfactory method of producing a high-grade monazite concentrate, although the initial outlay for plant

is much greater than is required for either of the foregoing processes. This method is based upon the fact that many minerals differ in magnetic permeability, *i.e.*, a current which will attract certain minerals will leave others unaffected.

A machine suitable for the purpose is shown in Fig. 3, and its action can be seen by reference to the diagrammatic sketch, Fig. 4. The well-dried sand is fed from the hopper in an evenly distributed layer on to the band  $B_1$ , and is carried forward and thrown against the belt  $B_2$ , which travels just beneath the poles of the electromagnet *s.s.* The constituent minerals of the sand are

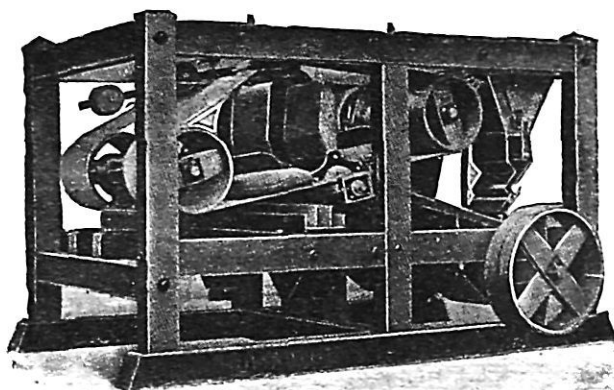

FIG. 3.—Wetherill Magnetic Separator.

attracted towards the magnet in varying degrees and fall into the collecting boxes arranged below, in order of their permeability. By repeating this treatment twice a product containing from 90-95 per cent. of pure monazite can be usually obtained.

**Thorianite** is a heavy black mineral usually found in small cubes, having a specific gravity of about 9.5 and a hardness of 7. It is usually readily soluble in either nitric or sulphuric acid. The mineral was first found in certain stream beds and gem-bearing gravels in the Central, Sabaragamuwa, and southern provinces of **Ceylon**. It has also been found, recently, in a placer deposit on the river Boshagoch

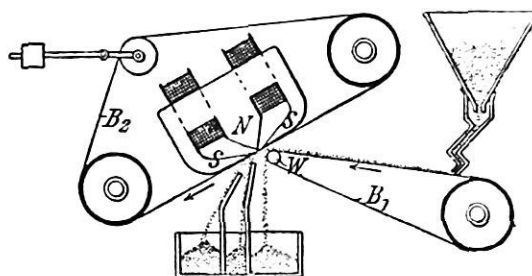

FIG. 4.—Wetherill Separator (Diagrammatic).

in Transbaikal, **Russia**. In 1905, about 9 tons of the mineral were exported from Ceylon and sold at prices varying from £1,600 to £1,700 per ton, but since then only small quantities have been produced. Thorianite is of interest, as containing a higher percentage of thorium than any other known mineral (see Table IV.).

For a full account of this mineral, see W. R. Dunstan and G. S. Blake, *Proc. Roy. Soc.*, 1905, A, 76, 253, and W. R. Dunstan and B. M. Jones, *Proc. Roy. Soc.*, 1906, A, 77, 546.

**Thorite** consists essentially of thorium silicate,  $\text{ThO}_2, \text{SiO}_2$ ; in colour it varies from yellow to dark brown, and its specific gravity may be between 4.4 and 5.4.

It is of little importance as a source of thoria owing to the small quantity available, but it is occasionally exported from **Southern Norway** and **Ceylon**. Its composition is shown in Table IV.

TABLE IV.

	Formula.	Ceylon Thorianite.		Ceylon Thorite.	
		1.	2.	3.	4.
		Per Cent.	Per Cent.	Per Cent.	Per Cent.
Thoria - - - - -	ThO <sub>2</sub>	58.84	78.86	71.04	70.12
Ceria and allied oxides - - -	Ce <sub>2</sub> O <sub>3</sub> , etc.	0.85	1.02	1.89	2.32
Ferric oxide - - - - -	Fe <sub>2</sub> O <sub>3</sub>	1.31	0.46	3.67	1.93
Uranium oxide - - - - -	U <sub>3</sub> O <sub>8</sub>	32.74	15.10	0.77	5.38
Lime - - - - -	CaO	0.19	1.13	...	...
Lead oxide - - - - -	PbO	2.56	2.59	...	1.40
Silica - - - - -	SiO <sub>2</sub>	0.45 <sup>1</sup>	0.20	13.35	13.30
Phosphoric acid - - - - -	P <sub>2</sub> O <sub>5</sub>	...	...	2.02	1.60
Loss on ignition - - - - -	...	1.26	...	7.16	4.59
Specific gravity - - - - -	...	...	...	4.94	5.94

1. Dunstan and Jones, *loc. cit.*

2. Dunstan and Blake, *loc. cit.*

3 and 4. "Rep. Min. Sur. Ceylon," Col. Reps. Misc. Ser. (Cd. 3,190, also Cd. 7,175).

**Commercial Value of Thorium Minerals.**—In 1912, 75 per cent. of the world's annual production of monazite sand came from Brazil (Espírito Santo and Bahia). This being the case, the price obtainable for the raw material from other sources has, in the past, been largely controlled by the shipments from Brazil. As is often the case with the less common minerals, the price obtainable is largely a matter of negotiation between the parties, but as a rough guide it may be stated that at the present time (June 1914), concentrates carrying 90 per cent. of monazite and not less than 4 per cent. of thoria can be sold at about £4 per unit, per cent. of thoria (ThO<sub>2</sub>), *i.e.*, a concentrate carrying 4.5 per cent. of thoria would fetch £18 per ton, *c.i.f.*, United Kingdom ports. In the case of such minerals as thorianite, which contain a much larger percentage of thoria (see analyses, Table IV.), a higher price per unit can often be obtained, providing, of course, that the material is not unusually refractory, and does not contain minerals, such as mica, which cause difficulty in the process of manufacturing thorium nitrate (see p. 299).

**Production.**—The output, during recent years, of monazite sand from the more important producing countries is shown in the following table:—

TABLE V.

	1909.		1910.		1911.		1912.	
	Metric Tons.	Value.	Metric Tons.	Value.	Metric Tons.	Value.	Metric Tons.	Value.
		£		£		£		£
Brazil - - - - -	6,462	144,742	5,437	127,526	3,686	111,104	3,398	108,758
United States - - - - -	246	13,548	45.1	2,501	1.6	89	0.5	33
Travancore (S. India) - - -	...	...	...	...	832	24,044	1,135	41,419

<sup>1</sup> Insoluble matter.

The value and original destination of the monazite shipped from Brazil, during recent years, is shown in the following table :—

TABLE VI.

Destination.	1910.		1911.		1912.	
	Metric Tons.	Value Reis.	Metric Tons.	Value Reis.	Metric Tons.	Value Reis.
Germany - . . .	2,636	921,069	1,890	868,343	1,852	900,070
France - . . .	1,691	592,321	1,096	485,016	944	440,680
United States - . .	1,100	387,200	700	316,400	600	287,400
Great Britain - . .	...	...	...	...	1.2	600
Italy - . . .	10	3,582	...	...	...	...

1 reis = 1s. 4d.

The total quantity of monazite exported from Brazil during 1913 amounted to 1,437 metric tons, valued at £38,444.

The whole of the Travancore output has, for several years past, gone entirely to Germany.

**Analysis of Thorium Minerals.**—The complete analysis of a thorium mineral is usually a long and tedious operation requiring much experience if accurate results are to be obtained, and the necessary operations are too complicated to be described here in detail.

A method for the complete analysis of monazite sand, which permits of the whole operation being carried out on one portion of the sample, has been described recently by the author (*Journ. Soc. Chem. Ind.*, 1914, 33, 56), and is briefly as follows :—

The finely ground mineral is digested with hot concentrated sulphuric acid until all the monazite has been decomposed, and the pasty mass of sulphates is then treated with cold water. After separation of the insoluble silica, by filtration, the rare earths in the acid solution are precipitated by means of ammonium oxalate. Thorium is estimated in this precipitate by the thio-sulphate method (see standard method given below). The cerium, lanthanum, and yttrium earths in the thio-sulphate filtrate are recovered by treating the solution with concentrated nitric acid, and then precipitating them by means of ammonia. Yttrium is separated from the cerium and lanthanum in this precipitate by fractional crystallisation of the double potassium sulphates, the yttrium salt remaining in solution. Cerium is separated from the lanthanum and didymium earths by converting all to hydroxides and treating with a current of chlorine whilst suspended in a fairly strong solution of caustic potash. This treatment causes the lanthanum and didymium earths to pass into solution whilst the cerium is converted into the insoluble hydrated peroxide. The filtrates from the precipitation with ammonium oxalate contain the iron, aluminium, calcium, and phosphoric acid, and after destroying the oxalate, by evaporation to dryness with nitric acid, these constituents are estimated by the ordinary methods of analysis. The accurate quantitative estimation of thorium in monazite is now a matter of considerable technical importance, and the following detailed account by E. White ("Thorium and Its Compounds"), of a variation of the thio-sulphate method, may be quoted, as it is stated to be the standard process employed commercially.

**Standard Method.**—12.5 g. of sand are heated to 180°-200° C. for two or three hours, or until all monazite grains are "broken," with 50 c.c. H<sub>2</sub>SO<sub>4</sub>. (Examine a small portion mixed with water on a watch glass.) The white pasty mass is cooled and dissolved in water sufficient to produce 500 c.c. of solution when cold. Filter when cold and take 200 c.c. of the solution (equal to 5 g. of sample), dilute with water to 500 c.c., and add, without stirring, 180 c.c. of a cold saturated solution of oxalic acid, and allow to stand until the bulky flocculent precipitate becomes heavy and crystalline (half to one hour as a rule); stir and set aside for twelve hours or overnight. Filter, reject filtrate, wash the precipitate until the washings give no reaction for phosphate with ammonium molybdate solution. (If necessary, use water acidulated with hydrochloric acid for washing.) Dry and ignite the oxalates and filter paper. Dissolve the oxides in hydrochloric acid (sp. gr. 1.16), rinsing the crucible with alcohol, if necessary. Evaporate the hydrochloric solution to dryness on a water-bath, take up with a few c.c. of water, and again evaporate to dryness. Dissolve the acid-free chlorides in 200 c.c. water, and add 9 g. of Na<sub>2</sub>S<sub>2</sub>O<sub>3</sub> + 5 Aq. in 30 c.c. water; set aside overnight, boil for ten minutes, filter and wash the precipitate until the washings

give no reaction with ammonia. Keep both precipitate and filtrate. The filtrate is again boiled for sixty minutes, and any further precipitate formed is collected, washed, kept aside, and marked "A," the filtrate being then rejected. The precipitate produced by the ten minutes' boiling is dissolved on the filter with 5 per cent. hydrochloric acid by passing the acid several times through the filter, which is then washed with boiling water. The acid solution is evaporated to dryness on a water-bath, taken up with 150 c.c. of water, and precipitated with 3 g. of sodium thiosulphate in 10 c.c. of water, set aside overnight, boiled ten minutes and filtered, and the filter washed with water. The filtrate is boiled after adding ammonia in excess, and the precipitated hydroxides are collected and set aside with precipitate "A" to rework. The thiosulphate precipitate is dissolved in 5 per cent. hydrochloric acid as before, evaporated, taken up, and reprecipitated with sodium thiosulphate solution, set aside, boiled, filtered, and the filtrate tested with ammonia. If the filtrate gives any precipitate with ammonia, the thiosulphate treatment is repeated until the solution gives no precipitate with ammonia. Three thiosulphate precipitations in all are generally sufficient. The final thiosulphate precipitate is dissolved on the filter in 5 per cent. hydrochloric acid, the filter washed with boiling water, and the filtrate made up to 150 c.c.; 10 c.c. hydrochloric acid are added, and then 30 c.c. of cold saturated solution of oxalic acid. The whole is kept at 30°-40° C. for two or three hours, and then set aside overnight, filtered, and the precipitate washed, dried, and ignited. The filter papers from the thiosulphate precipitates, the precipitate "A," and all subsequent ammonia precipitates are reworked for traces of thorium which they may contain. They generally yield about 5 mg. of  $\text{ThO}_2$ , equal to 0.1 per cent. on the 5 g. taken.

For an account of the numerous other methods which have been suggested for the separation and estimation of thorium and cerium, see "Die Analyse der seltenen Erden," by R. J. Meyer and O. Hauser (Stuttgart, 1912).

### Industrial Utilisation of Thorium Compounds

At the present time, the only commercial uses of thorium are for the production of thorium nitrate, used in the manufacture of incandescent gas mantles, the preparation of the radio-active product, mesothorium (see p. 393), alloyed with tungsten as a filament for incandescent electric lamps (see p. 362), and in certain flashlight powders.

**Manufacture of Thorium Nitrate.**—As is the case with many chemical processes, which involve the separation of a small quantity of valuable material from a large amount of comparatively worthless substance having similar chemical properties, the exact details of manufacture are carefully guarded trade secrets. The general principles involved, however, are mostly well known.

Owing to the fact that thorium occurs, in monazite, associated with members of the cerium and yttrium groups which have somewhat similar chemical properties, its separation from these is a matter of some considerable difficulty, for although there are several satisfactory methods available, on the analytical scale, these are too expensive for use on the works.

At the present time, all the processes employed for the preparation of thorium nitrate from monazite involve fractional precipitation and crystallisation at one or more stages of the operations.

The concentrated monazite, which usually contains at least 90 per cent. of the pure mineral, is first submitted to the process known as "breaking." This consists in heating it, in cast-iron pans, with about twice its weight of strong sulphuric acid (sp. gr. 1.84), until the white pasty mass of sulphates, which results from this treatment, is completely soluble in water, and no grains of yellow monazite remain. The operation is considerably facilitated if the mineral is added gradually to the *hot* acid.

**Brazilian monazite**, which occurs mostly in the form of fine grains under 1 mm. in diameter, does not usually need grinding before "breaking," but material from other sources, which is often in much larger grains, sometimes needs preliminary grinding. This is particularly the case with Carolina monazite, which often occurs in crystals about the size of a pea.

The pasty mixture of sulphates is next slowly run into cold water contained in a lead-lined vat, and the whole is well stirred until solution is complete. After allowing to stand for some time, in order to permit of the settling of the insoluble matter, which consists of silica, zircon, rutile, and other unattacked minerals, the solution of rare earth phosphates in dilute sulphuric acid is siphoned off. In this liquid the ratio of thoria to the other rare earths is about 1 to 12, and the next process consists in obtaining a product in which the ratio is about 4 to 1. This

is accomplished by taking advantage of the fact that thorium is more basic than the remaining rare earths, and so when a solution containing all these is gradually neutralised, the thorium phosphate is precipitated first. This precipitation is carried out by reducing the concentration of the free acid in the solution, either by partial neutralisation with an alkali or alkaline earth (ammonia or magnesite may be used) or by largely diluting the solution with water. The thorium precipitated in this manner is filtered off, dissolved in the minimum quantity of acid, and the fractionation repeated.

Great care is necessary in the carrying out of these operations in order to avoid losing any thorium phosphate in the waste filtrates.

The next process, involving the separation of the thorium from the phosphoric acid and remaining cerium earths, is of considerable importance, as phosphates and certain of the rare earths, particularly didymium, have a very deleterious effect on the lighting power of the incandescent mantle (see p. 303).

The methods employed, at the present time, for the removal of the phosphoric acid from this precipitate are mostly trade secrets.

A process much employed in the past was to boil the acid solution of the phosphates with oxalic acid. This caused the thorium to be precipitated as oxalate whilst the phosphoric acid remained in solution. The use of this process has now been largely discontinued, as it necessitated the use of dilute solutions and a large excess of oxalic acid, and thus proved too expensive for use on a technical scale.

An interesting process for the removal of the phosphoric acid by volatilisation, has been patented recently by C. Baskerville and described in a paper read before the Eighth International Congress of Applied Chemistry (1912, 2, 17). The process, which is being tried by the Welsbach Light Company of Gloucester City, N.J., consists in mixing 1 part of monazite with 1.1 parts of petroleum coke, 0.8 part of lime, and 0.15 part of fluorspar; heating the whole in an electric furnace for 1½ hours, using a current of 35 volts and 125 amperes. When the evolution of phosphorus ceases, the mass is allowed to cool and treated with water. Owing to the presence of calcium carbide, formed by the interaction of the lime and coke, the mass readily disintegrates to a fine powder, with the evolution of acetylene. This powder is well washed to remove calcium hydroxide, and after solution in hydrochloric acid is ready for treatment for the separation of the thorium from the cerium earths.

Previously, Muthmann, Hofer, and Weiss had operated on somewhat similar lines by fusing monazite with carbon in order to get phosphides and carbides, and then decomposing the mass with hydrochloric acid (German Patent, 129,416, 1901). Although this process removed the phosphorus, the final product was very hard and difficult to grind, probably owing to the presence of a small quantity of silicon carbide. All these difficulties are said to be overcome by Baskerville's process.

Another process which has been employed consists in fusing the phosphates with alkali carbonates and then treating the melt with water, which dissolves the sodium phosphate, leaving the rare earth oxides insoluble.

After the removal of the phosphoric acid there remains, associated with the thorium salt, from 10-25 per cent. of compounds of the cerium earths. There are several methods available for the separation of the thorium from this mixture. The best known of these are—(1) *Fractional crystallisation of the sulphates.* (2) *Separation by means of the double alkali carbonates.* (3) *Separation by the difference in solubility of the oxalates.*

**The Sulphate Method** of separation is based upon the property which thorium possesses of forming a number of hydrated sulphates, certain of which differ sufficiently in solubility from the sulphates of the cerium earths to make a separation possible.

Anhydrous thorium sulphate is soluble to the extent of about 25 per cent. in ice cold water, giving a labile solution. By raising the temperature of this solution various hydrates can be obtained which are much less soluble than the anhydrous sulphate or the corresponding cerium earth sulphates. At temperatures between 0° and 45° C. the thorium compound which separates out has the composition  $\text{Th}(\text{SO}_4)_2 + 8\text{H}_2\text{O}$ , and between 45° and 100° C. the sulphate obtained has the composition  $\text{Th}(\text{SO}_4)_2 + 4\text{H}_2\text{O}$ . The anhydrous sulphate is prepared by heating the hydroxide with concentrated sulphuric acid to a temperature of 400° C. The product obtained is then dissolved in five parts of ice cold water, and the solution heated to 15° or 20° C.

The solubilities of these sulphates, together with those of the cerium earths, are shown in the



following table. The figures represent the quantities of the various sulphates (calculated as anhydrous) which are dissolved by 100 g. of water at the temperatures stated :—

TABLE VII.<sup>1</sup>

	14°-18° C.	25°-30° C.	42°-50° C.
Th(SO <sub>4</sub> ) <sub>2</sub> + 8H <sub>2</sub> O - - -	1.38 (15°)	1.85 (25°)	3.71 (44°)
Ce <sub>2</sub> (SO <sub>4</sub> ) <sub>3</sub> + 8H <sub>2</sub> O - - -	11.06 (15°)	8.39 (25°)	5.65 (42°)
Nd <sub>2</sub> (SO <sub>4</sub> ) <sub>3</sub> + 8H <sub>2</sub> O - - -	7.10 (16°)	5.10 (30°)	3.60 (50°)
Pr <sub>2</sub> (SO <sub>4</sub> ) <sub>3</sub> + 8H <sub>2</sub> O - - -	14.05 (18°)	10.40 (35°)	7.02 (55°)
La <sub>2</sub> (SO <sub>4</sub> ) <sub>3</sub> + 9H <sub>2</sub> O - - -	2.60 (14°)	1.90 (30°)	1.60 (50°)

	50°-57° C.	70°-80° C.	90°-100° C.
Th(SO <sub>4</sub> ) <sub>2</sub> + 4H <sub>2</sub> O - - -	1.94 (55°)	1.09 (70°)	0.61 (90°)
Ce <sub>2</sub> (SO <sub>4</sub> ) <sub>3</sub> + 4H <sub>2</sub> O - - -	2.34 (57°)	1.38 (70°)	0.43 (100°)
Nd <sub>2</sub> (SO <sub>4</sub> ) <sub>3</sub> + 8H <sub>2</sub> O - - -	3.60 (50°)	2.70 (80°)	2.25 (100°)
Pr <sub>2</sub> (SO <sub>4</sub> ) <sub>3</sub> + 8H <sub>2</sub> O - - -	7.02 (55°)	4.20 (75°)	1.00 (95°)
La <sub>2</sub> (SO <sub>4</sub> ) <sub>3</sub> + 9H <sub>2</sub> O - - -	1.60 (50°)	1.00 (75°)	0.70 (100°)

A consideration of these figures shows that a temperature between 15° and 20° C. is the most suitable at which to effect the separation. The octa-hydrated thorium sulphate, at this temperature, also has the advantage that it is precipitated in the form of dense crystals, which are easily washed, whilst the tetra-hydrate is usually precipitated as a woolly mass, which is more difficult to manipulate.

**The Carbonate Method** depends upon the fact that thorium carbonate forms soluble double salts with certain of the alkali carbonates, and the amount of the cerium earths which pass into solution under these conditions is very small.

Experiments carried out by O. Hehner showed that 3.375 g. of sodium carbonate would keep in solution 0.890 g. of thoria and about 0.002 g. of ceria. The thorium can be recovered as oxalate from the solution of alkali carbonate by the addition of oxalic acid, or as hydroxide by means of caustic soda.

**The Oxalate Method** of separation utilises the property possessed by thorium oxalate of forming a soluble double salt with ammonium oxalate, whilst the cerium earth oxalates are almost insoluble in solutions of this salt.

The following table shows the relative quantities of the various oxalates (calculated as oxides) which are dissolved by excess of ammonium oxalate :—

ThO <sub>2</sub> - - - - 2663.0	Nd <sub>2</sub> O <sub>3</sub> - - - - 1.5
Yb <sub>2</sub> O <sub>3</sub> - - - - 105.0	Pr <sub>2</sub> O <sub>3</sub> - - - - 1.2
Y <sub>2</sub> O <sub>3</sub> - - - - 11.0	La <sub>2</sub> O <sub>3</sub> - - - - 1.0
Ce <sub>2</sub> O <sub>3</sub> - - - - 1.8	

A good account of the oxalates of the rare earths is given by B. Brauner, *Journ. Chem. Soc.*, 1898, 73, 951, and also by E. Rimbach and A. Schubert, *Zeits. physik. Chem.*, 1909, 67, 183.

From time to time various methods have been employed, in addition to the above, for the fractionation of the thorium precipitate; amongst these may be mentioned the *fractionation of the chromates* invented by W. Muthmann and E. Baur (German Patent, 120,013, 1901; English Patent, 17,603, 1902). For a description of this process, see *Ber.*, 1900, 33, 1756 and 2028.

All the above methods of separation are not quite so efficient as they would appear from the tables, owing to the fact that the relative solubilities of the thorium and cerium earth salts are not exactly maintained when these occur in solution together.

<sup>1</sup> Compiled from figures given by Demarcay (*Comptes rend.*, 1883, 96, 1860), Roozeboom (*Zeits. physik. Chem.*, 1880, 5, 198), and Wyrowboff (*Bull. Soc. Min.*, 1901, 24, 105).

After treating the thorium several times by one of the above processes, it is converted to the hydroxide or carbonate and then dissolved in nitric acid, giving the nitrate. This solution is evaporated until a drop on cooling shows signs of solidification. The solution, which is now in a state of superfusion, is allowed to cool to a certain point, and is then vigorously stirred. This causes crystallisation to begin with the evolution of heat, and the deposition of the nitrate in granular translucent lumps, having the composition  $\text{Th}(\text{NO}_3)_4 + 4\text{H}_2\text{O}$ . It is in this form that the nitrate is sometimes sold to incandescent mantle manufacturers, but more usually 1-2 per cent. of sulphuric acid is added to the solution just before crystallisation, as the addition of this substance causes the ash, left on ignition of the nitrate, to be soft and voluminous. By allowing the acid solution of the nitrate to crystallise slowly, clear tabular crystals are obtained which have the composition  $\text{Th}(\text{NO}_3)_4 + 12\text{H}_2\text{O}$ .

Various processes have been patented for the direct separation of thorium from the cerium earths without fractional crystallisation, but no information is available as to whether any of these are in use on a large scale.

According to recent descriptions, one of the most promising methods appears to be the use of hypophosphate of sodium (see United States Patent, 1,069,959, of 1913; M. Koss, *Chem. Zeit.*, 1912, 36, 686; A. Rosenheim, *Chem. Zeit.*, 1912, 36, 812; F. Wirth, *Zeits. angew. Chem.*, 1912, 25, 1678). This reagent is stated to precipitate thorium quantitatively from acid solution, whilst the other rare earths remain in solution. At the present time, however, the reagent is too expensive for use on a commercial scale in competition with the methods of fractional precipitation.

Sodium pyrophosphate is stated to act in a similar manner (see R. J. Carney and E. D. Campbell, *Journ. Amer. Chem. Soc.*, 1914, 36, 1134).

The use of sebacic acid has also been patented (German Patent, 266,459, 1912).

From 80-90 per cent. of the thorium present in monazite is recovered by the present-day methods of separation, the efficiency of the recovery usually increasing with the scale on which the operations are conducted.

**The Recovery of Thoria from Waste Mantle Ash.**—In some countries waste mantle ash, derived from factory trimmings and used mantles, forms a small but important source of thoria. Numerous processes have been devised for extracting the thoria from the ash and converting it to the nitrate. In one of these the crude ash is first sieved, in order to remove as much as possible of the asbestos fibre used for attaching the mantle to its support. The sieved ash is next treated, for some hours, with twice its weight of hot concentrated sulphuric acid; the pasty mass, after cooling, is poured into cold water and the rare earths precipitated by the addition of ammonium oxalate. The rare earth oxalates are then converted to the nitrates by one of the well-known processes.

The cost of manufacture of thorium nitrate from monazite varies, to some extent, with the price of the raw material, but, in the past, it would appear that the price has been regulated by the syndicate which controlled the output of raw monazite from Brazil. According to C. R. Böhm, if monazite containing 5 per cent. of thoria is sold at £30 per ton, *i.e.*, £6 per unit of thoria, then thorium nitrate can be produced at 16s. to 17s. per kilo. Another estimate by E. White puts the *works* cost of production at 10s. to 12s. per kilo, when the raw monazite is sold at about £4 per unit of thoria. The amount of monazite required to produce one kilo of technical thorium nitrate costs between 4s. and 5s., if the raw material is bought on a basis of £4 per unit of thoria.

In the past the price of thorium nitrate has been subject to wide variations, as is shown by the following table giving price per kilo:—

1894	-	-	-	£100	0	0	1907	-	-	-	£1	14	0
1898	-	-	-	2	0	0	1908	-	-	-	1	5	0
1900	-	-	-	1	14	0	1909	-	-	-	0	18	0
1904	-	-	-	2	3	0	1910	-	-	-	0	19	0
1906	-	-	-	1	7	0	1912	-	-	-	0	18	0

In June 1914 technical thorium nitrate cost about 18s. per kilo in the United Kingdom.

### Testing of Thorium Nitrate for Mantle Manufacture

The following is a brief summary of the tests which the salt is usually required to pass in order to satisfy the requirements of mantle manufacturers:—

**Solubility and Colour.**—When 25 g. of the nitrate is stirred with 25 c.c. of distilled water, for ten minutes, it should be completely soluble, and the solution should have only a slight yellow colour.

**Ignition.**—The nitrate, after ignition in a platinum crucible for thirty minutes, in a blast flame, should leave a residue of not less than 48 per cent. The ash should be quite white and free from any pinkish or yellowish tint.

**Cerium.**—Dissolve 2 g. in 10 c.c. of distilled water, and add sufficient potassium carbonate solution to dissolve the precipitate first formed. The addition of a few drops of hydrogen peroxide to this solution should not give any appreciable yellow colour. This test will indicate 0.004 g. of cerium oxide.

**Didymium.**—The ash produced by the above ignition is suspended by a platinum wire for two minutes in the flame of a Bunsen burner. After cooling and crushing, the ash will be pink if didymium oxide is present. This test is very sensitive. The yellow colour imparted to the flame in this test should be only transient, and the ash should show practically no luminosity in the ordinary (not blast) Bunsen flame. The presence of almost any inorganic impurity will cause the ash to become luminous.

**Iron and the Heavy Metals.**—Only a slight coloration should be produced on mixing a 30 per cent. solution of the nitrate with an equal volume of a 2 per cent. solution of ammonium thiocyanate. To test for the heavy metals, 20 c.c. of a 30 per cent. solution is mixed with 50 c.c. of water saturated with sulphuretted hydrogen. At the most, only a slight darkening should be produced without any trace of a permanent precipitate.

**Phosphoric Acid.**—The nitrate should not contain more than 0.004 per cent. of  $P_2O_5$ . For the quantitative determination of this constituent about 25 g. of the sample is taken, and the phosphate is precipitated in the usual way with ammonium molybdate in acid solution.

**Sulphuric Acid.**—The determination of sulphate in the presence of thorium nitrate by the usual method of precipitation with barium chloride gives low results. E. White recommends fusing the nitrate with four times its weight of solid potassium hydroxide, extracting the mass with water, and after filtering off the insoluble matter, determining the sulphate in the filtrate in the usual manner. Another process is to dissolve 10 g. of the nitrate in 250 c.c. of distilled water and add 5 c.c. of hydrochloric acid and 5 g. of oxalic acid. After allowing to stand for some hours, an aliquot part of the clear liquid is filtered off and the sulphate estimated in the usual manner.

Makers of mantles usually require a nitrate which, on ignition, shall leave a soft voluminous ash, and for this purpose sulphuric acid is added to the nitrate before crystallisation, so that the finished nitrate contains about 2 per cent. of sulphate. Thorium nitrate free from sulphate leaves, on ignition, a hard dense ash unsuitable for mantle manufacture by the ordinary process.

**Aluminium, Calcium, Magnesium, and Sodium,** together with the iron and phosphoric acid, are determined by precipitating the rare earths with oxalic acid, evaporating the filtrate to dryness, and weighing the residue remaining after ignition, which should not amount to more than 0.05 per cent. of the original thorium nitrate.

**Influence of Impurities.**—Alkalis and alkaline earths in the body of the mantles cause them to shrink and lose their shape. Phosphates cause excessive brittleness, whilst didymium and lanthanum produce a decrease in luminosity. Traces of iron and the heavy metals have but little effect, as they are largely volatilised during the ignition of the mantle.

## The Manufacture of Incandescent Gas Mantles

This industry, which has now attained such an enormous size, may be said to have started in 1884, when Welsbach patented the use as a lighting medium of a fibrous network composed of the oxides of certain of the rare elements (French Patent, No. 172,064, of 1884; German Patent, 39,162, Class 26, of 1885).

The first mantles were made of the oxides of zirconia, lanthana, and yttria (English Patent, 3,592, of 1886), but were not a success, as they could not stand any shock and had very inferior lighting power. The next advance was in the employment of thoria, either alone or mixed with other oxides (English Patent, 15,286, of 1886).

The incandescent mantle cannot be said to have been a commercial success until 1893, when Welsbach patented the use of a mixture containing 98-99 per cent. of thorium oxide, together with 1-2 per cent. of cerium oxide (English Patent, 124, of 1893). In these proportions the oxides have their maximum light-giving power. Later investigations have shown that pure thoria has little light-emitting power, and that the addition of over 2 per cent. of ceria causes a decrease in luminosity of the mantle, until about 10 per cent. is reached, when the light falls to about the same quantity as is emitted by pure thoria. The changes caused in the intensity of the light emitted by incandescent thoria, by the

addition of varying amounts of ceria, is well illustrated in Fig. 5. This curve has been drawn from the results of G. P. Drossbach (*Journ. für Gasbel.*, 1898, 41, 352; see also J. Lux, *Zeits. für Beleuchtung*, 1907, 246). From the year 1893 up to the present time, many oxides have been tried in place of these, but none have, thus far, been found to be so efficient.

In the conversion by ignition of thorium nitrate to the oxide, thoria, the material expands so that it occupies at least ten times its original volume. As the cerium nitrate does not appreciably change its volume when converted to the oxide in the mantle, the volume ratio of the thorium oxide to cerium oxide is 999 to 1. According to the work of A. H. White and H. F. Travers (*Journ. Soc. Chem. Ind.*, 1902, 21, 1012), 100 parts of thoria can hold 6.7 parts of cerium

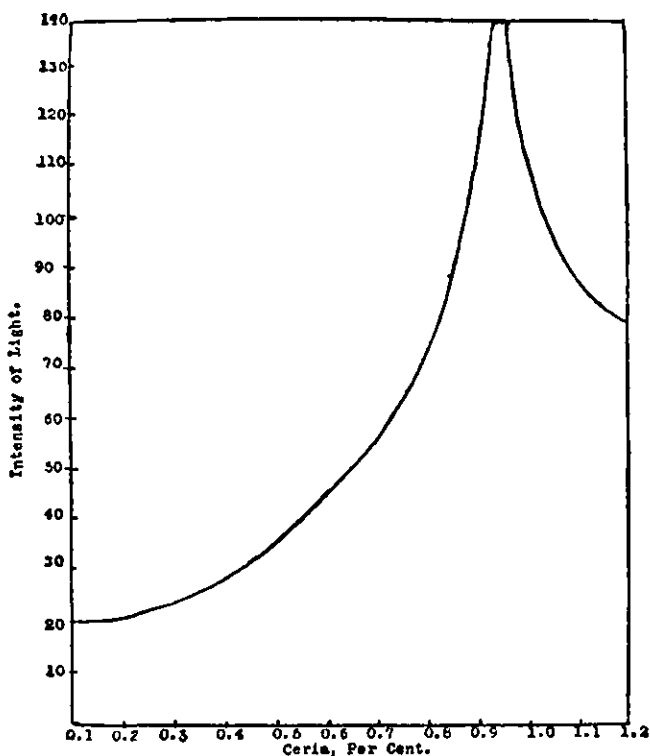

FIG. 5.

oxide ( $Ce_2O_3$ ) in solid solution, and, therefore, all the cerium in the incandescent mantle is in the dissolved condition.

It is impossible to give a full account of this important branch of technology in the space available, but the following is a brief outline of the more important parts of the process.

**Fabric.**—The earlier mantles were made of cotton, but as these were found to give a decreased illumination after being in use for a short time, this material has been largely supplanted by ramie fibre for the better quality goods. Recently, artificial silk has been used with satisfactory results, as it combines the high and well-maintained illuminating power of ramie with a greater elasticity of the ash skelëton, and the mantles produced are, therefore, more capable of withstanding shock. German makers are largely using cuprammonium cellulose and Chardonnet silks, whilst the French makers prefer to use "viscose" silk (see English Patent, 8,700, 1892), which is also used in this country. Artificial silk mantles have the additional advantage that they do not require washing before impregnation.

The appearance of impregnated fibres, made of the three classes of materials mentioned above, both before and after "burning off," is well illustrated in the



FIG. 6.—Cotton before Burning Off.



FIG. 7.—Cotton after Burning Off.

*(Reproduced by permission from Thorpe's "Dictionary of Applied Chemistry.")*

photo-micrographs shown in Figs. 6-11. Cotton fibre (Figs. 6 and 7) is seen to have a very twisted structure, whilst that of ramie (Figs. 8 and 9) is of a somewhat simpler form. The structure of artificial silk is very similar to that shown in Figs. 10 and 11, which show collodion fibres impregnated with thorium nitrate.



FIG. 8.—Ramie before Burning Off.

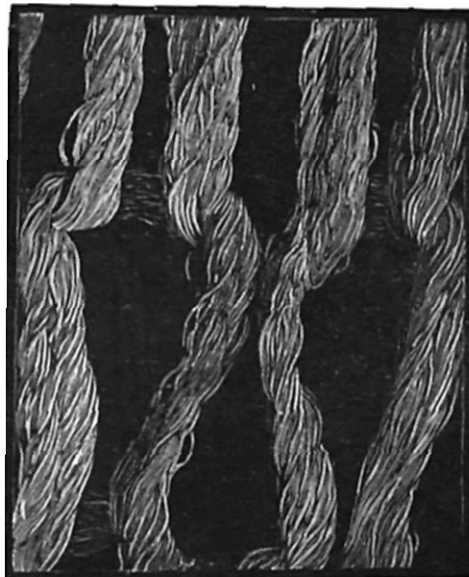

FIG. 9.—Ramie after burning off.

*(Reproduced by permission from Thorpe's "Dictionary of Applied Chemistry.")*

The yarn used in the manufacture of incandescent mantles is tested at the works, both as regards its "count" and breaking strain; the latter is of importance on account of the tension which the yarn has to undergo during knitting of the "stocking." The efficiency of the mantle varies directly, within certain limits, as the tension to which it is subjected during knitting.



FIG. 10.—Collodion before Burning Off.

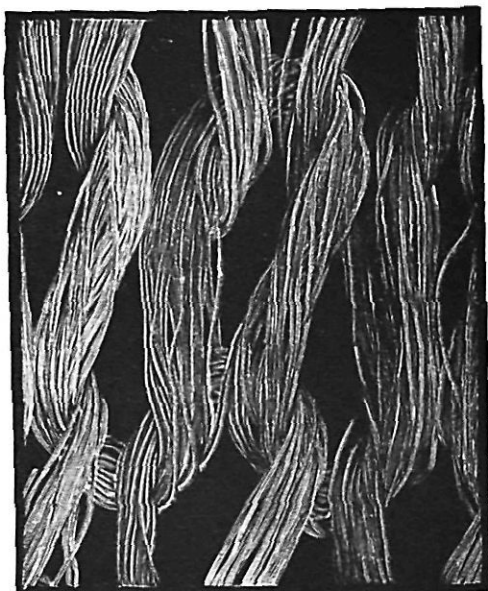

FIG. 11.—Collodion after Burning Off.

*(Reproduced by permission from Thorpe's "Dictionary of Applied Chemistry.")*

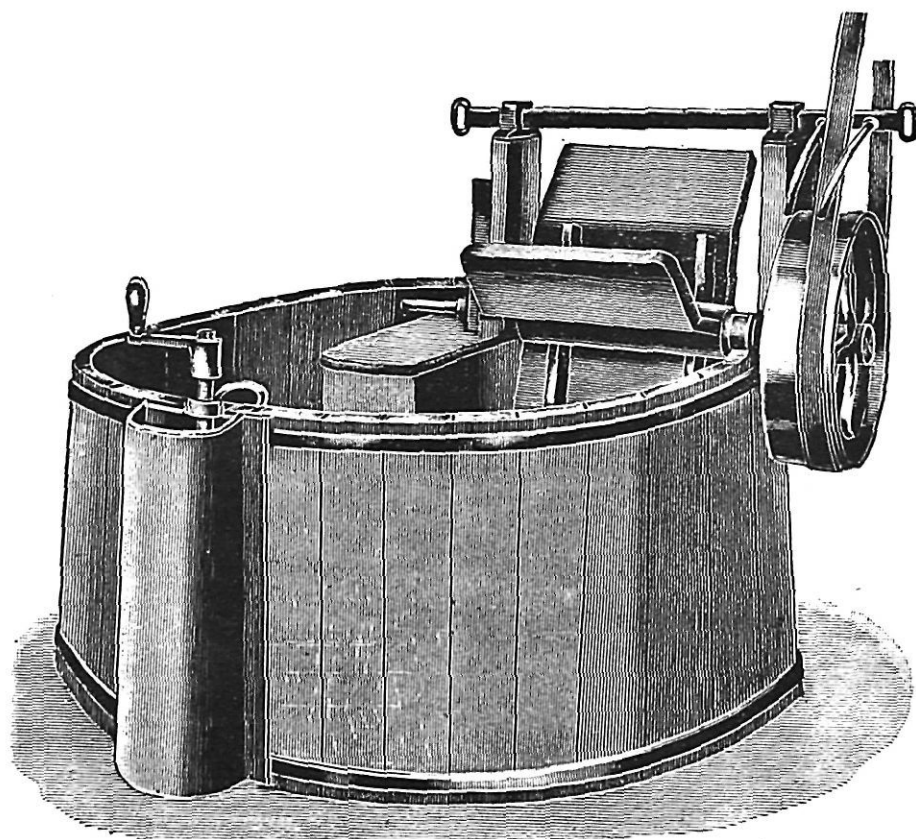

FIG. 12.—Washing Machine.

**Washing.**—Before being impregnated with the solution of the rare earths, the web for cotton and ramie mantles needs to be washed in order to decrease the quantity of mineral matter, and also to remove any fatty substance present. Ramie mantles are soaked overnight in a 2 per cent. solution of nitric acid, and next morning, after the superfluous liquid has been removed by means of a centrifuge, they are well washed in distilled water, and treated with dilute ammonia, and then again thoroughly washed with distilled water. Cotton mantles are washed, first in a 3-5 per cent. solution of caustic soda, and next in a 1-3 per cent. solution of hydrochloric acid. The alkaline bath is usually employed warm. The above methods are all subject to variation, according to the individual ideas of the manufacturer. A washing machine is shown in Fig. 12. By the above treatment the ash content of the mantle before impregnation is reduced to about 0.02 per cent., and consists largely of iron oxide and silica. Reduction of the ash below 0.01 per cent. is stated to be detrimental to the strength of the ash skeleton. Each batch of washed material should have its ash content determined. In all the following operations great cleanliness is necessary.

**Drying.**—This is done by suspending the mantle, in a current of hot air, in a special drying apparatus which may consist of a chamber in which the web is

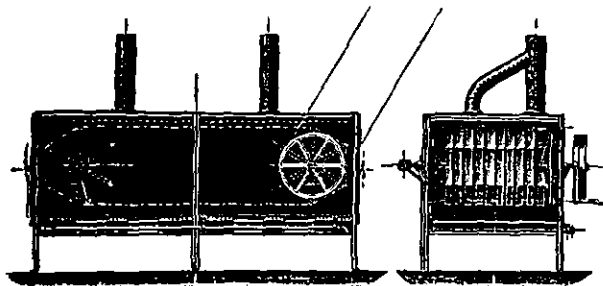

FIG. 13.—Drying Chamber.

suspended on poles, or of a special drying box round the inside of which the web passes a number of times. A machine of the latter type is illustrated in Fig. 13.

**Impregnation.**—For this purpose a solution containing from 25-50 per cent. of thorium and cerium nitrates is used, the proportions employed being about 99 per cent. of thorium salt to 1 per cent. of cerium. Small quantities of beryllium or magnesium nitrate are also added to strengthen the ash skeleton.

The composition of certain solutions used for impregnating is shown in the following table:—

TABLE VIII.

	1.	2.	3.	4.	5.
	Grams.	Grams.	Grams.	Grams.	Grams.
Thorium nitrate (48-49 per cent. ThO <sub>2</sub> )	1,000	1,000	1,000	1,000	1,000
Cerium nitrate - - - -	10	8	10	10	10
Beryllium nitrate - - - -	5	2	5	5	...
Magnesium nitrate - - - -	1.5	1.5	2.5	2	1
Distilled water - - - -	2,000	2,400	1,800	1,600	2,500

Many makers adjust the impregnating solution so that inverted mantles, after ignition, contain 0.5-0.8 per cent. of ceria, whilst the upright type contain 1.0 per cent.

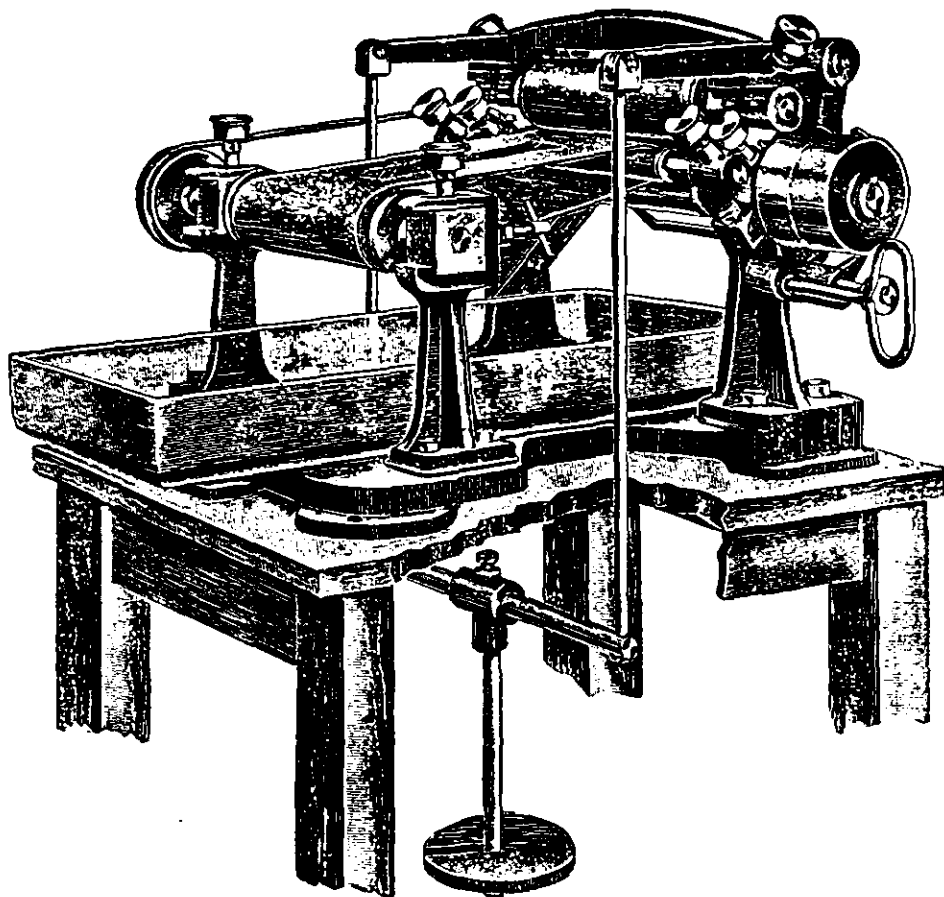

FIG. 14.—Impregnating Machine,  $\frac{1}{10}$  Actual Size.

Formulae for ramie mantles are given in columns 1-4, the latter being a stronger solution for impregnating mantles intended for use with high-pressure gas; No. 5 is for cotton mantles. Beryllium nitrate is sometimes added to the solution used for impregnating cotton mantles, if these have to be given special shapes such as those used in pressure or petrol gas lighting. The time of impregnation varies from about two minutes, in the case of cotton and ramie mantles, to about five hours in the case of certain artificial silk mantles. If the quantity of magnesium nitrate in the impregnating solution is much increased over that shown above, the time required for "burning off" is considerably reduced, and hence the cost of production is slightly lowered. After impregnation, superfluous liquid is removed by passing the ramie and cotton mantles through a wringing machine, the rollers of which can be adjusted so as to regulate the quantity of solution left in the mantle, and hence its final weight after "burning off." Such a machine is illustrated in Fig. 14. The artificial silk mantles have their superfluous solution removed by means of a centrifuge.



FIG. 15.—Glass Drying Cylinder.

The mantles are next dried at a temperature of about 30° C., those of ramie and cotton, which are cut up into lengths before impregnation, being stretched on glass cylinders (Fig. 15), whilst the silk ones are treated in lengths on wooden rollers. The cheaper grades are, however, usually cut up after impregnation and drying.



The upright mantles are next fitted with a sewn-on tulle head, together with the asbestos loop, by which they are suspended, unless these were attached before impregnation. Inverted mantles are drawn together with impregnated cotton to form the "spider," and are fixed to the supporting ring (see p. 313).

**Fixing.**—The mantle also requires to have strengthened those parts which, when in use, will be subjected to the greatest strain: these are the head and loop of upright and the portion around the ring of inverted mantles. The method sometimes used is to treat these portions with a thorium solution containing a much larger proportion of salts of calcium, aluminium, or magnesium, than that employed for impregnating. On "burning off" (see below), the portions of the mantle so treated shrink more than the body, and so become more compact and therefore stronger. The solution may contain aluminium nitrate, 20 parts; magnesium nitrate, 20 parts; borax, 0.3 part; water, 100 parts.

A machine for applying this "fixing" liquid is shown in Fig. 16. In this a felt pad saturated with the fixing solution is pressed against the dried impregnated mantle whilst the latter is slowly rotated. A small quantity of methyl blue is often added to the solution in order to show where it has been applied. In many works it is now customary to apply the fixing solution by means of a spraying machine working on the "Aerograph" principle. Upright mantles are usually fixed before the tulle head is sewn on.

**Branding.**—If it is desired to brand the mantle with a trade mark or maker's name the design is stamped upon it with a solution consisting of:—

Didymium nitrate	-	-	1,000 g.
Glycerine	-	-	200 "
Methyl blue	-	-	25 "
Alcohol (96 per cent.)	-	-	300 "
Distilled water	-	-	500 "

This solution gives a brand which can be readily seen both before and after "burning off." Although upright mantles are usually branded after fixing, it is more customary to brand the inverted type before mounting them on the ring.

**Burning Off.**—The mantle is next shaped on a wooden model and burnt off from the top with a Bunsen flame. Formerly, this operation, together with those of "shaping" and "hardening," was performed by hand, but it is now the general custom to use a machine similar to that illustrated in Fig. 17, which is designed for inverted mantles. It consists, essentially, of two rows of gas burners mounted on an iron frame, with a mechanical arrangement for raising or lowering the burners and gas pressure, and a removable bar with clips from which the mantles are

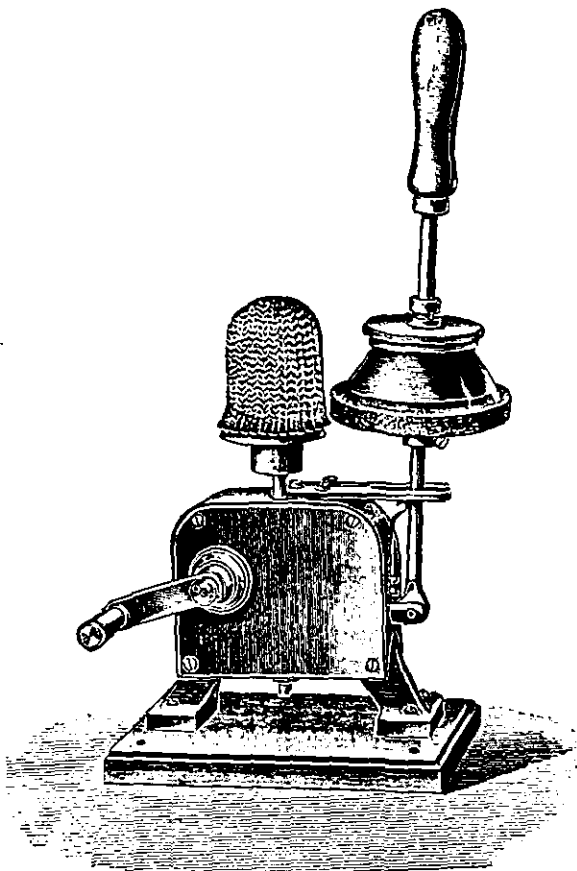

FIG. 16.—Machine for Applying "Fixing" Solution to Inverted Mantles,  $\frac{1}{2}$  Actual Size.

suspended. The machine is also furnished with a movable screen of blue glass in order to protect the operator from the heat and intense light. The upper row of burners, to which the gas is delivered at a pressure of 2-4 in. of water, are for carbonising the mantle; the lower row, which is fed with a mixture of gas and air under pressure, being for "hardening" the ash skeleton by subjecting it to a more intense heat. The "burning off" is always begun from the *top* of the mantle, for if the operation is performed in the reverse order the mantle will probably be so mis-shapen as to be quite useless. As soon as the carbonisation

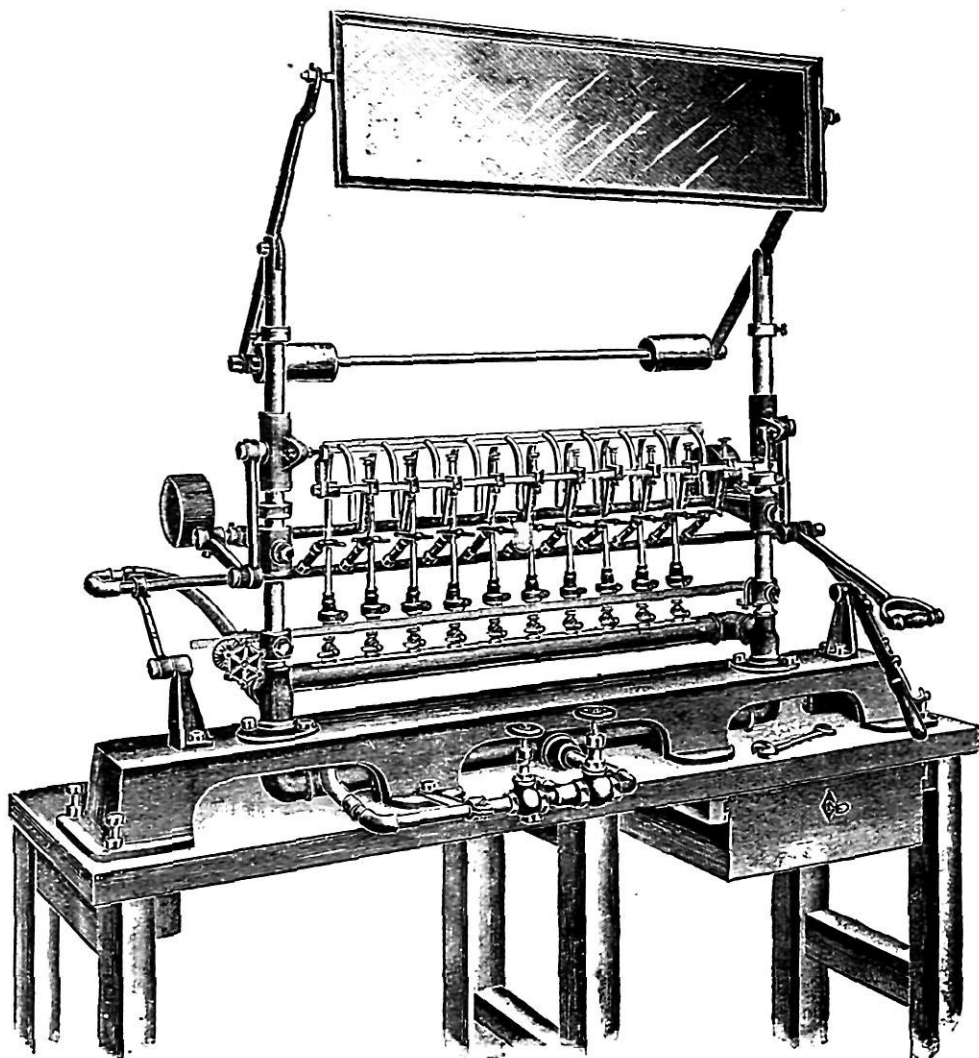

FIG. 17.—Burning Off and Hardening Machine for Inverted Mantles,  $\frac{1}{4}$  Actual Size.

of the mantle is complete, it is "shaped" by being heated from top to bottom by one of the low-pressure burners. It is next "hardened" by being heated in one of the high-pressure burners, the operation lasting from  $1\frac{1}{2}$ -15 minutes according to the size of the mantle.

In another type of machine the inverted mantles are supported by the lugs of their fire-clay rings, which just rest above holes in metallic saucers, which are suspended over the burners of a machine very similar to that described above.

During the process of "burning off" a considerable shrinkage takes place in the size of the mantle, the ratio between the size before and after the operation

being dependent upon a number of factors, such as count of yarn, stitch used, tension of knitting, heaviness of impregnation, etc. The following figures may serve as an illustration—"ramie stocking" for a "C" size upright mantle 20 cm. long and 10-14 cm. in circumference will give a mantle about 10-14 cm. long and 9 cm. in circumference.

The number of mantles which can be made from 1 kilo of thorium nitrate varies with the size and quality of the mantle; for "C" size upright mantles the number made per kilo by a well-known works are as follows:—Best quality, 500-600; medium quality, 700-800; cheap quality, 1,000. As many as 1,200 mantles of the cheap German type may be produced from 1 kilo of thorium nitrate.

**Collodionising.**—The mantles, which now consist of an ash skeleton, are

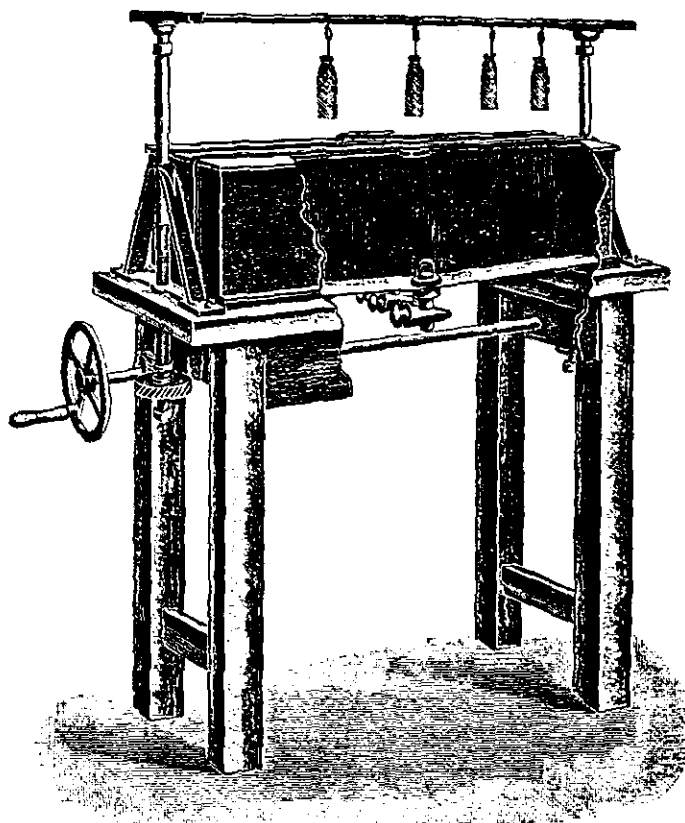

FIG. 18.—Collodionising Bath,  $\frac{1}{8}$  Actual Size.

made suitable to bear transport by being immersed in a solution somewhat of the following composition:—

Collodion solution (4 per cent.)	-	-	-	-	100 parts
Ether	-	-	-	-	40 "
Camphor	-	-	-	-	6.5 "
Castor oil	-	-	-	-	3.5 "

The mantle, after collodionising, is still somewhat fragile, and any blows which it receives will probably show as cracks when the mantle is brought into use. To overcome this defect, certain makers add inorganic salts such as the nitrates of thorium, zirconium, or beryllium to the collodion solution.

This operation is carried out by means of a machine, the principle of which is illustrated in Fig. 18. It is customary, however, in most large works to perform

the operation on a much larger scale in a closed room which has special arrangements for the condensation and collection of the volatile vapours evolved.

After drying at a temperature of 50°-60° C. the mantles are trimmed (see Fig. 20) and are ready for use. It is desirable that this drying should be performed fairly rapidly, as slow drying may cause undue strain to the mantle.

The manufacture of **incandescent mantles** from **artificial silk** is usually carried out in a manner differing somewhat from that already described for ramie or cotton. When nitro-cellulose is used, the impregnated fibre has to be denitrated before "burning off," otherwise the combustion would be so rapid as to destroy the form of the mantle. This denitration is unnecessary if "viscose" silk be used. One process may be quoted as an example of the method of procedure if nitro-cellulose is used (French Patent, 462,156, 1911). The silk, after being freed from grease by washing in ether containing a little carbon disulphide, is impregnated in a thorium-cerium nitrate bath of the usual strength. After drying, the impregnated fabric is denitrated by immersing it in 95 per cent. alcohol, to which has been added a little hydrofluoric acid. This treatment causes the thorium to be precipitated in an insoluble and viscous condition in the fabric, which is next washed in distilled water, and finished in the same manner as are ramie mantles.

Many patents have been granted for processes for the conversion of the thorium nitrate to an insoluble form whilst in the fabric, by means of a precipitant. The object of this precipitation is to obtain the thoria in a very dense form, so that on ignition it will give a more coherent ash skeleton than is obtained from the nitrate.

Substances for this purpose include ammonia (English Patent, 20,747, 1901; 11,042, 1902; and French Patent, 321,803, 1902), hydrogen peroxide (French Patent, 438,260, 1911), ozone (French Patent, 414,700, 1909), and aqueous solutions of amines mixed with a suitable acid or phenol (French Patent, 403,443, 1909).

This increase in strength of the ash skeleton is a matter of considerable importance for mantles which will be subjected to much vibration, such as those used for railway carriage lighting.

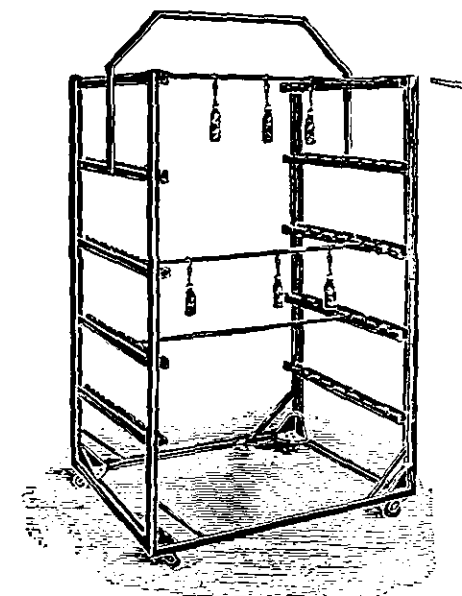

FIG. 19.—Movable Drying Crate for 500 Mantles,  $\frac{1}{4}$  Actual Size.

Of course, when this is desired, the thorium nitrate used for impregnation does not contain any sulphate (see p. 303), which causes the material to swell up enormously on ignition.

The increased use of pressure gas and vaporised oil for incandescent lighting has also led to a demand for extra strong mantles of this type, which are particularly necessary for use with certain incandescent oil burners in which the gaseous product is often delivered from the jets at a pressure of about 25 lbs. to the square inch. According to information supplied by a manufacturer in the United Kingdom who specialises in the production of mantles for the lighting of railway carriages, the most satisfactory material for this purpose is "viscose" silk (for an account of artificial silks see **G. Martin**, "Industrial Chemistry: Organic," p. 214).

The following is a very brief description of one process of manufacture employed (English Patent, 25,549, 1908). The fabric, if "viscose" silk be used, is impregnated in the usual manner, almost completely dried, and placed in a vacuum chamber in order to remove all occluded air and moisture. When this has been satisfactorily accomplished, dry gaseous ammonia is slowly admitted to the chamber, thus causing a more complete precipitation of the thoria than

could be obtained by immersion in aqueous ammonia, even when this latter treatment is preceded by evacuation. When the precipitation is considered to be complete, the ammonia is slowly blown out by a current of air, the mantles removed, washed, and finished in the usual manner. It is claimed that the tensile strength of mantles prepared in this way is greater than those of equal illuminating power prepared by the ordinary process. When cotton or ramie is employed in this process, in place of artificial silk, the fabric before impregnation is steamed, so as to open the fibres, placed in a vacuum, and the thorium solution slowly admitted.

Artificial silk mantles usually have the "burning off," shaping, and "hardening" performed in one operation. Owing to the fact that the individual threads of

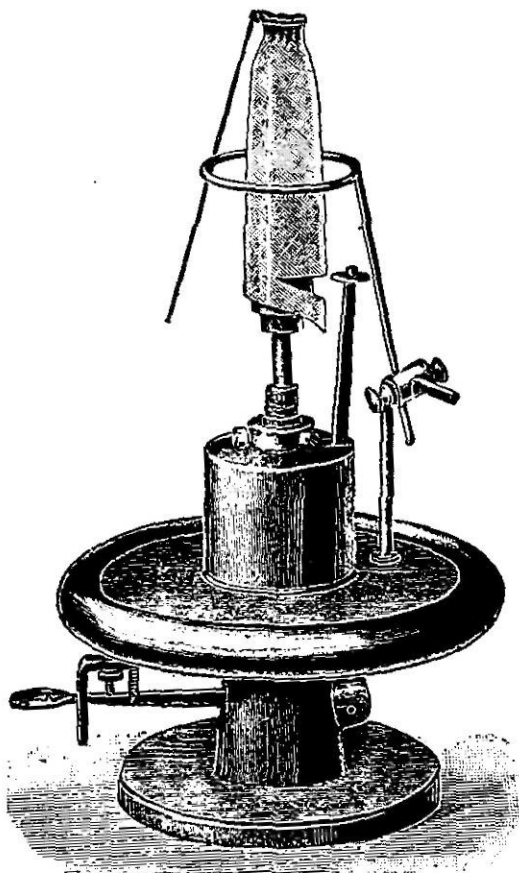

FIG. 20. — Machine for Trimming Upright Mantles,  $\frac{1}{4}$  Actual Size.

mantles of this type have a tendency to contract and become entangled when carbonised, a special arrangement is necessary for "burning off." The mantles are suspended over a guiding tube, the outer diameter of which is equal to that desired for the finished mantle, so that only the head is above the top of the burner, which passes through the inside of the guiding tube. The mantle is ignited and slowly moved upwards until only the bottom is in contact with the flame. Artificial silk mantles for high-pressure lighting are often sent out from the works in the soft unburnt condition.

A general review of the use of artificial silk for incandescent mantle manufacture is given by F. Wirth (*Chem. Zeit.*, 1911, 35, 752).

The manufacture of the rods and rings for supporting upright and inverted mantles, respectively, is an important matter in this branch of technology, but one which cannot be considered fully here. These articles are usually not made on

the mantle works. A description of their manufacture is given by C. R. Böhm ("Die Fabrikation der Glühkörper für Gasglühlicht"), and a recent account of comparative experiments with porcelain mixtures and alundum is given by R. L. Clare (*Trans. Amer. Ceram. Soc.*, 1912, 14, 497).

**Testing of Gas Mantles.**—The testing departments of certain public bodies have instituted a series of tests for the comparison of the various mantles on the market as regards their durability and lighting properties.

The durability is determined by means of the **Woodall-Moon** or similar machine (see Fig. 21), in which a mantle is fixed to its burner, and after being burned off for about five minutes is subjected to a series of shocks administered by a miniature stamp driven by a water motor. The shocks given to the mantle can be varied by altering the weights used to load the rod which causes the shock, and the vibrations thus produced are stated to be similar to those occurring when heavy

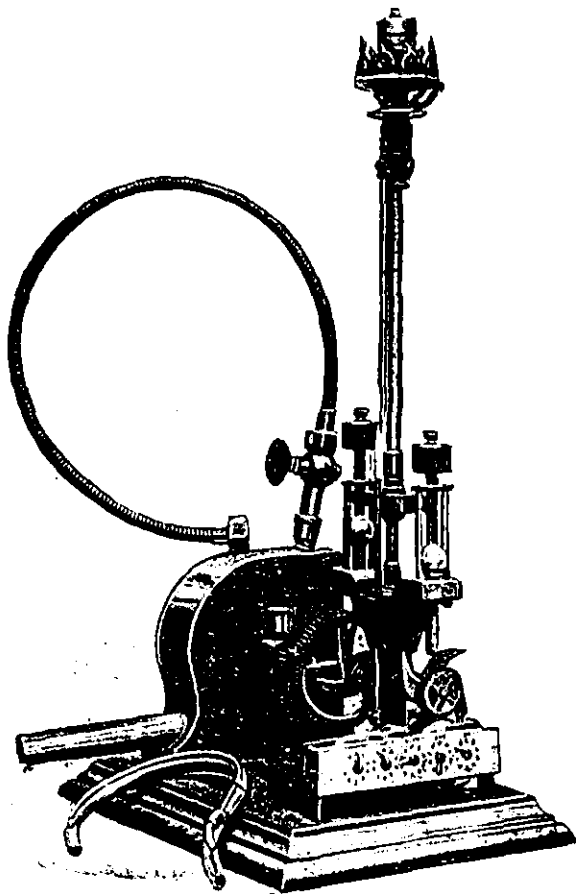

FIG. 21.—Woodall-Moon Mantle Tester.

traffic passes along a road. According to a recent article by J. H. Coste and W. E. F. Powney (*Journ. Soc. Chem. Ind.*, 1911, 30, 65) the usual test which upright mantles are required to stand, without fracture, is 1,000 shocks administered at the rate of 300 per minute, using 2 oz. weights. For inverted mantles the test is 3,000 shocks at the rate of 600 per minute, using 3 oz. weights. In both cases the Woodall-Moon machine is used.

The illuminating power of the mantles is tested by means of one of the well-known types of photometers.

**Statistics of Production.**—Accurate figures cannot be obtained, but the annual consumption of incandescent mantles in 1912 was estimated to be approximately as follows:—

	Millions.
Germany - - - - -	100
United States - - - - -	60
United Kingdom - - - - -	38
France - - - - -	16
Belgium - - - - -	3.5
Italy - - - - -	3.0
Russia - - - - -	1.5
	222.0

A recent estimate places the total consumption of incandescent mantles at 300 millions per annum.

Although rapid advances have been made in the manufacture of incandescent mantles in this country, there are still enormous numbers imported from Germany. Complete statistics are not available, but the value of the incandescent mantles imported into and exported from the United Kingdom and the United States are shown in the following table:—

TABLE IX.

	1911.	1912.	1913.
<b>IMPORTS.</b>			
	£	£	£
United Kingdom - - - - -	277,357	322,631	302,576
United States - - - - -	13,331	13,555	12,785
<b>EXPORTS.</b>			
United Kingdom (home manufacture) - - -	28,126	40,728	32,566
United Kingdom (foreign manufacture) - -	15,412	3,274	5,650
United States - - - - -	<i>Nil</i>	<i>Nil</i>	<i>Nil</i>

### Minor Uses of Thorium Compounds

Small "pastilles," consisting largely of thoria, together with a trace of ceria, are finding an extensive use for lighting of the "limelight" type, such as is used in searchlights and for the headlights of motor cars.

The use of certain thorium compounds as constituents of magnesium flashlight powders has been patented. Thus, the use of thorium chromate or tungstate is covered by French Patent, 14,692, 1908, whilst certain other salts are mentioned in English Patent, 27,267, 1904, and French Patent, 403,722, 1909. The chief claims made for these powders is that they evolve considerably less smoke, when fired, than do those consisting of magnesium alone.

A method for preparing colloidal thorium is given on p. 363, and the use of the metal in filaments for incandescent electric glow lamps is described on p. 362.

### PATENT LITERATURE

Since its introduction, numerous patents have been taken out covering many improvements in the manufacture of the incandescent mantle. In the following list are included the more important patents granted in the United Kingdom. An attempt has been made to classify these according to the nature of the improvement claimed; unfortunately, this has not been possible in all cases. Short abstracts of the majority of these specifications will be found in the *Journal of the Society of Chemical Industry*.

**Weaving and Knitting the Web.**—English Patents, Nos. 3,323, 3,530, 5,821, 13,259, 16,473 of 1900.

**Composition and Treatment of Fabric before Impregnation.**—English Patents, Nos. 11,038, 15,246 of 1895; 13,256, 26,304, 29,613 of 1896; 26,381 of 1897; 3,770 of 1898; 63, 11,653 of 1899; 9,088, 19,859 of 1900; 454, 9,551, 20,747 of 1901; 17,603, 20,004 of 1902; 25,698 of 1903; 7,668 of 1904; 24,680 of 1905; 18,152 of 1906; 3,055 of 1908; 21,315 of 1911.

**Impregnating Solutions**—(1) *With a Thorium Salt as the Chief Constituent.*—English Patents, Nos. 10,129, 19,202 of 1895; 1,681, 1,682, 2,000, 3,262, 3,681, 9,244, 13,659, 14,365, 14,448, 21,267, 26,167, 27,269 of 1896; 501, 11,739, 14,499, 15,963, 20,225, 26,202, 29,767, 30,145 of 1897; 2,015, 13,504, 14,184, 14,259, 15,713 of 1898; 8,058 of 1899; 5,989 of 1900; 827, 4,229, 12,137 of 1901; 21,861 of 1902; 16,018 of 1905; 6,828 of 1907; 422,643 of 1910; 17,492 of 1911; 25,360 of 1912.

(2) *Containing no Thorium Salt.*—5,646 of 1883; 17,866 of 1888; 4,732, 7,372, 10,427, 20,735 of 1894; 24,505 of 1895; 1,841, 4,000, 14,845, 15,500, 17,194 of 1896; 3,811, 14,499; 20,221, 30,112 of 1897; 49, 25,653 of 1898; 9,273, 16,166 of 1899; 3,925 of 1900; 1,629 of 1909.

**Precipitation of Thoria in Fabric.**—English Patents, 16,053 of 1899; 20,747 of 1901; 11,042 of 1902; 14,288 of 1904; 15,295 of 1906; 16,867 of 1907; 10,233 of 1908; 10,400, 23,434 of 1909; 11,904, 13,169, 27,837 of 1911.

**Strengthening the Mantle.**—English Patents, Nos. 7,330, 22,327 of 1897; 20,740 of 1898; 13,181 of 1906; 25,657 of 1907; 27,755 of 1908.

**Indestructible Mantles.**—English Patents, Nos. 8,162 of 1905; 3,785, 28,435 of 1908.

**Stamping Trade Marks on Mantles.**—English Patents, Nos. 1,538 and 12,077 of 1899.

**Self-Lighting Mantles.**—English Patents, Nos. 16,966, 26,618 of 1896; 15,414, 17,575, 20,017, 25,268 of 1898; 23,701 of 1900; 609 of 1903; 19,435 of 1905; 255, 18,602 of 1906.

**Collodionising and Rendering Suitable for Transport.**—English Patents, Nos. 23,986 of 1902; 15,696 of 1903; 6,814 of 1906; 15,536 of 1907; 2,572 of 1908; 4,860 of 1909; 11,459 of 1910.

**Machinery for "Burning Off," etc.**—English Patents, Nos. 25,171 of 1899; 4,302, 6,952, 12,413, 17,637, 24,218 of 1901; 24,032 of 1904; 6,432 of 1905; 6,556, 12,579 of 1907.

**Miscellaneous Patents.**—English Patents, Nos. 3,592, 9,806, 11,287, 16,581 of 1886; 6,236, 1,195 of 1887; 22,396 of 1893; 18,309 of 1894; 811, 4,324 of 1895; 6,919, 12,950, 18,800 of 1899; 4,707, 9,466, 9,733 of 1901; 11,042 of 1902; 14,687 of 1905; 6,814 of 1906; 2,240 of 1908; 27,354 of 1911; 19,668 of 1912.

A list of the patents granted in Europe and the United States, complete to 1902, is given by C. R. Böhm in "Das Gasglühlicht."

## CERIUM, LANTHANUM, AND DIDYMIUM

The oxides of these elements are important constituents of many minerals, such as **monazite**, **cerite**, **allanite**, and **gadolinite**, but at the present time, owing to the large quantity of cerium earths which are available as by-products in the manufacture of thorium nitrate, none of these minerals is utilised solely as a source of the oxides (see p. 299).

For many years there was no commercial outlet for the large quantities of rare earths thus obtained, which amount to about twelve times the quantity of thoria produced, and constitute 65 per cent. of the raw monazite, and hence thousands of tons remained on the works unutilised. It is true that the incandescent mantles contain about 1 per cent. of cerium oxide, but this only consumes a small fraction of the total amount available.

These rare earths, other than thoria, obtained from monazite, consist of about 45 per cent. cerium sesquioxide, 25 per cent. lanthanum oxide, 15 per cent. neodymium oxide, whilst oxides of yttrium and samarium constitute the remainder.

The following is a brief account of some of the uses to which these oxides have been put recently.

**Pyrophoric Alloys.**—In 1903, Auer von Welsbach, when conducting an investigation of the properties of the alloys obtained by reducing this mixture of rare earth oxides, found that, when filed, certain of these gave off a shower of bright sparks, which were sufficient to ignite inflammable gas. This discovery was patented (German Patent, 154,807, 1903, and English Patent, 16,853, 1903), and he disposed of his rights to a German company, for the sum of £30,000, and so started the pyrophoric alloy industry. At a later date, he found that this property was largely due to a superficial layer of oxide, which needed frequent renewal if the alloy was to retain its pyrophoric properties, and numerous patents were taken out covering methods for the production of this oxide layer (see English Patent, 8,163, 1909; French Patent, 407,117, 1909).

The necessity for these renewals has since been obviated by the discovery that alloys of the cerium earth metals with certain of the heavy metals, such as iron, nickel, manganese, and cobalt, have permanent pyrophoric properties. These properties are possessed, in particular, by alloys containing from 10-65 per cent. of iron, and experience has shown that the best results are obtained when using 35 per cent. of iron to 65 per cent. of the cerium earth metals ("Misch" metal). Alloys of this composition, known as "**Auer**" metal, form the sparking material of a large proportion of the automatic gas and cigar lighters now on the market. Various theories have been put forward to account for the pyrophoric properties of these alloys; one is that in striking the alloy small particles of metal are broken off, and the force of the percussion is sufficient to raise these to their ignition temperature.

In the production of these alloys many difficulties have been experienced, owing to the fact that the molten "Misch" metal is extremely reactive, combining readily with oxygen, nitrogen, and hydrogen, and removing oxygen from carbon dioxide and carbon monoxide; the reduction of the rare earth oxides to the metallic



state has, therefore, to be conducted in a vacuum. The process of manufacture is briefly as follows:—

If the rare earths, which have to be converted to the anhydrous chlorides, are in the form of carbonates, they can be directly dissolved in hydrochloric acid, but if they exist in the form of oxalates, they must be converted to hydroxides and dissolved in hydrochloric acid. The complete dehydration of the chlorides, thus produced, is a matter of considerable importance, as in the later stages much depends on the suitable preparation of the material. A product containing chlorides equivalent to 35-50 per cent. of oxides can be easily prepared by the use of calcium chloride as the drying agent, but in order to obtain a higher grade product it is necessary to employ the ammonium chloride process in order to avoid the formation of basic salts. This process consists in heating the cerium earth chlorides with ammonium chloride until the latter is completely volatilised. This operation is too costly to be employed unless the ammonium chloride is recovered. A full account of methods suitable for the production of these anhydrous chlorides is given by A. Hirsch (*Journ. Indus. and Eng. Chem.*, 1911, 3, 880).

The preparation of the anhydrous chlorides is usually undertaken by the manufacturers of pyrophoric alloys from the rare earths remaining as a by-product in the manufacture of thorium nitrate; these can be obtained in quantity at about 6d. per kilo. The calcined chlorides cost about 3s. per kilo, and the undehydrated product can be obtained, in Germany, at about 2s. per kilo.

The dry chlorides are next electrolysed in a graphite crucible using a large iron cathode. In order to conduct the manufacture of pyrophoric alloys on a remunerative scale it is necessary to have cheap electric power, and to work with a current of not less than 1,500 amperes.

According to the patent of W. Borchers and L. Stockem (German Patent, 172,529, 1905) the chlorides are mixed in the proportions represented by the formula  $CeCl_3 + CaCl_2$ , and the addition of a small quantity of fluorspar is recommended. In another method, described in German Patent 268,827, 1912, a mixture of the anhydrous cerium earth chlorides and oxychlorides, obtained by heating the hydrous chlorides to a high temperature, is treated with alcohol, the solution separated from the insoluble residue containing the oxychloride, and the anhydrous chloride is then recovered by evaporating the alcoholic solution. Organic matter is removed by heating the anhydrous chloride in a current of dry air.

Although the electrolysis of the cerium earth fluorides has been recommended for the production of these alloys, it has not proved satisfactory on a large scale, as the molten mass obtained is so viscid that the metal produced cannot collect as a regulus, but remains scattered throughout the whole mass.

For several years past, "Auer" metal has been manufactured in the United Kingdom from cerium earths imported from Germany. "Auer" metal, at the present time (June 1914), costs about 15s. per lb. in Great Britain, and this quantity will supply the sparking material for 1,300-1,800 automatic lighters. Each of these small pieces, termed "firestones," will give from 2,000-6,000 separate ignitions.

Pyrophoric alloys are also employed in several European armies for defining the flight of shells. The friction of the air during the flight of the shell causes the alloy to burst into flame shortly after leaving the gun.

On account of its extremely reactive nature, "Misch" metal has been employed for reducing certain refractory oxides, such as those of niobium, tantalum, and zirconium.

Another pyrophoric alloy containing cerium earth metals is "Kunheim" metal (French Patent, No. 405,021, 1909). This consists of a mixture of hydrides of these metals, together with a certain proportion of magnesium and aluminium.

The mixture of hydrides is quite stable both in air and at a fairly high temperature, but the individual hydrides are unstable in air and lose hydrogen at a red heat. It is produced by melting the "Misch" metal with the requisite quantity of magnesium and aluminium, and then heating the alloy, thus made, in a current

of hydrogen at a temperature of about 500° C., the operation being carried out in an electrically-heated muffle furnace. This treatment results in the conversion of a portion of the "Misch" metal into hydrides. The following is an analysis of the commercial pyrophoric alloy produced :—

	Per Cent.		Per Cent.
Cerium	36	Aluminium	1.0
Lanthanum	49	Iron	0.5
Didymium, etc.		Hydrogen	1.3
Magnesium	10	Silicon	0.5

For a full account of the manufacture, etc., of the above pyrophoric alloys, see the work by H. Kellermann.



FIG. 22.  
The "Whoop"  
Gas Lighter.

Pyrophoric alloys containing "Misch" metal alloyed with silicon, titanium, or boron have been patented (French Patent, 396,198, 1908, and English Patent, 27,341, 1908), and are claimed to be as efficient as the well-known ferro alloys. They can be produced by melting the metals in a magnesia crucible under a cover of sodium chloride. Pyrophoric cerium-tin alloys have been described by R. Vogel (*Zeits. anorg. Chem.*, 1911, 72, 319). The use of alloys consisting of the cerium earth metals together with one or more of the following metals:—Cadmium, zinc, tin, or lead, as pyrophoric substances, is covered by U.S. Patent, 1,102,575. The mixtures quoted as being suitable contain from 30-40 per cent. of the base metals. It is specially claimed for these alloys that they are not affected by air or moisture. A pyrophoric alloy consisting chiefly of manganese and antimony, together with 5 per cent. of "Misch" metal, has been patented (French Patent, No. 419,388, 1910), and is stated to be much cheaper to produce than "Auer" metal. A non-cerium pyrophoric alloy containing titanium is described on p. 327.

Alloys of "Misch" metal with mercury possess several interesting properties, but, so far, do not appear to have been put to any technical use. They can be produced (English Patent, 15,507, 1910; French Patent, 414,057, 1910) by heating the finely-divided "Misch" metal in a closed vessel with mercury vapour at a temperature of 500°-600° C. Alloys of this type containing 10-16 per cent. of "Misch" metal spontaneously ignite in air, giving off bright sparks.

Typical forms of automatic lighters are shown in Figs. 22 and 23.

The general principle of all these is that a piece of hard steel, having a roughened edge, is made to strike the alloy, thus causing it to give off a shower of bright sparks which ignite an inflammable substance (gas, petrol, benzene, or tinder) placed in close proximity.

According to a recent estimate, about 200 tons per annum of the cerium earth oxides are used in the manufacture of pyrophoric alloys.

**Uses of Cerium Compounds in the Lighting Industry.**—Salts of cerium, particularly the fluoride, are largely employed in the preparation of electrodes for "flame arc" lighting. For certain types of electrodes the cerium

fluoride is mixed with calcium fluoride, and a small quantity of sodium phosphate or borate is added in order to increase the fusibility of the mixture.

According to French Patent, No. 431,040, of 1911, the mixture may contain fluorides of the rare earths, together with compounds of the alkalis with tungsten or molybdenum. The use of a cerium pyrophoric alloy as a core for "flaming" arc carbons is covered by English Patent, No. 8,151, of 1909, whilst a mixture of the cerium earths and carbon is mentioned in English Patent, 8,151, of 1909 (see also French Patent, 414,707, of 1910).

**Cerium Titanofluoride** is also employed in this manner (English Patent, No. 13,988, 1912). In this case it has been found necessary to add sodium or potassium fluoride in order to get a steady flame. The colour imparted to the flame by these salts is corrected by the addition of a barium compound. The following is stated to be a suitable mixture for the preparation of these electrodes: carbon 45, cerium titanofluoride 35, potassium fluoride 10, barium fluoride

10 per cent. In order to minimise the etching effect of the fluorides on the glass globes, a small percentage of either silicate, borate, tungstate, carbonate, or molybdate of sodium is added. A recent estimate places the consumption of cerium earth salts in flaming arcs at about 300 tons per annum.

**Cerium Carbide** has been tried as a filament for incandescent electric lamps (see *Electrical Engineer*, 1908, 48, 416) as also has the nitride (English Patent, 929, of 1906), but neither appear to have been satisfactory.

**Separation of Ceria from the Associated Oxides.**—Few of the preceding uses for the cerium earths necessitate the separation of any individual oxide from the mixture obtained as a by-product in the manufacture of thorium nitrate. For certain purposes, however, it is necessary to obtain cerium compounds in a state of purity, and the following are some of the more important methods which may be employed for the separation of cerium from its allies.

A process often employed is to convert the cerium earths into nitrates, and to treat the solution of these with excess of potassium permanganate in the presence of a basic substance such as sodium carbonate or magnesia (German Patent, 143,106; see also Beyer, *Zeits. anorg. Chem.*, 1903, 37, 378, and G. P. Drossbach, *Ber.*, 1896, 29, 2,452). The process is essentially the same as that described on p. 321 for the estimation of cerium. The product obtained is quite pure, except for about 0.5 per cent. of didymium oxide.

Cerium can also be separated from the other rare earths by suspending the hydroxides in a solution of potassium hydroxide, and passing in a current of chlorine until the solution is no longer alkaline. Ceric hydroxide is formed, and remains undissolved, whilst the other rare earths are converted to soluble chlorides or hypochlorites (see P. Mengel, *Zeits. anorg. Chem.*, 1899, 19, 67).

The mixed oxides may also be dissolved in hot nitric acid, and the solution evaporated down with ammonium nitrate until ceric ammonium nitrate separates out (see Welsbach, *Monatsh.*, 1884, 5, 508, and Schottlander, *Ber.*, 1892, 25, 378).

**Cerium Nitrate** is used to a small extent in the manufacture of incandescent mantles (see pp. 304 and 307), and for this purpose it should conform to approximately the same standard of purity as that required for thorium nitrate (see p. 302).

The cerium compound obtained in a state of purity by any of the foregoing processes is converted to the hydroxide by treatment with solution of potassium hydroxide. The precipitate thus obtained is filtered, washed, dissolved in nitric acid, and evaporated to crystallisation. If the aqueous solution is slowly evaporated, granular masses of the nitrate are obtained, but if crystals are required, the solution must be evaporated nearly to crystallisation, rapidly cooled, after having added a crystal of the nitrate. The salt, being deliquescent, must be rapidly drained, and dried by pressure.

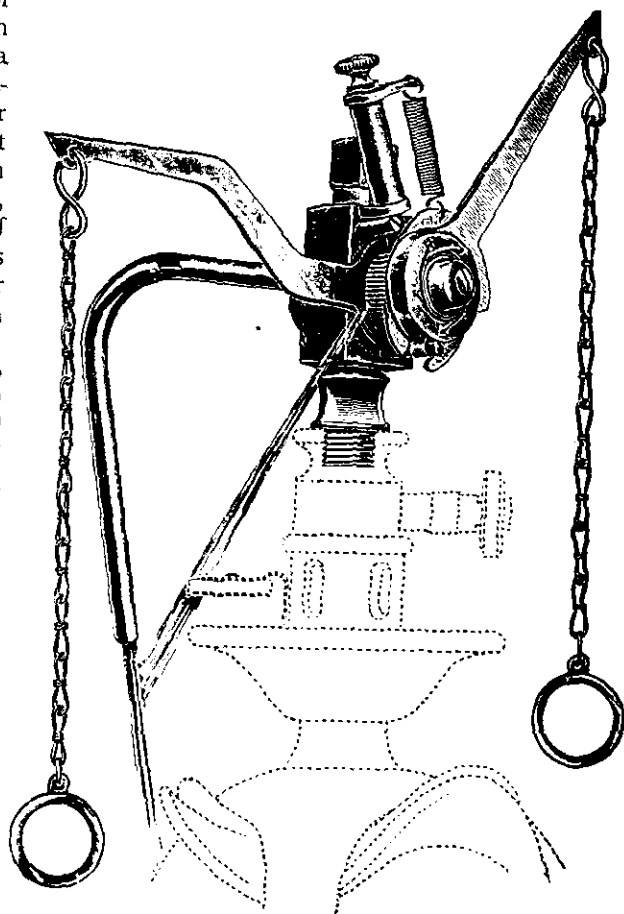

FIG. 23.—Automatic Lighter for Inverted Burners.

### Minor Uses for the Cerium Earths and their Salts

Numerous attempts have been made to utilise the reducing power of cerous compounds in the **textile industry**, a recent example of which is the following:—

The yarn is treated with a solution of cerous chloride (sp. gr. 1.16-1.26), dried and passed through a bath of strongly alkaline sodium hypochlorite. After being again dried, it is woven with untreated yarn, and when the fabric thus produced is treated with a direct cotton dye and then run through an acid bath, the treated fibres lose their colour, and so a variegated pattern is produced (German Patent, 241,469, 1911). When "vat" or "thio" colours are used the reverse change takes place.

The cerium earth oxides have recently been suggested for use, with tin compounds, for weighting silk (E. Stern, *Zeits. angew. Chem.*, 1914, 27, 357).

**In leather dyeing**, salts of the cerium earths have been employed as mordants (see F. Garelli, *Collegium*, 1912, 418, and W. Eitner, *Gerber*, 1911, 37, 199 and 213).

As a **base for dyestuffs** of the alizarin group, certain cerium salts are stated to be very suitable (see O. N. Witt, *Chemische Ind.*, 1896, 19, 156; also C. Baskerville and T. B. Foust, *Journ. Soc. Chem. Ind.*, 1904, 23, 104).

**In glass manufacture** several of the cerium earths have been employed as colouring agents. Thus, if 1 per cent. of cerium oxide be added to potash glass, a clear yellow colour results, which is intensified as the quantity is increased, and finally becomes brown. **Neodymium** and **praseodymium**, the two oxides which constitute the mixture often termed didymium, are sometimes used in the manufacture of blue optical glass (see O. Schott, *Jahres. über Fortschr.*, 1889, 42, 2685, and German Patent, 103,441).

**Porcelain** is sometimes coloured by the addition of phosphates of **neodymium** and **praseodymium**; the former giving an amethyst-red colour, whilst the latter produces a bright green (see W. Muthmann, Weiss, and H. Heramhof, *Annalen*, 1907, 355, 144).

The separation of the oxides of neodymium and praseodymium from the other cerium earth oxides found in monazite is a somewhat lengthy process, and the products obtained are not of sufficient technical importance to justify a full description here. Two general methods may be employed—(1) Fractional precipitation, utilising the difference in basicity of the metals (see W. Muthmann and H. Rolig, *Ber.*, 1898, 31, 1718; R. J. Meyer and E. Marckwald, *Ber.*, 1900, 33, 3009; G. P. Drossbach, *Ber.*, 1902, 35, 2826; Urbain, *Ann. Chim. Phys.*, 1900, 19, 184). (2) By means of fractional crystallisation (see Dennis and Chamot, *Journ. Amer. Chem. Soc.*, 1897, 19, 779; C. Scheele, *Ber.*, 1899, 32, 409; Demarcay, *Comptes rend.*, 1900, 130, 1019 and 1185; R. J. Meyer, *Zeits. anorg. Chem.*, 1904, 41, 94; Muthmann and Weiss, *Annalen*, 1904, 331, 1).

The cerium earths have been found suitable for use as **catalysts** in many chemical operations. Thus, in the formation of sulphuric acid from sulphur dioxide and oxygen, crude cerium earth sulphates may be employed (German Patents, 142,144 and 149,677).

The use of the chlorides of the cerium earths for the production of chlorine from a mixture of hydrochloric acid and air has been patented (German Patent, 150,226). The gaseous mixture is passed over the chlorides, which are heated to a temperature of 350°-480° C.

**In photography**, ceric sulphate has been suggested for use in reducing the density of negatives (German Patent, 123,017). It has also been found that paper soaked in cerium sulphate, or nitrate, is sensitive to light, and the image produced can be developed by means of phenol or amido-benzoic acid (see A. and L. Lumière, *Comptes rend.*, 1893, 116, 574).

**In medicine**, the mixed cerium earth oxalates have been used to minimise

nausea, and didymium salicylate has been sold under the name of "Dymal" as a non-irritant antiseptic dressing for wounds.

Cerium sulphate has been patented as a constituent of an electric accumulator (English Patent, 21,566, 1900; see also *Zeits. Elektrochem.*, 1902, 298). It was found by W. Krilitschewsky ("Zur Kenntniss des Cersulphat Akkumulators," Halle a/S., 1904) that cerium sulphate accumulators had certain advantages over those made of lead.

For a full account of the various uses to which the cerium earths may be put, see C. R. Böhm, "Die Verwendung der Seltene Erden," Leipzig, 1913.

### Estimation of Cerium in Minerals and Alloys

In view of the increasing use of cerium compounds in chemical technology, methods for the estimation of this constituent may be here briefly quoted, but it is impossible, in the space available, to give an adequate account of all the processes which have been employed.

The mineral is first attacked either by heating it with sulphuric acid or by fusion with potassium bisulphate. After treating with water, filtering, and well washing the insoluble matter, the thorium and cerium earths are precipitated as oxalates (see p. 298). The oxalates are filtered off, washed, transferred to a beaker, and boiled with fuming nitric acid until completely decomposed, and the cerium in this solution is separated by conversion to the hydrated ceric oxide. This can be accomplished by several processes, some of which are outlined below.

**Chlorine Process.**—This method, originally introduced by Mosander (*Journ. prakt. Chem.*, 1843, 30, 276), consists in suspending the rare earth hydroxides in a 5 per cent. solution of potassium hydroxide, and passing a current of chlorine through the solution until it is no longer alkaline, and the precipitate has attained a bright yellow colour. This treatment causes the cerium to be precipitated as the insoluble ceric hydroxide, whilst the remaining rare earths pass into solution as chlorides and hypochlorites. After being allowed to stand for a few hours the solution is filtered, the precipitate well washed, dissolved in hydrochloric acid, and the above treatment repeated. The ceric hydroxide is finally dissolved in hydrochloric acid, precipitated as oxalate, and weighed, after ignition, as the dioxide  $CeO_2$ . A modification of the above process, introduced by E. Browning and E. J. Roberts (*Amer. Journ. Sci.*, 1910, 29, 45), consists in using bromine in place of chlorine.

**Permanganate Process.**—The oxidation of the cerous compounds can also be carried out by means of potassium permanganate. The solution of the rare earths, which must contain only nitrates, is made nearly neutral with sodium carbonate, heated to boiling, and then a dilute solution of potassium permanganate is run in slowly until the pink colour begins to become permanent. A mixture containing potassium permanganate and sodium carbonate, in the ratio of 1 molecule to 4 molecules, is run into the boiling solution until an excess of potassium permanganate is present. When the reaction is complete the precipitated hydroxides of cerium and manganese are filtered, washed, dissolved in hydrochloric acid, and the treatment repeated. The precipitate finally obtained is dissolved in hydrochloric acid, and the cerium separated from the manganese by precipitation as the oxalate, which, after ignition, is weighed as the dioxide  $CeO_2$ . A full account of this method is given by E. J. Roberts (*Amer. Journ. Sci.*, 1911, 31, 350).

**A Volumetric Process** for the estimation of cerium in the presence of lanthanum and didymium has been introduced by G. von Knorre (*Zeits. angew. Chem.*, 1897, 10, 685, and *Ber.*, 1900, 33, 1924). The process is based upon the fact that ceric salts are reduced to cerous by hydrogen peroxide, and that ammonium persulphate in sulphuric acid solution converts cerous salts to ceric. To the solution of cerous salts in dilute sulphuric acid 2 g. of ammonium persulphate is added, the solution heated to boiling, cooled to 50° C., a further quantity of 0.5 g. of persulphate added, the solution boiled for five minutes, cooled, another 0.5 g. of persulphate added, and the solution finally boiled for fifteen minutes with the addition of a further quantity of sulphuric acid in order to decompose the remaining persulphate. After cooling the solution, excess of a standard solution of hydrogen peroxide is added, and the amount not utilised in reducing the ceric sulphate is estimated by titration with a standard solution of potassium permanganate. The reduction of the ceric salt may be expressed as follows:—



For details of the precautions which are necessary in the carrying out of this determination the original papers should be consulted.

A process for the analysis of pyrophoric alloys has been described by H. Arnold (*Analyst*, 1914, 39, 415).

**Acknowledgments.**—The author is indebted to Messrs W. Still & Co., of Charles Street, Hatton Garden, E.C., for details concerning the manufacture of the special mantles used for railway and incandescent oil lighting, and to Messrs Falk, Stadelmann & Co., of London, for the loan of illustrations of automatic gas lighters.

## SECTION LXXVIII

# TITANIUM

BY SYDNEY J. JOHNSTONE, B.Sc. (Lond.)

### LITERATURE

- B. STOUGHTON.—“Notes on Titanium and on the Cleansing Effect of Titanium on Cast Iron.” *Bull. Amer. Inst. Min. Eng.*, 1912, 1245-75. (Includes a useful bibliography on titanium and its uses.)
- “Distribution and Use of Titanium Ores.” *Bull. Imp. Inst.*, 1911, 9, 134-45.
- A. J. ROSSI.—“Titaniferous Ores in the Blast Furnace.” *Trans. Amer. Inst. Min. Eng.*, 1893, 21, 832-67.
- “The Manufacture of Titanium and its Alloys.” *Mineral Industry*, 1900, 9, 715.
- G. B. WATERHOUSE.—“Influence of Titanium on Segregation in Bessemer Rail Steel.” *Proc. Amer. Soc. for Testing Materials*, 1910, 10, 201-11.
- R. W. HUTCHINSON.—“High Efficiency Electrical Illuminants.” New York, 1911. Pp. 148-65.
- E. KNECHT and E. HIBBERT.—“New Reduction Methods in Volumetric Analysis.” London, 1910.
- E. VON MALTITZ.—“Der Einfluss des Titans auf Stahl, besonders auf Schienenstahl.” *Stahl und Eisen*, 1909, 29, 1593.
- “Titanium Salts in Leather Manufacture.” *Leather Trades' Review*, 1913, 46, 183 and 266.
- F. L. HESS.—“Titanium.” *Min. Res. United States*, 1911, pt. i., p. 954
- J. T. SINGEWALD.—“Titaniferous Iron Ores of the United States and their Economic Value.” *U.S. Bureau of Mines, Bull.* 64. (Washington, 1913.)
- T. CROOK and SYDNEY J. JOHNSTONE.—“Strüverite from the Federated Malay States.” *Min. Mag.*, 1912, 16, 224.

TITANIUM is often described as being one of the rarer metals, but this is hardly correct, as it constitutes one of the ten most common metals found in a state of combination on the earth's surface. Its oxide is a constituent of many soils and plant ashes.

### Natural Occurrence

The most common mode of occurrence of this element in nature is as the dioxide ( $\text{TiO}_2$ ), either alone as the mineral rutile, or in combination with ferrous oxide as the mineral ilmenite.

**Rutile** usually occurs as a black or reddish-brown mineral having a specific gravity of about 4.3, and containing 98-99 per cent. of titanic oxide ( $\text{TiO}_2$ ), together with 1-2 per cent. of ferric oxide ( $\text{Fe}_2\text{O}_3$ ).

**Ilmenite**, or titaniferous iron ore, is an iron-black mineral having a specific gravity of about 4.5 and containing a maximum of 52.7 per cent. of titanic oxide ( $\text{TiO}_2$ ) and 47.3 per cent. of ferrous oxide ( $\text{FeO}$ ), corresponding to a formula  $\text{FeO}, \text{TiO}_2$ .

Other minerals containing a large percentage of titanic oxide are **sphene** or **titanite** (silicate of calcium and titanium), and **brookite** ( $\text{TiO}_2$ ).

Another mineral called **strüverite**, containing a large but variable percentage of titanium, has been found recently in South Dakota, U.S.A., Federated Malay States, Madagascar, and also in Piedmont, Italy. A paper by T. Crook and the author describing this mineral, as found in the Federated Malay States, and its chemical analysis, will be found in the *Min. Mag.*, 1912, 16, 224.

Analyses of typical specimens of certain of these minerals are given in the following table:—

TABLE X.

	Formula.	1.	2.	3.	4.	5.
		Picro- ilmenite. Ceylon.	Ilmenite. Carolina. Ilmen Mts.		Sphene. George- town, D.C.	Strüverite. Fed. Malay States.
		Per Cent.	Per Cent.	Per Cent.	Per Cent.	Per Cent.
Titanium dioxide - -	TiO <sub>2</sub>	64.72	52.73	45.93	40.82	45.74
Ferrous oxide - - -	FeO	16.59	33.08	36.52	...	8.27
Ferric oxide - - -	Fe <sub>2</sub> O <sub>3</sub>	2.66	8.08	14.30	...	...
Lime - - - - -	CaO	...	...	...	28.08	...
Magnesia - - - -	MgO	15.76	5.33	0.59	0.40	...
Silica - - - - -	SiO <sub>2</sub>	0.70	...	...	30.10	0.20
Manganous oxide - -	MnO	0.42	...	2.72	...	trace
Niobic oxide - - -	Nb <sub>2</sub> O <sub>5</sub>	...	...	...	...	6.90
Tantallic oxide - -	Ta <sub>2</sub> O <sub>6</sub>	...	...	...	...	35.96
Stannic oxide - - -	SnO <sub>2</sub>	...	...	...	...	2.67
Water - - - - -		...	...	...	0.54	0.50

1. "Report on Mineral Survey of Ceylon," Col. Rep. Misc. Ser., Cd. 3,762.

2, 3, 4. Dana's "Mineralogy," 6th Edition, pp. 218 and 712.

5. S. J. Johnstone, *Min. Mag.*, 1912, 16, 224.

Of the minerals described above the most common form is **rutile**, but large deposits are rarely found. On the other hand the less pure **ilmenite** is known to occur in large quantities in many localities. Titanic oxide is also a minor constituent of many iron ores and bauxites.

### Geographical Distribution of Titanium Ores

In view of the somewhat limited demand at the present time for titanium minerals, it will suffice to mention only those deposits which have been already worked to some extent.

In **Europe**, the deposits of rutile near Kragero, situated to the north-east of Kristiansund, in Norway, yield about 50 tons per annum of high grade rutile concentrates.

In the **United States**, rutile deposits have been worked for some years at Roseland, near Arrington, Nelson County. The mineral here constitutes about 4 per cent. of certain pegmatite dykes, and by crushing and concentration a product containing over 98 per cent. of rutile is obtained ("Mineral Resources of United States," 1908, pt. i., p. 744).

In the **Australian Commonwealth**, small quantities of rutile have been produced from Talunga, South Australia ("Records of Mines, S. Australia," 1908, 356).

**Commercial Value of Titanium Minerals.**—As with many of the less commonly used minerals, this is largely a matter of negotiation between buyer and seller.

In Great Britain there is very little demand for titanium minerals, even of the highest grade. In the United States titaniferous iron ore from the Adirondack Mountains, which has 14.45 per cent. TiO<sub>2</sub>, is reported to be sold for the manufacture of ferro-titanium at £1 to £2 per ton (nominal) according to the titanium content.

The sale of rutile concentrates appears to be on a somewhat more definite basis, but the demand is small. According to one of the largest producers, they are selling three grades of ore:—A grade, containing 95 per cent. of titanium dioxide (TiO<sub>2</sub>), and only traces of iron, at \$160 per ton (2,000 lbs.); B grade, which contains 75-80 per cent. of TiO<sub>2</sub>, and the remainder chiefly iron,

sells at \$80 per ton; C grade, which is largely ilmenite, and contains 55-60 per cent. of  $TiO_2$ , sells at \$40 per ton.

**Statistics of Production.**—Complete returns are not available for the production of titanium ore, but the following figures may be of service:—

TABLE XI.

	1910.		1911.		1912.		1913.	
	Tons.	Value.	Tons.	Value.	Tons.	Value.	Tons.	Value.
Norway <sup>1</sup> - -	50	£ ...	76	£ 1,300	100	£ 1,900	...	£ ...
United States -	505	9,266	<i>Nil</i>	...	6,900	...	7,600	...

### Utilisation of Titanium and its Salts

Up to within a few years ago little use was found for titanium minerals. Numerous attempts had been made from time to time in the United Kingdom and elsewhere to smelt titaniferous iron ore on a commercial scale, but the majority of these were soon abandoned, and at the present time it is difficult to negotiate a sale in the United Kingdom of iron ore containing over 2 per cent. of titanite oxide.

The objections urged against the use of titaniferous iron ore is not that the iron obtained by smelting is of inferior quality, but that under the ordinary working conditions of the blast furnace a pasty slag is produced, and aggregations of titanium nitride and cyanide collect in the higher portions of the furnace. It has been shown, however, that under suitable working conditions the smelting of these ores is commercially possible. This is demonstrated by the fact that iron ores carrying from 8-15 per cent. of titanite oxide were smelted successfully for a period of twenty years in the Adirondack Mountains, New York State. Exhaustive articles dealing with the smelting of titaniferous iron ores are given by W. M. Bowron, *Trans. Amer. Inst. Min. Eng.*, 1882, 11, 159; A. J. Rossi, *idem*, 1893, 21, 832; E. von Maltitz, *Stahl und Eisen*, 1909, 29, 1593; and *Bull.* 64, *U.S. Bur. Mines*.

**Ferro Alloys.**—One of the most important uses of titanium minerals at the present time is for the production of ferro alloys, which are used in the final purification of steel and cast iron.

Many processes for the production of ferro-titanium have been suggested and tried on a small scale; references to these will be found in the bibliography given at the conclusion of the article by B. Stoughton, quoted above.

For the industrial production of ferro-titanium two general processes are in use, one or other of these being employed according to the nature of the alloy desired. For the production of alloys in which the presence of carbon is not objectionable, the process of Rossi can be employed (see U.S. Patents, 609,466-7, 1898; 648,439, 1900; 668,266, 1901; 721,467, 1903; 802,941, 1905; 822,305, 1906; 877,518, 1908; 935,863, 979,393-4, 986,505, 992,422-3, 1911; 1,003,805-7, 1,019,526-31, 1,020,512-7, 1,022,595-600, 1,022,799, 1,023,331-4, 1,024,476, 1,025,426, 1,028,389, 1,029,637, 1,032,432, 1,039,672).

In this process the finely pulverised titaniferous iron ore is mixed with charcoal and heated in an electric arc furnace of the Siemens type to a temperature of not less than 1,927° C. (3,500° F.). This yields an alloy containing 15-18 per cent. titanium, 5-8 per cent. carbon, and the balance iron.

The second type of process is employed if an alloy free from carbon is desired, the reduction being performed by some substance other than carbon, and for this purpose aluminium is frequently used.

A quantity of scrap aluminium is melted in an electric furnace, into which is charged the requisite quantity of scrap iron or high grade iron ore, the latter

<sup>1</sup> Chiefly rutile.



being employed if an alloy quite free from carbon is required. In either case a layer of molten iron forms at the bottom of the bath, and on this the aluminium floats. Upon this layer is charged rich titaniferous iron ore, which is immediately reduced to the metallic state, and combines with the iron already in the bath. So much energy is evolved during this reaction that little current has to be supplied in order to maintain the bath at reaction temperature. The process is capable of yielding alloys containing up to 75 per cent. of titanium, with only 0.12-0.80 per cent. of carbon. A full description of the process is given in *Electrochemical Industry* (New York), 1903, I, 527.

According to a recent patent of A. J. Rossi (U.S. Patent, 1,039,672, 1912), **carbide of titanium** is quite as efficient as a steel purifier if intimate mixture with the molten metal is effected.

It is claimed that the alloy is cheaper to produce than ordinary ferro-titanium. The composition of such an alloy is shown in column 5 of the following table:—

TABLE XII.

	Formula.	Ferro-Titanium.					
		1.	2.	3.	4.	5.	6.
		Per Cent.	Per Cent.	Per Cent.	Per Cent.	Per Cent.	Per Cent.
Titanium - - - -	Ti	10.28	25.17	35.64	17.79	22.21	23 to 25
Carbon - - - -	C	0.28	0.59	0.75	7.46	0.80	<i>Nil</i>
Phosphorus - - - -	P	0.09	0.06	0.06	0.05	trace	0.05
Sulphur - - - -	S	0.01	0.01	...	0.08	trace	0.01
Aluminium - - - -	Al	...	...	...	0.80	7.27	5.0
Silicon - - - -	Si	...	...	...	1.41	0.92	1.0

1, 2, 3. A. J. Rossi, *Mineral Industry*, 1900, 9, 720.

4. Product of Titanium Alloy Manufacturing Co., made under U.S. Patent, 1,039,672, 1912.

5. Product of Titanium Alloy Manufacturing Co., made under U.S. Patent, 648,439, 1900.

6. Made by Goldschmidt process.

Another form in which titanium is employed to a limited extent in the steel industry is that of titanium "Thermit." This consists of an intimate mixture of titanic oxide and metallic aluminium, which, when added to the molten steel, reacts to give metallic titanium.

**Ferro-titanium** has been largely used in the United States, particularly during the last few years, in the final treatment of steel. Its efficiency as a purifying agent is stated to be due largely to the great affinity which titanium has for nitrogen and oxygen at temperatures above 800° C. Nitrogen in steel, according to the observations of various workers, tends to cause brittleness and segregation of sulphur and phosphorus in the finished product. The titanium is not added to the steel in order to give the latter new properties, as are many other metals, such as tungsten, molybdenum, nickel, tantalum, chromium, etc., but only as a cleanser, and in the finished steel practically no titanium remains. The alloy which finds most frequent use for this purpose is one containing from 15-18 per cent. of titanium; alloys containing much larger percentages of titanium are difficult to use owing to their high melting point. The amount of the alloy to be added to each ton of steel as it runs into the ladle after recarburisation varies largely with the nature of the final product. When treating low carbon steels, such as those used for wire or plate, from 2-4 lbs. of ferro-carbon titanium is used per ton of steel, whilst for rail steel about 15 or 20 lbs. is used. From 4-8 lbs. of the alloy is added to each ton of steel castings, whilst 8-10 lbs. is used for axle steels.

This treatment has been applied with considerable advantage to Bessemer, open hearth, crucible, and even electric steel. It has also been applied with equally satisfactory results to cast iron.

The gradually widening use of these alloys in steel manufacture is demonstrated by the fact that in 1912, in the United States of America alone, over 550,000 tons

of titanium-treated steel was produced, whereas the quantity so treated in 1910 and 1911 was 326,300 and 410,600 tons respectively. These quantities are exclusive of cast iron so treated.

Articles dealing with the properties and advantages claimed for titanium-treated steel will be found in articles by R. Moldenke, *Trans. Amer. Foundrymen's Assoc.*, 1908, 17, 57; W. Venator, *Stahl und Eisen*, 1910, 30, 650; *Journ. Indust. and Eng. Chem.*, 1910, 2, 299.

Alloys of titanium with the non-ferrous metals have been employed in small quantity in the past.

An alloy of copper and titanium containing 5-12 per cent. of the latter constituent has been used for improving copper castings. The addition of 1-2 per cent. of this alloy to the molten copper is said to be of great advantage, as the metal can then be cast in sand without difficulty. The alloy also eliminates oxides and absorbed gases, and gives the casting a close dense structure free from blowholes. The influence of titanium on copper and its alloys is discussed by F. O. Bensele (*Metal und Erz*, 1914, 11, 10 and 46). The addition of titanium to aluminium to the extent of about 2 per cent. is said to greatly increase the toughness and resiliency of the metal, but the product is stated to be of somewhat doubtful durability.

Silico-titanium is prepared for use in the steel industry, when it is desirable to add silicon as well as titanium, by smelting a mixture of rutile, carbon, and silver sand in an electric arc furnace (*Journ. Soc. Chem. Ind.*, 1910, 29, 636; French Patent, 407,858, 13th October 1909).

Alloys can be made in this way containing 20-75 per cent. of silicon and 5-70 per cent. iron (see also United States Patent, 1,019,526).

**Metallic titanium**, other than in the form of its ferro alloys, has, so far, been put to but few uses. The metal, which has a specific gravity of about 4.8 and a silver-white colour, is hard and brittle when cold, but can be readily forged when red hot. Its observed melting point varies with different experimenters, but is probably between 1,795° and 1,810° C. When heated to 600° C. in oxygen it readily burns to the oxide  $TiO_2$ , as it also does in nitrogen at 800° C., yielding in the latter case several nitrides having the formulæ  $Ti_3N$ ,  $TiN$ ,  $Ti_2N_2$ , etc.

This property has been suggested as a means of fixation of atmospheric nitrogen, as the nitrides are stated to yield ammonia on treatment with steam or acids (French Patent, 387,002, 1908; English Patent, 1,842, 1908; United States Patents, 957,842-3).

Titanium has also been suggested as a constituent for non-cerium metal **pyrophoric alloys**. A suitable mixture, according to French Patent, 419,388, 1910, contains over 10 per cent. of both manganese and antimony, chromium not exceeding 20 per cent., and titanium not exceeding 15 per cent.

In the textile industry **titanous chloride**,  $TiCl_3$ , and **titanous sulphate**,  $Ti_2(SO_4)_3$ , are gradually finding an extensive use owing to their great power as acid-reducing agents.

**Titanous chloride** can be prepared by various processes, amongst which may be mentioned that of H. Spence (French Patent, 324,835, 1902), which consists in electrolytically reducing a hydrochloric acid solution of titanium hydrate in the cathode compartment of a divided cell. The anode employed consists of carbon plates in dilute hydrochloric acid and the cathode of lead plates.

In the dyeing of cotton goods with direct colours it sometimes happens that too deep a shade is obtained, or the colour is uneven, and it then becomes necessary to remove ("strip") it and re-dye the goods. This "stripping" can be performed, in a few minutes, by immersing the fabric in a solution containing an amount of titanous sulphate varying from 1-5 per cent. of the weight of material to be treated.

Certain dyes, such as primuline yellow, thioflavine S, cannot be stripped by this means, whilst the action is rather slow in the case of paranitraniline red and naphthylamine claret.

Titanous chloride and sulphate, which often come on to the market in the form of 20 per cent. solutions, are also used for clearing the whites of coloured goods when the colour has a tendency to "bleed" into the white. They find a similar use in laundry work for clearing articles that have "run" during washing, and are also employed to remove iron mould stains.

**Potassium titanium oxalate** is now used for the mordanting and dyeing of leather. Titanium salts unite with the tannin matter of leather to give a yellow

to brown titanium tannate, which is fast to light and soap (see J. Hurst, *Journ. Soc. Dyers*, 1903, 19, 105).

Basic sodium-titanium sulphate has been patented by M. C. Lamb for use in tanning (French Patent, 327,945, of 1902).

Titanium lactates have recently been employed as mordants and "strickers" in the leather industry under the name of "Corichrome."

A recent account of the uses to which the compounds have been put is given in *Leather Trades' Review*, 1913, 46, 183 and 266. The use and manufacture of these compounds is covered by English Patents, 22,629, 1901; 23,188, 1901; 14,921, 1902; 27,597, 1902; German Patents, 126,598, 1900; 136,009, 149,577; French Patent, 327,528, 1902. The solutions are prepared, according to English Patent, 22,629, 1901, by acting on freshly precipitated titanium hydroxide with lactic acid and an alkali, or if an excess of lactic acid is undesirable, the solution of titanium hydroxide in hydrochloric, sulphuric, or oxalic acid is acted upon by a lactate of a base which does not form an insoluble salt with the acid in which the titanium hydroxide is dissolved.

Various titanium salts have been employed as mordants for animal fibre (wool, etc.). Amongst these may be mentioned a solution of titanium tetrachloride ( $\text{TiCl}_4$ ) and cream of tartar.

A discussion of the advantages of titanium salts as mordants and their preparation will be found in papers by J. Barnes, *Journ. Soc. Chem. Ind.*, 1896, 15, 420; 1899, 18, 15. Their use for fixing colours on vegetable fibre is described in English Patent, 8,589, 1898.

General articles dealing with the use of titanium salts in dyeing will be found:—F. Erban, *Chem. Zeit.*, 1906, 30, 145; C. Dreher, *Textile Colourist*, 1903, 25, 4.

**Pigments.**—Titanium compounds have been employed for this purpose to a limited extent. A method of producing pigments from titaniferous iron ore has been patented (French Patent, 412,563, 12th February 1910). The process consists in roasting titaniferous iron ore so as to obtain a uniform product free from concretions, and then crushing in water. The colour of the pigment can be made to vary from yellow to red according to the conditions of roasting.

The light yellow pigments, stated to be suitable for use in rust-preventing paints, can be made by heating titaniferous iron ore with sulphuric acid and subsequently heating the mass to a temperature sufficient to decompose the sulphates (English Patent, 10,368, 1911).

Finely ground rutile is sometimes employed in the ceramic industry to give a soft yellow underglaze colour to porcelain ware. Titanic oxide is also employed for tinting artificial teeth. Recently, the addition of titanic oxide in quantity varying from 0.1-2.0 per cent. has been found to improve fused quartz ware, which is sold under the name of "T. siloxied."

**Illuminants.**—Titanium carbide produced in the electric furnace is employed to a small extent, in the United States, for the manufacture of electrodes for arc lamp lighting. These are produced by mixing the finely ground carbide with a suitable binder, and shaping the paste by hydraulic pressure. The rods so produced, after drying in a gas oven, are heated in a carbon tube electric furnace. The electrodes are next partly coated with copper to prevent oxidation during burning. The use of titanium carbide as electrodes has not found very extensive application, probably because the light is of a somewhat yellow character, and the operating costs are rather high (see also German Patent, 231,231, 1910). Another form of flame arc electrode consists chiefly of carbon, together with calcium titanate, an organic salt of titanium and a titanium halogen compound or alkali titanofluoride (U.S. Patent, 1,112,458, 1914). See also Cerium Titanofluoride, p. 318.

According to English Patent, 18,220, of 1912, a luminous arc electrode can be made from a mixture consisting of 96 per cent. of titanium carbide, 3 per cent. of copper oxide, and 1 per cent. of lithium fluoride. The latter substance is stated to steady the flame without imparting any undesirable colour. Titanic oxide, together with calcium cyanamide, cryolite, and carbon, is a mixture suggested for electrodes in English Patent, 11,792, of 1912 (see also English Patents, 2,027, 18,965, 1909; 17,278, 1910; 710, 17,723, 1911; 6,500, 1912).

Titanium carbide was used for the production of incandescent electric lamp filaments for a short time, but is now displaced by the more economical metallic filaments, tantalum and tungsten, *q.v.* Its initial efficiency was about 2.5 watts per candle power (English Patent, 14,852, 1908).

The "magnetite" arc lamp has its positive electrode composed of a mixture of magnetite and chromite, together with 15-25 per cent. of rutile, or an equivalent amount of ilmenite. This lamp can be operated only on a direct current circuit, as the magnetite must act as the positive electrode. This lamp, which has found favour in certain districts in the United States, and is now being used in this country, is said to give a very uniform distribution of light in the horizontal plane. For this use the minerals must be very finely ground, and to attain this end they are first crushed between rolls, and the final grinding is done in a ball mill.

### Analysis of Titanium Minerals and Salts

It is not possible in the space available to give an adequate account of the methods of analysis, but the following brief outline may prove of service.

The mode of estimating the quantity of titanium in a mineral varies largely with the amount and the nature of the other constituents present. Thus, the presence of tantalum, niobium, uranium, vanadium, or zirconium renders the gravimetric estimation of titanium a matter of considerable difficulty. A method suitable for the estimation of titanium in the presence of the first two elements has been described by the author in the *Min. Mag.*, 1912, 16, 224.

In the absence of vanadium and large quantities of iron, titanium can be estimated colorimetrically by the following process:—About 0.5-1.0 g. of the finely ground mineral is fused, at a low temperature, for about half an hour, with ten times its weight of potassium bisulphate. After being allowed to cool, the melt is crushed and extracted with about 200 c.c. of cold 5 per cent. sulphuric acid, to which has been added 10 c.c. of "10 volume" strength hydrogen peroxide. When the extraction is complete, the solution is filtered, the filtrate made up to 500 c.c., and the titanium in it estimated by the A. Weller colorimetric method (*Ber.*, 1882, 15, 2593). This consists in matching the colour of the solution against that produced when hydrogen peroxide is added to a standard solution of a titanium salt. The accuracy of the estimation is seriously affected by the presence of fluorides, and to a less degree by potassium sulphate and iron salts. A full account of this method is given by W. F. Hillebrand in "The Analysis of Carbonate and Silicate Rocks," *Bull.* 422, *United States Geol. Sur.*, pp. 128-34.

This method is accurate for minerals containing up to 10 per cent. of titanic oxide, but if used for estimating larger amounts it is not reliable, owing to the difficulty of matching the colours produced by strong solutions, or the error introduced by the large dilutions necessary if weak solutions are employed.

In the absence of compounds such as salts of niobium, vanadium, or uranium, which, in the reduced state, are oxidised by ferric salts, titanium can be estimated by reducing it to the titanous condition by means of zinc in acid solution, and then titrating with a solution of ferric alum, in an inert atmosphere, using ammonium thiocyanate as indicator. The reaction proceeds in accordance with the equation—

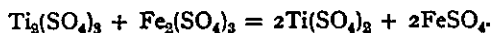

This method is of value, as it permits of the rapid and accurate estimation of titanium in the presence of iron compounds. The reduced solution can also be titrated with a standard solution of potassium permanganate, but, in this case, allowance must be made for any iron present.

For a full account of the processes available for the estimation of titanium and its separation from other elements see "Die Analyse der Seltenen Erden und der Erdsäuren," by R. J. Meyer and O. Hauser (Stuttgart, 1912). Methods of analysis of ferro-titanium are given in "The Chemical Analysis of Special Steels," by C. M. Johnson (London, 1909).

**Acknowledgments.**—The author is indebted to the Titanium Alloy Manufacturing Co., of Niagara Falls, U.S.A., for information concerning the use and manufacture of ferro-titanium; to Messrs Peter Spence & Sons Ltd., of Manchester, for details of the use of titanium salts in the textile industry; and to the British Thomson-Houston Company Ltd., of Rugby, for information relating to the "Magnetite" arc lamp. Statistics of the production and value of rutile concentrates in the United States were kindly supplied by the American Rutile Company, of Roseland, Nelson County, Virginia, U.S.A.

## SECTION LXXIX

# ZIRCONIUM

BY SYDNEY J. JOHNSTONE, B.Sc. (Lond.)

### LITERATURE

- L. WEISS and R. LEHMANN.—“Untersuchungen über Natürliche Zirkondioxyd.” *Zeits. anorg. Chem.*, 1909, **65**, 178 and 248.
- R. BAYER.—“Darstellung von Gefässen aus Zirkonerde.” *Zeits. angew. Chem.*, 1910, **23**, 485.
- E. WEDEKIND.—“Über Natürliche Zirkonerde.” *Ber.*, 1910, **43**, 290.
- E. WEDEKIND and S. J. LEWIS.—“Studien über das Elementare Zirkonium.” *Annalen der Chemie*, 1910, **371**, 366, and 1913, **395**, 149.
- C. R. BÖHM.—“Die Technische Verwendung der Zirkonerde.” *Chem. Zeit.*, 1911, **35**, 1261.
- R. J. MEYER.—“Die neueste Entwicklung unserer Kenntnisse von den Seltenen Erden.” *Zeits. Elektrochem.*, 1911, **17**, 633.
- C. R. BÖHM.—“Die Verwendung der Seltenen Erden.” (Leipzig, 1913.)
- H. C. MEYER.—“Zirconia, a New Refractory.” *Met. and Chem. Eng.*, 1914, **12**, 791.

ZIRCONIUM belongs to the same group in the periodic system as thorium, cerium, and titanium, but, at the present time, its commercial utility in nowise approaches that of any of these.

The oxide, zirconia, was first isolated in 1789 by Klaproth, from Ceylon zircon, but the metal was not produced until 1824, when Berzelius obtained it by reducing the double fluoride of potassium and zirconium with metallic potassium.

### Natural Occurrence

Zirconium does not occur in the metallic form in nature, but the ortho-silicate, **zircon**, is of fairly common occurrence in certain localities, and large deposits of the oxide, **baddeleyite**, have been located in Brazil.

**Zircon** is a silicate of zirconium, and, when pure, contains 66.2 per cent. of zirconia ( $ZrO_2$ ) and 33.8 per cent. of silica; impure forms also contain small quantities of iron oxide and combined water. It is found as a brown opaque mineral having a conchoidal fracture and an adamantine lustre. Zircon is sometimes found in clear forms which may be colourless, yellow, or red, and these are used as gemstones under the name of *hyacinth* (see p. 334). The specific gravity of ordinary zircon is about 4.7.

**Baddeleyite** was formerly a mineral of somewhat rare occurrence, but, during the last few years, fairly large quantities have been found in the gravels of the Sierra de Caldas of Minas Geraes. According to E. Wedekind, the mineral is available in three forms—(1) black glassy pieces; (2) broken stony fragments; (3) pebbles. Analyses of these three varieties are given in Table XIII. The commercial product is a mixture of all three forms, and has the composition shown in column 6. By crushing and sieving, the glassy variety can be freed from much of its iron oxide, which occurs in cavities in the mineral.

The percentage composition of the more important zirconium minerals is given in the following table:—

TABLE XIII.

	Zircon.		Baddeleyite.				
	1. Ceylon.	2. Norway.	3. Brazil. Glassy Variety.	4. Brazil. Stony Variety.	5. Brazil. Pebbles.	6. Brazil. Commercial Variety.	7. Ceylon.
	Per Cent.	Per Cent.	Per Cent.	Per Cent.	Per Cent.	Per Cent.	Per Cent.
Zirconia, $ZrO_2$ - -	66.35	64.05	94.12	88.40	74.48	68.93	98.90
Ferric oxide, $Fe_2O_3$ -	0.83	2.85	3.22	4.07	10.26	3.59	0.82
Titanic oxide, $TiO_2$ -	...	...	0.98	3.12	1.35	0.60	...
Lime, $CaO$ - -	...	...	...	...	...	...	0.06
Silica, $SiO_2$ - -	32.35	32.53	2.41	5.89	14.08	26.30	0.19
Water, $H_2O$ - -	0.23	...	...	...	...	0.80	0.28

1. "Rep. Mineral Survey Ceylon," Col. Rep. Misc. Series, Cd. No. 3,762, p. 60.

2. E. S. Dana, "Descriptive Mineralogy" (London, 1906), p. 485.

3 to 6. E. Wedekind, *Ber.*, 1910, 43, 290.

7. G. S. Blake, *Min. Mag.*, 1907, 14, 383.

**Preparation of the Mineral before Use.**—The commercial variety of baddeleyite, having the composition shown above, usually contains too much iron and silica to be used without previous treatment. The method of purification suggested by E. Wedekind consists in boiling the pulverised mineral in strong hydrochloric or sulphuric acid, which removes most of the iron and titanic oxides. When necessary, the silica is removed by treating the mineral with hydrofluoric and sulphuric acids, followed by ignition. This treatment is usually sufficient for most technical purposes.

If the pure oxide of zirconium is required, the method of L. Weiss, which is often technically employed, can be used. This process, which is suitable for treating either zircon or baddeleyite, is as follows: 50 kg. of baddeleyite or 70 kg. of zircon is intimately mixed with 150 kg. of sodium carbonate and 250 kg. of borax. The whole mixture is placed in a special cast-iron vessel, and heated in a reverberatory furnace. The melt is stirred frequently until decomposition is complete, and, after cooling, is finely ground and lixiviated with water. The insoluble matter, which contains the iron, titanium, and some sodium zirconate, is removed by filtration, and is reserved for further treatment. The solution, which has a specific gravity of about 1.16, is concentrated by the aid of steam in an iron boiler, until it has a specific gravity of 1.32-1.36, when it is allowed to cool and crystallise, with occasional agitation. The crystals obtained are sufficiently pure to be used without further treatment. The mother liquor is used for lixiviating further fusions, and the silica which accumulates is removed from time to time by passing carbon dioxide into the solution.

Another method, devised by R. Bayer (*Zeits. angew. Chem.*, 1910, 23, 485), consists in heating one part of the ground mineral with 2.5 parts of barium carbonate in a graphite crucible, which is placed in a wind furnace and the temperature maintained at about 1,400° C. for two hours. After cooling, the melt, which contains barium zirconate, is extracted with hydrochloric acid and the solution evaporated to dryness to precipitate silica. The residue is taken up in acid and let crystallise until first barium chloride, and later zirconium oxychloride, separate out. This latter substance is dissolved in water and the zirconium precipitated by ammonia.

### Industrial Utilisation of Zirconium and its Salts

Up to within a few years ago, little use was found for zirconium compounds. One reason against the development of their industrial employment was that the only commercial source of fairly pure zirconia was the mineral zircon, and the high cost of preparing the oxide from this material rendered its use impossible.

The already-mentioned discovery of large quantities of zirconium oxide in Brazil gave an impetus to the further investigation of the refractory properties of the material, and the greater proportion of the zirconia now utilised is obtained from this source.

**Refractory Materials.**—Pure fused zirconia ( $ZrO_2$ ) has a very low coefficient of expansion (linear = .00000084), and is, therefore, of service for the production of vessels of a refractory nature which are to be subjected to large or sudden changes of temperature. Vessels made of this substance can be plunged whilst white hot into cold water without risk of fracture. Owing to the high melting point of zirconia, considerable difficulty is experienced in making it into vessels, and most of the published processes include the use of some binding agent, often an alkali, to assist in fritting the mixture. A process described by L. Weiss (see above) for the manufacture of refractory crucibles consists in the use of a mixture of 90 parts of zirconia, 10 parts of magnesia, together with 10 per cent. of phosphoric acid as a binding agent. The ware, after firing in the electric furnace at a suitable temperature, is stated to be very resistant and practically unaffected either by molten alkali or potassium bisulphate.

Zirconia would appear to be very suitable for use as a furnace lining, owing to its resistance to the corrosive action of steel, copper, red brass, etc. Experiments have shown that the maintenance cost of a Siemens-Martin steel furnace, lined with crude zirconia, was only one-half of that entailed when linings of other refractory substances were used. Water-free tar may be used as a binding material.

Another process described by R. Bayer consists in making an intimate mixture of gelatinous zirconium hydroxide and raw zirconia (purified, as previously described, by crushing and treating with hydrochloric acid), together with the addition of a small quantity of starch paste as a binding agent. After being moulded to the desired shape, the crucibles are air-dried for several days, and then, after drying at  $100^\circ C.$ , they are heated in an electric resistance furnace of the Hempel type to a temperature of  $2,000^\circ-2,500^\circ C.$

**Metallic Zirconium.**—There are several practical difficulties associated with the production of this metal, as it combines readily with oxygen, nitrogen, carbon, silicon, etc., and therefore cannot be produced by reducing the oxide with carbon in the electric furnace, as this reaction yields the carbide. The difficulty in reducing the oxide, and the readily oxidisable nature and high melting point of the finely divided metal, make its production an expensive matter. It has been prepared by reducing potassium zirconium fluoride with metallic sodium in an iron cylinder, using a layer of fused potassium chloride as protective cover.

According to a recent communication by E. Wedekind (*Annalen*, 1913, 395, 149), unsatisfactory results are obtained by reducing the oxide with either metallic aluminium or magnesium, but a good yield of the metal is obtained by heating the oxide with metallic calcium shavings. The operation is carried out in an iron tube at a pressure of 0.1-0.5 mm. of mercury. The product of the reaction is treated successively with water, acetic acid, dilute hydrochloric acid, and water until free from calcium, and is then washed with acetone and dried *in vacuo* at  $300^\circ C.$  All these operations must be carried out in the absence of air.

Pure zirconium melts at about  $1,300^\circ C.$ , and has a specific gravity of about 6.4. It is not attacked by sulphuric or nitric acids, but is dissolved in the cold by hydrofluoric acid or aqua regia.

So far, little use has been found for metallic zirconium, but it has been tried as a filament for incandescent electric lamps (*Zeits. angew. Chem.*, 1910, 23, 2065).

**Ferro-Zirconium** is used, to a limited extent, in steel manufacture for removing nitrogen and oxides from the finished product, an alloy containing 20 per cent. of zirconium being added in amount equal to about 1 per cent. of the weight of steel treated (see English Patent, No. 29,376, 1910).

**Zirconia Quartz Ware.**—Recently small quantities of zirconia have been utilised in the manufacture of a variety of quartz ware termed "Siloxide" (French

Patent, No. 432,786, 1911). It is claimed that the addition of a small quantity of zirconia makes the ware more resistant towards the action of metallic oxides, particularly alkalis, and decreases its tendency towards devitrification on heating. The tensile strength is also said to be materially increased.

According to a recent paper by F. Thomas (*Chem. Zeit.*, 1912, 36, 25), the best resistance to devitrification is obtained with ware containing 0.5 per cent. of zirconia, and the best tensile strength with samples containing 1 per cent.

**Zirconium Carbide** has a metallic appearance, and is sufficiently hard to scratch quartz, but not ruby. It has been suggested as an agent for cutting glass and also for abrasive purposes.

It can be produced by heating zirconia with carbon in the electric furnace (H. Moissan and Lengfeld, *Comptes rend.*, 1896, 122, 651), or by similarly heating zircon with calcium carbonate and carbon, and then extracting the mass with dilute hydrochloric acid. A current of about 600 amperes is stated to be necessary (E. Wedekind, *Ber.*, 1902, 35, 3929; *Chem. Zeit.*, 1907, 36, 654).

**Pigments.**—The use of various zirconium compounds as white pigments has been patented by L. Weiss (German Patent, No. 235,495, 1910). Amongst those compounds mentioned as being suitable are the oxide, silicate, basic carbonate, phosphate, and basic sulphite. All these compounds have a good permanent white colour and covering power, and are non-poisonous. All are unaffected in colour by sulphuretted hydrogen, and mix well with the usual paint vehicles.

**Illuminants.**—Zirconia formed an important constituent of the glower of the Nernst lamp (see English Patents, 19,424 and 23,470, of 1897). Rods of zirconia form the incandescent substance of the Blériot lamp (German Patent, 174,313, 1906).

The use of zirconium carbide as a filament for incandescent electric lamps has been patented (German Patents, Nos. 133,701 and 148,257), but has not, so far, proved entirely satisfactory. According to English Patent, 5,412, of 1908, filaments may be made by mixing zirconium oxalate with a binder and sufficient carbon to reduce the oxalate. The use of zirconium nitrate, in place of thorium nitrate, for the manufacture of incandescent gas mantles has been patented, but the invention has not been a commercial success (English Patents, Nos. 1,681 and 4,000, of 1896).

**Other Uses.**—Basic zirconium acetate, or a mixture of soluble zirconium salts with sodium phosphate, has been patented for **weighting silk** (German Patent, No. 232,875). It has also been suggested that zirconia might replace some of the stannic oxide in enamels.

“**Kontrastin**” is the name under which pure zirconia is sold for the purpose of defining the intestines for X-ray photographs.

As **gemstones**, certain clear varieties of zircon have been utilised for many years under the names of **hyacinth**, **jargon**, and **Matura diamond**. The latter is produced by heating a brownish-yellow variety of zircon and so causing decolorisation. For further details, see “**Precious Stones**,” by M. Bauer (London, 1904).

**Commercial Value of Zirconium Ores.**—As there is only a very limited demand for zirconium minerals, there is little possibility of finding a market for any but those of the highest grade, and then only with difficulty. The prices at which the products made from the Brazilian mineral can be purchased are on a fairly definite basis. According to recent information (Jan. 1913), the following grades are offered for sale:—

TABLE XIV.

Grade Mark.	Zirconia. (ZrO <sub>2</sub> )	Ferric Oxide. (Fe <sub>2</sub> O <sub>3</sub> )	Silica. (SiO <sub>2</sub> )	Price per Metric Ton.
	Per Cent.	Per Cent.	Per Cent.	£.
“Crude” - - - -	85	...	...	31
“S” - - - - -	90-92	1	8	35
“N” - - - - -	90-92	7	1	36
“NS” - - - - -	98	0.8	1	50



The demand for zircon is much smaller than for the Brazilian baddeleyite, and sales are correspondingly more difficult to negotiate.

**Production.**—Statistics regarding the production of zirconium minerals are somewhat difficult to obtain, as the output, from most localities, is very interrupted. In 1911, Brazil produced 25 tons valued at £7,437, and small quantities are occasionally produced from the United States and Norway.

### Estimation of Zirconium in Minerals

Zirconium is usually estimated gravimetrically as the dioxide ( $ZrO_2$ ), which is precipitated from solutions of its salts, in a hydrated form, by excess of ammonia.

Practically all zirconium minerals have to be fused with about five times their weight of potassium bisulphate before they become soluble in acids. After fusion, the melt is leached with a 2 per cent. solution of sulphuric acid, and the insoluble residue separated by filtration, and again fused. The acid filtrates are then treated with sulphuretted hydrogen, any precipitate that may form is filtered off, washed, and the filtrate, after removal of sulphuretted hydrogen, is nearly neutralised with ammonia in the cold, and excess of a saturated solution of sodium thiosulphate added. After standing for a few minutes, the solution is heated to boiling for one hour, let stand for twelve hours, filtered, and the precipitate well washed with boiling water. This precipitate, which contains all the zirconium, tantalum, niobium, thorium, and titanium, also traces of iron and aluminium, is dissolved in hydrochloric acid, and the thorium removed from the solution as oxalate (see p. 298). The oxalate filtrate contains the titanium and zirconium, but in order to recover these the oxalate must be destroyed by evaporating the solution nearly to dryness with concentrated nitric acid. The bases are then precipitated by means of sodium thiosulphate as before. After filtration and washing well with hot water, the precipitate is dissolved in concentrated hydrochloric acid, and after diluting the solution with water, the titanium and zirconium are precipitated together by excess of ammonia. After filtration, and being well washed with water, the precipitate is ignited and weighed as  $ZrO_2 + TiO_2$ . The titanium dioxide in this precipitate can be estimated colorimetrically by the Weller method (see p. 329), and the zirconia obtained by difference.

Methods for the complete analysis of commercial ferro-zirconium have been described by W. Trautmann (*Zeits. angew. Chem.*, 1911, 24, 62), and also by M. Wunder and B. Jeanneret (*Zeits. anal. Chem.*, 1911, 50, 733).

## SECTION LXXX

# TANTALUM AND NIOBIUM

BY SYDNEY J. JOHNSTONE, B.Sc. (Lond.)

### LITERATURE

- A. SIEMENS.—“Tantalum and its Industrial Applications.” *Proc. Royal Instit. Gr. Brit.*, 1911, 19, 159.
- NICOLARDOT.—“L'Industrie des Metaux secondaires et des Terres Rares.” *L'Encyclopedie Scientifique*. Paris.
- W. VON BOLTON.—“Das Tantal, seine Darstellung und seine Eigenschaften.” *Zeits. Elektrochem.*, 1905, 11, 45.
- “Die Härte des geschmiedeten Tantals.” *Zeits. Elektrochem.*, 1905, 11, 503.
- “Das Tantal und die Tantallampe.” *Zeits. Elektrochem.*, 1905, 11, 722.
- “Occurrence and Uses of Tantalum.” *Bull. Imp. Inst.*, 1907, 5, 429.
- P. BREUIL.—“Tantalum.” *Mineral Industry* (New York), 1908, 17, 799.
- W. MUTHMANN, L. WEISS, and R. RIEDELBAUCH.—“Untersuchen über metallisches Vanadin, Niob, und Tantal.” *Annalen*, 1907, 355, 59.
- O. BRUNCK.—“Tantalelektroden.” *Chem. Zeit.*, 1913, 36, 1233.
- A. S. VAN TESLAAR.—“Tantalum, a New Metal in Dentistry.” *Dental Review* (Chicago), 1911, 25, 1210.

TANTALUM is one of those metals whose appearance in commerce, in a pure condition, is of comparatively recent date, and, owing to its peculiar properties, it seems likely that it will find a fairly wide range of utility.

Tantalic oxide ( $Ta_2O_5$ ) was first isolated, in 1802, by Hatchett, from a mineral obtained from Massachusetts, and the metal was produced in an impure form by Berzelius in 1824, by heating potassium fluotantalate with metallic potassium. Although tantalum belongs to the same group of elements as nitrogen, phosphorus, arsenic, antimony, bismuth, and vanadium, in its general properties it appears to have little in common with these elements.

### Natural Occurrence

Tantalum is found in nature only as the oxide ( $Ta_2O_5$ ), and is usually associated with variable percentages of the oxides of niobium, iron, and manganese. It is an essential constituent of about forty minerals, but of these only tantalite is of commercial importance.

**Tantalite** is the most important ore of tantalum, occurring usually as a black mineral having a specific gravity of 6.5-7.3, and crystallising in the ortho-rhombic system. When pure, its composition is represented by the formula  $FeO, Ta_2O_5$ , but in most specimens some of the tantalum is replaced by niobium (columbium), and some of the iron by manganese.

**Columbite** is the most commonly occurring mineral containing tantalum. It often occurs associated with tantalite, being essentially a niobate of iron and manganese of the formula  $(Fe, Mn)ONb_2O_5$ , and often crystallises in ortho-rhombic prisms whose specific gravity varies from 5.3-6.5. It has been observed that an increase in the percentage of tantalum in the mineral is accompanied by a proportionate increase in its specific gravity, and this relationship has been suggested as a means of roughly estimating the tantalum content of a mineral. Part of the niobium in the mineral is often replaced by tantalum.

Other minerals containing tantalum are **fergusonite** (niobate of yttrium and tantalum), **samarskite** (niobates and tantalates of iron, calcium, yttrium, and

cerium earths), **ytthro-tantalite** (niobates and tantalates of yttrium, iron, cerium earths, and uranium), **tapiolite** (iron tantalate). At the present time, however, none of these are utilised as commercial sources of tantalum, as the demand for tantalum minerals is small, being more than met by the supply of tantalite, and none but the highest grade of this mineral finds a sale.

### Geographical Distribution of Tantalum Ores

The most important producing localities are the Greenbushes and Pilbara districts of **Western Australia**. The mineral also occurs in certain of the tin-bearing districts in the Northern Territory of **South Australia**. In the **United States**, tantalite ores occur, and have been worked near Branchville, Connecticut, and in the Black Hills of Dakota. As a general rule, American tantalite contains from 10-40 per cent. of tantallic oxide, whilst the amount of this constituent present in the Australian mineral varies from 50-70 per cent.

Tantalum minerals have also been found in certain localities in Finland, Sweden, Norway, Russia, France, Bavaria, Italy, the Federated Malay States, Nigeria, and Ceylon, but at present none of these occurrences are of commercial importance as producers.

The composition of some typical tantalum ores is shown in the following table:—

TABLE XV.

	Formula.	Tantalite. 1.	Columbite, Ceylon. 2.	Samarskite.		Fergusonite.	
				Miask. 3.	India. 4.	Ytterby. 5.	Ceylon. 6.
		Per Cent.	Per Cent.	Per Cent.	Per Cent.	Per Cent.	Per Cent.
Tantallic oxide - -	Ta <sub>2</sub> O <sub>5</sub>	76.34	7.30	1.36	13.64	28.50	1.51
Niobic „ - - -	Nb <sub>2</sub> O <sub>5</sub>	7.54	67.35	47.47	39.76	29.66	46.06
Ferrous „ - - -	FeO	...	9.22	...	...	...	0.43
Ferric „ - - -	Fe <sub>2</sub> O <sub>3</sub>	13.90	2.05	11.02	12.15	0.76	...
Yttrium earth oxides-	Y <sub>2</sub> O <sub>3</sub> , etc.	...	...	12.61	15.80	33.47	41.22
Cerium „ - - -	Ce <sub>2</sub> O <sub>3</sub> , etc.	...	...	3.31	0.67	...	0.82
Uranium oxide - -	U <sub>3</sub> O <sub>8</sub>	...	...	11.60	12.09	2.24	3.92
Manganous „ - -	MnO	1.42	10.30	0.96	0.42	...	...
Lime - - - - -	CaO	...	0.36	0.73	1.07	4.40	...
Magnesia - - - -	MgO	...	...	0.14	0.07	...	...
Thoria - - - - -	ThO <sub>2</sub>	...	...	6.05	0.09	...	2.48
Titanium dioxide -	TiO <sub>2</sub>	...	2.90	...	1.70	...	0.07
Stannic oxide - -	SnO <sub>2</sub>	0.70	...	0.50	0.04	...	...
Lead „ - - - - -	PbO	...	...	...	0.68	...	...
Tungstic „ - - -	WO <sub>3</sub>	...	...	1.36	...	...	...
Zirconia - - - -	ZrO <sub>2</sub>	...	...	4.35	...	...	...
Water - - - - -	H <sub>2</sub> O	...	...	...	...	...	2.78

1, 3, and 5. *Mineral Industry*, 1908, 17, 800. 2. Col. Rep. Misc. Ser., Cd. 3,190, p. 30.  
4. *Bull. Imp. Inst.*, 1913, 10, 483. 6. Col. Rep. Misc. Ser., Cd. 3,190, p. 37.

The production of tantalum ore is small and variable. During 1909, ore valued at £327 was raised in Australia, but no production was recorded for 1910, 1911, 1912, or 1913.

**Commercial Value of Tantalum Ores.**—The demand for these ores at the present time is very small, and consumers are reported to hold stocks sufficient for several years. The price of tantalum minerals has varied, during the past few years, between £3. 10s. and £1. 10s. per unit of tantallic oxide (Ta<sub>2</sub>O<sub>5</sub>). Buyers often stipulate that ore shall contain over 65 per cent. of tantallic oxide, the niobic oxide must not exceed 3 per cent., and that chromium is to be absent.

**Manufacture of Metallic Tantalum.**—This may be roughly divided into two operations—(1) The separation of the tantalum from the other substances with which it is associated in the ore, and the preparation of a salt of the metal. (2) The electrolysis of a pure salt of tantalum under such conditions as will yield the metal in a fairly pure form.

Tantalum minerals are not readily attacked by the common acids, except perhaps strong hydrofluoric acid, and in order to decompose the mineral it is necessary to heat it for some considerable time with a suitable flux, such as caustic soda or potassium bisulphate. The usual process employed is to fuse the finely ground mineral in an iron crucible, with about three times its weight of potassium bisulphate, and after cooling, to treat the melt with water. By this means most of the oxides, other than those of tantalum, niobium, silicon, and tungsten, pass into solution. The insoluble matter, after being well washed, is digested with ammonium sulphide, so as to remove compounds of tin and tungsten, boiled with dilute hydrochloric acid to remove iron sulphide, and again well washed. The precipitate is next dissolved in hydrofluoric acid and boiled, so as to remove the silica as the volatile silicon tetrafluoride ( $\text{SiF}_4$ ). To the solution is next added an amount of potassium hydrogen fluoride ( $\text{KHF}$ ) slightly greater than is required to form the double salts, potassium fluotantalate ( $\text{K}_2\text{TaF}_7$ ) and potassium fluoxy-niobate ( $2\text{KF}, \text{NbOF}_3 + \text{H}_2\text{O}$ ). The solution is evaporated until, on cooling, it deposits the tantalum salt in the form of rhombic needles which are almost free from the more soluble niobium compound.

This separation, which was first introduced by C. Marignac (*Ann. Chim. Phys.*, 1866, 8, 5), is based upon the fact that, at ordinary temperatures, one part of potassium fluotantalate is soluble in about 150 parts of water, whilst the niobium salt, under similar conditions, is soluble in 12-13 parts of water. For a discussion of the properties of potassium fluotantalate, see R. D. Hall (*Journ. Amer. Chem. Soc.*, 1904, 26, 1235).

The method first used for the production of metallic tantalum is that ascribed to Berzelius and Rose. In this process, as described by W. von Bolton (*Zeits. Elektrochem.*, 1905, II, 45 and 722), potassium fluotantalate is put into a crucible interspersed with layers of metallic sodium, and the reaction started by the application of heat. As soon as the interaction is complete, the mass is cooled and washed first with water, and finally with nitric acid.

The process which has been used recently on a technical scale for obtaining metallic tantalum is that devised by W. von Bolton, and covered by German Patents, 152,848, 152,878, and 155,548, of 1903. The method consists in electrolyzing the potassium fluotantalate prepared as described above, and thus obtaining the tantalum in the form of a somewhat impure metallic powder, which is purified by being melted *in vacuo* between tantalum electrodes. By this means the impurities, which are more volatile than the metal, are volatilised.

A process introduced by the British Thomson-Houston Co., somewhat similar to the above, is described in English Patent, 24,234, of 1906. In this method the potassium fluotantalate is electrolysed in a refractory crucible made of magnesia or tantalic oxide, using a cathode of pure tantalum and an anode of impure tantalum.

Another process for purifying the metallic tantalum powder is to compress it into blocks and heat these in a crucible of magnesia or thoria which is lined with metallic tantalum. The heating is conducted *in vacuo* by means of an electric current, using a bar of tantalum as the cathode (English Patent, 21,766, of 1904).

The process devised by G. C. Bouhard (French Patent, 377,931, of 1907) consists in dissolving 100 g. of potassium tantalate in 3 litres of water, and adding sulphuric acid until no further precipitate forms. After being allowed to stand, the solution is filtered, and the precipitate washed and added to 1 litre of water heated from 70°-80° C. To this solution is added a 20 per cent. solution of oxalic acid in quantity sufficient to dissolve the precipitate, and after neutralising the solution thus obtained with ammonia, sulphuric acid is added in quantity sufficient to make 3 per cent. of the total volume of liquid. The acid solution is now electrolysed between electrodes of carbon or platinum, using a current of 2 volts and 0.1-0.3 ampere. When the deposited metal is 3-4 mm. thick it is removed from the bath and drawn into filaments.

Pure metallic tantalum cannot be prepared by reducing the oxide with excess of carbon, as, under these conditions, a mixture of carbide and oxide is obtained. A method employed at one

time by W. von Bolton was to mould tantalic oxide with paraffin wax into rods, which, after calcining, were heated *in vacuo* by means of an alternating electric current (*Zeits. angew. Chem.*, 1906, 36, 1537). The rods of brittle metal thus produced were purified by melting *in vacuo*.

In von Pirani's process the great affinity which metallic tantalum has for hydrogen is utilised as a means of purifying the crude metal. Tantalum will absorb about 740 times its own volume of hydrogen, with the production of a very brittle compound. After saturating the metal with hydrogen it is put into a vessel and made the positive pole of a circuit, whilst the negative pole consists of barytes. The metal is heated to redness, and then an electric current is passed which melts the metal and volatilises the occluded gases and impurities (see also French Patent, 367,293, 1906).

**Properties of Metallic Tantalum.**—In appearance the pure metal much resembles platinum, but its melting point is considerably higher, being, according to recent determinations, about 2,910° C. The specific gravity of the pure fused metal is about 16.6, whilst its specific heat is 0.0365. The specific resistance of a bar of the metal 1 m. long and 1 sq. mm. in cross section is 0.146 ohm at 20° C. Tantalum is characterised by its great ductility, combined with toughness, and it can be worked by the usual methods employed for other metals.

When first prepared in quantity, the metal was stated to possess unusual hardness (*Zeits. Elektrochem.*, 1905, 11, 503), but at a later date this was found to be incorrect, the hardness being due to the presence of small quantities of oxide. When this impurity is removed, the metal is found to be considerably softer and more ductile; the normal hardness of pure tantalum being about equal to that of medium hard steel. Towards chemical action the metal is particularly resistant, being unattacked by solutions of caustic alkali and mixtures of the common acids. It is attacked, however, by hydrofluoric acid, molten alkali nitrates, sulphur, and fused caustic alkali: the latter substance causing the metal to disintegrate into crystals. On heating in air, the surface of the metal turns blue at 400° C., greyish black at 600° C., and at higher temperatures it becomes coated with a layer of oxide and slowly burns. When heated in hydrogen it forms brittle compounds of metallic appearance, but when heated *in vacuo* to a white heat by a continuous electric current the metal is little affected.

### Uses of Metallic Tantalum

At the present time, tantalum is perhaps best known as a material used for making the filaments of certain incandescent electric lamps (see p. 356), but there are numerous other uses to which the metal may be put, and a few of these are here described.

**Tools.**—The use of the metal for surfaces and points which will be subject to mechanical wear is covered by French Patent, 351,351, of 1905. Various methods have been introduced for producing tantalum of the requisite hardness for the production of cutting tools, etc. Amongst these is the addition of oxide (English Patent, 6,050, of 1908), treatment with oxygen, hydrogen, silicon, boron, aluminium, titanium, or tin (French Patent, 357,714, of 1905). For the production of hardened tantalum, according to English Patent, 6,051, of 1908, the powdered metal is mixed with 1-10 per cent. of silicon, the mixture moulded under pressure, and melted *in vacuo* between tantalum electrodes. From 5-10 per cent. of silicon is recommended if the metal is to be used for tools, and 2-3 per cent. for wire.

**Dental and Surgical Instruments.**—For these purposes tantalum possesses many advantages, amongst which may be mentioned that it is non-rusting, can be sterilised in acids or in the flame at a moderate red heat, and the instruments can be repeatedly sharpened similarly to those made of steel. For dental purposes, tantalum tools are surface hardened by a secret process, and have a hardness about equal to that of agate (see also *Brit. Med. Journ.*, 1911, 32, 724, and *Dental Review*, 1911, 25, 1210).

**Chemical Apparatus.**—For many chemical operations, tantalum can be used in place of platinum, and has the advantage of costing considerably less, but it must also be remembered that when no longer fit for use platinum has a market value not far short of that charged for new vessels, whilst it would seem probable that disused tantalum vessels would be of comparatively little value. During 1913, tantalum vessels were sold at 2s. 6d. per gram. There is no evidence that the metal is finding a wide use in the chemical industry.

**Pens.**—The elasticity and hardness which tantalum possesses when rolled into a thin sheet renders it particularly suitable for the manufacture of pens, and it is stated that large quantities are now being made by a firm in Berlin. Pens made of tantalum have the advantage over those made of steel in that they do not rust, and are not corroded by ink. In order to reduce the wear on the point, it is specially hardened, and will then wear at about the same rate as a good quality steel pen.

**Electrodes.**—According to the investigations of O. Brunck (*Chem. Zeit.*, 1913, 36, 1233), tantalum is particularly suitable as an electrode material, as many metals such as silver, copper, zinc, nickel, platinum, and antimony can be deposited on a tantalum cathode, and can be dissolved off by acids or aqua-regia. As tantalum does not form an alloy with zinc at the surface of contact with the liquid, it does not require to be coated with silver or copper before use (see also G. Oesterheld, *Zeits. Elektrochem.*, 1913, 19, 585).

**Alloys.**—Tantalum forms alloys with many metals such as iron, molybdenum, and tungsten, but only the iron alloy is, at present, of any commercial importance. Small quantities of ferro-tantalum have been prepared for use in the steel industry by the reduction of a mixture of tantalite and iron in the electric furnace, but the alloy does not seem to be widely used (see L. Guillet, *Comptes rend.*, 1907, 145, 327).

During April 1914 ferro-tantalum sold in the United Kingdom for use in the steel industry at 7s. 6d. per lb. of tantalum contained. The alloy usually contains from 60-70 per cent. of tantalum.

A recent account of the uses of tantalum in science and technology is given by A. R. Meyer in *Dingler's Polytech. Journ.*, 1913, 328, 292.

## NIOBIUM

As mentioned on p. 337, this element, in the form of its oxide, is almost invariably associated with tantalum ores, but, at the present time, there appears to be no commercial use for the metal or its salts.

It can be obtained in a metallic state by several processes, amongst which may be mentioned—(1) Electrolysis of potassium fluoxy-niobate in a manner similar to that employed in the production of tantalum (see p. 339). (2) By passing a mixture of the vapour of the tetrachloride and hydrogen through a red-hot tube. (3) By the aluminothermic process, which yields a product containing about 3 per cent. of aluminium which can be removed by heating *in vacuo*. (4) By von Bolton's process of mixing niobium pentoxide with paraffin wax, squirting into fine threads, and heating these *in vacuo* to a temperature of 1,900° C. (see p. 340).

**Properties.**—Metallic niobium has a specific gravity of 12.7, and melts at 1,950° C. It is considerably less malleable and ductile than tantalum, and when in the form of powder it rapidly oxidises in air, but the massive metal is more resistant, probably owing to a protective coating of oxide being formed. It is insoluble in most acids, and is not attacked by solutions of the alkalis, but fused nitrates or alkalis readily attack the metal.

**Estimation of Tantalum and Niobium in Minerals.**—The complete analysis of a complex tantalum mineral is often a long, tedious, and complicated undertaking. It is impossible, in the space here available, to give full details of methods of analysis, but the following brief outline of a process for the separation and estimation of tantalum and niobium may be of service.

About 1 g. of the finely ground tantalite is fused for several hours with about five times its weight of potassium bisulphate, and after cooling, the melt is lixiviated with 5 per cent. sulphuric acid. The insoluble matter is separated by filtration and again fused. The sulphuric acid solutions thus obtained are diluted to 200 c.c., and, after nearly neutralising with ammonia, saturated with sulphur dioxide and well boiled for about one hour. This causes the precipitation of any traces of niobium and tantalum which may have passed into solution. The precipitate, together with the insoluble residue previously obtained, will now contain all the niobium, tantalum, silica, together with some of the tin, tungsten, and titanium. The moist precipitate is digested with ammonium sulphide in order to remove the tin and tungsten, and is then washed, transferred to a platinum basin, and dissolved in a few drops of hydrofluoric acid. After diluting the solution to about 20 c.c. it is boiled in order to expel silica. If the quantity of titanium present in the ore does not much exceed 5 per cent., then the niobium and tantalum in the hydrofluoric acid solution can be separated and estimated by the Marignac process, but if titanium is present in large quantity the separation is ineffective, and some other process must be adopted. The presence of titanium in tantalum ore also causes a large amount of the tantallic and niobic oxides to pass into solution after the fusion with potassium bisulphate, and special methods of analysis have to be adopted (see T. Crook and S. J. Johnstone, *Min. Mag.*, 1912, 16, 244). Assuming that only a small quantity of titanium is present, then the tantalum and niobium are separated as follows:—The solution in very dilute hydrofluoric acid is concentrated to about 20 c.c., heated to boiling, and to it is added a boiling solution containing about 0.7 g. of potassium fluoride. The solution is slowly evaporated to 10 c.c. and let cool slowly to about 15° C. When thoroughly cold, the clear solution, which contains all the niobium and a small part of the tantalum, is decanted through a small filter into a small platinum dish. The residual mass, consisting of crystals of potassium fluo-tantalate, is washed four times with a few c.c. of cold water, the washings being added to the main solution, which is evaporated to about 5 c.c. and let slowly cool. This solution is decanted and the crystals washed four times with a few c.c. of cold water, and then examined with a lens for flat plates of potassium fluoxy-niobate. If these are present they must be removed by further washing. Next evaporate the solution to dryness on the water bath, cool, add one drop of hydrofluoric acid and 0.1 g. of KF dissolved in 1 c.c. of water. Then run into the dish from 1.5 c.c. of water according to the proportion of niobium expected to be present, allowing 1 c.c. for each 7 per cent. of Nb<sub>2</sub>O<sub>5</sub>. Heat rapidly for a few seconds, note the total bulk of solution, and set aside to cool for one hour. Filter the solution into a small platinum dish and wash the residue three or four times with a few drops of water, making note of the approximate bulk of the washings. To the solution add 8 c.c. of strong sulphuric acid, evaporate to fuming, and maintain at this temperature for at least twenty minutes in order to remove the last traces of hydrofluoric acid.

After cooling, the solution is poured into 150 c.c. of cold water, and the whole boiled for about twenty minutes in order to completely precipitate the niobium. The solution is filtered and the precipitate well washed with boiling water, dried, ignited, and weighed. The whole of the niobium and a small proportion of the tantalum is contained in this precipitate; the tantalum being allowed for on the following basis—0.00365 g. Ta<sub>2</sub>O<sub>5</sub> for each c.c. of solution from which the final crystallisation took place, and 0.00091 g. Ta<sub>2</sub>O<sub>5</sub> for each c.c. of wash water in the final filtration. The remainder of the tantalum is recovered by dissolving the crystallised potassium fluo-tantalate in a few c.c. of water, adding about 10 c.c. of concentrated sulphuric acid, and evaporating to fuming. When cold, the acid solution is poured into about 200 c.c. of water, and the tantalum precipitated by the addition of ammonia. The precipitate is filtered, washed, ignited, and weighed as Ta<sub>2</sub>O<sub>5</sub>.

A convenient and rapid process for the volumetric estimation of niobium in a mixture of oxides of niobium and tantalum has been described by F. D. Metzger and C. E. Taylor (*Zeits. anorg. Chem.*, 1909, 62, 382). The method depends on the fact that if succinic acid be added to a bisulphate fusion of niobic and tantallic oxides, the solution can be diluted and heated without depositing insoluble compounds of the two elements. When this solution is treated with amalgamated zinc, the niobium is reduced and can be titrated with potassium permanganate. About 0.5 g. of the mixed oxides is fused with 5 g. of potassium bisulphate, 10 c.c. of concentrated sulphuric acid added, and the heating continued until a clear solution is obtained. The solution is poured into a beaker, the crucible rinsed out with 30 c.c. of sulphuric acid, and the whole allowed to cool. Two g. of succinic acid are stirred into the liquid, followed by 20 c.c. of a saturated aqueous solution of succinic acid, and lastly, 200 c.c. of water. The liquid is heated to 75° C., and sent through a Jones zinc reductor (previously warmed by running through it 200 c.c. of 5 per cent. sulphuric acid at 75° C.), filled with 20 per cent. sulphuric acid also heated at 75° C. The niobium solution is followed, first by 50 c.c. of 20 per cent. sulphuric acid, and then by 200 c.c. of 5 per cent. sulphuric acid (both at 75° C.). The brown reduced solution and washings are at once titrated with potassium permanganate in an atmosphere of carbon dioxide. Under these conditions, niobic oxide is reduced to an oxide approximating to the formula Nb<sub>2</sub>O<sub>3.107</sub>, whilst tantallic oxide is unaffected.

The degree of amalgamation of the zinc in the reductor is important. It is best prepared by shaking 600 g. of sieved zinc for several minutes with 250 c.c. of a solution containing 0.5 g. of mercury dissolved in 25 c.c. of concentrated nitric acid. The amalgamated zinc is washed first with water and then with dilute sulphuric acid, and is stored under water.

**Acknowledgments.**—Thanks are due to Messrs Siemens Brothers Dynamo Works for information on the recent utilisation of metallic tantalum, and to Messrs G. Blackwell & Sons, of Liverpool, for supplying quotations for tantalum ore and its ferro-alloy.

## SECTION LXXXI

# TUNGSTEN

BY SYDNEY J. JOHNSTONE, B.Sc. (Lond.)

### LITERATURE

- H. MENNICKE.—“Die Metallurgie des Wolframs.” Berlin, 1911.
- H. LEISER.—“Die Wolfram.” Halle a/S., 1910.
- C. G. FINK.—“Ductile Tungsten.” *Trans. Amer. Electro-Chem. Soc.*, 1910, 17, 229.
- “Applications of Ductile Tungsten.” *Journ. Indus. and Eng. Chem.*, 1913, 5, 8.
- O. RUFF.—“Über die Darstellung Streckbaren Wolframs.” *Zeits. angew. Chem.*, 1912, 25, 1889.
- W. D. COOLIDGE.—“Metallic Tungsten and some of its Applications.” *Proc. Amer. Inst. Elec. Eng.*, 1912, 31, 865.
- G. ERHARD.—“Über Darstellung von Wolframmetall.” *Metallurgie*, 1912, 9, 441.
- J. E. CARNE.—“The Tungsten Mining Industry in New South Wales.” *N.S.W. Department of Mines, Bull.* 15. Sydney, 1912.
- T. L. WALKER.—“Report on the Tungsten Ores of Canada.” *Canada, Dept. of Mines, Bull.* 25. Ottawa, 1909.
- “Occurrence and Utilisation of Tungsten Ores.” *Bull. Imp. Inst.*, 1909, 7, 170 and 285.
- R. A. HADFIELD.—“Alloys of Iron and Tungsten.” *Trans. Iron and Steel Inst.*, 1903, 64, 14.
- C. A. EDWARDS.—“Function of Chromium and Tungsten in High Speed Tool Steel.” *Trans. Iron and Steel Inst.*, 1908, 77, 104.
- C. BASKERVILLE.—“The Chemistry of Tungsten.” *Met. and Chem. Eng.*, 1913, 11, 319.
- G. T. HOLLOWAY.—“Tungsten.” *Thorp's Dict. of Applied Chemistry*, 1913, 5, 562.
- A. W. G. BLEEK.—“The Occurrence of Wolframite Lodes in the Tavoy District of Burma.” *Rec. Geol. Sur. India*, 1913, 43, 48.

TUNGSTEN, like several of the rarer elements, was little more than a scientific curiosity up to about fifteen years ago, but its employment first in the steel industry, and more recently in a ductile form for the manufacture of filaments for incandescent electric lamps, has led to the production of the metal in large quantities.

### Natural Occurrence

Tungsten ores are usually found in veins in the older plutonic rocks, or in the alluvium resulting from the denudation of these, being present in many tin deposits. The ores of commercial importance, at the present time, are **wolframite**, **hübnerite**, **scheelite**, and **ferberite**.

**Wolframite**, or wolfram, is a tungstate of iron and manganese, having a specific gravity of 7.2-7.5, and varying in colour from dark greyish to brownish black.

**Hübnerite** may be described as a variety of wolframite in which most of the iron has been replaced by manganese. It varies in colour from brownish to black, and usually occurs in bladed form.



**Scheelite**, a tungstate of calcium, is a white mineral having a specific gravity of 5.9-6.1, and when pure contains 80.6 per cent. of tungstic oxide ( $WO_3$ ).

**Ferberite** is a black opaque mineral having a specific gravity of about 6.8. It consists essentially of iron tungstate.

Other tungsten minerals of less importance are **cuprotungstite**, **stölzite** (lead tungstate), **tungstic ochre**, etc.

**Analyses** of some typical tungsten ore concentrates are given in the following table:—

TABLE XVI.

	Formula.	1. Wolframite, N. W. Spain.	2. Scheelite, Zinnwald.	3. Hübnerite, Colorado.	4. Ferberite, Nederland.
		Per Cent.	Per Cent.	Per Cent.	Per Cent.
Tungstic oxide - - -	$WO_3$	64.13	77.84	70.21	63.88
Stannic oxide - - -	$SnO_2$	0.68	...	...	...
Ferrous oxide - - -	$FeO$	10.88	...	2.03	20.44
Ferric oxide - - -	$Fe_2O_3$	...	...	...	0.35
Alumina - - -	$Al_2O_3$	5.32	...	0.56	2.19
Manganous oxide - - -	$MnO$	6.42	...	21.72	0.37
Lime - - -	$CaO$	1.21	19.48	0.37	0.35
Magnesia - - -	$MgO$	3.16	...	...	0.50
Molybdic oxide - - -	$MoO_3$	...	2.23	...	...
Silica - - -	$SiO_2$	7.71	...	4.91	6.45

1, 3, 4. O. J. Steinhart, *Min. Ind.*, 1908, 17, 830. 2. Traube, *Jb. Min.*, 1890, 7, 232.

### Geographical Distribution of Tungsten Ores

The increase in the demand for tungsten ore during recent years has led to the development of deposits in many countries, and it is impossible in the space available to give even a brief account of the more important of these. At the present time the most important producing countries are the **United States**, **India** (Burma and Shan States), **Queensland**, **New South Wales**, **Portugal**, **Argentina**, and the **United Kingdom**. An account of the occurrences in the United States will be found in the *Mineral Resources of the United States*, 1910, Part i., p. 744 (United States Geol. Sur., Washington, 1911). For a description of the other occurrences the literature quoted at the beginning of this article should be consulted.

**Concentration of Ore.**—Tungsten ore, which often occurs associated with numerous other minerals, is usually separated from these and concentrated by some process of wet dressing. This treatment results in the concentration of the tungsten ore, but the other heavy minerals present accumulate with it, and other means have to be adopted to separate these from the ore, in order to produce a marketable product. As wolfram ores are usually slightly magnetic, this removal can often be accomplished by means of an electro-magnetic separator (see Fig. 3, p. 296).

Owing to various causes, such as the excessive production of slimes, the losses in dressing tungsten ore are usually high.

### Production of Tungsten Ore

The following table shows the production, in short tons (2,000 lbs.), of tungsten ores during recent years. For purposes of comparison the outputs from the various countries have been reduced to a basis of ore containing 60 per cent. of tungstic oxide,  $WO_3$  (*Min. Res. United States*, 1912, Part i., p. 993).

TABLE XVII.

	1908.	1909.	1910.	1911.	1912.
<i>Asia—</i>					
India . . . . .	...	7	430	1,119	2,095
Federated Malay States . . . . .	83	99	105	205	275
Japan . . . . .	220	292	275	287	215
<i>Australasia—</i>					
New South Wales . . . . .	269	431	413	512	298
Northern Territory . . . . .	40	49	78	71	...
Queensland . . . . .	516	679	1,145	750	944
Victoria . . . . .	3	15	31	33	...
Tasmania . . . . .	5	20	75	86	87
New Zealand . . . . .	87	78	187	184	...
<i>East Indies</i> . . . . .	25	24	33	...	29
<i>Europe—</i>					
Austria . . . . .	44	43	54	50	...
United Kingdom . . . . .	261	421	307	298	216
France . . . . .	124	55	33	...	...
Germany . . . . .	46	106	105	89	...
Portugal . . . . .	684	609	1,132	1,078	1,466
Spain . . . . .	249	142	169	106	...
<i>America—</i>					
United States . . . . .	671	1,619	1,821	1,139	1,330
Argentina . . . . .	548	900	826	683	702
Bolivia . . . . .	187	168	232	370	547
<i>South Africa</i> . . . . .	40	16	...	...	...

### Commercial Value of Tungsten Minerals

The price obtainable per lb. of tungstic oxide in the ore varies largely with the percentage of tungsten present. Thus, in the United States, in 1912, the ores were sold on the following scale (only a few of the prices are quoted):—

Tungstic Oxide in the Ore.	Price per Lb. of WO <sub>3</sub> .
Per Cent.	<i>d.</i>
10-14	10
35-39	14
50-54	16
60	19

### Manufacture of Metallic Tungsten and its Salts

Although the processes employed for the production of metallic tungsten from the concentrated ore do not appear to be very complicated, great care is necessary, at every stage, in order to avoid heavy losses of valuable material.

The present-day method usually employed for the production of sodium tungstate from the ore is practically identical with the "Oxland" process which was patented in 1847. If bismuth is present, the ore is first roasted and then leached with hydrochloric acid. The dry finely powdered ore is heated in a reverberatory furnace with a quantity of sodium carbonate, equivalent to an excess of about 10 per cent. over the amount required to combine with the tungstic oxide in the ore to form sodium tungstate in accordance with the following equation—

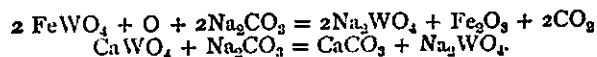

About 10 per cent. of sodium nitrate is sometimes also added to the mixture. Whilst in the furnace, the mass is maintained at a red heat for about four hours, care being taken that it does not fuse, and only reaches a pasty condition. According to G. Erhard (*Die Metallurgie*, 1912, 9, 441), who gives a good review of the processes available for smelting tungsten ore, it is advisable to let the pasty mass cool after this first heating, crush in a ball mill, and again sinter. The first heating converts about 70 per cent. of the tungsten into sodium tungstate, whilst the second sintering increases this amount to about 90 per cent. After the second heating, the pasty mass is removed from the furnace and leached with water in superimposed vats, so that the weak liquor from the final washing of one batch is used for the first leaching of the next. The solid residue from this treatment often contains cassiterite (tinstone), which, being of considerable value, is recovered by treating the material on shaking tables of the Wilfley type (see Fig. 1, p. 295), or by other suitable means.

The solution obtained as above can be (1) evaporated to dryness to give crude sodium tungstate, or (2) evaporated to crystallisation for the production of the **pure salt**. The chief impurities present in the crude sodium tungstate produced by evaporation to dryness are:—Sodium sulphate, sodium silicate and arsenate, whilst iron and manganese occur in smaller amounts. When the pure salt is required, these impurities are removed by the following series of operations. Iron, manganese, and arsenic are precipitated by the addition of a small quantity of caustic soda, and the greater proportion of the sodium sulphate will crystallise out before the sodium tungstate. The silica passes to the mother liquor which remains after the crystallisation of the sodium tungstate, and may cause a considerable loss of tungsten, as it leads to the formation of soluble silico-tungstates. This loss is mitigated, to some extent, by the fact that this silico-tungstate can be obtained by further evaporation, and sold for fire-proofing purposes. It is also possible to recover the tungsten, thus retained by the silica, by adding a calcium salt to the solution, and thus precipitating calcium tungstate. After recrystallising the sodium tungstate and thus obtaining a fairly pure product, it is dissolved in boiling water, and added to a boiling solution of hydrochloric acid, which has been previously diluted with its own volume of water. This latter solution sometimes contains, in addition, about 6 per cent. of nitric acid. This treatment causes the tungsten to be precipitated in a granular form as hydrated tungstic oxide ("tungstic acid") which is filtered off and well washed in filter presses. In the precipitation and washing considerable losses may occur owing to the formation of a soluble acid tungstate, and also of colloidal tungstic acid, which pass away in the wash waters. The extent of these losses is influenced by (1) the strength of the solutions of sodium tungstate and hydrochloric acid before mixing; (2) the method of mixing, filtering, and washing. It is best to mix the solutions slowly, with constant agitation, at as high a temperature as possible, and to wash rapidly with dilute acid.

It is very essential that the tungstic acid should be washed free from sodium salts, for if this is not done the product, when dry, has a greenish tinge, and is supposed to be less suitable for the production of tungsten powder. Various other processes have been suggested for the production of sodium tungstate, amongst which may be mentioned that of Jean, which consists in heating the ore with calcium carbonate and sodium chloride, a process which is only applicable to pure wolframite. The Kempen Electro-Chemical Company heats sodium bisulphate to fusion with mono-hydrated sulphuric acid, and then introduces the powdered mineral (German Patent, 149,556, of 1902).

**Preparation of Metallic Tungsten.**—Metallic tungsten can be obtained from tungstic oxide by several processes, such as—(1) Reduction by means of hydrogen. (2) Heating with carbon in an electric furnace. (3) Heating with metallic zinc. (4) Conversion to the hexa-chloride and reduction in hydrogen. (5) Conversion to the nitride and heating. (6) Heating to redness a mixture of ammonium tungstate and metallic zinc. (7) Reduction with aluminium or magnesium. (8) Electrolysis of the double chloride of sodium and tungsten.

Few of these processes are of commercial importance, except (1) and (2), although certain of the others may be in use on a small scale.

Reduction in a current of hydrogen gives a purer product than that obtained when carbon is the reducing agent, but it is somewhat difficult to control the operation and to make the reaction go to completion. The reduction with carbon is, therefore, the process more usually employed. In practice, the dried tungstic oxide is mixed with slightly less than the full quantity of carbon required for its reduction by means of carbon monoxide, and the mixture heated in crucibles. The process, as described by G. Erhard, consists in mixing 100 kilos of dried tungstic oxide with 14 kilos of pure charcoal (petroleum coke) and 2 kilos of rosin. This mixture is placed in a crucible, the lid firmly luted on, and the whole maintained at a temperature of 1,400° C. for some time.

The metallic powder produced, which is mixed with unburnt carbon and unreduced tungstic oxide, is elutriated so as to remove these, together with the very finest particles of metal. The material so removed is mixed with the next charge to be reduced.

**Cost of Production.**—The manufacturing costs in the production of metallic tungsten are somewhat high, owing to the number of operations, each of which entails some loss of material. For example, it is found that although from theoretical considerations 127 parts of the oxide should yield 100 parts of the metal, in practice at least 140 parts are required. The costs of production ("returning charge") per ton of metal amounts to about £80, so that if ore containing 60 per cent. of tungstic oxide costs £100 a ton, the metal will cost about £310 a ton.

**Ferro-Tungsten.**—This alloy, which finds a wide use in the steel industry, can be prepared by several methods, such as—(1) The direct reduction of the ore by means of carbon in a crucible. (2) By reducing in the electric furnace by means of some substance other than carbon. (3) By direct reduction in the electric furnace by means of carbon.

In the first process the concentrated ore is placed in a clay-lined crucible, together with a suitable flux and the reducing agent, and the whole is heated in a gas-fired furnace, together with the correct proportion of iron or steel scrap.

When direct reduction by means of carbon in the electric furnace is employed, wolframite, small hübnerite, and ferberite are easily reduced, but scheelite is more difficult to treat, and gives thick pasty slags. The alloys produced by either of the above processes are decarburised by means of refining slags.

The composition of tungsten powder and ferro-tungsten is shown in the following table, the powder being produced by the reduction of tungstic oxide by means of carbon, whilst the ferro-tungsten was obtained by reduction in the electric furnace (analyses quoted by O. J. Steinhart, *Min. Ind.*, 1908, 17, 833).

TABLE XVIII.

	Formula.	Tungsten Powder.		Ferro-Tungsten.		
		Per Cent.	Per Cent.	Per Cent.	Per Cent.	Per Cent.
Tungsten	W	97.02	98.63	85.15	79.48	71.80
Iron	Fe	0.61	0.59	14.12	18.60	24.35
Carbon	C	0.32	0.12	0.45	1.49	2.58
Silicon	Si	0.72	0.32	0.13	0.16	0.36
Manganese	Mn	0.16	...	0.085	0.21	0.078
Phosphorus	P	<i>Nil</i>	...	0.018	0.017	0.008
Sulphur	S	<i>Nil</i>	...	0.021	0.016	0.02
Aluminium	Al	0.47	0.21	...	0.001	0.07
Copper	Cu	...	...	...	...	0.008
Magnesium	Mg	0.32	...	...	...	...

At the present time (April 1914) ferro-tungsten containing about 80 per cent. of tungsten and a maximum carbon content of one per cent., is sold, in the United Kingdom, at 2s. 9d. per lb. of tungsten contained.

**Ductile Tungsten.**—The advent of the tungsten metal filament lamp (see p. 357) led to a search for methods of producing the metal in a more ductile form than it had previously been obtained, and it was found that the pure metal, when submitted to repeated swaging and heating, loses its crystalline character and becomes ductile and fibrous.

The master patent in this connection appears to be English Patent 23,499, of 1909, granted to the British Thomson-Houston Co., which is briefly as follows. By repeatedly working a heated body of coherent tungsten, the metal may be obtained in a form which is ductile both when hot and at ordinary temperatures; the consolidated rod being transformed by repeated rolling, hammering, swaging, or drawing, into a form which shows a conchoidal fracture and ultimately becomes very fibrous. This process is described in full on p. 359.

For the production of ductile tungsten by the above method, it is necessary that metal of great purity should be employed. According to O. Ruff (*Zeits. angew. Chem.*, 1912, 25, 1889), the metal must be entirely free from oxide; iron and nickel and non-metallic impurities, such as sulphur, phosphorus, etc., must be entirely absent. It should not contain more than about 0.1 per cent. of carbon. Before working, the metal should be sintered almost to the melting point in order to obtain it in as dense a condition as possible. In order to get a pure metal, it is desirable to purify the trioxide by reducing it to the dioxide, volatilising the latter as oxychloride, and treating this with hydrochloric acid. Tungsten dioxide ( $WO_2$ ) can be prepared by heating the trioxide to bright redness with one-fifth of its weight of glycerol or similar hydroxy compound (English Patent, 18,922, 1907). By this means silica and phosphoric acid are left behind in the non-volatile residue, whilst arsenic and antimony pass into solution in the hydrochloric acid. The pure trioxide is reduced in a rapid current of hydrogen at a temperature of  $1,250^\circ C.$ , and is pressed into rods which are hardened by heating in hydrogen to a temperature of about  $1,300^\circ C.$ , and then sintering in a special furnace at about  $2,650^\circ C.$

It is sometimes necessary, in the case of very pure tungsten, to add about 0.05 per cent. of carbon in order to lower the melting point. Other methods for producing ductile tungsten are described in Section LXXXII., p. 359.

**Properties of Metallic Tungsten.**—Cast tungsten, or that in the form of powder, has properties differing widely from those of the pure wrought metal, such as is used in the manufacture of incandescent electric lamp filaments (see p. 357). The powder is a hard, brittle, crystalline substance having a specific gravity of 16.17. The pure metal is a much softer and tougher material which may be rolled into thin sheets, welded at a yellow heat, and drawn into exceedingly fine wire. It has a melting point of about  $3,080^\circ C.$ , and a specific gravity of 18.8. In common with most metals, its tensile strength increases with the thinness of the wire tested. Thus, a wire 5 mm. in diameter has a tensile strength of 460,000 lbs. to the square inch, whilst that of wire of 1.2 mm. in diameter is 580,000 lbs. per square inch. Air and water, at ordinary temperatures, are without effect on metallic tungsten, but at a red heat the metal is oxidised. Molten sulphur and phosphorus attack it slowly, but it is rapidly converted to sulphide or phosphide by their vapour. Fused nitrates, peroxides, potassium bisulphate, alkali carbonates, and caustic alkalis readily attack the metal, but solutions of these are without action. The metal is unattacked by boiling dilute sulphuric acid, but the concentrated acid attacks it slowly. Strong or weak hydrochloric acid has no action at ordinary temperatures, but the strong acid, at the boiling point, slowly attacks the metal, producing a black coat of oxide. Concentrated nitric acid or hydrofluoric acid have little action separately, but the metal is rapidly attacked by a mixture of these two acids.

#### Utilisation of Metallic Tungsten and its Salts

**Tungsten Steel.**—About 90 per cent. of the tungsten produced is used in the manufacture of tungsten steel. One of the most important properties of tungsten is the additional hardness and toughness which a small quantity of it is

capable of imparting to steel, and for this reason tungsten steel is of especial value for the construction of **armour plate, projectiles, and firearms**. Tungsten steel is also especially suitable for the manufacture of high-speed tools, which are required to retain their temper when run hot. A steel suitable for such use may contain tungsten, 8.5 per cent.; chromium, 4.0 per cent.; carbon, 1.25 per cent.

**Self-hardening steels**, *i.e.*, those requiring no tempering after forging, may have a composition between the following limits—Tungsten, 2.4-3.4 per cent.; chromium up to 6 per cent.; carbon, 0.4-2.2 per cent.; silicon, 0.2-3.0 per cent.

The chief characteristics of tungsten steels are that they possess a tensile strength and elastic limit which, within certain limits, become higher in proportion as the percentage of tungsten increases. Their elongation, reduction of area, and resistance to shock diminish proportionately whilst the hardness increases somewhat rapidly with the percentage of tungsten.

For use in the steel industry, tungsten is usually employed in this country in the form of its ferro-alloy, but the powdered metal is often employed abroad.

Tungsten is a constituent, to the extent of about 5 per cent., of an interesting alloy known as "Stellite," which contains, in addition, 75 per cent. of cobalt and 20 per cent. of copper. This alloy can be utilised for cutting tools, being very hard and non-rusting (see E. Haynes, *Bull. Amer. Inst. Min. Eng.*, 1913, 249, and United States Patents, 1,057,423 and 1,057,828, 1913). It also enters into the composition of the alloys "Minargent," "Platinoid," "Partinium," and "Sideraphit."

Numerous uses have been suggested for wrought and ductile tungsten. Its applications in the chemical industry are fairly obvious from a consideration of the properties quoted on p. 348.

It may also find numerous applications in electro-technology. Thus it is stated to be particularly suitable for *contacts*, such as those of magneto spark coils, signal relays, sending keys, etc., being much superior to platinum, or platinum-iridium, for these purposes. As the heat conductivity of tungsten is twice that of platinum, contacts made of the first-mentioned metal remain much cooler whilst in use than do those made of platinum. Owing to its higher melting point, tungsten is stated to be better than platinum as a target material for Röntgen ray tubes. For the numerous other uses which have been suggested for tungsten, the article by C. G. Fink should be consulted.

**Bronze Powders**.—When potassium tungstate is fused with pure tin, coloured compounds are produced, known as tungsten bronzes, which are largely employed for decorative purposes.

**Magenta Bronze** is produced by adding tungstic oxide to fused potassium carbonate until the solution is saturated. The product thus obtained is gently heated in hydrogen and then successively treated with water, hydrochloric acid, and potassium hydroxide solution. These operations yield a product in the form of small violet crystals, which have the composition  $K_2W_4O_{12}$ . Other alkali-tungstate bronzes are also employed for decorative purposes, owing to their colour and insolubility in acids. They can be prepared electrolytically by fusing together the calculated quantities of tungstic acid and metallic carbonate and then electrolyzing the mass. According to Philipps (*Ber.*, 1882, 15, 499), the following tungsten-sodium bronzes are known— $Na_5W_6O_{18}$  (golden yellow);  $Na_2W_6O_{15}$  (blue);  $Na_2W_3O_9$  (red);  $Na_4W_5O_{15}$  (reddish yellow). Blue tungsten-lithium bronzes have been described by Hallopeau (*Comptes. rend.*, 1898, 127, 512); also by G. von Knorre and E. Schäfer (*Ber.*, 1902, 35, 3407). Other tungsten bronzes have been described; for accounts of these see E. Engels, *Zeits. anorg. Chem.*, 1903, 37, 125, and Schäfer, *Zeits. anorg. Chem.*, 1904, 38, 148.

In the **textile industry**, sodium para-tungstate is used to a small extent for the fireproofing of cloth and other fabrics, and as a mordant for calico printing. Tungsten salts are also used as mordants for silk, and have the additional advantage that they also serve as weighting materials.

Tungstic oxide is used in glass and porcelain manufacture for the production of yellow colours. Formerly, difficulties arose from the formation of an opalescence in the glaze, but a method has been described by which this may be avoided (see A. Granger, *Comptes rend.*, 1905, 140, 935).

Sodium tungstate is sometimes used for decolorising acetic acid.

### Estimation of Tungsten in Minerals and Salts

A process for the determination of tungsten in wolframite will serve to illustrate the methods employed (Treadwell and Hall, "Analytical Chemistry," Vol. II., p. 259). About 1 g. of the extremely finely powdered mineral is fused with 4 g. sodium carbonate in a platinum crucible for from one-half to three-quarters of an hour. After cooling, the melt is boiled with water and filtered. The residue contains iron, manganese, calcium, and magnesium, and sometimes small amounts of niobic and tantallic acids. The solution contains all the tungstic acid and silica. The aqueous solution of the alkali tungstate is treated with an equal volume of nitric acid and boiled until the precipitate becomes a pure yellow. After the precipitate has settled, the supernatant liquid is decanted through a filter and the precipitate washed three times, by decantation, with a mixture of equal parts of nitric acid (sp. gr. 1.2) and water, and finally upon the filter until the washings leave no residue when evaporated to dryness on platinum foil. Then, in order to remove nitric acid, the precipitate is washed twice with a neutral 5 per cent. solution of ammonium nitrate. By this means the greater proportion of the tungstic acid will be in the precipitate, but a small quantity will be in the filtrate, which is then evaporated to dryness, the residue moistened with ammonia, again evaporated to dryness, dissolved in as little water as possible, and treated with an equal volume of concentrated nitric acid. After boiling and filtering, the precipitate is washed as before. The two precipitates of tungstic acid are dried, ignited, and weighed as impure tungstic oxide ( $WO_3$ ); the impurities present being usually silica and stannic oxide. To remove silica, the oxide is treated with hydrofluoric and sulphuric acids, ignited, and again weighed. The stannic oxide may be removed by Rammelsberg's method of igniting the residue with pure dry ammonium chloride. For a full account of the numerous methods of separating tungsten from other metals see "Treatise on Quantitative Analysis," by J. W. Mellor (London, 1913), pp. 405-411.

**Tungsten Bronzes.**—These salts are not readily decomposed by acids, but can be easily attacked by the method of Brunner (*Inaug. Diss.*, Zurich, 1903). About 0.5 g. of the finely powdered bronze is treated in a porcelain crucible with 2 g. of alkali-free ammonium sulphate and 2 g. of concentrated sulphuric acid, and carefully heated over a very small flame until vapours of sulphuric acid begin to escape. After a part of the ammonium sulphate has been volatilised, the mass is allowed to cool and further quantities of ammonium sulphate and sulphuric acid added. After further heating, the mass is allowed to cool, treated with water, and transferred to a porcelain dish. About 50 c.c. of concentrated nitric acid is next added and the contents of the dish digested on the water bath for three or four hours, after which it is diluted with water and the tungstic acid filtered off. The remaining treatment is similar to that already described above.

## SECTION LXXXII

# THE INCANDESCENT ELECTRIC GLOW LAMP INDUSTRY

BY SYDNEY J. JOHNSTONE, B.Sc. (Lond.)

### LITERATURE

- G. S. RAM.—“The Incandescent Lamp and its Manufacture.” London, 1893.  
 J. A. FLEMING.—“Electric Lamps and Electric Lighting.” 2nd edition. London, 1899.  
 C. H. WEBER.—“Die Kohleleuchtstoff für elektrische Glühlampen, Ihre Herstellung, Prüfung und Berechnung.” Leipzig, 1909.  
 —“Metalfädenglühlampen.” Leipzig, 1914.  
 G. B. BARHAM.—“The Development of the Incandescent Lamp.” London, 1912.  
 A. SIEMENS.—“Metal Filament Lamps.” *Trans. Inst. Metals*, 1913, 9, 42.  
 A. LEDERER.—“The Tungsten Lamp and its Development.” *Electric Journ.*, 1913, 10, 1166.  
 M. VON PIRANI.—“Die Entwicklung der modernen Glühlampe.” *Helios*, 1912, No. 46.  
 R. W. HUTCHINSON.—“High Efficiency Electrical Illuminants.” New York, 1911.  
 A. R. MEYER.—“The Modern Filament Lamp and its Development.” *Dingler's Polytech. Journ.*, 1913, 328, 305.  
 L. F. GROTHUSS CALL.—“Wolfram-Thorium, eine duktile Legierung.” *Metal und Erz*, 1913, 26, 844.  
 R. E. MYERS.—“Commercial Manipulation of Refractory Elements for Incandescent Lamp Purposes.” *Trans. Amer. Inst. Chem. Eng.*, 1910, 3, 172.  
 C. BASKERVILLE.—“Chemistry of Tungsten, and the Evolution of the Tungsten Lamp.” *Trans. New York Elec. Soc.*, 1912, No. 1.  
 A. MÜLLER.—“Neuere Erfahrungen über duktile Wolframglühkörper.” *Helios*, 1913, 19, 504.

### Incandescent Electric Glow Lamps

THE modern electric glow lamp may be briefly described as consisting of a glass bulb, enclosing a fine thread of some refractory substance, known as the filament, which, when heated by the passage of an electric current, will radiate light. The atmosphere in the bulb is usually reduced nearly to a vacuum, but occasionally a gas in a partially rarified condition is used.

The numerous problems involved in the manufacture of the various types of electric glow lamps are mostly of an electrical, rather than a chemical nature, and, therefore, cannot be fully discussed in this volume. Although great developments have taken place in the method of manufacture of the metal filament lamp (see p. 355), these lamps have by no means entirely displaced the carbon filament variety. As certain of the processes employed are very similar, both for the metal and carbon filament lamp, a very brief outline of the general method of manufacture of the latter is here given.

### Carbon Filament Lamps

The following description, which is an account of the process as employed at the works of the Edison & Swan United Electric Light Co., Ponders End, may be taken as being typical of the methods generally in use in this branch of industry.



The first operation is the production of the glass bulb which is to enclose the filament. This is made by first blowing an elongated bulb, which is given the finished shape by completing the blowing in a metal mould. For this purpose

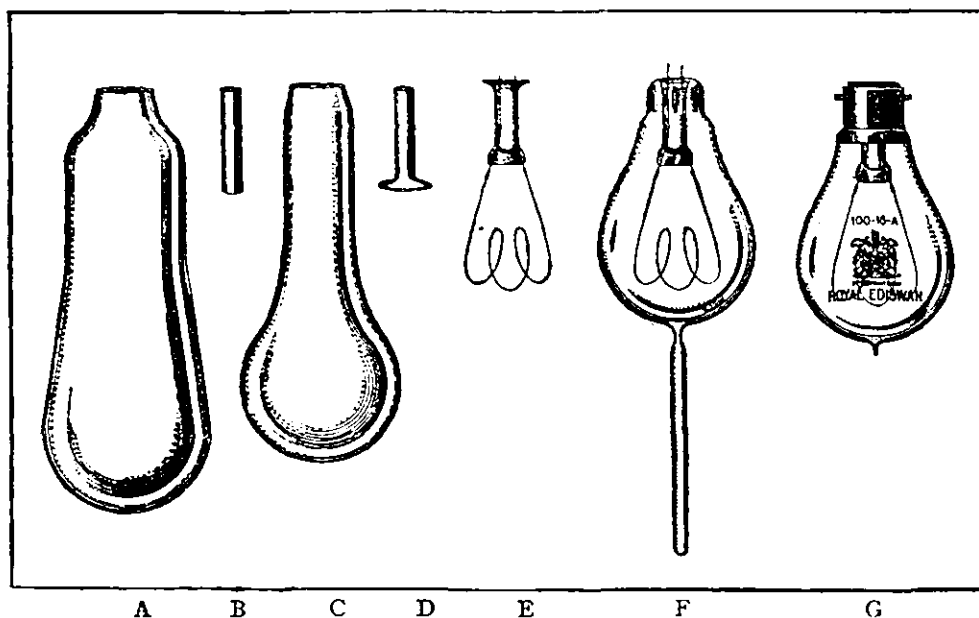

FIG. 1.—Stages in the Manufacture of a Carbon Lamp.

A and C show the bulb before and after it has been blown in the mould. B and D represent the tube for the leading-in wires before and after flanging. The filament attached to the leading-in tube and ready for sealing into the bulb is shown in E. The lamp ready for pumping is shown in F, whilst G represents the finished lamp.

the best flint glass containing a large percentage of lead is usually employed. The shapes thus produced are shown in A and C of Fig. 1. A small hole is next blown in the bottom of the bulb, and into it is sealed the piece of glass tubing which is required for use in the final operations of evacuating and sealing off the finished lamp. The two wires which in the finished lamp will convey the current from the mains to the filament are usually made in three sections (see Fig. 2). The first section, AB, is made of copper wire, whilst the second portion, BC, is composed of platinum or some alloy which has the same coefficient of expansion as the glass, in order that the joint between glass and metal may be perfectly gas-tight. Alloys used for this purpose include ferro-nickel and "platinoid" (an alloy of copper, zinc, tungsten, and nickel). "Partinium" is also used, and consists of an alloy of tungsten, aluminium, tin, copper, and magnesium (English Patent, 21,573, 1895). The lower section, CD, which is joined to the filament, is often composed of nickel.

These wires are next sealed into the small glass tube D (Fig. 1), and are then ready to be attached to the filament, the method of making which will be described later. Several processes are in use for attaching the finished carbon filaments to the leading-in wires, the method selected being largely dependent upon the amount of shock which the lamp will have to withstand in use, and upon the strength of the current to be used in the lamp. For low amperage lamps, the joint between the filament and wires is effected by covering the junction with a special paste, the essential constituents of which are graphite and sugar. When an extra strong joint is required, the filament and

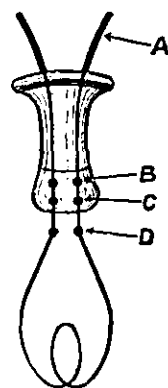

FIG. 2.  
Connections between Filament and Leading-in Wires.

leading-in wires are brought into close contact, immersed in a liquid hydrocarbon, usually ligroin or benzene, and a current passed. This causes a small arc to play across the gap between the leading-in wires and filament, which decomposes the hydrocarbon and forms a compact deposit of carbon around the joint. The filament and its holder is now ready for sealing into its bulb, this operation being now usually done by machinery in most modern works. The lamp is now ready for exhausting, or "pumping," as it is called in the works. This operation is sometimes carried out in two stages, the bulk of the air being removed by means of a pump, and the evacuation completed by means of a Sprengel or similar type of pump.

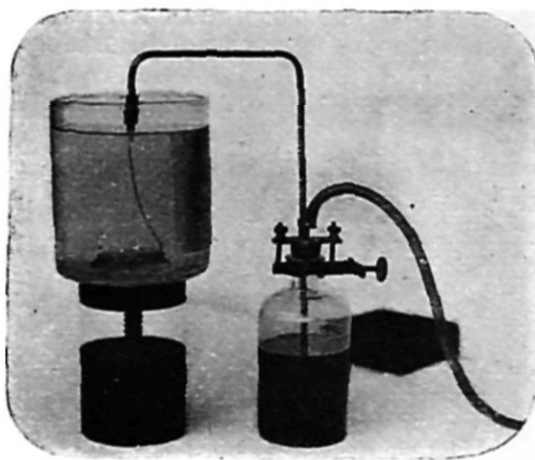

FIG. 3.—Squirting Carbon Filaments.

The degree of evacuation which is claimed for several modern types of pump is shown in the following table:—

TABLE XIX.

Pump.	Pressure left in Bulb.
	Mm.
Geisler - - - - -	0.0085
Sprengel (five tubes) - - - - -	0.000006
Geryk (oil pump) - - - - -	0.0002
Töpler (new type) - - - - -	0.00009

Carbon filament lamps are usually evacuated so as to leave a pressure of about 0.005 mm. in the bulb, and when the process is finished, the glass stem is melted and the tube sealed off close to the bulb. It next has its candle power tested photometrically, using electric lamp standards with the Lummer-Brodhun disc, and is then ready for fixing into its metal socket, which is done by means of a special paste composition consisting largely of plaster of Paris, together with a small quantity of gum. A small spot of solder on each of the terminals completes the lamp. The above is a very brief outline of the general method of manufacture employed; for full details the literature mentioned above should be consulted.

In most modern works, the whole of the above series of operations, with one or two exceptions, is carried out by machinery.

**Carbon Filaments.**—In the earlier types of lamp these were made of carbonised bamboo or cotton fibre, but at the present day they are made almost entirely from cotton wool, which is dissolved in a strong solution of zinc chloride to give a thick syrupy liquid. This dark greenish solution is squirted, by pressure, through various-sized nozzles which are immersed in jars of methylated spirit. As

the solution is forced from the jet, the cellulose is precipitated by the methylated spirit, and so forms a continuous filament. This operation is shown in Fig. 3.

The gelatinous filaments, thus produced, are removed from the solution and air-dried on frames. When dry, the filaments, which now resemble cat-gut, after being examined for defects, are passed repeatedly through drawplates until they are reduced to the requisite standard diameter. The filaments are next wound on porcelain or metal frames, which have the same shape as it is desired to give to the finished filament, immersed in graphite contained in crucibles, and raised to about  $2,000^{\circ}$  C. This latter process, which is known as "**metallising**," is sometimes repeated after the filament has been "**flashed**." By this means a filament of pure carbon of the desired shape is obtained, and after being carefully sorted, the selected filaments are submitted to the process of "**flashing**." This consists in



FIG. 4.—"Flashing" Room at Messrs Edison & Swan's Works.

electrically heating the filament to bright redness in a glass jar, having in it an atmosphere of a volatile hydrocarbon, such as ligroin or benzene, until it has attained a certain resistance, when the heating current is automatically cut off. The operation is usually conducted by considerably reducing the pressure of air within the jar and then admitting a definite volume of the hydrocarbon vapour. If the latter were used at atmospheric pressure, the deposition of carbon would be rapid, and an insufficiently dense layer would result. It is usual to employ a current about twice as great as that which will be used in the finished lamp. This process effects several improvements in the filaments, amongst which may be mentioned—(1) Carbon is deposited on the filament in a hard, lustrous condition, and in this form has a high light emissive power. (2) Any small inequalities in the thickness of the filament are levelled up, because the carbon is deposited least on those parts of the filament which have the least resistance, *i.e.*, those which are thickest. The flashing room at Messrs Edison & Swan's works is shown in Fig. 4.

The filaments are next graded according to their diameter and resistance, and are then ready for attaching to the leading-in wires by one of the processes which have been already described (p. 352).

### Metallic Filament Lamps

There are probably few articles in commerce whose introduction created such widespread interest and demand as the metal filament electric glow lamp.

Briefly summarised, the transition from the carbon filament to the present-day metal filament lamp was as follows:—The carbon filament lamp with an efficiency of 3 watts per candle power was succeeded in turn by the “metallised” carbon filament having an efficiency of 2.5 watts, the tantalum with 1.7 watts, squirted tungsten requiring 1.25 watts, and the ductile or drawn tungsten lamp consuming 1 watt per candle power. More recently, however, the nitrogen-filled drawn tungsten lamp has been introduced, and has an efficiency of 0.5 watt per candle power (see p. 364).

The carbon filament lamp, in its many forms, had reigned unchallenged for many years when the first metallic filament lamp was made by Welsbach in 1898, as the outcome of his investigations on the use of metals having a high melting point as incandescent electric illuminants. It is rather interesting to note that the man who, by his invention of the incandescent mantle, put coal-gas lighting on a competitive basis with electricity, should indicate the lines of development for the electric glow lamp, so that it might equal incandescent gas lighting in efficiency. The changes during the past ten years in the method of manufacture of metal filament electric lamps have been many and varied, and it is not possible to give here a full account of these. The following summary is, therefore, only intended to indicate briefly the more important stages through which the metal filament has passed in order to attain its present degree of efficiency.

In order that a metal may be suitable for use as a filament for incandescent electric lamps, it is essential that it should have a high melting point, be fairly ductile, and possess a low vapour tension under working conditions, whilst its radiation must be highly selective. It has been shown by C. W. Waidner and G. K. Burgess (*U.S. Bureau Standards*, 1907, 2, 319) that the light emitted by an incandescent metal varies as the twelfth power of the temperature, whilst the energy required varies as the fifth power of the temperature. It is seen, therefore, that a small increase in the working temperature of the filament is of considerable advantage.

The melting points of some of the metals which have been suggested or used as filaments are shown in the following table:—

Tantalum - - -	2,910° C.	Molybdenum - - -	2,450° C.
Thorium - - -	over 1,700° C.	Zirconium - - -	about 1,300° C.
Tungsten - - -	3,080° C.	Titanium - - -	1,795° C.

Amongst the advantages possessed by metal filaments over those of carbon is that, being good conductors of electricity, their resistance increases with temperature, whereas with carbon filaments increase of temperature causes a decrease of resistance, as the substance is a poor conductor of electricity. For this reason, fluctuations in voltage cause smaller alterations in the intensity of the light given by a metal filament than would be the case if a carbon filament were employed.

The first metal filament lamp constructed on modern lines was one introduced by Welsbach in 1898, the filament of which was composed of metallic osmium, one of the platinum group of metals (English Patent, 7,210, 1900).

This lamp had many disadvantages besides the high price of the metal, which was at that time about £100 per lb. The lamps had to be burned in a vertical position, otherwise the filaments sagged and broke, and they could not withstand shock. Low voltage lamps only could be produced, and therefore on the ordinary circuit several lamps had to be run in series. The filaments were first made by heating a platinum wire in an atmosphere containing a volatile osmium compound. This caused the deposition of metallic osmium on the wire from which the platinum was subsequently volatilised by increasing the temperature. At a later date, filaments were also made by the “squirting” process, and a lamp having a filament of metallic osmium was on the market, for a short time, under the name of the “Osmi” lamp. The physical properties of the earlier types of osmium filament lamps have been described by F. G. Bailey (*Electrician*, 1904, 52, 646). The patent literature indicates that the idea of using osmium as a filament has not been entirely abandoned (see United States Patents, 1,090,111, 1,109,886, of 1914).

After Welsbach had thus indicated the direction in which improved efficiency of the incandescent electric lamp was to be sought, there were numerous attempts

to utilise, as filaments, other metals of the platinum group, either alone or alloyed with base metals in order to reduce the tendency towards volatilisation. After numerous trials, however, the metals found to be most suitable were tantalum and tungsten, neither of which is a member of the platinum group. At the outset, considerable difficulty was experienced in producing filaments of sufficient strength and thinness, and it was soon realised that the filament drawn from a rod of ductile metal had many advantages over one made by the squirting process, as then used (see pp. 353 and 358).

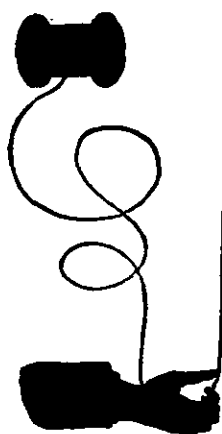

FIG. 5.  
"Spider."



FIG. 6.—Method of Arranging  
Continuous Filament on "Spider."



**The Tantalum Lamp.**—The first lamp placed on the market having a filament of drawn wire was the tantalum lamp, which was introduced in 1903 by the Siemens & Halske A.G. of Charlottenberg, Germany. The earlier tantalum lamps had filaments varying in diameter up to 0.28 mm., but with the improvement in the method of making the metal more ductile, it was found possible to make wire having a diameter of less than 0.02 mm. This improvement permitted of the production of lamps suitable for use on a current of any voltage

commonly employed, but led to a difficulty in accommodating a long length of wire within a bulb of such a size as would be practicable to use. As tantalum has a much lower specific resistance than carbon, tantalum filaments have to be two and a half times the length and one quarter the diameter of carbon filaments for equal voltage and candle power. Thus, a tantalum filament for a 110 volt, 25 candle power lamp is 645 mm. long and 0.047 mm. in diameter, whilst a carbon filament for a lamp of similar voltage and candle power would be about 250 mm.

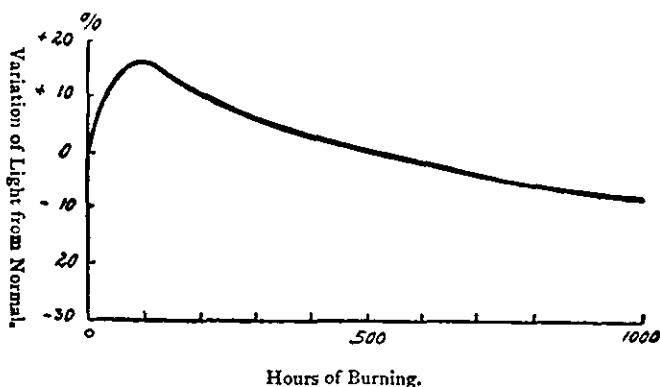

FIG. 7.—Variation of Luminosity of the Tantalum Lamp.

long and 0.18 mm. in diameter. The fact that the working temperature of the tantalum filament was very near to its softening point precluded the use of the double loop sometimes employed in carbon filament lamps, but this difficulty was surmounted by the invention of the "Spider" shown in Fig. 5 (German Patent, 153,328). The method of arranging the filament in zigzag fashion on the spider, as shown in Fig. 6, permits of the lamp being burned in any position.

Tantalum lamps have an initial efficiency of about 1.5 watts per (Hefner) candle power, the light intensity increasing slightly during the first fifty hours of use, and then decreasing slowly (see Fig. 7). The consumption of current per candle power

slowly increases with the time that the lamp has been in use (see Fig. 8). The light intensity of the tantalum lamp varies by about 4 per cent. for each 1 per cent.

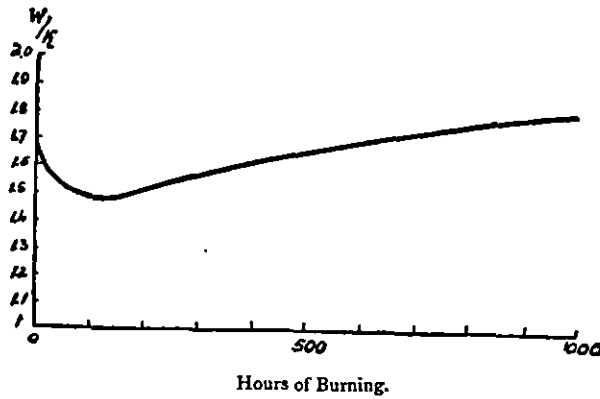

FIG. 8.—Variation in Consumption of Current of Tantalum Lamp.

difference in voltage at the lamp terminals. The variations in candle power caused by alterations in the voltage are shown in the following table:—

TABLE XX.

Variation in Pressure. Per Cent.	Candle Power.					Average Candle Power as Per Cent. of Normal.	Watts per Hefner <sup>1</sup> Candle Power.	
Below normal -	-20	3.9	6.3	9.9	12.6	19.7	39.4	2.60
	-15	5.0	8.0	12.5	16.0	25.0	50.0	2.25
	-10	6.5	10.3	16.1	20.6	32.2	64.5	1.95
	-5	8.1	13.0	20.3	26.0	40.5	81.0	1.70
Above normal -	+5	12.2	19.5	30.5	39.0	60.9	121.9	1.35
	+10	14.7	23.6	36.8	47.2	73.6	147.2	1.20
	+15	17.5	28.1	43.8	56.2	87.7	175.5	1.10
	+20	20.7	33.2	51.8	66.4	103.8	207.5	1.00
Normal pressure - ...		10	16	25	32	50	100	1.50

The initial increase in the light intensity may be due to a structural change in the filament, which causes a decrease in its resistance. When examined under the microscope, a tantalum filament, which has been burnt for some time on a direct current circuit, shows a tendency to contract into drops (see Fig. 9). The alternating current, under similar circumstances, causes a disconnected appearance in the filament (see Fig. 10). As would be expected from these observations, tantalum lamps when used on alternating current circuits have a somewhat shorter life than when a direct current is employed.

The tantalum lamp met with great success during its early days, about 103 million lamps being sold during the years 1905-1911.

**The Tungsten Lamp.**—The drawn wire tantalum lamp was followed by numerous patents for utilising metallic tungsten as a filament. Owing to the hardness and brittle character of the metallic tungsten at that time produced, the process of making filaments by drawing the metal, in the same way as tantalum was drawn, could not be employed. The filaments, therefore, had to be produced

<sup>1</sup> The Hefner candle power is equal to about 0.9 British standard candle.

by a "squirting" process, similar to that employed in the manufacture of carbon filaments, or by producing a coating of tungsten on a core of carbon or other refractory substance.

The many processes which have been employed up to the present day may be roughly classified into those involving—(1) Substitution. (2) Amalgamation. (3) Squirting a paste containing tungsten powder. (4) Squirting colloidal tungsten. (5) Drawn wire. (6) Alloy processes.

In the first-mentioned method, which is covered by French Patent, 347,661, of 1904; English Patent, 11,949, of 1905; German Patent, 184,379, of 1905, metallic tungsten powder is mixed with an organic binding material, such as gum, and squirted into filaments. The carbon is eliminated by placing the filaments in an atmosphere containing a volatile compound of tungsten, such as the oxychloride, and a small quantity of hydrogen. When the filament is heated to redness by the passage of an electric current, tungsten is substituted for carbon.

A typical example of the second class of process is one patented by the General

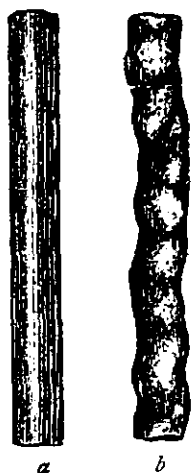

FIG. 9.—Tantalum Filament  
(a) before and (b) after Use  
on Direct Current Circuit.



FIG. 10.—Tantalum Filament  
after Use on Alternating  
Current Circuit.

Electric Company of the United States. The method consists in mixing metallic tungsten powder with an amalgam containing equal amounts of cadmium and mercury, and squirting the mixture through a die in the usual way. The cadmium and mercury in the filament, thus produced, are subsequently volatilised by heat, and the filament remaining has the usual brittleness, but it is claimed that after moderate heating it becomes pliable and can be bent to any desired shape (see English Patents, 18,745 and 18,748, of 1906, and 5,576, of 1907).

In the third type of process, as in the other classes, numerous modifications have been employed. Thus the binder may be one which, on heating, leaves a carbonaceous residue, *e.g.*, gum, sugar, gelatine, or nitro-cellulose dissolved in amyl acetate. On the other hand, it may consist of some substance which, although acting as a binding agent at ordinary temperatures, is volatilised, on heating, without carbonising. Examples of this class of binder are paraffin wax, camphor, and pinene hydrochloride. Binders of this class are employed in the paste process patented by Just, in which filaments are made by mixing a noncarbonising binding agent with a compound of tungsten which is reducible by hydrogen. After pressing and drying, the filaments are reduced in hydrogen at such a temperature that the

binder is volatilised. The process avoids the difficulty experienced in completely removing the carbon which is deposited when the other class of binder is used.

In certain processes, e.g., French Patent, 357,842, of 1905; German Patent, 182,683, of 1905, finely powdered metallic tungsten is mixed with an organic binding material and the paste squirted into threads, which, after drying in a non-oxidising atmosphere, are ignited by passing an electric current through them in an atmosphere of a reducing gas consisting chiefly of hydrogen.

The use of tungstic oxide in squirted filaments is covered by English Patent, 18,814, of 1905, and French Patent, 357,868, of 1905.

Tungstic oxide for the production of squirted filaments can be prepared, in a suitable condition, by boiling hydrated tungstic oxide with ammonia until crystallisation occurs. The crystals are removed, heated to 250° C. for some time, and the residue boiled with water until it changes to a viscous plastic mass, which is then ready for squirting into filaments (French Patent, 379,069, of 1907). According to some authorities, the violet oxide of tungsten ( $W_2O_5$ ) or the brown oxide ( $WO_2$ ) are more suitable for the manufacture of filaments, as they conduct electricity better at ordinary temperatures than does the yellow oxide ( $WO_3$ ).

According to English Patent, 14,850, of 1908, plastic tungstic acid, suitable for the preparation of filaments, can be made by treating the hydrated oxide with ammonia at -20° C.

**Colloidal Tungsten Filaments.**—One of the most successful of the squirting paste processes is that in which colloidal tungsten is employed. The feature of the process is that, owing to the plastic and coherent nature of the material, no binding material is required; a much stronger filament being thus produced, and the difficulty of removing the carbon from the filament is avoided.

The use of many colloidal metals for the production of lamp filaments is covered by English Patent, 28,154, of 1904, with numerous additions granted to Dr Kuzel. The metals mentioned in the master patent include tungsten, uranium, molybdenum, vanadium, tantalum, nickel, titanium, thorium, zirconium, platinum, osmium, iridium, and silicon.

Colloidal tungsten may be prepared by allowing an electric arc to play between roughened electrodes of tungsten under water, or by the methods of Wedekind or Wright. The finely divided colloidal tungsten can be separated from the water by slow evaporation, and the plastic mass, thus obtained, is squirted into filaments. At ordinary temperatures the filaments, thus obtained, do not conduct electricity at low voltages, but when heated to 60° C. they conduct sufficiently well to enable the final drying and sintering of the filament to be carried out. The preliminary heating to 60° C. can be dispensed with if a current of 400-1,000 volts be used for performing the operation (English Patent, 12,968, of 1908). In order to avoid small cavities in the filament, the heating is carried out in a non-oxidising atmosphere, the pressure of which is reduced to at least 150 mm., and preferably to 40 mm. During the operation a continuous current of gas, consisting of about 80 per cent. nitrogen and 20 per cent. hydrogen, is passed through the apparatus. As the temperature is gradually increased the tungsten returns to its massive state, and the filament decreases considerably in size and resistance.

Colloidal tungsten filaments have been produced in large quantities, but the process is now replaced, at one large works at least, by a process in which colloidal tungsten is used together with certain of the rare earth metals (see "Tungsten Alloy Filaments," p. 362).

**Drawn Wire Tungsten Filaments.**—The manufacture of drawn filaments from metallic tantalum has already been mentioned on p. 339. The production of drawn tungsten filaments was rendered possible by the discovery of a method of producing ductile tungsten introduced by the General Electric Company of the United States. The general principles involved in the method have been already

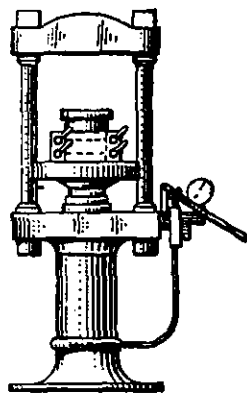

FIG. 11.—Hydraulic Press and Mould.



described on p. 348; the actual details of the various operations are not disclosed by those working the patents. The following description, from *La Technique Moderne*, 1914, 6, 193, through the *Electrical Review*, 1914, 74, 595, gives an account of the essential details of the process.

Pure metallic tungsten is very fragile at forging temperature, but at a white heat it can be hammered, rolled, or drawn, and so be rendered malleable. In order to obtain the metal in this condition, it must be free from oxide, iron, nickel, and contain only traces of sulphur, phosphorus, antimony, arsenic, selenium, or tellurium, whilst the carbon content must not exceed 0.05 per cent. The heating must be performed very gradually, and it is necessary to protect the metal from contact with air during the various stages of its manufacture. The operations may be roughly divided into six sections.

1. *The Production of Pure Metallic Tungsten.*—This is effected by heating pure tungstic oxide, prepared by one of the methods already described (see p. 346), in a current of pure hydrogen at a temperature of about 1,000° C.

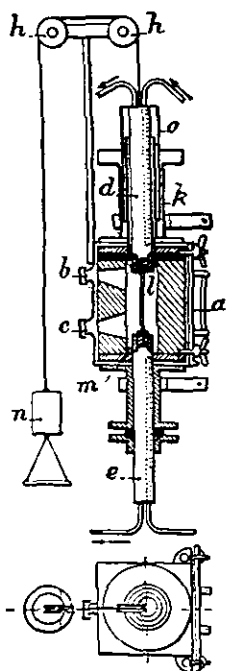

FIG. 12.—Electric Furnace.

2. *Agglomeration of the Tungsten Powder into Bars.*—

This is effected by means of a hydraulic press, exerting a pressure of about 5,000 kilos per square centimetre (see Fig. 11). The bars, which are about 130 mm. long and 4 mm. thick, are exceedingly fragile, and their formation requires considerable skill. The powder used in this process should be of medium fineness; if it is too fine or too coarse, the bars readily crumble after compression.

3. *Consolidation of the Compressed Bars.*—The bar, as it leaves the hydraulic press, is very fragile, and will break if laid on an uneven surface. It is given the desired firmness by heating for about one hour in a current of hydrogen in a tubular furnace, the temperature being slowly increased to full redness. The temperature is then very slowly raised to slightly above 1,000° C.

4. *The Burning of the Bars.*—The burning process is intended to create an intimate union between the minute crystals of tungsten, of which the bar is now composed. The operation must be carried out slowly and cautiously, as the quality of the filaments depends largely upon the success of this operation. The bars are heated to a temperature of about 2,850° C. (near the melting point of tungsten) in a special furnace shown in Fig. 12.

The casing of the furnace, which is of cast iron coated inside with graphite, is provided with small tubes *l* and *m* for the admission and discharge of hydrogen. The wall *a* of the furnace is removable, and is normally attached with screws and wing nuts. The opposite wall has two windows *b* and *c*, which permit the operation to be watched. The copper electrodes *d* and *e* are water cooled, the lower one being fixed whilst the upper one is suspended by a counterpoise and carries a bell *o*, which is immersed in a cylinder *k* filled with mercury. The bar to be treated is attached to the electrodes by spring grips, the furnace closed, filled with hydrogen and, as soon as all oxygen is removed, the heating current is turned on. The contraction of the bar during this heating amounts to about 14 per cent. In order to obtain a temperature of 2,650° C. a current of about 53 amperes per square millimetre is required for bars having a cross-sectional area of 16-20 sq. mm., whilst 57 amperes are required for a temperature of 2,730° C. with bars of similar size.

5. *Working the Bars by Hammering and Rolling.*—The sintered bars, as obtained by the last process, are still brittle enough to break if dropped from a height of 30-40 cm., and now require to be worked at a temperature of 1,200°-1,300° C., but as they oxidise very rapidly in air at this temperature, it is necessary to carry out the hammering or rolling, as far as it is possible, in a current of hydrogen. The machine used for this purpose is illustrated in Figs. 13, 14, and 15.

The dies *b* have on their interior surface a tapering groove of the same size as the bar; they are mounted with the hammer *c* in a recess in the hollow shaft *a*. The hammers, which have rounded external ends, are carried by the rotation of the shaft in front of the rollers *r*, which are arranged in a ring. The rapid revolution of the shaft causes the hammers to be driven outwards by centrifugal force, but they are thrown inwards as they come into contact with each roller and transmit the blows to the dies. When the shaft is rotating at about 400 revs. per minute, the hammers give

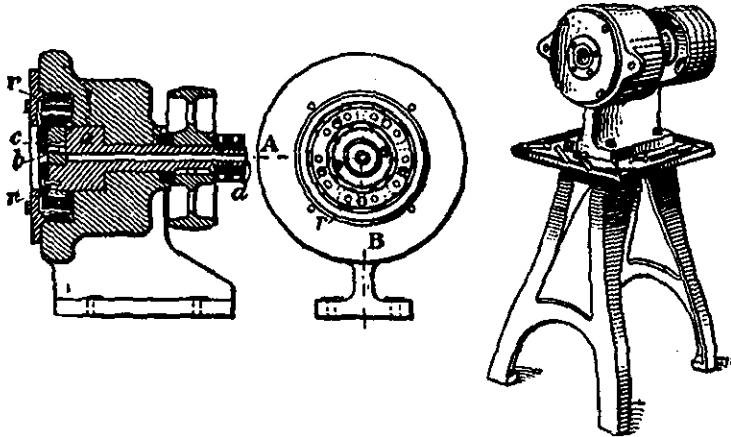

FIG. 13.—Section on A. B.

FIG. 14.—View with Cover Removed.

FIG. 15.—Complete Machine.

about 4,000 blows per minute, and these are distributed regularly over the surface of the bar. The latter, after being heated to 1,300° C. in an atmosphere of hydrogen, is quickly thrust into the machine, whilst a continuous supply of hydrogen is led in at *d* in order to prevent oxidation of the metal during the hammering. The diameter of the bar can be reduced about 4 per cent. at each treatment in the machine, so that in order to obtain a wire 1 mm. in diameter from a bar 6 mm. square about fifty treatments are necessary. Every third time that the bar passes through the machine the dies are replaced by others having an smaller diameter. When the wire has been reduced to a diameter of 0.75 mm. the metal has become so ductile that it can be bent and worked at ordinary temperatures.

6. Drawing the Bars into Wire.—

Although the drawing might be performed at ordinary temperatures, the operation is considerably facilitated by heating the drawplate, the arrangement used being shown in Fig. 16.

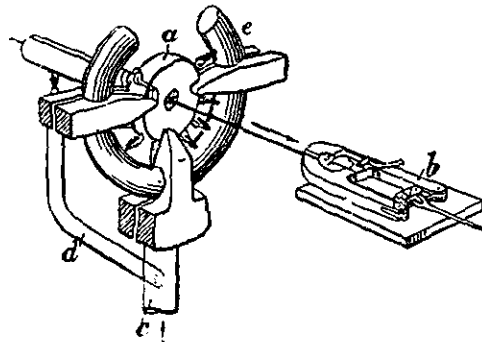

FIG. 16.—Heated Drawplate.

The drawplate *a* consists of a cylindrical block in which the diamond is fixed in the usual way. Lighting gas is brought by the pipe *c* to a burner *e*, which is arranged so as to direct its flames upon the periphery of the plate. Before entering the die, the wire passes through a cylindrical tube, which is also heated. The draw tongs *b* are similar to those usually employed in the drawing of steel wire.

The drawplate is lubricated with a mixture of deflocculated graphite and water. In order to point the ends of the wires, so as to enable them to enter the die, they are either plunged into melted potassium nitrate or, if they are already thin, they are immersed in a solution of potassium cyanide and made the anodes of an electric circuit. The successive dies employed differ very little in diameter, thus, starting with a wire, 0.65 mm. diameter, they decrease by about 0.0125 mm. as far as 0.35 mm., and from this size to 0.1 mm. the interval is 0.0065 mm. From 0.1-0.075 mm. it is 0.03 mm. From 0.075-0.0375 mm. it is 0.0025 mm., and finally from 0.0375-0.025 mm., and below it becomes 0.00125 mm. Thus about 100 dies are necessary. During the reducing of the wire from 0.65-0.45 mm. the temperature is maintained at 600°-650° C., whilst from 0.45-0.25 mm. it is

500° C., whilst for smaller diameters a temperature of about 400° C. is used. The wire thus obtained is coloured blue-black by graphite and a small amount of oxide, and is cleaned by being electrically heated to a dull red whilst passing it through a glass tube containing hydrogen.

According to English Patent, 21,513, of 1906, the tungsten wire, during the drawing operations, may be protected from oxidation by having a coating of some ductile metal such as gold, silver, or copper deposited on it.

At the present time, numerous firms are making lamps having filaments of drawn tungsten made under licence from the patentees. As would be expected, the drawn tungsten filament has proved considerably stronger in use than those made by squirting a paste consisting of a tungsten powder and a binder, and they have also the advantage of simplifying the manufacture of the lamp, as no joining of short lengths of filament is necessary.

With pure tungsten filaments, no matter by what process they are made, a very serious defect often manifests itself after they have been in use for a short time. This defect is crystallisation, which is the result of the tungsten reverting to its original hard, brittle condition, and shows itself by irregular thickenings of the filament.



FIG. 17.—Squirting Tungsten-Thorium Filament after 1,000 Hours on Alternating Current.



FIG. 18.—Squirting Tungsten Filament after 1,000 Hours on Alternating Current.

According to A. Lederer (*Elec. Journ.*, 1913, 10, 1175), these thickenings occur in a longitudinal direction when a direct current is used, but if an alternating current is employed, a sort of sliding motion occurs between adjacent portions of the filament, which eventually results in fracture. Crystallisation of the filament and subsequent volatilisation is also stated to be one of the most important causes of the blackening of the bulb, which often occurs after the lamp has been in use for some little time.

These defects can be obviated, to a large extent, by using, in place of tungsten, an alloy of this metal with certain of the rare earth metals (see below).

**Tungsten Alloy Filaments.**—Numerous processes have been patented in which alloys of tungsten have been suggested for use at some stage in the manufacture of the filaments.

The processes may be roughly divided into two classes:—

1. Those in which the finished filament consists of tungsten alloyed with some other metal.
2. Those in which an alloy of tungsten is produced at a certain stage in the manufacture, but the finished filament consists only of pure tungsten.

At the present time, the only process belonging to the first group which calls for notice is that in which an alloy of tungsten and thorium is used. The process, which is covered by Austrian Patent, No. 41,247, of 1906, consists in producing

a filament composed of tungsten alloyed with thorium and other rare earth metals. The filament, thus produced, is stated to be very ductile, even in the cold, and to remain in this condition after being in use for a considerable time.

Micro-photographs of two types of tungsten filaments are shown in Figs. 17 and 18, and illustrate the difference in the appearance of the ordinary squirted tungsten filaments and those of tungsten-thorium alloy after both have been used for a considerable time.

In this country, the process is being worked by the Brimsdown Lamp Company, who make the filament by mixing colloidal tungsten (see p. 359) with certain percentages of thorium and other rare earth metals. The thorium must be in such a condition as not to promote crystallisation of the colloidal tungsten.

Several modifications of the thorium-tungsten alloy process have been patented.

Thus, according to French Patent, 447,584, finely divided metallic tungsten is mixed with about 7 per cent. of thorium tungstate and an organic binding material and filaments are made by the usual squirting process. These are reduced at a temperature near the melting point of thorium. According to English Patents, 5,026 and 8,758, of 1912, tungstic oxide is mixed with 1.4 per cent. of thorium and compressed into rods, which are then reduced in hydrogen at a low red heat.

**Thorium** and other rare earth metals can be obtained in a **colloidal condition** by the process which has been described by Dr Kuzel. The metal, in an extremely finely divided condition, is treated alternately with dilute solutions of certain acid and neutral reagents.

Thus, 10 kilos of the metal are heated for twenty-four to forty-eight hours with 75 kilos of 15 per cent. hydrochloric acid, well agitated, decanted, washed with distilled water, until some colloidal metal begins to pass into the filtrate. The material is next treated for about twenty-four hours with 75 kilos of a 1 per cent. solution of potassium cyanide, washed with distilled water, and heated with 75 kilos of a 1 per cent. solution of ferrous sulphate. After well washing to remove iron salts, the residue is treated with a solution of a basic substance, such as a 2 per cent. alcoholic solution of monomethylamine or a 0.5 per cent. solution of sodium hydroxide. After repeating the process several times, the metal will pass almost completely into solution in distilled water.

Processes for obtaining **colloidal tungsten** are described by Müller, *Zeits. Chem. Ind. Kolloide*, 1911, 8, 93, and also by Wohler and Engels, *Zeits. Elektrochem.*, 1910, 16, 693.

The **second type of alloy process** is one in which the tungsten is alloyed with another metal in order to facilitate drawing, but the finished filament consists only of tungsten. A process of this class was successfully employed for some time by Messrs Siemens Bros., of London.

Nickel tungstate is mixed with tungstic acid, or similar plastic tungsten compound, in such proportion that the alloy produced on heating to 1,650° C. in hydrogen contains about 12 per cent. of nickel. (At a later date this quantity was reduced to 2 per cent.) The alloy, thus produced, is stated to be very ductile, and may be drawn into wire or rolled. After making the alloy into filaments by drawing, the nickel is expelled by heating *in vacuo*. This process has now been discontinued, as considerable blackening of the bulb took place after the lamps had been in use for some time.

Another method of producing this alloy was to mix the finely divided metals in the correct proportions, compress in rods, and heat these at the melting point of nickel in an atmosphere of hydrogen.

A machine suitable for making filaments from plastic material, such as tungsten powder mixed with a binder or the colloidal metal, is described in English Patent, 11,252, of 1912.

The machine comprises a rotating horizontal disc, having projecting studs on its outer edge. These studs intersect a filament as it leaves a fixed squirting orifice, so that the filament forms loops hanging down between the studs. These loops are carried round by the disc until they come opposite to a pair of burners which heat the two branches of the loop simultaneously at points near the studs, so as to sever the loop from the continuous filament. At this instant a rod is thrown forward beneath the loop so as to invert it as it drops, and guide it on to its support. This support may be a conductor, and can be heated so that the loops hanging on it will take its shape. The studs pass a brush before they again reach the squirting nozzle, so that the short pieces of filament remaining on them are removed.

It is very essential that all the small loops which go to make up a discontinuous filament, *i.e.*, one which is not made from one piece of wire, should be of the same cross-sectional area and resistance, otherwise the life of the lamp will suffer. In some works it is customary to actually weigh each section of filament on an extremely sensitive balance. In the case of a lamp having a filament of drawn wire, it is very essential that this should be of uniform diameter.

As many of the details in connection with the finishing and mounting of the metallic filaments are trade secrets they cannot be given here, but the following is a brief general account of certain portions of the process.

The central "spider" upon which the filament is to be wound is produced by moulding a glass rod to the desired shape, and then fixing the supporting metal hooks by hand. It is usual to make the upper and lower series of hooks of different metals, that used for the upper series being selected for its rigidity, whilst a more elastic material is used for the lower series. A very frequent arrangement is to make the upper row of fairly stout nickel wire, whilst the lower supports are made of molybdenum or an alloy of nickel with tungsten or molybdenum. This arrangement gives a fairly wide range of elasticity, and thus allows for the expansion and contraction of the filament which occurs in use. In some cases the necessary elasticity is attained by the use of thin copper wire coiled in helical form in place of the lower series of hooks. The actual shapes of the hooks used exhibit wide variations; thus, if continuous filaments are used, the support consists of a straight wire with a small terminal hook or loop; but if a discontinuous filament be employed, the individual loops require to be separately fixed to the wires of the "spider," and this has to be done either by using a tungsten solder or by employing a "pinched" joint.

The filament is usually wound very loosely on to the "spider," in order to allow for the permanent contraction which occurs when a current is passed through the wire; and a current is then sent through it for a few seconds in order to test the work.

The connection between the leading-in wires and the metal filament is made in three sections, as mentioned under carbon filament lamps (see p. 352).

The filament and spider is sealed into the bulb in the usual manner, but in order to remove from the latter all traces of moisture, which is stated to be one of the causes of blackening, a small quantity of some phosphorus compound is painted upon the stem. For this purpose a solution of red phosphorus in alcohol and ether is often employed. Owing to the high temperature employed in the final evacuation, the phosphorus is completely volatilised. The removal of the air from metallic filament lamps requires to be more thoroughly carried out than is necessary in the case of those having carbon filaments, and is usually performed by means of one of the modern types of pump mentioned on p. 353.

In some works it is customary to perform the final evacuation of the lamps at a temperature of 200°-300° C. The evacuated lamp is affixed to its metal socket, and tested in the same way as has been described already for the carbon filament lamp (see p. 353).

The last three stages in the manufacture of a metal filament lamp are shown in Fig. 19, B, C, and D).

**Nitrogen-filled Lamps.**—During the past two years an interesting development has taken place in the manufacture of high efficiency electrical illuminants, by the introduction of a glow lamp having a tungsten filament not enclosed in an evacuated globe, but in one which contains a quantity of an inert gas, the pressure of which at working temperatures is about equal to that of the atmosphere.

The invention appears to have been at first announced in a paper by I. Langmuir and J. A. Orange (*Proc. Amer. Inst. Elec. Eng.*, 1913, p. 1915). These workers, whilst investigating the causes of the blackening of metallic filament lamps, found that this defect, which is largely due to volatilisation of the filament, was considerably minimised by introducing an inert gas into the bulb. The gas found to be most suitable was nitrogen, as the loss of heat by convection

was considerably less than when hydrogen was used. It was also found that the loss of efficiency of a tungsten filament in an atmosphere of an inert gas near atmospheric pressure was greater for wires of small diameter (0.002 in.) than for larger wires (over 0.005 in.), hence the finer wires require to be coiled into a tightly wound helix, or otherwise concentrated into a small space. A filament wound in such a manner and mounted on its "spider" is shown in A, Fig. 19. It may be here mentioned that the helical filament is also coming into use for the evacuated type of lamp when required to give most of its light in the horizontal plane.

It was found that lamps made in this manner had an efficiency much greater than those of the usual evacuated type. Nitrogen-filled lamps are now being produced by several makers, and may be roughly classified into—(1) Large unit lamps consuming 0.4-0.5 watt per candle power, and having a life of at least 1,500 hours. These lamps take a current of 20-30 amperes, and hence must be run on a low voltage circuit. (2) Small unit lamps taking currents of about 10 amperes at voltages as low as 4 or 5. Their specific power consumption with

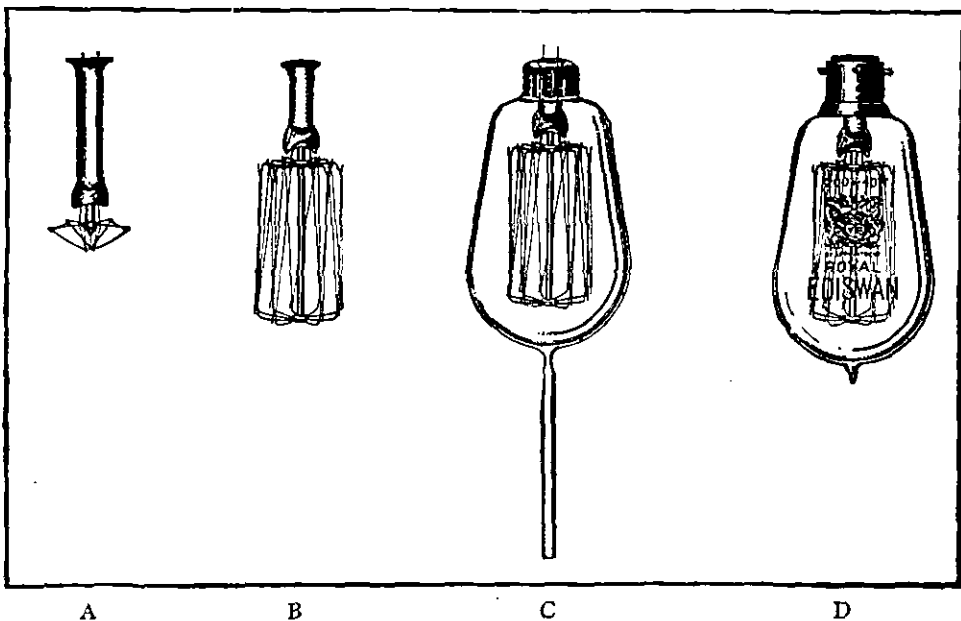

FIG. 19.—Stages in the Manufacture of a Metallic Filament Lamp.

a life of 1,000 hours varies from 0.6-1.0 watt per candle power. (3) Large unit lamps of several thousand candle power, run on standard lighting circuits of 110 volts, consuming 0.5 watt or less, per candle power. The maximum efficiency, at present, can only be attained with lamps taking large currents. The light given by the nitrogen-filled tungsten lamp is of a very penetrating character, and more adapted for replacing arc lighting than for the illumination of small interiors. A description of the "Nitra" lamp, one of the best known of this class, is given in *Helios*, 1913, 19, 316.

A method for the analysis of metallic filaments, which permits of individual filaments being examined, has been described by C. Baskerville (*Trans. New York Electrical Soc.*, 1912, No. 1).

**Cost of Production of Metal Filament Lamps.**—The profits on the manufacture of metal filament glow lamps are stated to be very small at the present time. The following figures, which are actual works costs, and show the outlay required for material and labour for the production of the individual parts of the lamps and the finished article, are from an account by H. T. Erb (*Electrical Review*, 1913, 73, 938).

The lamp under consideration is a 220 volt, 25 watt metal filament.

TABLE XXI.  
COST PER 1,000 LAMPS

	Materials.	Wages.	Breakages.
	Shillings.	Shillings.	Shillings.
Bulb - - - - -	37.1	4.5	0.63
Crown - - - - -	4.9	1.52	0.32
Electrodes - - - - -	28.0	2.25	0.29
Stem - - - - -	41.3	7.2	0.49
Star - - - - -	26.3	13.15	..
Attachment - - - - -	133.0	32.10	5.04
Melting-on - - - - -	37.1	9.7	15.85
Pumping - - - - -	...	11.8	18.7
Flashing - - - - -	0.6	1.96	4.70
Adjustment and completion -	21.8	9.35	6.90
	261.0	85.0	53.0

In the above table no allowance is made for the cost of gas, electric current, standing charges, and unproductive labour.

**The Efficiency of Metallic Filament Lamps.**—It is frequently stated that the drawn wire tungsten filament lamp has an efficiency of 1 watt per English candle power, with an average useful life of at least 1,000 hours. But according to statements by the makers, it would appear that this efficiency is rarely reached under ordinary conditions of working, especially in the case of the smaller candle power lamps. An average figure would appear to be between 1.1 and 1.25 watts per candle power. The useful life of an electric glow lamp is defined as the time taken for the mean horizontal candle power of the lamp to decrease 20 per cent. from its standard value, when run under standard conditions.

The characteristics of the various types of incandescent electric glow lamps are shown in the following table:—

TABLE XXII.

Material.	Watts per Hefner Candle Power.	Hefner Candle Power per Sq. Mm. of Surface.	Temperature of Incandescence.	Ratio of Hot to Cold Resistance.
Carbon - - - - -	3.5	0.154	1,800° C.	0.5
Osmium - - - - -	1.5	0.331	1,900° C.	8.94
Tantalum - - - - -	1.6	0.307	1,700° C.	6.07
Tungsten - - - - -	1.15	0.441	2,150° C.	12.12

The use of numerous other metals as metallic filaments has been patented. Thus, Kellner, in addition to tungsten, suggested thorium, titanium, and chromium (English Patent, 19,785, of 1898), whilst the use of metallic vanadium or niobium is covered by English Patents, 12,156, 12,157, and 12,159, of 1902. Carbides of certain metals have also been suggested, such as vanadium carbide (English Patent, 19,264, of 1905), cerium carbide, titanium carbide (see p. 328), and zirconium carbide (see p. 334). Cerium nitride is mentioned in English Patent, 929, of 1906. Numerous attempts have been made to utilise silicon as a filament. In one of these (French Patents, 446,140 and 446,310, of 1912) carborundum is used as the starting point. The use of metallic uranium is mentioned in United States Patent, 1,106,384, of 1914, and cobalt in French Patent, 460,093, of 1913.

### PATENT LITERATURE

A large number of patents dealing with the manufacture of incandescent electric lamps have been granted in many countries during the past few years, and it is not possible to give a complete list of these here.

During 1913, it was announced by the General Electric Company, the British Thomson-Houston Company, and Siemens Bros. Dynamo Works, all of London, that they had arranged to licence each other to operate all patents which they then held individually. The principal of these patents are stated to be as follows:—

English Patents, Nos. 27,712, of 1903; 20,277, 23,899, 27,713, 27,714, of 1904; 19,379, 20,175, 23,437, of 1905; 3,213, 6,803, 12,325, 21,513, 23,335, 18,622, of 1906; 3,174, 8,563, 16,503, 16,530, 16,531, of 1907; 5,387, 8,421, 17,350, 19,932, of 1908; 23,499, of 1909; 2,759, 8,031, 15,621, 23,121, 24,549, of 1910; 1,161, 1,162, 8,004, 17,722, 20,224, 20,380, 27,360, 28,576, of 1911; 873, 874, 2,284, 3,840, 11,439, of 1912.

It is understood that a large number of the other makers in the United Kingdom are also working these patents under licence.

**Acknowledgments.**—Thanks are due to the Edison & Swan United Electric Light Company, of Ponders End; Messrs Siemens Bros., of Dalston, London, N.E.; and the Brimsdown Lamp Company, of Brimsdown, Middlesex, for information concerning the method of manufacture of incandescent electric lamps, and to the first-mentioned company also for the loan of certain of the blocks illustrating this chapter.



## SECTION LXXXIII

## URANIUM

BY SYDNEY J. JOHNSTONE, B.Sc. (Lond.)

## LITERATURE

- E. ODENHEIMER.—“Fixation of Uranium Oxide on Textile Fibres.” *Farber Zeit.*, 1894, 5, 17.
- H. BREARLEY.—“Analytical Chemistry of Uranium.” London, 1903.
- R. BECK.—“The Nature of Ore Deposits.” Vol. I., p. 285. London, 1905.
- F. H. RIDDLER.—“The Colouring Power of Uranium Oxide in Glazes of Various Compositions.” *Trans. Amer. Ceram. Soc.*, 1906, 8, 210.
- L. H. MINTON.—“Discussion on Uranium Oxide” (as a ceramic colouring agent). *Trans. Amer. Ceram. Soc.*, 1907, 9, 771.
- H. Y. L. BROWN.—“Uranium Ores of South Australia.” Adelaide, 1911.
- SEGAUD and HUMERY.—“Deposits of Uranium in Portugal.” *Ann. des Mines*, 1913, Ser. 2, Vol. III., 111.
- R. B. MOORE and K. L. KITHIL.—“Preliminary Report on Uranium, Radium, and Vanadium.” *United States Bureau Mines, Bull.* 70. Washington, 1913.

ALTHOUGH uranium cannot be classed amongst the rare earths, its intimate association, in the mineral form, with radium renders a brief account of its occurrence and properties desirable. More important still, perhaps, is the fact that the uranium content of an ore is often a fairly accurate measure of the quantity of radium present. Besides radium, most uranium ores carry other radioactive matter, such as actinium, polonium, and ionium.

## Natural Occurrence

Uranium oxide was first isolated by Klaproth in the year 1789 from the mineral, **pitchblende**. The metal itself was first obtained by Péligot in 1842. Combined with other elements, uranium has been found in a large number of minerals; the majority of these, however, are of somewhat infrequent occurrence. A fairly complete list of these minerals is given in *U.S. Bur. Mines, Bull.* 70, p. 92. Amongst the more important uranium minerals may be mentioned **pitchblende** or **uraninite**, **carnotite**, and **autunite**. The less frequent minerals, **thorite** and **thorianite**, have already been described under **Thorium** (see p. 296).

Small quantities of uranium oxide are found in most of the minerals which contain phosphates and silicates of the rare earths, *e.g.*, **xenotime**, **columbite**, **cerite**, and **monazite**.

**Pitchblende**, which was for some years the most important uranium mineral, consists essentially of uranium oxide, together with varying amounts of rare earths, lead, lime, bismuth, etc. The mineral is sometimes found in octahedral crystals, but more commonly occurs massive. It varies in colour from greyish to dark green, brown, and black, having a conchoidal fracture, and a submetallic lustre. The specific gravity varies from 6.4-9.7, and the hardness is usually about 5.5. **Clevite** and **bröggerite** are the names applied to certain varieties of pitchblende rich in the rare earths.

**Carnotite**.—This promises to become in the future the largest source of uranium, and consequently of radium. Chemically, the mineral is a vanadate of uranium and potassium, sometimes containing small quantities of calcium, barium,

and iron. The mineral usually occurs in the form of very minute crystals, of a canary-yellow colour, as incrustations on certain other minerals. This mineral is also valuable for its vanadium content.

**Autunite.**—Anhydrous phosphate of calcium and uranium, with the formula  $\text{Ca}(\text{UO}_2)_2(\text{PO}_4)_2 \cdot 8\text{H}_2\text{O}$ . It is a bright yellow mineral, often crystallising in orthorhombic plates, having a specific gravity of 3.5-3.9. It is sometimes termed uranium mica.

### Geographical Distribution of Uranium Ores

The most celebrated deposits of **Pitchblende** occur in Austria, at Joachimsthal, where the mines have been worked since 1517 for various minerals, including silver and bismuth. It is only during the last ten years, however, that they have been extensively worked for uranium. At the present time, the mines are worked by the Austrian Government for uranium and radium, the export of the latter substance from Austria being prohibited. An account of these deposits is given by R. Beck (see above). In Saxony, the mineral occurs at Johanngeorgenstadt, Marienburg, Freiburg, and Schneeberg, and also at Pribram, in Bohemia.

In **Corwall**, pitchblende has been found in many mines of the tin area, associated with nickel and cobalt (as at Joachimsthal). An account of these mines is given in "The Geology of Falmouth and Truro, and of the Mining Districts of Camborne and Redruth," and "The Geology of the Country around Bodmin and St Austell," both of these publications being issued in the Memoirs of the Geological Survey of England and Wales. In the **United States**, pitchblende occurs in many localities in Gilpin County, Colorado, and has been mined to some extent. An account of recent work at these mines is given in *U.S. Bureau of Mines, Bull.* 70. The mineral in a very pure form has been found in **German East Africa**, but it would appear that the quantity available is small (see also W. Marckwald, *Centralbl. Min.*, 1906, 761). It also occurs in the Porcupine district of Ontario, **Canada**, where it is stated to contain a larger proportion of radium than the Austrian mineral. In **India**, the mineral occurs at the Singar mica mines of the Gaya district, and is now being worked. For an account of this deposit see *Records of Geol. Sur., India*, 1914, 44, 20.

Uranium ores have been exported from the **United States** for a number of years past, but it would appear that it was not until about the year 1912 that the authorities realised how much radium was leaving the country in this form. Carnotite ores occur chiefly in Colorado and Utah in the area lying between the Rocky Mountains of Colorado and the San Rafael Swell of Utah, the Denver and Rio Grande railroad, and the Arizona and New Mexico line. In this area the chief deposits of Colorado occur in the vicinity of Paradox Valley, McIntire Canon, Mesa Creek, and Gateway; whilst those of Utah include the La Sal Mountains, Dry Valley, Yellow Cat Wash, San Rafael Swell, and the Henry Mountains (F. L. Hess, *Econ. Geol.*, 1914, 9, 676). An investigation, carried out by R. B. Moore and K. L. Kithil (*U.S. Bur. Mines, Bull.* 70), showed that the richest deposits are those of the Paradox Valley. Much uranium ore is wasted in the process of sorting to get a marketable grade, owing to the lack of a cheap and efficient method of concentrating the ore.

Considerable attention has been directed, during the past few years, to the economic possibilities of the **South Australian** deposits of uranium ore. So far, deposits have been worked in two localities, *i.e.*, Radium Hill, 20 miles E.S.E. of Olary station on the Petersberg-Brokenhill railroad, and between Mts. Painter and Pitt in Flinders Camp, about 80 miles east of Farina. In the Olary district, where the work has so far proved the more successful, the uranium occurs, in the form of carnotite, as an incrustation on titaniferous magnetite. The ore, which has been worked for over two years, is magnetically concentrated at the mine, so that each ton of concentrate will give about 3.6 mg. of radium. The concentrates are treated at Woolwich, near Sydney. The Mt. Painter deposits, which yield autunite, carnotite, uranophane, and torbernite, appear to be rather less successful than those of Olary. For an account of recent progress in these localities see L. K. Ward, "Review of Mining Operations in South Australia," No. 19, p. 26, and *Min. Journ.*, 1913, 103, 1134.

During the past few years, **Portugal** has produced a quantity of uranium ore; chiefly autunite, torbernite, and small quantities of urano-circite (a hydrous phosphate of barium and uranium). The richest deposits are stated to occur in the district of Guarda, in the province of Beira, and to be closely connected with occurrences of tin and tungsten. The ore mined is stated to have an average content of about 1 per cent. of uranium oxide ( $\text{UO}_3$ ). The deposits are being worked by several companies, one of which employs about six hundred men.

Deposits of carnotite have been found in several localities in **Russia**, the largest being probably that of Tjua-Mujun in the Andijan district of Central Asiatic Russia. These and other Russian deposits have been described by E. de Hautpik in "Radioactive Minerals of Russia" (*Min. Journ.*, 1911, 92, 185), and F. L. Hess (*Min. Res. U.S.*, 1912, pt. i., 1031).

In **Madagascar**, autunite, blomstrandite, euxenite, and fergusonite occur in pegmatites, but the quantity available commercially is probably small.

In **Sweden**, a carbonaceous substance found in Silurian limestone and known as "Kulm" contains a small percentage of uranium, and it is proposed to burn it and recover the uranium from

the ash. The "Kulm," on burning, gives from 15.56 per cent. of ash, which contains 1.3 per cent. of uranium oxide.

**Commercial Value of Uranium Ores.**—The value of uranium ore is almost entirely dependent upon its radium content. At the present time, ores carrying less than 2 per cent. of uranium oxide ( $U_3O_8$ ) cannot be readily sold in this country. The price in October 1914 was about £30 per ton for ore containing 2 per cent. of uranium oxide ( $U_3O_8$ ). Sometimes an allowance is also made for any vanadium in the ore.

### Production of Uranium Ore

The following table shows the production and value of uranium ore so far as statistics are available:—

TABLE XXIII.

	1910.		1911.		1912.	
	Quantity.	Value.	Quantity.	Value.	Quantity.	Value.
	Metric Tons.	£	Metric Tons.	£	Metric Tons.	£
United Kingdom -	77	...	68	...	43	...
Austria - -	6,522	4,039	5,785	3,522	10,894	6,472
Germany <sup>1</sup> - -	95	11,000	82	8,250	5,053	3,200
Indo-China - -	1.1	390	1.9	200	...	...
Madagascar - -	2	30	29	349	1	..
Portugal - -	138	3,776	4,409	5,737	...	1,310
United States <sup>2</sup> -	No returns.	...	25	62,731	26	102,669

**Composition of Uranium Ores.**—The chemical composition of certain ores of uranium is shown in the following table:—

TABLE XXIV.

	Formula.	1. Pitchblende. Johäungeorgenstadt.	2. Carnotite. S. Australia.	3. Autunite. Autun.	4. Torbernite. Cornwall.
Uranic oxide - -	$UO_3$	59.37	47.8	61.34	61.00
Uranous oxide - -	$UO_2$	22.33			
Vanadic oxide - -	$V_2O_5$	...	16.8	...	...
Ferric oxide - -	$Fe_2O_3$	0.21	19.4	...	...
Alumina - - -	$Al_2O_3$	0.20	5.7	...	...
Manganous oxide - -	$MnO$	0.09	...	...	...
Lime - - -	$CaO$	1.00	1.0	5.24	0.62
Magnesia - - -	$MgO$	0.17	...	...	...
Lead oxide - - -	$PbO$	6.39	1.3	...	...
Copper oxide - - -	$CuO$	...	...	...	8.56
Potash - - -	$K_2O$	...	5.2	...	...
Soda - - -	$Na_2O$	0.31	1.8	...	...
Phosphoric acid - -	$P_2O_5$	0.06	trace	14.97	13.94
Arsenic oxide - - -	$As_2O_5$	...	...	...	1.96
Silica - - -	$SiO_2$	0.50	...	...	...
Water - - -	$H_2O$	3.17	...	19.66	14.16

1. Analysis by W. F. Hillebrand, *Amer. Journ. Sci.*, 1891, 42, 390. 2. G. S. Blake, *Min. Mag.*, 1910, 15, 271. 3. A. H. Church, *Journ. Chem. Soc.*, 1875, 28, 109. 4. Church, *Chem. News*, 1865, 12, 183.

**Chemical Treatment of Uranium Minerals.**—For the production of uranium compounds from pitchblende, the ore is first roasted in order to remove

<sup>1</sup> Returns are for uranium and tungsten ore.

<sup>2</sup> Values are for uranium and titanium ores, the quantities being calculated to the equivalent amount of  $U_3O_8$ . The quantities of "uranium and vanadium ore" produced in 1911, 1912, and 1913 were 8,468, 18,000, and 27,900 tons respectively.

most of the sulphur, arsenic, and molybdenum, and is then heated in a reverberatory furnace with sodium carbonate to which a little sodium nitrate has been added. The fused mass is washed with water, extracted with dilute sulphuric acid, and filtered, the insoluble residue being used for the production of radium. To the filtrate containing the uranium, excess of sodium carbonate is added, thus causing basic carbonates of iron, aluminium, nickel, and cobalt to be precipitated. After filtration, the uranium in solution is precipitated either by adding sodium hydroxide or by vigorously boiling the solution after neutralising it with dilute sulphuric acid. The sodium diuranate thus obtained is pressed, dried, and ground. The commercial salt has the composition  $\text{Na}_2\text{U}_2\text{O}_7, 6\text{H}_2\text{O}$ .

If the black oxide,  $\text{U}_3\text{O}_8$ , is required Wohler's method may be used. In this, the solution in dilute sulphuric acid is treated with sulphuretted hydrogen to remove arsenic, antimony, copper, lead, and bismuth, filtered, and after oxidising the filtrate with nitric acid, excess of ammonia is added. The precipitate, which consists of hydroxide of iron and ammonium uranate, is digested with a concentrated solution of ammonium carbonate containing excess of ammonia, in order to dissolve the ammonium uranate. After filtering the liquid and allowing it to cool, ammonium uranyl carbonate crystallises out. A further quantity of ammonium uranate can be obtained from the mother liquor by adding ammonium sulphide to precipitate the zinc, nickel, or cobalt, and evaporating the filtrate. Both ammonium uranate and ammonium uranyl carbonate give  $\text{U}_3\text{O}_8$  on ignition.

The possibility of utilising phosphatic uranium micas, such as autunite and copper autunite, as sources of radium and uranium, is discussed by F. Glaser (*Chem. Zeit.*, 1912, 36, 1166). It is stated that although the processes of extraction are comparatively simple, the profitable working of autunite is only possible when the percentage of uranium is high.

**Metallic uranium** can be prepared by several methods, one of which consists in mixing five hundred parts of  $\text{U}_3\text{O}_8$  with forty parts of sugar charcoal and reducing the mixture in a carbon tube in the electric furnace. The crude product, thus obtained, which still contains some carbon, is purified by being heated in a crucible, brasqued with  $\text{U}_3\text{O}_8$ , which is embedded in another crucible brasqued with titanium. The effect of this latter is to prevent access of nitrogen to the reduced uranium (H. Moissan, *Comptes rend.*, 1893, 116, 347). The metal may also be prepared by the electrolysis of the fused double chloride of uranium and sodium in an inert atmosphere using carbon electrodes (H. Moissan, *Comptes rend.*, 1896, 122, 1088).

For the production of **ferro-uranium**, reduction with aluminium is stated to be unsuitable, as the final product then contains aluminium, corundum, and uranium oxide (F. Giolitti and G. Tavanti, *Gaz. Chim. Ital.*, 1903, 33, 239). It is stated, however, that Stavenhagen's modification of the "thermit" process can be used (A. Stavenhagen and E. Schuchard, *Ber.*, 1902, 35, 909).

### Utilisation of Uranium and its Salts

So far, very few uses demanding much material have been found for **metallic uranium**. For a short time an impure form, containing some carbide, was employed as the sparking medium for automatic cigar lighters, but the material has now been superseded by the more efficient cerium-iron alloy (see p. 316). Metallic uranium has been suggested for use in electrodes of arc lamps. When enclosed in a quartz globe surrounded by an inert atmosphere, the arc between such electrodes gives a light very rich in ultra-violet rays. (See French Patent, 418,280, 15th July 1910.) According to the third and fourth additions to the above patent, a vacuum is substituted for the inert atmosphere, and in the seventh addition, dated 26th May 1911, a special type of lamp with mercury cathode is described and is stated to be suitable for sterilising liquids by means of ultra-violet rays.

Various attempts have been made to utilise **ferro-uranium** in the manufacture of special steel. In general, it may be stated that uranium steel has properties very similar to those of tungsten steel, but as ferro-tungsten can be produced at a

lower price than ferro-uranium, not much progress has been made in the use of the latter alloy in steel manufacture.

Uranium salts have long been known as **colouring agents for glass**. The colour produced is an opalescent yellow which is green by reflected light. Owing to the fact that about 20 per cent. of uranium oxide has to be used to produce the colour, the glass is somewhat expensive.

**In the Ceramic Industry** uranium salts find a limited use for the production of yellow and orange glazes, the salts most employed being the "yellow oxide" (sodium diuranate) and the green oxide ( $U_3O_8$ ).

The colouring power of uranium is strong, 0.006 equivalent giving a good colour, the depth of which is stated to be largely dependent upon the amount of lead present in the glaze. By suitable adjustment of the composition of the glaze and the conditions of firing, uranium can be made to give colours varying from yellow and orange to brown and dark olive-green. An account of the use of uranium salts in glazes is given by F. H. Riddle, *Trans. Amer. Ceram. Soc.*, 1906, 8, 210, and by L. H. Minton, *Trans. Amer. Ceram. Soc.*, 1907, 9, 771.

Uranium salts have been suggested for use as **mordants** for silk and wool, but no great progress seems to have been made in this direction. (See also E. Odenheimer, *Farber Zeit.*, 1894, 5, 17.)

Uranium oxide has been utilised as a catalyst in the synthesis of ammonia from nitrogen and hydrogen (Haber and Le Rossignol, *Zeits. Elektrochem.*, 1913, 19, 53).

Uranium salts have been used to a very limited extent for producing brown colours on textile fibres by treating them first with uranium nitrate solution and then with solutions of either ferrocyanide of potassium, gallic acid, tannic acid, or pyrogallol. (See P. Werner, *Bull. Soc. Ind.*, Mulhouse, 1892, 542, and E. Odenheimer, *loc. cit.*)

In photography, uranium nitrate has been suggested as a sensitising agent for paper (C. T. Roche, *Journ. Soc. Chem. Ind.*, 1888, 7, 231), and according to English Patent, 10,072, of 12th May 1896, uranium acetate combined with a suitable acid can be used with potassium ferricyanide for intensifying or reducing negatives. With potassium sulphocyanide it can be used for toning bromide prints.

**Analysis of Uranium Minerals.**—The mode of attacking uranium minerals varies largely with their nature. Thus, carnotite and autunite can be readily dissolved with the aid of dilute nitric acid, whilst thorianite and pitchblende are attacked by boiling concentrated nitric acid, but certain varieties of thorite are very difficult to dissolve, and require fusion before a satisfactory solution can be obtained. In the absence of vanadium and phosphates the following procedure may be adopted.

When the solution of the mineral is complete, the acid solution is filtered, diluted, and slowly poured into excess of ammonium carbonate. After allowing to stand for some hours, the solution is filtered, the precipitate dissolved in acid, and retreated with ammonium carbonate. The combined filtrates will now contain all the uranium, and may also carry small quantities of rare earths and calcium. The rare earths must be removed by precipitation with ammonium oxalate (see p. 298). The filtrate from this treatment is evaporated to dryness and ignited to remove oxalates, redissolved in nitric acid, and the latter removed by repeated evaporation with sulphuric acid. The residual sulphates are dissolved in a small quantity of water, and three times their bulk of alcohol added. After being allowed to stand for twelve hours, the precipitated lime is filtered and washed with alcohol. The alcoholic filtrate is evaporated to dryness, ignited, dissolved in nitric acid, and the uranium precipitated as ammonium uranate by the addition of a slight excess of ammonia. The solution is filtered, and the precipitate, after being washed with a 4 per cent. solution of ammonium nitrate, is dried, ignited, and weighed as  $U_3O_8$ .

When phosphates are present, difficulty is often experienced in carrying out the analysis, as described above, owing to uranium phosphate being somewhat difficultly soluble in ammonium carbonate, and when calcium is present this is also precipitated with the uranium phosphate. The following process overcomes these difficulties. The uranium solution is diluted, and a solution of ferric sulphate is added in slight excess of the amount required to precipitate the phosphorus as ferric phosphate. The iron and phosphate are then precipitated together by the basic acetate method, using ammonium acetate and keeping the solution slightly acid. The solution is filtered, the precipitate washed a few times with a very dilute solution of ammonium acetate, then dissolved in hydrochloric acid, and the precipitation repeated. The combined filtrates are evaporated to dryness with hydrochloric acid, the residue treated, as already described, for the removal of rare earths and calcium and the estimation of uranium oxide.

When vanadium is also present, as in carnotite, the analysis is much more intricate, owing to the necessity of separating this constituent from the uranium. Methods used by firms dealing in these ores will be found, in detail, in *U.S. Bur. Mines, Bull.* 70.

Methods for the analysis of ferro-uranium are given by W. Trautmann, *Zeits. angew. Chem.*, 1911, 24, 61.

## SECTION LXXXIV

# VANADIUM

BY SYDNEY J. JOHNSTONE, B.Sc. (Lond.)

### LITERATURE

- H. P. SMITH.—“Vanadium and its Uses.” *Journ. Soc. Chem. Ind.*, 1901, 20, 1183.  
 P. NICOLARDOT.—“Le Vanadium.” Paris, 1905.  
 W. PRANDTL.—“Die Literatur des Wolframs.” Leipzig, 1906.  
 J. KENT-SMITH.—“Vanadium as a Steel-Making Element.” *Journ. Soc. Chem. Ind.*, 1906, 25, 291.  
 “Vanadium, its Occurrence, Preparation, and Uses.” *Bull. Imp. Inst.*, 1909, 7, 401.  
 D. F. HEWETT.—“The Vanadium Deposits of Peru.” *Trans. Amer. Inst. Min. Eng.*, 1909, 40, 291.  
 W. F. BLEECKER.—“Notes on the Chemistry and Metallurgy of Vanadium.” *Met. and Chem. Eng.*, 1910, 8, 666; 1911, 9, 209 and 499.  
 W. H. HATFIELD.—“Influence of Vanadium on Cast Iron.” *Trans. Iron and Steel Inst.*, 1911.  
 S. FISCHER.—“The Extraction of Vanadium from Carnotite and Vanadiferous Sandstones.” *Met. and Chem. Eng.*, 1912, 10, 469.  
 W. W. CLARKE.—“The Technical Analysis of Ferro-Vanadium and its Products.” *Met. and Chem. Eng.*, 1913, 11, 91.  
 H. MANZ.—“Die Vanadiumerze und Ihre Aufarbeitung.” *Metal und Erz*, 1913, 10, 379.

DURING the past ten years increasing attention has been devoted to the utilisation of metallic vanadium and its salts. First, by reason of its utility in the production of special steels, and secondly on account of its being a by-product in the manufacture of radium from carnotite.

### Natural Occurrence

Minerals containing vanadium are of fairly common occurrence, being frequently found in arenaceous and other sedimentary rocks associated with other metallic minerals such as those of copper and iron. In spite of its frequent occurrence, however, ores of vanadium of sufficient richness to be of commercial value are somewhat rare.

The most commonly occurring vanadium minerals are **carnotite**, **patronite**, **roscoelite**, and **vanadinite**. Of less importance are descloizite (a basic vanadate of lead and zinc), mottramite (vanadate of lead and copper), and pucherite (bismuth vanadate). Vanadic oxide is a minor constituent of many bauxites, iron ores, and sometimes constitutes a large portion of the ash of certain lignites, coals, and bituminous substances.

**Carnotite** is a uranyl potassium vanadate and has already been described under **Uranium** (see p. 369).

**Patronite** is a greenish coloured sulphide of vanadium, which approximates in composition to the formula  $V_2S_9$ ; often occurring mixed with carbonaceous matter. It is frequently found associated with pyrites and free sulphur. When calcined, it burns readily and loses about 45 per cent. of its weight. The mineral has a hardness of 2.7 and a specific gravity of about 2.71.

**Roscoelite** is a muscovite mica in which a part of the aluminium has been replaced by vanadium. It occurs in minute mica-like scales which may vary in colour from green to brown. Its specific gravity is usually about 2.9. This is probably the most important vanadium ore produced in the United States.

**Vanadinite** is a chloro-vanadate of lead to which the formula  $9\text{PbO}, 3\text{V}_2\text{O}_5, \text{PbCl}_2$  has been assigned. It would thus contain, when pure, 19.4 per cent. of vanadic oxide ( $\text{V}_2\text{O}_5$ ). The mineral, which occurs in prismatic hexagonal crystals, has a specific gravity of 6.6-7.1. It may vary in colour from ruby red to yellowish or reddish brown.

**Composition of Vanadium Minerals.**—The chemical composition of typical samples of several vanadium minerals is shown in the following table:—

TABLE XXV.

	Formula.	Vanadinite, <sup>1</sup> Arizona.	Roscoelite. <sup>2</sup>
		Per Cent.	Per Cent.
Vanadic oxide - - - - -	$\text{V}_2\text{O}_5$	18.64	28.36
Arsenic oxide - - - - -	$\text{As}_2\text{O}_5$	Trace	...
Ferric oxide - - - - -	$\text{Fe}_2\text{O}_3$	0.40	1.23
Alumina - - - - -	$\text{Al}_2\text{O}_3$	...	13.94
Lime - - - - -	$\text{CaO}$	...	0.62
Magnesia - - - - -	$\text{MgO}$	...	2.06
Copper oxide - - - - -	$\text{CuO}$	0.18	...
Lead oxide - - - - -	$\text{PbO}$	77.00	...
Potash - - - - -	$\text{K}_2\text{O}$	...	8.87
Soda - - - - -	$\text{Na}_2\text{O}$	...	0.92
Chlorine - - - - -	$\text{Cl}$	2.69	...
Phosphoric acid - - - - -	$\text{P}_2\text{O}_5$	0.72	...
Water - - - - -	...	...	2.42

### Geographical Distribution of Vanadium Ores

Probably at least 70 per cent. of the vanadium produced commercially is obtained from the ores occurring at Minasragra, about twenty miles from Cerro de Pasco, **Peru**.

The vanadium here occurs in several mineral forms, amongst which may be mentioned a red calcium vanadate, which may carry as much as 50 per cent. of vanadic oxide ( $\text{V}_2\text{O}_5$ ) and is found in small pockets and crevices. A blue-black vanadium shale also occurs, which may carry as much as 13 per cent. of vanadic oxide and 5 per cent. of sulphur. The principal vanadium-bearing mineral, however, is patronite, which occurs in veins enclosed by porphyry dykes. An analysis of this mineral showed it to contain:—vanadium sulphide, 39.94 per cent.; molybdenum sulphide, 1.57; free sulphur, 30.57. This sample, on calcination, gave a product containing 58.08 per cent. of vanadic oxide. Descriptions of these deposits are given by D. F. Hewett, *Trans. Amer. Inst. Min. Eng.*, 1909, 40, 291, and W. F. Hillebrand, *Journ. Amer. Chem. Soc.*, 1907, 29, 1019.

An interesting deposit of asphaltic material occurs beneath these patronite beds. It is very rich in sulphur, deficient in hydrogen, and contains from 2-3 per cent. of vanadic oxide. Several attempts have been made to work certain of these asphaltic deposits for vanadium. Similar carbonaceous deposits occur in many localities in Peru, and also in the United States, in Oklahoma, and Nevada.

**Roscoelite** has been mined, in the **United States**, for a number of years, between Placerville and Newmire in San Miguel County, Colorado. It has been stated that these are probably the largest vanadium deposits yet located in the United States. The ore as mined carries an average of about 1.5 per cent. of vanadic oxide, but as the deposits are large and easily worked the operations can be conducted at a profit. For references to literature dealing with these and other deposits of vanadium in the United States see *U.S. Bur. Mines, Bull.* 70, p. 51.

**Vanadinite** deposits at Cutter, New Mexico, **United States**, were worked for some time, but were recently abandoned owing to difficulties encountered in the metallurgical treatment of the ore (see also F. L. Hess, *U.S. Geol. Surv., Bull.* 530, p. 157). The mineral also occurs, in the United States, in Arizona and California. In **Mexico**, it occurs at Villa Rosales, Chihuahua, Coyame, and Iturbide.

In **Spain**, important deposits of vanadinite occur and have been worked near Santa Marta, Estramaduras. The sandstone ore is stated to contain an average of 3 per cent. of vanadic oxide which is raised to about 14 per cent. by concentration. These deposits have been worked for vanadium since 1899, and up to 1906 they supplied the greater part of the world's requirements.

<sup>1</sup> Genth, *Trans. Amer. Phil. Soc.*, 1885, 22, 365.

<sup>2</sup> Roscoe, *Proc. Roy. Soc.*, 1876, 25, 109.

In **Argentina**, deposits of descloizite occur in the River Plate district, and these have been worked to a small extent.

At one time the preparation of vanadium on a large scale was carried out near Manchester, **England**, from mottramite, which occurs, with copper ore, in the Keuper sandstone beds at Alderley Edge and Mottram St Andrews, Cheshire. It would appear, however, that the payable portion of the deposits was worked out some years ago and the mining discontinued.

Deposits containing vanadium minerals also occur at the Wanlock Head Mine of Dumfries, Scotland, and in Portugal, Sweden, Russia, and Germany.

### Production of Vanadium Ore

The available statistics of the quantity and value of vanadium ore produced during recent years are shown in the following table:—

TABLE XXVI.

	1910.		1911.		1912.	
	Quantity. Metric Tons.	Value £	Quantity. Metric Tons.	Value £	Quantity. Metric Tons.	Value £
Argentine - -	...	...	14	...	40	...
Peru - - -	3,131	237,880	2,251	215,000	3,048	150,000
Spain - - -	...	...	199	2,860	38	730

No statistics are available regarding the quantity of vanadium ore produced in the United States, as in the returns the ores are included under the heading "Uranium and Vanadium Ore."

### Extraction of Vanadium from its Ores

The method of extraction employed on a commercial scale varies largely with the nature and richness of the ore. Usually, the difficulties encountered lie not so much in obtaining the mineral in solution as in the separation of the vanadium from other mineral substances which are dissolved at the same time, such as oxides of uranium, aluminium and iron, and silica.

The extraction processes may be roughly classified into (1) those involving the use of acids as solvents, (2) those employing alkaline solvents. In the opinion of many authorities, it is preferable to use the latter, where possible, as the alkaline vanadates, thus obtained, are less erratic in their behaviour than are the vanadyl compounds, which result from treatment with acid. The relative merits of the two types of process are discussed by S. Fischer, *Met. and Chem. Eng.*, 1912, 10, 469. In the following notes the description of the extraction processes has been divided into sections—(1) acid extraction processes, (2) alkaline extraction processes, (3) methods of recovering the vanadium from the extraction solution. These are followed by an account of the manufacture of ferro-vanadium from the compounds isolated.

**Acid Extraction Processes.**—The Koenig method, as described in United States Patent, No. 986,180, is stated to be suitable for roscoelite, vanadiferous sandstone, and similar minerals. The crushed ore is treated with a 20 per cent. solution of sulphuric, hydrochloric, or other acid, in a rotating drum; the temperature being kept at about 200° C., and the pressure at 225 lbs. per square inch. After undergoing this treatment for several hours, the solution is filtered and evaporated to a semi-solid condition. The salts are then heated to bright redness in order to expel the remaining acid. The solid residue of oxides and sulphates (if sulphuric acid were used in the first stage) is mixed with sodium carbonate, and roasted at a red heat in an oxidising atmosphere, with or without the addition of oxidising agents. The roasted mass is next treated with boiling water and then with carbon dioxide in order to precipitate any aluminium compounds present.

In the Fleck method (United States Patent, 880,645, of 1908), as used by the American Rare Metals Co., of Denver, Colorado, for the treatment of carnotite and



other vanadiferous ores, the finely crushed ore is treated with dilute sulphuric acid, which dissolves the uranium, vanadium, copper, and iron present. The clear solution is decanted and treated with sulphur dioxide gas in order to reduce the iron and vanadium compounds to the ferrous and vanadous states. A calculated quantity of ground limestone is then added until the metals begin to separate. The solution is filtered from the precipitated calcium sulphate, and the precipitation of the metals completed by boiling the solution with more limestone. The precipitate, thus obtained, which contains about 20 per cent. of uranium and vanadium oxides, is dried and shipped for further treatment.

The process described by P. Auchinachie in English Patent, 12,726, of 1904, consists in treating the ore, for about two hours, with hot concentrated sulphuric acid to which a small quantity of sodium nitrate has been added. The acid solution, after cooling, is electrolysed, using iron electrodes, vanadic oxide being deposited. In English Patent, 22,422, of 1904, the same inventor obtains the suboxide by nearly neutralising the above acid solution with sodium carbonate and boiling for some time. The pentoxide ( $V_2O_5$ ) is obtained from this lower oxide by boiling it with sulphuric acid and sodium nitrate.

Another acid treatment process has been described by J. Ohly (*Osterr. Zeit. für Berg und Hüttenwesen*, 1906, 54, 232). It is intended for the preparation of ammonium vanadate from carnotite-bearing sandstone. The finely ground ore is treated for some time with cold hydrochloric, sulphuric, or nitric acid and then heated until all the vanadium compounds are dissolved. A predetermined quantity of ammonium chloride is added to the solution, which is next evaporated to about one-third of its bulk and left to stand over-night. The separated ammonium metavanadate is recrystallised from a concentrated solution of ammonium chloride. A further crop of ammonium metavanadate is obtained from the mother liquor by further evaporation. The final liquid is treated with excess of sodium carbonate, boiled for half an hour, the precipitate filtered off, and the uranium in the filtrate then precipitated by the addition of caustic soda.

In the Saklatwalla process (United States Patents, Nos. 1,020,224 and 1,020,312, of 1912; English Patent, No. 6,119, of 1912) the ore is extracted with dilute sulphuric acid and, after nearly neutralising the solution, the vanadium is precipitated by adding an oxidising agent, such as ammonium persulphate, chlorine, or an oxy-acid of chlorine.

According to U.S. Patent, 890,584, of 1908, ore containing uranium and vanadium is treated with sulphur dioxide under pressure and the clear solution then boiled to remove the excess of the gas. This latter treatment causes the precipitation of the uranium as basic sulphite, and the vanadium is precipitated from the residual solution as calcium vanadate by adding excess of caustic lime.

**Alkaline Extraction Processes.**—In the majority of these methods the object is to produce soluble sodium vanadate, either by treating the ore with solutions of sodium carbonate or hydroxide, or by roasting it with sodium chloride. Almost without exception, the extraction of the vanadium is not complete, but in some cases it reaches 90 per cent. of the quantity present in the ore. Roasting the ore with sufficient sodium chloride to form sodium pyrovanadate is covered by United States Patent, 831,280, of 1906.

The Primos Chemical Co., of Newmire, Colorado, employ the following process for recovering vanadium from roscoelite. The ore is mixed with common salt, the mixture coarsely ground and dried until its moisture content is about 1 per cent. The caked material is ground to pass a 20-mesh sieve and then roasted for three hours. The roasted mass is next lixiviated with water and the vanadium precipitated, as ferrous vanadate, by the addition of excess of ferrous sulphate. No attempt is made to recover the small quantity of uranium present.

In the Herrenschildt process (French Patent, 328,421, of 1903) vanadinite is fused with an alkali carbonate, sulphate, or sulphide and carbon. In a later communication (*Comptes rend.*, 1904, 139, 635) the author describes the process more fully. The vanadinite is smelted with sodium carbonate in a reverberatory furnace, and thus are produced argentiferous lead and a slag carrying vanadate, aluminate, and silicate of sodium, and ferric oxide. Air is blown through the slag in order to fully oxidise the sodium vanadate, and the mass is then granulated by pouring it into boiling water. The solution obtained by agitating the fused mass with two further quantities of water contains all the sodium vanadate, some sodium silicate, but no aluminate. To remove the silicate, one portion of the liquid is evaporated to a syrup, sulphuric acid, 66° Bé., added to precipitate a portion of the vanadic acid, and then the whole added to the unevaporated portion of the liquid. The solution is next passed through a filter press in order to remove the precipitated silica (see French Patent, No. 334,333, of 1903, and United States Patent, No. 787,758, of 1905). The solution, which contains fairly pure sodium vanadate, is evaporated to expel excess of sulphuric acid, and the residue, after washing with water, consists of fairly pure vanadic acid. The yield is stated to be from 92-95 per cent.

The above process has been employed on a large scale for treating the ore from the Santa Marta mines of Spain.

In the Haynes and Engle process, as described in United States Patents, Nos. 808,839 and 828,850, of 1906, the ore crushed to 12-mesh is boiled with a solution of sodium or potassium carbonate until the uranium and vanadium are dissolved. The length of time of boiling and the concentration of the alkaline carbonate solution are, to some extent, determined by the quantity of vanadium and uranium in the ore, and it is stated that for each 1 per cent. of these metals in the ore, about 100 lbs. of sodium carbonate are required per ton of ore. The clear solution is treated with sodium hydroxide to precipitate the uranium as sodium uranate, which is then removed by filtration. The vanadium is next precipitated from the filtrate by the addition of slaked lime. When used on carnotite ore, this process gave an extraction of about 80 per cent. of the uranium and 60-65 per cent. of the vanadium present in the ores.

According to the process described by A. H. Perret (French Patent, No. 412,641, of 1901, and English Patents, 26,777, of 1910, and 15,181, of 1911) the ore is roasted with an alkaline carbonate and oxidising conditions maintained after the addition of sodium nitrate. The fused mass is granulated by being run into cold water and thoroughly lixiviated. The solution, which contains all the vanadium, may be treated with ammonium chloride so as to give ammonium metavanadate or the vanadic acid may be precipitated by the addition of an acid.

It was stated recently that a large works in France had been acquired by the Santa Marta Co., of Spain, in order to treat their ore by this process.

In addition to the processes already described for the separation of uranium and vanadium on a technical scale, that of W. F. Bleecker must be mentioned. As described in United States Patent, 1,050,796, the process consists in treating the alkaline carbonate solution with sufficient sodium hydroxide to precipitate the uranium as a mixture of uranyl hydrate and sodium uranate. This precipitate, which contains some vanadium, is filtered, washed, dissolved in acid, and the solution treated with excess of sodium carbonate. The solution is then electrolysed, using anodes of any active metal, such as iron, nickel, or copper, the vanadium being precipitated on the anode as vanadate of the anode metal. When all the vanadium has been deposited the uranium in the filtrate may be recovered by one of the known methods.

A method for extracting vanadium from copper vanadate is described by W. F. Bleecker in United States Patent, 1,049,330.

**Methods of Recovering the Vanadium from Mill Solution.**—A number of the processes already described have included details of the method of recovering the uranium and vanadium from the extraction or "mill" solutions. These may be briefly summarised as consisting in precipitation (1) as ferrous vanadate by nearly neutralising the solution, and adding ferrous sulphate; (2) as calcium vanadate by the addition of slaked lime; (3) by electro-deposition.

In the first-mentioned process several difficulties may be encountered, thus, according to W. F. Bleecker (*Met. and Chem. Eng.*, 1911, II, 501), sodium sulphate, formed by the interaction of the sodium carbonate and ferrous sulphate, is a powerful solvent for ferrous vanadate unless the ferrous sulphate is present in considerable excess. A small amount of a colloidal compound is formed, which causes difficulty in washing the precipitate, and loss of vanadium. Calcium vanadate would seem to suffer from few of the above objections.

Electrolytic precipitation appears to possess several advantages over the foregoing methods. In all hydro-electrolytic processes vanadium is always an anode product, and so, if ferrous vanadate is required, the nearly neutral solution containing the vanadium is electrolysed, using iron anodes and cathodes of almost any metallic substance. A potential difference of about 4 volts is maintained between the electrodes. As a rule, any impurity present in the solution is found, in part at least, in the final product. For a discussion of the process, see W. F. Bleecker, *loc. cit.*

**Vanadic Acid** may be prepared from the solution of sodium vanadate by treatment with acid as already described, but this process does not precipitate all the vanadium; some 10 per cent. remaining in solution. An electrolytic process, described by W. F. Bleecker, takes advantage of the difference in solubility of sodium vanadate and vanadic acid.

The solution of sodium vanadate, which must not contain chlorides, is heated to 90° C., and then made slightly alkaline with sodium carbonate. The clear liquor is decanted, evaporated to 30° Bé., when it will contain about 200 g. of vanadic acid per litre. This solution is transferred to a porous pot, and electrolysed in a compartment cell, the liquid in the outer jar being water containing a little lye. A platinum anode is used, whilst the cathode may consist of iron or copper. A potential difference of 6-8 volts is maintained together with a current density of 30 amperes per square foot of anode surface. The effect of the current is to cause the sodium ions to travel to the outer vessel, leaving vanadic acid in the inner porous pot. As this salt is less soluble in water than is sodium vanadate, a portion of it is precipitated. The product obtained, in this way, is easily filtered and washed, and contains about 98 per cent. of vanadic oxide ( $V_2O_5$ ). Mineral acids seriously interfere with the efficiency of the reaction.

The oldest process for obtaining vanadic acid is that of preparing ammonium metavanadate, and then driving off the ammonia by heating.

When dry calcium vanadate is treated with hot hydrochloric acid, red vanadic acid separates out, which can be washed with dilute acid and water.

The product always contains some lime salts, and a considerable quantity of hydrochloric acid is present as vanadyl dichloride. If the material be dried and fused a practically pure sample of vanadic oxide ( $V_2O_5$ ) will be obtained.

**Metallic Vanadium** may be produced, according to G. Gin (*Elektrochem. and Met. Ind.*, 1909, 7, 264), by the electrolysis of a solution of vanadium trioxide ( $V_2O_3$ ) in fused calcium vanadate.

The lining of the bath in which the electrolysis is performed is pure electrolytically fused alumina. The anodes are composed of carbon, whilst the cathodes are conical in form, and consist of pulverised and agglomerated ferro-vanadium. A current density of about 4.5 ampères per square inch of anode is recommended.

The metal may also be prepared by the alumino-thermic method (see W. Prandtl and B. Bleyer, *Zeits. anorg. Chem.*, 1909, 64, 217, and *Ber.*, 1910, 43, 2602, and R. Vogel and G. Tammann, *Zeits. anorg. Chem.*, 1909, 64, 225).

**Ferro-Vanadium.**—The processes available for the production of this substance are the reduction of ferrous vanadate, calcium vanadate, or the oxides, by means of (1) carbon in the electric furnace; (2) the alumino-thermic process.

Alloys produced by the first method usually contain somewhat large amounts of carbon (1.5-6 per cent.), which renders the alloy objectionable for certain uses in the steel industry.

For the alumino-thermic process, it has been stated that the lower oxide ( $V_2O_3$ ) is more suitable. The majority of the ferro-vanadium now on the market contains from 25-50 per cent. of vanadium.

In the Gin electrolytic process for the production of ferro-vanadium from vanadic acid, as described in *Zeits. Elektrochem.*, 1903, 9, 831, electrodes prepared from a mixture of vanadic acid and retort carbon are used as the anode in a bath of fused iron fluoride dissolved in fused calcium carbide, whilst fused steel constitutes the cathode.

In French Patent, 340,413, of 1904, the electrolyte is composed of fused calcium fluoride, but iron fluoride is also added, as the decomposition of this latter substance assists the process by regenerating the electrolyte at the expense of the anode.

In a later communication (*Proc. 7th Inter. Cong. Appl. Chem.*, 1909, Sect. 10, p. 10) the same inventor suggests the use of vanadic acid dissolved in fused calcium fluovanadate. A carbon anode is used, whilst the cathodes consist of agglomerated carbon and vanadic acid as before. A current density of 0.7 ampère per square centimetre of anode surface is stated to be the most suitable.

Ferro-vanadium may be prepared, according to United States Patent, 866,561, of 1907, by passing an electric current through a bath of molten ferro-silicon and vanadic oxide in calculated amounts.

According to United States Patent, 875,208, of 1907, ferro-vanadium is prepared by mixing the oxide with the calculated amounts of iron and carbon and passing a current through the charge.

**Composition of Vanadium Alloys.**—As already stated, ferro-vanadium made by the reduction of vanadium compounds by means of carbon contains from 2-6 per cent. of the latter element, and has not the same utility, in the steel industry, as those alloys with under 1 per cent. of carbon.

The reason for this is stated to be that vanadium readily combines with carbon, to form a carbide which is a stable product and passes into solution in the steel without decomposition, and is stated, therefore, to be of much less value for use in the steel industry.

The melting point of a ferro-vanadium, practically free from other elements, and containing 40 per cent. of vanadium, is about  $1,480^\circ\text{C}$ . The melting point becomes gradually lower as the amount of vanadium is decreased until 35 per cent. is reached, when it remains stationary at  $1,425^\circ\text{C}$ . until 30 per cent. is attained. From this point, as the vanadium is decreased to 25 per cent., the melting point gradually rises to about  $1,450^\circ\text{C}$ .

Most firms supply several grades of ferro-vanadium, of different vanadium content.

The amounts of certain elements in commercial ferro-vanadium are shown in the following table:—

TABLE XXVII.

	Per Cent.	Per Cent.	Per Cent.	Per Cent.	Per Cent.
Vanadium - - -	20 to 25	25 to 30	30 to 40	35 to 42	30 to 40
Silicon - - -	1.5 to 3.0	Below 2.0	Below 2.0	Below 2.0	1 to 3
Carbon - - -	4 to 6	0.25	0.25	0.25	...
Aluminium - - -	Below 0.05	Below 2.0	Below 2.0	Below 1.0	...
Manganese - - -	6 to 8	...	...	...	...

Cupro-vanadium may have the following percentage composition—vanadium, 10-15; copper, 60-70; aluminium, 10-15; nickel, 2-3.

### Utilisation of Vanadium and its Salts

At least 90 per cent. of the vanadium extracted is utilised in the form of its ferro alloy, in the steel industry; a use which has gradually increased during the past ten years. A very complete account of the use of vanadium and its alloys in steel-making has been given by J. Kent-Smith (*Journ. Soc. Chem. Ind.*, 1906, 25, 291). Briefly summarised, the effect of vanadium on steel may be stated as being to increase the elastic limit and ultimate tensile stress without reducing the ductility.

It is chiefly employed in connection with the manufacture of chrome, manganese, open hearth and high speed tool steels, being especially useful in the production of steel required for use in the construction of motor cars, steel shafts, locomotive axles, rock drills, and similar work subject to shock. Vanadium is stated to toughen steel in several ways, such as (1) by causing any oxides and nitrides present in the steel to pass into the slag; (2) the metal passes into solid solution in the ferrite or carbonless portion of the steel rendering the metal more coherent and less liable to disintegration. The quantity of vanadium required for the first-mentioned effect rarely exceeds 0.1 per cent. of the weight of steel treated.

The total quantity of vanadium added to ordinary engineering structural steels usually amounts to about 0.25 per cent., whilst as much as 2.0 per cent. may be added to high quality tool steels.

For further details see J. O. Arnold and A. A. Read, *Trans. Iron and Steel Inst.*, 1912, 85, 215; P. W. Shimer, *Trans. Amer. Inst. Min. Eng.*, 1912, 883.

Copper-vanadium alloys are much used in the production of solid copper castings and bronzes, as well as in the manufacture of certain aluminium alloys.

A number of uses have been suggested for vanadium compounds, but it would appear that few of these demand any large quantity of material.

In **Photography**, vanadium salts have been used for toning silver-bromide prints to a green colour. According to German Patent, 215,071, of 1909, and U.S. Patent, 979,887, of 1910, when 500 g. of liquid vanadium chloride are mixed with 1,310 g. of anhydrous oxalic acid, a solid product is obtained which may be compressed into tablets and is readily soluble in water. The toning bath is prepared by dissolving 3.8 g. of this product together with 1.5 g. of anhydrous oxalic acid, 1 g. of ferric oxalate, and 1 g. of potassium ferricyanide in one litre of water. The photographic properties of vanadium salts are discussed by L. Lumière in *Moniteur Scientifique*, 1894, 42, 437.

The use of vanadium or its alloys in place of lead in **accumulators** has been patented (French Patent, 357,601, of 1905), and in the same specification it is mentioned that solutions of vanadium salts may replace sulphuric acid in accumulators.

Vanadium salts have been used for colouring **pottery** and **glass**, and the pentoxide ( $V_2O_5$ ) has been suggested for use as a "gold bronze."

Vanadium salts are employed as **mordants**, for fixing aniline black on silk, and in calico printing. The use of ammonium vanadate in dyeing leather is described in *Journ. Soc. Chem. Ind.*, 1882, 1, 185.

When solutions of vanadium salts are mixed with tincture of galls, a deep black colour is produced, and it has been suggested that the solution might be employed as a **writing ink**. It has been shown, however, that although the colour is unaffected by acids, alkalis, or chlorine, it is not permanent.

As **Catalysts**, oxides of vanadium may be employed in the electrolytic oxidation and reduction of certain organic compounds (see French Patent, 345,701, of 1904). It is also stated to accelerate ordinary oxidation (see A. Naumann, L. Moeser, and E. Lindenbaum, *Journ. prakt. Chem.*, 1907,

75, 146). Vanadium carbide has been suggested as a filament for incandescent electric lamps (English Patent, 19,264, of 1905). In medicine, certain vanadium salts find a limited use.

### Chemical Analysis of Vanadium Ores and Alloys

Space does not permit of an account being given of a method for the analysis of complex vanadium ores, but the following "Rapid Method for the Determination of Vanadium in Ores," as given in *United States Geol. Survey, Bull. 70*, p. 90, may be of service. It is suitable for ores which are readily attacked by acid.

Treat 2-5 g. of the ore in a 16-oz. Erlenmeyer flask with 20 c.c. of hydrochloric acid (sp. gr. 1.20), and warm for half an hour. Add 20 c.c. of water and 20 c.c. of sulphuric acid, and evaporate till fumes of sulphuric acid are liberated. While the mixture is hot, add powdered potassium permanganate, a little at a time, until all organic matter is oxidised and an excess of permanganate is present. Heat for a few minutes, cool, and add 25 c.c. of water and a few drops of a strong solution of potassium permanganate to ensure complete oxidation. Add 50 c.c. of hydrochloric acid (sp. gr. 1.20), and evaporate as rapidly as possible, without causing "bumping," until the hydrochloric acid is expelled and sulphuric acid fumes are evolved. Continue the fuming for ten minutes. Cool, add a little cold water, dilute to 250 c.c. with boiling water, and determine the vanadium by titrating the hot solution with a standard solution of potassium permanganate.

In most cases it is unnecessary to remove the insoluble matter; sometimes, however, it is advisable to do so. Place the ore in a beaker, add 10 c.c. of hydrochloric acid and 5 c.c. of sulphuric acid, evaporate till fumes of the latter are liberated, take up with water, and filter into the flask. Then add 15 c.c. more sulphuric acid, and proceed as above.

If arsenic and molybdenum are present, they may be removed from the dilute sulphuric acid solution before filtration by precipitation with sulphuretted hydrogen.

Success with this method depends upon complete destruction of the organic matter and complete oxidation of the iron, etc., by potassium permanganate. Some vanadium ores contain much organic matter. In treating these the sulphuric acid solution should be heated longer, and several cautious additions of powdered potassium permanganate should be made. In some cases preliminary calcination at a low temperature will save time. Several other methods are also given in the above-mentioned bulletin.

A comprehensive account of the analysis of vanadium ores of all types is given by W. F. Bleecker in *Met. and Chem. Eng.*, 1911, 9, 209, whilst the methods suitable for ferro-vanadium are discussed by W. W. Clarke, *Met. and Chem. Eng.*, 1913, 11, 91.

Thanks are due to the **International Vanadium Co.**, of Liverpool; **The American Vanadium Co.**, of Pittsburgh, U.S.A.; and **The Primos Chemical Co.**, of Primos, Delaware Co., U.S.A., for supplying certain information concerning the uses of vanadium salts and alloys.

## SECTION LXXXV

# THE INDUSTRY OF RADIO- ACTIVE SUBSTANCES

BY ALEXANDER S. RUSSELL, M.A., D.Sc.

*Late Carnegie Research Fellow and 1851 Exhibition Scholar of the University of Glasgow*

### LITERATURE

- E. RUTHERFORD.—“Radioactive Substances and their Radiations.” Cambridge University Press, 1913. This is the best book on Radioactivity.
- F. SODDY.—“The Chemistry of the Radio-elements.” Longmans, Green, & Co. Part I. (new edition), 1915. Part II., 1914. These books deal thoroughly with the chemical aspect of Radioactivity.
- J. JOLY.—“Radioactivity and Geology.” Archibald Constable & Co., 1909. This work deals with the distribution of radium, etc., in the earth's crust, and gives in detail methods for detecting radium in minerals, waters, muds, etc.
- C. A. PARSONS, in an article in *Science* (31st October 1913), gives a valuable account of the radium resources of the world.
- E. T. WHERRY.—“Carnotite near Mauch Chunk.” *Bull.* 580-H., *U.S. Geol. Sur.* Washington, 1914.
- E. EBLER and W. BENDER.—“Preparation of Radium.” *Zeits. anorg. Chem.*, 1914, **88**, 255-264.
- BULLETIN 70, issued by the Bureau of Mines, Department of the Interior, Washington, U.S.A., 1913. This bulletin deals with the uranium, radium, and vanadium resources in the Western States.
- RADIUM.—Report presented to the House of Representatives, U.S.A. See *Chem. News*, 1914, 110, 264-266, 276-278, 284-286, 301-302, 310-312; see also *Journ. Soc. Chem. Ind.*, 1913, 616, 1066, 1107.
- An excellent account of the applications of radium for curing diseases is given in Westcott and Martindale's “Extra Pharmacopœia.”

THE following are the chief recent patents relating to the extraction, preparation, and use of radioactive materials:—

*British.*—20,922, 1902; 11,926, 1905; 24,222, 1906; 14,760, 1909; 19,820, 1909; 25,504, 1910; 778, 1911; 14,471, 1911; 21,462, 1911; 8,908, 1912; 20,081, 1912; 24,887, 1912.

*United States.*—787,928, 1905; 788,480, 1905; 895,478, 1908; 907,066, 1908; 917,191, 1909; 1,076,141, 1913; 1,065,581, 1913; 1,065,582, 1913; 1,084,734, 1914; 1,100,743, 1914; 1,103,600, 1914.

*French.*—370,749, 1906; 386,751, 1908; 406,299, 1908; 411,099, 1909; 411,629, 1909; 416,588, 1910; 418,455, 1909; 429,368, 1911; 440,236, 1912; 440,127, 1912; 440,236, 1912; 455,189, 1913; 459,081, 1913; 456,990, 1912; 466,015, 1913; 466,850, 1913; 467,330, 1914.

*German.*—226,804, 1909; 264,901, 1912; 256,666, 1912; 269,541, 1911; 269,692, 1912; 274,874, 1913.

## INTRODUCTION

**History.**—The discovery of X-rays by Röntgen in 1895 called attention to the study of other obscure radiations. Becquerel, between 1895 and 1903, discovered the fact that uranium salts gave invisible rays which affected a photographic plate in the dark. In 1898 G. C. Schmidt and Madame S. Curie discovered that thorium salts acted in a similar way, and this led to the discovery of the radioactive elements, polonium and radium.

In 1902 Geoffrey Martin (*Chem. News*, 1902, 85, 205) put forward the theory that the radioactive elements are elements undergoing decomposition—the theory now universally accepted but received at the time of its publication with open ridicule. Rutherford and Soddy, later in the same year, adopted the same view, which was put on a firm experimental basis by their classical researches. The evolution of helium from radium was first proved by Ramsay and Soddy in 1903. Radium emanation was first recognised as a gas by Rutherford and Soddy in 1902. Fajans, Russell, Fleck and Soddy in 1913-1915 established the position of the radioactive elements in the periodic system.

There are few departments of technical chemistry that have been more neglected in Great Britain than technical work in connection with the radium industry. Part of this neglect has its origin in the reception given by some prominent chemists in England to the chemical aspect of the pioneer work on radioactivity carried out by Rutherford and his colleagues in 1902 and the years that followed. The subject was regarded in many quarters as fantastic, speculative, unsafe, and of no importance, and it was generally taken for granted that any work that might be done in it could be conveniently left to physicists who possessed a knowledge of inorganic chemistry. The second and more important reason has been the great difficulty of obtaining in this country, either cheaply or in any quantity, the raw material from which the more important radioactive constituents could be worked up. The uranium ores are by no means plentiful in amount, and are only found in certain parts of the world. Again, immediately after its discovery radium was surrounded by a halo of romance by the press of England and the Continent. A substance which had hitherto been of theoretic interest only, and of little use practically, was then declared to be a body likely to be of the highest practical value in the future. This speculative pronouncement had the effect of preventing workers from putting it to any practical use. The fortunate possessors of the raw material from which this substance could be extracted did what most people do with a thing that attracts general attention, they proceeded to make as much money out of the material as they could so long as it held the public mind. The result has been that the prices of raw material and of purified material alike have risen continuously, until at the present time only those who have large sums of money at their back are able to obtain possession of it.

Radium, mesothorium, or any other radioactive substance should never be bought without a guarantee as to its genuineness, its purity, and its amount. This can now be easily obtained at the National Physical Laboratory at Teddington, in England.

## RADIOACTIVE ELEMENTS

It is necessary, for the better understanding of what follows, that a short account be given here of the theoretical work on radioactivity, in so far as it is necessary to explain things of a technical nature. The reader is referred to Rutherford's book for a full account.

Radioactivity is an atomic phenomenon. The radioactivity of a radium atom, for instance, is due to the element, radium, itself, and to that alone. It is in no

way increased or decreased when that element is chemically combined with other atoms. It is neither diminished nor increased in the least degree by subjecting the body to any change of pressure or of temperature. Radioactivity is due to the expulsion of certain **radiations**, which are conveniently grouped under three heads according to their penetrating power. The least penetrating of the three is the  **$\alpha$ -particle**, or, as it was formerly called, the  **$\alpha$ -ray**.

This radiation or particle possesses two positive charges of electricity, and is expelled by different radioactive atoms with different velocities, all of which, however, are of the order of one-tenth of the velocity of light. This particle has been definitely proved to have an atomic weight of about four, and is indeed a charged atom of helium.

The most penetrating radiation is called the  **$\gamma$ -ray**.  $\gamma$ -rays are of the same nature as X-rays, but many of the  $\gamma$ -rays, though not all, expelled by radioactive bodies, are much more penetrating than any known X-ray.

The most penetrating  $\gamma$ -rays, namely, those from mesothorium, thorium D, and from radium C, are so penetrating that more than a centimetre of lead is required to reduce the radiation to half its value. The intensity of the radiation is reduced in geometrical progression, as the thickness through which it has to pass is increased in arithmetical progression. Thus, if a centimetre and a half of lead reduce a radiation to 50 per cent. of its former intensity, three centimetres will reduce it to 25 per cent., four and a half centimetres will reduce it to 12½ per cent., and so on. It is thus possible to detect the  $\gamma$ -rays from radium after they have passed through twenty centimetres of lead. Other bodies absorb these penetrating rays directly in proportion to their density. Thus, aluminium has roughly one-fifth the density of lead. Therefore a sheet of the latter metal must be five times the thickness of one of the former in order to produce an equivalent reduction in the strength of a given radiation.

The rays of intermediate penetrating power are called  **$\beta$ -rays**. They are of the same nature as the electrons or cathode rays which are produced in a vacuum tube by a discharge.

They possess one negative charge of electricity, and are expelled with a velocity varying in magnitude from about 20-99 per cent. of the velocity of light. They are able to penetrate up to about three millimetres of aluminium, and proportionate thicknesses of other metals and bodies.

There are at present considerably over thirty bodies which expel one or more of these three types of radiations. Each of these bodies is an element with definite chemical properties, and with an absolutely definite existence.

A radioactive element differs in no way either in its chemical or physical properties from those of any common element. It possesses, however, in addition, one property which common elements do not possess, namely, that in a given interval of time a certain definite proportion of the total number of atoms of the radioactive element break up or disintegrate with the expulsion of  $\alpha$ ,  $\beta$ , or  $\gamma$  rays. It is the atom which disintegrates. The atom, after the expulsion of the radiation, is obviously different in nature to what it was before. It is a new atom, and the whole of the atoms, which are the resultant of this expulsion, form a new element. This may be made plainer by taking an actual case. The atomic weight of the element, uranium, is 238.5. In any given interval of time a definite percentage of the total number of atoms of uranium present disintegrate. The radiation expelled in this case is an  $\alpha$ -particle, which has an atomic weight of 4. The resultant atom is entirely different in nature from the uranium atom. It is to be expected that a disturbance inside the atom itself, which has resulted in the expulsion from it of a particle of this magnitude, has disarranged the structure of the atom sufficiently to give it different chemical and physical properties. The atomic weight of the new atom is also four units less than the parent atom. In this particular case the resultant atom is called uranium X. Its atomic weight is 234.5, and its chemical properties resemble very closely those of thorium. It is therefore easily separated from uranium.

Every radioactive element except uranium, thorium, and actinium is the resultant or product of some one radioactive element, and every radioactive element is the parent of some one other element.



Uranium, thorium, and actinium are called **primary radioactive bodies**. They are not the products of any element known. They form the heads of the three **disintegration series** of radioactive bodies.

A **disintegration series** is simply an arrangement of elements in which every body is the product of the one coming before it, and the parent of the one following it.

The four things which are of interest in any radioactive body are—

- (1) *What is its period of average life?*
- (2) *What type of radiation does it emit?*
- (3) *Into what body does it disintegrate?*
- (4) *What are its chemical properties?*

The first of these requires some explanation. It has been stated above that in any interval of time a definite fraction of every radioactive body disintegrates forming a new body. This fraction is different for each body.

If  $I_0$  be the number of atoms of any disintegrating body originally present,  $I_t$  the number after a time  $t$  has elapsed,  $I_0$  and  $I_t$  are connected by the equation—

$$I_t = I_0 e^{-\lambda t}$$

$$\text{i.e., } \frac{\log I_0 - \log I_t}{.434t} = \lambda$$

$\lambda$  is the **disintegration constant**. It is always determined experimentally.  $\frac{1}{\lambda}$  is called the **period of average life** of the atoms of the body.

Any body which disintegrates or decays according to the equation above does so at such a rate that at the end of a certain interval of time there is one-half of the number of atoms present which there were at the commencement of the interval. This interval is called the **half-value period**. The period of average life of any body is 1.443 times the half-value period.

In the following tables are tabulated the members of the three disintegration series, the radiations emitted by them, their periods of half-value, and their chemical properties. The chemical properties are for shortness expressed in terms of those of common elements.

#### A. THE URANIUM SERIES

Name of Element.	Symbol.	Radiation Emitted.	Half-Value Period.	Common Body Possessing Chemical Properties Most Similar.
Uranium 1	Ur1	$\alpha$	$5 \times 10^8$ years	Uranium
Uranium X <sub>1</sub>	UrX <sub>1</sub>	$\beta, \gamma$	24.6 days	Thorium
Uranium X <sub>2</sub>	UrX <sub>2</sub>	$\beta, \gamma$	1.15 mins.	Tantalum
Uranium 2	Ur2	$\alpha$	About $10^8$ years	Uranium
Ionium	Io	$\alpha$	About $2 \times 10^6$ years	Thorium
Radium	Ra	$\alpha, \beta$	2,000 years	Radium
Radium emanation	RaEm	$\alpha$	3.85 days	(Inert gas)
Radium A	RaA	$\alpha$	3.0 mins.	Tellurium
Radium B	RaB	$\beta, \gamma$	26.8 mins.	Lead
Radium C	RaC	$\alpha, \beta, \gamma$	19.5 mins.	Bismuth
Radium D	RaD	$\beta, \gamma$	16.5 years	Lead
Radium E	RaE	$\beta$	5.0 days	Bismuth
Polonium	Po	$\alpha$	136 days	Tellurium

## B. THE ACTINIUM SERIES

Name of Element.	Symbol.	Radiation Emitted.	Half-Value Period.	Common Body Possessing Chemical Properties Most Similar.
Actinium - -	Act	None	Unknown	Lanthanum
Radio actinium - -	RaAct	$\alpha, \beta, \gamma$	19.5 days	Thorium
Actinium X - -	ActX	$\alpha$	10.2 days	Radium
Actinium emanation	ActEm	$\alpha$	3.9 secs.	Radium emanation
Actinium A - -	ActA	$\alpha$	0.002 sec.	Tellurium
Actinium B - -	ActB	$\beta$	36 mins.	Lead
Actinium C - -	ActC	$\alpha$	2.1 mins.	Bismuth
Actinium D - -	ActD	$\beta, \gamma$	4.71 mins.	Thallium

## C. THE THORIUM SERIES

Name of Element.	Symbol.	Radiation Emitted.	Half-Value Period.	Common Body Possessing Chemical Properties Most Similar.
Thorium - -	Th	$\alpha$	About $1.3 \times 10^{10}$ years	Thorium
Mesothorium 1 - -	MsTh1	None.	5.5 years	Radium
Mesothorium 2 - -	MsTh2	$\beta, \gamma$	6.2 hrs.	{ Actinium and Lanthanum
Radiothorium - -	RaTh	$\alpha$	2 years	Thorium
Thorium X - -	ThX	$\alpha, \beta$	3.65 days	Radium
Thorium emanation -	ThEm	$\alpha$	54 secs.	Radium emanation
Thorium A - -	ThA	$\alpha$	.14 sec.	Tellurium
Thorium B - -	ThB	$\beta, \gamma$	10.6 hrs.	Lead
Thorium C - -	ThC	$\alpha, \beta, \gamma$	60 mins.	Bismuth
Thorium D - -	ThD	$\beta, \gamma$	3.1 mins.	Thallium

One or two alterations of a minor character would require to be made in the above tables to represent the present state of knowledge. The omissions relate to branch products. These products, however, are of no practical interest. Each body described above is the parent of the body following it in the table.

Except in the case of thorium A and actinium A, the chemical properties of all the radio-elements have been determined experimentally. A rule has also been found (Soddy, *Chem. News*, 1913, vol. 107, p. 97) by means of which, from a knowledge of the chemical properties of an element, and the radiations expelled by it and by all its products, the chemical properties of any subsequent member of its disintegration series can be predicted. These predictions in every case agree with the experimental results. It will be seen from the tables that radium B, thorium B, and actinium B are all described as being similar in chemical properties to lead.

The property of radio-elements, being very similar in chemical properties to common elements, is one of the most extraordinary phenomena in the subject, but it is a thing that greatly simplifies chemical work. Thorium B, for instance, is so similar to lead that there is no known method of separating one from the other, or of even concentrating one in a mixture of both in the least degree. To separate thorium B from other radioactive bodies, therefore, one requires only to add a trace of lead to the active solution, and separate the lead by ordinary methods. It will be found that thorium B is separated quantitatively with it, and is free from all other radioactive bodies except those which have the same chemical properties as lead, or which have grown from the thorium B between the time of separation and the time of examination. The same principle can be applied to separate other radioactive elements.

A body is said to be *in equilibrium* with its product when the ratio of the amount of the product to that of the parent body remains constant with time. In

such a case the amount of the product produced by the transformation of the parent substance in any time must equal that transformed into a third body. If a product be wholly removed from its parent substance, it grows again in the parent body according to an exponential law with the time which is independent of the period of the parent substance (unless the period be very short), and depends on the half-value period of the product grown.

Thus if radium emanation be removed from a solution of radium it decays to half value every 3.85 days, that is to say in 7.70 days there is only 25 per cent. of the original quantity of emanation left, after 11.55 days only 12½ per cent., and so on. But in 3.85 days 50 per cent. of the equilibrium quantity of radium emanation has formed again in the radium solution, 75 per cent. in 7.70 days, 87½ per cent. in 11.55 days, and so on, the rate at which the emanation forms in the solution depending only on the half-value period of radium emanation and not on that of radium itself.

### Radioactive Bodies of Technical Importance

It is clear that only bodies of reasonably long periods can be of technical importance. These are radium, mesothorium 1, radiothorium, radium D, polonium, and ionium.

It will be noticed that four bodies of long period have been omitted, viz., uranium 1 and uranium 2, thorium and actinium. The reason for the omission of the first three is that they are too inactive to be of importance, that is to say, the proportion of the number of atoms of any of these bodies breaking up per hour to the total number is so small that they are of no practical use. The reason for the omission of actinium is due to the fact that no one has yet succeeded in concentrating it from the large mass of lanthanum which associates with it in the process of separating actinium from a mineral. Were this possible, actinium would be a body of some technical importance.

The second and third of the six bodies named above belong to the thorium series, the other four to the uranium series. The sources of these six bodies are therefore the sources of the two elements, thorium and uranium.

### Sources of Thorium

The chief sources of the element thorium at the present time are the monazite sand deposits of Brazil, Travancore, and North and South Carolina (see under Thorium, p. 292). Practically the whole of the thorium used for making incandescent gas mantles is extracted from ore from these sources. As these are the best and cheapest sources known at present for this industry, they must also be the best and cheapest sources for mesothorium and for radiothorium.

The preparation of these bodies is, therefore, a by-product in the thorium industry, and anybody engaged in separating thorium on a large scale can, by performing a few more chemical operations, prepare at the same time preparations of these radioactive bodies.

There is another source of mesothorium, but it can be used only for the production of small preparations, and that is the mineral thorianite.

Thorianite is a mineral found in Ceylon, containing about 70 per cent. of  $\text{ThO}_2$  and about 10-30 per cent. of  $\text{U}_3\text{O}_8$  and oxides of other rare earths (see p. 296). Were this mineral to be sold in the market at a cheap rate it would be the best source of all these bodies, for it is much more easily worked up than monazite sand. There is, however, only a small quantity of this mineral in existence, and therefore it cannot be used to extract preparations on a commercial scale.

As the thorium industry has been dealt with in a separate section of this work (p. 291), it is not proposed to deal further with it here. This can be said, however, that as long as the supplies of monazite sand are available, and there is no sign at present that they are approaching exhaustion, so long will quantities of mesothorium and radiothorium be obtainable as by-products in the industry.

### Sources of Uranium

The natural occurrence of uranium ores has already been considered (see p. 369), and it will only be necessary to consider here a few details of special interest in connection with the radium industry.

The original source of uranium, and therefore of radium and the other radioactive bodies of the uranium series of technical importance, was the **pitchblende mines of St Joachimsthal** which are owned and worked by the Austrian Government.

Pitchblende has been the most fruitful source of radioactive materials up to the present, and most of the radium now in use has been extracted from this ore. These deposits are now alleged to be worked out.

Originally this ore was sold at such a price that after allowing for the cost of extraction of radium, the radium could be sold at less than 10s. per milligramme of radium bromide. Gradually, however, the price of the ore rose, till at the present time a milligramme of radium bromide costs about £15, though as is well known the actual cost of extracting radium on a large scale from a high grade ore, such as that obtained from the Austrian mines, *does not exceed 5s. per milligramme.*

With the gradual exhaustion of the St Joachimsthal mines, and the difficulty people had in obtaining, for any money at all, radium from the Austrian Government, a general search was made over the world for new deposits. The most fruitful source has been located in America, and it looks at present as if there and there alone is a chance of obtaining radium and other products in sufficient quantities to meet the demands of the world.

The **Cornwall mines** of England have been described as being good sources of radium, and two companies have been formed to extract this substance from them. It must be confessed, however, that the results have been disappointing up to the present.

Quantities of a mineral called **Autunite** (p. 370) were recently discovered in Portugal. **Autunite** is a phosphate of calcium and of uranium of great purity, when freed from the gangue with which it is associated. Much of the radium in equilibrium with the uranium, however, has been washed away from it by percolating water. There is no evidence that anything more than a few hundred milligrammes of radium bromide have been extracted from this source.

The most important ore in America, and, indeed, the most important and most fruitful ore of radium known at the present time, is **Carnotite** (p. 369).

It must be understood that the extraction of uranium ores on a large scale has only just commenced in the United States. Until a year or so has elapsed, it will not be possible for anyone to say definitely what quantity of radium can be extracted from these mines. At present we are confined to estimates made by experts on the spot. Officials from the Bureau of Mines have declared that there is enough ore in Colorado to produce at least 180 g. of pure radium. This is the lowest estimate of all. Others have placed the figure as high as 900 g.

### The Manufacture of Radium

Until recently the manufacture of radium has been carried on in France, Germany, and in Austria. Even the ore obtained from the Cornwall mines was mostly shipped to France to be worked up. In America and Australia radium is now being extracted. The essential methods of treatment are of course well known, and all that is required is the adaptation of these to the mineral carnotite, a mineral which is easier to work up than pitchblende.

A National Radium Institute, having a right to work certain claims in Denver, is already (1913) at work in conjunction with the official Bureau of Mines, and already 100 tons of high grade carnotite ore have been mined. A great deal of ore, however, is still being exported to the Continent, and there is at present so great a demand for it that carnotite ores, containing as little as one per cent. uranium oxide, find a market on the Continent.

**The Curie-Debiegne Process of Radium Extraction.**—In extracting radium from any uranium ore, the most important operations are the separation of the mineral proper from the gangue and impurities which are mined with it, the solution of the mineral, the separation of the radium with the barium of the mineral as sulphate, and, lastly, the fractionation of the barium-radium product to obtain

pure radium. The first of these is effected by mechanical or other means, which need not be discussed here. The reagent for effecting solution of the mineral depends on the particular composition of the mineral. In the case of carnotite, which is now the most abundant ore, the solvent is a dilute solution of hydrochloric acid. From this solution the bodies whose sulphates are difficultly soluble are precipitated. In these insoluble sulphates, the radium of the mineral is found in almost quantitative amount, as radium sulphate is even more difficultly soluble than barium sulphate. The sulphates are then converted into carbonates by vigorous boiling with sodium carbonate solution, filtering and washing free from sulphate. The carbonates are then treated with pure hydrochloric acid, which dissolves the alkaline earths and radium. From this solution the latter may be precipitated as sulphates by sulphuric acid, converted back into carbonates, and the carbonates dissolved again in pure hydrochloric acid. In this way barium and radium are separated from the other impurities, namely, iron, lead, and calcium, which are usually associated with it.

According to R. Sternlicht (*Chem. Zeit.*, 1914, 38, 49), pitchblende (average uranium content, 45 per cent.) is worked by this process at the Austrian State radium factory as follows:—The uranium ore is roasted, the uranium removed, and the residual sulphates of Ca, Ba, Er, and Ra which remain are converted into carbonates by boiling with concentrated  $\text{Na}_2\text{CO}_3$  solution. The carbonates are then converted into chlorides, and the radium separated by fractional crystallisation of the chlorides. The process, however, is very laborious, and yields only 80 per cent. of the original radium content.

The French factory of Armet de Lisle, however, extracts the radium directly from their uranium ore by treating with HCl. They work with materials containing only a very low percentage of radium, principally "uranium mica," "uranium ochre," carnotite, and autunite. They attain a yield of 70 per cent. radium, but the process is difficult and costly.

**The Ulzer-Somner Method of Radium Extraction** (see English Patent, 19,820, 30th August 1909).—The material containing radium is first treated with concentrated  $\text{H}_2\text{SO}_4$  for some weeks at the normal temperatures, or a few hours at a boiling temperature, or it is fused with acid sulphates; and the residue remaining after repeated washing is boiled, under pressure, with concentrated solutions of caustic alkalis or alkali carbonates, or is melted therewith; the melt is treated with water, and, after further repeated washing, the residue is boiled with dilute sulphuric acid. The same effect is attainable by treating first with alkaline agents and then with acid agents. The residue which remains (about 0.5 per cent. of ore) contains all the radium as  $\text{RaSO}_4$ .

The following example is quoted:—100 kilos of finely ground pitchblende residue are heated with about 400 kilos of crude concentrated  $\text{H}_2\text{SO}_4$  for several hours, until the acid begins to fume. When the dark brown colour of the mixture has changed to light brown or grey, the mass is poured into 10-20 times its volume of  $\text{H}_2\text{O}$ , boiled, settled, and solution decanted. The residue is washed twice with water, collected on a filter, and dried. The residual mass (45-50 kilos) is now heated with 130-150 kilos of commercial NaOH in iron crucibles for one to two hours until thoroughly melted. The mass is boiled several times with  $\text{H}_2\text{O}$  (1,000 litres each time), decanted, and filtered.

The moist residue is boiled with 5 kilos of dilute (20 per cent.)  $\text{H}_2\text{SO}_4$ , filtered, and washed; 0.5 g. of crude sulphates remain.

The radium factory in Neulenbach use this process with good success, recovering 97-98 per cent. of radium.

W. F. Bleecker and the Standard Chemical Co., of Pittsburg, U.S.A., suggest treating the Carnotite ore as follows (see U.S.A. Patents, 1,068,730, 1913, and 1,065,581, 1913):—The finely powdered carnotite ore is successively treated with (1) a solution of NaOH and  $\text{Na}_2\text{CO}_3$  to form partly soluble vanadates and insoluble sodium uranate. (2) The residue, after washing, is extracted with dilute HCl to produce radium, vanadyl, and uranyl chlorides. (3) Next  $\text{Na}_2\text{CO}_3$  is added, whereby  $\text{RaCO}_3$  is precipitated, sodium vanadate (partly soluble) and sodium uranyl carbonate (soluble) being simultaneously produced. (4) To the residue, after washing, HCl is added to produce  $\text{RaCl}_2$  (soluble) and vanadyl chlorides. (5) Lastly,  $\text{H}_2\text{SO}_4$  is added, the Ra being precipitated as  $\text{RaSO}_4$ , and the Va going into solution as soluble vanadyl sulphate. See under Vanadium, Section LXXXIV.

F. Soddy, in his "Chemistry of the Radioelements," p. 45, recommends that the tedious and lengthy wet methods for extracting the barium-radium product from the mineral at present in use could with advantage be replaced in many cases

by simple reduction of the insoluble sulphates to sulphides in a current of coal-gas, or other reducing atmosphere, followed by solution of the product in acid.

E. Ebler and W. Bender (*Zeits. anorg. Chem.*, 1913, 83, 149-158) suggest reducing the dry powdered crude "sulphates" of radium, barium, etc., to sulphides by mixing with calcium hydride, pressing into a crucible, and kindling as in the aluminothermic method, when the following change takes place:— $\text{RaSO}_4 + 4\text{CaH}_2 = \text{RaS} + 4\text{CaO} + 4\text{H}_2$ . The reaction product is cooled, powdered, rapidly dissolved in hot dilute HCl, and the  $\text{H}_2\text{S}$  expelled by boiling. The Pb present remains undissolved as PbS, also  $\text{SiO}_2$  is insoluble. The whole of the radium is then separated as pure radium-barium chloride, by evaporating, if necessary, and treating with HCl gas until about 75 per cent. of the Ba is deposited. A total recovery of 75-80 per cent. of the Ra is claimed.

R. Sternlicht (*Chem. Zeit.*, 1914, 38, 49), however, criticises adversely the method, on account of the technical difficulties evolved, the cost of the  $\text{CaH}_2$ , the rapid re-oxidation of the precipitated sulphides to sulphate, and the fact that it can only be applied to ores rich in radium and poor in barium.

**Separation of Radium and Barium.**—The last stage in the operations consists of the separation of the radium from the barium by fractional crystallisation of either the bromide or the chloride. Formerly this crystallisation was effected with the chloride, later the bromide was used instead, as the operations were much more rapid; but owing to the fact that the chloride is a much more stable compound than the bromide, and parts with its halogen much less readily on keeping, fractionation is now conducted on the chloride. To carry out this operation we proceed in the usual way, the operation depending on the fact that radium chloride is less soluble in hydrochloric acid than is barium chloride.

Kunheim & Co. (German Patent, 264,901, 1912) propose to effect the separation of Ba and Ra by using such salts as picrates, bromates, and ferrocyanides. As solvents, alcohol and acetic acid may be used instead of water.

E. Ebler and W. Bender (*Zeits. anorg. Chem.*, 1913, 84, 77-91) suggest the use of hydrated manganese dioxide as an absorbent for radium-barium salts. The process, however, according to R. Sternlicht (*Chem. Zeit.*, 1914, 38, 49), has not come into general use.

Most of the radium on the market is in the form either of chloride or of bromide. It is usually sealed up in tubes of thin glass, the reason for doing so being not only for safety, but also to prevent escape of the emanation, and with it its products, which together contribute themselves more than three times the activity of radium itself measured by  $\alpha$ -rays, and the whole of the activity measured by  $\beta$ - and  $\gamma$ -rays (see Table A above). It is essential that the salt, whether it be pure or whether it be mixed with barium salts, be quite dry before it is sealed up. If it is not, the increase in pressure inside the tube due to the formation of hydrogen and oxygen by the action of the radiations on the water may cause the tube to burst, and the material to be scattered about and lost.

Of the chemistry of radium compounds little need be said, except that they resemble very much the corresponding compounds of barium.

Radium sulphate is more insoluble than barium sulphate, radium chloride more insoluble in hydrochloric acid than barium chloride, radium bromide more insoluble in hydrobromic acid than barium bromide. Radium carbonate is easily soluble in hydrochloric acid. Radium metal has been prepared, but it is very rapidly oxidised, and is of strictly scientific interest only.

### The Separation of Ionium, Radiolead, and Polonium

Of these three bodies the most useful for medical purposes is polonium. Polonium is useful because it expels an  $\alpha$ -ray of moderately great penetrating power, and can be easily obtained pure and in a highly concentrated condition.

Preparations of ionium have also been placed on the market by a Hamburg firm, and it is very probable that for some technical purposes preparations of this body will be used in the future.

**Ionium** is the parent substance of radium. It is therefore found in all minerals which contain uranium and radium. Its chemistry may be stated accurately in a sentence. It is so similar in all properties to the element thoria that it is impossible for it to be separated from that body when once the two have

been mixed. In working up any mineral on a large scale, the ionium is quantitatively separated with the rare earth constituents, and in the fractionation of these bodies by the usual methods it associates itself quantitatively with thorium. The whole of the ionium constituent of any uranium mineral can therefore be obtained by fractionating the rare earth constituents of it, and separating out and purifying the thorium by the well-known methods. There is not the slightest risk that any of the ionium will associate itself with any body other than thorium.

Preparations of ionium have been obtained weighing several grammes, and equalling in  $\alpha$ -ray activity 30 milligrammes of radium chloride.

Most of these preparations, however, consist of thorium with a few per cent. of ionium only. Owing to a relatively great amount of an almost inactive body being associated with a small quantity of a very active body, much of the usefulness of the ionium is lost. Pure ionium can be obtained by working up a uranium mineral which contains no trace of thorium at all, but such minerals have not yet been located, though in many the amount of thorium present cannot be detected in the gramme or two of it used for making a quantitative analysis.

**Radiolead** is a name given to radium D, containing radium E and polonium in equilibrium with it, in other words, to an old preparation of radium D. The reason for its being called radiolead is that it was always found with the lead impurity of a uranium mineral. Radiolead is of technical importance only because it grows polonium. Neither radium D nor its product, radium E, expel any radiation except feebly penetrating  $\beta$ - and  $\gamma$ -rays, nor is it possible to obtain radium D free from the relatively large mass of lead which is separated with it from the mineral.

Radium D is so similar to lead in all its chemical and its physical properties that it is not possible for it to be separated from it, or even concentrated in a mixture of both substances. All uranium minerals, with one or two minor exceptions, contain lead as an impurity; the few which have no lead have none because the lead which it originally contained has been removed from it by percolating water or other natural agencies, which often remove at the same time a good proportion of the radium content, and of the radium D content. For this reason it is impossible to obtain pure radium D from a radium mineral. If a preparation of nearly pure radium D be wanted for any purpose it may be obtained as follows:—To an old solution of radium salt add a few milligrammes of lead in the form of nitrate free from sulphate, heat the solution to boiling, and add to it excess of a solution of  $H_2S$  in water. The whole of the radium D, radium E, and polonium which have formed in the radium solution are precipitated quantitatively with the lead as sulphide. This precipitate may be then filtered off and used as a source of radiation on the filter paper.

The only lead or other impurity associated now with the radiolead is the few milligrammes of lead that were added to the radium solution. If this operation be performed once only, a small quantity of the radium will be found present with the radiolead. This can be removed by dissolving the lead in acid, repeating the precipitation with  $H_2S$ , and filtering, the radium impurity remaining in the filtrate.

**The methods for the separation of polonium** from a mineral depend on the fact that polonium is the missing top member of the sulphur, selenium, and tellurium series (group VI. B of the Periodic Classification). The method for its separation from a preparation of radiolead depends on the great ease with which it is deposited on plates of metal when these are dipped into a solution containing it.

After tellurium, the body which polonium resembles most is bismuth. In any technical process of working up a uranium mineral it is necessary, therefore, to examine the **bismuth constituent** of the mineral when it is separated out, and from this to concentrate the polonium. Thus, from one ton of Joachimsthal pitchblende, about 3 kg. of bismuth oxychloride are obtained. This contains the greater part of the polonium content of the mineral. From it Mme. Curie separated the polonium from the bismuth by fractional precipitation of the basic

nitrate with water, by fractional precipitation from solutions made very acid with hydrochloric acid, and by sublimation *in vacuo*. Later, Marckwald separated it from bismuth and other impurities by immersing a plate of silver or of copper in a hydrochloric acid solution of all, the polonium being deposited on the plate in almost quantitative amount. He found also, by adding a small quantity of stannous chloride to the solution of polonium and impurities in hydrochloric acid, that the tellurium impurity, and with it the polonium, were precipitated. From this mixture most of the tellurium could be removed from the polonium by dissolving both in not too acid a solution, adding hydrazin hydrate (which precipitates the tellurium, but not the polonium), and precipitating the polonium from the solution by stannous chloride. This is at present the best method known for separating polonium from a mineral.

When polonium has to be separated from a preparation of radiolead, the procedure is much simpler. If the radiolead preparation contains much lead, all but a few milligrammes must be removed by fractional crystallisation of the nitrate from a solution of nitric acid. To carry this out the preparation of radiolead containing the lead is dissolved in nitric acid, and evaporated, till on cooling some of the lead crystallises out. Most of the polonium remains in the solution with the rest of the lead. This operation is then repeated several times, till only a small quantity of lead (a few milligrammes) remains. The solution can then be evaporated to dryness, and redissolved in the smallest quantity of hot water necessary to effect solution. In this solution is rotated a clean copper plate, varnished on one side with Brunswick black or other similar material to prevent deposition on it of the polonium. After about ten minutes the plate can be removed. The greater part of the polonium in the solution will be deposited on the plate. In many cases the proportion is as high as 95 per cent. If the amount of lead associated with the radiolead be small, the preliminary operation of removing the lead by fractional crystallisation may be omitted.

Preparations of polonium may be used for all purposes in which a very strong source of  $\alpha$ -rays in a concentrated form is required. Polonium possesses the advantage over ionium, that the former can be prepared in a more highly purified form than can the latter. Ionium, however, owing to its long half-value period, may be looked upon as being permanent in its activity. A preparation of polonium, on the other hand, decays, falling every 136 days to half value, only about one-seventh of the total amount at the beginning of a year existing at the end of it.

Other methods for purifying radium E and polonium are described by A. S. Russell and J. Chadwick (*Phil. Mag.*, 1914, 27, 112).

### The Separation of Mesothorium and Radiothorium from Thorium Minerals

The radioactive body, **mesothorium**, has come greatly to the fore within the last two or three years as a serious competitor with radium in the radium markets. Owing to the very large quantity of thorium used in the gas-mantle industry, in which, as has been stated above, mesothorium is a by-product, it will probably be very largely manufactured in the future. Owing to the fact, however, that thorium forms only a very small percentage of the constituents of monazite sand, and that its product, mesothorium, associates itself with the insoluble sulphate residues of the mineral, the extraction of mesothorium from monazite is a somewhat costly process. Another disadvantage which attaches to it is that it is not permanent, but decays, its half-value period being 5.5 years.

Mesothorium is identical in chemical properties with radium. Pure mesothorium behaves exactly as though it were radium. If mesothorium and radium are mixed together they cannot afterwards be separated.

To separate mesothorium, therefore, from any mineral, it is necessary only to add a little barium chloride to a solution of the mineral, to precipitate the



barium as sulphate from this solution, and to fractionate the insoluble sulphate precipitate by exactly the same methods as are used for fractionating radium.

If the mineral shows from its analysis that it contains barium, it is, of course, not necessary to add any barium salt to its solution.

All the methods employed at present in preparing mesothorium on a large scale are based on this general method.

For instance, in the first stage of the chemical treatment of monazite sand for the extraction of thorium the mineral is heated with about twice its own weight of sulphuric acid. The resultant mass, when cold, is treated with water and the whole left to settle. The thorium itself goes mainly into solution. Now if a little quantity of barium is added either before or during the treatment of the ore with sulphuric acid, the mesothorium will be separated from the soluble thorium after the treatment with water, associating itself with the difficultly soluble sulphates. Barium and mesothorium can then be separated from the other sulphates by the ordinary methods used for purifying barium under such conditions. The mesothorium is finally separated from barium by fractional crystallisation of the chloride. The preparations of mesothorium on the market are usually in the form of chloride sealed up in glass tubes. The impure preparations contain in addition both barium and radium. The purest contain radium only as impurity. The reason for the presence of the radium is, of course, that mesothorium and radium have the same chemical properties, and therefore all the radium of the mineral gets concentrated with the mesothorium. If the thorium mineral contained no uranium whatever there would be no radium content, but most thorium minerals (including monazite sand) contain a small percentage of uranium, and therefore some radium, and this is separated with the mesothorium. In most preparations of mesothorium now being sold about 80 per cent. of the activity of the whole preparation is due to the mesothorium, and as much as 20 per cent. to the radium with it. Weight for weight, however, the preparation contains about 99 per cent. radium chloride and 1 per cent. mesothorium chloride, the radium, having much the longer period of average life, being present in much greater mass than the mesothorium. The radiations from an old preparation of mesothorium are essentially the same in nature as those from radium. All three types of radiations are expelled by it. Mesothorium itself is rayless, but its first product, mesothorium 2, expels a powerful  $\beta$ - and  $\gamma$ -radiation. This body is very short-lived, forming radiothorium which, with its products, gives a powerful  $\alpha$ -radiation. This radiation can be made use of only when the preparation is removed from the tube, since the glass walls of the tube absorb most of the  $\beta$ -rays and all of the  $\alpha$ -rays emitted by the products.

Owing to the formation of the radiothorium, a body having a half-value period of about two years, and the fact that mesothorium itself has a half-value period of 5.5 years, the  $\alpha$ -ray activity of a preparation of mesothorium steadily increases for about 4-6 years. During this time the  $\beta$ - and  $\gamma$ -activity is augmented owing to the formation of thorium C and thorium D. After that time all three types of radiation decay in intensity, exponentially to zero, with a period of 5.5 years.

**Radiothorium**, the other important radioactive constituent of thorium minerals, cannot be separated directly from the mineral. The reason for this is that radiothorium and thorium have identical chemical properties. Nobody who has attempted the separation of these two bodies has been able, up to the present, to effect a separation or to detect the slightest difference in any of their chemical properties. The radiothorium of a mineral is, therefore, separated quantitatively with the thorium. The only method of preparing radiothorium is to prepare it from a quantity of mesothorium. A preparation of pure mesothorium, after being left for a year to grow radiothorium, is dissolved in a little hydrochloric acid. A solution of a small quantity of aluminium nitrate, or of any inorganic body which is precipitated by ammonia, is added to the solution, and the whole saturated with ammonia gas. The aluminium is precipitated as hydrate, and with it is precipitated

the whole of the radiothorium. The mesothorium, and any radium present, remain in solution. The amount of aluminium necessary to be added is simply enough to be conveniently filtered, *i.e.*, about a milligramme or two. Many of the preparations of commerce contain thorium, this body having been used instead of aluminium in the precipitation of radiothorium by ammonia.

Radiothorium has two uses in medical work: it is not only the producer of a constant supply of thorium emanation, but also the producer of the highly active deposit of thorium.

In order to get a plentiful supply of emanation from a preparation of radiothorium, the substance should be placed, in a slightly moist state, in a tube with narrow ends. By means of suitable apparatus a current of air may be passed over the preparation, removing much of its emanation, which may be inhaled or put to other use.

For many purposes in medical treatment with radioactive preparations a temporary activity only is required. For instance, it may be necessary for the patient to swallow some radioactive material. It would be manifestly unwise to put a valuable preparation to this use. This difficulty may be overcome by separating, by chemical means, thorium X from the radiothorium preparation. The whole of the thorium X may be easily removed by dissolving the radiothorium in acid and passing in ammonia gas. This precipitates the radiothorium and its nucleus quantitatively, leaving in solution the thorium X, which is chemically identical with radium and mesothorium. The ammonium salts may be removed by evaporation of the solution and ignition, and the thorium X may then be redissolved and used. The activity of the radiothorium is thus not destroyed, for in a month's time it has grown its equilibrium amount of thorium X again, and this quantity can be separated as before if it be necessary.

It may be pointed out that thorium X cannot be obtained in this way from mesothorium, owing to the identical properties of the two.

Radiothorium loses its activity much more quickly than mesothorium, falling to half value every two years. Thus after ten years only about 3 per cent. of the original quantity of material is left.

### Methods of Testing the Strength of Radioactive Bodies

The strength of any radioactive body is measured by the intensity either of its  $\alpha$ - or of its  $\gamma$ -rays, and all activities are referred to the  $\alpha$ -ray activity of 1 g. of radium in the form of metal, or to the  $\gamma$ -ray activity of the quantity of radium C in equilibrium with 1 g. of radium metal. The amount of radium emanation in equilibrium with 1 g. of pure radium metal is called a curie. Thus 5.8 millicuries of emanation is the amount of emanation in equilibrium with 5.8 mg. of radium metal, *i.e.*, with 7.6 mg. of radium chloride, or with 9.9 mg. of anhydrous radium bromide.

A curie expels per second the same number of  $\alpha$ -particles as 1 g. of radium metal. Since, however, radium A and C, both of which expel  $\alpha$ -particles, soon form in the emanation, a curie of emanation in equilibrium with its short-lived products expels per second three times as many  $\alpha$ -particles as does a gramme of radium freed from its products. The intensity of every product in the uranium-radium series should be expressed in terms of grammes or milligrammes of metallic radium. There can then be no doubt what is meant by the unit used. Formerly, activities were often expressed in terms of what were known as Mache units, and sometimes in terms of the  $\alpha$ -ray activity of uranium. Such units are not only unscientific, but also unbusinesslike, for they are not definite units which are accepted everywhere.

It is customary at the present time, for instance, to talk about 5 mg. of polonium. This does not mean 5 mg. of polonium by weight, but that quantity of polonium which is in equilibrium with 5 mg. of radium metal or 5 millicuries of emanation. Similarly 300 mg. of radium C means the quantity of radium C in equilibrium with 300 mg. radium metal or 300 millicuries of radium emanation.

Again, 4 mg. of ionium means the amount of ionium with which, in a mineral, 4 mg. of radium are in equilibrium. The amount by weight of any product of the uranium-radium series can always be obtained by multiplying its activity expressed in terms of milligrammes of radium metal by its period, and dividing by the period of radium, and *vice versa*.

Preparations of mesothorium and of radiothorium are standardised and sold in terms of the  $\gamma$ -ray activity of 1 mg. of radium C, *i.e.*, the  $\gamma$ -ray activity of the radium C in equilibrium with 1 mg. of radium metal. As the penetrating power of the  $\gamma$ -rays from the thorium preparations and from radium are not quite the same, it is usual to measure the intensity through 3 mm. of lead. Thus a preparation of radiothorium when in equilibrium with its product, thorium X, gives 50 divisions per minute in a  $\gamma$ -ray electroscope through a thickness of 3 mm. lead; when 1 mg. of radium chloride containing the emanation in equilibrium amount gives 12, then the strength of the radiothorium preparation is  $\frac{50 \times 226}{12 \times 297}$  mg. of radium at the date on which the measurements were made. Mesothorium preparations have their activities expressed in the same way.

This standardisation is now carried out for a small fee by experts at the **National Physical Laboratory, Teddington, in England**. Everybody buying radium, mesothorium, or radiothorium should insist on having the official certificates of its strength and purity furnished by this institution.

The strengths of preparations of ionium and of polonium, if very strong, may be measured by measuring the current a film of the material produces in the air of an ionisation box and comparing it with the current produced in the same ionisation box by a known quantity of a radium salt, the measurements of the current being determined by an electrometer. If the preparations are too weak to allow of this being done, the number of  $\alpha$ -particles expelled by a known area of the film may be compared with that expelled by a small quantity of radium, the measurements being made by the scintillation method.

The radium emanation content of a mineral, of any solid preparation, or of any solution containing it, is measured in a special emanation electroscop. The procedure consists essentially of getting the radium-containing solid completely into solution, expelling the radium emanation completely from it, allowing the emanation to accumulate in it for a definite time, say forty hours, transferring this quantity of emanation completely from the solution into an air-tight ionisation chamber, and measuring the activity of the emanation and its products three hours after it has been in this chamber by means of an electroscop. The electroscop is standardised by introducing a known quantity of emanation either from a small but known quantity of a radium salt, or from a uranium mineral, the ratio of the quantity of radium to that of uranium of which is known, allowing this emanation to remain in the chamber for three hours, and then measuring its activity. In this way the emanation content of any body can be expressed in terms of the amount of emanation in equilibrium with 1 mg. of radium element.

### Uses of Radioactive Substances in Medicine and in General

The chief use of radium and other radioactive bodies, apart from their use for strictly scientific investigation, is undoubtedly in medicine. A short account of their use in this department of science will therefore be given. Many medical men are much more optimistic in their opinion of the therapeutic value of these preparations than others, but there are certain facts of which there can be but little doubt.

Radium, especially when used in considerable quantity, has undoubtedly effected cures of surface cancers, warts, lupus, and ulcers. The reason for much of the former non-success in curing these diseases was the lack of a sufficient quantity of the active material. We are informed further that the emanation of radium when drunk or inhaled causes increased diuresis, and increased excretion of uric acid, and relieves patients suffering from gout, rheumatism, and diabetes.

It must be pointed out, however, that there are less expensive methods of curing these diseases than the employment of radioactive substances. The object that medical men have in view in experimenting with radium is to cure **cancer**. To further this object a radium institute has been founded in London, and similar institutes are being formed in the provinces, at which medical men may obtain radioactive preparations with which to experiment.

The results obtained by treating cancer with radium have been astonishingly successful. In all cases the condition of the patient is relieved. In the worst cases radioactive preparations, when applied to the diseased part, have acted as local anæsthetics in removing the pain. In several cases every sign of the cancer has been completely removed. Experiments have been in progress for a short time only, and therefore a considerable time must be allowed to elapse before even the most successfully treated case is described as a cure. Already (September 1914) there are three hospitals in the kingdom in which non-medical men, trained in radioactive chemistry, are working in conjunction with medical men on this great problem.

It is the possibility that radium will be a permanent cure for cancer that has stimulated the search for radium minerals over the earth, and has caused neither money nor pains to be spared to bring to the doctor's hand as much of the valuable material as possible. Until quantities of the order of 10 g. can be used in medicine the possibilities of radium as a curer of cancer and malignant diseases of a like nature cannot be known. It is as reasonable to expect some of the small quantities of radium to cure the disease to which they have been applied as that 10 cubic centimetres of cold water should quench the thirst of a thirsty man.

For internal use the preparations used are generally either radium emanation or thorium B, C, and D. In both these the physiological effects produced are due to the  $\alpha$ -rays from these bodies.

The radium emanation may either be inhaled directly from an atmosphere laden with emanation, or taken in the form of gas dissolved in mineral water.

There is at present on the market a small chamber in which a patient may sit, the air of which is kept permanently supplied with emanation diffusing from a strong source of radium placed on the floor. The radioactive water is made either by dissolving a known quantity of radium carbonate or chloride completely, and diluting down by the ordinary methods till each litre of solution contains about  $10^{-6}$  g. of radium (or stronger if necessary), and with it, of course, after it has been bottled up for a month, the emanation in equilibrium amount or "Radium water" can be made to contain emanation only by simply pumping off the emanation from a known quantity of radium and dissolving it in a large quantity of water by shaking. In the latter case much larger doses may be taken for the same cost.

If a patient is required to take internally only the active deposit of radium, *i.e.*, radium B and C, it may be collected on a pill, or on anything that is easily swallowed, by exposing the pill for some hours to a large quantity of the emanation; the emanation is then removed and may be used again for the same purpose.

This is not so easily accomplished with the emanation of thorium, and, therefore, it is best to separate the active deposit of thorium, *i.e.*, thorium B, C, and D, chemically from radiothorium as described above. It is then taken in the liquid form dissolved in some solvent.

For external purposes, the substance used depends upon the particular disease which is being attacked. If a strong source of  $\alpha$ -rays is required, preparations of ionium, or of polonium, in thin films on plates of metal, make excellent sources. If  $\alpha$ -rays are required with  $\gamma$ -rays, the source which must be used is a thin tube of glass, or of quartz, containing radium emanation, the tube being so thin that the  $\alpha$ -rays are able to escape from it ( $\alpha$ -ray tubes).

Whenever  $\alpha$ -rays are used, the preparation must be placed so near the part that is being treated that the rays are able to exert their full effect. Sometimes radium, or radiothorium, is immersed in the pores of a blanket or other similar material, so that the emanation diffuses out of the dry fabric without any of the parent substance being lost.

If  $\gamma$ -rays only are required, sealed tubes of radium salts, of radium emanation, of mesothorium, or of radiothorium can be used. Of these sources radiothorium is the least concentrated, and radium emanation the most concentrated. The latter, however, decays almost to zero in a month. A source of mesothorium, if free from barium, is much more concentrated than a source of pure radium. Radium, radium emanation, and mesothorium are the sources of  $\gamma$ -rays used in work on cancer.

It must be emphasised that all radium, or radioactive preparations containing quantities as small as  $10^{-9}$  of a gramme of radium, can be of little therapeutic value. Ointments, pills, radioactive blankets, etc., containing quantities of material of this order, are of no more value than the same preparations lacking the radioactive constituent.

Preparations of radium, mixed with zinc sulphide, emit a greenish-yellow light, due to the bombardment of the zinc sulphide crystals by the  $\alpha$ -particles from the radium and its products.

This mixture has been used for giving a permanent illumination to keyholes, to the hands of a watch or clock, etc., so that these articles may be seen easily in the dark.

### The Prices of Materials

The pre-war (1913) price of radium was about £24 per milligramme of radium element. All radium preparations are priced on this basis, though actually no radium is sold in the metallic form. Reckoned on this basis a milligramme of radium chloride should cost about £18. 10s., and a milligramme of anhydrous bromide, £14. There was formerly little diminution of charge because a radium preparation is impure. Thus 325 mg. of radium-barium chloride containing 24 per cent. of radium chloride costs  $\frac{14}{100} \times 325 \times 18\frac{1}{2}$ , *i.e.*, simply the price of the pure radium chloride it contains. When the preparation contained a few per cent. only of radium a larger diminution was made in the price. At the present time the difference in price between equal quantities of pure and

impure radium is considerable. The price of radium bromide in 1902 was 5s. a milligramme, this rose next year to 6s., and later to 20s., which was the price in 1904. Since that time the price has steadily risen to what it is to-day. The question whether the price of radium will advance further is not only an interesting one, it is a very practical one.

Rutherford, whose knowledge of radioactivity is unrivalled, says in his book, published in 1913, that "the present price of radium is very high, and bears no relation to the cost of separation of the radium from uranium minerals. The present price is artificial. There seems to be no reason why the present abnormally high prices of radium should be ultimately maintained."

On the other hand, C. A. Parsons, whose knowledge of the resources of the United States is very great, declares that at the present time "it is impossible to predict whether the price will go up or down, or remain stationary." The great increase in production of radium that is bound to happen in the next years in the United States would tend, other things being equal, to lower the price. Again, the competition of mesothorium, which is being put on the market in increasing quantities every year, should also tend to lower the price. Mesothorium, however, for reasons difficult to understand, is less popular with medical men than radium. But the uses and demands for radium are apparently developing at an even greater rate than the supply. Also, as has been pointed out above, the present supply of the mineral is limited.

The one thing that would lower the price seems to the writer to be the adaptation of X-rays (resembling  $\gamma$ -rays), cathode rays (resembling  $\beta$ -rays), and canal rays (resembling  $\alpha$ -rays) to effect exactly the same physiological effects and the same curative powers which are produced by radioactive materials. This at present seems unlikely, but it is a question for the future.

The only radium mineral selling in large quantities at present is the 2 per cent.  $U_3O_8$  carnotite ore from Colorado. This sells at Hamburg for about £19 per ton (1913). The equilibrium amount of radium element in this material is at least 4 mg. per ton, which, when extracted, can be sold for about £100. Since the price of the raw material from which this quantity of radium is extracted is about £19, there is a margin of £80 for the cost of extraction, the profit of the extractor and of the agents through whose hands the material must pass before it reaches the buyer. The present prices of the other radium ores are not of much importance, owing to the present drift of the radium-extracting industry from Austria and France to the United States.

The pre-war (1913) price of mesothorium is about £5 per milligramme, where, by milligramme, is not meant milligramme of mesothorium, but the quantity of mesothorium the  $\gamma$ -ray activity of which through 3 mm. of lead is equal to that from 1 mg. of radium chloride through the same thickness.

The price of preparations of radiothorium vary according to the purity of the material, but it is of the order of £2 or £3 per milligramme equivalent in  $\gamma$ -rays of radium chloride.

The price of the monazite sand has not been influenced by the fact that these radioactive bodies are extracted from it.

**Output of Radium Compounds.**—It is difficult to estimate the quantity of radium compounds produced annually, but the following details may be of service in this connection. According to S. Fischer (*Min. Ind.*, 1913, 22, 657) the Austrian production of radium salts, during 1912, amounted to about 5 g. as compared with 2.65 g. produced in 1911. The total European production, in 1913, was about 4 g., whilst the Australian ores yielded 2 g. It has been estimated that the quantity of uranium ores exported from the United States, in 1913, was sufficient to produce 8.97 g. of radium chloride.

## SECTION LXXXVI

# ELECTRIC FURNACE PRODUCTS INDUSTRY

BY H. D. K. DREW, B.Sc. (Lond.)

### LITERATURE

#### General.—

- P. ASKENASY.—“Einführung in die Technische Electrochemie.” Erster Band: “Elektrothermie.” Braunschweig, 1910.  
 A. STANSFIELD.—“The Electric Furnace—Its Evolution, Theory and Practice.” Toronto (second edition in press).  
 A. J. ALLMAND.—“The Principles of Applied Electro-Chemistry.” London, 1912.  
 M. DE KAY THOMPSON.—“Applied Electro-Chemistry.” New York, 1911.  
 J. WRIGHT.—“Electric Furnaces and their Industrial Applications.” London, 1910.  
 A. MINET.—“Les Fours électriques et leurs Applications.” Paris, 1907.

#### Carborundum, Siloxicon, etc.—

- Journ. Soc. Chem. Ind.*, 14, 755 [1895]; 16, 863 [1897]; 24, 654 [1905].  
*Electro-Chem. and Met. Ind.*, 1, 50 and 514 [1902-03]; 2, 439 [1904]; 3, 253 [1905]; 4, 53 and 348 [1906]; 5, 70 [1907]; 7, 24 and 189 [1909].  
*Met. and Chem. Eng.*, 9, 377 and 613 [1911]; 10, 287 and 519 [1912].  
*Trans. Amer. Electro-Chem. Soc.*, 2, 55 [1902]; 12, 215 [1907]; 16, 207 [1909]; 21, 425 [1912]; 22, 73 [1912].  
*Journ. Amer. Chem. Soc.*, 28, 853 [1906].  
*Trans. Chem. Soc.*, 93, 2104 [1908].  
*Journ. Phys. Chem.*, 15, 213 [1911].  
*Journ. Franklin Inst.*, 136, 194 [1893]; 143, 81 [1897].

#### Manufactured Graphite.—

- Electro-Chem. and Met. Ind.*, 1, 52 [1902]; 3, 253 and 416 [1905]; 5, 452 [1907]; 7, 187 and 358 [1909].  
*Met. and Chem. Eng.*, 9, 536 [1911]; 11, 242 [1913].  
*Trans. Amer. Electro-Chem. Soc.*, 1, 53 [1902]; 2, 43 [1902]; 12, 29 [1907]; 20, 105 [1911].

#### Alundum.—

- Electro-Chem. and Met. Ind.*, 1, 15 [1902].  
*Met. and Chem. Eng.*, 9, 257 [1911].  
*Trans. Amer. Electro-Chem. Soc.*, 19, 333 [1911].

#### Silicon and Ferro-Silicon.—

- Journ. Soc. Chem. Ind.*, 24, 654 [1905]; 33, 774 [1914].  
*Electro-Chem. and Met. Ind.*, 3, 254 [1905]; 5, 9 [1907]; 6, 397 [1908]; 7, 192 [1909].  
*Met. and Chem. Eng.*, 8, 133 [1910]; 11, 102 [1913].  
*Trans. Amer. Electro-Chem. Soc.*, 7, 243 and 251 [1905]; 15, 395 [1909].  
*Rev. de Métallurgie* (W. Pick and W. Conrad), 9, 362.  
*Local Govt. Board Report on Ferro-Silicon, etc.*, 1909 [Cd. 4,958]. Revised Orders, July 1912.

#### Calcium Carbide and Cyanamide.—

- Electro-Chem. and Met. Ind.*, 1, 22 [1902]; 6, 397 [1908]; 7, 212, 309, and 360 [1909].  
*Met. and Chem. Eng.*, 8, 279, 589, 617, and 682 [1910]; 11, 438 [1913].  
*Trans. Amer. Electro-Chem. Soc.*, 15, 411 [1909]; 16, 197 [1909].  
*Ann. Chim. Phys.*, 125, 120.  
*Annuaire Internat. de Pacetylene*, 1912.  
*Engineering*, 87 [1909].

## CARBORUNDUM

**Carborundum**, or crystalline silicon carbide,  $\text{SiC}$ , was discovered accidentally, in 1891, by E. G. Acheson, whilst trying the impregnating of clay with carbon at a high temperature produced electrically.

The first carborundum furnace was that of the Carborundum Company at Monongahela in 1893; it consumed about 75 H.P., and produced 45 tons of carborundum a year. In 1895, with the formation of the Niagara Falls Power Company, much larger furnaces were constructed by the Carborundum Company at Niagara Falls; and at the present day there are twenty-one furnaces of about 2,000 H.P. in continuous operation and estimated to produce in 1913 about 7,000 tons of carborundum.

**Manufacture.**—Carborundum is manufactured on the large scale by heating

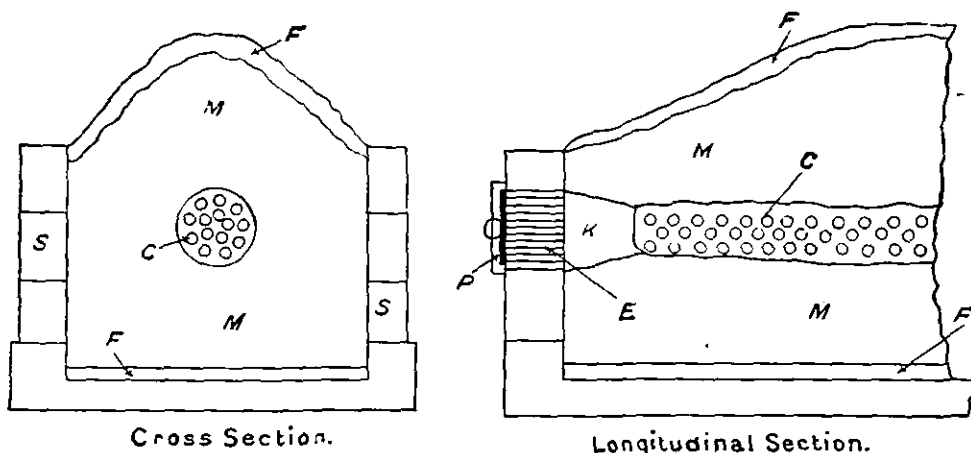
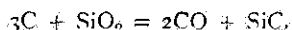

FIG. 1.—Carborundum Furnace.

together in the electric furnace a mixture of silica,  $\text{SiO}_2$ , and carbon. The silica is usually in the form of quartz, and the carbon in the form of coke.

The formation may be expressed by the equation:—



The furnace used for the production of carborundum is of the resistance type, the size varying in different localities. Furnaces taking from 2,000-3,000 H.P. have been constructed. A carborundum furnace unit consists of five furnaces, only one at a time being in operation, while the rest are loading, unloading, or cooling.

Fig. 1 shows a modern carborundum furnace in cross section and elevation. The furnace is about 30 ft. long, 12 ft. wide, and 10 ft. deep, and has permanent end walls of concrete which contain the terminals, while the side walls *s* are built up of fire-bricks set in iron frames capable of ready removal by means of an electric overhead crane for discharging. The furnace ends are kept cool by a water-circulating system.

The resistance core *c* is built about half-way up the charge. It is cylindrical, being about 3 ft. in diameter, and consists of granular coke which has become partly graphitised in a previous run. It has a slight upward curve to allow for sagging, owing to contraction of the charge during the run, and is connected at either end to the electrodes *E*, which consist of a number of horizontal carbon rods, by a layer of finely-powdered compressed carbon *K*. The electrodes are clamped to thick copper plates *P* connected to the cable.

The raw material *M* consists of a mixture of silver sand, coke, sawdust and salt, having the composition—

Quartz	-	-	-	-	52.2	parts,
Coke	-	-	-	-	35.4	"
Sawdust	-	-	-	-	10.6	"
Salt	-	-	-	-	1.8	"

The sawdust is added in order to render the material porous, and so aid the escape of carbon monoxide during the process of interaction between the silica and carbon. The addition of salt is found to increase the purity of the carborundum produced, since at the high temperature of the furnace it forms volatile compounds with the metallic impurities.

The mixture of dry powdered materials is fed into the furnace from an overhead conveyer, and when the furnace is loaded an alternating current is passed for thirty-six hours. At the beginning of a run the voltage is about 230 and the current about 6,000 amperes, but as the process proceeds the resistance decreases rapidly and then becomes constant, the voltage being finally about 70 and the current about 20,000 amperes. The carbon monoxide, CO, produced during the reaction, escapes at the sides and top of the furnace and burns there with a blue flame. The

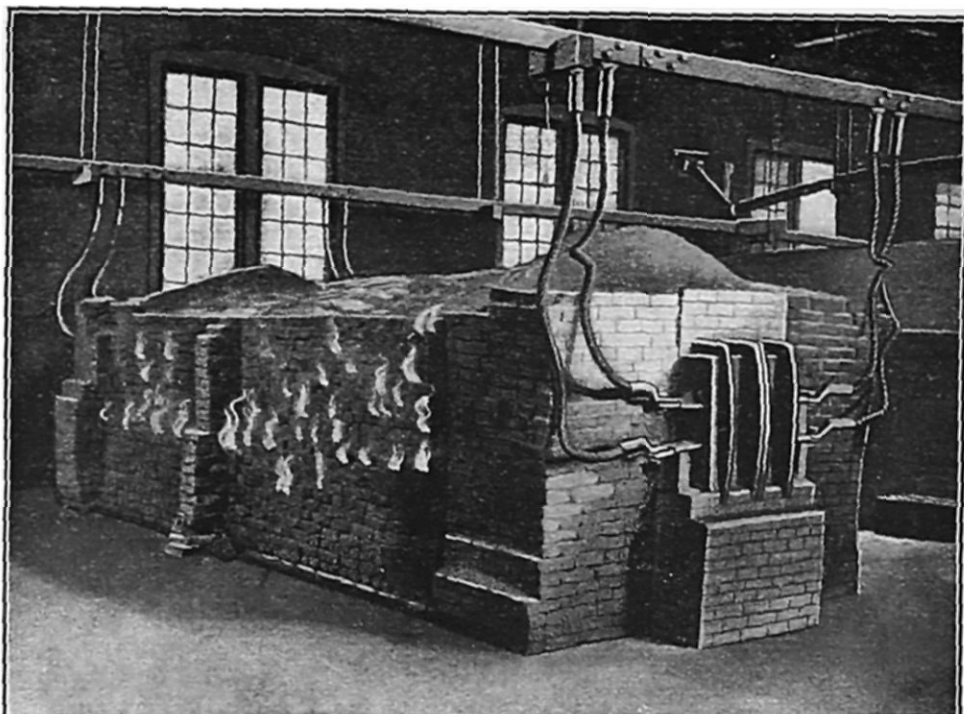

FIG. 2.—Fitz-Gerald's Carborundum Furnace in Action.

reactions which proceed in the furnace are very complicated, but the simple result of the formation of carborundum may be expressed by the equation given above.

When the furnace is dismantled after the run, the core is found to be surrounded by a thin layer of graphite, while next to this is a layer some 20 in. thick of crystalline carborundum, the crystals being larger nearer the core. This in turn is surrounded by a layer of "carborundum firesand," or so-called "amorphous carborundum," or "whitestuff." It contains oxygen and probably consists of a mixture of siloxicon (*q.v.*) and amorphous silicon carbide. Finally the whole is surrounded by more or less unchanged material.

The temperatures of formation of these various products are of the greatest importance, since upon them will depend the conditions for successful working. Tucker and Lampen (1906), Gillett (1911) and Saunders (1912) have all carried out determinations, with results which agree fairly well considering the difficulty of the investigation. L. E. Saunders gives the temperature of formation of crystalline carborundum as  $1,840^{\circ} \text{C.} \pm 30^{\circ} \text{C.}$ , and of its decomposition into graphite and carbon as  $2,240^{\circ} \pm 5^{\circ}$ . The graphite found surrounding the core of the furnace has the skeleton form of carborundum crystals, so that we must conclude that it is produced by the decomposition of carborundum first formed, the changes taking place whilst the temperature of the core is rising from about  $1,840^{\circ}$ - $2,240^{\circ}$ . The same investigator gives the temperature of formation of firesand as  $1,600^{\circ} \pm 50^{\circ}$ , and of its decomposition into crystalline carborundum, of course, as  $1,840^{\circ} \pm 30^{\circ}$ .



The carborundum, the average yield of which is about 9 tons in each run, is transferred in large lumps to roll crushers, where it is broken up and washed. It is finally purified by treatment with sulphuric acid, washed with water, dried, and separated into grades according to degree of fineness. It is then ready for fashioning into wheels or for other employment.

**Properties.**—Carborundum forms masses of lustrous crystals of the hexagonal system, which, when pure, are colourless, but which, as commercially produced, vary in colour from yellow to greenish-grey or blue-black. The crystals are doubly refractive, both indices of refraction being higher than the refractive index of the diamond. Carborundum has a specific gravity of 3.123, conducts heat and electricity, and is remarkable for its extreme hardness (which is about 9.5 on the

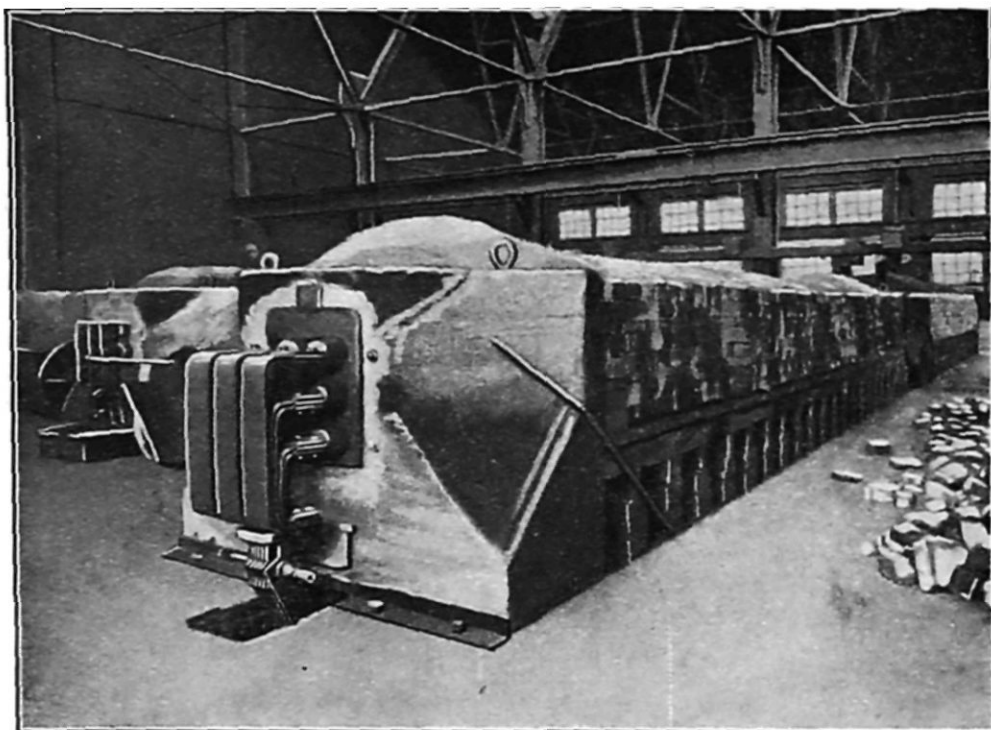

FIG. 3.—Modern Type of Carborundum Furnace used by the Carborundum Company, Niagara Falls.

Mohs scale as against 10 for diamond), its infusibility, and great resistance to chemical change. It can be heated to a temperature of  $2,240^{\circ}\text{C}$ . (L. E. Saunders) before it breaks down, without melting, into silicon and graphite; while, if heated to whiteness in oxygen or air, it very gradually changes into carbon dioxide and silicon dioxide, becoming coated with a layer of the latter substance. It is not attacked by acids to any extent (though syrupy phosphoric acid decomposes it at  $230^{\circ}$ ), but is decomposed by fused alkalis into carbon and a silicate. Chlorine slowly decomposes it at  $600^{\circ}$ ; rapidly at  $1,200^{\circ}$ . It has a high thermal conductivity and a low coefficient of expansion.

Amorphous silicon carbide is not produced in the commercial furnace. The so-called "amorphous carborundum," or "whitestuff," produced during the manufacture of crystalline carborundum is a mixture of silicon carbide, with variable amounts of a variety of siloxicon (*q.v.*).

Commercial carborundum, after purification, always contains the oxides of iron, aluminium, and calcium, the total of these impurities being generally under 1 per cent.

**Uses of Carborundum.**—The usages to which carborundum is put are numerous. Chief among them is its employment as an abrasive (see p. 418), for which purpose it is fashioned into

grindstones and wheels by mixing with some bonding material, such as kaolin or felspar, pressing into shape and igniting. In this form it is extensively used for grinding and polishing metal, porcelain, marble, granite, wood, glass, leather, precious stones, etc. It is also employed for rice hulling. The firesand is mixed with silicate of soda or fire-clay, as binding material, and used to an increasing extent as a refractory in brass, aluminium, and zinc manufacture. The residual carborundum powder obtained from the crushing mills is used in steel manufacture as a source of silicon and carbon, in place of ferro-silicon. Carborundum crystals are now employed in the receiving circuit of wireless telegraph apparatus as rectifying crystals.

**Statistics.**—Carborundum is manufactured, among other places, at Niagara Falls (United States of America), Chippawa (Canada), Düsseldorf-Reisholz (Germany), La Bathie (Savoy), Benateck (Bohemia), Prague (Austria), and Bodio (Turin); while a company has been projected to work on the West Coast of Scotland. At Niagara Falls, at the present time, the Carborundum Company manufacture on the average nearly 5,000 metric tons per annum; while at Chippawa the Norton Wheel Company make about 2,000 tons under the name of "Crystonol."

**Silundum Articles.**—Both Acheson and Bölling have constructed refractory articles, such as crucibles, tubes, etc., by shaping pieces from sand and coke, or firesand and sand, and heating in an electric furnace to a high temperature; or by shaping the articles from graphite, embedding them in the charge of a carborundum furnace, and subjecting them to the action of silicon vapours at a high temperature.

The articles are said thus to become coated with a layer of carborundum, of thickness depending on the duration of heating; but in all probability the action is not simply that of the formation of carborundum, and has not yet been cleared up.

By this process the articles, while retaining their shape, become possessed of great hardness and resistivity, and are capable of conducting electricity at high temperatures. They are known to commerce as "silundum" articles, and are used for electrical cooking apparatus and other purposes.

F. G. Tone (U.S. Patent, 992,698, of 16th May 1911) shapes the pieces of a mixture of carborundum and carbon, bound together with glue or other substance. He then heats them in a carborundum furnace, when combination with vapours of silica or silicon takes place and the binding material is volatilised. By this means he can vary the porosity and resistance of the product. The electrical resistance of silundum is about six times that of carbon, and it is capable of standing a temperature of 1,600° for a considerable time without crystallising.

**Siloxicon.**—This substance is, as described above, always produced, together with silicon carbide, in the carborundum furnace in a zone of lower temperature than that in which the carborundum crystals are formed.

It contains oxygen, has a variable composition corresponding roughly with the formula  $Si_2C_2O$ , and has been said to be a mixture of silico-carbides from  $Si_2C_2O$  to  $Si_8C_8O$ . P. E. Spielmann finds that the composition would correspond with that of a mixture containing about 71 per cent. of  $Si_2C_2O$ , 11 per cent. of  $SiCO$ , 10 per cent. of graphite, 6 per cent. of carborundum, and 1 per cent. of iron, the rest consisting of other impurities; but the identity of the oxygen compounds present is still a matter of conjecture.

Siloxicon, which is manufactured by the International Acheson Graphite Company, is a greenish-grey, amorphous substance, containing dark particles of graphite and carborundum. It has a specific gravity of 2.52, is extremely refractory towards heat, chemically inert, and is insoluble in molten iron. The temperature of its formation is about 1,600°, while at 1,840° it breaks down into crystalline silicon carbide, silicon, and carbon monoxide.

It is prepared in a furnace similar to a carborundum furnace, but having three or more resistance cores to obtain a more even distribution of temperature throughout the mass of material. Acheson, who patented the process in 1902, uses, as raw material, 1 part of powdered coke to 2 parts of sand, together with sawdust to increase the porosity.

Siloxicon is used alone or with binding material for making crucibles, muffles, and fire-bricks, and as a furnace-lining.

It was at one time thought to have a promising future, but it has not been actively commercialised and is not very largely used at present.

**Monox.**—H. N. Potter (English Patent, 26,788, of 22nd December 1905) and F. G. Tone (United States Patent, 993,913, of 30th May 1911) patented processes for the production of a substance which was called monox by the former, and was claimed to consist essentially of silicon monoxide,

SiO. The processes consisted in heating a mixture of silica and carbon in a closed resistance or arc furnace, withdrawing the carbon monoxide gas and trapping it in air-free collecting chambers. The gas carried with it the monox, which collected as an extremely fine powder, light brown in colour, and having a true density of about 2.24. Monox is, however, so voluminous that, unless compressed, it weighs only  $2\frac{1}{2}$  lbs. per cubic foot. It burns in oxygen to form silica, and is slowly oxidised by water. It was thought to be a mixture of SiO, SiO<sub>2</sub>, and Si, but its composition has never been definitely settled. On account of its opacity and power of thickening fluids, monox can be used as a pigment in certain oil paints, particularly for protecting ironwork. It is not manufactured at the present day, however, and its interest is theoretical only.

## MANUFACTURED GRAPHITE

**Graphite**, also known as **plumbago** or **black lead**, is a form of carbon which occurs as a mineral in wide distribution throughout the world, generally in compact crystalline masses. Mineral graphite is velvety black or steel grey in colour, is soft, and has a specific gravity which varies in different localities over a range of about 2.25-2.35. It contains from 75-92 per cent. carbon, the chief impurities being ferric oxide, alumina, silica and lime.

Graphite is found also in the crystalline form in blast furnace slag produced during the process of iron smelting, where it is known as **kish**.

Graphite occurs, just as does amorphous carbon, in several varieties, both crystalline and amorphous. In some cases there is no sharp line of demarcation between graphite and amorphous carbon, so that a satisfactory definition of the former is difficult to give. Recently (1911) W. C. Arsem, who has exhaustively studied the subject, has proposed to define graphite as that allotropic modification of carbon which has the specific gravity of from 2.25-2.26.

**Mode of Formation.**—Carborundum, as has already been pointed out, decomposes at a temperature which has been estimated by L. E. Saunders to be about 2,240° C. into its constituent elements silicon and carbon, the carbon taking the form of crystalline graphite. E. G. Acheson, observing that the core of his carborundum furnace was surrounded by a layer of graphite which sometimes retained the form of carborundum crystals, conceived the idea of producing graphite artificially by first forming silicon carbide in the electric furnace and then decomposing it, by raising the temperature, into graphite and silicon, the latter, together with other impurities, being volatilised by the intense heat. This process, which he patented in 1895, forms the basis of the present-day graphite industry. Acheson subsequently observed the fact that coke could be converted into graphite in the presence of very much less silica than would have been required to convert the whole of the carbon into silicon carbide, and he therefore concluded that the action was catalytic. This observation has been confirmed by Borchers and Mögenburg, and Borchers and Weckbecker, who have shown also that other oxides, such as Al<sub>2</sub>O<sub>3</sub>, Fe<sub>2</sub>O<sub>3</sub>, B<sub>2</sub>O<sub>3</sub>, and CaO, are capable of bringing about the change in various degrees, the required temperature being lower the greater the amount of oxide present. More recently W. C. Arsem has shown that amorphous carbon can in some cases pass to graphite at temperatures above 3,000°, even when no oxide is present; thus, petroleum coke gives a good quality of graphite without the aid of an oxide. All forms of carbon tend to pass to graphite at high temperatures, the velocity of the change being widely variant according to the nature of the substance and the conditions.

Graphite is manufactured by the International Acheson Graphite Company at Niagara Falls, U.S.A.

The chief patents under which the manufacture is carried on are: U.S.A. Patents, 542,982, of 23rd July 1895; 568,323, of 29th September 1896; 617,979, of 17th January 1899; 645,285, of 13th March 1903; 702,758, of 17th June 1902; and 711,103, of 14th October 1903.

Two processes are carried out: (1) the manufacture of graphite powder; (2) the graphitising of electrodes and other moulded articles.

For the manufacture of **graphite powder** a resistance furnace (Fig. 4) similar to the carborundum furnace is used, though narrower in section and having a much thinner core. There are twenty-two furnaces, each being about 30 ft. long, with a sectional area of 18 in. by 14 in., and taking about 1,000 H.P. The end walls, which carry the electrodes *E*, are fixed, while the side walls, which are made of carborundum fire-bricks, are movable. A protective layer of carborundum firesand *F* is placed at the bottom of the furnace, and the charge *M* is loaded in by overhead electric cranes. The charge varies according to the quality of graphite required. It generally consists of clean anthracite, in fine grains, which contains about 10 per cent. of ash.

The ash contains the oxides of silicon, iron, and aluminium, so that a sufficient quantity of oxide to produce the catalytic action is distributed throughout the material. For the best quality of graphite petroleum coke is used, lumps of coke being embedded in coke powder, and from 2.5 per cent. of ferric oxide added. In this case the oxide is soon reduced, and, as the temperature rises, the volatilised metallic iron permeates the whole contents of the furnace and brings about the required change.

The core *c*, which consists of graphitised coke, having been placed in position and the furnace filled, the charge is covered with a layer of firesand and the current is passed. At the beginning about 3,000 amperes at 220 volts are used; but the resistance decreases rapidly, and the final current is some 9,000 amperes at 80 volts. The duration of the run is about twenty to twenty-four hours. When the furnace has cooled the graphite is carefully removed, ground in tube mills, and sifted from coarse particles by means of air separators.

The world's total annual production of graphite is about 100,000 tons, over one-third of this coming from Ceylon and India. The production of manufactured graphite in 1900 was only about 400 tons, while in 1909 it was about 3,300 tons.

Manufactured graphite contains, besides 1-2 per cent. amorphous carbon, varying

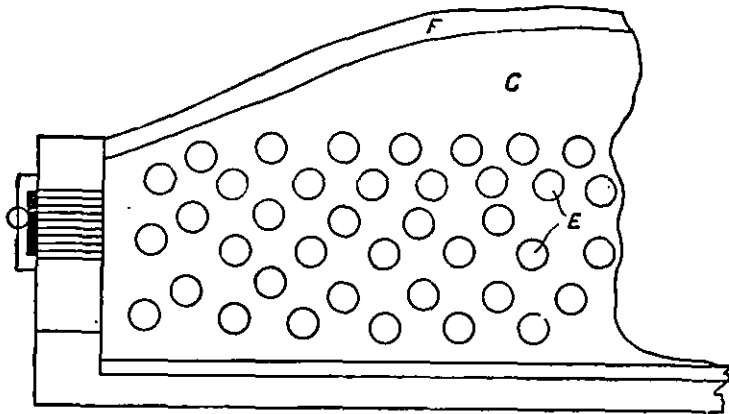

FIG. 4.—Furnace for Graphitising Electrodes.

quantities of ash, according to the temperature at which it is produced and the nature of the raw material; the quantity of ash may be as high as 10 per cent., but in the purest grades it is about 0.2 per cent.

**Uses.**—Graphite is used for making electrodes, lamp-carbons, battery fillings, electrical carbon brushes, refractory crucibles and retorts, and for pencils. It is also used as a paint for coating metal-work, and in electrotyping. As a lubricant it is used with or without oil or grease. By treatment with a solution of gallotannic acid, graphite powder can be caused to assume a state of very fine subdivision, so that it remains suspended indefinitely in oil or water.

In this form it is manufactured under the names "Oildag" and "Aquadag," the word "dag" standing for "deflocculated Acheson graphite."

For the graphitising of electrodes and other shaped or moulded articles, a furnace (Fig. 4) similar to that described above is used. The electrodes are shaped from a mixture containing 97 per cent. of powdered petroleum coke and 3 per cent. of ferric oxide, a little water and molasses, or tar, being used for binding. The shaping is done either by moulding or by extruding the mixture under hydraulic pressure through a die of the required form. The dried electrodes *E* are made to take the place of the core of the furnace, being placed in horizontal rows in the furnace, cross-wise to the current stream, and surrounded by granular coke *C*, by which they are isolated from one another. A mixture of sand and ground coke *F* covers the furnace. The initial current is 1,400 amperes at 210 volts, while at the end of the run the current is 9,000 amperes at 80 volts. The chief development of heat takes place in the granular coke, so that the surfaces of the electrodes are surrounded by regions of high temperature.

Graphite electrodes contain only about 0.1-0.2 per cent. of amorphous carbon, and about 0.1-0.5 per cent. of ash, the rest of the impurities having been volatilised by the intense heat. The specific resistance is 0.0008 ohm per c.c., or only about a quarter of that of amorphous carbon.

Graphite electrodes are more capable than amorphous carbon electrodes of standing sudden changes of temperature without fracture.

**Uses.**—On account of their durability, and the fact that they are comparatively chemically inactive at very high temperatures, graphite electrodes are extensively used in the electro-chemical and electro-metallurgical industries, *e.g.*, in the manufacture of carbides and ferro-alloys, the electrical smelting of iron, zinc, and nickel, the electrolysis of fused calcium chloride and fluoride, the electrolytic recovery of bromine, the production of chlorine and caustic alkalis and of hypochlorites, the cyanide gold and silver processes, etc. They are not used in solutions in which oxygen is liberated at the anode, their temperature of oxidation in air being 640° C.

## ALUNDUM

Alundum, or corundum, is fused alumina,  $Al_2O_3$ , rendered hard by a special process of melting and cooling. Its specific gravity is from 3.93-4.00, and there are two varieties, one white, of melting point 2,050°-2,100°, and the other red dish-brown, melting at 2,000°-2,050°. The white crystalline variety is 99 per cent. pure, while the brown vitreous product is about 93 per cent. pure. The impurities present consist chiefly of oxides of iron, silicon, and titanium. Alundum has a hardness of over nine on the Mohs scale. Alundum is made (U.S. Patents, 775,654, 1904, and 659,926, 1900) by the **Norton Emery Wheel Co.** at Niagara Falls, by fusing pure calcined bauxite in a 500 H.P. arc furnace, and allowing the molten product to cool slowly during three to four hours. The block of alundum so obtained is broken up and used as an abrasive in the form of wheels, etc. It is particularly efficient for work on metals of high tensile strength, such as alloy steels, wrought iron, etc. It is also used for muffles, fire-bricks, etc. The production in 1909 was about 6,000 tons.

It is also manufactured at Rheinfelden under the name of "Diamantin."

Fig. 5 shows a recent design by J. Pettigrew and E. Gerbel-Strover (English Patent, 17,544, 1911), in which the bauxite is fused in the chamber C, which is enclosed by a vacuum jacket V, surrounded by some bad conductor of heat. The electrodes E pass through stuffing boxes in a hinged lid. P represents the arrangement for exhausting the air from the vacuum chamber. The fused material is allowed to cool very slowly in the heat-insulated crucible.

**Silicon.**—Crystalline silicon is manufactured in the electric furnace by heating together a mixture of silica (quartz or sand),  $SiO_2$ , and carbon (coke), when the following change takes place:—

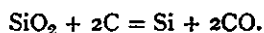

The type of furnace used is an arc furnace taking 1,200 H.P. It is constructed of fire-bricks F, and is lined with carbon C on the interior (Fig. 6). It carries two depending carbon electrodes E, which extend for a considerable distance into the charge, which consists of a mixture of coke and sand. The silicon S is tapped from the bottom of the furnace, at an outlet  $O_1$ , at intervals in the molten state, in pigs of 600-800 lbs.  $O_2$  is an outlet from which slag can, if necessary, be drawn off. Silicon is manufactured on the Continent in furnaces taking over 1,500 H.P.

Silicon is manufactured by the **Carborundum Company** under F. J. Tone's U.S. Patents, Nos. 745,122, 833,427, 842,273, and 869,276.

**Properties.**—Crystalline silicon, as manufactured in the electric furnace, is a brittle substance having a silver-grey lustre and a specific gravity of 2.5-2.6 (cast). It has a hardness of six on the Mohs scale, and is stated by F. J. Tone to melt at 1,430°, though this figure is probably low. It conducts heat and has an electrical resistance many times greater than that of carbon. Acids, with the exception of hydrofluoric acid, scarcely attack it at moderate temperatures; but alkalis readily react upon it. It contains from 90-97 per cent. of silicon, with aluminium, carbon, and iron as the principal impurities.

In 1908, over 600 tons of silicon were manufactured by the Carborundum Company. It is used in refining steel, in place of the higher grades of ferro-silicon, and also in the manufacture of low carbon ferro-alloys, such as ferro-vanadium and ferro-chromium. In this connection silicon has the advantage of possessing great heat of oxidation and of giving a solid oxidation product.

A. G. Betts (U.S. Patent, 918,648, of 20th April 1909) has proposed to use silicon as a reducing agent for zinc ores containing impurities such as iron and lead. Recently, silicon castings have been successfully made, and cast silicon pipes, pans, and other articles are turned out. On account of its resistance to the corrosive action of acids, and its advantage over iron in the matter of specific gravity, this silicon ware is expected to be of value in the chemical industries.

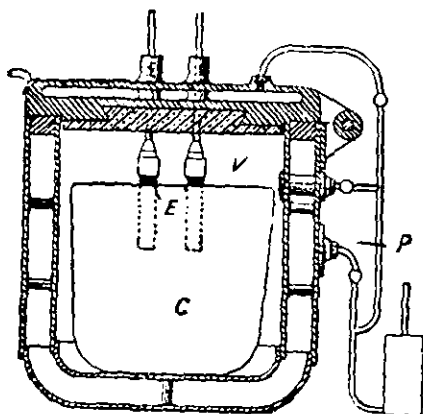

FIG. 5.—Alundum Furnace of Pettigrew and Gerbel-Strover.

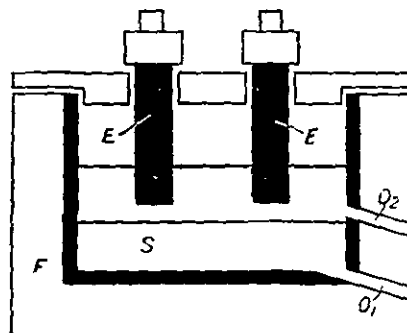
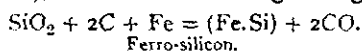

FIG. 6.—Furnace for Producing Silicon.

## FERRO-SILICON

Ferro-silicon is an alloy of silicon and iron in various proportions.

**Manufacture.**—Ferro-silicon is made by heating together in an electric furnace a mixture of silica (usually quartzite),  $\text{SiO}_2$ , iron or steel turnings, and carbon (coke, anthracite, or charcoal), when the following changes probably take place:—



The raw materials consist of quartzite containing over 95 per cent. of silica; iron or steel turnings or shavings, which should contain very little phosphorus; and anthracite, charcoal, or high-grade coke. Quartzite, anthracite, and coke are used in small lumps, while charcoal is used unbroken. Hematite is still employed as a source of iron in certain localities. The proportions of the various materials depend upon the purity of the materials and upon the grade of ferro-silicon to be produced. Thus Pick and Conrad cite instances for Rathenau furnaces using anthracite (20.7 per cent. ash, with two-thirds silica), quartz (0.5 per cent. iron oxide), and iron turnings: for 25 per cent. ferro-silicon the charge was 40 per cent. quartz, 40 per cent. iron turnings, and 20 per cent. anthracite; while for 50 per cent. ferro-silicon the charge was 58 per cent. quartz, 13 per cent. iron, and 29 per cent. anthracite.

**Furnaces.**—The type of furnace used is very similar in principle to the calcium carbide furnace, and in France furnaces at one time used for carbide manufacture are now employed for ferro-silicon. In all cases an arc is struck between one electrode, or both electrodes, and the charge, so that the action of the furnace is partly an arc and partly a resistance action.

The older (Rathenau) type of furnace, some of which are still in use on the Continent, simply consists of a furnace-body, usually cylindrical in section, of fire-brick lined with carbon, into the open top of which a depending, adjustable electrode passes. The other electrode is formed in the hearth of the furnace by means of a steel plate with grooves, into which is pressed a graphite composition. The charge is filled in from the top and reaches to the electrode. The ferro-silicon sinks to the bottom, and is removed every hour or so at a tap hole. The molten substance is allowed to cool, and then broken up into small lumps for transport. This furnace suffers from several disadvantages, in that the electrode consumption is large, and that part of the charge is lost as vapour at the open top.

A more efficient type of furnace is the Keller furnace (see also English Patent, 24,234, 1901), used by the Keller-Leleux Company at Livet (Isère). This consists (Fig. 7) of a furnace-body *B* lined with carbon. Two suspended water-cooled electrodes, or groups of electrodes, *E*, pass through holes in the roof of the furnace; and a tapping outlet enables the ferro-silicon to be drawn off. Slag can also be removed, and the furnace is continuous and may run for several years. The arrangement obviates the disadvantageous floor terminal.

In these older types of furnace the current used is from 10,500-15,000 amperes at from 40-75 volts. At Livet (Isère) some of the furnaces of the Keller-Leleux Company take 1,200 H.P. More modern furnaces are built of silica fire-bricks, bound round with iron frames, and lined internally with carbon. Two adjustable electrodes *E* (Fig. 8) are suspended by chains so as to pass through shafts in the roof. The furnace is of such a size that the molten material is separated from the walls and iron bottom *B* by a layer of solidified charge, the solidification of this layer being aided by air-cooling. The tapping is done through a hole in the side of the furnace, the layer of solidified material being pierced by a pointed electrode mounted on a small carriage. The slag can be drawn off as required by piercing at an appropriate height. The electrodes are so adjusted that there is a small clearance between them and the charge, so that an arc plays between each electrode and the fused charge, through a thin layer of vapour in which the action chiefly takes place. By this means the current is prevented from becoming diffused, and a region of very high temperature is available for the reaction. In the production of ferro-silicon an alternating current is generally used; a direct current may be employed, but the product is then less pure, since it contains foreign metals produced by the electrolysis of impurities in the charge. The voltage

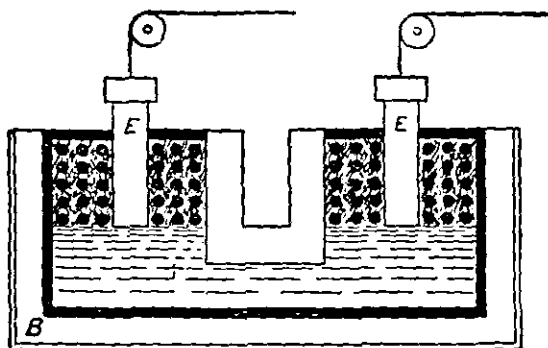

FIG. 7.—Keller Furnace.

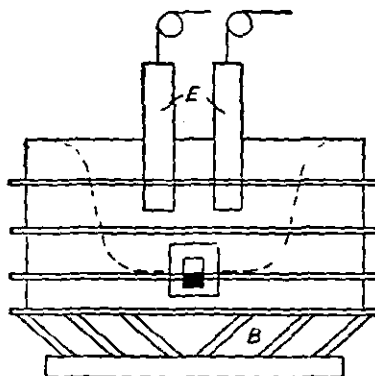

FIG. 8.—Modern Ferro-Silicon Furnace.

used varies, according to the circumstances, from about 40-80 volts. Modern furnaces take up to 4,000 H.P., and even larger (5,000-8,000 H.P.) three-phase furnaces are in use in Norway and Austria. The largest furnaces are said to take 10,000 H.P.

**Properties.**—Ferro-silicon is a hard, greyish substance of crystalline structure, and consists of various compounds of iron and silicon in alloy with either element.

Its composition varies widely, commercial ferro-silicon having a silicon content which may range from about 10 per cent. to over 96 per cent. (see Silicon). Silicides of iron having the formulæ  $\text{FeSi}$ ,  $\text{FeSi}_2$ ,  $\text{Fe}_2\text{Si}$ , and  $\text{Fe}_3\text{Si}_2$ , have been definitely isolated, while three other silicides,  $\text{FeSi}_3$ ,  $\text{Fe}_3\text{Si}$ , and  $\text{Fe}_7\text{Si}_4$ , are said to exist.

Ferro-silicon, as made in the blast furnace, has a low percentage of silicon, but the modern type of electric furnace has tended to increase the silicon content, the chief grades now made containing about 25 per cent., 50 per cent., 75 per cent., and 90 per cent. of silicon. The 50 per cent. grade is the most used. Different grades of ferro-silicon naturally vary in properties. The melting point may roughly be said to range from  $1,200^\circ$  to above  $1,400^\circ$ ; while the specific gravity, according to J. Rothe, is 6.96 for a silicon content of 11.6 per cent., 6.48 for 24.3 per cent., 4.55 for 47.3 per cent., and 2.93 for 77.3 per cent. Ferro-silicon is a good conductor of electricity, and is magnetic, its magnetic qualities diminishing as the silicon content rises.

Ferro-silicon generally contains as impurities calcium, aluminium, magnesium, manganese, phosphorus (and sometimes traces of arsenic), sulphur, and carbon.

The presence of more than a very small amount of phosphorus is avoided, since serious explosions, thought to be due to the generation of phosphoretted hydrogen, have taken place. The grades of ferro-silicon most liable to become explosive are said to be those containing 30-65 per cent. of silicon.

**Uses of Ferro-Silicon.**—It is used extensively in the steel industry as a reducing agent. For many years one of the great problems of the steel industry was how to diminish or avoid the blow-holes and pipes that were formed when steel was poured from the ladle into the large ingot moulds. It was often necessary to cut off 20-25 per cent. of the upper parts of the ingot before perfectly sound metal was reached. It was found that the addition of quite small amounts, say  $\frac{1}{2}$ -1 per cent., of ferro-silicon to the steel while in the ladle evolved much heat from the combustion of the silicon. This thinned the metal and absorbed the oxygen dissolved in the steel, with the result that on pouring into the moulds there resulted perfectly solid ingots with no blow-holes at all. This discovery has made ferro-silicon an important article of commerce, and it is being used to an increasing extent in the steel industry.

Ferro-silicon is also used for producing some of the extraordinary acid-proof irons now on the market. Ironac, tantiron, duriron, etc., all contain silicon (see Vol. I., *Sulphuric Acid Industry*).

**Storage and Transport.**—The evolution of poisonous and explosive gases (probably  $\text{PH}_3$ ) from ferro-silicon containing appreciable amounts of phosphorus caused several accidents (see Pellew, "Ferro-Silicon and its Dangers," *Journ. Soc. Chem. Ind.*, 1914, 33, 774). Consequently in July 1912 the British Board of Trade warned shippers that the carriage of ferro-silicon between 30-70 per cent. Si is highly dangerous, and was prohibited on both cargo and passenger boats. Above and below that grade it can be carried if broken in pieces and stored for a month before shipment, and packed in strong wooden cases pierced with holes and properly labelled. Ferro-silicon, however, as now made with purer materials, is not dangerous.

**Statistics.**—Ferro-silicon was first manufactured in America by the Willson Aluminium Company in 1899, and is now made extensively in France, Austria, Switzerland, and Norway, notably at Bozel, Ugine, Livet, Meran, Courtepin, and Montbovon.

The Electro-Metallurgical Co., of Niagara, started to manufacture ferro-silicon in 1907, and now turn out about 15,000 tons annually. The Electro-Metals Co., at Welland, Canada, commenced the manufacture of the substance in 1908, and produce annually 7,000-8,000 tons. The average consumption of ferro-silicon in the United States was, in 1914, 20,000 tons; 90 per cent. of this was 50 per cent. ferro-silicon, and the price at Pittsburg in 1913-14 was \$71 a ton.

## CALCIUM CARBIDE

**Calcium Carbide,  $\text{CaC}_2$ ,** is produced by heating a mixture of lime and carbon in the electric furnace, when the following change takes place:—

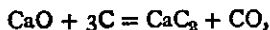

this reaction being a reversible one. The temperature at which the carbide is produced in the electric furnace is variously given as 3,000°, 2,000°, or lower.

The raw materials consist of freshly-burnt lime, containing little magnesia and alumina; and of anthracite or high-grade coke, containing less than 5 per cent. ash, or charcoal.

The materials are, as far as possible, free from phosphorus, arsenic, and sulphur. It has been found that, as in the case of ferro-silicon, the presence of phosphorus and arsenic gives rise to compounds which may render the acetylene produced from the carbide explosive and highly dangerous. The materials are mixed together and fed into the furnace, by hand, in the form of small lumps.

The electric furnaces used in the various countries in which calcium carbide is manufactured are of many different types. In the majority of the more modern furnaces, in which both electrodes enter the furnace from above, the carbide is tapped in a molten form as described under **Ferro-Silicon**; in others, chiefly belonging to the older types, the carbide is taken from the furnace in solid blocks, the furnace body in which the carbide is formed either being wheeled away or, as in the case of the Horry furnace, being caused to rotate and thus carry the carbide away from the sphere of the electrodes.

In the modern Alby furnace (Fig. 9), which is used by the Alby United Carbide Factories at Odda, Norway [see *Engineering*, 87 (1909)], the carbide is removed by tapping during the process. It consists of a sheet-iron body lined with carbon and mounted on wheels, one electrode being formed in the hearth



by means of a steel grill into which a graphite composition is pressed, while the other electrode is constituted by a group of adjustable carbons depending through the roof. A tapping-hole is provided at one end of the furnace, through which the carbide is withdrawn every forty-five minutes.

Fig. 10 shows a complete carbide plant of 4,000-6,000 kw., as erected in Norway. A is the

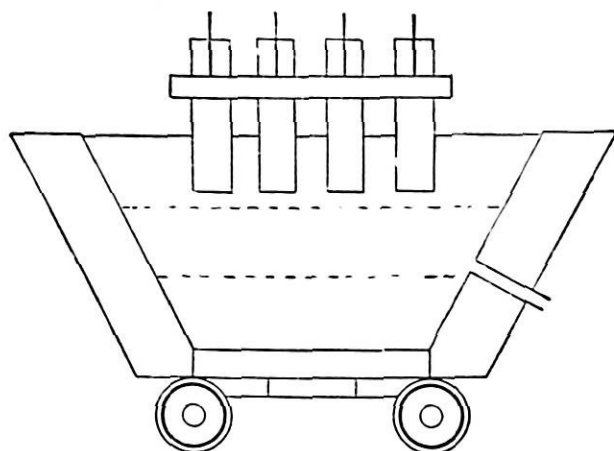

FIG. 9 -The Alby Carbide Furnace.

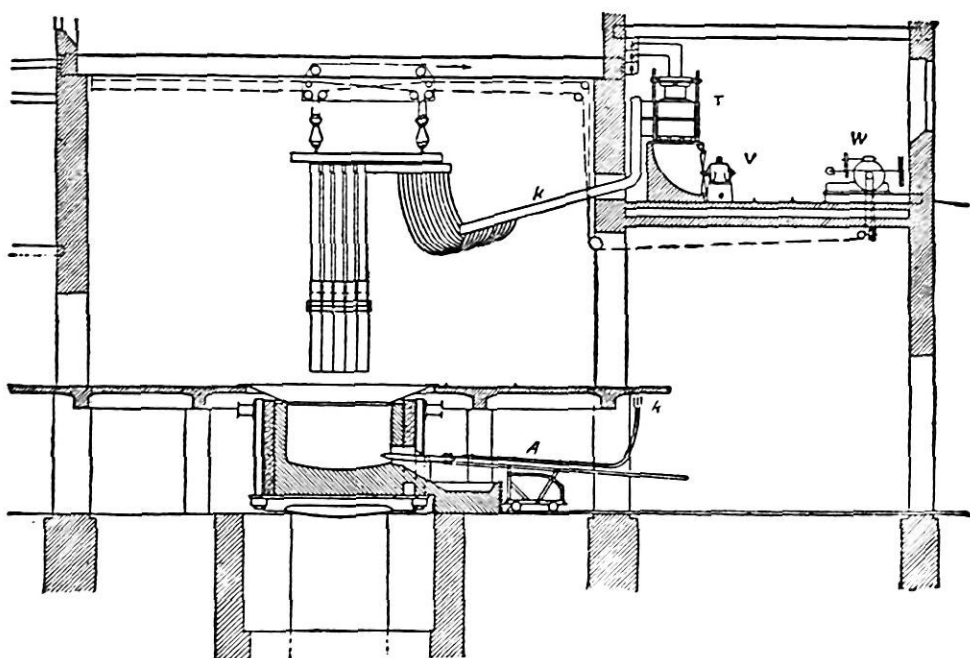

FIG. 10. -Modern Carbide Plant.

tapping arrangement which runs on wheels. It consists of a rod about 18 ft. long, at the end of which is an electrode connected to a copper conducting cable *k*. A powerful current is connected with this electrode, which, when applied to the opening in the side of the furnace closed by the solidified walls of material, melts a hole through 1½ ft. of material in about twenty minutes, so that the white-hot molten carbide flows out and runs off into the iron trays provided for it.

The furnace is built of refractory material lined with carbon. *T* are the transformers, *v* the ventilating fans for air-cooling the furnace walls, *w* the winding gear for raising and lowering the electrodes into the furnace.

The molten carbide is allowed to cool in cast-iron trays, where it forms slabs about 6 in. thick, which are afterwards broken up.

The Odda works at present contain twelve furnaces, each of about 1,800 H.P. capacity, and one larger furnace; but the number is in process of being almost doubled. The current is stated to be 28,000 amperes at 50 volts, and each furnace is capable of producing 7.8 tons of carbide per day of twenty-four hours. 2,000 lbs. of lime and 1,300 lbs. of anthracite, with less than 3 per cent. of ash, are consumed per ton of carbide. The temperature attained is said to be between 2,800° and 3,000°, and the workmen are shielded from the heat by means of wire screens.

At Niagara Falls and at Sault Sainte Marie, the Union Carbide Company employ the Horry type of rotary furnaces.

The furnace consists of a vertical rotating wheel of sheet iron, 8 ft. in diameter and 3 ft. broad. The outer rims are flanged, and over the flanges are placed removable iron segments, 2 ft. deep, so as to form an annular receptacle. These segments are bolted to the lower half of the wheel only, plates being removed as they come by the rotation into the upper half, and placed in position as a space under the electrodes becomes vacant. The electrodes are formed by bundles of carbons, which pass into a fixed vertical shaft, into which the charge is fed. As the carbide is formed, the wheel, which is under automatic electrical control, is caused to rotate, and thus carries the product out of the sphere of the arcs. When the carbide has reached the other side of the wheel, it has had time to cool, and is broken off in pieces 6-9 in. thick. A complete revolution is said to take place once in twenty-four hours. The capacity of the furnace is 500 H.P., and the current is 3,500 amperes at 110 volts.

Both direct and alternating currents can be used for carbide manufacture, though the latter are generally the more advantageous. Recently, very large double three-phase furnaces have been successfully operated on the Continent. The largest furnaces run up to 10,000 H.P.

Commercial calcium carbide is usually about 80-85 per cent. pure, and always contains lime as an impurity. Carbon and iron are among the other impurities commonly found.

**Properties and Uses.**—Calcium carbide,  $\text{CaC}_2$ , in the pure state is a colourless, transparent crystalline substance, but the commercial product is usually greyish or brownish, the colour being due to impurities. It has a specific gravity of 2.22, and is insoluble in all known solvents. At a temperature above 1,500° it decomposes, probably into carbon and a sub-carbide. Its chief chemical reactions upon which its commercial value is based are, firstly, its property of reacting with water in the cold to give acetylene gas (see **Martin's** "Industrial Chemistry: Organic"), which is used to a very large extent for illuminating and other purposes:—



and secondly, the power of combining with nitrogen at a temperature of about 1,200° to form calcium cyanamide (see Vol. I.), which is used as a fertiliser under the name of "nitrolim," or is employed as a basis for the production of ammonium sulphate (see Vol. I.):—

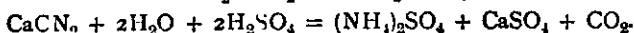
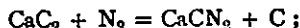

Calcium carbide was first prepared by Wohler in 1863, by the action of a molten alloy of zinc and calcium on carbon; he obtained a black substance which evolved gas on treatment with cold water. In 1892 both Willson and Moissan independently rediscovered the substance, and the first-named placed the process on a commercial basis. The first commercial production of calcium carbide was made by the Willson Aluminium Works in America in 1892, and since that time the industry has extended to enormous dimensions.

The largest carbide plants are situated at Niagara Falls (U.S.A.); Sebenico (Austria); Odda (Norway); Sault Sainte Marie (U.S.A.); Ascoli (Italy); Viège (Switzerland); Collestata (Italy); Papigno (Italy); Jajce (Bosnia); Méran (Austria); and Notre Dame de Briançon (France).

In the year 1910-11 the world's total production of calcium carbide, exclusive of that used for the manufacture of cyanamide, amounted to nearly 260,000 tons. The chief countries producing it were as follows:—

Country.	Production (Tons).
Sweden and Norway	52,000.
U.S.A.	50,000.
France	32,000.
Switzerland	30,000.
Italy	28,000.
Austria-Hungary	22,500.
Spain and Portugal	18,000.
Canada	12,000.
Germany	7,000.
England	2,000.

SECTION LXXXVII

GRINDING AND POLISHING  
MATERIALS

Including Abrasives, Emery Wheels, etc.

BY ALFRED B. SEARLE

LITERATURE

THERE is very little literature of a special character on grinding and polishing, and the reader would do well to study the chapters dealing with these subjects in works dealing with the particular trade in which he is interested—metal working, lens making, etc.

The following books deal specially with the use of grinding wheels :—

A. HAENIG.—“Emery and its Industry.” London, 1912.

G. T. STIER.—“Die Heutige Metall-Technik.” 2 Band. (Schleifmittel und Polieren.) Leipzig, 1911.

Attention is drawn to the fact that numerous articles on this subject have appeared in various engineering periodicals, the following being specially worthy of notice :—

J. HORNER.—“Grinding Machines.” *Engineering*, 1915.

H. DARBYSHIRE.—“Grinding Wheels and Processes.” *Herbert's Monthly Review*, Coventry, 1915.

G. W. BURLEY.—“Notes on Abrasive Wheels.” *Mechanical World*, Manchester, 1912.

MATERIALS for grinding and polishing are necessarily of an abrasive character, as their action depends on the removal of projections on the surface to be ground or polished. The two processes of grinding and polishing are closely allied to each other, polishing usually being the final stages of grinding, though sometimes accompanied by a filling up of hollows which is not really a process strictly to be included under grinding. In order to act effectively, grinding materials must have a hardness greater than that of the material to be ground, and the same is largely true of polishing agents; but whereas in grinding, an agent of much greater hardness than the one to be ground will usually prove economical, because of the speed at which it can be made to operate, the use of too hard a material in polishing will prevent a satisfactorily polished surface being obtained as it will cut too much into the surface to be polished. It is, therefore, necessary in polishing to use a series of abrasives, the earlier members being hard and rapid in action, and the later ones progressively softer so as to exercise a regularly diminishing action. To some extent, this effect may also be produced by reducing the size of the grains of the abrasive; thus, a very rough piece of steel may be first trimmed with a fine chisel, which will remove any prominent projections. It may then be turned in a lathe, which will produce a still smoother surface; the polishing may be continued by the use of coarse emery powder, followed by emery powder of greater fineness, and the final polish may be given by the use of rouge or lime.

Many polishing materials are softer than the surfaces to be polished, but the pressure at which they are applied gives them the effect of a greater hardness. Thus a series of cloth discs, mounted so as to form a sort of wheel, is composed of

an extremely soft material, but by revolving the cloths at a high rate of speed they appear to become quite hard, and form a very efficient polishing tool, particularly if fed with rouge or lime.

Some polishes do not require to be hard enough to abrade the surface to be polished, but only sufficiently so to remove tarnish; this is particularly the case with polishes for gold, silver, furniture, etc.

Grinding materials and polishes may be divided into a number of groups, but a satisfactory classification is not possible. The most important are:—

(a) **Hard mineral abrasives**, such as diamond powder, steel, carborundum, emery, and sand.

(b) **Mild mineral abrasives**, such as chalk, rouge, pumice, kieselguhr and tripoli powder.

(c) **Waxy polishes**, used chiefly for wood, leather, boots, and shoes, etc.

### GRINDING APPLIANCES

The hard mineral abrasives are used in a variety of forms, the chief of which are (1) **Cutting tools**, the material being solid with a sharp edge or point, as a steel chisel or file, a fragment of diamond; these appliances abrade by their intense hardness, which enables them to cut into the material. (2) **Crushing tools**, such as pestles and mortars, grinding mills and crushing rolls; these act by the pressure applied to them being greater than the material to be ground or polished can withstand, the tools themselves being made of a material of sufficient hardness not to be damaged by the pressure and grinding. Some crushing tools may be used on account of their hardness; e.g., when grinding razors and cutlery, the grindstones depend quite as much on the abrasive action of the sand-grains, of which they are composed, as on the pressure applied. (3) **Abrasive powders**, which remove irregularities in the surface to be ground partly by reason of the intrinsic hardness of the powder, and partly because of the pressure with which it is applied.

Cutting tools used for grinding need not be fully described, as they are quite well known. Crushing tools are made of either natural materials or of artificially prepared ones, according to the purpose required and the materials to be treated. The **grinding mills** (pp. 166, 204) in use at the present time are made of iron or steel framework, the actual grinding surface being of either specially hardened metal, a natural stone (sandstone) or an artificial stone (emery wheels). Where the whole structure is of metal, the grinding surfaces (as in **crushing rolls**) are parallel cylinders of steel or specially chilled iron, one cylinder rotating somewhat faster than the other so as to give a slight spreading action. For some purposes it is preferable to have two plates of hard metal, one of which is fixed almost vertically, whilst the other works on a hinge and a lever and is moved reciprocally to the fixed plate; such an arrangement is used in the **Blake Marsden** and other well-known **stone-breakers** or **jaw-crushers**. Another mechanism for grinding hard materials is a **disintegrator**, which consists of a series of steel hammers which rotate rapidly, and are thus brought with considerable force into impact with the material to be ground. **Edge-runner mills** are usually provided with wheels or runners of sandstone, but these are not infrequently fitted with steel rims or tires, so that these machines really belong to the "all-metal" class. **Edge-runner mills** are extensively used for grinding rocks, shales, and other minerals where a high degree of fineness is required. **Ball mills**, **centrifugal mills**, and **stamping mills** are other forms of all-metal appliances used in grinding, and the reader should consult special treatises regarding the details of their construction.

**Mill-stones**, such as are used in flour mills, operate horizontally, the material being crushed or ground between the upper and the nether stone. The stones are made of selected rock, chert being preferred, but sandstone being also used extensively. In the grinding of raw materials for the potteries, a mill consisting of

a stone pavement over which is dragged a circular frame containing large lumps of chert or other hard stone is used, the material being crushed between the two.

The **grindstones used for sharpening** edge-tools are carved from stones selected from the millstone grit deposits, particularly those round Matlock. They wear rapidly, require frequent dressing, and produce a large volume of dust of an injurious character. Since their replacement by grinding wheels made artificially (as described below) "grinder's phthisis" has been almost exterminated. A corundum wheel will last about twenty-five times as long as a gritstone wheel, so that the risk of the dust from it injuring the lungs of the user is negligible.

For grinding by hand it is usual to employ a pestle and mortar; these may be made of a specially hard stoneware (p. 193) or of steel, according to the hardness of the material to be ground or crushed. For chemical purposes, pestles and mortars made of polished agate are extensively used. Mullers or flat-ended hammers are also used for grinding small quantities of material. They are rubbed over the material to be ground, the latter being placed on a plate of glass or polished metal.

A special form of grinding device which has come into great prominence in recent years is the grinding wheel made of a hard abrasive material formed into a disc of convenient size and rotated at a peripheral speed approaching 6,000 ft. per minute. Such grinding wheels have proved invaluable in the dressing of castings and for a variety of other purposes, and in some large works they are rapidly replacing lathes on account of the greater speed at which they work. For many purposes, such grinding wheels can be operated in a stream of water, and the metal to be dressed is therefore kept quite cool, and its temper is retained without much difficulty.

Grinding wheels are of many different types and are made in a great variety of shapes, sizes, and hardness, so as specially to be suited to the requirements of the users. One large firm in the United States claims to have over three hundred different types of wheel in stock, and makes wheels with some thirty-six different degrees of hardness.

The manufacture of grinding wheels is rightly regarded as dependent on the knowledge of numerous trade secrets, few, if any, of which have been published; it is, however, common knowledge that all such wheels are composed of two ingredients—the abrasive, and the bond which unites the grains of abrasive together. The **abrasive** may be composed of emery, carborundum, corundum, alundum, or other suitable material, and the **bond** may be (*a*) vegetable, as shellac, rubber, or "boiled" linseed oil and resin, (*b*) siliceous, as water-glass, (*c*) vitrified, as in porcelain or ceramic wheels, or (*d*) cementitious, as in wheels bonded with cement.

The wheels made with a vegetable bond are elastic, but their speed of cutting is limited by the temperature at which the bond "burns," and is therefore somewhat low. Wheels with a siliceous bond can be worked more rapidly, but the most rapid wheels of all are those with a vitrified bond. It has been found that wheels having a bond of Portland cement are unsatisfactory, as the cement occupies the spaces between the grains of abrasive in such a manner that instead of allowing a clean cutting abrasive action, the wheel becomes polished or "glazed,"<sup>1</sup> and then fails to cut properly, as its cutting fragments have been covered with cement. Wheels made with sorel cement (magnesia and magnesium chloride, see pp. 128, 130) are also unsatisfactory, as they are readily decomposed by water. The best wheels for general use are those with a vitrified bond, provided they are made sufficiently porous, and that the bond is sufficiently fusible to unite the particles firmly, though it must not be melted prematurely by the heat developed when the wheel is in use—the bond used in vitrified wheels is usually a mixture of 70-90 parts of finely ground felspar with 10-30 parts of a vitrifiable clay, the Klingenberg clay being preferred to most others. It is essential that the bond shall be very viscous when fused, as "thin" bonds do not hold the particles of abrasive sufficiently firmly.

Vitrified bonds are greatly improved by the addition of a little water-glass; this strengthens the wheels and facilitates the handling of them during the various stages of manufacture.

The **ideal abrasive wheel** would be one in which the particles of abrasive are held together by the bond until they are worn away or until they become too dull to cut, after which the bond

<sup>1</sup> "Glazing" is one of the commonest defects of grinding wheels. It is usually due to (*a*) a wheel with too hard a bond, (*b*) a wheel which rotates too rapidly, (*c*) too much surface in contact with the work, (*d*) insufficient pressure on the wheel or surface to be ground, and (*e*) an excessively abrasive bond which "smears" the abrasive particles instead of falling away.

surrounding such particles would break off, leaving a fresh surface to continue the grinding. Hence the bond must be of such a nature and in such a proportion that it is reduced to powder at the same rate as the abrasive particles are worn away; otherwise the wheel will have to be "dressed" frequently. This is objectionable for various obvious reasons, though an occasional dressing is almost unavoidable.

The wheels are manufactured by mixing the abrasive and bond in suitable proportions so as to form a plastic paste, which is filled into a mould made of either wood or steel according to the number of wheels required. In some cases the moulded mass is compressed hydraulically in order to give it added compactness and strength. According to the nature of the bond, the moulded mass must be left or subjected to some heat treatment whereby its bonding properties may be fully developed. Wheels with an elastic or siliceous bond are baked at a temperature of 150°-200° C. Those with a vitrified bond require to be heated for sixty hours in a kiln, the final temperature attained being about 1,400° C. The rough wheels have a shaft fitted to the central hub, and are turned true by means of diamonds or "dressing tools" of exceptionally hard steel, after which they are ready for use.

The manufacture requires considerable knowledge of a special character and a high degree of technical and mechanical skill, for the best wheels are made of an artificial abrasive which has to be prepared in an electric furnace, and the bond is developed by heating the moulded wheel in a kiln under conditions equivalent to those for the most delicate porcelains. Moreover, the tests applied to the finished wheels are necessarily far more severe than those applied to most other materials, for first-class grinding wheels must stand an enormous peripheral speed of rotation and be capable of being brought up "dead" against the material to be ground without there being the slightest likelihood of the wheel flying to pieces or being crushed in the impact. In order to drive such a wheel at its highest speed it is necessary to see that it is perfectly balanced; this is one of the chief objects of turning or "dressing it" before offering it for sale.

The two chief characteristics of abrasive wheels are the fineness of the texture (due to the size of the particles of abrasive and known as the **grain** or **grit** of the wheel) and the hardness<sup>1</sup> or resistance to crumbling (technically known as the **grade**). The various grades are produced by altering the nature and proportion of the bond used to hold the grains together.

The fineness or sizes of grain in the abrasive are usually expressed by a series of numbers,<sup>2</sup> and the hardness or grade is represented by a series of letters, arranged alphabetically, A representing the softest and Z the hardest grades. The following table by Burley shows the classes of work for which the various grades are most suitable; it is, however, very incomplete, as no indication can be given of the nature of the abrasive nor of the bond used.

TABLE GIVING GRADE AND GRAIN FOR DIFFERENT CLASSES OF WORK.

Class of Work.	Size of Grains.	Degree of Hardness.
General machine work - - -	30-36	N-P
Tool grinding - - - - -	20-30	N-Q
Malleable-iron castings - - -	16-20	O-R
Chilled-iron castings - - - -	16	P-R
Wrought iron - - - - -	16	O-Q
Car-wheel grinding - - - - -	20	N-R
Drop forgings - - - - -	30	P
Twist drills - - - - -	46	K-N
Reamers and taps - - - - -	46-60	K-N
Milling cutters - - - - -	46-64	K-N
Steel castings - - - - -	16	P-R
Brass castings - - - - -	30	M-Q
Bronze castings - - - - -	20	O-P
Lathe and planer tools - - - -	20-36	O-Q
Small tools - - - - -	60	N-P
Woodworking tools - - - - -	46	K-N
Rough grinding - - - - -	16	O-Q
Surface work on steel - - - - -	20	M-P

<sup>1</sup> When manufacturers speak of hard or soft wheels they refer to the behaviour of the wheel as a whole, and not to the abrasive or bond of which it is composed.

<sup>2</sup> Nominally the number of holes per running inch in a sieve which will just pass the particles.

H. Darbyshire has published the following figures showing the fineness of wheels specially suitable for the materials mentioned :—

Marble	-	-	-	-	-	-	-	-	2 to 6
Glass	-	-	-	-	-	-	-	-	16
Soft cast iron	-	-	-	-	-	-	-	-	24
Hard cast iron	-	-	-	-	-	-	-	-	46
Bronze	-	-	-	-	-	-	-	-	60 to 80
Machine steel or cast steel (either hard or soft) where rapid reduction of stock is required, and up to 60 grit when high finish is desired									24

For precision work in engineering shops, wheels containing several sizes of grains are used. Thus, for most purposes, a wheel made of 24, 36, 60, and 80 grit has all the advantages of a 24-grit one, together with the finishing power of an 80-grit wheel and greater economy in use.

The reader interested in the manufacture of grinding wheels should consult the works by Haenig, Stier, etc., mentioned in the Literature list on p. 413. At the same time he should not be disappointed if he gains little or no information on the points on which he requires it most urgently, for the manufacture of vitrified wheels is kept more rigidly secret than any other corresponding industry. The manufacturers of the wheels are willing, in most cases, to give useful hints on the selection and employment of their wheels for various operations.

**Abrasive paper and cloth** is made as follows :—

First the stock passes between circular rolls which print on one side the name of the company, the kind of abrasive used, and its number; it then passes between two rubber rolls, the lower one of which is immersed in a tank of hot glue. The coat of glue, which is deposited on one side, is next spread evenly by a narrow brush which extends across the stock, and has a very rapid reciprocating movement. Just beyond the brush there is a hopper, from which an even stream of abrasive falls upon the stock; the latter then passes under a steel roll, which forces or imbeds the abrasive grains into the glue, holding them firmly on the stock.

The paper or cloth next passes over an elevated drum, and is then gathered up into loops about 12 ft. long by an endless-chain mechanism, which at regular intervals carries a wooden cross-bar up under the sheet as it feeds out. When one of these sticks upon which one of the loops is suspended is conveyed to the top, it enters upon a horizontal track and is conveyed along by a slow intermittent motion so that the first coat of glue will have time to partially dry before the next coating operation. This intermittent motion is obtained from a framework that extends above the track and moves back and forth. The stroke of this frame is about 12 in., and with each forward movement pawls on it engage the cross-bars upon which the loops hang and push them forward a distance equal to the stroke of the frame. On the return stroke the pawls simply lift and glide back over the sticks, and then engage another set on the next stroke. As the result of this intermittent movement, the loops of cloth or paper swing to and fro as they gradually move along, presenting a rather grotesque appearance.

About one hundred feet from the starting point, the paper which has partly dried passes through a second glue-coating process. This is known as "sizing." The glue is much thinner than is used for the first coat, and is applied to fill up the interstices between the abrasive grains and hold them more firmly in place. When one of the loops approaches this second or sizing machine, it is straightened out as the paper is drawn between the tensioning and glueing rolls, and this straightening out draws the loop cross-bar (which has passed beyond the feeding pawls) forward, and the cross-bar drops upon conveyer chains, and is lowered to the floor.

The paper, after passing the point where the cross-bar support is removed, is drawn over a curved platform down to the tensioning rolls, and then to the second set of glueing rolls. After the sizing operation, the paper passes over a drum or roll on the periphery of which are raised strips that incline from each side towards the centre, similar to the teeth of a herring-bone gear. This roll is to centre the paper before it again enters upon the drying track. The paper is now gathered up into loops upon cross-bars which are automatically elevated at proper intervals, the arrangement being the same as that used after the first coating process.

The loops of coated paper now begin a long journey which continues in a straight line to the end of the room, the motion being intermittent and effected by the feed-pawl mechanism previously referred to. When the procession of swinging loops reaches the end of the room it makes a short turn on a curved track, and proceeds back in the opposite direction. The feed of the cross-bars around this curved end is obtained by a pawl-feeding mechanism similar to that described, except that it is curved to conform to the track, and this curved, fan-shaped frame has an oscillating movement instead of a straight-line motion.

After passing the curve, the loops, which hang quite close together, travel in an unbroken line and on a continuous track from one end of the building to the other several times. At the end of the last track the supporting cross-bars fall on to another chain conveyer, and are carried down to the floor. The stock is then drawn over another curved platform, just beyond which there is a series of rolls which iron out the wrinkles and also provide tension preparatory to winding the coated stock on to an arbor. This is the end of the coating operation.

The complete passage from the first coating rolls to the end where the coated and dried stock is wound on to rolls requires several hours. When the tracks are completely filled with paper they

hold a continuous sheet (joined by glue where breaks have occurred, or where a new roll of paper has been started) which, if straightened out, would extend about eleven miles.

The coating process is practically the same for cloth as for paper, except that the cloth stock requires two passages through the coating machine, one for coating with glue and another for coating with both glue and abrasive. A preliminary coat of glue is necessary, because the cloth absorbs more glue than the paper. Stock varying from 18-48 in. wide can be run through this coating machine. When a lot of paper or cloth is to be coated, the wide stock is put through first, the order being from wide to narrow. This is done so that any wear which might occur on the rubber glue-coating rolls will not affect the narrower widths. Similarly, stock requiring the coarse abrasives is coated last, the order being from fine to coarse to avoid any possibility of coarse grains which might have remained in the machine being deposited upon a paper of finer grain.

The large rolls of coated stock are cut into various shapes in another department.

## HARD ABRASIVE POWDERS

The hard mineral abrasives, either in the form of wheels, as just described, or in powdered form, are extensively used for grinding and polishing. They are sometimes used for cutting, as in the cutting of stone blocks by a band of steel with wet sand as the real cutting agent, but their chief use is for grinding and polishing. The most important of the harder abrasive powders are the following:—

**Diamonds** in the form of either fragments or coarse powder form the hardest abrasive material known. It is used by lapidaries in the cutting of gems and precious stones, and for other work in which no softer abrasive can be used economically. The larger fragments of diamond are held in a special clamp and are employed as cutting tools, but the smaller fragments are used as powder, applied to the surface to be ground under pressure, water being also used to prevent loss by the flying dust.

**Carborundum, SiC**, is prepared by fusing a mixture of petroleum residue, coal, or pitch, with fine quartz sand and a little salt in an electric furnace. It has a hardness closely approaching that of diamonds, and is extensively used in the manufacture of grinding wheels and artificial grinding stones.

On account of its hardness it is rapidly replacing corundum in some industries, though it is more brittle and less economical in use on account of the tendency it has to wear away rapidly.

The crystals of carborundum are small with sharp edges which are just brittle enough to break slightly in use and thus produce a material which cuts cleanly and rapidly and prevents glazing, so that carborundum forms one of the best of the hard abrasives.

**Crystolon** is a registered trade name for the carborundum manufactured by one firm.

**Corundum, Al<sub>2</sub>O<sub>3</sub>**, occurs naturally and, in an impure form, as **emery**; it is prepared artificially on a large scale in the neighbourhood of the Niagara Falls, U.S.A., by fusing bauxite or other forms of alumina in an electric furnace, and it is then known as **alundum**. Another variety—a by-product of the thermite welding process—is known as **corubin**.

Emery is found chiefly in the Greek island of Naxos, and consists of an aggregate of crystalline alumina (corundum) and magnetite (iron oxide), with about 12 per cent. of other minerals, of which the chief is tourmaline. The best qualities contain about 50 per cent. of corundum. Deposits of lesser importance also occur in the states of New York and of Massachusetts, whilst a deposit of very pure corundum occurs at Hastings County in Canada.<sup>1</sup> The grinding power of emery depends almost entirely on the proportion of corundum it contains, and on the effect of the other ingredients in detracting from the hardness of this material; it is therefore probable that with increased facilities in the manufacture of artificial corundum of a purity far greater than that of emery, the artificial material will effect a severe competition with the naturally occurring emery, especially where

---

<sup>1</sup> The Canadian deposit supplies the best natural corundum on the market.



precision grinding is concerned. At the present time, however, the cost of the artificial corundum is so high that there is ample scope for the continued use of emery for some time to come, particularly as the natural material has been found to be more reliable than some of the artificial product.

**Electrite** is a composition—the nature of which is kept secret—intermediate between artificial corundum and emery in hardness. **Carbo-corundum** is a similar material.

Corundum, emery, and similar materials must be ground before they can be used; the ground product is sifted into thirty-three sizes of grains.

The coarser grains are known by the number of holes per linear inch in the sieves through which they have last passed, but grains finer than those which are retained on a 250 sieve are separated by levigation, and are marked according to the number of minutes they remain suspended in water. No numbers are used for this purpose, but the fineness is indicated by the number of cyphers, thus 0 is the coarsest and 00000 the finest levigated emery.

Emery, corundum, and several other abrasives are mounted on cloth or paper and sold under the names of **emery cloth**, **emery paper**, **sand paper**, etc. **Glass paper** is seldom made with glass, quartz grains being harder and more satisfactory. The adhesive used is strong glue, with which the material (cloth or paper) is covered, and the abrasive is then sprinkled on by means of a sieve and adheres when the adhesive hardens. An extensive arrangement is required to hold the long strips of cloth or paper during the coating processes, and to enable the glue to harden before the strips are wound on to a roller. The plant is largely automatic in character, the cloth or paper being fed in at one end, coated and dried, and the finished product being supplied in the form of a roll (see p. 417).

It is customary to employ **garnets** on paper used for wood-working, carborundum or emery cloth for leather goods, and corundum, carborundum or emery cloth for general machine work.

**Sand** (impure silica) is largely used for abrasive purposes, both in its natural form and as sandstone. The grinding stones used for flour mills, cutlery, and other purposes are usually of selected sandstone.

For polishing, sand and water make an excellent abrasive for metals, glass, and other relatively hard surfaces. In the form of a miniature sand storm, sand has been used with great success for grinding and smoothing complex surfaces, and the sand-blast is now considered essential in several industries. In glass manufactories, sand is used in the production of ground glass and for polishing lenses, and in the metal industries it is employed for cleaning and finishing castings, the sand grinding off the dirt and aggregations due to casting in a simple and rapid manner. Sand is not nearly so hard as corundum, but its low cost is greatly in its favour, and it is sufficiently hard for many purposes, so that there is little or no advantage to be gained, in such cases, by using the more costly material unless very rapid work is to be done, or the articles to be ground must be "cut" with great accuracy, as in precision grinding.

**Crushed steel**, made by heating steel to bright redness and quenching it suddenly in water, is a popular abrasive in the United States, especially for stone and marble dressing, about 600 tons per annum being used for this purpose.

## MILD MINERAL ABRASIVES

The mild mineral abrasives are almost invariably used in the form of powders, and are employed more for polishing than for actual grinding, though, as already explained, the two processes are almost identical.

**Chalk**,  $\text{CaCO}_3$ —preferably in the form of precipitated calcium carbonate, which is more free from grit than ground natural chalk—is an extremely mild abrasive, much used in the manufacture of dentifrices, and of polishing powders for silver and plated goods.

**Lime**,  $\text{Ca(OH)}_2$ , is largely used by silversmiths in preference to chalk

**Rouge** is usually composed of extremely fine iron oxide, prepared by precipitation, gentle ignition, and then separation of the finest particles by levigation. There are several reactions in which finely divided iron oxide is a by-product, and these serve as further sources of supply. The finest rouge of all—that employed

for the complexion—is prepared from safflowers (*Carthamus tinctoris*) by pulverising them with a solution of carbonate of soda, and subsequently neutralising this with dilute acetic acid. The precipitated rouge is allowed to fall on absorbent cotton. The rouge is removed, subjected to a fresh treatment with soda and placed in a vessel containing very fine talc. On the addition of dilute citric or acetic acid, the colouring matter is again precipitated and collects on the talc. The product is ground by hand with olive oil so as to ensure the desired mellowness.

Rouge is chiefly employed in giving the final polish to metals, its softness and freedom from grit making it specially suitable for this purpose. The red colour of the material also imparts a pleasing tinge to metals polished by its aid; for this reason it is often mixed with chalk in the preparation of plate powders. The cost of rouge is such that it is only employed where a cheaper abrasive will not give the desired result.

**Tripoli powder or rottenstone** is an aluminosilicate of variable composition or even a number of aluminosilicates which happen to be suitable as abrasives and polishes.

The best quality comes from Corfu and is infusorial like kieselguhr, but little notice is now taken of the source so long as the material is satisfactory. A variety of tripoli powder termed **rottenstone** is found at Bakewell in Derbyshire; it is a highly aluminous and very soft rock, and owes its brown colour to the iron it contains.

**Kieselguhr** is a fine siliceous powder composed of the sheaths of minute diatoms and is one of the best known forms of diatomaceous earth. Like other forms of exceedingly finely powdered or levigated silica, it is largely used as the abrasive in pastes and liquids for polishing metals and wood. For this purpose it must be free from all gritty particles.

**Pumice stone** is a product of volcanic action, and is therefore found in the neighbourhood of volcanoes. Large quantities of it are obtained from Rhenish Prussia.

It is a more powerful abrasive than the other mild ones just mentioned, and is largely used as a preliminary polisher in cases where a quick-acting abrasive is required, but where sand or the harder abrasives would be unsuitable. It is also mixed with soap to increase the detergent properties of the latter.

## POLISHES

Polishes are of two kinds: those which rub away the surface of the material until a smooth and polished surface is obtained and those which cover the material with a coating which is, in itself, smooth and reflective. The former kinds of polish are abrasives and have been described in the pages immediately preceding; the latter are more in the nature of varnishes and lacquers, but differ from these in several marked respects (see **Martin's "Industrial Chemistry: Organic"**) and partake rather of the nature of oils and waxes (*ibid.*).

Polishes may be required chiefly to restore a bright surface which has become dull on exposure, and, in the case of metals, has become covered with a film of oxide which makes it tarnished. The object of the polish is to remove this tarnish, whilst at the same time removing as little of the metal as possible. This may be effected by the process known as **buffing**, which consists in holding the article against a rapidly rotating disc of cloth charged with a mild abrasive, such as lime or chalk; but useful as is this method for the manufacturer, it would be too strong for the owners of the finished goods and would wear away the surface too rapidly if frequently repeated. The abrasive is therefore applied with a piece of flannel and is rubbed by hand on to the object to be polished, the surface being afterwards finished with a wash-leather (chamois leather) or (in the "trade") by rubbing with the fleshy part of the palm, this latter being superior to any other polishing medium for giving the final polish to metals.

It is not always necessary to use an abrasive of a solid nature; thus ammonia solution applied with a piece of flannel will frequently renew the polish on tarnished metals, and paraffin is a well-known remover of rust. Most **metal polishes** contain both solid and liquid abrasives and a detergent, the best known ones

consisting of soap, oil, whiting, chalk, or finely levigated silica, and a colouring agent. Some of the much advertised brass polishes contain finely-ground sand or tripoli powder as the chief solid abrasive, and oxalic acid and paraffin as the chief liquids for removing tarnish.

There are two kinds of polish on metals; one is known as "colour" and is almost a mirror-like polish, in which all the grain of the metal has disappeared. It is seen on high-class steam fittings, etc., and is produced by holding the work against bobs or mops of felt or calico charged with a mild abrasive such as whiting or lime, though it may be produced on work running in the lathe, if the finest abrasive cloth or paper is used and followed with a piece of wash-leather charged with metal polish.

The other kind of polished surface is seen on scientific instruments and is known as **mathematical grain**. It is somewhat difficult to describe its exact appearance, but if an astronomical telescope, photographic lens, or microscope is carefully examined, it will be seen that there is a certain amount of grain under the polish. This is obtained by the use of planishing and burnishing tools, the metal being subsequently covered with lacquer such as those described in *Martin's "Industrial Chemistry: Organic,"* pp. 48, 211, 348.

**Stove polishes** are of several kinds. The one chiefly used some years ago, under the name of **blacklead**, consisted of finely-ground graphite—a form of the element carbon which occurs as a mineral in Cumberland, Ceylon, and elsewhere. **Brunswick black** consists of asphaltum or pitch mixed with turpentine and linseed oil and heated until the mixture becomes uniform throughout, but some of the preparations sold as Brunswick black contain benzoline and other vehicles, and the pigment is bone pitch or some other convenient form of carbon instead of asphaltum or bitumen. A well-known "brilliant" stove polish consists of an ink made by precipitating sulphate of iron with tannic acid, the liquid being mixed with boot blacking; another—almost equally well known—consists of plumbago or graphite mixed with water-glass and glycerine, sufficient aniline black being added to give the desired tint.

**Furniture polishes** consist chiefly of beeswax or paraffin wax, soap, turpentine, alcohol, and water, made into an emulsion, but some consist of a solution of sandarac and shellac (with or without gums) in alcohol.

**French polish** for woodwork consists of shellac dissolved in alcohol and coloured with "dragon's blood." Various other gums, such as benzoin and juniper, are also added by some polishers.

The proportions vary very greatly, and are apparently adapted to suit the skill of the workman rather than to secure the best result apart from any question of skill in application.

**Boot and shoe polishes** vary greatly in composition, but their essential constituents are shellac, wax, lampblack or an aniline black or light brown dye, with turpentine, paraffin, or alcohol as a vehicle. Too much shellac must not be used or the polish will crack. Spermaceti is used to prevent this in some polishes. To prevent the paste from drying to an inconvenient powder, a little glycerine may be added with advantage.

Boot and shoe polishes are more conveniently considered under **Waxes** (*Martin's "Industrial Chemistry: Organic"*).

**Boot blackings** consist of bone-black, sugar syrup, sulphuric acid, and olive oil, or their equivalents.

**Mechanical methods of polishing** are very various, each industry employing its own adaptations of the general methods. In most cases they consist in applying the abrasive or waxy polish to the article under a considerable pressure, this being applied by hand or mechanically, according to the nature of the material to be polished. Thus, wood polishers work entirely by hand, but in the polishing of stones, lenses, and metals the earlier stages are all carried out mechanically—usually by rotating a disc carrying the abrasive and applying the object to be polished to this, or by making the object rotate and applying the abrasive to it under the pressure of a metal or wooden polishing tool. The final stages may be assisted by the use of mechanism, but the pressure to be applied is usually so slight that it must be applied by the hand of a skilled operative.

## SECTION LXXXVIII

# PHOSPHORUS

BY C. AINSWORTH MITCHELL, B.A. (Oxon.), F.I.C.

**PHOSPHORUS**, in combination with other elements, is one of the most abundant substances in nature. In the form of calcium phosphate it is the principal constituent of various minerals such as phosphorite and apatite; in others it is present as iron phosphate, aluminium phosphate, etc. It is also a chief constituent of the bones of vertebrate animals, and is found in the brain substance, muscles, etc.

It was discovered towards the close of the seventeenth century by Brand, who had ignited the residue left on the evaporation of urine in a search for the philosopher's stone; and in 1755 it was prepared by Scheele by the distillation of bones.

Until comparatively recently modifications of this method were still the only manufacturing processes.

By dry distillation of bones in iron retorts, a distillate known as **Dippel's animal oil** is obtained, while a residue of **bone charcoal** or **bone earth** is left behind. This bone charcoal, after being used as a decolorising agent in sugar refineries, is calcined to obtain **bone ash**, which was formerly obtained by directly calcining the bones in kilns.

This bone ash is washed in leaden tanks, first with hot water, and then with the calculated amount of sulphuric acid to convert the tricalcium phosphate in the ash into the soluble monocalcium salts—

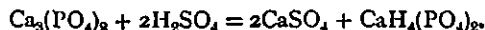

After dilution and sedimentation of the calcium sulphate the clear phosphate solution is decanted, and concentrated in leaden pans to a specific gravity of 1.45, after which it is mixed with a little wood charcoal, and evaporated to a nearly dry solid mass in iron pans.

This residue is next heated in horizontal terra-cotta retorts, arranged back to back in rows in a furnace, and after being exposed to red heat for twenty-four hours the monocalcium phosphate is converted into calcium metaphosphate—

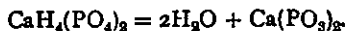

The temperature is then raised to white heat for about forty-six hours, with the result that tricalcium phosphate is produced, while carbon monoxide is evolved, and free phosphorus distils—



The phosphorus is condensed under water, and is purified by redistillation with a small proportion of moist sand, and is finally moulded into cylinders under water.

Another method of purification used in France is to treat the phosphorus under warm water with sulphuric acid and potassium bichromate.

The drawbacks to this process, apart from the cost of the raw material, are that it only yields a portion of the phosphorus present, and that compounds of phosphorus and sulphur are simultaneously produced, and have subsequently to be eliminated. Hence the final yield of the pure product is less than 10 per cent. of the original material.

In Fleck's process, now abandoned, hydrochloric acid was used instead of sulphuric acid for the decomposition of the bone ash.

Wöhler (*Pflüg. Arch.*, XVII., 179) devised a process of obtaining a better yield of phosphorus by heating the slightly charred bones with sand—

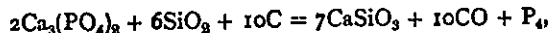

but it was found that high temperatures were required, and that the calcium silicate

attacked the retorts to such an extent as to render the process unpracticable on a manufacturing scale. For the same reason the process could not be used for the treatment of mineral phosphates.

**Readman and Parker's Process.**—It was not until an electric furnace was

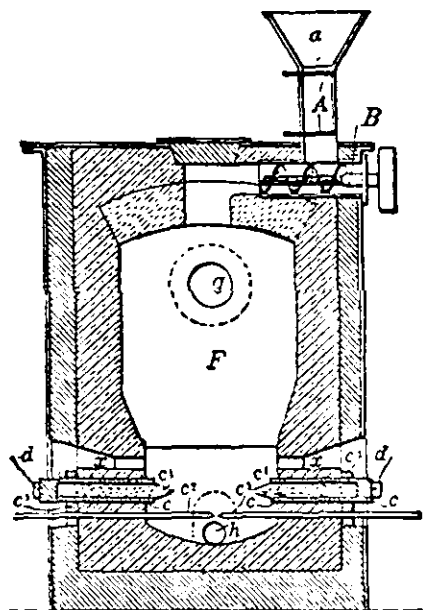

FIG. 1.—Vertical Section.

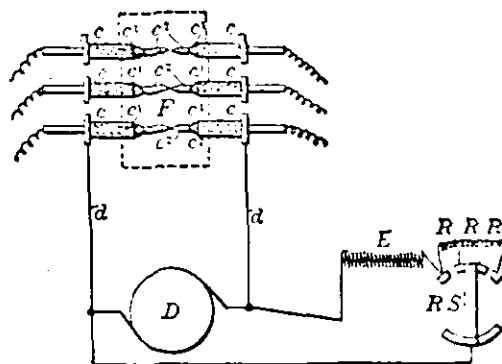

FIG. 2.—Arrangement of Electrodes.  
Readman and Parker's Phosphorus Furnace.

used for heating the mixture (1898) that it was found possible to prepare phosphorus by Wöhler's process. Readman and Parker's furnace is shown in Figs. 1 and 2.

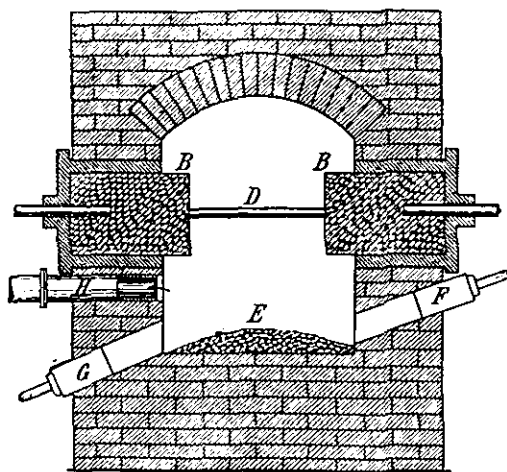

FIG. 3.—Phosphorus Furnace of the Electric Reduction Co.

A finely-ground mixture of 100 parts of phosphorite with 50 parts of sand and 50 parts of charcoal is introduced into the hopper *a*.

After the initial heating has been effected by a current passing through the movable carbons *c*, the latter are withdrawn, and an arc-light made to pass between the electrodes *c*<sup>1</sup>. The phosphorus fumes pass through the tube *g*, and are condensed in water contained in copper receivers.

Any oxidation of the phosphorus may be prevented by passing a current of coal-gas through the retort (German Patents, 107,736 and 112,832).

In the furnace of the Electric Reduction Co. (Fig. 3) the mixture of phosphate, carbon, and silica is placed on a bed *x*, beneath a rod of graphite *D* of high resistance connecting the two blocks of carbon *B*. On transmitting a current the rod *D* becomes white hot, and the deflected heat decomposes the phosphate mixture. The phosphorus fumes escape through the tube *F* to the condensers, while the slag is afterwards removed through the outlet *G*.

To prevent decomposition of the water in the condensers by the phosphorus vapours the Compagnie Électrique du Phosphore, Billaudot et Cie, have patented (German Patent, 106,498) a process whereby the condensation is effected in an atmosphere of carbon monoxide which is formed in the reaction.

A diagram of their furnace is shown in Fig. 4. The vapours (namely, phosphorus and carbon

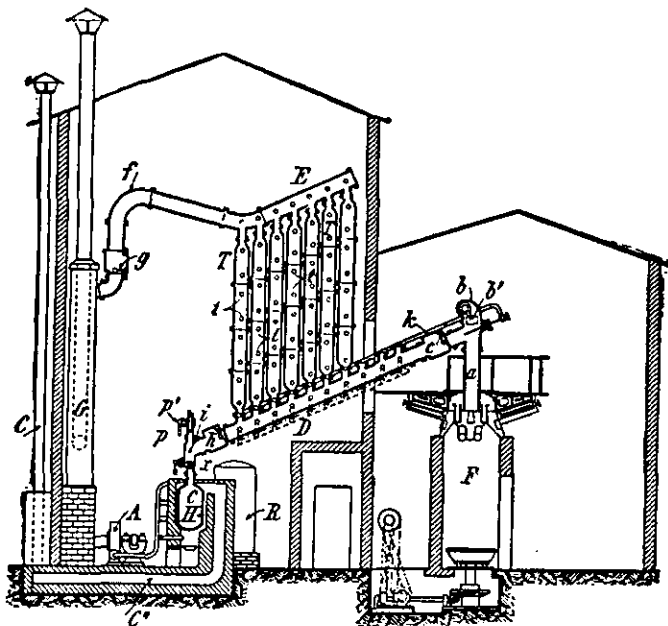
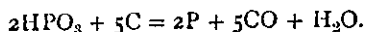

FIG. 4.—Phosphorus Condensation Plant of the Compagnie Électrique du Phosphore, Billaudot et Cie.

monoxide) formed in the furnace *F* are freed from solid particles by passing through the tube *a*. Thence they pass through *D* and the upright tubes *T*, which are kept at 50° C., into the tube *E*, where the bulk of the phosphorus condenses and falls into *D*. The regulation of the temperature and the speed of the passage of the vapours is controlled by a current of carbon monoxide, which is stored in *R* and can be forced through the openings *t* in the tubes *T*. Any phosphorus escaping uncondensed from *E* passes onwards into the tower *G*, where it is brought into intimate contact with a solution of copper sulphate. The resulting copper phosphide is used in the manufacture of phosphor bronze.

The electrical methods of producing phosphorus are everywhere taking the place of the old method of distilling bones, for the high temperatures required for the reaction (1,300°-1,450° C.) are in this way most economically obtained. The residual slags still contain about 20 per cent. of the phosphorus originally present. This is left in the form of irreducible iron phosphide or silico-phosphoric acid.

In Neumann's process (*Zeit. angew. Chem.*, XCV., 291) a better yield of phosphorus is obtained by reducing phosphoric acid with carbon at a temperature of 650°-850° C.—



Earthenware retorts are used for this purpose, and lower grades of phosphorite may be used as the raw material.

**Harding's process** is based upon a similar reaction. Phosphorite is first decomposed with an excess of sulphuric acid, and the phosphoric acid solution filtered from calcium sulphate mixed with carbon and evaporated to dryness. It is next heated to expel sulphates, and the residue of phosphoric and phosphorus oxides is reduced in an electric furnace.

The simultaneous production of calcium carbide and phosphorus forms the basis of Hilbert and Frank's German Patent, 92,838, and Bradley and Jacobs' English Patent, 10,290, of 1898.

In Joudrain's process on these lines the raw material, phosphorite, is heated with an excess of charcoal in carbide furnaces, and the phosphorus fumes condensed in water towers—

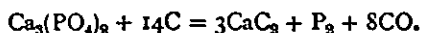

It is doubtful whether the carbide thus produced would be sufficiently pure for ordinary purposes.

Reduction of phosphoric acid or phosphates with metallic zinc or aluminium (Rossel, German Patent, 71,259) in the presence of sand has also been proposed as an industrial method of preparing phosphorus.

**Properties.**—The so-called **yellow** or **white** phosphorus is a wax-like solid which melts at  $44.4^\circ \text{C}$ ., boils at  $287^\circ \text{C}$ ., and has a specific gravity of 1.83. It is insoluble in water, but dissolves readily in carbon bisulphide, and is slightly soluble in alcohol and ether. It "phosphoresces" in the dark, and when exposed to the air in a finely divided state ignites spontaneously.

In Mitscherlich's test for the detection of traces of white phosphorus the substance is boiled with water in the dark, the steam becoming luminous when phosphorus vapours are present.

Phosphorus dissolved in carbon bisulphide will precipitate metallic phosphides from solutions of salts of the metals, as, for example, silver phosphide,  $\text{PAg}_3$ , and copper phosphide,  $\text{Cu}_3\text{P}_2$ .

White phosphorus is extremely poisonous, and absorption of the vapours causes chronic necrosis of the jaws and teeth.

**Allotropic Modifications of Phosphorus.**—Several allotropic forms of phosphorus are known, including Schröller's "amorphous" red phosphorus discovered in 1845, Hittorf's black phosphorus, and Schenk's scarlet phosphorus.

**Red Phosphorus**, which is sometimes also termed **amorphous** phosphorus, though it forms hexagonal crystals, is slowly produced when white phosphorus is exposed to light. It is more rapidly produced by heating ordinary phosphorus in a vacuum at  $300^\circ \text{C}$ ., or with a trace of iodine at a lower temperature.

On a manufacturing scale it is prepared in Albright's apparatus, which consists of a cast-iron vessel containing an inner porcelain chamber, the top of which can be screwed down. The space between the inner and outer chamber is filled with sand, and the iron vessel also rests upon a sand bath, which is heated for eight days at a temperature of  $230^\circ$ - $250^\circ \text{C}$ . From the top of the porcelain chamber containing the soluble phosphorus there passes a bent tube, the end of which dips into a trough of mercury to form a seal.

At the end of the operation a mass of red phosphorus, mixed with unaltered white phosphorus, is left in the chamber. By boiling the mixture with sodium hydroxide solution the white phosphorus is converted into phosphine,  $\text{PH}_3$ , which escapes, leaving the red phosphorus unaltered.

A more recent method of separating the two varieties is based upon the difference in their specific gravity. The mixture is first finely ground under water, and then incorporated with a solution of calcium chloride of sp. gr. 1.9 at  $50^\circ \text{C}$ . The white phosphorus (sp. gr. 1.83-1.84) melts and rises to the surface, while the red phosphorus (sp. gr. 2.1) remains at the bottom. A separation of the two kinds of phosphorus may also be effected by extracting the mixture with carbon bisulphide.

**Hittorf's Black Phosphorus.**—This is prepared by heating white phosphorus with lead in a sealed tube to a temperature of about  $800^\circ \text{C}$ ., and subsequently dissolving the lead by means of an electrolytic bath of lead acetate and acetic acid. Metallic bismuth may be used instead of lead in this process, but a lower yield of the black phosphorus is obtained.

The specific gravity of Hittorf's modification is 2.31-2.33. It is more inert than red phosphorus, but oxidises very slowly in the air.

A so-called **pyromorphic phosphorus** is described by Jolibois (*Comptes Rend.*,

1910, CLI., 382). It is prepared by treating red phosphorus with a trace of iodine at  $280^{\circ}\text{C}$ ., or *in vacuo*. It is more stable than red phosphorus at temperatures below  $450^{\circ}\text{C}$ .

Incomplete conversion of red phosphorus into this modification yields a puce-coloured product consisting of a mixture of the two modifications.

When red phosphorus is heated at  $725^{\circ}\text{C}$ . it is converted into a violet modification with a specific gravity of 2.27.

**Schenk's Scarlet Phosphorus** is obtained by heating a solution of phosphorus in a solvent that acts at the same time as a catalytic agent, *e.g.*, phosphorus tribromide. After several hours at a relatively low temperature ( $175^{\circ}\text{C}$ .), the scarlet phosphorus is deposited as an amorphous powder, which is separated from the phosphorus tribromide by boiling it with water. It has the stability of ordinary red phosphorus, but reacts more readily with reagents, and is therefore used in the manufacture of safety matches.

In a process patented by Totenhaupt (German Patent, 171,364) this modification is obtained by heating a solution of white phosphorus in a hydrocarbon such as benzene or naphthalene for several hours at  $120^{\circ}\text{C}$ . in the presence of 0.25-0.5 per cent. of iodine.

In addition to its principal use in the match industry, red phosphorus is used in the preparation of hydriodic acid, and for producing a vacuum in electric lamps.



## SECTION LXXXIX

# MATCHES

BY C. AINSWORTH MITCHELL, B.A., F.I.C.

### LITERATURE

CLAYTON, E. G.—*Proc. Chem. Soc.*, 1911, XXVII., 229.

—*J. Soc. Chem. Ind.*, 1912, XXXI., 568.

W. JETTEL.—“Zündwaaren Fabrikation.” Vienna, 1897.

J. KELLNER.—“Handbuch der Zündwaaren Fabrikation.” Vienna, 1886.

PRIOR to the invention of phosphorus matches early in the nineteenth century, “friction lights” were manufactured by Walker in this country. These consisted of antimony sulphide and potassium chlorate, and were ignited by friction upon sandpaper. “Lucifer” matches of a similar character were invented by Jones.

The following analyses by E. J. Clayton<sup>1</sup> gives the percentage composition of typical specimens of these early matches:—

	S.	KClO <sub>3</sub> .	Lycopodium.	Gum.	Antimony Sulphide.	Ferric Oxide.
“Promethean” matches <sup>2</sup> (1828) -	24.7	34.9	8.8	31.6	...	...
“Lucifer” „ I. (1832-3)	6.5	27.6	...	35.7	24.6	5.6
“Lucifer” „ II. (1832-3)	12.5	41.0	...	24.9	18.1	3.3

The earliest phosphorus matches made in France, Germany, and Austria contained potassium chlorate, and owing to the danger attending their use were soon prohibited in the latter countries. They were imported in large quantities into England.

Typical examples of early phosphorus matches, examined by Clayton, had the following percentage composition:—

	Ordinary Phosphorus.	S.	KClO <sub>3</sub> .	Chalk.	Dextrin.	Gum.	Dye.
German (about 1835)	20.5	14.3	32.1	8.0	25.1	...	Trace of blue dye.
Austrian (1835-50) -	17.8	11.5	37.4	...	...	33.3	...

In 1837 matches were made in Germany in which the potassium chlorate was replaced by the product of the interaction of red lead and nitric acid. The first

<sup>1</sup> *Proc. Chem. Soc.*, 1911, XXVII., 229.

<sup>2</sup> Ignited by dilute sulphuric acid, coloured with indigo.

"safety" matches were invented by Böttger in 1843, the composition of these being ignited by friction upon a surface coated with red phosphorus.

Matches of a similar kind were soon afterwards manufactured in Sweden, but for many years could not compete commercially with matches containing white phosphorus.

**Composition of White Phosphorus Matches.**—The heads on these usually contain from 4-7 per cent. of ordinary white phosphorus mixed with an oxidising agent such as lead oxide.

The various ingredients are heated together in a closed vessel over hot water, and are meanwhile continually stirred with an agitator. The wooden spills are dipped into this paste, then dried in a current of air, and their heads finally coated with a thin layer of varnish.

Jettel gives the following formula as typical:—Water, 4.5 litres; glue, 2 kilos; glass powder, 2 kilos; iron oxide, 0.5 kilo; cinnabar, 0.1 kilo; and white phosphorus, 2.5 kilos.

**Safety Match Compositions.**—These consist, in the main, of potassium chlorate and sulphur, or a similar substance, with additions to reduce the violence of the ignition. They are ignited upon a surface coated with a mixture of red phosphorus, antimony sulphide, and powdered glass.

Ichenhäuser gives the following representative formula:—

Potassium chlorate, 18; potassium bichromate, 1.6; sulphur, 0.4; manganese dioxide, 1.8; iron oxide, 1; umber, 1; glass powder, 2; glue, 1; and gum arabic, 4 kilos.

The accompanying striking surface consists of red phosphorus, 1.0; antimony trisulphide, 0.25; lampblack, 0.50; and dextrin, 0.30 kilos.

The splints for the matches are prepared from non-resinous woods, generally aspen wood, large quantities of which are exported from Russia. They are impregnated with paraffin wax before being tipped with the composition.

Resinous woods are also sometimes used after treatment with sodium carbonate solution (Hälwe's German Patent, 130,919), or with phosphoric acid solution (Benedick's German Patent, 144,229).

After-glowing is prevented by impregnating the woods with a solution of phosphoric acid and ammonium phosphate.

**Prohibition of White Phosphorus Matches.**—In 1906 a Conference was held at Berne at which most of the principal nations of Europe agreed to prohibit the sale and export of matches containing white phosphorus. Some countries, however, including Great Britain, Belgium, Russia, and the United States, were unable to agree to the prohibition, and relied upon measures to prevent the occurrence of necrosis in the works.

In this country these still proved ineffectual, and in 1908 the White Phosphorus in Matches Prohibition Act was passed, and came into force on 1st January 1910.

In the United States the so-called "double-dip" matches, which contained from 14-20 per cent. of white phosphorus, were in great demand owing to the readiness with which they ignited; but in that country too an Act in 1912 was passed prohibiting their sale and export after January 1914, and imposing a tax upon white phosphorus matches sold after July 1913.

A method of detecting white phosphorus in match composition is described by Thorpe (*Chem. Soc. Proc.*, 1909, XXVI., 73). The substance is greatly heated *in vacuo*, and the white phosphorus, which sublimates under these conditions, is then identified by its physical properties.

**Substitutes for White Phosphorus.**—The substances used as substitutes for white phosphorus in match compositions include amorphous red phosphorus and other allotropic modifications, hydrides, oxides, and sulphides of phosphorus mixed with potassium chlorate or other oxygenating substance, and with inert substances to reduce the violence of the ignition.

## USE OF PHOSPHORUS SULPHIDES

**French State Matches.**—These are made by the process of Sévène and Cahen, with a composition consisting essentially of phosphorus sesqui-sulphide,  $P_4S_3$ , and potassium chlorate, with other ingredients in approximately the following proportions:—Phosphorus sesqui-sulphide, 6; potassium chlorate, 24; zinc white, 6; red ochre, 6; powdered glass, 6; glue, 18; and water, 34 parts.

They are liable to slow decomposition in moist air, with the liberation of hydrogen sulphide.

The use of other phosphorus sulphides,  $P_3S_6$ , is claimed by the Griesheim-Elektron Chemical Co. (German Patent, No. 163,078), whilst Huch (German Patent, No. 174,878) has protected a composition containing a brown powder (16 per cent. of S and 82 per cent. of P) produced by the interaction of sulphur chloride and red phosphorus.

A phosphorus polysulphide,  $P_4S_{10}$ , claimed in German Patent, 239,162, and French Patent, 424,522, of 1910, has been shown by Stock and Frederici (*Zeit. angew. Chem.*, 1912, XXV., 2201) to be mainly a mixture of sulphur and the sulphide  $P_4S_3$ . Thiophosphites made by heating sulphides (*e.g.*,  $Sb_2S_3$ ,  $ZnS$ , etc.) with red phosphorus and sulphur in an atmosphere of carbon dioxide to a temperature of  $450^\circ C$ . are used in compositions patented by the Elektron Fabrik (German Patent, No. 153,188), as for example in the formula:—Zinc thiophosphite, 30; potassium chlorate, 60; zinc oxide, 5; gypsum, 3; chalk 5; and powdered glass, 10 parts.

Matches of this composition are less affected by moisture than those containing phosphorus sulphides.

Various allotropic modifications of phosphorus, such as Schenk's scarlet phosphorus and Hittorf's variety (*Ber.*, 1909, XLII., 4510), which is obtained by heating phosphorus with lead in closed tubes to a high temperature, are also used for match compositions.

An ignition composition claimed by G. W. Johnson (English Patent, 21,931, of 1909) contains the following ingredients:—Red phosphorus, 350; antimony pentasulphide, 400; chalk, 100; zinc oxide, 100; and powdered glass, 100 parts.

These are made into a paste with water, and incorporated with:—Glue, 500; potassium chlorate, 1,300; chalk, 50; zinc oxide, 50; and powdered glass, 50 parts.

A paste upon somewhat similar lines is claimed by Caussemille Jeune et Cie et Roche (French Patent, 404,337, of 1909), the phosphorus therein being described as "neutral amorphous phosphorus," obtained from ordinary phosphorus by distillation and filtration.

The preparation and properties of two solid hydrogen phosphides,  $P_{15}H_8$  and  $P_9H_2$ , are described by Stock, Bottcher, and Lenger (*Ber. d. d. Chem. Ges.*, 1909, XLII., 2839). The orange-coloured compound,  $P_9H_2$ , is used in a match composition patented by Wheelwright (English Patents, 21,866, of 1906, and 3,214, of 1910).

**Statistics.**—The following tables show the values of matches exported and imported during several years ending 1910.

## EXPORTS OF BRITISH MATCHES

			Total to Foreign Countries.	Total to British Possessions.	Grand Totals.
1890	Safety matches and others	- -	£ 16,517	£ 129,366	£ 145,883
1895	Safety matches and others	- -	9,849	77,470	87,319
1900	Safety matches	- -	1,175	7,728	89,016
	Other kinds	- -	8,677	81,288	
1905	Safety matches	- -	1,260	8,581	60,232
	Other kinds	- -	4,914	51,651	
1908	Safety matches	- -	853	9,850	81,017
	Other kinds	- -	3,629	71,167	
1909	Safety matches	- -	1,212	15,144	84,752
	Other kinds	- -	3,839	69,608	
1910	Safety matches	- -	1,626	13,092	82,569
	Other kinds	- -	2,270	69,477	

## BRITISH IMPORTS

		Total from Foreign Countries.	Total from British Possessions.	Grand Totals.	
1890	Safety matches and others	£ 368,886	From Australasia, £30	£ 368,916	
1895	Safety matches and others	362,900		...	362,900
1900	Safety matches	203,818		...	203,818
	Other kinds	177,239		...	177,239
1905	Safety matches	263,460		...	265,460
	Other kinds	318,238		...	318,238
1908	Safety matches	327,573		...	327,573
	Other kinds	281,095		...	281,095
1909	Safety matches	341,693		...	341,693
	Other kinds	256,967		...	256,967
1910	Safety matches	306,519		...	306,519
	Other kinds	173,418		...	173,418

# SUBJECT INDEX

NOTE.—The Roman numerals refer to the volume, the Arabian numerals to the pages.

## A

- Aalborg kiln, II., 79, 104, 105  
 Abbe ball mill, II., 24, 94  
 Abraham-Marmier ozone tower, I., 151  
 — — ozoniser, I., 149  
 Abrasive powders, II., 414, 418, 419, 420  
 — wheels, II., 123  
 Abrasives, II., 334, 402, 403, 406, 413-421  
 Abrastol, II., 5  
 Absorption machines, ice making, I., 81  
 — pyrometers, I., 67  
 — towers, I., 277, 447  
 Accelerators, for plaster, II., 116  
 Accumulators, use of cerium salts in, II., 321  
 — use of vanadium salts in, II., 381  
 Acetic acid, decolorising, II., 349  
 — disinfecting properties, II., 5  
 — germicidal value, II., 3  
 Acetonitril, I., 456  
 Acetylene, I., 45, 103, 115, 487; II., 411  
 — hydrogen from, I., 115  
 — reducing power of, I., 487  
 — temperature of ignition, I., 45  
 Achromatic glass, II., 264  
 Acid, benzoic, II., 5  
 — hippuric, I., 429  
 — hydrocyanic—see *Hydrocyanic acid*  
 — hydrofluoric, I., 413-419  
 — nitric—see *Nitric acid*  
 — perboric, I., 425, 426  
 — percarbonic, I., 426  
 — persulphuric, I., 424, 425  
 — salicylic, II., 5  
 — sulphuric, I., 207 *et seq.*; see also *Sulphuric acid*  
 Acid centrifugal pumps, I., 232  
 — concentration pans, I., 236  
 — eggs, I., 233, 277  
 — elevators, I., 231-233  
 — emulseurs, I., 233  
 Acid pumping, I., 231-233, 278  
 — resisting ware, I., 236  
 — sodium sulphate, disinfecting properties of, II., 12  
 — towers—see under *Towers, Gay-Lussac towers, Glover towers*  
 — waters, I., 173, 194  
 Acids, amino, I., 427, 428  
 — disinfecting properties of, II., 12  
 — germicidal value of, II., 10-11  
 — hydrogen from, I., 116  
 Acker, electrolytic process, I., 377  
 Actinium, disintegration of, II., 386  
 — radio-active constants of, II., 387  
 Actinium emanation, radio-active constants of, II., 387  
 — series, II., 387  
 Actinolite asbestos, II., 281, 284  
 Actol, II., 16  
 Adie testing machine, II., 121, 122  
 Adobe clay, II., 144  
 Ados, combustion meter, I., 47  
 Aerated waters, I., 195-200  
 — — continuous process for, I., 196  
 — — fermentation of, I., 199  
 — — Geneva process for, I., 196  
 — — metallic contamination of, I., 199  
 — — pressure of saturation of, I., 197  
 Aerobic tanks, I., 187  
 Aeronautics, use of hydrogen in, I., 117, 118  
 Aeschynite, II., 291  
 Agate pestles and mortars, II., 415  
 Agyrol, II., 16  
 Air, amount required for combustion, I., 46, 47  
 — drying of, I., 77, 86, 89, 93, 98  
 — properties of, I., 103  
 — purification of, I., 86, 89, 154  
 Air-gas, I., 119, 121, 122, 123  
 — — liquefying machines, I., 85  
 — — separators, I., 15, 16, 65, 67; II., 28, 107  
 Alabaster, I., 345

- Alabaster glass, II., 269  
 Alby carbide furnace, II., 409, 410  
 Albuminoid ammonia, I., 160, 193  
 Alcohol, germicidal value of, II., 3  
 — use as fuel, I., 25  
 Alcoholic fermentation, carbon dioxide from, I., 141  
 Alexandrite, II., 63  
 Algin, I., 408  
 Alite, I., 110, 111, 125  
 Alkali, electrolytic, I., 367-379  
 — Act, I., 235-275  
 — chlorides, electrolysis of, I., 367, 368, 374-375  
 — iodides, I., 411  
 — waste, I., 294, 297, 298  
 Alkalis—see under *Sodium hydroxide, Sodium carbonate, Potassium hydroxide, Potassium carbonate, Lime, etc.*  
 — action on glass, II., 246  
 — estimation of, II., 120, 149  
 — hydrogen from, I., 116  
 — presence in fire clays, II., 230  
 — presence in water, I., 172, 173; II., 61  
 — removal from water, II., 61  
 Allanite, II., 316  
 Alloys, pyrophoric, II., 316-319  
 — tantalum, II., 341  
 Alluvial clay, II., 144  
 Almandine, II., 63  
 Alpha-rays, II., 385  
 Altmann's process, II., 10  
 Alum, II., 49, 54, 55, 56, 57  
 — action on plaster, II., 117  
 — ammonium iron, II., 56  
 — burnt, II., 56  
 — iron in, II., 57  
 — potassium, II., 55, 56  
 — potassium chrome, II., 56  
 — replacement by aluminium sulphate, II., 49, 56  
 — shales, II., 55, 144  
 — sodium, II., 56  
 — statistics, I., 332, 333  
 — waterproofing by, II., 118, 119  
 Alum cake, II., 54  
 — stone, II., 55  
 Alumina, I., 227; II., 49-52, 165  
 — bricks of, II., 233  
 — crucibles of, II., 272  
 — detection by dyeing, II., 111  
 — estimation of, II., 119  
 — fused, I., 231, 236; II., 52  
 — manufacture of, I., 473, 474; II., 49-51  
 — packing for acid towers, I., 231, 236; II., 52  
 Alum, properties of, II., 51, 52  
 — thermite, II., 75  
 — uses, II., 51, 52, 240, 250, 253, 277, 278, 279, 418  
 Aluminate, sodium, I., 474; II., 50, 51, 52, 56  
 — calcium, II., 109, 110, 111  
 Aluminium, II., 49, 51  
 — action on alkalis, I., 116  
 — action on charcoal, II., 68  
 — action on iron oxide, II., 68  
 — action on lead sulphide, II., 67  
 — action on metallic oxides, II., 68  
 — action on metallic sulphides, II., 67, 68, 69  
 — alloys of, I., 110; II., 325, 327  
 — metallic plates, I., 175  
 — reduction of metals by, II., 69  
 — sterilising effect of, II., 16  
 — use as anti-scale agent, I., 175, 176  
 Aluminium acetate, II., 56  
 — chloride, II., 16, 56  
 — compounds, industry of, II., 49-57  
 — fluoride, II., 52  
 — hydroxide, II., 49, 50, 51, 52  
 — hypochlorite, I., 396  
 — nitride, I., 107, 473-474  
 — oxide—see *Alumina*.  
 — salts, disinfecting properties of, II., 16  
 — — uses of, II., 56, 57  
 — — water purification by, I., 166  
 — silicates, II., 60, 109 111, 139-142  
 — silicofluorides, II., 119  
 — soaps, II., 57  
 — sulphate, II., 52-57  
 — — iron free, II., 51, 52, 53  
 — — manufacture of, II., 52-54  
 — — properties of, II., 54  
 — — replacement of alum by, II., 56  
 — — uses of, I., 188  
 Alumino-silicates, II., 60, 109-111, 139, 142  
 Alumino-silicic acids, II., 140-142, 150, 183  
 Alumino thermics, II., 67-75  
 Aluminol, II., 5  
 Alunite, II., 55  
 Alundun, I., 236; II., 406-407, 415, 418  
 — furnace, II., 406, 407  
 — literature, II., 399  
 Amalgam, sodium, I., 374, 375  
 Amber mica, II., 286, 288  
 American natural cements, II., 86  
 Amethysts, II., 63  
 Amino acids, I., 427, 428  
 Amino acetic acid, I., 428  
 Ammonia, I., 453-474

- Ammonia absorption in brine, I., 300
- absorption by plants, I., 427
  - absorption of, I., 304, 305
  - albuminoid, I., 160
  - anhydrous, I., 467
  - bacteria, I., 428, 429
  - by direct union of elements, I., 469-472
  - catalytic formation of, I., 469
  - costs of manufacture, I., 471
  - cyanide from, I., 485, 486, 487
  - distillers, I., 312, 313-317
  - dry, I., 467
  - estimation of, in water, I., 193, 194
  - from aluminium nitride, I., 474
  - from beetroot sugar waste, I., 454
  - from blast furnace gas, I., 454
  - from bones, I., 455
  - from coal, I., 453, 454
  - from coke ovens, I., 52, 55
  - from cyanamide, I., 449, 472, 480
  - from leather, I., 455
  - from Mond gas, I., 453
  - from nitrides, I., 473-474
  - from nitrogenous organic matter, I., 455
  - from peat, I., 454
  - from producer gas, I., 454
  - from sewage, I., 455
  - from shale, I., 454
  - from urine, I., 455
  - from vinasse, I., 454
  - heat of distillation of, I., 316
  - heat of evaporation of, I., 80
  - heat of formation of, I., 469
  - heat of solution in brine, I., 305
  - limiting amounts in water for fish, I., 192
  - in water, I., 158, 160, 192
  - oxidation of, I., 429, 434, 435, 448
  - properties of, I., 103
  - proteid, I., 160
  - purification of, I., 465
  - recovery plants, I., 133, 462, 463
  - solutions, analytical, II., 46
  - solutions, specific gravity of, I., 465
  - solid, I., 467
  - sources of, I., 454-455
  - steam required for, I., 316, 317
  - stills, I., 457-459
  - sulphocyanides from, I., 495
  - synthetic, I., 118, 441, 455, 469-474; II., 373
  - tension of vapour during distillation, I., 314, 315, 316
  - tension of vapour, I., 79
  - use as a polish, II., 420
- Ammonia, use as refrigerating agent, I. 78, 79
- water, I., 463-465
- Ammonia cycle, I., 324
- Ammonia soda process, I., 144, 285, 289, 299-328
- — — by-products of, I., 326, 366
  - — — calcium chloride from, I., 366
  - — — carbonating apparatus for, I., 306, 307
  - — — chemical control of, I., 323
  - — — cost of working, I., 325
  - — — history of, I., 299, 300
  - — — modifications of, I., 326
  - — — raw materials for, I., 325, 326
  - — — statistics, I., 289
  - — — summary of, I., 321, 322
  - — — theory of, I., 300
  - — — yield of, I., 303, 324
- Ammoniacal fermentation, I., 187
- liquor, I., 456
- Ammonium acetate, I., 467
- alum, II., 56
  - bromide, I., 467
  - carbonate, I., 556, 466
  - — conversion into potassium carbonate, II., 61
  - — limiting amount in water for fish, I., 192
  - — manufacture of, I., 466
  - — production from urea, I., 428
  - — properties of, I., 466
  - — uses of, I., 466
- Ammonium chlorate, I., 467; II., 61
- Ammonium chloride, I., 176, 466
- — heat of formation of, I., 466
  - — limiting amounts in water for fish, I., 192
  - — solubility in water, I., 301
  - — uses of, I., 466
  - cyanide, I., 456, 494
  - ferrocyanide, I., 493
  - fluoride, I., 417, 467; II., 11
  - formate, I., 471
  - iron alum, II., 56
  - nitrate, I., 435-436, 448, 480
  - — effects of heat on, I., 496
  - — heat of formation of, I., 466
  - — manufacture of, I., 435
  - — manurial value of, I., 436
  - — production of by the ammonia soda process, I., 326, 435, 436
  - — properties of, I., 436
  - — uses of, I., 436, 466
  - oleate, I., 467
  - perborate, I., 426
  - perchlorate, I., 389, 466; II., 61

- Ammonium persulphate, I., 424, 425, 466  
 — phosphate, I., 466  
 — polysulphides, I., 495-496  
 — salts, I., 429, 466-467  
 — — fixed, I., 456  
 — — oxidation to nitrates by bacteria, I., 434  
 — — technical, I., 466  
 — — volatile, I., 456, 457  
 — sulphate, I., 456-463, 466  
 — — composition of, I., 456  
 — — cost of manufacture, I., 471, 472, 473  
 — — direct process for, I., 462  
 — — from ammoniacal liquor, I., 456-459  
 — — from blast furnace gas, I., 454  
 — — from coke ovens, I., 52  
 — — from Mond gas, I., 461  
 — — from nitrolim, II., 411  
 — — from peat, I., 459, 461, 462  
 — — from shale, I., 454  
 — — from urine, I., 455  
 — — heat of formation of, I., 466  
 — — limiting amounts in water for fish, I., 192  
 — — nitrogen content of, I., 469  
 — — oxidation of, by bacteria, I., 434, 435  
 — — plant for, I., 457, 458, 459, 460, 464  
 — — price of, I., 456, 473  
 — — statistics of, I., 454-455; II., 47  
 — — use as manure, II., 36  
 — — yield from coal, I., 453  
 — sulphide, I., 305, 456, 494  
 — superphosphate, II., 42  
 — sulphocyanide, I., 467, 492, 494, 495  
 — thiosulphate, I., 466  
 — uranate, II., 372  
 — uranyl carbonate, II., 372  
 Amphibole asbestos, II., 281-282, 284  
 Amsler and Laffon press, II., 122  
 Analcite, II., 59  
 Anastigmatic glass, II., 264  
 Andeer's lotion, II., 4  
 Anderson's process for water purification, I., 166  
 Andrew's researches, I., 84  
 Anhydrite, I., 329, 346, 347  
 Anhydrous ammonia, I., 467  
 Animal black charcoal, I., 491  
 Animals, assimilation of nitrogen by, I., 427, 428  
 — excretion of nitrogen by, I., 427, 428, 429  
 Annaline, I., 345  
 Annealing glass, II., 261  
 Anodes, composition of, for chlorine, I., 369  
 Anthophyllite asbestos, II., 282  
 Anthracite, I., 6  
 — briquetting of, I., 24  
 Antichlor, I., 259  
 Antiformin, II., 9  
 Antihypo, I., 426  
 Anti-incrustators, I., 175, 176, 347  
 Antimonic acid, colouring pottery with, II., 165  
 Antimony alloys with rare earth metals, II., 318  
 — oxide, colouring glass by, II., 253, 269  
 Antiseptic power, II., 1  
 Antiseptics, I., 422, 423; II., 1-16  
 — testing of, II., 1-3  
 Apollinaris water, I., 198  
 Aquadag, II., 405  
 Aqua regia, I., 279  
 — water purification by, I., 168  
 Aquamarine, II., 63  
 Arc electrodes, magnetite, II., 329  
 — — titaniferous, II., 328-329  
 — — uranium, II., 372  
 Architectural faience, II., 157  
 Archless kiln, II., 214, 216  
 Argentamine, II., 16  
 Argentina, vanadium ores of, II., 377  
 Argon, properties of, I., 103  
 Argonine, II., 16  
 Armour plates, tungsten in, II., 349  
 Armoured concrete, II., 118  
 Armstrong-Mordan process, I., 24  
 Arsenic, disinfecting properties of, II., 13  
 — in mineral waters, I., 200  
 — in sulphuric acid, I., 217, 235, 250  
 — removal from hydrochloric acid, I., 278  
 — removal from sulphur dioxide gases, I., 244  
 — removal from sulphuric acid, I., 235  
 Arsenic acid, use in glass making, II., 250, 253  
 — oxide, disinfecting properties of, II., 20  
 Arsenical dips, II., 20  
 Arsenious oxide in glass, II., 250-253  
 Arsenite of soda, disinfecting properties of, II., 20  
 Art enamels, II., 278  
 Artesian wells, I., 159  
 Artificial cold, I., 77  
 — gems, II., 265-266  
 — guanos, II., 42  
 — manures, II., 21-47  
 — marble, I., 366; II., 128



- Artificial mineral water, I., 195 *et seq.*  
 — silk, for incandescent mantles, II., 304, 305, 306, 312, 313  
 — stone, I., 419; II., 129-131, 134  
 — teeth, II., 191  
 — zeolite industry, II., 59-61  
 Asbestic, II., 284  
 Asbestos, II., 281-284  
 — actinolite, II., 281, 284  
 — amphibole, II., 281, 284  
 — anthophyllite, II., 282  
 — blue, II., 282  
 — chrysotile, II., 282, 283, 284  
 — crocokolite, II., 282  
 — filtering, II., 284  
 — fireproofing, II., 284  
 — Italian, II., 281, 282  
 — nature of, II., 281  
 — ropes of, II., 284  
 — serpentine, II., 282  
 — tremolite, II., 281, 284  
 — uses of, II., 284  
 Asch's theory of clays, II., 141  
 — — of glass, II., 244, 267  
 — — of silicates, II., 236-241  
 Astrakanite, I., 329, 330  
 Atlantic Ocean, composition of, I., 263  
 Atmospheric nitrogen, absorption of, I., 427, 428, 429  
 — — quantity of, I., 441  
 Atomisers, I., 226, 418  
 Atoms, disintegration of, II., 384-385  
 Auer metal, II., 316, 317  
 Auricome, I., 423  
 Aussig-Bell cell, I., 373, 376, 377  
 Australian uranian ores, II., 370  
 Autogenous welding, I., 105; II., 71, 72  
 Automatic gas lighters, II., 316-319  
 — stokers, I., 35  
 Autunite, II., 369, 370, 371, 372, 389  
 Available chlorine, I., 396  
 — heat of fuel, I., 45  
 — oxygen, I., 360, 421, 424  
 Aventurine, II., 164  
 Aventurine glass, II., 267, 268, 269  
 Avery's automatic hopper weigher, II., 108
- ## B
- Babcock & Wilcox stoker, I., 37, 41  
*Bacillus typhosus*, II., 3  
 — *urea*, I., 428  
 Bacteria, destruction of, by light, I., 158, 170-172  
 — — in sewage, I., 186-189  
 — — in water, I., 168  
 Bacteria in water, I., 161  
 — nitrifying, I., 427, 428, 429  
 Bacterial manures, II., 39  
 Bacterised peat, I., 434  
 Baddeleyite, II., 331, 332  
 Balas ruby, II., 63  
 Ball clays, II., 144, 154, 160, 166, 194  
 — mills, II., 24-26, 89, 93, 94, 414  
 Balloons, I., 117  
 Baltic, salt in, I., 263  
 Barium carbide, I., 491  
 — carbonate, I., 351; II., 248  
 — — in glass, II., 248, 253  
 — — water softening by, I., 178  
 — chloride, I., 351, 352  
 — — limiting amount in water for fish I., 192  
 — hydroxide, I., 114, 352  
 — nitrate, I., 352  
 — oxide, I., 352  
 — — in enamels, II., 277  
 — — influence on glass, II., 248  
 — peroxide, I., 352, 421-422, 423  
 — — action of aluminium on, II., 68  
 — — use in glass-making, II., 248, 249  
 — salts, I., 351-352  
 — sulphate, I., 351  
 — sulphide, I., 117, 235, 351, 352  
 — tannate, I., 175  
 Barrow, brick, II., 207  
 Baryta, use as glaze, II., 162  
 — use in glass, II., 248, 253  
 Barytes, I., 351  
 Basic bricks, II., 233  
 — cinder, II., 32  
 — phosphate, II., 32  
 — slag, II., 32-33  
 — — statistics, II., 47  
 — superphosphate, II., 31  
 Basins, II., 177  
 Batchelor kilns, II., 103  
 Bauxite, I., 473; II., 39, 55  
 — bricks of, II., 233  
 — manufacture of aluminium sulphate from, II., 52, 53  
 — nitrogen absorption by, I., 473, 474  
 Baum's classifier, I., 14  
 Bay salt, I., 268  
 Bead glass, II., 252  
 Beans, nitrogen absorption by, I., 428  
 Becker's electric furnace, II., 255  
 Beehive oven, I., 51  
 Beeswax, use as polish, II., 44  
 Beet sugar molasses, cyanide from, I., 488-489  
 — — — potassium from, I., 338  
 — — — waste, I., 454

- Beilby cyanide process, I., 485, 486  
 Beleek porcelain, II., 186  
 Belite, II., 110, 111, 125  
 Bell-Colemann machine, I., 81  
 — electrolytic cell, I., 375-377  
 Belt elevator, II., 89  
 Bengal ruby mica, II., 288  
 — white mica, II., 288  
 — yellow mica, II., 288  
 Benker and Millberg's sprays, I., 233,  
 234  
 Bennis stoker, I., 37, 39  
 Benzene, cement resisting, II., 137  
 — compositions insoluble in, II., 137  
 — hydrogen from, I., 115  
 — recovery, I., 52, 55  
 — tight joints, II., 137  
 Benzoates, disinfecting properties of, II., 5  
 Benzoic acid, disinfecting properties of,  
 II., 5  
 — — from hippuric acid, I., 428  
 — — germicidal value of, II., 3  
 Benzoin, use in polishes, II., 421  
 Benzol—see *Benzene*  
 Benzoyl sulphonic imide, II., 6  
 Bergius process, I., 111  
 Berlin blue, I., 493-494  
 — porcelain, II., 184  
 Beryl, II., 63  
 Beryllium aluminium silicate, II., 63  
 — nitrate, in incandescent mantles, II.,  
 307, 308  
 Beta naphthol, disinfecting properties of,  
 II., 4  
 — — sulphonates, disinfecting properties  
 of, II., 5  
 — rays, II., 385  
 Betaine, I., 489  
 Beth dust collector, II., 107, 108  
 Beton, II., 117  
 Bichromate, colouring glass by, II., 269  
 — potassium, I., 339  
 Bicarbonates, in water, I., 172, 173  
 — potassium, I., 339  
 — sodium, I., 313, 318, 327, 328; see  
*Sodium bicarbonate*  
 Billiter-Leykam cell, I., 372, 373  
 Billiter-Siemens cell, I., 372, 373  
 Binders, briquettes, I., 21  
 Birkeland-Eyde-furnace, I., 443-444  
 — — process, I., 436, 441, 443  
 Bischofite, I., 329  
 Bismuth, resemblance to polonium, II.,  
 392  
 Biscuit ware, II., 176  
 Bitten, II., 127  
 Bituminous coals, I., 5  
 Black ash, furnaces for, I., 291, 292  
 — — lixiviation of, I., 293  
 — — liquors, evaporation of, I., 294  
 — glass, II., 269  
 — lead, use as polish, II., 421  
 — overglaze, II., 189  
 — oxide of manganese, I., 360  
 — Sea, composition of, I., 263  
 Blacks, in pottery, II., 165  
 Blackett washers, I., 13  
 Blacking, boot, II., 421  
 Blake stonebreaker, II., 92  
 Blake-Denison automatic weigher, II.,  
 108  
 Blake-Marsden crusher, II., 92  
 — — stone-breaker, II., 414  
 Blast furnace, I., 40, 41  
 — — gas, I., 136  
 — — ammonia, recovery from, I., 454,  
 462  
 — — slag, II., 83, 111, 131, 252  
 Bleaching, I., 392, 393, 394  
 — by bleaching powder, I., 392, 393  
 — by perborates, I., 426  
 — by percarbonates, I., 426  
 — by hydrogen peroxide, I., 423  
 — by sodium hypochlorite, I., 396  
 — by sodium peroxide, I., 421  
 — electrolytic, I., 396-402  
 — liquors, I., 396  
 — powder, I., 359, 391-396  
 — — composition of, I., 391, 392  
 — — constitution of, I., 392  
 — — disinfecting properties of, I., 396.,  
 II., 8, 9  
 — — electrolytic, I., 360, 379, 395  
 — — manufacture of, I., 299, 393-395  
 — — packing of, I., 394  
 — — statistics, I., 359, 360, 374  
 — — valuation of, I., 396  
 — — water purification by, I., 167  
 — — yield of, I., 394  
 Bleeding, arresting of, I., 422  
 Blend roasting furnace, I., 283  
 Bleriot lamp, II., 334  
 Blind roasters, I., 281, 282  
 Blocks, flooring, II., 227  
 — partition, II., 227  
 — paving, II., 197, 198  
 Blood meal, II., 39  
 Blomstrandite, II., 370  
 Blowing of cement, II., 108  
 Blown glass, II., 251, 256  
 Blue asbestos, II., 282  
 — clays, II., 159, 160  
 — glass, II., 269  
 — lias lime, analysis of, II., 81

- Blue printing, I., 493  
 — tungsten bronzes, II., 349  
 Blueing of clays, II., 160, 164  
 Blunger, II., 166, 167  
 Body of earthenware, II., 165-169  
 — of porcelain, II., 186  
 — of pottery, II., 158  
 Bohemian glass, II., 242, 243, 251  
 Boiler composition, I., 347  
 — compounds — see *Anti-incrustators, Scale, etc.*  
 — lagging, II., 136  
 Boilers, heating by surface combustion, I., 59, 61  
 Boiler scale, I., 172, 173, 174, 175  
 — water, I., 172, 173  
 Boiling test for cement, II., 124  
 Bolognian phosphorus, I., 352  
 Bombs, incendiary, II., 71, 72  
 Bonds, for grinding wheels, II., 415  
 Bone ash, II., 184, 425  
 — charcoal, II., 423  
 — china, II., 185, 187  
 — combustion process, I., 57  
 — manures, II., 32, 33  
 — meal, II., 32, 33  
 — porcelain, II., 153  
 — Court combustion, I., 60  
 Bone, ammonia from distillation of, I., 455  
 — crushing of, II., 33  
 — dissolved, II., 32  
 — distillation of, II., 423  
 — phosphorus in, II., 423  
 — steamed, II., 33  
 — statistics, II., 47  
 — use as manure, II., 32, 33  
 Boot polishes, II., 421  
 Boracic acid, II., 162  
 — — in glass, II., 249  
 Boracite, I., 329, 331, 355  
 Borate glasses, II., 242, 244, 249  
 Borax, I., 356-358  
 — action on plaster of Paris, II., 117  
 — disinfecting properties of, II., 11  
 — uses of, I., 357; II., 157, 162, 249  
 — varieties of, I., 356, 357  
 Borax Consolidated Co. Ltd., I., 356  
 — glass, I., 357; II., 249, 253  
 Bordeaux mixture, I., 206; II., 17  
 Boric acid, I., 332, 355, 356  
 — — disinfecting properties of, II., 11  
 — — germicidal value of, II., 3  
 — — in enamels, II., 277, 278, 279  
 — — statistics, I., 356  
 — anhydride in glass II., 253  
 Boro-flint glass, II., 242, 249  
 Boron alloys, II., 70, 318  
 Boron compounds, I., 355-358  
 — nitride, ammonia from, I., 474  
 Boronatrocalcite, I., 355, 357  
 Borophosphate glasses, II., 250  
 Borosalicylates, I., 357  
 Borosilicate glass, II., 246  
 — glasses, II., 251  
 — — II., 265  
 Bottle glass, II., 242, 243, 252  
 — — brown, II., 253  
 — — champagne, II., 242, 243  
 — — green, II., 253  
 — green glass, II., 269  
 — kiln, II., 103  
 — lutes, II., 137  
 — machines, II., 257, 258  
 Bottling machines for aerated waters, I., 196, 197  
 Boulder clay, II., 145  
 Boulet briquettes, I., 24  
 Boulevard carboniser, I., 307  
 Bowl making machines, II., 172  
 Bradley-Craven brick machine, II., 209  
 — three-roll mill, II., 26, 96  
 Brass furnaces, I., 40  
 Braunkohle, I., 4  
 Brazil monazite deposits, II., 292  
 Brewed aerated waters, I., 199  
 Brick clays, II., 145  
 — earths, II., 145  
 Bricks, II., 199-222  
 — alumina, II., 233  
 — baked, II., 214  
 — barrow for, II., 212  
 — basic, II., 233  
 — bauxite, II., 233  
 — buff, II., 203  
 — building, II., 199, 234  
 — burning of, II., 214  
 — chromite, II., 233  
 — common, II., 199  
 — crushing strength of, II., 200  
 — drying of, II., 212-214  
 — facing, II., 199  
 — fireclay, II., 231  
 — fire-proof, II., 229  
 — furnace, II., 229  
 — engineering, II., 200  
 — glazed, II., 157, 200  
 — improvements in manufacture, II., 222  
 — iron in, II., 202  
 — kilns for, II., 214-222  
 — lime in, II., 202  
 — lime sand, II., 131, 223, 224  
 — literature, II., 199  
 — machines for, II., 209, 210, 211  
 — magnesia, II., 233

- Bricks, magnesium aluminate, II., 233  
 — metallurgical, II., 229, 233  
 — neutral, II., 233  
 — open air driers, II., 213  
 — plastic, plant for, II., 209  
 — raw materials for, II., 201  
 — red, II., 202  
 — refractory, II., 200  
 — requirements of, II., 200  
 — resistance of, in furnaces, II., 229, 230  
 — sand-lime, II., 201  
 — semi-dry process, II., 210-212  
 — silica, II., 232  
 — steel furnace, II., 233  
 — stiff-plastic process, II., 208-210  
 — stock, II., 199  
 — testing, II., 198  
 — tunnel driers for, II., 212-214  
 — vitrified, II., 214  
 — weathering of, II., 234  
 — white, II., 203  
 — zirconia, II., 233  
 Brimstone acid, I., 206  
 Brine, composition of, I., 265, 304  
 — pumping, I., 263  
 — purification of, I., 270  
 — saturation with ammonia, I., 304  
 — wells, I., 263-265  
 Brinn's oxygen process, I., 105, 352  
 Briquettes, I., 19  
 — cement, II., 99  
 — manufacture, I., 21, 22, 23, 24  
 British Oxygen Co., I., 100  
 — thermal unit, I., 45  
 Broadbent stone-breaker, II., 92  
 Bröggerite, II., 369  
 Bromidine, II., 10  
 Bromine, I., 403-406  
 — disinfectant properties, II., 10  
 — electrolytic process for, I., 405  
 — manufacture of, I., 264, 332, 403, 404, 405  
 — occurrence of, I., 403  
 — plant for, I., 404, 405  
 — properties of, I., 405  
 — purification of, I., 405  
 — statistics of, I., 406  
 — uses of, I., 406  
 — water purification of, I., 168  
 Bromine salt, I., 406  
 — water, germicidal value of, II., 3  
 Bromium, solidification, I., 406  
 Bronze, magenta, II., 349  
 — powders, II., 349  
 Brookite, II., 323  
 Broughton mixer, II., 116  
 Brown glass, II., 269  
 Brown overglaze, II., 189  
 Burnett's fluid, II., 16  
 — tower chamber, I., 227, 228  
 — uranium dyes, II., 373  
 Brühler glass bottle machines, II., 257  
 Brunck oven, I., 54  
 Brunswick black, II., 421  
 Bucket pumps, I., 233  
 Bueb's cyanide process, I., 488-489, 492, 493  
 — — recovery from coal-gas, I., 493  
 Bühler continuous kilns, II., 218, 221  
 Buff bricks, II., 203  
 — burning clays, II., 149, 160  
 Buffing, II., 420  
 Building bricks, II., 199, 222  
 — lime, II., 81  
 Bulbs, glow lamp, II., 352-353  
 Bungs, II., 177  
 Burkheiser process, I., 205  
 Burner, coal dust, I., 42; II., 102  
 Burner, gas, I., 221  
 — oil, I., 26  
 — pipes, I., 220  
 Burnt iron oxide, I., 213  
 Butter, use of sterilised water, I., 172  
 Butt-welding, thermite, II., 71  
 Buxton lime, analysis of, II., 81
- ### C
- Cadmium, alloys, II., 318  
 — borotungstate, I., 357  
 Cainite, I., 329; see *Kainite*  
 Cairngorm, II., 63  
 Calcarone sulphur process, I., 201  
 Calcareous cement industry, II., 77-125  
 Calcium, absorption of hydrogen by, I., 116  
 — aluminate, II., 109, 110, 111  
 — bicarbonate, I., 172, 173  
 — carbide, I., 112, 472, 475, 481; II., 409-411  
 — — absorption of nitrogen by, I., 477  
 — — action of water on, I., 479  
 — — decomposition by carbon dioxide, I., 480  
 — — decomposition by carbon monoxide, I., 480  
 — — literature of, II., 399  
 — — manufacture of, I., 475  
 — — properties of, II., 411  
 — — residues, manurial value of, II., 41  
 — — statistics, II., 411  
 — — uses of, II., 411  
 — carbonate, burning to lime, II., 78-81

- Calcium carbonate in glass, II., 253  
 — — heat of decomposition, I., 317, 320  
 — — properties of, I., 341  
 — — solubility of, I., 341  
 — — tension of dissociation, I., 341  
 — — use as manure, II., 41  
*Calcium chloride*, I., 326, 327  
 — — chlorine from, I., 366  
 — — compound with ammonia, I., 467  
 — — hydrochloric acid from, I., 366  
 — — limiting amount in water for fish, I., 192  
 — — nitrogen absorption by, I., 477, 479  
 — — properties, I., 341, 342  
 — — removal from water, II., 60  
 — — solubility of, I., 342  
 — — specific gravity of solutions, I., 342  
 — — uses, I., 79, 341, 342, 366, 477, 479  
*Calcium cyanamide*, I., 107, 429, 449, 475-481; II., 411  
 — — ammonia from, I., 472  
 — — analysis of, II., 38  
 — — literature, II., 399  
 — — manufacture of, I., 475-477  
 — — manufacture of cyanides from, I., 490, 491  
 — — manurial value of, II., 37  
 — — uses of, I., 480, 481; II., 37  
 — ferrocyanide, I., 492, 493  
 — fluoride, I., 413, 415; II., 51  
 — — in glass, II., 253  
 — — in phosphates, II., 28  
 — — nitrogen absorption by, I., 477, 479  
 — hydride, II., 68  
 — — action of aluminium on, II., 69  
 — — hydrogen from, I., 116  
 — — reduction by, II., 391  
 — hypochlorite, I., 391, 392, 395  
 — — disinfecting properties of, II., 8-9  
 — — pure, I., 395  
 — nitrate, I., 210, 434, 435, 447  
 — — ammonium nitrate from, I., 435  
 — — manurial value of, II., 36-37  
 — nitride, I., 474  
 — oxide, I., 341; see *Lime*  
 — permutite, II., 60  
 — peroxide, I., 167, 422; II., 7  
 — phosphate, II., 21, 23, 28, 269  
 — potassium ferrocyanide, I., 492  
 — salts, I., 341-342  
 — — precipitation of, I., 270  
 — — removal from water, II., 60  
 — — use as manure, II., 41  
 — silicate, II., 84, 244  
 — — stone, II., 130  
 — sulphate, I., 175, 345-349  
 — — analysis of, I., 348  
*Calcium sulphate* in water, I., 173, 174  
 — — limiting amounts in water for fish, I., 192  
 — — removal from water, I., 178  
 — — setting of, I., 347, 348  
 — — solubility of, I., 270  
 — sulphide, I., 293, 294  
 — sulpho-cyanide, I., 495  
 — vanadate, II., 376  
*Caliche*, I., 431; see *Sodium nitrate*  
 — iodine in, I., 407  
*Callow*, II., 203  
*Calorie*, I., 45  
*Calorific intensity*, I., 11, 46  
 — power, I., 8, 10, 45, 123  
 — — from chemical constitution, I., 10  
 — — of gases, I., 123, 126, 128, 134  
 — — of fuels, I., 10  
*Calorimeters*, I., 8  
*Cameos*, II., 262  
*Canadian asbestos*, II., 282  
 — mica, II., 286, 288  
 — uranium ores, II., 370  
*Cancer treatment by radium*, II., 396-397  
*Cannel coals*, I., 6  
*Carbide, calcium*, I., 472, 475; II., 409-411; see also *Calcium carbide*  
*Carbo-corundum*, II., 419  
*Carbolic acid*, II., 20  
 — — germicidal value of, II., 1-3  
 — — coefficient, II., 1-3  
 — — dips, II., 20  
*Carbon, action on water*, I., 112  
 — calorific intensity of, I., 11  
 — heat evolved by burning, I., 29  
 — dioxide, I., 139 *et seq.*  
 — — absorption of ammoniacal brine by, I., 306, 309  
 — — amount in ammonia soda plant gases, I., 320  
 — — amount in lime-kiln gases, I., 320  
 — — amounts in water injurious to fish, I., 192  
 — — disinfecting properties of, I., 199; II., 11  
 — — dissociation temperature of, I., 45  
 — — for aerated water, I., 196, 197  
 — — from beer, I., 141  
 — — from carbonates, I., 141  
 — — from exhaust gas, I., 142  
 — — from fermentation, I., 141  
 — — from furnace gases, I., 142  
 — — from lime kilns, I., 317, 318, 320  
 — — from lime stone, I., 141  
 — — heat of formation, I., 45  
 — — industry of, I., 139

- Carbon dioxide, influence on ammonia  
 content of brine, I., 306  
 — — latent heat of evaporation, I., 80  
 — — liquid, I., 142  
 — — manufacture, I., 140 *et seq.*  
 — — natural, I., 130, 131  
 — — occurrence, I., 139  
 — — pressure of saturation, I., 196, 197  
 — — production of, I., 61  
 — — properties of, I., 103, 139  
 — — purification of, I., 141  
 — — snow, I., 143, 144  
 — — solid, I., 143  
 — — tension of vapour, I., 79, 143  
 — — use in ammonia soda process, I.,  
 144  
 — — use in hardening steel, I., 144  
 — — use in raising sunken ships, I., 144  
 — — use in refrigerating agent, I., 78,  
 79, 144  
 — — vapour tension of, I., 79, 143  
 — disulphide, I., 257-258  
 — sulphocyanide from, I., 495  
 — transport of, I., 258  
 — uses of, I., 258  
 — filaments, II., 353-355  
 — — efficiency of, II., 366  
 — — lamps, 351-355  
 — monoxide, I., 112, 119, 124  
 — — boiling point of, I., 112  
 — — formation of, I., 120  
 — — heat of formation, I., 45  
 — — hydrogen from, I., 113  
 — — poisoning by, I., 121  
 — — production of, I., 102  
 — — properties of, I., 103, 120  
 — — temperature of ignition, I., 45  
 — tetrachloride, II., 6  
 Carbonates in water, I., 174  
 Carbonic acid, I., 139; see *Carbon  
 dioxide*  
 Carborundum, II., 400-403, 414, 415  
 — amorphous, II., 401-402  
 — decomposition of, II., 401, 402, 404  
 — fire sand, II., 401  
 — furnaces for, II., 400-402  
 — literature, II., 399  
 — manufacture, II., 400-402  
 — properties of, II., 402  
 — statistics, II., 403  
 — temperature of formation, II., 401-402  
 — uses of, II., 402, 403, 418  
 Carboys, II., 260  
 Carmine overglaze, II., 189  
 Carnallite, I., 329, 330, 335; II., 127  
 — potassium chloride from, I., 336  
 — use as manure, II., 41  
 Carnotite, II., 369, 370, 371, 375, 389,  
 390, 398  
 Carolina monazite deposits, II., 292  
 Caros acid, I., 424  
 Carter's disintegrator, II., 26-27  
*Carthamus tinctoris*, II., 420  
 Cascade system, I., 236  
 Case hardening, I., 108, 481  
 Cassius purple, colouring pottery with,  
 II., 165  
 Casting earthenware, II., 172  
 — porcelain, II., 187  
 — sanitary ware, II., 195  
 Castner cyanide process, I., 486, 487  
 Castner-Kellner cell, I., 373, 374, 375  
 Castor oil meals, use as manure, II., 38  
 Catalase, II., 7  
 Catalysts, I., 240, 363, 448, 449, 469-471,  
 474; II., 320, 373, 381, 405  
 — cerium, II., 320  
 — for promoting union of sulphur dioxide  
 and oxygen, I., 240  
 — formation of ammonia by, I., 469-471  
 — uranium oxide, II., 373  
 — vanadium, II., 381  
 Catalytic agents, I., 240; see *Catalysts*  
 — oxidation of hydrochloric acid, I., 363  
 — platinum, poisoning of, I., 243  
 — poisons, I., 240, 241  
 Catechol, disinfecting properties of, II., 4  
 Cathode ray tubes, II., 274  
 Caustic ammonia, I., 463-465  
 — potash—see *Potassium hydroxide*  
 — soda—see also *Sodium hydroxide*  
 — amount made by electric current,  
 I., 367, 368, 374  
 — — concentration of, I., 378, 379  
 — — decolorisation of, I., 296  
 — — electrolytic, I., 296, 297, 360, 367-  
 379  
 — — energy required to produce, I., 368  
 — — from black ash liquors, I., 295  
 — — manufacture of, I., 295, 296  
 — — packing of, I., 296  
 — — statistics, 289, 379  
 — — strength of, I., 297  
 — — yield of per H.P. by electrolysis,  
 I., 370  
 Ceiling plaster, II., 118  
 Celestine, I., 353  
 Celite, II., 125  
 Cell, Aussig-Bell, I., 376, 377  
 — Bell, I., 375, 376  
 — Castner-Kellner, I., 374  
 — Lederlin and Corbin, I., 387, 388  
 — mercury, I., 375  
 — Rhodin, I., 375

- Cell, Solvay-Kellner, I., 375  
 Cellarius condensers, I., 276, 277, 284  
 Cells, electrolytic, I., 368-377  
 Cellulose, action of water on, I., 111  
 Cement, II., 133, 134; see also *Sodium silicate*  
 — acid resisting, II., 135-137  
 — American natural, II., 86  
 — analysis of, II., 119-125  
 — blowing off, II., 108  
 — boiling test, II., 124  
 — burning to clinker, II., 99  
 — classification, II., 77, 78  
 — clays, II., 145  
 — clinker, storing of, II., 105  
 — constituents of, II., 125  
 — crushing strength of, II., 122  
 — dental, II., 137  
 — dry process for, II., 92  
 — fineness of, II., 121  
 — flour, II., 98  
 — French quick-setting, II., 86  
 — Grappier, II., 82  
 — grinding, II., 84, 93-98, 106-107  
 — industry of, II., 77-125  
 — iron ore, II., 112  
 — iron Portland, II., 85  
 — Keene's, II., 117, 130  
 — kilns for, II., 99-105  
 — la Farge, II., 82  
 — Louisville, II., 86  
 — Mack's, II., 117  
 — magnesium oxychloride, II., 130  
 — marble, II., 136  
 — medina, II., 85  
 — microscopic examination, II., 125  
 — miscellaneous, II., 135-137  
 — mixing, II., 84, 88  
 — mortar, II., 117-119; waterproofing of, II., 118  
 — natural, II., 85-87  
 — natural Portland cement, II., 86  
 — nature of, II., 77  
 — packing, II., 107-108  
 — Parker's, II., 85  
 — parian, II., 117  
 — Passow's slag, II., 84  
 — plaster, II., 113-117, 118  
 — Portland, II., 109, 112; see *Portland cement*  
 — ponilly, II., 86  
 — puzzuolanic, II., 83, 85  
 — rock, II., 86  
 — Roman, II., 85  
 — rosendale Portland, II., 86, 87  
 — sand, II., 113  
 — Scott's selenitic, II., 83  
 Cement, semi-wet, II., 89  
 — setting of, II., 110  
 — setting time of, II., 105, 106, 122, 123  
 — sidero, II., 112  
 — slag, II., 83-85  
 — Snelus, II., 85  
 — Sorel, II., 130, 415  
 — soundness of, II., 124  
 — specific gravity determination, II., 120  
 — storing, II., 107-108  
 — super, II., 112, 119  
 — tensile strength of, II., 121  
 — Vassy, II., 86  
 — wet process for, II., 88  
 — white Portland, II., 112  
 Cementkote, II., 118  
 Cementing powder, I., 481  
 Centrifugal acid pumps, I., 232  
 — mills, II., 414  
 Centrifugation, dust removal by, I., 220  
 Ceramic industry, II., 151-227  
 Cerebros salt, I., 268  
 Ceresit, II., 118  
 Ceria, catalytic, I., 449, 471; II., 320  
 — separation of, II., 300-302, 319  
 Cerium, II., 291 *et seq.*  
 — catalytic, I., 471; II., 320  
 — estimation of, II., 321  
 — industry, II., 291  
 — removal from thorium, II., 300-302  
 — test for, II., 303  
 — uses of, 316-321  
 Cerium carbide, II., 319  
 — — filaments, II., 366  
 — earth metals, uses, II., 320  
 — fluoride, II., 318  
 — iron alloys, II., 316, 372  
 — nitrate, uses, II., 319  
 — nitride filaments, II., 366  
 — oxalates, solubility of, II., 301  
 — oxide, effect on luminosity of mantles, II., 303, 304  
 — sulphate, solubility of, II., 301  
 — titanofluoride, II., 318-319  
 Cerite, II., 316, 369  
 Cerous compounds, use in dyeing, II., 320  
 Cesspools, I., 186, 187  
 Ceylon monazite, II., 293  
 Chabazite, II., 59  
 Chalcedony, imitation, I., 349  
 Chalk, II., 78, 414  
 — in clay, II., 202  
 — use as abrasive, II., 419  
 Chamber acid, I., 223, 235, 248  
 — — oxides of nitrogen in, I., 235

- Chamber acid, sulphuric acid process, I., 206, 222 *et seq.*  
 — — — chemical control of, I., 235  
 — — — remarks on, I., 224  
 Chambers, Brown tower, I., 226  
 — construction of, I., 225 *et seq.*  
 — corrosion of, I., 225, 230  
 — Falding's, I., 227  
 — intensive working of, I., 224, 226  
 — life of, I., 225  
 — Moritz, I., 226  
 — replacement of steam jets by water sprays in, I., 233  
 Chamois leather, polishing by, II., 420  
 Champlévé enamel, II., 278  
 Champagne bottle glass, II., 242, 243  
 Chance-Claus process, I., 204, 210, 298, 461  
 Charcoal, I., 16, 17  
 — decolorising, I., 491  
 — properties of, I., 18  
 — temperature of ignition, I., 44  
 Chaux de Theil, II., 82  
 Chemical reactions, effect of pressure on, I., 364  
 Chemical stoneware, II., 195-196  
 Chest, II., 415  
 Cheshire salt, I., 263  
 Chile nitrate beds, I., 431, 432, 433  
 — saltpetre, I., 210, 431 *et seq.*  
 — — iodine in, I., 407  
 — — nitric acid from, I., 437  
 Chimneys, glass for, II., 265  
 China, bone, II., 185, 187  
 — English, II., 185, 187  
 — clays, II., 145, 160, 166, 183  
 — — aluminium sulphate from, II., 54  
 — stone, II., 184  
 — ware, II., 153  
 Chinese porcelain, II., 186  
 Chinosol, germicidal value of, II., 3  
 Chloramine, II., 8  
 Chlorates, I., 385-388  
 — current for, I., 388  
 — old process for, I., 385, 386  
 — statistics, I., 359, 360  
 — use in glass making, II., 248  
 Chloride of lime—see *Bleaching powder*  
 Chlorine, I., 359-383  
 — action on iron, I., 381  
 — amount evolved by electric current, I., 367, 370, 374  
 — available, I., 391, 392, 396  
 — disinfecting properties of, II., 3, 8-9  
 — estimation of, I., 194  
 — from magnesium chloride, I., 365, 366  
 Chlorine in water, I., 159, 160, 173  
 — liquid, I., 381-383  
 — poisoning by, I., 393, 394  
 — production of, by diaphragm process, I., 369  
 — properties of, I., 379  
 — removal of, I., 168, 259, 393, 396  
 — stills for, I., 360, 361, 363; II., 9  
 — test for free, II., 9  
 — uses of, I., 381  
 — water, germicidal value, II., 3  
 — water, purification of, I., 167, 168  
 — weight liberated by electric current, I., 367, 370, 374  
 — yield of per H.P. by electrolysis, I., 370  
 Chloroform, II., 6  
 Chloros, II., 9  
 Chlorosulphonic acid, I., 424  
 Chromate, potassium, I., 339  
 Chrome alum, II., 56  
 — — injurious amount of water, I., 192  
 — aventurine glass, II., 269  
 Chromic acid, disinfecting properties of, II., 12  
 — oxide, colouring with, II., 164, 165  
 Chromite bricks, II., 233  
 Chromium alloys, II., 70  
 — colouring glass by, II., 269  
 — filaments, II., 366  
 — metallic, II., 68-69  
 — steel, II., 69  
 — oxide, catalytic, I., 240  
 Chrysoberyl, II., 63  
 Chrysotile asbestos, II., 282, 283, 284  
 Cigar lighters, II., 316-319, 372  
 Ciment grapier, II., 82  
 Cisterns, cements for, II., 136  
 Citric acid, II., 5  
 Clarax, I., 426  
 Clark's mill, II., 89, 90  
 Claude process, I., 84, 85, 89, 113  
 — — advantages of, I., 91  
 — — nitrogen plant, I., 96, 479  
 — — oxygen plant, I., 96  
 Claus kiln, I., 210  
 — sulphuretted hydrogen furnace, I., 219, 220  
 Clay, II., 139-150; see also *Kaolin and China clay*  
 — absorption of dyes by, II., 140  
 — action of heat on, II., 140  
 — adobe, II., 144  
 — alluvial, II., 144  
 — alum for, II., 54, 55  
 — analysis of, II., 149, 150  
 — ball, II., 144, 159, 160, 166, 194



- Clay, boulder, II., 145  
 — brick, II., 145, 201  
 — blue, II., 159  
 — buff-burning, II., 149, 160  
 — cement, II., 145  
 — chalk in, II., 202  
 — chemical constitution of, II., 139-142  
 — China, II., 54, 145, 160, 166, 183  
 — connection between composition and refractory properties, II., 230, 231  
 — consistency of, II., 168  
 — crucible, II., 146  
 — earthenware, II., 159  
 — effect of heat on, II., 160  
 — electrical osmose of, II., 143  
 — expression of, II., 208  
 — fire, II., 146  
 — flux for, II., 143  
 — fusing point of, II., 231  
 — impurities in, II., 143  
 — jollying, II., 171  
 — literature, II., 139  
 — melting point of, II., 230, 231  
 — moulding, II., 170, 206  
 — pipe, II., 147  
 — plasticity of, II., 142, 169  
 — puddling of, II., 147  
 — purification of, II., 143  
 — quarrying of, II., 203  
 — red-burning, II., 147, 160  
 — refractory, II., 147, 230  
 — resistance to heat, II., 229, 230  
 — sagger, II., 147  
 — shaping of, II., 169-174  
 — shrinkage of, II., 142, 144  
 — softening points of, II., 230, 231  
 — stiff-plastic process, II., 208  
 — surface, II., 148  
 — tempering of, II., 205  
 — tender, II., 148  
 — throwing, II., 170  
 — turning, II., 170  
 — varieties of, II., 144-149  
 — vitrifiable, II., 149  
 — washing of, II., 203, 204  
 — wire-cut process, II., 208  
 — yellow, II., 149  
 Clerite, II., 369  
 Clinker blocks, II., 130  
 — cement, II., 105  
 Cloisonné enamel, II., 278  
 Clover, nitrogen fixation by, I., 428  
 Coal, I., 5-16  
 — action on water, I., 111, 124  
 — ash of, I., 7  
 — calorific intensity of, I., 11  
 — — power of, I., 8, 10  
 Coal, chemical constitution of, I., 6  
 — classification of, I., 6  
 — cleaning of, I., 12-16  
 — coking test for, I., 10  
 — for firing earthenware ovens, II., 177  
 — ignition temperature of, I., 44  
 — impurities in, I., 7  
 — Nigerian, I., 21  
 — nitrogen, content of, I., 453  
 — small, I., 7  
 — spontaneous combustion of, I., 19  
 — temperatures attainable by, I., 46  
 — valuation of, I., 7, 11  
 — varieties of, I., 5-6  
 — washing of, I., 12  
 — water evaporating power, I., 45  
 — dust burners, I., 9, 42; II., 102  
 — — furnaces, I., 9  
 — gas, ammonia from, I., 454  
 — — ferrocyanide from, I., 491-493  
 — — hydrocyanic acid in, I., 492  
 — — sulphocyanide recovery from, I., 494, 495  
 — tar disinfecting liquids, II., 4  
 Coalite, I., 19  
 Cobalt, colouring glass by, II., 269  
 — oxide, II., 189  
 — — blueing with, II., 160, 164  
 — — colouring with, II., 164, 269  
 — sulphate, catalytic, I., 240  
 Coffee-mill grinding machine, II., 86, 92  
 Cogswes cooler, I., 307  
 Coke, I., 18, 19, 52  
 — ammonia from, I., 454  
 — sulphur removal from, I., 19  
 — water evaporative power, I., 45  
 — oven gas, ammonium sulphate from, I., 462  
 — ovens, I., 41, 51  
 — — by-product recovery, I., 55  
 Coking coals, I., 6  
 — test for coal, I., 10  
 Cold, artificial, uses of, I., 77  
 — drying gas by, I., 77  
 — by evaporation of volatile liquids, I., 80  
 — by expansion of gases, I., 84  
 — air machines, I., 81  
 Cole's arctic machine, I., 81  
 Colemanite, I., 355, 356, 357  
 Collodionising of gas mantles, II., 311-313  
 Colloidal theory of clays, II., 142, 143  
 — tungsten filament, II., 359  
 Colour mill, II., 181  
 Coloured glass, II., 251, 270  
 Colours, earthenware, II., 163-165  
 — enamel, II., 278

- Colours, glazing, II., 188-189  
 — porcelain, II., 188-189  
 — uranium, II., 373  
 Columbite, II., 337, 338, 369  
 Combustion, air required for, I., 46  
 — chemistry and physics of, I., 44  
 Common bricks, II., 199  
 — salt, I., 268  
 Compo, II., 98  
 Composite glaze, II., 195  
 Compound mills, II., 97, 98  
 Compressing engines, I., 320  
 Compression machines for ice-making, I., 77  
 Concentrated ammonia water, I., 463  
 — crystal soda, I., 328  
 — oil of vitriol, I., 248  
 Concrete, II., 117, 118, 129  
 — armoured, II., 118  
 — reinforced, II., 118  
 — waterproofing of, II., 118, 119  
 Condyl's fluid, II., 7  
 Conferoid growth, I., 168  
 Contact process for sulphuric acid, I., 206, 239-246  
 — substances, I., 363; see *Catalysts*  
 Continuous kilns, II., 217  
 Cooker, continuous, II., 35  
 Coolers, cement, II., 102, 103  
 — Cogswes, I., 307  
 — Mosser, II., 203  
 — shaking, II., 103  
 — Smidth, II., 102  
 Cooling by gaseous expansion, I., 80, 84  
 Coppée ammonium sulphate plant, I., 460, 463, 464  
 — oven, I., 51, 52  
 Copper, alloys, II., 70  
 — disinfecting properties of, II., 14  
 — castings, titanium in, II., 327  
 — ores, I., 214  
 — oxide, II., 189, 269  
 — phosphide, II., 426  
 — pyrites, I., 206, 217  
 — ruby glass, II., 267, 268  
 — salts, antiseptic properties of, II., 14, 17  
 — sulphate, germicidal value of, II., 3, 14, 17  
 — — use as insecticide, II., 17  
 — — water purification by, I., 168  
 — titanium alloys, II., 327  
 — vanadium alloys, II., 381  
 Coprolites, II., 21, 23  
 Corichrome, II., 328  
 Cornish stone, II., 157, 161, 166, 184  
 Cornu-Chatelier pyrometer, I., 69  
 Cornwall mines, II., 389  
 — pitchblende deposits, II., 370  
 Corrosion of boilers by oils, I., 174, 175  
 — of lead chambers, I., 225, 230  
 Corrosive sublimate, II., 18  
 Corundum, II., 52, 63, 64, 418-419  
 — wheels, II., 415  
 Cotton, use in incandescent mantles, II., 304-305  
 Cottrel electrical dust remover, I., 220  
 Coudres de Varech, I., 408  
 Coulomb, amount of chemical product liberated by, I., 367, 368  
 — definition of, I., 367  
 Counter-current principle, I., 229, 313, 314  
 Crackers, II., 86  
 Crackled ware, II., 189  
 Crazing, II., 189  
 Crenothrix, I., 168  
 Cresylic acid, germicidal value of, II., 3  
 — — uses as disinfectant, II., 4  
 Critical temperature, I., 84  
 Crocodolite asbestos, II., 282  
 Crocus martis, II., 164  
 Crops, rotation of, I., 428  
 Crown glass, II., 250, 251, 252, 260  
 Crucible cements, II., 135  
 — clays, II., 146  
 — furnaces, I., 40, 61, 62  
 — lutes, II., 135  
 Crucibles, manufacture of, II., 232  
 — refractory, II., 333, 405  
 Crushed steel, use as abrasive, II., 419  
 Crusher, Blake-Marsden, II., 92  
 — gyratory, II., 92, 93  
 — rotary, II., 86, 92  
 — Wheeling, forced feed, II., 92  
 Crushing machinery, II., 24, 92, 93  
 — rolls, II., 414  
 — strength of cement, II., 122  
 — tools, II., 414  
 Cryolite, II., 51, 55, 165  
 — in enamels, II., 278  
 — in glass making, II., 250, 269  
 Crystal carbonate, I., 327  
 — glass, II., 253  
 Crystalline glazes, II., 189  
 Crystallisation, connection between and molecular weight, II., 236  
 — of salt, I., 268  
 Crystolon, II., 403, 418  
 Culinary stoneware, II., 195  
 Cullet, II., 250  
 Cummer rotary calciner, II., 115  
 Cup making machine, II., 172  
 Cupolas, I., 40

- Cuprammonium cellulose for incandescent mantles, II., 304  
 Cupric chloride, use as contact substance, I., 363  
 — oxide, colouring with, II., 164  
 — sulphate, use as contact substance, I., 363  
 Cuprous chloride, disinfecting properties of, II., 14  
 — iodide, I., 408, 410, 411  
 Cupro-vanadium, II., 381  
 Curie, definition of, II., 395  
 Curie-Debiegne process of radium extraction, II., 389  
 Cutting tools, II., 414  
 Cyanamide, II., 411  
 — ammonia from, I., 472  
 — calcium, I., 107, 429, 475-481, 490; II., 37, 38; see also under *Calcium cyanamide*  
 — cyanide from, I., 491  
 — furnace, I., 476  
 — industry of, I., 475-481  
 — literature, II., 399  
 — urea from, I., 480  
 Cyanide, I., 429  
 — Beilby process for, I., 485  
 — Erlenmeyer process for, I., 484  
 — from atmospheric nitrogen, I., 490-491  
 — from calcium cyanamide, I., 480, 490, 491  
 — from ferrocyanide, I., 480  
 — from Schlempe, I., 488-489  
 — from sulphocyanides, 487-488  
 — industry of, I., 483-495  
 — iodine, II., 6  
 Cyanide, potassium, I., 483; see also *Potassium cyanide*  
 — Siepermann's process for, I., 485  
 — sodium—see *Sodium cyanide*  
 — statistics, I., 483  
 Cylinders, liquid chlorine, I., 382, 383  
 — hydrochloric acid, I., 278  
 Cymophane, II., 63
- D**
- Dairies, water for, I., 183  
 Dakin's hypochlorite disinfectant, I., 402  
 Davidsen tube mill, II., 96  
 De Lambilly's process, I., 471  
 Deacon's apparatus for bleaching powder, I., 395  
 Deacon chlorine, bleaching powder from, I., 395  
 Deacon chlorine process, I., 362, 363-365  
 Dead Sea, bromine in, I., 403  
 — — composition of, I., 262, 263  
 Death Valley, I., 356  
 Decolorants for glass, II., 250  
 Decolorisation of sulphuric acid, I., 246  
 Decoration of earthenware, II., 179  
 Delft ware, II., 157  
 Deliming skins, I., 419  
 Della ware, II., 157  
 Dellwik-Fleischer water-gas producer, I., 125  
 Demantoid, II., 63  
 Denitrification, I., 429  
 Denitrifying bacteria, I., 427, 428, 429  
 Dens, superphosphate, II., 30, 31  
 Dental cements, II., 137  
 Dentifrices, I., 423; II., 419  
 Deplinne and Donop's kiln, II., 79  
 Descloizite, II., 375, 377  
 Desmids, I., 168  
 Devil liquor, I., 459  
 Devitrification of glass, II., 236, 240, 243  
 Diabetes, radium treatment of, II., 396-397  
 Dials, luminous watch, II., 397  
 Diamantin, II., 406  
 Diamonds, II., 63, 64  
 — artificial, II., 64  
 — imitation, II., 65, 265  
 — powder of, II., 414  
 — use as abrasive, II., 418  
 Diaphragm process of electrolysis, I., 368-373  
 Diaphragms, porous, I., 114, 115, 368, 370, 371, 372, 419  
 Diastase, II., 7  
 Diatoms, I., 168  
 Diazotisation, I., 436  
 Dibdin's contact beds, I., 187, 189  
 Dicyandiamide, I., 480  
 Didymium, effect on incandescent mantles, II., 300  
 — test for, II., 303  
 — uses of, II., 316  
 Didymium nitrate, use for branding, II., 309  
 Dies for tungsten ware, II., 361  
 Dietzsch kiln, II., 79, 104  
 Dioxogen, II., 7  
 Dippel's animal oil, II., 423  
 Disinfectants, I., 422, 423; II., 1-16  
 — hydrofluoric acid as, I., 419  
 — hypochlorites as, I., 402  
 — oxidising, II., 6  
 — percarbonates, I., 426  
 — testing of, II., 1-3  
 — use of bleaching powder as, I., 396

Disintegration constant, II., 386  
 — series, II., 386  
 Disintegrators, II., 26, 27, 93, 414  
 Dissolved bone compound, II., 32  
 — guanos, II., 42  
 — raw bones, II., 32  
 Distillation of ammonia, I., 312, 313-317  
 — of water, I., 166  
 Dolomitic lime, analyses of, II., 81  
 — limestone, II., 78  
 Dome kiln, II., 103  
 Douglasite, I., 329  
 Doulton's nitric acid condensing plant,  
 I., 439  
 Down-draught kiln, II., 215  
 Dowson gas, composition of, I., 123  
 — suction gas producer, I., 135  
 Dragaging, II., 249  
 Dragon's blood, use in polishes, II.,  
 421  
 Drain-pipes, II., 196  
 Draught in acid plant, I., 231  
 — pipes, I., 220  
 Driers, II., 83, 84  
 — brick, II., 212  
 — rotary, II., 34, 35, 92  
 — steam, II., 34  
 — tunnel, II., 89, 99  
 Drinking water, I., 159  
 — — analysis of, I., 193  
 — — purification of, I., 166 *et seq.*  
 Driwal, II., 118  
 Drops, Rupert, II., 243  
 Drummond's light, I., 117  
 Dry ammonia, I., 467  
 — soaps, I., 426  
 Drying earthenware, II., 173, 174  
 — machines for incandescent mantlewebs,  
 II., 307  
 — plant for slag, II., 83, 84  
 — process for cement, II., 88, 89  
 — stoves, II., 173, 174  
 Ducco furnace, I., 213  
 Duff producers, I., 129  
 Dumesnil kiln, II., 114  
 Dung, use as manure, II., 42, 43  
 Durax glass, II., 265  
 Duriron, I., 236, 249  
 Duron tower system, I., 239  
 Dust collectors, II., 107, 108  
 — firing, I., 42  
 — removal by filtration, I., 220  
 — — from hot gas, I., 220  
 Dwight-Lloyd furnace, I., 210, 216, 217  
 Dyeing, uranium, II., 373  
 — water for, I., 182  
 Dymal, II., 321

## E

Earth, brick, II., 145  
 — fullers, II., 146  
 Earthenware, II., 152-153, 157-181  
 — bodies, II., 165-169  
 — calcareous, II., 157  
 — cements for joining metals to, II., 137  
 — classification of, II., 157  
 — clays for, II., 159  
 — coarse, II., 157  
 — constituents of, II., 158  
 — decoration of, II., 179  
 — drying, II., 173  
 — engobing, II., 172  
 — fine, II., 157  
 — furnaces for, II., 177  
 — glazed, II., 157  
 — glazes for, II., 178-179  
 — machines for, II., 172  
 — mixing materials for, II., 166-167  
 — overglaze decoration of, II., 180  
 — painting of, II., 179  
 — printing of, II., 179  
 — progress in, II., 181  
 — shrinkage of, II., 174  
 — siliceous, II., 158  
 — underglaze decoration of, II., 180  
 East Africa, pitchblende deposits of, II.,  
 370  
 Eau de Javel, I., 359; II., 9  
 — — Labarraque, II., 9  
 Edge-runners, II., 88, 89, 107, 204, 205,  
 414  
 Efficiencies of electrolytic processes, I., 373  
 Effluents, I., 183 *et seq.*  
 — acid treatment of, I., 184, 185  
 — for wool washing, I., 183, 184, 185  
 — limiting amounts of poisonous sub-  
 stances in, I., 192  
 Eggette briquette, I., 24  
 Eggs, acid, I., 233, 277, 278  
 Eisen Portland cement, II., 85  
 Electric lamps, II., 351-367  
 — — carbon filament, II., 351-355  
 — — literature, II., 351, 366, 367  
 — — production of vacuum for, II., 427  
 Electrical discharges, absorption of N  
 by, I., 427  
 — — dust removal by, I., 220  
 — — ozone by, I., 146  
 — energy for electrolysis, I., 368  
 — furnace, alundum, II., 406, 407  
 — — carbide, II., 409-411  
 — — glass, II., 255  
 — — graphite, II., 404-406  
 — — phosphorus, II., 424

- Electrical discharges, production of, II., 399-411  
 — temperature of, II., 411  
 Electrical purification of clays, II., 143  
 Electricity, destruction of bacteria by, I., 158  
 Electrite, II., 419  
 Electro-magnetic separation, II., 168, 295, 296  
 Electro-osmosis, I., 4  
 Electro-smelting, use of graphite electrodes in, I., 406  
 Electrodes, arc-light, II., 320  
 — graphite, II., 405, 406  
 — graphitised, II., 405, 406  
 — tantalum, II., 341  
 Electrolysis, chlorine by, I., 367, 379  
 — diaphragm process for, I., 368-373  
 — hydrogen for, I., 114  
 — graphite electrodes for, II., 406  
 — laws of, I., 367, 368  
 — of alkali chlorides, I., 368  
 — of salt, I., 367 *et seq.*  
 — quicksilver process for, I., 374, 375  
 Electrolytic alkali process, efficiencies of, I., 373  
 — bleaching, I., 359, 396, 402  
 — bromine, I., 405  
 — caustic soda, I., 289  
*Electrolytic cells*, Acker process for, I., 377  
 — — Bell process, I., 375, 377  
 — — Gall and Montlaux, I., 387  
 — — Gibbs, I., 387  
 — — Lederkin-Corbin, I., 387, 388  
 — — porous diaphragms for, I., 368, 370, 371, 372, 419  
 Electrolytic chlorates, I., 385, 386, 387, 388  
 — chlorine, I., 367-379  
 — — water purification by, I., 167, 168  
 — iodine, I., 408  
 — perchlorates, I., 388, 389  
 Elements, decomposition of, II., 384, 385  
 Embossing glass, II., 262  
 Emerald, II., 63  
 Emery, II., 52, 414, 415, 418-419  
 — cloth, II., 417, 418, 419  
 — paper, II., 417, 418, 419  
 — wheels, II., 413-421  
*Emulsators*—see *Emulseurs*  
 Emulseurs, I., 233, 278  
 Enamel cements, II., 136  
 — glaze, II., 136  
 — ware, dangers from, II., 276  
 Enamelling industry, I., 419  
 Enamels, II., 165, 275-279  
 — art, II., 278  
 Enamels, colours for, II., 276, 278  
 — composition of, II., 277, 278, 279  
 — ground coats for, II., 275  
 — painting, II., 279  
 — printing of, II., 279  
 — varieties of, II., 275  
 — zirconia in, II., 334  
 Encaustic tiles, II., 225  
 Engelhardt, I., 3  
 English china, II., 185, 187  
 — sheet glass, II., 242  
 — vanadium deposits, II., 377  
 Engobe, II., 158, 159  
 Epsom salts, I., 139, 141  
 Equalised guanos, II., 42  
 Erlenmeyer's process for cyanides, I., 484  
 Eschelmann's process, I., 245  
 Essen tank, I., 186  
 Estrich gips, II., 116  
 Etching glass, II., 262  
 Ethane, I., 103  
 — ignition temperature of, I., 45  
 Ethylene, properties of, I., 103  
 — temperature of ignition, I., 45  
 Ethylene diamine silver phosphate, II., 16  
 Eucalyptol, germicidal value of, II., 3  
 Eucalyptus, use as disinfectant, II., 5  
 Euxenite, II., 370  
 Evaporation of black ash liquors, I., 299  
 — of caustic alkalis, I., 378, 379  
 Evaporative power of fuel, I., 45  
 Evaporator, Thelen, I., 294  
 — vacuum, I., 269  
 Excess lime process for water, I., 167  
 Exit gases from acid plant, I., 235, 238  
 — — ammonium sulphate plant, I., 459  
 Expansion test for Portland cement, II., 124  
 Expression of earthenware, II., 172  
 External work of gases, refrigerating effect, I., 85
- ## F
- Facing bricks, II., 199  
 Fæces, use as manure, II., 42, 43  
 Fahnejelm's kiln, II., 80  
 Faience, II., 153, 157  
 Faija test, II., 124  
 Falding chamber, I., 227  
 Fans for acid gases, I., 231  
 — instead of chimneys, II., 216, 221  
 Faraday's laws of electrolysis, I., 367  
 Farmyard manure, II., 43  
 Fats, hydrogenation of, I., 110, 118  
 — manufacture from flesh meal, II., 34

- Fats, recovery from effluents, I., 183-185  
 — — — sewage, I., 191  
 Fawcett's brick machine, II., 210  
 Feed water for boilers, I., 172  
 Feld sulphur process, I., 205  
 Feldmann's ammonia still, I., 457  
 Felite, II., 110-111, 125  
 Felspar, II., 161, 184, 191  
 — use in opaque glass, II., 269  
 — weathering of, II., 59  
 Ferberite, II., 343-344  
 Fergusonite, II., 337, 338, 370  
 Ferric ferro cyanide, I., 494  
 — oxide, catalytic, I., 240, 244, 245  
 — — estimation of, II., 119  
 — cyanide, potassium, I., 493  
 Ferrite, sodium, I., 296; II., 50  
 Ferrites, II., 109  
 Ferro-boron, II., 70  
 — chlore treatment of water, II., 8, 9  
 — cyanide, I., 487, 491-493  
 — cyanides from, I., 483, 484-485  
 — from coal-gas, I., 491-493, 495  
 Ferrodur, I., 481  
 Ferro molybdenum, II., 70  
 — nickel, II., 352  
 — silicon, I., 220, 221, 236; II., 407-408  
 — — acid resisting, I., 249  
 — — dangers of, II., 409  
 — — hydrogen from, I., 116, 117  
 — — literature, II., 399  
 — — properties, II., 408, 409  
 — — statistics, II., 409  
 — — storage of, II., 409  
 — — uses of, II., 409  
 Ferrous sulphate, disinfecting properties of, II., 16  
 Ferro-tantalum, II., 341  
 — titanium, II., 70, 325-327  
 — tungsten, II., 347  
 — uranium, II., 372  
 — vanadium, II., 70, 380  
 — zirconium, II., 333, 335  
 Fertiliser Act, II., 43  
 Fertilisers, limits of error, II., 44  
 — plant for, II., 22  
 — statistics, II., 47  
 Féry radiation pyrometer, I., 69, 70, 71,  
 73  
 — spiral pyrometer, I., 71  
 Fibrous plaster, II., 118  
 Figured plate glass, II., 261  
 Filament lamps, II., 351, 366, 367  
 Filaments, carbon, II., 353-355  
 — metallic, II., 355  
 — miscellaneous, II., 366  
 — zirconia, II., 304  
 Filter press, for slips, II., 168  
 Filters, asbestos, II., 284  
 — bicarbonate of soda, I., 310, 311  
 — gas, I., 212  
 — house, I., 161  
 — iron removing, I., 181  
 — mechanical, I., 162 *et seq.*; 310, 311  
 — permutite, I., 179, 180  
 — pressure, I., 166  
 — Reisert's, I., 162  
 — revolving cylinder type, I., 310  
 — Royle's gravity, I., 164  
 — — pressure, I., 165  
 — sewage, I., 188, 189, 190  
 — trickling, for sewage, I., 189  
 Filtration, avoidance by sedimentation, I.,  
 306  
 — sand, I., 161  
 — water, I., 161 *et seq.*  
 Findling quartzite, II., 233  
 Finishing earthenware, II., 172  
 Findlay cell, I., 372, 373  
 Firearms, tungsten in, II., 349  
 Fire-bricks, II., 231, 234, 403, 406; see  
 also *Fire-clay, bricks*, etc.  
 — clay, II., 146, 230  
 — lighters, I., 17; see *Cigar lighters*  
 — places, domestic, I., 39  
 — proof, asbestos preparations, II., 284  
 — — by tungsten salts, II., 349  
 — — cloth, II., 133  
 — — II., 57  
 — sand, II., 401  
 Firestones, II., 316-319  
 Firing earthenware, II., 177  
 Fireworks, I., 354  
 Fish, destruction by effluents, I., 192  
 — oxygen necessary for life, I., 192  
 — guanos, II., 34, 36  
 — manures, II., 34  
 — scrap, II., 34  
 Fishing salt, I., 268  
 Fitzgerald carborundum furnace, II., 401  
 Fixation of nitrogen—see *Nitrogen, fixation of*  
 Fixed ammonium salts, I., 456, 457  
 Flare kiln, II., 79  
 Flash-light powders, II., 315  
 Flashing carbon filaments, II., 354  
 Fleck's phosphorus process, II., 423  
 Flesh meal, II., 34  
 Flint, II., 163, 166  
 — glass, II., 242, 243, 251, 253  
 — packing, I., 231  
 Flooring asbestos, II., 284  
 — blocks, II., 227  
 — composition, I., 366; II., 128

- Flooring plasters, II., 113, 116, 348  
 Flowing glass, II., 190  
 Fluates, II., 119  
 Fluorides, calcium, I., 413, 415; II., 51  
 — ammonium, I., 417  
 — disinfecting properties of, II., 11  
 Fluorine in enamels, II., 278  
 Fluorspar, I., 415; II., 165, 269  
 Flue gas, I., 44, 47  
 Flues, I., 220  
 Fluted sheet glass, II., 260  
 Flux for clays, II., 143  
 — for earthenware, II., 160-163  
 Ford's silicate of lime stone, II., 130  
 Fog, I., 158  
 Formaldehyde, disinfecting properties, II.,  
 3, 5, 18  
 Formalin—see *Formaldehyde*  
 Formates, I., 114  
 Formic acid, disinfecting properties, II.,  
 3, 5  
 Foster superheater, I., 50  
 Foucault's sheet-glass machine, II., 259  
 Frasch furnace, I., 213  
 — sulphur process, I., 202  
 Fray-Bentos guano, II., 34  
 Freezing mixtures, I., 279  
 Freiburg process for sulphur trioxide, I.,  
 245  
 French polish, II., 421  
 Frits, II., 178, 186  
 Fritting, II., 178  
 Fritz, II., 162  
 Frosting glass, II., 262  
*Fucus ascophyi nodosum*, I., 407  
 — *filum*, I., 407  
 — *palmatum*, I., 407  
 — *serratum*, I., 407  
 — *vesiculosus*, I., 407  
 Fuels, I., 1 *et seq.*  
 — available heat of, I., 45  
 — calorific intensity of, I., 46  
 — — power of, I., 10  
 — classification of, I., 1  
 — conditions for best combustion, I., 37,  
 39  
 — evaporative power of, I., 45, 46  
 — for pottery ovens, II., 177  
 — highest temperatures of, I., 45, 46  
 — ignition temperatures of, I., 34  
 — liquid, I., 25 *et seq.*  
 — utilisation of, I., 29  
 — waste with hard water, I., 173  
 — weathering of, I., 19  
 Fuller Lehigh mill, II., 96  
 Fuller's earth, II., 146  
 Fuming sulphuric acid, I., 246, 247, 251  
 Fungicides, II., 17-20  
 Furnace bricks, II., 200  
 — coals, I., 5  
 — linings, II., 146, 229-234, 333, 403  
 — gases, I., 142, 321  
 Furnaces, I., 29 *et seq.*; see also under  
*Kilns, Calciners, Ovens, Fireplaces*  
 — air required by, I., 46, 47  
 — Alby carbide, II., 409-410  
 — alundum, II., 406, 407  
 — Birkeland-Byde, I., 443, 444  
 — black ash, I., 291, 292  
 — blast, I., 40, 41  
 — brass, I., 40  
 — Buebe's schlempe, I., 488, 489  
 — calcining bicarbonate, I., 318, 319, 320  
 — carbide, II., 409, 411  
 — carborundum, II., 400-402  
 — cements for, II., 136  
 — conditions for best combustion, I., 37,  
 39  
 — construction of, I., 30  
 — crucible, I., 40, 61, 62  
 — Ducco, I., 213  
 — Dwight-Lloyd, I., 210, 216, 217  
 — earthenware, II., 175-177  
 — electric, II., 255, 360, 400-411, 424,  
 425  
 — flues of, I., 220  
 — Frisch's, I., 213  
 — ganister linings of, II., 234  
 — gas fired, I., 43  
 — glass, II., 254, 255  
 — Gorman's, I., 44  
 — Harris, I., 212, 213, 214, 216, 217  
 — heating by surface combustion, I.,  
 61, 62  
 — Hegeler, I., 216  
 — Huntington-Heberlein, I., 210, 216  
 — improvements in, II., 181  
 — Keller, II., 408  
 — liquid fuels, I., 42  
 — Lurgi, I., 213, 216  
 — Maletta, I., 212  
 — Mathewson, I., 217  
 — mechanical, I., 283, 284, 292  
 — Montz, I., 213  
 — muffle, I., 42, 281, 282  
 — O'Brien, I., 213  
 — oil, I., 25, 42  
 — open roasting, I., 283  
 — Pauling, I., 443, 444  
 — Ponsard's, I., 44  
 — pyrites, I., 211 *et seq.*  
 — Rathenau, II., 407  
 — Readman and Parker's, II., 424  
 — retort, I., 41

Furnaces, reverberatory, I., 39, 40  
 — revolving black ash, I., 292  
 — Rhenania, I., 215, 216, 218  
 — Taylor's, for CS<sub>2</sub>, I., 257, 258  
 — temperature of, II., 177  
 — Thorna, I., 213  
 — Tomblee and Paull's, I., 219  
 — salt cake, I., 281-284  
 — Savelsberg, I., 216  
 — Scherfenberg, I., 213  
 — Schönherr, I., 445  
 — Scott's electrical, I., 446  
 — Shippenbach, I., 216  
 — silicon, II., 406, 407  
 — solid fuels, I., 31  
 — steam boiler, I., 31, 32, 33, 34, 35, 36,  
 37, 38, 39  
 — water tube boiler, I., 41  
 — Wedge, I., 212, 215  
 Furniture polishes, II., 421  
 Fused electrolytic process, I., 377

## G

Gadolinite, II., 291, 316  
 Gaillard towers, I., 236  
 Galena, I., 210, 214; II., 163  
 Gall-Montlaux electrolytic cell, I., 387  
 Galloway boiler, I., 31  
 Galloway-Hill smoke-preventing furnace,  
 I., 33  
 Ganister, II., 146, 232  
 — furnace linings, II., 234  
 Gan's permutite process, I., 178-183  
 — zeolites, II., 59, 60  
 Garnets, II., 63, 419  
 Garuti-Pompili apparatus, I., 115  
 Gas, ammonium sulphate from, I., 462  
 — blast furnace, I., 136  
 — burner, I., 221  
 — coals for, I., 5  
 — coke-oven, I., 54, 55  
 — ferrocyanide from, I., 491-493  
 — filters for, I., 212, 237  
 — furnaces, I., 43, 52  
 — lighters for, II., 316, 317  
 — locking of, I., 315  
 — producers, I., 40, 121  
 — retorts, II., 231  
 — water, ammoniacal liquor from, I., 456  
 — — composition of, I., 456  
 Gases, exit, I., 235, 238, 459, 460  
 — purification of, I., 243  
 Gauges, glass for, II., 265.  
 Gay-Lussac tower, I., 221, 223, 227-229,  
 231

Gee's coal washer, I., 16  
 Geisler pump, II., 353  
 Gelis, sulpho-cyanide process, I., 495  
 Gems, II., 63-65, 265-266  
 Geneva process for aerated waters, I., 195  
 Gérard system, I., 149  
 Gerbel-Strover furnace, II., 406, 407  
 Gercke, I., 4  
 Germicidal power, II., 1  
 — value, II., 1, 3  
 Gerolstein waters, I., 198  
 Geryk pump, II., 353  
 Geyserite, II., 163  
 Gibb's electrolytic cell, I., 387  
 Gibbon kiln, II., 103  
 Gilded glass, II., 270  
 Gilding, II., 189  
 Gill kiln, I., 201  
 — steam liquation process, I., 201  
 Ginger beer, I., 199  
 Glaserite, I., 330  
 Glass, II., 235-274  
 — achromatic, II., 264  
 — actinic ray, opaque, II., 265  
 — — — transparent, II., 265  
 — action of alkalis on, II., 246  
 — action of superheated water on, II., 246  
 — alabaster, II., 269  
 — alumina in, II., 250  
 — anastigmatic, II., 264  
 — annealing, II., 261  
 — arsenic, II., 250  
 — artificial gems, II., 265-266  
 — Asch's theory of, II., 236-241, 244  
 — atmospheric influence on, II., 246  
 — aventurine, II., 267, 268, 269  
 — baryta, II., 253  
 — Bastie's hardening process, II., 245-246  
 — bead, II., 252  
 — bending of, II., 262  
 — black, II., 269  
 — blown, II., 251  
 — blowing, II., 256  
 — blue, II., 269  
 — Bohemian, II., 242, 243, 251  
 — boracic acid in, II., 249  
 — boroflint, II., 242, 249  
 — borophosphate, II., 250  
 — borosilicate, II., 251, 265  
 — bottle, II., 242, 243, 252  
 — bottle green, II., 269  
 — bottle machines, II., 257-258  
 — brittleness of, II., 246  
 — brown, II., 253, 269  
 — carboys, II., 260  
 — casting of, II., 260  
 — cements for joining metals to, II., 137



- Glass, cerium in, II., 320  
 — chemical, II., 265  
 — — composition of, II., 236-241, 242  
 — — properties of, II., 246  
 — chimneys, II., 265  
 — chrome aventurine, II., 269  
 — classification of, II., 251  
 — coloured, II., 251, 266-270, 349, 373, 381  
 — crown, II., 250, 251, 253  
 — cryolite in, II., 250  
 — cutting of, II., 262  
 — decay of, II., 266  
 — decolorants for, II., 250  
 — defects in, II., 260, 266  
 — density of, II., 244  
 — devitrification of, II., 243, 248  
 — electrical insulating, II., 265  
 — embossing of, II., 262  
 — English sheet, II., 242  
 — engraving of, II., 262  
 — etching of, I., 417; II., 262  
 — expansion of, II., 245  
 — flashing of, II., 267  
 — flint, II., 242, 243, 249, 251, 253  
 — frosting of, II., 262  
 — furnaces for, II., 253, 254, 255  
 — geräte, II., 265  
 — gilded, II., 270  
 — green, II., 269  
 — grinding of, II., 261, 262  
 — hardened, II., 245, 246, 262  
 — hollow ware, II., 251  
 — homogeneity of, II., 244  
 — insulating, II., 265  
 — iridescent, II., 262  
 — Jena, II., 242, 247, 249, 253, 265  
 — laboratory, II., 242  
 — large vessels of, II., 260  
 — lead, II., 249, 251  
 — literature, II., 235  
 — melting point of, II., 245  
 — milk, I., 419; II., 51, 270  
 — miner's lamp, II., 253  
 — mirrors, II., 263  
 — mixing materials for, II., 252  
 — mixture, theory of, II., 241  
 — nature of, II., 235  
 — normal, II., 236  
 — opal, II., 269  
 — opaque, II., 250, 251, 266-270  
 — — to infra-red rays, II., 244  
 — — to ultra-violet rays, II., 244  
 — — white, II., 269, 270  
 — optical, II., 263, 264  
 — — properties of, II., 244  
 — paper, II., 417, 418, 419  
 Glass, phosphate, II., 251  
 — photographic, II., 265  
 — pink, II., 269  
 — planed, II., 253  
 — plate, II., 242, 243, 251, 253, 260, 261  
 — pot-metal colouring of, II., 267  
 — pots for, II., 232, 254, 255  
 — pressed, II., 242, 248, 261  
 — properties of, II., 243  
 — quartz, II., 270-274  
 — raw materials for, II., 247  
 — recipe for, II., 252  
 — red, II., 269  
 — refining, II., 253  
 — reinforced, II., 261  
 — resistance to atmosphere, II., 246, 247  
 — Sackurs', II., 265  
 — Saint Gobin, II., 242  
 — sand blast for, II., 262  
 — seediness of, II., 260  
 — sheet, II., 253, 258-259  
 — silica, II., 270-274  
 — silica-free, II., 251  
 — silver stain, II., 269  
 — solid solution theory of, II., 241  
 — special, II., 265  
 — specific heat of, II., 245  
 — spun, II., 244  
 — stained, II., 267  
 — stones in, II., 260  
 — strength of, II., 245  
 — striæ in, II., 260  
 — stringiness of, II., 260  
 — steam boiler gauge, II., 265  
 — table, II., 242, 251  
 — tanks, II., 260  
 — thermal endurance of, II., 245  
 — thermometer, II., 265  
 — Thuringen, II., 242, 247  
 — transparency of, II., 244  
 — tubing, II., 253  
 — tumblers, II., 257  
 — typical analysis of, II., 242  
 — ultra-violet light transparent, II., 265  
 — uviol, II., 265  
 — Venetian, II., 242, 270  
 — violet, II., 269  
 — viscosity of, II., 235, 240  
 — water, II., 251  
 — white, II., 243  
 — — opaque, II., 269, 270  
 — window, II., 247, 253  
 — working of, II., 255-262  
 — X-ray bulb, II., 253  
 — yellow, II., 269  
 — Zschimmer's II., 265  
 Glassy porcelain, II., 185

- Glauber salt, I., 264, 285, 331, 332, 333  
 Glauberite, I., 329  
 Glaze, II., 185, 186, 187-188, 276  
 — composition of, II., 195  
 — crystalline, II., 189  
 — earthenware, II., 161, 178-179  
 — flowing, II., 190  
 — lead, II., 163  
 — lead-free, II., 157, 158  
 — lustre, II., 190  
 — sanitary ware, II., 195  
 — uranium, II., 373  
 Glazed bricks, II., 200, 201  
 — — substitutes, II., 270  
 — tiles, II., 226  
 Glazing, grinding wheels, II., 415  
 — porcelain, II., 187-188  
 Globe granite, II., 129  
 Glost, II., 176  
 — firing, II., 179  
 Glover acid, I., 223, 224, 228, 235, 248, 281  
 Glover tower, I., 221, 223, 227-229, 238  
 — — packing for, I., 230, 231  
 — — uses of, I., 224  
 Glue, use as a retarder in plaster of Paris, I., 347  
 Glue works, water for, I., 182  
 Glycozone, II., 7  
 Gold, colouring glass with, II., 269  
 — — pottery with, II., 165  
 — cyanide extraction of, I., 429, 483-484  
 — industry, statistics, I., 483-484  
 — liquid, II., 270  
 — precipitation of, II., 61  
 Gold bronze, vanadium, II., 381  
 — chloride, colouring pottery with, II., 165  
 — overglaze, II., 189  
 Golden hair water, I., 423  
 Goldschmidt's reactions, II., 67-75  
 Goreham process for cements, II., 89  
 Gorman's furnace, I., 44  
 Gout, radium treatment of, II., 396-397  
 Graf von Schwerin's clay purification process, II., 143  
 Grainers, I., 270  
 Graphite, deflocculated, II., 405  
 — electrodes, II., 405, 406  
 — from cyanamide, I., 472  
 — literature, II., 399  
 — mode of formation, II., 404  
 — powder, II., 404-405  
 — properties, II., 404  
 — purification of, I., 417  
 — statistics of, II., 405  
 — temperature of formation, II., 401, 402  
 Graphite, uses, II., 405  
 Grappier cements, II., 83  
 Grates, I., 34  
 Grease recovery from effluents, I., 184, 185  
 — — from sewage, I., 191  
 Green glass, II., 269  
 Greenland, cryolite deposits of, II., 51  
 Griesheim cell, I., 368, 369, 370, 373  
 — nitric acid plant, I., 440  
 — system, I., 234, 239  
 — towers, I., 224  
 Griffin mill, II., 95, 96  
 Gritstone wheels, II., 415  
 Grinder's phthisis, II., 415  
 Grinding appliances, II., 414  
 — glass, II., 261, 262  
 — machinery, II., 24-26, 93-98  
 — materials, II., 52, 128, 413-420  
 — mills, II., 414  
 — plaster, II., 115, 116  
 — powders, II., 418-420  
 — slag, II., 84  
 — wet, II., 88, 89  
 — wheels, II., 415, 416, 417  
 Grindstones, carborundum, II., 402, 415  
 Grog, II., 146, 163, 231  
 Ground coating for enamels, II., 278  
 — mica, II., 287  
 — waters, I., 158, 159  
 Guaiacol, II., 3, 4  
 Guanidine, I., 480  
 Guano, II., 42-43, 47  
 Guttman's alumina packing, II., 52  
 — nitric acid plant, I., 440  
 Gwynne, I., 3  
 Gypsite, I., 346  
 Gypsum, I., 329, 345-349; II., 113-117  
 — analysis of, I., 348  
 — dehydration of, I., 347  
 — effect on setting of cement, II., 111  
 — loss of setting power, II., 116  
 — occurrence of, I., 346  
 — prices of, I., 347  
 — statistics, I., 346  
 — uses of, I., 345, 349

## H

- Haas-Ottel electrolytic bleaching cell, I., 400, 401  
 Haber-le Rossignol ammonia process, I., 469, 470, 471  
 Hack, II., 213  
 Hadfield's gyratory crusher, II., 92, 93

- Half-value period, radioactive, II., 386  
 Hampson hydrogen plant, I., 100  
 — liquid air machine, I., 86  
 Hanisch-Schröder sulphur dioxide process,  
 I., 253  
 Hard finish plasters, I., 348; II., 113, 116  
 Hardened glass, II., 245, 246, 262  
 Hardening of plaster, II., 116  
 Harding's phosphorus process, II., 425  
 Hargreave's bird cell, I., 370, 373  
 — process for sodium sulphate, I., 275,  
 281, 284, 285, 289  
 Hardness of water, I., 160, 172  
 — — estimation of, I., 194  
 — — loss of fuel by, I., 173  
 Harris furnace, I., 212  
 Hart's process, I., 337  
 Hasenclever's bleaching powder plant, I.,  
 394, 395  
 — process, I., 365  
 Hauenschild kiln, II., 105  
 Haughton's acid concentration pans, I.,  
 237  
 — acid pumps, I., 232  
 — water sprays, I., 233  
 Haythorpe's process, I., 175  
 Hayward Tyler's process, I., 196  
 Heat restorers, I., 30, 34, 43  
 Heat units, I., 45  
 Heavy spar, I., 351  
 Hedgehog rolls, II., 92  
 Hefner candle power, II., 357  
 Hegeler mechanical furnace, I., 210, 216  
 Helium, properties of, I., 103  
 Henry's law, I., 140  
 Heræus fused silica process, II., 272  
 Hermite electrolytic bleaching cell, I., 396,  
 397  
 — fluid, II., 9  
 Herreshoff mechanical furnace, I., 212  
 Hessonite, II., 63  
 Hexamethylene tetramine, II., 6  
 — para-amino-triphenylmethane, II., 9  
 High speed steel, II., 69  
 Hildebrandt's liquefaction process, I., 99  
 Hippuric acid, I., 428  
 Hittorf's black phosphorus, II., 426  
 Höchst process, I., 245  
 Hoffmann kiln, I., 42; II., 80, 104, 217-  
 221  
 Hofmann's blue, I., 494  
 Holdcroft's thermoscopes, I., 73, 74  
 Hollow glass ware, II., 251  
 Holst drier, II., 84  
 Honigmann carbonating apparatus, I., 307,  
 308  
 Hoof meals, II., 39  
 Hop ale, I., 199  
 Hopper salt, I., 268  
 Horehound beer, I., 199  
 Horizontal kiln, II., 216  
 Horn metals, II., 39  
 Horry rotary furnaces, II., 411  
 Horse power, mechanical equivalent of, I.,  
 29  
 Hot air for furnaces, I., 32  
 Hotop kilns, II., 105  
 House coals, I., 5  
 — filters, I., 161  
 Houston excess lime process for water, I.,  
 167  
 Howard bridge ozone system, I., 149, 152  
 Hubnerite, II., 343-344  
 Humphries' sulphur burner, I., 255, 256  
 Humus in water, I., 159, 173, 190  
 Huntington-Heberlein furnace, I., 210, 216  
 Hyacinth, II., 63, 334  
 Hydrargyllit, II., 50  
 Hydraulic limes, II., 77, 78, 82-83, 119  
 — press, for filaments, II., 359  
 Hydroboracite, I., 329, 331, 355  
 Hydrocarbons, hydrogen from, I., 115  
 Hydrochloric acid, I., 275-280  
 — — absorption towers for, I., 277  
 — — condensation of, I., 276, 277  
 — — escape of, into air, I., 275  
 — — germicidal value of, II., 3  
 — — injurious amounts in water, I., 192  
 — — manufacture, I., 275  
 — — properties of, I., 279  
 — — purification of, I., 278, 279  
 — — specific gravity of solutions of, I., 280  
 — — storage of, I., 279  
 — — transport of, I., 278  
 — — uses of, I., 279  
 Hydrocyanic acid, I., 487, 488, 495  
 — — action on steam, I., 492  
 — — in coal-gas, I., 492, 493  
 — — in exit gases, I., 459, 461  
 — — in gas liquors, I., 456  
 — — disinfecting properties, II., 11  
 — — from schlempe, I., 489  
 Hydrofluoric acid, I., 413-419  
 — — disinfecting properties of, II., 11  
 — — evolution in superphosphate dens,  
 II., 30  
 — — glass etching, I., 417  
 — — manufacture, I., 413, 414  
 — — properties of, I., 416  
 — — purification of, I., 415, 416  
 — — specific gravity of solutions of, I.,  
 416  
 — — storage of, I., 416  
 — — transport of, I., 416

- Hydrofluoric acid, uses of, I., 417  
 Hydrofluorsilicic acid, I., 415, 417-419  
 — — disinfecting properties, II., 11  
 — — properties of, I., 419  
 Hydrogen, I., 109 *et seq.*, 124  
 — amount liberated by electrical current, I., 367, 368  
 — boiling point of, I., 112  
 — calorific intensity of, I., 11  
 — Claude's process for, I., 113  
 — electrolytic, I., 370, 379  
 — from acetylene, I., 115  
 — from acids, I., 116  
 — from alkalis, I., 116  
 — from benzene, I., 115  
 — from calcium hydride, I., 116  
 — from carbon monoxide, I., 113  
 — from cellulose, I., 111  
 — from coal, I., 111  
 — from ferro-silicon, I., 116  
 — from hydrocarbons, I., 115  
 — from petroleum, I., 115  
 — from water, I., 110, 112  
 — from water-gas, I., 112, 113  
 — ignition temperature of, I., 45  
 — Jaubert's process for, I., 117; II., 69  
 — lifting power of, I., 118  
 — Linde-Frank-Caro process, I., 101  
 — Linde process, I., 113  
 — liquefaction of, I., 100  
 — manufacture of, I., 83 *et seq.*; 110, 471  
 — occlusion of, I., 110  
 — properties of, I., 103, 109  
 — uses of, I., 117, 118, 379  
 — yield per H.P. by electrolysis, I., 370  
 Hydrogen peroxide, I., 158, 421, 422, 423, 424, 426  
 — — disinfecting power of, II., 7  
 — — estimation of, I., 424  
 — — manufacture, I., 423, 424  
 — — water purification by, I., 167  
 Hydrogenite process, I., 116  
 Hydrolith, I., 116  
 Hydrolytic tanks, I., 186  
 Hydroquinine, disinfecting properties of, II., 4  
 Hydrosulphite, sodium, I., 260  
 Hydroxide, potassium, II., 13; see also *Potassium hydroxide*  
 Hypochlorite, calcium, I., 395  
 Hypochlorites, I., 391-402  
 — disinfecting properties of, I., 402; II., 8, 9  
 — formation of, I., 397, 398  
 — germicidal value of, II., 3  
 — water purification by, I., 167, 168  
 Hypochlorous acid, I., 392, 393  
 Hyposulphite, sodium, I., 259, 298  
 Hyraldite C. Ext., I., 260
- I**
- Ice-making machines, I., 77 *et seq.*  
 Ice manufacture, I., 77 *et seq.*  
 Iceland, water power of, I., 475  
 Ignition temperatures, I., 34, 44  
 Ichaboe guano, II., 42  
 Illuminants, zirconia, II., 334  
 Illuminating gas, coke oven, I., 52, 54, 55  
 Ilmenite, II., 323, 324  
 Imitation marble, I., 349  
 Impervite, II., 118  
 Incandescent electric glow lamps, II., 351-367  
 — mantles, II., 291, 303-315, 334  
 — — artificial silk, II., 312, 313  
 — — branding of, II., 309  
 — — burning of, II., 309-313  
 — — collodionising of, II., 311-313  
 — — durability of, II., 314  
 — — fabric of, II., 304-306  
 — — fixing of, II., 309  
 — — impregnation of, II., 307, 308  
 — — inverted, II., 307  
 — — patents relating to, II., 315, 316  
 — — rings for, II., 313, 314  
 — — rods for, II., 313, 314  
 — — statistics, II., 314, 315  
 — — testing, II., 314  
 — — upright, II., 307  
 Incendiary bombs, II., 71, 72  
 India, mica from, II., 287  
 Industrial gases, properties, I., 103  
 Infra-red rays, opaqueness of glass to, II., 244  
 Inks, vanadium, II., 381  
 Insecticides, I., 258; II., 17-20  
 Insulating glass, II., 265  
 — porcelain, II., 185  
 Intermittent kilns, II., 79  
 Internal work of gases, I., 84, 85  
 Iodic hydrarg, II., 14  
 Iodides, potassium, I., 411  
 Iodine, I., 407-412, 434  
 — antiseptics, II., 3, 6, 10  
 — detection of, I., 278  
 — electrolytic, I., 408  
 — extraction by solvents, I., 410  
 — from phosphates, I., 411  
 — in sea-weed, I., 407  
 — manufacture from caliche, I., 407, 408, 409  
 — — from sea-weed, I., 408, 410, 411

- Iodine, occurrence, I., 407  
 — precipitation of, I., 407, 408, 410  
 — properties of, I., 411  
 — purification of, I., 411  
 — statistics, I., 412  
 — uses of, II., 426, 427  
 — water, germicidal value, II., 3  
 — yield from sea-weed, I., 411  
 Iodine cyanide, II., 6  
 — trichloride, germicidal value, II., 3, 10  
 Ionisation, connecting with disinfecting  
   properties of, II., 10, 14  
 Ionium, II., 386, 388, 391-392  
 Ions, I., 367, 368  
 Iridescent glass, II., 262  
 Iron, action of ammonium sulphide on,  
   I., 305  
 — — of sulphuric acid, I., 116  
 — — on water, I., 110-111  
 — disinfecting properties of, II., 16  
 — corrosion by acids, I., 249  
 — — by water, I., 172, 173  
 — cutting by oxygen flame, I., 105  
 — effect on glass, II., 269  
 — enamelled, II., 276-277  
 — estimation of, II., 119, 120  
 — in aerated water, I., 200  
 — in alum, II., 53, 57  
 — in bricks, II., 202  
 — in fire-clays, II., 230  
 — in soda water, I., 200  
 — in water, I., 168, 180, 181, 182; II.,  
   60, 61  
 — in magnetic separation of, II., 168  
 — water purification by, I., 166  
 Iron alloys, II., 70  
 — bromide, I., 406  
 — cistern cement, II., 136  
 — ore cements, II., 112  
 — oxide, I., 112, 213; catalytic, I., 240,  
   244, 245  
 — — colouring earthenware with, II., 164,  
   189  
 — pans, enamel glaze in, II., 136  
 — phosphate, II., 425  
 — Portland cement, II., 85  
 — pyrites, I., 206, 214; see under *Pyrites*  
 — salts, disinfecting properties of, II., 16  
 — treatment of effluents by, I., 184, 188  
 — water purification by, I., 166  
 Iron sulphates, limiting amounts in water  
   for fish, I., 192  
 — silicides, II., 408  
 — work, protection of, II., 404  
 Ironac, I., 236, 249, 278  
 Ironite, II., 119  
 Isinglass substitute, I., 408  
 Italian asbestos, II., 281, 282  
 Itrol, II., 16
- ## J
- Japanese porcelain, II., 186  
 — sulphur, I., 203  
 Jargon, II., 63, 334  
 Jaubert hydrogen process, I., 105, 116  
 Javel water, I., 391  
 Jeffrey pulveriser, II., 93  
 Jena glass, II., 242, 249, 253, 265  
 Jenisch ball mill, II., 94  
 Jersey stone, II., 161  
 Jet, I., 4  
 Jigger, vertical, II., 171  
 Jigs for coal, I., 14  
 Johannis waters, I., 198  
 Johnstone kiln, II., 103, 104  
 Jolleying clay, II., 171  
 Joudrain's phosphorus process, II., 426  
 Joule-Thomson effect, I., 84  
 Juniper, use in polishes, II., 421
- ## K
- Kainite, I., 329, 330, 337  
 — use as manure, II., 40  
 Kalkstickstoff, I., 475; see *Nitrolim*  
   *Cyanamide*  
 Kankar, II., 78  
 Kaolin, II., 55, 145-146, 183; see also  
   *China clay*  
 — chemical composition of, II., 139-142  
 — zeolite from, II., 59  
 Kaolinite, II., 146, 183  
 Keene's cement, II., 116, 130, 137  
 Keller furnace, II., 408  
 Kellner's electrolytic bleaching cell, I.,  
   396, 397, 398  
 Kelp, I., 408  
 Kent mill, II., 96  
 Kentish rag, II., 111  
 Keramo, II., 270  
 Keramyl, II., 11  
 Kermode burner, I., 26  
 Kerpely producer, I., 130, 132  
 Kessler's apparatus, I., 237  
 Kestner acid elevator, I., 231  
 Kettles, calcining, II., 115  
 Keystone lime kiln, II., 79  
 Kieselguhr, II., 163, 414, 420  
 Kieserite, I., 329, 330, 332, 335; II., 41

- Kilns, I., 42 ; II., 79-81, 99-105, 113-117,  
     214-222  
 — Aalborg, II., 104, 105  
 — archless, II., 214, 216  
 — Batchelor, II., 103  
 — bottle, II., 103  
 — brick, II., 214-222  
 — Bühler continuous, II., 218, 221  
 — cement, II., 99-105  
 — clamp, II., 215  
 — continuous, II., 104, 217  
 — Dietzsch, II., 104  
 — dome, II., 103  
 — down-draught, II., 215, 216, 232  
 — Dumesnil, II., 114  
 — for lime burning, II., 79-81  
 — for refractory goods, II., 232  
 — Gibbons, II., 103  
 — gypsum, II., 113-117  
 — Hargreaves, I., 284  
 — Hauenschild, II., 105  
 — Hoffmann's, I., 42 ; II., 217-221,  
     232  
 — horizontal, II., 216, 232  
 — Hotop, II., 105  
 — Johnstone, II., 103  
 — muffle, II., 194  
 — plaster, II., 113-114  
 — rotary, II., 99-103, 114  
 — Schneider, II., 105  
 — semi-continuous, II., 216, 217  
 — shaft, II., 104  
 — Spackman's, II., 103  
 — Staffordshire, II., 222  
 — stage, II., 104  
 — stationary, II., 99, 103-105  
 — stein-ribbed, II., 105  
 — up-draught, II., 216  
 Kish, II., 404  
 Knietsch-Herreshoff process, I., 242  
 Koker stoker, I., 37  
 Kominor, mild, II., 94  
 Kontrastin, II., 334  
 Kopper ammonia recovery plant, I., 462  
 Kopper's oven, I., 54  
 Kritzer hydrator, II., 81  
 Krugite, I., 329  
 Krupp ball mill, II., 94, 95  
 Krupp's pyrometer, I., 15  
 — tube mill, II., 96  
 Krause's catalytic process, I., 245  
 Kryolite—see *Cryolite*  
 Kubierschky's bromine plant, I., 404,  
     405  
 Kulm, uranium in, II., 370  
 Kunheim metal, II., 317-318  
 Kunzite, II., 63
- L**
- La Farge cement, II., 82  
 Laboratory glass, II., 242  
 Lactic acid, disinfecting properties, II.,  
     35  
 Lagging cements, II., 133-134  
 — for steam-pipes, II., 133, 134, 136,  
     284  
 Lake Magadi, I., 287, 299  
*Laminaria digitata*, I., 407, 408  
 — *saccharina*, I., 407  
 — *stenophylla*, I., 407, 408  
 Lamps, filament, II., 351, 366, 367  
 — mercury vapour, II., 274  
 — metallic filament, II., 351-367  
 — metal filament, II., 365, 366  
 — nitrogen filled, II., 364, 365  
 — tantalum, II., 356-357  
 — tungsten, II., 357-366  
 Land plaster, I., 345  
 Lane's process for hydrogen, I., 111  
 Lanthanum, uses of, II., 316  
 — oxalate, II., 301  
 — sulphate, II., 301  
 Largin, II., 16  
 Lassen and Hjert's standard purifier, I., 174  
 — — water softener, I., 177  
 Lathe, for earthenware, II., 170  
 Laughing gas, I., 496  
 Laundry, water, I., 482  
 Lawns, pottery, II., 168  
 Le Chatelier test, II., 124  
 Le Maitre briquette process, I., 29  
 Le Sueur cell, I., 371  
 Lead alloys, II., 318  
 — corrosion of, I., 230, 236, 249  
 — in aerated water, I., 199  
 — in sulphuric acid, I., 250  
 — in water, I., 161, 168  
 — antimonate, II., 165, 189  
 — borate, I., 357  
 — chamber process, I., 221 *et seq*  
 — chambers, construction of, I., 225  
     *et seq*  
 — compounds, use as fluxes, II., 163  
 — glazes, II., 163  
 — glasses, II., 249, 251  
 — oxides in enamels, II., 277, 279  
 — — in glass, II., 249  
 — sulphide, I., 210, 214  
 — pans for salt-cake furnaces, I., 283  
 Leather, ammonia from, I., 455  
 — effect of cold on, I., 90  
 — use of titanium salts on, II., 320  
 — dyeing, II., 320  
 — meal, II., 39

- Leblanc process, I., 204, 287, 288, 289, 291-298  
 — — melting process, I., 291  
 — — statistics, I., 288, 289, 299, 300  
 — — sulphur from, I., 204  
 — — summary of, I., 297  
 Lederlin and Corbin's cell, I., 387, 388  
 Lees' fusion process for salt, I., 271  
 Leguminosæ, fixation of nitrogen by, I., 428, 429; II., 39  
 Lemonade, fermentation of, I., 191  
 Lenix drive, II., 97  
 Lenses, manufacture of, II., 264  
 — polishing of, II., 421  
 Lepidolite, II., 286  
 Light, sterilisation of water by, I., 158, 169-172  
 Lighters, automatic gas, II., 316-319  
 — cigar, II., 372  
 Lignite, I., 4  
 Lime, I., 341  
 — action of carbon monoxide on, I., 114  
 — amount in distilled ammoniacal liquors, I., 315  
 — analysis of, II., 81, 119-125  
 — bleaching powder manufacture, I., 391  
 — burning of, II., 79-81  
 — common, II., 77, 78-81  
 — composition, II., 81  
 — detection by dyes, II., 111  
 — disinfecting properties of, II., 13  
 — effect on organisms in water, I., 167, 192  
 — estimation of, II., 120  
 — fat, II., 81  
 — hydraulic, II., 77, 78, 82  
 — in bricks, II., 202  
 — in enamels, II., 278  
 — in water, estimation of, I., 194  
 — lean, II., 81  
 — limiting amount in water for fish, I., 192  
 — manufacture, II., 78-81  
 — manures, II., 41  
 — milk of, I., 317, 324  
 — nature of, II., 77  
 — properties of, I., 341  
 — rich, II., 81  
 — slaked, I., 341; II., 78  
 — slakers, I., 317, 361; II., 80, 81  
 — stucco, II., 118  
 — uses, I., 341; II., 248, 419, 421  
 — water purification by, I., 167  
 — kilns, I., 41, 317, 318; II., 79, 81  
 — — gas, I., 320, 321  
 — precipitate, II., 34  
 Lime-nitrogen, II., 37; see *Calcium cyanamide*  
 Lime-sand bricks, II., 131, 223-224  
 Lime-sulphur dips, II., 18, 19  
 — — washes, II., 18  
 Limestone, II., 78  
 — carbon dioxide from, I., 141, 320, 321  
 — heat for calcination, I., 320  
 — in clay, II., 143, 144, 201  
 — use as manure, II., 41  
 Limogeic enamel, II., 278  
 Linde-Frank-Caro process, I., 113  
 Linde liquid air machines, I., 87  
 — nitrogen plant, I., 96, 479  
 — oxygen plant, I., 92, 96  
 — process, I., 84, 85, 89, 113  
 Liquefaction of gas, I., 83 *et seq.*  
 Liquid air, separation of constituents of, I., 91  
 — carbon dioxide, I., 142  
 — chlorine, I., 381-383  
 — fuels, I., 25, 26, 42, 59  
 — gold, II., 270  
 Litharge, use as flux, II., 163  
 Lithia mica, II., 286  
 — water, I., 198  
 Lithium aluminium silicate, II., 63  
 — nitride, I., 474  
 Lithophone, I., 422  
 Lixiviation of black ash, I., 293  
 Loams, II., 146  
 Local Government Board's Sewage Disposal Regulations, I., 190, 191, 192  
 Lodge's fog-dispelling device, I., 220  
 Löhnert's compound mill, II., 98  
 Löwig process, I., 296  
 Long-flamed coals, I., 5  
 Loss of heat in burning, I., 47  
 Louisiana sulphur deposits, I., 202  
 Louisville cement, II., 86  
 Lubricants in water, I., 174  
 Lucifer matches, II., 429  
 Luminator apparatus, I., 176  
 Luminous watch dials, II., 397  
 Lump pyrites kilns, I., 211  
 Lunge-Rohrman reaction towers, I., 230  
 Lurgi furnace, I., 213, 216  
 Lustre glazes, II., 190  
 Lutes, II., 135-137  
 Lux's mass, II., 50

## M

- Mache units, I., 198  
 Machines, soft mud, II., 206  
 Mack's cement, II., 117

- Mactear furnaces, I., 320  
 Madras mica, II., 288  
 Magadi, Lake, I., 287, 299  
 Magenta bronze, II., 349  
 Magnesia, II., 127  
 — estimation of, II., 119  
 — from magnesium chloride, I., 365, 366  
 — in cement, II., 108  
 — in glass, II., 248, 253  
 — use in glaze, II., 162  
 Magnesia bricks, II., 233  
 — cement, II., 127, 128  
 — mica, II., 287  
 — mixtures, II., 46  
 Magnesite, I., 141, 343; II., 127, 184  
 Magnesium in water, I., 173  
 — alba, I., 343  
 — aluminate, II., 63  
 — — bricks, II., 233  
 — bromide, I., 403, 405  
 — carbonate, I., 343  
 — chloride, I., 192, 268, 330, 332, 333;  
   II., 127, 128  
 — — chlorine from, I., 365, 366  
 — — hydrochloric acid from, I., 365, 366  
 — — waste of, I., 365  
 — hypochlorite, I., 396  
 — limestone, II., 78  
 — metallic, I., 330  
 — nitride, I., 474  
 — oxychloride cements, I., 366; II., 127,  
   128, 130, 415  
 — perhydrol, I., 422  
 — peroxide, I., 167, 422; II., 7  
 — salts, I., 343; II., 127, 128  
 — — manufacture, I., 264  
 — — precipitation of, I., 270  
 — — removal from water, II., 60  
 — silicofluoride, II., 119  
 — sulphate, I., 330, 332, 333  
 Magnetic separation of monazite, II., 295,  
   296  
 Magnetite arc lamp, II., 329  
 — anodes lamp, I., 369  
 Mahler-Cook calorimeter, I., 8  
 Majolica, II., 153, 157  
 Maletra furnaces, I., 212  
 Mallow root, action on plaster, II., 116  
 Malins, II., 146, 203  
 Manganates, disinfecting properties of,  
   II., 7  
 Manganese alloys, II., 70, 318  
 — borate, I., 357  
 — catalytic, I., 471  
 — dioxide, I., 360, 362, 410  
 — metallic, II., 68, 70  
 — removal from water, II., 60  
 Manganese, available oxygen in, I., 360  
 — — use in glass-making, II., 250  
 — hydroxide, I., 362  
 — oxides, II., 189  
 — — catalytic, I., 240  
 — — colouring glass with, II., 269  
 — — — pottery with, II., 165  
 — permutite, II., 60  
 Manganous oxide, I., 117  
 Mannheim calciner, II., 114  
 — salt-cake process, I., 284  
 — sulphur trioxide process, I., 244, 245  
 Mantles, incandescent gas, II., 303-315  
 Manures, II., 21-47  
 — animoniacal salts, I., 467  
 — analysis of, II., 44-47  
 — certificates for, II., 47  
 — cyanamide, I., 475, 480  
 — determination of nitrogen in, II., 45  
 — — of phosphorus in, II., 45  
 — incompatible, II., 42  
 — mixed, II., 41, 42  
 — moisture in, II., 45  
 — nitrogenous, II., 36-40  
 — sludge, I., 191, 192  
 — statistics, II., 47  
 Marble, II., 78  
 — artificial, I., 366; II., 128, 130, 131  
 — cement for, II., 136  
 — imitation, I., 349  
 — Marezzo, II., 130  
 — Moreau, II., 131  
 Marcasite, I., 206  
 Marezzo marble, II., 130  
 Margett's cement process, II., 89  
 Marls, II., 146, 203  
 Marquardt's porcelain, II., 185  
 Marten's instrument, II., 123  
 Martin's theory of decomposing elements,  
   II., 384  
 Matches, II., 429-432  
 — after-glow prevention, II., 430  
 — composition of, II., 429-431  
 — double dip, II., 430  
 — French State, II., 431  
 — Lucifer, II., 429  
 — safety, II., 430, 431, 432  
 — statistics, II., 431, 432  
 — white phosphorus, II., 430  
 Mathewson furnace, I., 217  
 Matura diamond, II., 334  
 Meal, blood, II., 39  
 — castor oil, II., 38  
 — horn, II., 39  
 — rape cake, II., 38  
 Mechanical burners, I., 213  
 — pyrites furnaces, I., 212



- Mechanical salt cake furnaces, I., 283, 284, 365
- Medina cement, II., 85
- Mediterranean, composition of, I., 262, 263
- Medusa, II., 119
- Meldrum Koker stoker, I., 37
- Mercuric bromide, II., 14, 15
- chloride, II., 3, 14, 15, 18
- cyanide, II., 15
- ethylene diamine sulphate, II., 15
- iodide, II., 15
- Mercury alloys, II., 318
- cells, I., 375
- disinfecting properties of, II., 15
- mirrors, II., 263
- oxycyanide, II., 15
- peroxide, II., 7
- salicylate, II., 15
- salts, II., 14-15
- vapour lamp, I., 170; II., 265, 274
- zinc cyanide, II., 15
- Mesothorium, II., 385, 387, 388, 393-394, 398
- Messerschmitt's process, I., 111
- Metal polishes, II., 420-421
- Metallic filament lamps, II., 351-367
- salts, germicidal value of, II., 10
- Metallising carbon filaments, II., 354
- Metals, action of sulphuric acid on, I., 249
- cements for joining to wood, II., 137
- melting by surface combustion, I., 61
- Methane, properties of, I., 103
- temperature of ignition, I., 45
- Methylamines, I., 488
- Mexico, vanadium ores of, II., 376
- Meyer's tangential chambers, I., 227
- Mica, II., 285-289
- amber, II., 288
- artificial, II., 286
- dark amber, II., 288
- ground, II., 286, 287, 289
- literature of, II., 285
- manufacture, II., 286
- powder, II., 287
- production of, II., 288
- scrap amber, II., 289
- sheet, II., 287
- silver amber, II., 288
- species of, II., 285
- uses of, II., 287
- value of, II., 288, 289
- Micanite, II., 287
- Micrococcus ureæ*, I., 428
- Microsol, II., 14
- Milch superphosphate den, II., 30
- Milk, Pasteurisation of, II., 7
- glass, I., 419; II., 270
- Mills, ball, II., 89, 93-94, 106
- Clark's, II., 89, 90
- colour, II., 181
- compound, II., 97, 98
- edge-runner, II., 204, 205
- pug, II., 99, 168, 206
- roller, II., 93, 95, 96
- tube, II., 89, 96, 97, 107
- wash, II., 204
- wet grinding, II., 166
- Millstones, II., 414
- Minargent, II., 349
- Mineral blue, I., 494
- oils, I., 25
- springs, bromine rich, I., 403, 406
- superphosphate, II., 31
- table waters, I., 197, 198
- waters, artificial, I., 195-200
- — radio-active, I., 198
- Mirrors, glass, II., 263
- Misch metal, II., 316, 317, 318
- Mixed gas, carbon dioxide in, I., 321
- manures, II., 41, 42
- Mixers for slurry, II., 91
- Mixing silos, II., 99
- slag, II., 84
- Modelling clay, II., 169-171
- Mohave desert, I., 356
- Moisture, estimation of, II., 45
- Molasses, potash from, I., 338
- removal of salt from, II., 60
- Molecular weight and crystallising capacity, II., 236
- Molitor ball mill, II., 94
- Molybdenum, II., 355
- alloys, II., 70
- filaments, II., 355
- metal, II., 68, 70
- molybdate, II., 46
- Molybdic acid solutions, II., 46
- Monazite, II., 291, 292, 316, 369
- composition of, II., 293-294
- concentration of, II., 294-296
- dry blowing of, II., 295
- preparation for export, II., 294-296
- statistics, II., 297, 298
- Mond gas, ammonia from, I., 134, 453, 461
- — calorific power of, I., 134
- — composition of, I., 134
- — theory of ammonia formation in, I., 492
- producer, I., 121, 129, 130
- suction gas producer, I., 135
- Monochloroacetic acid, I., 381

Monox, II., 403, 404  
 Montanin, II., 11  
 Montejus acid, I., 231  
 Moor coal, I., 4  
 Moorish ware, II., 157  
 Mordants, II., 51, 56, 57  
 — uranium, II., 373  
 — vanadium, II., 381  
 Mortar, II., 117-119  
 Moritz chambers, I., 224, 226  
 — furnace, I., 213  
 Mortar cement, II., 117, 118  
 — common, II., 117  
 Mosser cooler, II., 103  
 Mottramite, II., 375, 377  
 Moulding clay, II., 170  
 — porcelain, II., 187  
 Moulds for earthenware, II., 170, 171  
 Mover waterproofing process, II., 118  
 Muffle furnaces, I., 42; II., 118  
 — kiln, II., 194  
 Multitubular boiler, I., 32  
 Muriate of potash—see *Potassium chloride*  
 Muscovite, II., 285, 287

## N

Naphthol, beta, II., 4  
 Naples yellow, II., 165  
 Native guano, II., 43  
 Natrolite, II., 59  
 Neodymium, colouring porcelain by, II., 320  
 — use in glass, II., 320  
 — oxalate, II., 301  
 — sulphate, II., 301  
 Nernst filament, I., 145  
 — lamp, II., 334  
 Nesfield triple tablets, II., 10  
 Neumann's phosphorus process, II., 425  
 Neutral bricks, II., 233  
 Newfoundland asbestos deposits, II., 282  
 Niagara Falls, I., 371, 385, 387; II., 403  
 Nickel alloys, II., 70  
 — colouring glass by, II., 269  
 — use in glass making, II., 250  
 — oxide, I., 118; II., 165  
 — sulphate, catalytic, I., 240  
 Nicol's spissograph, II., 124  
 Nicotine, disinfecting properties of, II., 19, 20  
 — sulphur dip, II., 19-20  
 Nidenführ-Rohrmann packing, I., 227, 229  
 Nigerian monazite, II., 293

Nile sudd, briquetting of, I., 24  
 Niobium, II., 341-342  
 Niton, I., 198  
 Nitra lamps, II., 365  
 Nitragin, II., 40  
 Nitrates, absorption by plants, I., 427, 428, 429  
 — ammonium, I., 435-436, 448; see also *Ammonium nitrate*  
 — calcium, I., 434, 435, 447  
 — Chile deposits, I., 431  
 — estimation of, I., 194  
 — for sulphuric acid, I., 210  
 — from air, I., 446-447  
 — formation of, in soil, I., 427, 428, 429, 434  
 — in water, I., 173  
 — Norwegian, I., 441  
 — potassium—see *Potassium nitrate*  
 — sodium—see *Sodium nitrate*  
 — sources of, I., 210  
 Nitre cake, I., 438  
 — — disinfecting properties of, II., 12  
 — — uses of, I., 356  
 — pots, I., 220, 234  
 Nitric acid, I., 437-451  
 — — absorption towers, I., 447  
 — — disinfecting properties, II., 11  
 — — from air, I., 427, 441-449  
 — — from ammonia, I., 435, 448-449  
 — — from Chile saltpetre, I., 437  
 — — in sulphuric acid chambers, I., 225, 233, 234  
 — — in water, I., 159, 160  
 — — properties of, I., 449-450  
 — — specific gravity of, I., 450  
 — — statistics, I., 451  
 — — stills, I., 438, 439, 440  
 — — Valentin's process, I., 440  
 — — oxide, formation of, I., 441, 442, 446, 447  
 — — heat of formation, I., 442  
 — — properties of, I., 103  
 Nitrides, aluminium, I., 473-474  
 — — ammonia from, I., 473-474  
 Nitrification, I., 429  
 Nitrifying bacteria, I., 427, 428, 429  
 Nitrites, I., 447-448  
 — absorption by plants, I., 427, 428, 429  
 — bacteria, I., 429  
 — estimation in water, I., 194  
 — sodium, I., 436; see also *Sodium nitrite*  
 Nitro-cake, I., 234  
 Nitrogen, I., 83, 107, 108  
 — absorption by bauxite, I., 473, 474  
 — — by calcium carbide, I., 477

- Nitrogen, absorption by plants, I., 427, 428, 429
- — from atmosphere, I., 427
  - animal life and, I., 427, 428
  - assimilation of, I., 427, 428, 429
  - boiling point of, I., 112
  - circulation of, I., 427, 428
  - Claude plant for, I., 96, 98
  - conditions for uniting with oxygen, I., 441, 442
  - copper process for, I., 107
  - direct unions of, I., 108, 469
  - estimation of, I., 193; II., 45
  - fixation of, I., 427, 428, 429, 441-447; II., 327
  - from air, I., 91
  - Hildebrandt's process for, I., 99
  - in coal, I., 453
  - lamps, II., 364-365
  - Linde plant for, I., 94, 95, 96
  - production of, I., 61, 94, 107, 471, 479
  - properties of, I., 105, 107
  - quantity in atmosphere, I., 441
  - uses of, I., 108
  - bacteria, I., 427, 428, 429
  - — use as manure, II., 39
  - monoxide, I., 496
  - oxides, disinfecting properties of, II., 11
  - — electrical formation of, I., 427, 441-447
  - — in chamber process, I., 222-225, 233, 234
  - — in sulphuric acid, I., 251, 235
  - peroxide, I., 446, 447
- Nitrogenous manures, II., 36-40
- Nitroguanidine, I., 480
- lime, I., 475; II., 42, 411; see also *Calcium cyanamide*
  - — analysis of, II., 38
  - — use as manure, II., 37, 38
- Nitro-phosphate, II., 42
- Nitrosococcus, I., 429
- Nitrosomonas, I., 429
- Nitrosyl sulphuric acid, I., 223, 224
- Nitrous acid, decomposition of urea by, I., 428, 429
- — in water, I., 159, 160
  - — manufacture, I., 496
  - oxide, I., 103, 434, 496
  - — properties, I., 496
- Non-coking coal, I., 5
- Non-slip stone, II., 129
- Northwich salt beds, I., 262
- — pans, I., 265, 266
- Norway, water power of, I., 441, 475
- Norwegian saltpetre, I., 435, 447
- Nut briquettes, I., 24
- O'Brien furnace, I., 213
- Ocean, composition of, I., 262
- Ochre, II., 164
- Oddo cyanamide factory, I., 475, 476, 477
- Ohio bromine mineral springs, I., 403, 406
- Ohm's law, I., 368
- Oil, filtration of, I., 174
- in water, I., 174
  - mineral, I., 25
  - separation from boiler water, I., 174, 175, 179
- Oil fuels, I., 25
- — advantages of, I., 26
  - — cost of, I., 27
  - furnaces, I., 42
  - shales, II., 148
  - of eucalyptus, II., 5
  - of vitriol, I., 248; see *Sulphuric acid*
  - dug, II., 405
- Oleic acid, I., 118
- Olivene, II., 63
- Opal, II., 63
- glass, II., 269
- Opaque glass, II., 250, 251, 269, 270
- Open mixers, II., 205, 206
- roasting furnace, I., 291, 292
- Opl process, I., 224, 234, 239
- Optical glass, II., 263-264, 320
- pyrometers, I., 67, 68, 69, 70, 71, 73
- Oriental amethysts, II., 63
- Orthoclase, II., 161
- Osmi lamp, II., 355
- Osmic acid, II., 11
- Osmium, catalytic, I., 471
- filaments, II., 355, 366
- Ostwald nitric acid process, I., 435, 448, 449, 480
- Otto oven, I., 52, 53
- ozone system, I., 147, 151, 152
- Otto-Hilgenstock ammonia recovery process, I., 463
- oven, I., 54
- Outhenin-Chalandre cell, I., 371
- Ovens, earthenware, II., 175-177
- improvements in, II., 181
  - pottery, II., 175-177
- Overburden, II., 203
- Overglaze colours, II., 189
- decoration, II., 180
- "Ovoid" briquettes, I., 24
- Owen's glass bottle machine, II., 257
- lake, I., 287
- Oxalates, hydrogen from, I., 114
- Oxalic acid, II., 119

- Oxalic acid, use as polish, II., 421  
 Oxidation, catalytic, I., 448, 449  
 Oxidising agents, I., 421-426  
 — disinfectants, II., 6  
 Oxone, I., 421  
 Oxy-acetylene flame, I., 105, 117  
 Oxychloride, II., 9  
 Oxy-hydrogen flame, I., 117  
 Oxygen, amount necessary to life, I., 192  
 — available, I., 421, 424  
 — Brinn process, I., 105  
 — Claude plant for, I., 96, 97, 98  
 — consumption value for water, I., 160  
 — determination of dissolved, I., 194  
 — electrolytic, I., 105  
 — Hildebrandt's process, I., 99  
 — Jaubert process, I., 105  
 — Linde plant, I., 92, 96  
 — manufacture, I., 83  
 — production from air, I., 91  
 — — from electrolysis, I., 370  
 — — from Linde plant, I., 92  
 — properties of, I., 103, 105  
 — statistics of, I., 106  
 — uses of, I., 105  
 Oxygen consumption value, I., 194  
 Oxyolith, I., 421  
 Ozonair system, I., 150  
 — water treatment, I., 153, 154  
 Ozone, I., 145 *et seq.*  
 — air purification by, I., 154  
 — applications of, I., 151  
 — bleaching by, I., 154  
 — detection of, I., 150  
 — disinfecting properties of, II., 5, 6  
 — estimation of, I., 150  
 — formation of, I., 145, 146  
 — properties of, I., 103, 145  
 — sterilisation of water by, I., 169  
 — water purification by, I., 151, 168, 169  
 — use in fermentation industry, I., 154  
 Ozonic ether, II., 7  
 Ozonides, II., 6
- P**
- Packing for towers, I., 227, 229, 230, 231  
 Paint for iron-work, II., 404  
 Pan-boilers, I., 39  
 Pan-scale, I., 268  
 Pans, iron, I., 281  
 Pancreatine, II., 7  
 Pankermite, I., 355  
 Paper sizing, II., 57  
 Paperstock asbestos, II., 283  
 Paraffin, use as a polish, II., 420, 421  
 Paraform, II., 6  
 Paraformaldehyde, II., 6  
 Parian cement, II., 117  
 — porcelain, II., 154  
 — ware, II., 186  
 Paris, plaster of, II., 113-117  
 — blue, I., 494  
 Parker's cement, II., 85  
 Parrot coals, I., 6  
 Partinium, II., 349, 352  
 Partition blocks, hollow, II., 227  
 Passow's slag cement, II., 84  
 Paste, II., 65, 265, 266  
 Patent fuel, I., 21  
 — plate glass, II., 261  
 Patronite, II., 375, 376  
 Pauling electrical furnace, I., 443, 444  
 Paving blocks, II., 197-198  
 — stones, II., 129, 130, 131  
 — tiles, II., 225  
 Pearls, II., 63  
 — artificial, II., 65  
 Peas, nitrogen fixation by, I., 428  
 Peat, I., 3  
 — ammonia from, I., 454, 461  
 — bacterised, I., 434  
 — nitrogen in, I., 454  
 — temperature of ignition, I., 44  
 — use as fuel, I., 3  
 Peat charcoal, I., 18  
 — gas, I., 4  
 Peaty acids, I., 173  
 Pegmatite, II., 161, 285  
 Pens, tantalum, II., 341  
 Pepsin, II., 7  
 Peracids, I., 424-425  
 Perborates, I., 357, 425, 426  
 — ammonium, I., 426  
 — disinfecting properties of, II., 7  
 — sodium, I., 425, 426  
 Perborax, I., 425  
 Perboric acid, I., 425  
 Perborin, I., 426  
 Percarbonates, disinfecting properties of, II., 7  
 — potassium, I., 426  
 — sodium, I., 426  
 Percarbonic acid, I., 426  
 Perchlorates, I., 388-389  
 — analysis of, I., 389  
 Perhydrol, I., 423; II., 7  
 — water purification by, I., 167  
 Peridot, II., 63  
 Perin's instrument, II., 123  
 Period, radio-active, II., 386  
 Permanent hardness, I., 172

- Permanganates, disinfecting properties of, II., 7  
 — removal from water, II., 61  
 — sterilisation of, I., 182  
 — water purification by, I., 167  
 Permonosulphuric acid, I., 423, 424  
 Permutite, I., 176-183; II., 59, 60, 61  
 — sodium, II., 60  
 Peroxide, hydrogen, II., 7  
 Peroxides, I., 421-424  
 — disinfecting property of, II., 7  
 — nature of, I., 421  
 Peroxol, II., 7  
 Persol, I., 426  
 Persulphate, ammonium, I., 424-425  
 — potassium, I., 425  
 Persulphates, disinfecting properties of, II., 7  
 Persulphuric acids, I., 424  
 Peru, nitrate beds of, I., 431  
 — vanadium deposits of, II., 376  
 Peruvian guanos, II., 42  
 Pestle and mortars, II., 415  
 Petersen's tower process for sulphuric acid, I., 239  
 Petroleum, cements insoluble in, II., 137  
 — hydrogen from, I., 115  
 Petroleum ether, use as lubricant, I., 89  
 — oils, water evaporative power, I., 45  
 Pettigrew's furnace, II., 406, 407  
 Pharaoh's serpents, II., 69  
 Phenol, germicidal value of, II., 1-3  
 — in dips, II., 20  
 — in gas liquor, I., 456  
 — use as disinfectant, II., 4  
 Phenyl-salicylate, II., 5  
 Phlogopite, II., 285, 286  
 — uses of, 287  
 Phosphate glasses, II., 251  
 — rock, I., 252  
 — plant, II., 28  
 Phosphates, crushing of, II., 24  
 — deposits of, II., 21-23  
 — estimation of, II., 45  
 — iodine from, I., 411  
 — natural, II., 21-23  
 Phosphatic manures, II., 21-33  
 Phospho-nitrogenous manures, II., 33-36  
 Phosphorescent substances, I., 352  
 Phosphoretted hydrogen, II., 409  
 Phosphoric acid, I., 160; II., 31, 32  
 — — removal from thorium, II., 300  
 — — use in glass making, II., 250  
 Phosphorus, II., 423-427  
 — allotropic modifications of, II., 426  
 — amorphous, II., 426  
 — black, II., 426  
 Phosphorus, Bologna, I., 352  
 — condensation of, II., 425  
 — Harding's process for, II., 425  
 — Hittorf's black, II., 426, 431  
 — Joudrain's process for, II., 426  
 — Neumann's process for, II., 425  
 — occurrence, II., 423  
 — old process for, II., 423  
 — production in matches, II., 430  
 — properties of, II., 426  
 — pyromorphic, II., 426  
 — Readman-Parker process for, II., 424  
 — red, II., 426, 430, 431  
 — scarlet, II., 426, 427, 431  
 — uses of, II., 427  
 — violet, II., 426  
 — white, II., 426, 429, 430  
 Phosphorus hydrides, II., 431  
 — sulphides, II., 431  
 Photographic glass, II., 265  
 Photography, use of cerium in, II., 320  
 — — — uranium nitrate, II., 373  
 — — — vanadium salts, II., 381  
 Photometric pyrometers, I., 69  
 Picro-ilmenite, II., 324  
 Pictures, restoring of, I., 423  
 Pigments, zirconium, II., 335  
 Pine-wood, ignition temperature, I., 44  
 Pink glass, II., 269  
 — overglaze, II., 189  
 Pinnoite, I., 329, 331, 355  
 Pipeclay, II., 147  
 Pipes, burner, I., 220  
 — drain, II., 196  
 Pitch, use as a binder, I., 21, 22  
 Pitch cancer, I., 24  
 — coal, I., 4  
 — ulcer, I., 24  
 Pitchblende, II., 369, 370, 371  
 — extraction of radium from, II., 390  
 — mines, II., 389  
 Placing ovens, II., 175  
 Panel glass, II., 253  
 Plants, absorption of nitrogen by, I., 427, 428, 429  
 — foods for, II., 21  
 Plaster cements, II., 86, 113-117, 118, 130  
 Plaster of Paris, I., 347; II., 113-117  
 — — — action of glue on, II., 116  
 — — — analysis of, I., 348; II., 120  
 — — — hardening by gum arabic, II., 116  
 — — — properties of, II., 116  
 — — — theory of setting, II., 116  
 — — — uses of, I., 349; II., 162  
 Plasters, calcium, II., 113  
 — flooring, II., 113, 116

- Plasters, grinding, II., 115, 116  
 — hard finish, I., 348; II., 113, 116  
 — hardening of, II., 116  
 — setting of, I., 347, 348  
 — tensile strength of, I., 348  
 — wall, I., 349  
 Plastic bricks, plant for, II., 99, 209  
 Plasticity of clays, II., 142, 169  
 Plate glass, II., 242, 243, 251  
 — — figured, II., 261  
 — — manufacture, II., 260, 261  
 — — recipe for, II., 253  
 — — making machines, II., 172  
 — — powders, II., 419, 420  
 Platinised asbestos, I., 242  
 Platinoid, II., 349, 352  
 Platinum, catalytic, I., 240, 241, 245, 448, 449  
 — colouring pottery with, II., 165  
 — oxidation of ammonia by, I., 449  
 — price of, I., 233  
 — resistance pyrometers, I., 67  
 — sulphate, use as catalyst, I., 245  
 Plumber's cement, II., 137  
 Plunger pumps, I., 233  
 Pointed enamel, II., 278  
 Poisons, catalytic, I., 240, 241  
 — in water, I., 192  
 Polarisation voltages, I., 368  
 Polishes, II., 414, 420-421  
 Polishing, II., 413, 414  
 — materials, II., 128, 413, 413-421  
 — mechanical methods of, II., 421  
 — powders, II., 419  
 — steel, II., 413  
 Polonium, II., 386, 388, 391, 392  
 Polyhalite, I., 329  
 Polyoxides, I., 421  
 Polysius tube mill, II., 97  
 Polysulphides, ammonium, I., 494, 495  
 — disinfecting properties of, II., 13  
 Pondermite, I., 356, 357  
 Ponsard's furnace, I., 44  
 Porcelain, II., 183-190  
 — Beleck, II., 186  
 — bodies, II., 184, 186  
 — casting, II., 187  
 — cement for joining metal to, II., 137  
 — Chinese, II., 186  
 — clays for, II., 145  
 — colouring by neodymium, II., 310  
 — — by praseodymium, II., 320  
 — — by titanium, II., 320, 328  
 — — by tungstic oxide, II., 349  
 — — by uranium, II., 373  
 — decoration of, II., 188, 189  
 — definition of, II., 153  
 Porcelain, electrical, II., 185  
 — glassy, II., 185, 187  
 — glazing of, II., 187, 188  
 — hard, II., 184, 187  
 — Japanese, II., 186  
 — manufacture of, II., 186-190  
 — moulding, II., 187  
 — raw materials for, II., 183  
 — throwing, II., 187  
 Porous cells, composition of walls, I., 368, 369  
 — vessels, manufacture of, I., 419  
 Porpora glass, colour of, II., 267, 268  
 Portland cement, II., 87-112  
 — — adulteration of, II., 111  
 — — analysis, II., 109, 119-125  
 — — clay for, II., 145  
 — — composition of, II., 108-111  
 — — constituents of, II., 125  
 — — expansion test for, II., 124  
 — — natural, II., 78, 86  
 — — properties of, II., 112  
 — — setting of, II., 110, 111, 124  
 — — specifications of, II., 108  
 Possoz-Boissière process for cyanides, I., 490  
 Pot, glass-maker's, II., 232  
 Pot-metal colouring of glass, II., 267  
 Potash, consumption of, in agriculture, II., 40  
 — estimation of, II., 46  
 — in enamels, II., 278  
 — in glaze, II., 162  
 — in wood, I., 338  
 — manures, II., 40  
 — mica, II., 285  
 — water, I., 198  
 Potassium, estimation of, II., 46  
 — alum, II., 55, 56; injurious amounts in water, I., 192  
 — auro-cyanide, I., 483  
 — bicarbonate, I., 339  
 — bichromate, I., 339; II., 269  
 — bromate, I., 406  
 — bromide, I., 406  
 — carbonate, conversion into ammonium carbonate, II., 61  
 — — in glass making, II., 247, 253  
 — — manufacture, I., 337, 338, 339  
 — chlorate, I., 385, 386, 387, 388  
 — — conversion into ammonium chlorate, II., 61  
 — — current for production of, I., 388  
 — — electrolytic, I., 386, 387, 388  
 — — formation of, I., 388  
 — — solubility of, I., 386  
 — — statistics of, I., 360

- Potassium, use in glass making, II., 248  
 — — use as manure, II., 41  
 — chloride, I., 335, 336  
 — — electrolysis of, I., 386, 387  
 — — from carnallite, I., 332  
 — — insolubility in caustic alkalis, I., 378  
 — — manufacture of, I., 336  
 — — manurial value of, II., 41  
 — — statistics, I., 332, 333  
 — chromate, I., 339  
 — chrome alum, II., 56  
 — cyanate, I., 484, 485  
 — cyanide, I., 483  
 — — Beilby's process for, I., 485  
 — — disinfecting properties of, II., 11  
 — — from atmospheric nitrogen, I., 490  
 — — from potassium ferrocyanide, I., 484-485  
 — — from sulphocyanide, I., 487, 488  
 — — price of, I., 484  
 — — Siepermann's process for, I., 485  
 — — statistics, I., 483, 484  
 — ferricyanide, I., 493  
 — ferrocyanide, I., 483, 484, 485, 491-493, 494  
 — fluorides, I., 416  
 — fluotantalate, II., 339  
 — fluoxy-niobate, II., 339, 341  
 — hydroxide, concentration of, I., 378, 379  
 — — disinfecting properties of, II., 13  
 — iodide, I., 411, 412  
 — metasulphite, I., 256  
 — nitrate, I., 433, 434  
 — — decomposition of, in soil, I., 429  
 — — formation in soil, I., 429, 434  
 — — in glass, II., 248, 253  
 — — manufacture of, I., 433, 434  
 — — manure, II., 41  
 — — properties of, I., 434  
 — — solubility of, I., 434  
 — — uses of, I., 434  
 — percarbonate, I., 426  
 — perchlorate, I., 389; II., 61, 248  
 — permanganate, II., 7  
 — — germicidal value of, II., 3  
 — persulphate, I., 425  
 — phosphate, II., 41  
 — salts, I., 335-340  
 — — in wool washing, I., 184, 185  
 — — manufacture, I., 264  
 — — manures, II., 40-41  
 — — removal from water, II., 60  
 — silicate, use as manure, II., 41  
 — silico-fluoride, I., 415, 416  
 — superphosphate, II., 42
- Potassium sulphate, I., 337  
 — — statistics, I., 332, 333  
 — — use as manure, II., 41  
 — sulphide, fungicide, II., 18  
 — — statistics, I., 289  
 — sulphocyanide, I., 487, 488, 495  
 — titanium oxalate, II., 327  
 — tri-iodide, I., 411  
 Potter's wheel, II., 169  
 Pottery, II., 151-155  
 — classification of, II., 152  
 — colouring by vanadium, II., 381  
 — furnaces, I., 42; II., 177  
 — improvements in, II., 155  
 — properties of, II., 154  
 — varieties of, II., 154  
 Pouilly cement, II., 86  
 Powder, light, II., 404  
 Power-Gas Corporation, I., 121, 130, 134  
 Power, water, I., 368  
 Praseo-dymium, colouring porcelain by, II., 320  
 — in glass, II., 320  
 — oxalate, II., 301  
 — sulphate, II., 301  
 Precht's process, I., 338  
 Precious stones, II., 63-65  
 Precipitate process for effluents, I., 185  
 Precipitated phosphate, II., 28  
 Press, hydraulic, for filaments, II., 359  
 — for earthenware, II., 171  
 Pressed glass, II., 242, 261  
 Pressure, effect on chemical action, I., 364  
 — filters, I., 466  
 Primary air supply, I., 31  
 Printing table, II., 180  
 Producer, central blast, I., 130  
 — circumferential grate, I., 129  
 — diagonal grate, I., 129  
 — Kerpeley, I., 130, 132  
 — Mond, I., 129, 130  
 — Talbot's, I., 130, 131  
 — Taylor, I., 130  
 — types of, I., 129  
 — gas, I., 119  
 — — advantages of, I., 131  
 — — ammonia from, I., 454, 462  
 — — calorific power of, I., 128  
 — — composition of, I., 123, 127, 128  
 — — odourising of, I., 133  
 — — uses of, I., 129, 255  
 Projectiles, tungsten in, II., 349  
 Propane, I., 103  
 Propionic acid, disinfecting properties, II., 5

Protargol, II., 16  
 Protectyl, II., 15  
 Proteid ammonia, I., 160  
 Proteolytic bacteria, I., 427  
 Prussian blue, I., 493-494; II., 53  
 — — soluble, I., 494  
 Prussiate manufacture, I., 491-493  
 — recovery, I., 492-493  
 Ptyalin, II., 7  
 Pucherite, II., 375  
 Puddling clay, II., 147  
 Pug mills, II., 99, 160, 206, 208  
 Pumice, II., 414, 420  
 Pumps, acid, I., 231-233, 278  
 — — for compressing chlorine, I., 381, 382, 383  
 — — vacuum, II., 353  
 Purple of Cassius, II., 61, 109  
 Purification of sulphuric acid, I., 235  
 Putrescibility of water, determination of, I., 194  
 Puzzuolana cement, II., 83, 85  
 Pyriat, II., 11  
 Pyridine, I., 456  
 Pyrites, analysis of, I., 210, 211  
 — burner gas, I., 214, 221  
 — burnt, I., 214  
 — copper, I., 206, 217  
 — furnaces, I., 213  
 — in fire-clays, II., 230  
 — iron, I., 214  
 — kilns, I., 211 *et seq.*  
 — spent oxide from, I., 213  
 Pyrogallic acid, germicidal value, II., 3, 4  
 Pyrogallol—see *Pyrogallic acid*  
 Pyrolusite, I., 360  
 Pyrometers, I., 65-73; II., 177  
 — absorption, I., 67  
 — cements for, II., 136  
 — Cornu-Chatelier, I., 69  
 — Féry radiation, I., 69, 70, 71, 73  
 — Féry spiral, I., 71  
 — Krupp's, I., 75  
 — optical, I., 67, 68, 69, 70, 71, 73  
 — photometric, I., 69  
 — platinum resistance, I., 67  
 — Siemen's water, I., 75  
 — thermo-electric, I., 67, 68  
 — Wanner, I., 69  
 Pyrometric heating effect, I., 11  
 Pyrometry, I., 65 *et seq.*  
 Pyrope, II., 63  
 Pyrophoric alloys, II., 316-318, 327  
 Pyroscopes, I., 72, 73, 74, 75  
 Pyroscopy, I., 65 *et seq.*  
 Pyrosulphuric acid, I., 247

Pyrotechny, I., 354  
 Pyrozone, II., 7  
 Pyrrhottite, I., 206

## Q

Quartz, II., 63, 184  
 Quartz glass, II., 270-274  
 Quartzite, Findling, II., 232  
 — packing, I., 231  
 Quicklime, II., 78  
 — disinfecting properties, II., 13  
 — use as manure, II., 41  
 Quicksilver process of electrolysis, I., 374-375  
 Quinol, disinfecting properties, II., 4

## R

R.U.V. steriliser, I., 171, 172  
 Rabe process, I., 245  
 Radiations, radio-active, II., 385  
 Radio-actinium, II., 387  
 Radio-active elements, II., 383-398  
 — — — average life of, II., 386  
 — — — disintegration constant of, II., 386  
 — — — disintegration series of, II., 386, 387  
 — — — equilibrium of, II., 387, 388  
 — — — half-value period of, II., 386, 387  
 — — — literature, II., 383  
 — — — medicinal uses of, II., 396-397  
 — — — prices, II., 397-398  
 — — — radiation of, II., 384  
 — — — similarity to other elements, II., 387  
 — — — technically important, II., 388  
 — — — testing, II., 395, 396  
 — — — waters, I., 158, 198  
*Radio-elements—see Radio-active elements*  
 Radio-lead, II., 391, 392  
 Radio-thorium, II., 387, 388, 394, 395, 398  
 Radium, II., 384, 386, 388, 389, 390, 391, 397, 398  
 — cost of manufacture, II., 397-398  
 — luminous preparations of, II., 397  
 — C, II., 385  
 — D, II., 388  
 — bromide, II., 391, 398  
 — carbonate, 390, 391  
 — chloride, II., 390, 391, 397, 398  
 — Institute, II., 389



- Radium sulphate, II., 390, 391  
 Rags, use as manure, II., 39  
 Rails, testing joints of, II., 72-75  
 — welding by, II., 72  
 Rain water, I., 157, 158, 159  
 Ram pumps, II., 89  
 Ramie fibre, use in incandescent mantles,  
 II., 304-305  
 Rancidity, removal from oil, 422  
 Ransome's artificial stone, II., 134  
 Rape cakes, II., 38  
 Rape seed meal, II., 38  
 Rare earth oxalates, II., 301  
 — — sulphates, II., 301  
 Raschen cyanide process, I., 487, 488,  
 495  
 Rathenau furnace, II., 408  
 Raw cement flour, II., 98  
 — — meal, II., 98  
 Rays,  $\alpha$ , II., 385  
 —  $\beta$ , II., 385; see *Beta rays*  
 —  $\gamma$ , II., 385  
 — X—see *X-rays*  
 Reaction towers, I., 230  
 Readman-Parker phosphorus process, II.,  
 424  
 Receivers, hydrochloric acid, I., 276,  
 277  
 Recovered sulphur, I., 204  
 Recuperators, I., 30, 34, 43, 44  
 Red bricks, II., 202  
 — burning clays, II., 147, 160  
 — fire, I., 354  
 — glass, II., 269  
 — lead, as flux, II., 163  
 — — in enamels, II., 279  
 — — in glass, II., 249, 250  
 — overglaze, II., 189  
 — phosphorus, II., 426, 427  
 — plague, I., 168  
 Reducing agents, II., 327, 391  
 Refractory bricks, II., 200  
 — clays, II., 147  
 — materials, I., 58; II., 163, 229-234,  
 333, 403, 405, 406  
 Refrigerating absorption machines, I., 81  
 — compression, I., 77  
 — machines, I., 77 *et seq.*  
 — mixture, carbonic acid snow, I., 144  
 Regenerators, I., 30, 34, 43, 54; II.,  
 255  
 Reichardite, I., 329  
 Reinforced concrete, II., 118  
 — glass, II., 261  
 Reisert iron removing filter, I., 180, 181  
 — rapid filter, I., 162  
 — water-softening patent, I., 178  
 Resorcin, disinfecting properties of, II.,  
 34  
 Retarders of setting of plaster, II., 16  
 Retort furnaces, I., 41, 43  
 Retorts, gas, II., 231  
 — graphite, II., 405  
 — lutes, II., 135  
 Reverberating furnaces, I., 39, 40  
 Revolving black ash furnace, I., 292  
 Rhenania furnace, I., 215, 216, 218  
 Rhodin cell, I., 375  
 Rjukan falls, I., 441  
 Rice-hulling, II., 403  
 Riddled guano, II., 42  
 Rideal-Walker carbolic acid coefficient,  
 II., 1-3  
 Ring roll mills, II., 25  
 River water, I., 158  
 Robbia ware, II., 157  
 Robinson washer, I., 13  
 Rock crushers, II., 24  
 — crystal, II., 63  
 — salt, I., 262, 263, 330  
 Roland Wild calorimeter, I., 9  
 Roller mills, II., 26, 93, 95, 96  
 Rolls, toothed hedgehog, II., 92  
 Roman alum, II., 55  
 Roman cement, II., 85-86  
 Rongalite conc., I., 260  
 Roscoelite, II., 375, 376  
 Rosendale Portland cement, II., 86, 87  
 Rosenhain calorimeter, I., 9  
 Rotary crusher, II., 86, 92  
 Rotary kiln, II., 80, 99-103  
 — — fuel requirements, II., 103  
 — — plaster, II., 114-115  
 — weigher, II., 108  
 Rotation of crops, I., 428  
 Rottenstone, II., 420  
 Room, disinfection of, II., 12  
 Rouge, II., 164, 414, 419-420  
 Rouge flambé, II., 164, 190  
 Roulette mill, II., 96, 97  
 Rowart's sheet glass machine, II., 259  
 Royle's gravity filter, I., 164  
 — pressure filter, I., 165, 166  
 Rubbers (bricks), II., 147  
 Ruby, artificial, II., 52, 64  
 — Balas, II., 63  
 — natural, II., 63, 64  
 — reconstituted, II., 64  
 — thermite slag, II., 75  
 Rudersdorf kiln, II., 80  
 Ruggles-Coles drier, II., 83  
 Rumford kiln, II., 80  
 Rupert's drops, II., 243, 246  
 Russian asbestos, II., 282

Rust, prevention of, I., 172, 173  
 — joint cement, II., 119, 136  
 — removers, II., 420  
 Ruthenium, catalytic, I., 471  
 Rutile, II., 320, 323, 324, 328

## S

Saccharin, antiseptic properties, II., 6  
 Sachsenberg sulphur burner, I., 219, 254  
 Sack fillers, II., 108  
 Sackur's glass, II., 265  
 Safflowers, rouge from, II., 420  
 Sage plaster cement, II., 86  
 Sagger clays, II., 147  
 Sagger, II., 176, 177  
 Saint Gobin glass, II., 242  
 — Joachimsthal mines, II., 389  
 Sal ammoniac, I., 466; see *Ammonium chloride*  
 Salicylic acid, disinfecting properties of, II., 5  
 Salol, II., 5  
 Salophen, II., 5  
 Salt, I., 261-273  
 — antiseptic properties of, II., 14  
 — bay, I., 268  
 — by freezing, I., 265  
 — common, I., 268  
 — composition of, I., 268  
 — crystallisation of, I., 268  
 — drying of, I., 266, 267, 268  
 — electrolysis of, I., 369, 370, 388, 396-402  
 — fine-grained, I., 267  
 — fishing, I., 268  
 — from rock salt by fusion, I., 271  
 — from sea water, I., 264  
 — fuel consumption in production of, I., 270, 271  
 — glaze, II., 162, 195  
 — grain of, I., 268, 270  
 — hopper, I., 268  
 — insoluble in caustic alkali liquors, I., 378, 379  
 — licks, I., 268  
 — limits in water for fish life, I., 192  
 — lump, I., 267  
 — melting point, I., 285  
 — occurrence of, I., 261  
 — pans, I., 265, 266  
 — prices, I., 272, 273  
 — properties of, I., 271, 272  
 — rock, I., 263  
 — saturated solutions of, I., 304  
 — solar, I., 264

Salt, solubility in water, I., 301  
 — specific gravity of solutions of, I., 272  
 — statistics, I., 272  
 — table, I., 268  
 — tax, I., 273  
 — use in glass making, II., 247  
 — use as glaze, II., 162, 195  
 — use as manure, II., 41  
 — vacuum evaporators for, I., 269  
 Salt cake process, I., 275, 281, 289  
 — — properties, I., 285  
 Saltpetre, Chile; see *Chile saltpetre*, *Sodium nitrate*  
 — plantations, I., 434  
 — superphosphate, II., 42  
 Salufer, II., 11  
 Samarskite, II., 291, 337, 338  
 Sand, II., 163, 414  
 — definition of, II., 144  
 — for lime-sand bricks, II., 223  
 — in clay, II., 144  
 — in glass, II., 253  
 — removal from iron castings and graphite, I., 417  
 — use as abrasive, II., 419, 421  
 Sand blast, II., 262  
 — cement, II., 113  
 — filtration, I., 10  
 Sand-lime bricks, II., 201  
 Sand moulding, II., 206  
 — paper, II., 417, 418, 419  
 — scale, I., 268  
 — seal, II., 274  
 Sand's silica glass process, II., 273  
 Sandarac, II., 252, 421  
 Sandstone, millstones of, II., 414-415  
 — use as abrasive, II., 419  
 Sang de Bœuf, II., 164  
 Sanitary ware, II., 157, 193, 194  
 — — enamelled, II., 276-277  
 Sanitas, I., 423; II., 5, 6  
 Santorin earth, II., 82, 83  
 Sapphires, artificial, II., 52, 63, 64, 65  
 Satinite, I., 345  
 Saturators for ammonium sulphate, I., 458, 459  
 Savelsberg furnace, I., 216  
 Scab destroyers, II., 19  
 Scagliola, II., 130  
 Scale, I., 268, 347  
 — ammonia soda, I., 307  
 — ammonia stills, I., 316  
 — boiler, I., 172, 173, 174  
 — prevention of, I., 175-176  
 — salt pan, I., 268  
 Schaeffer-Budenberg's pyrometer, I., 65  
 Scheelite, II., 343, 344

- Schenk's scarlet phosphorus, II., 427  
 Scherfenberg furnace, I., 213  
 Schlempe, ammonia from, I., 454  
 — cyanide from, I., 488 489  
 Schlempekohle, I., 338, 488  
 Schlösing's process, I., 303  
 Schlutius' process, I., 471  
 Schmatolla's kiln, II., 80  
 Schneider kiln, II., 105  
 Schönherr furnace, I., 445  
 Schönite, I., 329, 330, 337  
 Schofer kiln, II., 79  
 Schofield brick machine, II., 210  
 Schoop's electrolytic bleaching cell, I.,  
 401, 402  
 Schreib's carboniser, I., 307  
 Schroeder grillo process, I., 245  
 — red phosphorus, II., 426  
 Schuchtermann-Kremer jig, I., 15  
 Schuckert electrolytic bleaching cell, I.,  
 396, 400, 401  
 Schütze automatic elevator, I., 231, 232  
 Schwartz process, II., 224  
 Schwerin electrical purification of clay,  
 II., 143  
 Scoop-wheel, II., 89  
 Scott's cement, II., 83  
 — electrical furnace, I., 446  
 — selenitic cement, II., 83  
 Scouring, solvent, I., 185  
 Scrap mica, II., 289  
 Screen separators, II., 28  
 Screw press, II., 35, 172, 173  
 Sea salt, I., 262  
 — — manufacture of, I., 264, 265  
 Sea water, action on cement, II., 111-  
 112  
 — — composition of, I., 262, 264  
 — — use in boiler, I., 174  
 — — use as manure, II., 43  
 Sea weed, iodine in, I., 407, 408  
 Secondary air furnace, I., 32, 43  
 Sedimentation, I., 158, 306  
 — sewage, I., 186  
 Seediness of glass, II., 260  
 Seger's cones, I., 72, 73, 74  
 — ruby glass, II., 267  
*Sel mixte*, I., 264  
 Selektor, I., 15, 16  
 Selenite, I., 346  
 Selenium, colouring glass with, II., 269  
 — in glass, II., 250  
 Self-hardening steel, II., 349  
 Semi-continuous kilns, II., 216, 217  
 Semi-dry process for bricks, II., 210 212  
 Semi-water gas, I., 119, 126, 127  
 Sentinel pyroscopes, I., 72  
 Separators, II., 28  
 Septic tanks, I., 186  
 Serpek process, I., 473-474  
 Serpentine asbestos, II., 282  
 Setting of cement, II., 85, 105, 106, 110,  
 111, 122, 124  
 — of plaster of Paris, I., 348; II., 116  
 — of Portland cement, II., 85, 105, 106,  
 110, 122, 124  
 Setting ovens, II., 175  
 Severn glass bottle machine, II., 257  
 Sevres ware, II., 189  
 Sewage, ammonia from, I., 455  
 — analysis of, I., 190, 191, 192, 193,  
 194  
 — constituents of, I., 183  
 — disinfection of, II., 8-9  
 — disposal of, I., 183, 186 *et seq.*  
 — filters for, I., 188, 189, 190  
 — grease recovery from, I., 191  
 — injurious substances in, I., 192  
 — Local Government Board requirements,  
 I., 190  
 — purification of, I., 188, 189, 190  
 — sludge as manure, II., 42, 43  
 Shaft kilns, I., 41; II., 104  
 — soot, II., 39  
 Shaking cooler, II., 103  
 Shales, II., 148  
 — alum, II., 144  
 — ammonia from, I., 454  
 — oil, I., 25; II., 148  
 Shank's lixiviating process, I., 293  
 Sheep-dips, II., 18-20  
 Sheet glass, II., 253, 258, 259, 260  
 — — crown, II., 260  
 — — fluted, II., 260  
 — mica, II., 287  
 Shellac, use in polishes, II., 421  
 Shells, II., 78  
 — use as manure, II., 41  
 Shenstone fused silica process, II., 272  
 Shippenbach furnace, I., 216  
 Ships, disinfection of, II., 12  
 Shoddy, manurial use of, II., 39  
 Shoe polishes, II., 421  
 Shrinkage of clays, II., 142  
 — — earthenware, II., 174  
 Sicily sulphur deposits, I., 201  
 Sideraphit, II., 349  
 Sidero cement, II., 112  
 Siemens' furnace, I., 43, 132  
 — pyrometer, I., 75  
 Siemens-de Vrise water ozonising tower,  
 I., 153

- Siemens - Halske electrolytic bleaching  
 plant, I., 399  
 — — ozone plant, I., 147, 151, 152  
 Sienna, II., 164  
 Siepermann's process, I., 485  
 Sieveless ball mill, II., 106.  
 Sievert's glass machine, II., 259-260  
 Silica, II., 63  
 — bricks, II., 232  
 — chemical constitution of, II., 238  
 — cyclic structure of, II., 238  
 — detection by dyes, II., 111  
 — estimation of, II., 119  
 — for glass, II., 247  
 — fused, II., 270-274  
 — in water, I., 173  
 — Martin's theory of, II., 238  
 — properties of, II., 273, 274  
 — thermometers, II., 274  
 — tridymite from, II., 233  
 — use as manure, II., 41  
 — vessels, I., 236  
 Silica glass, II., 270-274  
 — — properties of, II., 273-274  
 — — vacuum-tight seals for, II., 274  
 Silica-free glasses, II., 251  
 Silicates, II., 63  
 — Asch's theory of, II., 236-241  
 — chemical composition of, II., 236-241  
 — lutes and cements for acids, II., 135  
 — manurial value of, II., 41  
 — sodium, I., 133-134  
 Silicic acids, glass, II., 247  
 Silicofluoride, sodium, I., 418  
 — waterproofing plasters by, II., 119  
 Silico-phosphoric acid, II., 425  
 Silico-titanium, II., 327  
 Silicon, II., 406, 407  
 — acid resisting, I., 249  
 — bonds, II., 237-238  
 — hydrogen from, I., 116  
 — literature, II., 399  
 — properties of, II., 406, 407  
 Silicon carbide—see *Carborundum*  
 — iron, I., 236, 249, 277, 278  
 — monoxide, II., 403, 404  
 — nitride, I., 474  
 — tetrafluoride, I., 416, 417, 418  
 Silk, artificial, use in incandescent mantles,  
 II., 304, 305, 312, 313  
 — weighting of, II., 320, 334, 349  
 Sillimanite, II., 140  
 Silos, cement, II., 98, 99, 106, 107  
 — mixing, II., 99  
 Siloxicon, II., 399, 401, 403  
 Siloxide, I., 236  
 Silundum, II., 403  
 Silver, colouring glass with, II., 269  
 — — pottery with, II., 165, 189  
 — citrate, disinfecting properties of, II.,  
 16  
 — fluoride, disinfecting properties of, II.,  
 16  
 — lactate, disinfecting properties of, II.,  
 16  
 — mirrors, II., 263  
 — nitrate, disinfecting properties of, II.,  
 16  
 — overglaze, II., 189  
 — phosphide, II., 426  
 — salts, disinfecting properties of, II.,  
 16  
 — stain glass, II., 269  
 Silvester's waterproofing process, II., 118  
 Simon's sack fillers, II., 108  
 Sizing paper, II., 57  
 Skin meal, II., 39  
 Skins, deliming of, I., 419  
 Slag, blast furnace, II., 131, 252  
 — blocks, II., 130  
 — cement, II., 83-85  
 — drying, II., 83-84  
 — granulating, II., 83  
 — sand, II., 83  
 — use in glass making, II., 252  
 Slaked lime, I., 341; II., 78  
 Slates, II., 148  
 Slip, I., 348; II., 88, 159, 166, 167  
 Slop moulding, II., 206  
 Sludge, disposal of, I., 191  
 — use as manure, I., 191, 192  
 Slurry, II., 88, 166  
 Small coal, I., 7  
 Smidth cooler, II., 102  
 Smith's hearth, I., 62, 63  
 Smoke, I., 47, 48  
 — causes of, I., 47, 48  
 — prevention of, I., 33, 34, 36, 48, 133  
 — waste fuel in, I., 30, 31, 47, 48  
 Smokeless coals, I., 6  
 Snelus cement, II., 85  
 Soaking, II., 178  
 Soaps, aluminium, II., 57  
 — disinfecting properties of, II., 13  
 — dry, I., 426  
 — use as lutes and lubricants, II., 137  
 — use as polish, II., 421  
 Soft water, I., 160, 172, 182  
 Soda—see *Sodium carbonate*  
 Soda, caustic—see *Sodium hydroxide*  
 — in enamels, II., 278  
 — in glass making, II., 248

- Soda ash, I., 295  
 — — yield by ammonia soda process, I., 324  
 — crystals, I., 327  
 — lakes, I., 287, 299  
 — lime glass, expansion of, II., 245  
 — water, I., 197, 198  
 Sodamide, I., 486, 487  
 Sodium, action on water, I., 110  
 — cyanides from, I., 484  
 — metallic, I., 485  
 — quantity liberated by electrical current, I., 367, 368  
 Sodium alum, II., 56  
 — aluminate, I., 474; II., 50, 51, 52, 56  
 — amalgam, I., 374, 375  
 — arsenite, disinfecting properties of, II., 20  
 — azide, I., 496  
 Sodium bicarbonate, I., 141, 327, 328  
 — — calcination of, I., 318  
 — — composition of crude, I., 311  
 — — heat of calcination, I., 319  
 — — heat of decomposition, I., 319  
 — — precipitation of, I., 307, 308  
 — — solubility of, I., 301  
 — — temperature of decomposition, I., 319  
 Sodium bisulphate, I., 285  
 — — disinfecting properties of, II., 12  
 — — germicidal value of, II., 3  
 — bisulphite, I., 407  
 — borofluoride, II., 11  
 — bromate, I., 406  
 Sodium carbonate, I., 287-328  
 — — in glass making, II., 247, 253  
 — — hydrates of, I., 327  
 — — limiting amounts in water for fish, I., 192  
 — — manufacture by ammonia soda process, I., 299, 328  
 — — manufacture by electrolysis, I., 370  
 — — manufacture by Leblanc process, I., 291-298  
 — — natural, I., 287, 299, 300  
 — — removal from water, II., 60  
 — — statistics, I., 289  
 — — use as anti-incrustator, I., 176  
 Sodium chloride, I., 261-273; see also *Salt*  
 — — electrolysis of, I., 388  
 — — solution in ammonia, I., 302  
 — — voltage necessary for decomposition of, I., 368  
 Sodium chlorate, I., 385, 386, 388  
 — cyanamide, conversion into sodium cyanide, I., 491  
 Sodium cyanide, I., 483, 485; Castner process for, I., 486  
 — — disinfecting properties of, II., 11; from cyanamide, I., 490, 491; from schlempe, I., 489  
 — — statistics, I., 483  
 Sodium diuranate, II., 372  
 — ferrite, I., 296; II., 50  
 — formaldehyde bisulphite, I., 260  
 — — sulphoxylate, I., 260  
 Sodium ferrocyanide, I., 485, 491, 493  
 — — manufacture of, I., 491-493  
 — — properties of, I., 491  
 — hydrogen sulphate, I., 285  
 — hydrosulphite — see *Sodium hypsulphite*, I., 260  
 — hydroxide—see also under *Caustic soda*  
 — — amount liberated by electrical current, I., 367, 368  
 — — concentration of, I., 378, 379  
 — — disinfecting properties of, II., 13  
 — — electrolytic, statistics of, I., 360, 379  
 — hydroxy mercury benzoate, II., 15  
 — hypochlorite, I., 397, 402  
 — — disinfecting properties of, I., 402; II., 8-9  
 — — solid, I., 402  
 — hyposulphite, I., 259, 298  
 — iodate, I., 407, 431, 434  
 — iodide, I., 411  
 — nitrate, I., 420, 431-433  
 — — ammonium nitrate from, I., 326  
 — — mining of, 431, 432  
 — — nitric acid from, I., 437  
 — — occurrence of, I., 431  
 — — properties of, I., 432  
 — — statistics of, I., 432; II., 47  
 — — uses of, I., 433; II., 36-37  
 — nitrite, I., 436, 447, 448  
 — — nitrate, I., 448  
 — paratungstate, II., 349  
 — perborate, I., 425, 426  
 — percarbonate, I., 426  
 — perchlorate, I., 388, 389, 431, 434  
 — permanganate, II., 7  
 — permutite, II., 60  
 — peroxide, I., 421, 423  
 — — disinfecting properties of, II., 7  
 — — water purification by, I., 167  
 — potassium cyanide, I., 485  
 — pyrosulphate, I., 438  
 — pyrovanadate, II., 378

- Sodium salts, removal from water, II., 60
- sesqui-carbonate, I., 328
  - silicate, II., 133-134
  - — cements, II., 135-137, 415
  - — manure, II., 41
  - — waterproofing by, II., 119
  - silicofluoride, I., 418
  - — waterproofing by, II., 119
  - sulphate, I., 281-285, 330, 438
  - — ammonia soda process, I., 326
  - — for glass, II., 247
  - — in soil, I., 287
  - — iron free, I., 283
  - — properties of, I., 285
  - sulphide, I., 286, 296
  - — statistics, I., 289
  - sulphite, I., 256
  - sulphocyanide, I., 487, 495
  - thiosulphate, I., 259, 298
  - titanium sulphate, II., 328
  - tungstate, II., 349
- Soffioni, I., 355
- Soft mud machines, II., 206
- Soils, II., 148
- nitrates in, I., 427, 428, 429, 434
- Solar salt, I., 264
- Solid ammonia, I., 467
- carbon dioxide, I., 143
  - fuels prepared, I., 16, 21
  - sodium aluminate, II., 56
  - solutions, II., 140, 241, 267
- Solo mill, II., 98
- Soluble anhydrite, I., 347
- glass, II., 133-134; see also *Sodium silicate*
  - Prussian blue, I., 494
  - superphosphate, II., 31
- Solvay-Kellner cell, I., 375
- Solvay towers, I., 307
- Solvent scouring, I., 185
- Soot, I., 48
- analysis of, II., 39
  - use as manure, II., 39
- Sorel cement, I., 366; II., 127, 128, 130, 415
- Spackman kiln, II., 103
- Spanish ware, II., 157
- Specific gravity, determination of, II., 120
- — of slips, II., 167
  - — of sulphuric acid, I., 249
- Spent oxide, I., 210, 213, 214
- — arsenic in, I., 213
  - — from gas works, I., 493
- Spiders, II., 355, 364
- Sphene, II., 63, 323, 324
- Spinel, II., 63, 64
- Spissograph, II., 124
- Spogumene, II., 63
- Spontaneous combustion of coal, I., 19
- Sprays, water, in acid chambers, I., 233
- Sprengel pump, II., 353
- Spring waters, I., 158, 159
- Spun glass, II., 244
- Stable soluble blue, I., 494
- Staff, I., 349; II., 118
- Staffordshire kiln, II., 222
- Stage kiln, II., 104
- Stained glass, II., 267
- Stains (earthenware), II., 157-159
- Stamp mills, II., 26
- Stamping mills, II., 414
- Stannic oxide, use in glasses, II., 165
- Stassfurt deposits, I., 329-333, 335, 403; II., 40
- Statuary porcelain, II., 154
- Stead's process for carbon dioxide, I., 142
- Steam, action on carbon, I., 124
- superheated, for ammonia distillation, I., 317
- Steam boiler furnaces, I., 31-39
- — gauges, glass for, II., 265
  - coal, I., 6
  - generation by surface combustion, I., 59
  - jets, replacing by water sprays, I., 223, 233
  - joints, amounts for, II., 136
  - navy, II., 202
  - pipes, lagging for, II., 133, 134, 136
- Stearic acid, I., 118
- Steatite, II., 184
- Steel, chromium, II., 69
- crushed, use as abrasive, II., 419
  - enamelled, II., 276-277
  - high speed tool, II., 381
  - making, use of CO<sub>2</sub> in, I., 144
  - manganese, II., 70
  - melting by thermite, II., 72
  - molybdenum, II., 70
  - refining, II., 326
  - self-hardening, II., 349
  - tool, II., 70
  - uranium, II., 372, 373
  - use of titanium for refining, II., 326
- Stein ribbed kiln, II., 105
- Stellite, II., 349
- Sterilisation of water, I., 182
- — — by ultra-violet rays, II., 372
- Sterilised water, use of, I., 172
- Sticking up earthenware, II., 172

- Stiff-plastic process for bricks, II., 208-210  
 Stilbite, II., 59  
 Stills, ammonia—see *Ammonia stills*  
 Stock bricks, II., 199  
 Stone-breakers, II., 92, 414  
 Stones, artificial, I., 419; II., 129-130  
 — Cornish—see *Cornish stones*  
 — in glass, II., 260  
 — precious—see *Precious stones*  
 — Ransome's artificial, II., 134  
 — reconstructed, II., 130  
 Stoneware, II., 154, 193-198  
 — chemical, II., 195  
 — culinary, II., 195  
 — fine, II., 194  
 Stove polishes, II., 421  
 Strass, II., 65, 265, 266  
 Striæ in glass, II., 260  
 Stringiness of glass, II., 260  
 Strontium, metallic, I., 353  
 — uses of, I., 354  
 Strontium chloride, I., 192, 353  
 — dioxide, I., 353  
 — hydroxide, I., 353, 354  
 — oxide, I., 353  
 — nitrate, I., 354  
 — salts, I., 353-354  
 Strüverite, II., 323, 324  
 Stuart's granolithic stone, II., 129  
 Stucco, II., 18  
 Sturtevant Newaygo separator, II., 27  
 Sublamen, II., 15  
 Sucrates, I., 488  
 Suction gas-producer, I., 135  
 Suerth system, I., 142  
 Sugar industry, use of permutite in, II., 60  
 — — — of strontium salts in, I., 354  
 — manufacture, I., 144  
 — refining, water for, I., 183  
 Sulis water, I., 198  
 Sulphate, calcium, I., 174, 175; see *Calcium sulphate*  
 — estimation of, II., 120  
 — in water, I., 160, 173, 178  
 Sulphate of alumina—see *Aluminium sulphate*  
 — of ammonia—see *Ammonium sulphate*  
 — of potash—see *Potassium sulphate*  
 Sulphides, estimation of, II., 120  
 Sulphites, analysis of, I., 256  
 — disinfecting properties of, II., 13  
 — manufacture of, I., 253-256  
 Sulpho-cyanides, recovery from coal-gas, I., 494-495  
 — synthetic, I., 495  
 Sulphur, I., 201-206  
 — Chance-Claus process for, I., 298  
 — disinfecting properties of, II., 13  
 — estimation of, II., 120  
 — extraction of, I., 201-203  
 — fungicidal value of, II., 17-18  
 — in cement, II., 109  
 — occurrence, I., 201  
 — properties of, I., 205  
 — recovered, I., 204, 298  
 — refining of, I., 202  
 — removal from coke, I., 19  
 — statistics, I., 203  
 — uses of, I., 205  
 — varieties of, I., 205  
 Sulphur burners, I., 217-220, 254-256  
 Sulphur dioxide, analysis of, I., 256  
 — — anhydrous, I., 253, 254  
 — — detection in HCl, I., 278  
 — — disinfecting properties of, II., 12-13  
 — — estimation of, I., 221  
 — — kilns for, I., 211-220  
 — — latent heat of evaporation, I., 80  
 — — manufacture of, I., 253-256  
 — — oxidation of, I., 223, 225, 239, 240, 241  
 — — poisoning of plants by, I., 256  
 — — properties of, I., 256  
 — — purification of, for contact process, I., 243, 244  
 — — tension of, I., 256  
 — — uses, I., 78, 79, 253, 256  
 — — vapour tension of, I., 79  
 — dyes, I., 268  
 — fungicides, II., 17  
 — trioxide, absorption of, I., 243, 244, 245  
 — — condensation of, I., 245, 246  
 — — estimation of, I., 221  
 — — formation of, I., 239, 240, 241, 246  
 — — heat of formation, I., 240, 241  
 — — Mannheim process for, I., 244  
 — — properties of, I., 246, 247  
 — — Schroeder-Grillo process for, I., 245  
 — — temperature of formation, I., 240, 241, 242, 243  
 — — theory of formation, I., 241, 242  
 Sulphuretted hydrogen, I., 260  
 — — furnace for burning to sulphur, I., 219, 220  
 — — poisonous amounts of, I., 192  
 — — sulphuric acid from, I., 210  
 — — treatment of, I., 461  
 Sulphuric acid, I., 207 *et seq.*  
 — — action on metals, I., 249  
 — — analysis of raw materials, I., 210  
 — — arsenic free, I., 217

- Sulphuric acid, arsenic in, I., 235  
 — — boiling point of, I., 238, 248  
 — — chamber process for, I., 206  
 — — concentration of, I., 235  
 — — contact process for, I., 206, 210, 239  
 — — conveyance of, I., 251  
 — — costs of manufacture, I., 246, 247  
 — — decolorisation of, I., 246  
 — — decomposition of, I., 238  
 — — disinfecting properties of, II., 12  
 — — distillation of, I., 235  
 — — electrolysis of, I., 114  
 — — estimation of, I., 252  
 — — formation of, I., 223, 225  
 — — from galena, I.; 210  
 — — from spent oxide, I., 210  
 — — from zinc blende, I., 210  
 — — fuming, I., 251  
 — — heat of formation, I., 225  
 — — hydrates of, I., 247  
 — — impurities in, I., 250  
 — — injurious amounts in water, I., 192  
 — — methods of production, I., 208  
 — — nitrogen oxides in, I., 251  
 — — non-fuming, I., 248  
 — — ordinary, I., 247, 248  
 — — poisoning by, I., 248  
 — — raw materials for, I., 206  
 — — removal from HCl, I., 278  
 — — removal of nitrogen oxides from, I., 235  
 — — statistics, I., 205  
 — — specific gravity, I., 249, 250, 251  
 — — storage of, I., 251  
 — — sulphur dioxide for, I., 211 *et seq.*  
 — — transport of, I., 238  
 — — uses of, I., 208, 252  
 — — varieties of, I., 248  
 — — vessels for, I., 252  
 — — water sprays for, I., 225, 233  
 — — yield of, I., 225  
 Sulphurous acid, disinfecting properties of, II., 12-13  
 — — injurious amounts in water, I., 192  
 — — properties of, I., 256  
 — — bacterial power of, I., 158, 169  
 Super cement, II., 112, 119  
 Superheated steam, I., 49, 317  
 — water, action on glass, II., 246  
 Superheater, I., 41, 42, 49  
 Superoxides, I., 421  
 — ammoniated, I., 467  
 Superphosphate dens, I., 418; II., 30  
 — industry, hydrofluorsilicic acid from, I., 417-419  
 Superphosphate manufacture, II., 28-32  
 — plant, II., 28-32  
 — statistics, II., 47  
 Surface clays, II., 148  
 — combustion, I., 57, 58, 62, 63, 132  
 Sutton-Steele dry concentration table, II., 295  
 Swimming baths, disinfection of, II., 9  
 Swing-jaw stone-breaker, II., 92  
 Sylvin, I., 329, 330, 336  
 Synthetic ammonia, I., 118, 441, 455, 469-474  
 — sulpho-cyanides, I., 495  
 Syphilis, I., 423; II., 15
- ## T
- Table glass, II., 242, 251  
 — salts, I., 268  
 Tachiol, II., 16  
 Tachhydrite, I., 329  
 Tacoma nitrate beds, I., 433  
 Tafelglas, II., 251  
 Talbot producer, I., 130, 131  
 Tantalalic oxide, II., 337  
 Tan, in boilers, I., 175  
 Tangential chambers, Meyer's, I., 227  
 Tank waste, I., 294  
 Tannic acid, use as stove polish, II., 421  
 Tantalite, II., 337, 338  
 Tantalum, II., 337-341  
 — estimation of, II., 341  
 — manufacture, II., 338-339  
 — melting point of, II., 355  
 — metallic, II., 338-341  
 — properties of metallic, II., 340  
 — use as a filament, II., 355  
 — uses, II., 340  
 Tantalum alloys, II., 341  
 — electrodes, II., 341  
 — instruments, II., 340  
 — lamp, II., 356-357  
 — — efficiency of, II., 366  
 — ores, II., 338  
 — pens, II., 341  
 — tools, II., 340  
 Tantiron, I., 236, 249, 277, 278  
 Tapiolite, II., 338  
 Taps, stoneware, II., 196  
 Tar, I., 52, 55  
 Tarapaca nitrate beds, I., 431, 433  
 Tartaric acid, II., 5  
 Taylor's furnaces for carbon disulphide, I., 257, 258



- Taylor producer, I., 130  
 Teeth, artificial, II., 191  
 Teissier-Chaillan hydrogen process, I., 117  
 Tellurium colouring glass, II., 269  
 Temperature of combustion, lowering of, I., 480  
 — exchanger, I., 84, 85  
 — of ignition, I., 44  
 Temperatures, highest attainable by fuels, I., 45, 46; see *Calorific intensity*  
 Temporary hardness, I., 172  
 Tender clays, II., 148  
 Tensile strength, estimation of cement, II., 121  
 Tentelew's process, I., 245  
 Terra alba, I., 345  
 Terra-cotta, II., 152, 226-227  
 Testalin, II., 57  
 Testing raw materials in pottery, II., 165  
 Testmaja's instrument, II., 123  
 Textile industry, effluents, I., 183  
 — — use of tungsten in, II., 349  
 Thelen evaporator, I., 294  
 — pans, I., 318, 319  
 Thermal syndicate process, II., 273  
 Thermite, I., 1; II., 67-75  
 — alumina from, II., 52  
 — bombs, II., 71, 72  
 — fire, II., 71  
 — heat of reaction, II., 71  
 — slag, II., 75  
 — steel, II., 75  
 — use as heating agents, II., 71, 72  
 — welding rails by, II., 72  
 Thermo-electric pyrometer, I., 67, 68  
 Thermometers, I., 65, 66, 67  
 — air, I., 65, 67  
 — electrical, I., 65, 66  
 — glass for, II., 265, 270  
 — mercurial, I., 65, 66  
 — silica, II., 274  
 Thermoscopes, Holdcroft's, I., 73, 74  
 Thickening liquids, II., 404  
 Thiocyanates, I., 494; see also *Sulphocyanides*  
 Thiogen process, I., 204  
 Thiophosphites, II., 431  
 Thiosulphate, sodium, I., 259, 298  
 Thomas-Gilchrist furnaces, bricks for, II., 233  
 — — process, II., 32, 33  
 — phosphate, II., 32, 33  
 — slag, II., 32, 33  
 Thoria, II., 291  
 — catalytic oxidation of, I., 449  
 Thoria, effect of cerium on luminosity of, II., 303, 304  
 — recovery from waste mantle ash, II., 302  
 — volume from nitrate by ignition, II., 304  
 Thorianite, II., 292, 296, 297, 369, 388  
 Thorite, II., 291, 292, 296, 297, 369  
 Thorium, II., 291-361  
 — colloidal, II., 315, 363  
 — disintegration of, II., 386  
 — melting point of, II., 355  
 — radio-activity of, II., 384  
 — radio-active constants of, II., 387  
 — sources of, II., 388  
 — use as a filament, II., 355  
 Thorium compounds, uses, II., 299, 315  
 — D, II., 385  
 — emanation, II., 395  
 — minerals, II., 297, 298  
 — nitrate, 297, 299-303  
 — oxalate, II., 301  
 — series, II., 387  
 — silicate, II., 296  
 — sulphate, II., 300  
 Thorna furnaces, I., 213  
 Throwing clay, II., 170  
 — porcelain, II., 187  
 Thuringen glass, II., 242  
 Thwaite cupola producer, I., 122, 123  
 — simplex producer, I., 129  
 Thymol, use as disinfectant, II., 4  
 Tiles, II., 157, 197-198, 225-226  
 — encaustic, II., 225  
 — glazed, II., 226  
 — literature, II., 225  
 — paving, II., 225  
 — roofing, II., 225  
 — tests for, II., 198  
 Tin alloys, II., 70  
 — chloride, colouring pottery with, II., 165  
 — oxide, II., 189  
 — — colouring glass with, II., 269  
 — — in enamels II., 277  
 — — in glazes, II., 165  
 — pinks, II., 165  
 Tincal, II., 162  
 Tindal-de Vrise ozoniser, I., 148  
 Titaniferous iron ore, II., 323, 324  
 Titanite, II., 323  
 Titanium, II., 323-330, 355  
 — alloys, II., 70, 318, 325-327  
 — estimation in steel, II., 329  
 — literature of, II., 323

- Titanium, metallic, II., 327  
 — nitrogen fixation by, II., 327  
 — occurrence of, II., 323-324  
 — pyrophoric alloys, II., 327  
 — statistics of, II., 325  
 — utilisation of, II., 325-329, 355  
 Titanium aluminium alloy, II., 325, 327  
 — carbide, II., 326; electrodes, II., 328;  
   filaments, II., 328, 366  
 — copper alloys, II., 327  
 — dioxide, II., 323, 324  
 — ferro alloys, II., 325-327  
 — filaments, II., 366  
 — lactates, II., 328  
 — minerals, analysis of, II., 329  
 — — value of, II., 324, 325  
 — nitride, I., 474; II., 327  
 — ores, II., 324  
 — oxide, II., 189, 191  
 — pigments, II., 328  
 — salts, uses, II., 320, 328  
 — silicon alloys, II., 327  
 — thermite, II., 70  
 Titanous chloride, II., 327  
 — sulphate, II., 327  
 Tobacco dips, II., 20  
 — extracts, II., 20  
 Tobacco-sulphur dips, II., 19-20  
 Tomblée-Paul furnace, I., 219  
 — — sulphur burner, I., 254  
 Toning solutions, vanadium, II., 381  
 Tools, tantalum, II., 340  
 Tooth-powders, I., 422, 423; II., 419  
 Toothed hedgehog rolls, II., 92  
 Topaz, II., 63  
 Töpler pumps, II., 353  
 Torbeanite, II., 370, 371  
 Totenhaupt's phosphorus, II., 427  
 Tourmaline, II., 163  
 Tower acid, I., 248  
 — hydrochloric acid, I., 279  
 — systems for sulphuric acid, I., 238  
 Towers, absorption, I., 277, 304, 305  
 — Gaillard, I., 236  
 — packing for, I., 231  
 — Solvay, I., 307  
 — theory of, I., 229  
 Town refuse, use as manure, II., 42, 43  
 Townsend cell, I., 371, 373  
 Transvaal gold industry, I., 483, 484  
 Trass, II., 82, 83  
 Travancore monazite, II., 292  
 Tremolite asbestos, II., 281, 282, 284  
 Trials, I., 74; II., 177  
 Tribromonaphthol, II., 4  
 Triformal, II., 6  
 Trimethylamine, I., 489  
 Tripoli powder, II., 414, 420, 421  
 Trona, I., 287  
 Tube mills, II., 24-25, 89, 96, 97, 98, 107  
 Tubing, glass, II., 253  
 Tumblers, glass, II., 257  
 Tungstate, sodium, II., 349  
 Tungsten, II., 343-350  
 — catalytic, I., 471  
 — colloidal, II., 363  
 — drawing, II., 361  
 — ductile, II., 348  
 — estimation, II., 350  
 — ferro, II., 347  
 — literature, II., 343  
 — melting point of, II., 355  
 — metallic, cost of production, II., 347  
 — — manufacture, II., 345-346, 360  
 — — properties, II., 348  
 — powder, II., 347, 360  
 — uses, II., 348, 349  
 Tungsten alloys, II., 349, 352  
 — bars, furnace for, II., 360  
 — bronzes, II., 349, 350  
 — electric furnace, II., 360  
 — electro-contacts, II., 349  
 — filaments, I., 117; II., 355, 358-363,  
   366  
 — lamp, II., 357-366  
 — lithium bronze, II., 349  
 — ores, II., 343, 344, 345  
 — oxide, colouring porcelain with, II., 349  
 — — — glass, II., 349  
 — powder, II., 347, 360  
 — sodium bronzes, II., 349  
 — steel, II., 348  
 — wire, II., 361  
 Tunnel drier, II., 99, 212-214  
 — kiln, II., 177, 181  
 — ovens, II., 175  
 Turner's cement, II., 137  
 Turning clay, II., 170  
 Turquoises, II., 63

## U

- Ulexite, I., 357  
 Ultra-violet light, II., 372  
 — — — destruction of bacteria by, I., 158  
 — — — opaqueness of glass to, II., 244  
 — — — ozone formation by, I., 146  
 — — — sterilisation by, I., 169-172; II.,  
   372  
 — — — use in chamber process, I., 223

Ulzer-Somner process of radium extraction, II., 390  
 Underfeed stoker, I., 35, 36  
 Underglaze colours, II., 188, 189  
 — painting, II., 180  
 Unglazed pottery, II., 152  
 United Alkali Co., I., 288  
 United States asbestos deposits, II., 282  
 — — carnotite deposits, II., 370  
 — — pitchblende deposits, II., 370  
 — — vanadium deposits, II., 376  
 Uralite, II., 134  
 Urals, asbestos in, II., 282  
 Uraninite, II., 369  
 Uranium, I., 118; II., 369-374, 388  
 — arc lamps, II., 372  
 — catalytic, I., 471  
 — colouring glass by, II., 373  
 — disintegration of, II., 386  
 — dissociation of, II., 385  
 — estimation of, II., 373  
 — literature, II., 369  
 — metallic, II., 372  
 — occurrence of, II., 369  
 — radio-active constants, II., 386  
 — sources of, II., 388  
 — use in ceramic industry, II., 373  
 — utilisation of, II., 372, 373  
 Uranium, colours, II., 373  
 — filaments, II., 366  
 — glazes, II., 373  
 — micas, II., 372  
 — minerals, analysis of, II., 373  
 — nitrate, II., 373  
 — ores, II., 370, 371, 384  
 — oxide, II., 189, 372  
 — — colouring pottery with, II., 165  
 — steels, II., 372, 373  
 Urano-circite, II., 370  
 Urea, ammonia from, I., 455  
 — ammoniacal fermentation of, I., 428, 455; II., 37  
 — decomposition by nitrous acid, I., 428  
 — — in soil, I., 424, 480  
 — excretion of, I., 427, 428, 429; fermentation of, I., 480; from calcium cyanamide, I., 480; II., 37  
 — liberation of nitrogen by, I., 428, 429  
 Urease, I., 428  
 Urine, I., 428  
 — ammonia from, I., 455  
 — phosphorus in, II., 423  
 — statistics, I., 455  
 Urotropine, II., 6  
 Utah Sea, I., 263  
 Uviol glass, II., 265

## V

Vacuum evaporators, I., 269, 270, 378  
 — pumps, II., 353  
 — tight seals for silica, II., 274  
 Valentiner's vacuum process for nitric acid, I., 440  
 Vanadic acid, II., 379  
 — oxide, II., 375  
 Vanadinite, II., 375, 376  
 Vanadium, II., 375-382  
 — acid extraction process, II., 377  
 — alkaline extraction process, II., 378 379  
 — analysis of, II., 382  
 — electrolytic deposition of, II., 379  
 — ferro, II., 380  
 — literature, II., 375  
 — metallic, II., 380  
 — occurrence of, II., 375  
 — recovery from mill solution, II., 379  
 — uses, II., 381  
 Vanadium alloys, II., 70, 380, 381  
 — carbide filaments, II., 366  
 — colours, II., 381  
 — inks, II., 381  
 — mordants, II., 381  
 — ores, II., 376, 377, 382  
 — oxide, I., 240; II., 375  
 — steel, II., 375, 380, 381  
 Varch, I., 408  
 Vaseline, extraction of iodine with, I., 411  
 Vases, II., 157  
 Vassy cement, II., 86  
 Venetian glass, II., 242, 270  
 Verbundglas, II., 265  
 Verneuil's blowpipe, II., 64  
 Vertical jigger, II., 171  
 — kiln, II., 103  
 Vicat needle, II., 123  
 Victoria stone, II., 129  
 Vinasse, ammonia from, I., 454  
 — cinder, I., 338  
 Vincent's process, I., 338  
 Violet glass, II., 269  
 Viscose silk, use in incandescent mantles, II., 304  
 Vitreosil, I., 236; II., 273  
 Vitriifiable clays, II., 149  
 Vitriol, oil of, I., 248  
 Vitriolised bones, II., 32  
 Voelker's electric furnace, II., 255  
 Volatile ammonium salts, I., 456, 457  
 Voleker's silica glass process, II., 273  
 Volvic lava, I., 227, 236  
 Vosmaer system, I., 149

## W

- Wall plasters, I., 347, 349  
 Wanner pyrometer, I., 69  
 Ward's stone, II., 129  
 Ware, sanitary, II., 157  
 — shaping of, II., 169-174  
 Wash leather, II., 420  
 — mill, for cement, II., 87, 88  
 Washing machine for incandescent  
   mantles, II., 306, 307  
 Waste gases, acid, I., 235, 238  
 — products, use as manure, II., 40  
 Watch dials, enamelled, II., 277  
 — — luminous, II., 397  
 Water, acid in, I., 173  
 — action on carbon, I., 112  
 — — on cellulose, I., 111  
 — — on metals, I., 110  
 — — on non-metals, I., 112  
 — aerated, I., 195-200  
 — alkaline, I., 172, 173  
 — analysis of, I., 193  
 — artificial mineral water, I., 195  
 — bacteria in, I., 161  
 — chlorine in, I., 159, 160, 173  
 — disinfection of, II., 8-9  
 — dissociation temperature of, I., 45  
 — distillation of, 166  
 — drinking, I., 159  
 — estimation of nitrates in, I., 192  
 — evaporation of, by fuels, I., 45  
 — filtration of, I., 161 *et seq.*  
 — for boilers, I., 172-175  
 — for dairies, I., 183  
 — for dyeing, I., 182  
 — for paper mills, I., 182  
 — for sugar refining, I., 183  
 — freeing from oil, I., 174-175  
 — ground, I., 158, 159  
 — hard, I., 160, 172, 173, 176-183  
 — iron in, I., 168, 180, 181, 182  
 — laundry, I., 182  
 — lead in, I., 161, 168, 172  
 — lithia, I., 198  
 — loss of fuel by hard, I., 173  
 — magnesium in, I., 173  
 — mineral table, I., 197  
 — natural, I., 157  
 — nitrates in, I., 159  
 — nitric acid in, I., 159, 160  
 — nitrites in, I., 159, 194  
 — oil in, I., 174, 175  
 — organic matter in, I., 158, 159  
 — oxygen consumption value, I., 160  
 — — content vital to fish life, I., 192  
 Water, ozone treatment of, I., 151  
 — permanganate treatment of, II., 60  
 — phosphoric acid in, I., 160  
 — pollution of, I., 160  
 — potash, I., 198  
 — properties of, I., 103  
 — purification by aluminium salts, I., 166  
 — — by aqua-regia, I., 168  
 — — by bleaching powder, I., 167  
 — — by bromine, I., 168  
 — — by calcium peroxide, I., 167  
 — — by chlorine, I., 167  
 — — by copper sulphate, I., 168  
 — — by electrolytic chlorine, I., 167  
 — — by hydrogen peroxide, I., 167  
 — — by hypochlorites, I., 167, 168  
 — — by iron salts, I., 166  
 — — by lime, I., 167  
 — — by magnesium peroxide, I., 167  
 — — by oxidation, I., 167  
 — — by ozone, I., 151, 168, 169  
 — — by perhydrol, I., 167  
 — — by permanganate, I., 167  
 — — by precipitation, I., 166  
 — — by sodium peroxide, I., 167  
 — radioactive, I., 158, 198  
 — rain, I., 159  
 — removal of alkali from, II., 61  
 — — of calcium from, I., 160, 172,  
   173, 176-183; II., 60; see *Soft  
   water*  
 — — of gold from, II., 61  
 — — of iron from, II., 60, 61  
 — — of magnesium from, I., 160, 172,  
   173, 176-183; II., 60  
 — — of manganese from, II., 60, 61  
 — — of potassium from, II., 60  
 — — of sodium from, II., 60  
 — river, I., 158  
 — self-purification of, I., 158  
 — soda, I., 198  
 — soft, I., 160, 172, 176-183  
 — sprays, I., 225, 233, 418  
 — spring, I., 158, 159  
 — sterilisation, I., 166 *et seq.*, 168, 169,  
   170, 171, 172  
 — — by ozone, I., 169  
 — — by permanganate, I., 182  
 — — by permutite, II., 61  
 — — by ultra-violet rays, I., 169-172  
 — technology of, I., 157 *et seq.*  
 — use of sterile, I., 172  
 Water-gas, I., 102, 112, 117, 119, 123  
 — — ammonia from, I., 453  
 — — composition of, I., 126  
 — — hydrogen from, I., 101, 112

Water-gas, uses of, I., 133  
 Water-glass, II., 41, 133-134, 251, 415;  
     see also *Sodium silicate*  
 Water power, I., 368, 475  
 Waterproofing, cement mortar, II., 118  
     — cloth, II., 57  
     — concrete, II., 118  
 Water tube boiler, I., 39, 41  
 Weathering of fuel, I., 19  
 Wedge mechanical furnace, I., 212, 215  
 Wedging of slip, II., 168  
 Wedgwood's pyroscope, I., 74, 75  
 Weighing machine, II., 108  
 Welding by thermite, II., 71  
 Weldon chlorine, bleaching powder from,  
     I., 393  
     — process, I., 360-362  
 Weldon-Pechinery process, I., 366  
 Wells, artesian, I., 159  
 Welsbach mantles, II., 291, 303, 304  
 Wet fish scrap, II., 34  
     — grinding, II., 88, 89, 166  
 Wetherill magnetic separator, II., 296  
 Whale meal, II., 36  
 Wheeling forced feed washer, II., 92  
 Whipple temperature indicator, I., 69  
 Whirlers, II., 174  
 White bricks, II., 203  
     — caustic, I., 296  
     — clays, II., 160, 164  
     — glass, II., 243  
     — glass, opaque, II., 269, 270  
     — lead, in enamels, II., 279  
     — lead, use of flux, II., 163  
     — overglaze, II., 189  
     — Portland cement, II., 112  
     — stuff, II., 401, 402  
     — sulphate of alumina, II., 54  
     — ware, II., 195  
 Whiting, I., 141  
     — use as glaze, II., 162  
     — use as polish, II., 144  
 Whole guano, II., 36  
 Wiborgh phosphate, II., 32  
 Wieliczka salt mines, I., 261  
 Wild calorimeter, I., 9  
 Wilfey tables, II., 295  
 William's purifier, I., 495  
 Williamson's blue, I., 494  
 Windhausen machine, I., 81  
 Window glass, II., 253  
 Wire cut process for bricks, II., 207  
 Wire drawing, tungsten, II., 361  
 Wireless rectifying crystals, II., 403  
 Witherite, I., 351  
 Wöhler phosphorus process, II., 423

Wolframite, II., 343, 344  
 Wollastonite, II., 244  
 Wood, cements for joining metal to, II.  
     137  
     — fireproofing, II., 57  
     — potash in, I., 338  
     — use as fuel, I., 2  
     — water evaporated by, I., 45  
 Woodall-Moon test for mantles, II., 314  
 Woodcock's instrument, II., 123  
 Wool, bleaching by hydrogen peroxide  
     I., 423  
     — injury by sulphur-lime dips, II., 19  
     — washing, suds from, I., 184  
     — waste, use as manure, II., 39  
 Wounds, treatment with hypochlorites, I  
     402  
 Wyld furnaces, I., 213

X

X-rays, II., 384, 398  
     — glass for bulbs, II., 253  
     — photographs, II., 334  
 Xenotime, II., 369  
 Xylolite, II., 128  
 Xylolith, I., 366

Y

Yeadon's briquette machine, I., 22  
 Yellow clays, II., 149, 160, 164, 166  
     — colours, II., 328, 349  
     — glass, II., 269  
     — overglaze, II., 189  
 Ytterbium oxalate, II., 301  
 Yttrium oxalate, II., 301  
 Yttrio-tantalite, II., 338

Z

Zeolites, II., 150  
     — artificial, II., 59, 60, 61  
     — natural, II., 59  
 Zeppelin dirigibles, I., 115  
 Zinc, action on alkalis, I., 116  
     — action on water, I., 110  
     — alloys, II., 70, 318  
     — anti-incrustator, I., 175, 176  
     — disinfecting properties of, II., 16  
     — manufacture, I., 327

- Zinc blende, I., 206, 207, 214  
 — chloride, disinfecting properties of, II., 16  
 — — germicidal value of, II., 3  
 — copper couples, action on water, I., 110  
 — oxide, in enamels, II., 277  
 — — in glass, II., 248, 353  
 — — in glazes, II., 165  
 — perhydrol, I., 422  
 — peroxide, I., 422 ; II., 7  
 — salts, disinfecting properties, II., 16  
 — silico-fluoride, II., 119  
 — sulphate, disinfecting properties, II., 16  
 — sulphide, luminous preparations with radium, II., 397  
 Zircon, II., 63, 331, 332  
 Zirconia bricks, II., 233  
 — crucibles, II., 272  
 — filaments, II., 334  
 Zirconia gas mantles, II., 334  
 — illuminants, II., 334  
 — quartz ware, II., 333  
 — refractory materials, II., 333  
 — statistics, II., 335  
 Zirconium, II., 331-335, 355  
 — estimation of, II., 335  
 — filaments, II., 355  
 — literature, II., 331  
 — metallic, II., 333  
 — occurrence of, II., 331  
 — pigments, II., 334  
 — uses, II., 332-335  
 Zirconium acetate, II., 334  
 — carbide, II., 334  
 — — filaments, II., 366  
 — ores, II., 334  
 — silicate, II., 63  
 Zschimmer's glass, II., 265

# Edgar Allen & Co<sup>Ltd.</sup>

"STAG"  
BALL & TUBE  
MILLS  
for wet or dry  
crushing

ROTARY  
DRYERS

MIXERS

CONVEYERS

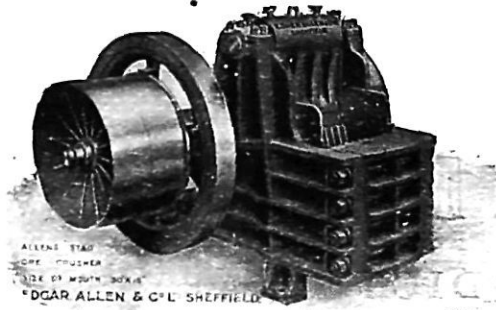

ALLEN'S STAG  
ORE CRUSHER  
SIZE OF WORK 30" X 18"  
EDGAR ALLEN & CO. L<sup>D</sup> SHEFFIELD

"STAG" ORE  
CRUSHERS  
and STONE-  
BREAKERS

SCREENS

AIR  
SEPARATORS

## Pulverising Plants

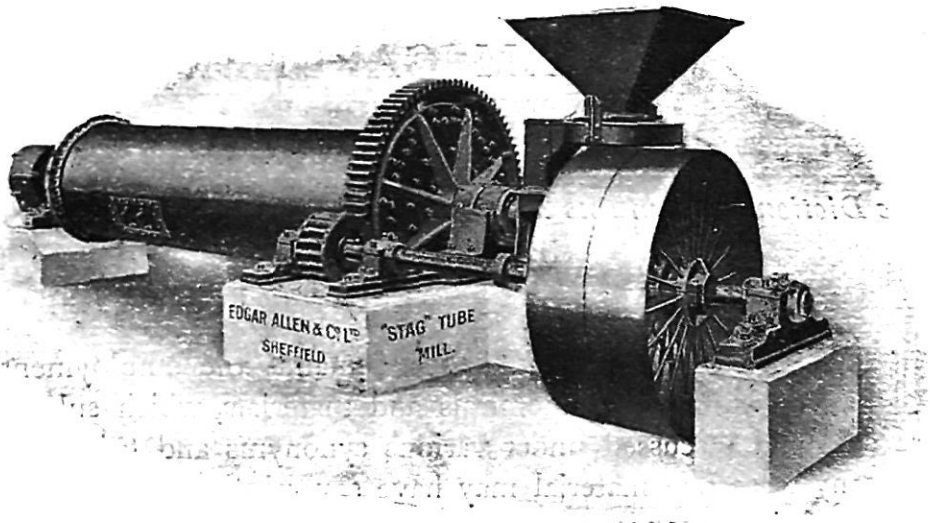

## Experimental Department

To enable our friends to judge of the suitability of our machines for their particular purposes, we have installed machines of commercial size which are at their disposal for carrying out crushing and grinding tests on their own materials

**Imperial Steel Works**  
SHEFFIELD

**A WORK OF SUPREME IMPORTANCE TO ALL  
CONNECTED WITH THE CHEMICAL INDUSTRY**

JUST READY. Royal 8vo, cloth. 330 pp. Price about 30s. net.

SECOND EDITION, ENLARGED

---

# CHEMICAL SYNONYMS

AND

# TRADE NAMES

A DICTIONARY AND  
COMMERCIAL HANDBOOK

BY

**WILLIAM GARDNER**

WORKS CHEMIST

---

*The Dictionary contains approximately 16,000 Definitions and  
Cross-References*

---

**Q** Modern art and manufacture demands the employment of a vast number of chemicals and materials, which substances are sold and discussed under various synonyms and trade names. In many cases one material may have several commercial designations, and, in consequence, considerable confusion exists. To supply a ready reference to such synonyms and trade names is the object of this dictionary. It is a sure means of rapidly ascertaining the chemical name and the use of the materials commonly employed in manufacture and pharmacy.

It is arranged in strictly alphabetical classification, and is thoroughly cross-indexed.

The ground covered is exhaustive, including as it does, minerals, dyestuffs, explosives, pigments, drugs, alloys, commercial chemicals, and materials in common use.

---

**CROSBY LOCKWOOD & SON, Publishers, LONDON**



# TOWNSON & MERCER Ltd.

## Laboratory Outfitters

*Manufacturers of*

**CHEMICAL AND SCIENTIFIC APPARATUS AND LAMP-BLOWN GLASSWARE**  
of all kinds for Laboratories and Works

**34 Camomile Street, London, E.C.3**

ESTABLISHED 1798

*Telegraphic Address*  
"Townson, Stock, London"

*Telephone No.*  
London Wall 5754

### AUTOCLAVES

DRYING OVENS

FILTER PRESSES

OIL TESTING APPARATUS

GAS ANALYSIS APPARATUS

STIRRING AND SHAKING APPARATUS

VACUUM DISTILLING APPARATUS

POLARISCOPES

SPECTROMETERS

PYROMETERS, ETC.

Manufacturers and Suppliers of Pure Chemicals, etc.,  
for Analysis.

Agents in United Kingdom for Messrs Becker's Sons,  
Brummen, Balances and Weights.

CONTRACTORS FOR THE SUPPLY OF  
**CHEMICAL, PHYSICAL, & BACTERIOLOGICAL APPARATUS**

Etc., to the

Home and Colonial Departments of H.M. Government, War Office,  
India Office, and the Principal Technical Institutions, County Councils, etc.

# ADIE'S

## Cement Testing Machines

USED BY

The Admiralty, War Office, Home, Indian, Colonial, and Foreign Governments, County and other Councils, Cement Manufacturers, Contractors, Etc. Etc.

EVERYTHING NECESSARY FOR THE TESTING OF CEMENT, Etc.

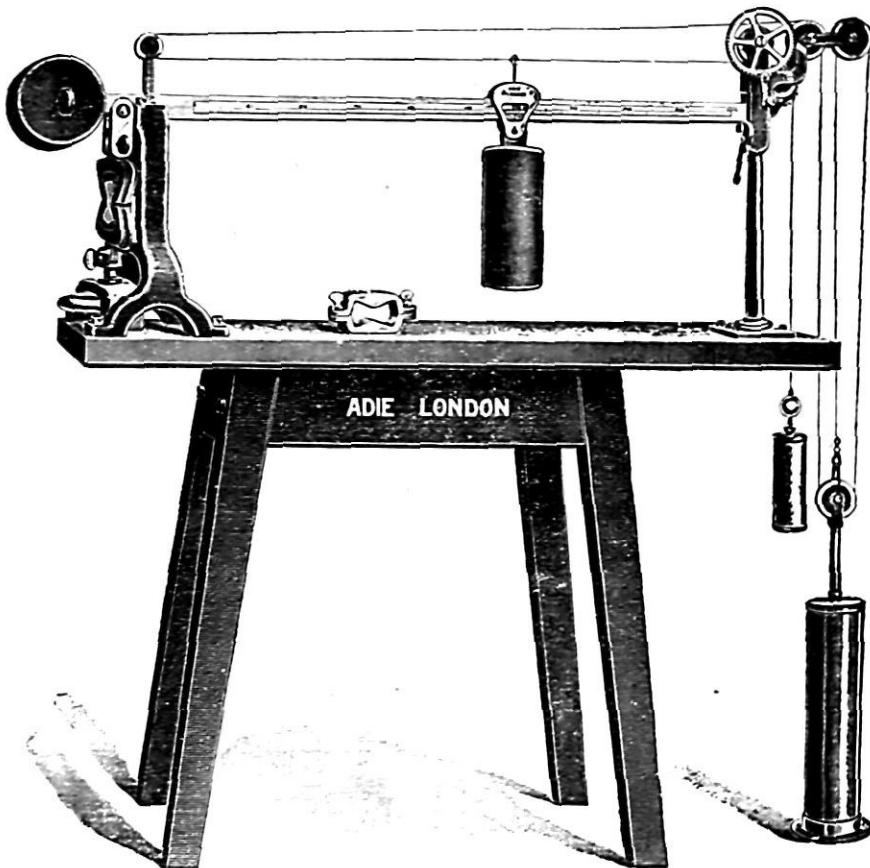

MOULDS, SIEVES, Etc.

Made according to the British Standard Specifications for Portland Cement issued by the Engineering Standards Committee

## PATRICK ADIE

45 HORSEFERRY ROAD, WESTMINSTER, S.W.  
(FORMERLY BROADWAY WORKS, WESTMINSTER, S.W.)

Makers of Apparatus for the Testing of Cement and other Materials, Etc.  
Also Mathematical, Surveying, and Scientific Instruments, and Experimental  
and Model Work carried through quickly

# BABCOCK & WILCOX LTD.

## PATENT WATER-TUBE STEAM BOILERS

Over **25,000,000** H.P. of Land and Marine Types supplied or on order, of which over **500,000** H.P. are in use in **Chemical and Allied Industries**

**ARRANGED FOR COAL OR OIL FIRING**

Also Makers of "Express" Type Light-Weight Boilers

**Babcock & Wilcox Ltd., Sole Licensees and Manufacturers of the Fuller Products for Burning Pulverized Coal**

BABCOCK & WILCOX also manufacture

STEAM SUPERHEATERS.  
ECONOMISERS.  
MECHANICAL STOKERS.  
SOOT BLOWERS.  
FEED-WATER HEATERS.  
HIGH PRESSURE STEAM VALVES

STEAM PIPING PLANTS.  
WATER SOFTENERS AND PURIFIERS.  
STEEL CHIMNEYS.  
COAL & ASH CONVEYERS.

SUCTION ASH PLANTS.  
STRUCTURAL STEELWORK.  
ELECTRIC AND OIL DRIVEN CRANES.  
STEEL WORKS CHARGERS.  
PATENT BOAT DAVITS.

ALL BOILER HOUSE ACCESSORIES.

Telegrams—  
"Babcock, Cent. London"

HEAD OFFICES:

Telephone—  
No. 6470 City (8 Lines)

**BABCOCK HOUSE, Farringdon St., LONDON, E.C.4**  
**Works: RENFREW, SCOTLAND**

Branch Offices: Dumbarton, Scotland; Oldbury and Lincoln, England; Italy; Australia; and Japan

### JUST PUBLISHED

## A COMPREHENSIVE AUTHORITATIVE WORK

Third Edition. Thoroughly Revised and greatly Enlarged. In Two Vols. complete. Royal 8vo, Cloth. Over 1,300 Pages. With 250 Illustrations and 3 Coloured Plates. £2. 12s. 6d. net

## STANDARD METHODS OF CHEMICAL ANALYSIS

A MANUAL OF ANALYTICAL METHODS AND GENERAL REFERENCE FOR THE ANALYTICAL CHEMIST AND FOR THE ADVANCED STUDENT

Edited by **WILFRED W. SCOTT**

WITH THE COLLABORATION OF EMINENT AUTHORITIES

6 in. x 4½ in., Cloth. 252 Pages. Illustrated. 12s. 6d. net.

## SOAP MAKING MANUAL

A PRACTICAL HANDBOOK ON THE RAW MATERIALS, THEIR MANIPULATION, ANALYSIS, AND CONTROL IN THE MODERN SOAP PLANT

By **E. G. THOMSEN, Ph.D.**

Demy 8vo, Cloth. 158 Pages. Illustrated. 10s. 6d. net.

## COLORIMETRIC ANALYSIS

By **F. D. SNELL**

LONDON: CROSBY LOCKWOOD & SON, STATIONERS' HALL COURT, E.C.4

AN IMPORTANT WORK**THE MODERN SOAP AND  
DETERGENT INDUSTRY**

INCLUDING

**GLYCEROL MANUFACTURE**

A Complete Practical Treatise in Three Volumes on the  
Manufacture of Laundry, Toilet, Pharmaceutical, Textile,  
Abrasive, Scouring, and Powdered Soaps; also Detergent  
Compositions and Soap Substitutes of all kinds

Including Analyses of Raw Materials, Modern Patents and Literature, Recent  
Machinery and Processes, together with Numerous Practical Recipes, and  
Lay-out of Modern Soap Factories

BY

**GEOFFREY MARTIN**

D.Sc. (Lond. and Bristol), Ph.D., F.I.C., F.Inst.Phys.

INDUSTRIAL CHEMIST AND ENGINEER;  
FELLOW OF THE CHEMICAL SOCIETY; MEMBER OF THE SOCIETY OF CHEMICAL INDUSTRY,  
SOCIETY OF PUBLIC ANALYSTS, AND OF THE PHYSICAL SOCIETY;  
LATE DIRECTOR OF RESEARCH OF THE CO-OPERATIVE WHOLESALE SOCIETY LTD. OF MANCHESTER;  
DIRECTOR OF RESEARCH OF THE PORTLAND CEMENT RESEARCH ASSOCIATION;  
AUTHOR OF "INDUSTRIAL AND MANUFACTURING CHEMISTRY," "OILS, FATS, AND WAXES,"  
"PERFUMES AND ESSENTIAL OILS," "DYESTUFFS AND COAL TAR PRODUCTS," ETC.;  
"SALT AND ALKALI INDUSTRY," ETC., ETC.

*IN THREE VOLUMES (Sold Separately)*JUST PUBLISHED

## VOLUME I

**THEORY AND PRACTICE OF SOAP MAKING**

Royal 8vo, cloth.

Nearly 400 pp. and over 140 Illustrations

Price 36/- net

*Detailed Prospectus on Application*NEARLY READY

## VOLUME II

**MANUFACTURE OF SPECIAL SOAPS AND DETERGENT  
COMPOSITIONS**

About 380 pp.

Profusely Illustrated.

Royal 8vo, cloth.

Price about 36/- net

## VOLUME III

**THE MANUFACTURE, PROPERTIES, AND USES OF  
GLYCEROL AND GLYCEROL SUBSTITUTES**

About 160 pp.

Illustrated.

Royal 8vo, cloth.

Price about 21/-

LONDON

**CROSBY LOCKWOOD AND SON**  
STATIONERS' HALL COURT, LUDGATE HILL, E.C.4