

**ASYMMETRIC TRANSFORMATIONS EMPLOYING  
II-FACE STEREOSELECTION AND  
ENANTIOSELECTIVE SYNTHESSES OF BIOLOGICALLY  
ACTIVE NATURAL PRODUCTS**

**SUBBA RAO V. KANDULA**

**DIVISION OF ORGANIC CHEMISTRY:  
TECHNOLOGY  
NATIONAL CHEMICAL LABORATORY  
PUNE 411 008, INDIA  
DECEMBER 2005**



**NATIONAL CHEMICAL LABOATORY**

*(Council of Scientific & Industrial Research)*

Division of Organic chemistry: Technology, Pune – 411008, India.

Phone (O) : 0091-20-25902050, Fax: 0091-20-25893614

E-mail: [pk.tripathi@dalton.ncl.res.in](mailto:pk.tripathi@dalton.ncl.res.in)

**Dr. Pradeep Kumar, Scientist E-II**

---

**CERTIFICATE**

This is to certify that the work presented in the thesis entitled “**ASYMMETRIC TRANSFORMATIONS EMPLOYING  $\pi$ -FACE STEREOSELECTION AND ENANTIOSELECTIVE SYNTHESSES OF BIOLOGICALLY ACTIVE NATURAL PRODUCTS**” submitted by **Subba Rao V. Kandula** was carried out by the candidate at the National Chemical Laboratory, Pune, under my supervision. Such materials as obtained from other sources have been duly acknowledged in the thesis.

**(Dr. Pradeep Kumar)**

**Research Guide**

**Scientist E-II,**

**Division of Organic Chemistry : Technology**

**National Chemical Laboratory**

**Pune 411 008, INDIA**

**December 2005**

## **CANDIDATE'S DECLARATION**

I hereby declare that the thesis entitled **“ASYMMETRIC TRANSFORMATIONS EMPLOYING  $\Pi$ -FACE STEREOSELECTION AND ENANTIOSELECTIVE SYNTHESSES OF BIOLOGICALLY ACTIVE NATURAL PRODUCTS”** submitted for the degree of Doctor of Philosophy in Chemistry to the University of Pune has not been submitted by me to any other university or Institution. This work was carried out at the National Chemical Laboratory, Pune, India.

**Subba Rao V. Kandula**  
**Senior Research Fellow (CSIR)**  
**Division of Organic Chemistry : Technology**  
**National Chemical Laboratory**  
**Pune-411 008, INDIA**

**December 2005**

*DEDICATED*  
*TO MY*

**PARENTS AND SISTERS**

## ACKNOWLEDGEMENT

*It gives me great pleasure to express my deep sense of gratitude to my research supervisor Dr. Pradeep Kumar for his encouragement and scientific temperament, which further my interest in synthetic organic chemistry. I do sincerely acknowledge freedom rendered to me by him for independent thinking, planning and executing the research.*

*I take this opportunity to thank Department of Chemistry S.V.R.M.College, Nagaram and NIT(REC) Warangal, A.P. for preliminary preparation to pursue my career in Chemistry.*

*My sincere thanks goes to Dr. M. K. Gurjar, Head, Division of Organic Chemistry: Technology for support and encouragement. I extend my gratitude to Dr. S. P. Chavan and Dr. K. V. Srinivasan for their help during the course of this work.*

*Help from the spectroscopy and mass groups is gratefully acknowledged. I sincerely thank Dr. Rajmohan, Mrs. Phalgune, Mr. Sathe, Mrs. Rupali and Mrs. Shanta kumari for their kind co-operation.*

*I am equally indebted to my seniors Dr. Rodney Fernandes, Dr. Rajesh Pandey and Dr. Mandar Bodas for the preliminary training during my Ph.D program.*

*I would like to thank my lab mates Ramalingam, Nagendra, Pandey, Puspesh, Rajesh, Shijo, Abhishek, Vasu, Priti, Divya, Sachin, Anis and Shinde who extended help throughout the tenure of my work in NCL. I am also grateful to colleagues and friends: Sham, Govind, Eku, DPS, Nag, Mahesh, Gnaneswar, Bhoje, Sankar, Pasupathi, Ramkrishna, Praveen, Bhargav, Srinu, Shiva, Raghu, Raj, Satya, Rajendra, Venkatesh, Harish, Safi, Girish, Anegudi, Swaroop, Raman, Srikanth, Prabal, Dhananjay, Sitaram, Tushar, Suken, Anirban, Eswar, Sharma, Murali, Nageshwar, Kiran, Chinna Srinu, Rambabu, Kishore, Raju and Kathi.*

*Support from OCT office staff: Babush, Catherine, Kulkarni, Varadarajan Rannowde and Balln is also acknowledged.*

*It is my great pleasure to thank my parents, sisters and my other family members for their blessings, care, love, and continuous encouragements throughout my education. Thanks to my wife Deepthi for her support and patience.*

*Finally, I thank Director, NCL, Pune for providing infrastructural facilities to complete my work successfully. I am also thankful to CSIR, New Delhi for financial assistance in the form of research fellowship.*

Subba Rao V. Kandula

## CONTENTS

ABBREVIATIONS	i
ABSTRACT	iii
PUBLICATIONS	xxii

---

---

### CHAPTER 1

#### CHIRAL AUXILIARY BASED ORGANIC TRANSFORMATIONS

---

---

1.1	Introduction	1
1.2	Present Work	16
1.3	Synthesis of <i>Trans</i> -2-Phenyl-Cyclohexanol	16
1.4	Synthesis of Novel Chiral Spirodione: (6 <i>R</i> ,7 <i>R</i> )-7-phenyl-1-oxaspiro [5.5]undec-3-en-2,5-dione	19
1.5	Asymmetric Diels-Alder Reaction	23
1.6	Asymmetric Diels-Alder Reaction with Chiral Dienophile	27
1.7	Detachment of Chiral Auxiliary from Cycloadducts	30
1.8	Conclusion	31
1.9	Experimental Section	32
1.10	Spectra	48
1.11	References	56

---

---

### CHAPTER 2

#### CHIRAL EPOXIDES, DIOLS, CYCLIC SULFITES / SULFATES AND AMINO ALCOHOLS AS SYNTHETIC INTERMEDIATES

---

---

#### 2.1 Section A: Asymmetric Epoxidation

2.1.1	Introduction	59
2.1.2	Asymmetric Epoxidation with the Titanium (IV) Tartrate catalyst	59
2.1.3	Mechanism	60

2.1.4	Kinetic Resolution of Secondary Allylic Alcohols	65
2.1.5	Various Synthetic Manipulations of Epoxide	68
2.1.6	Applications of Asymmetric Epoxidation in Bioactive Molecules	73
<b>2.2</b>	<b>Section B: Asymmetric dihydroxylation and cyclic sulfites/sulfates</b>	
2.2.1	Introduction	77
2.2.2	Mechanism of Osmylation	79
2.2.3	Empirical Rules for Predicting the Face Selectivity	83
2.2.4	Reaction Conditions	84
2.2.5	The Cinchona Alkaloid Ligands and their Substrate Preferences	85
2.2.6	Cyclic Sulfites/Sulfates	87
2.2.7	Preparation of Cyclic Sulfites/Sulfates	87
2.2.8	Reactions of Cyclic Sulfites/Sulfates	89
2.2.9	Applications of Asymmetric Dihydroxylation and Cyclic Sulfites/Sulfates in Bioactive Molecules	90
<b>2.3</b>	<b>Section C: Asymmetric aminohydroxylation</b>	
2.3.1	Introduction	94
2.3.2	Mechanism	95
2.3.3	Nitrogen Sources	97
2.3.4	Regioselectivity	99
2.3.5	Tethered Aminohydroxylation	103
2.3.6	Applications of Asymmetric Aminohydroxylation in Bioactive Molecules	105
<b>2.4</b>	<b>References</b>	108

---

---

## CHAPTER 3

### ENANTIOSELECTIVE SYNTHESSES OF (-)- $\alpha$ -CONHYDRINE AND (-)-ACATERIN VIA ASYMMETRIC DIHYDROXYLATION

---

---

#### 3.1 Section A: Enantioselective synthesis of (-)- $\alpha$ -conhydrine

3.1.1	Introduction	120
3.1.2	Review of Literature	121
3.1.3	Present Work	130
3.1.4	Results and Discussion	132
3.1.5	Conclusion	137

3.1.6	Experimental Section	138
3.1.7	Spectra	154
<b>3.2</b>	<b>Section B: Asymmetric synthesis of (-)-acaterin</b>	
3.2.1	Introduction	165
3.2.2	Review of Literature	166
3.2.3	Present Work	172
3.2.4	Results and Discussion	172
3.2.5	Conclusion	177
3.2.6	Experimental Section	178
3.2.7	Spectra	187
<b>3.3</b>	<b>References</b>	193

---

---

## CHAPTER 4

### ASYMMETRIC SYNTHESSES OF VICINAL AMINO ALCOHOLS: (+)-L-733,060, L-THREO-SPHINGANINE AND (-)-DEOXOCASSINE VIA ASYMMETRIC AMINOHYDROXYLATION

---

---

<b>4.1</b>	<b>Introduction</b>	196
<b>4.2</b>	<b>Section A: Enantioselective synthesis of (+)-L-733,060</b>	
4.2.1	Introduction	205
4.2.2	Review of Literature	205
4.2.3	Present Work	213
4.2.4	Results and Discussion	213
4.2.5	Conclusion	217
4.2.6	Experimental Section	218
4.2.7	Spectra	229
<b>4.3</b>	<b>Section B: Enantioselective synthesis of L-threo-sphinganine</b>	
4.3.1	Introduction	238
4.3.2	Review of Literature	240
4.3.3	Present Work	244



4.3.4	Results and Discussion	245
4.3.5	Conclusion	249
4.3.6	Experimental Section	249
4.3.7	Spectra	259
<b>4.4</b>	<b>Section C: Total synthesis of (-)-deoxocassine</b>	
4.4.1	Introduction	267
4.4.2	Review of Literature	268
4.4.3	Present Work	272
4.4.4	Results and Discussion	273
4.4.5	Conclusion	278
4.4.6	Experimental Section	278
4.4.7	Spectra	294
<b>4.5</b>	<b>References</b>	306

---

**CHAPTER 5**  
**STEREOSELECTIVE SYNTHESIS OF C<sub>1</sub>-C<sub>6</sub> FRAGMENT OF**  
**FUMONISIN B**

---

5.1	Introduction	311
5.2	Review of Literature	317
5.3	Present Work	324
5.4	Results and Discussion	326
5.5	Conclusion	330
5.6	Experimental Section	330
5.7	Spectra	345
5.8	References	354

## ABBREVIATIONS

Ac	Acetyl
Ac <sub>2</sub> O	Acetic anhydride
aq.	Aqueous
AD	Asymmetric dihydroxylation
Bn	Benzyl
<i>t</i> -Bu	<i>tert</i> -Butyl
Cat.	Catalytic
CDCl <sub>3</sub>	Deuterated chloroform
Conc.	Concentrated
DET	Diethyltartrate
D <sub>2</sub> O	Deuterium oxide
de	Diastereomeric excess
ds	Diastereoselectivity
DHP	Dihydropyran
(DHQ) <sub>2</sub> AQN	1,4-Bis(dihydroquinin-9- <i>O</i> -yl)anthraquinone
(DHQ) <sub>2</sub> PHAL	1,4-Bis(dihydroquinin-9- <i>O</i> -yl)phthalazine
(DHQD) <sub>2</sub> PHAL	1,4-Bis(dihydroquinindin-9- <i>O</i> -yl)phthalazine
DIBAL-H	Diisobutyl aluminium hydride
DMAP	N, N-(Dimethylamino)pyridine
DMF	N, N-Dimethylformamide
DMSO	Dimethyl sulfoxide
ee	Enantiomeric excess
equiv.	Equivalents
EtOAc	Ethyl acetate
Et <sub>3</sub> N	Triethyl amine
g	Grams

h	Hours
Hz	Hertz
IR	Infrared
<i>i</i> -Pr	Isopropyl
<i>m</i> CPBA	<i>m</i> -Chloroperbenzoic acid
mg	Milligram
min	Minutes
mL	Milliliter
mmol	Millimole
M.p.	Melting point
Ms	Methane sulfonyl
NMO	N-methyl morpholine N-oxide
NMR	Nuclear magnetic resonance
Pet. Ether	Petroleum ether
<i>p</i> -TSA	<i>p</i> -Toluene sulfonic acid
rt	Room temperature
SAA	Sharpless asymmetric aminohydroxylation
SAD	Sharpless asymmetric dihydroxylation
SAE	Sharpless asymmetric epoxidation
TBDMS	<i>tert</i> -Butyl dimethylsilyl
THF	Tetrahydrofuran
TLC	Thin layer chromatography
TMS	Trimethylsilyl
Ts	<i>p</i> -Toluene sulfonyl

## ABSTRACT

The thesis entitled “**Asymmetric Transformations Employing  $\Pi$ -Face Stereoselection and Enantioselective Syntheses of Biologically Active Natural Products**” is divided into five chapters.

**Chapter 1:** covers the synthesis of a new chiral spirodione and its application to the asymmetric Diels-Alder reaction.

**Chapter 2:** describes a brief introduction to the Sharpless asymmetric epoxidation, dihydroxylation, cyclic sulfites/sulfates and aminohydroxylation as synthetic intermediates and is divided into three sections.

**Chapter 3:** deals with the enantioselective synthesis of biologically active molecules such as (-)- $\alpha$ -conhydrine and (-)-acaterin via asymmetric dihydroxylation and is divided into two sections.

**Chapter 4:** constitutes the asymmetric synthesis of vicinal amino alcohols (+)-L-733,060, L-*threo*-sphinganine and (-)-deoxocassine via asymmetric aminohydroxylation and is divided into three sections.

**Chapter 5:** includes the stereoselective synthesis of C<sub>1</sub>-C<sub>6</sub> fragment of fumonisin B

### **Chapter 1: Spirodiones in asymmetric synthesis**

This chapter discusses the synthesis of a new chiral spirodione and its successful application to the asymmetric Diels-Alder reaction. An efficient method has been developed to cleave the Diels-Alder cyclo adducts from the auxiliary. Increasing attention is being paid towards creation of novel chiral auxiliaries which are highly versatile for asymmetric transformations because of the reliable prediction of stereochemistry that is

offered in many cases.<sup>1</sup> By attaching an active functional group to the chiral auxiliaries such as menthol, menthone, efficient asymmetric synthesis was achieved by the organic chemists. In most of the cases an activated olefin was used as the functional group, on which several types of reactions have been carried out. The attachment of this active functional group to the auxiliary is normally through an ether, ester or amide linkage. We have developed a novel chiral spirodione **5** utilizing (-)-*trans*-2-phenylcyclohexanone as chiral synthon through carbon-carbon bond formation. The synthesis of **5** commenced from 2-phenylcyclohexanol **1** as shown in **Scheme 1**. Thus, compound **1** can be prepared either by enzymatic resolution<sup>2</sup> of racemic phenyl cyclohexyl acetate or by Sharpless asymmetric dihydroxylation of phenylcyclohexene<sup>3</sup> followed by reduction of benzylic alcohol. Oxidation of **1** gave the required phenyl cyclohexanone **2** with high enantiomeric purity. Thus, optically pure (-)-2-phenylcyclohexanone **2** was treated with 2-lithiated

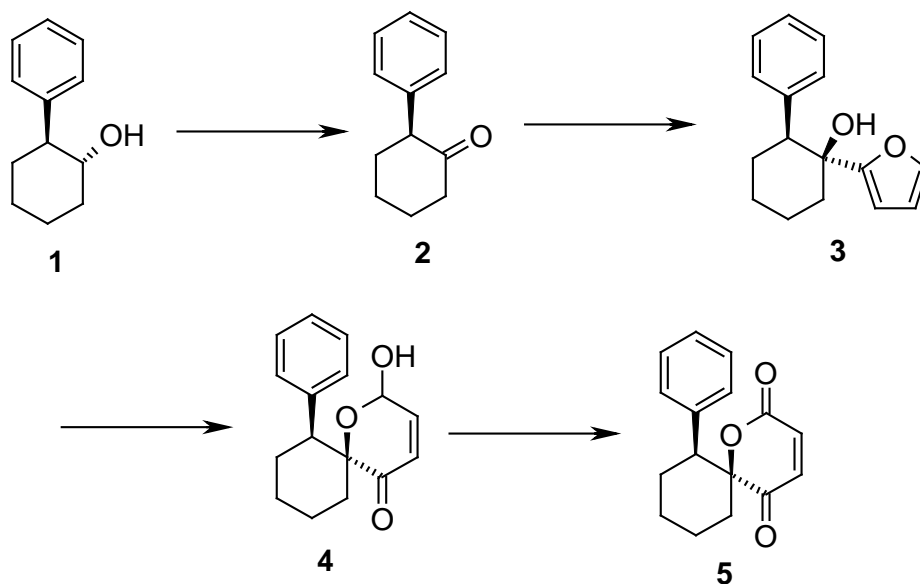

**Scheme 1**

furan to give **3** quantitatively as single diastereomeric product. Stereo-specific oxidation rearrangement of **3** afforded **4**. The compound **4** was then treated with Jones' reagent to

give **5** in single diastereomeric product which was confirmed by single crystal X-ray analysis. (**Scheme 1**)

The role of Diels-Alder reaction with the control of absolute stereochemistry leading to the formation of two or more chiral centers in a single reaction is well known.<sup>4</sup> By taking advantage of the diastereotopic face differences in **5**, we have examined the Diels-Alder

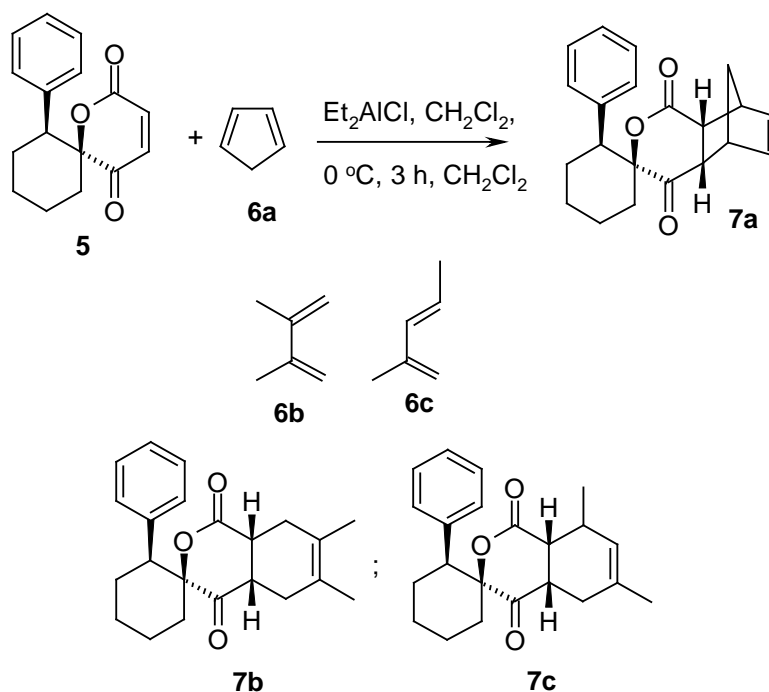

**Scheme 2**

reaction with a view to preparing an optically active skeleton. The approach of the diene is based on the chiral auxiliary **5**, which is expected to undergo  $\pi$ -face selective cycloaddition with a variety of dienes. Thus, the Diels-Alder reaction between dienophile **5** and dienes such as cyclopentadiene **6a**; 2,3-dimethyl-1,3-butadiene **6b**; 2-methyl-1,3-pentadiene **6c**; in the presence of diethylaluminium chloride as Lewis acid gave the cycloadducts **7a-c** respectively as single diastereomer in 92-94% yields (**Scheme 2**). Diastereoselectivity was determined on the basis of  $^{13}\text{C}$  NMR spectroscopy.

In order to obtain the optically pure Diels-Alder product, we next attempted the detachment of the chiral auxiliary from the adduct **7a**. A variety of methods employed for the detachment of the chiral auxiliary such as Bayer-Villiger oxidation followed by hydrolysis, photochemical degradation and basic hydrolysis followed by oxidation were unsuccessful. However, when **7a** was treated with lithium aluminium hydride in refluxing THF, it gave triol **8**, which on subsequent oxidative cleavage by lead tetraacetate afforded the optically pure 2-phenylcyclohexanone **2** without loss of its identity and lactol **9** as a single enantiomer. (Scheme 3)

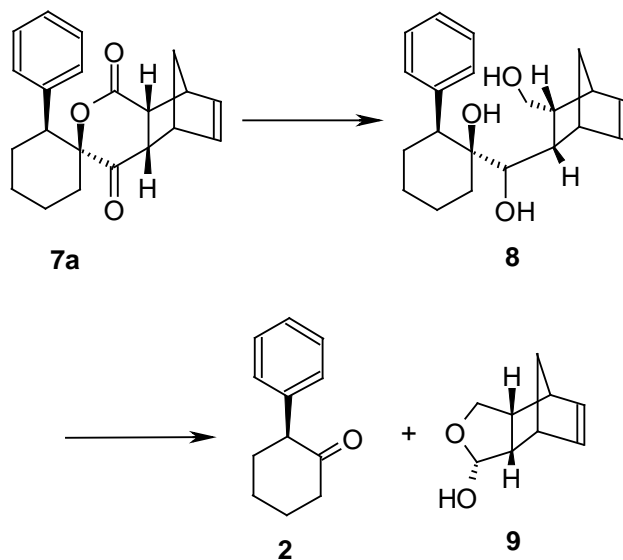

Scheme 3

## **Chapter 2: Chiral epoxides, diols, cyclic sulfites/sulfates and amino alcohols as synthetic intermediates in organic synthesis**

This chapter gives a brief introduction to Sharpless asymmetric epoxidation, dihydroxylation, cyclic sulfites/sulfates and aminohydroxylation as synthetic intermediates.<sup>5</sup> Catalytic asymmetric reactions provide an especially practical entry into the chiral world due to their economical use of asymmetric inducing agents. Especially

useful is the carbon-hetero atom bond forming reactions, since resulting functionality can be readily manipulated to produce many important classes of compounds. Catalytic asymmetric reactions such as epoxidation, dihydroxylation and aminohydroxylation developed by Sharpless *et al.*<sup>6</sup> have emerged as powerful methods in the synthetic organic chemistry. Chiral epoxides, diols and amino alcohols are versatile and convenient building blocks in the synthesis of bioactive compounds.

In this chapter, we have described aforementioned catalytic reactions along with their recent applications. During the course of our research work we have prepared chiral epoxides, diols and amino alcohols and successfully employed these synthetic intermediates towards the total syntheses of (-)- $\alpha$ -conhydrine, (-)-acaterin, (+)-L-733,060, L-threo-sphinganine, (-)-deoxocassine and partial synthesis of fumonisin B.

### **Chapter 3: Enantioselective synthesis of bioactive molecules via asymmetric dihydroxylation**

#### **Section A: Enantioselective synthesis of (-)- $\alpha$ -conhydrine**

Alkaloid mimics with a nitrogen in the ring, including naturally occurring and synthetic monocyclic and bicyclic derivatives, constitute a realm of important functional molecules which have drawn considerable attention by virtue of their potent and varied biological activities.<sup>7</sup> Conhydrine **10** (**Fig. 1**) is one of the poisonous alkaloids of the hemlock, *conium maculatum* whose extracts were used in the ancient Greece for the execution of criminals.<sup>8</sup> Enders and co-workers achieved first asymmetric synthesis of (-)- $\alpha$ -conhydrine based on RAMP/SAMP hydrazone methodology.<sup>9</sup> We have designed two synthetic routes for the synthesis of (-)- $\alpha$ -conhydrine and key steps are asymmetric dihydroxylation, regiospecific opening of cyclic sulfate and Wittig olefination.



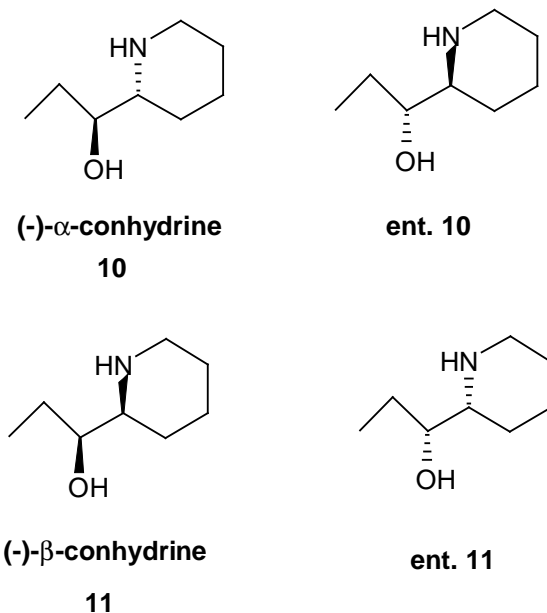
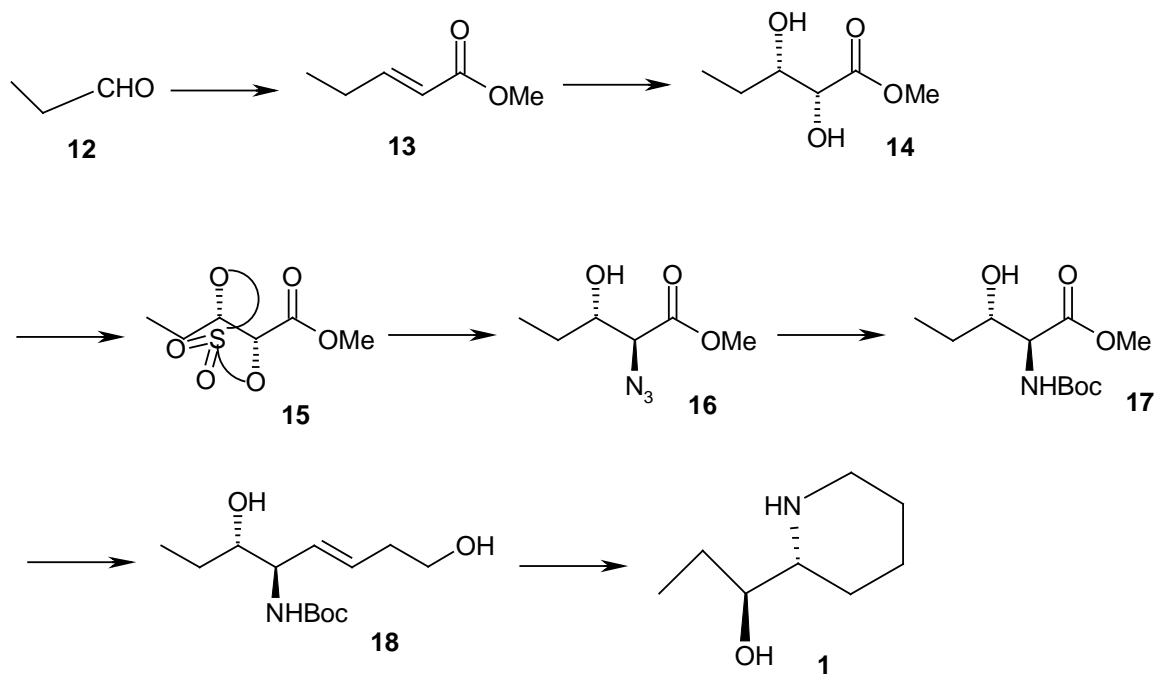

**Fig. 1**

As shown in **Scheme 4**, the asymmetric dihydroxylation of olefin **13** which could be derived from propionaldehyde **12** gave the diol **14** which was converted into the cyclic sulfate **15** by treatment with thionyl chloride and subsequent oxidation. The regioselective opening of cyclic sulfate **15** with  $\text{NaN}_3$  gave the required azide compound **16** in excellent yield. The azide group of **16** was reduced to free amine and subsequently protected as Boc. Reduction of ester **17** to aldehyde followed by Wittig olefination using  $\text{Br}^- \text{Ph}_3\text{P}^+(\text{CH}_2)_3\text{OH}$  furnished **18**. Reduction of double bond followed by subsequent cyclization and deprotection of Boc group furnished the target molecule (-)- $\alpha$ -conhydrine **1**.<sup>10</sup>

Alternatively, the required amino alcohol functionality was achieved by the selective 1,3-benzylidene formation, as shown in **Scheme 5**. Asymmetric dihydroxylation of allylic alcohol **19** gave the triol **20**. Selective 1,3-hydroxy protection as cyclic benzylidene, followed by conversion of free hydroxyl into the azido functionality furnished **22**. The

DIBAL-H reduction and subsequent Wittig olefination produced **24**. To arrive at the target molecule, we then carried out similar reactions as described in **Scheme 4**.



Scheme 4

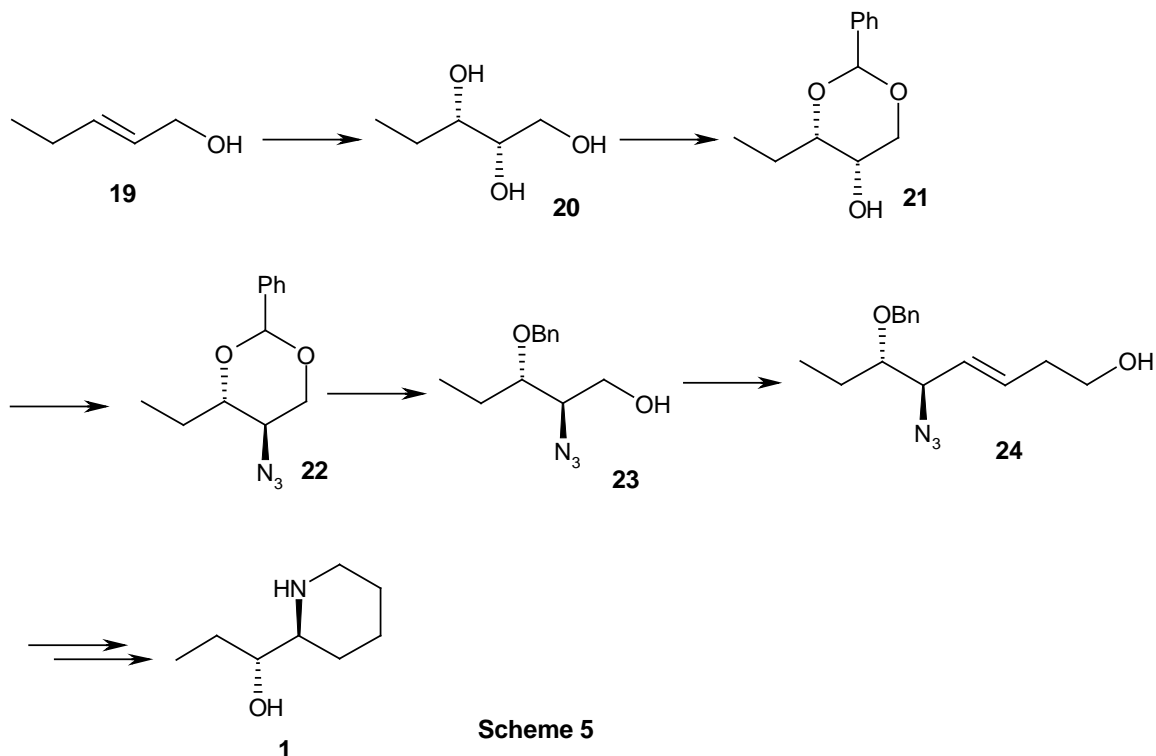

Thus, a short and highly enantioselective synthesis of (-)- $\alpha$ -conhydrine has been achieved through asymmetric dihydroxylation by employing a cyclic sulfate or a cyclic benzylidene intermediate.

### Section B: Asymmetric synthesis of (-)-acaterin:

Acyl-CoA cholesterol acyl transferase (ACAT) plays an important role in cholesterol ester accumulation in atherogenesis and in cholesterol absorption from the intestines. Inhibitors of ACAT activity are expected to be effective for the treatment of atherosclerosis and hypercholesterolemia.<sup>11</sup> Acaterin **25** (Fig. 2) is one of the ACAT inhibitors isolated from a culture broth of pseudomonas sp. A 92 by Endo and co-workers.<sup>12</sup> Acaterin has a butenolide skeleton with an alkyl chain at the C-2 position, which is related to Annonaceous acetogenin and has remarkable antitumour activity.

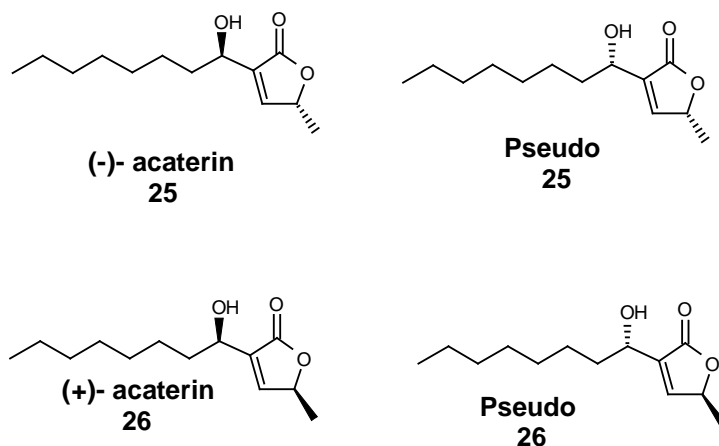

**Figure 2**

We have developed a concise and efficient synthetic route to (-)-acaterin **25** using Sharpless asymmetric dihydroxylation procedure and Wittig olefination. We have constructed butenolide skeleton by coupling of two fragments, the phosphonium salt **32** and aldehyde **34** through Wittig olefination.

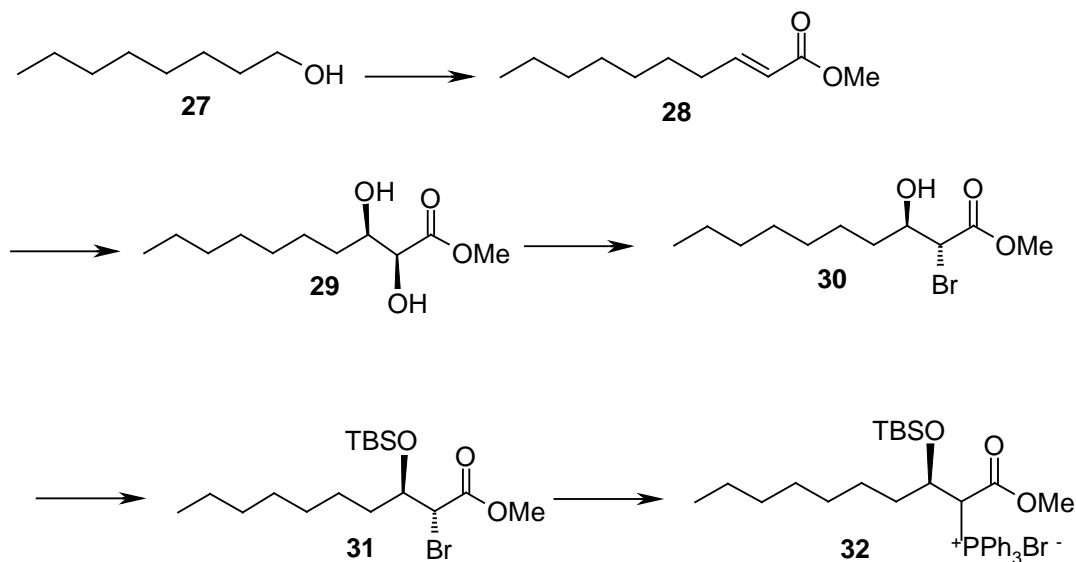

**Scheme 6**

The Sharpless asymmetric dihydroxylation of olefin **28** derived from alcohol **27** gave the required diol **29** in excellent yield and high enantioselectivity (**Scheme 6**). Regioselective conversion of diol **29** to bromohydrin **30** using Sharpless protocol and protection of the free hydroxyl group as TBS ether afforded compound **31** which was treated with

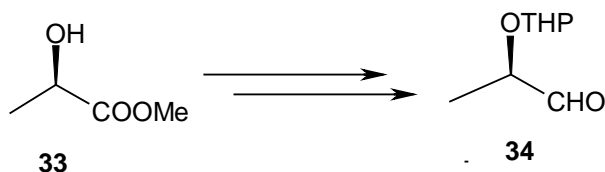

**Scheme 7**

triphenyl phosphine to give the phosphonium salt **32**. Aldehyde **34** was prepared starting from commercially available (*R*)-methyl lactate **33**. (**Scheme 7**)

The final step involved the coupling of phosphonium salt **32** with aldehyde **34** through Wittig olefination and subsequent cyclization to give (-)-acaterin **24**<sup>13</sup> (**Scheme 8**)

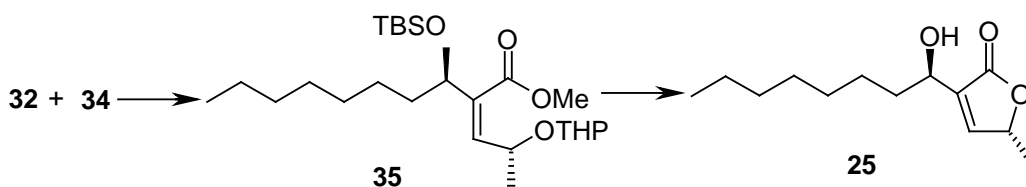

**Scheme 8**

Thus, a short and efficient asymmetric synthesis of (-)-acaterin has been accomplished using asymmetric dihydroxylation and Wittig olefination as key steps.

#### **Chapter 4: Asymmetric synthesis of vicinal amino alcohols via asymmetric amino hydroxylation**

The vicinal amino alcohol functionality is the key structural feature in a variety of bioactive molecules. This chapter summarizes our studies on the asymmetric syntheses of

(+)-L-733060, L-threo-sphinganine and (-)-deoxocassine via asymmetric aminohydroxylation and is further divided into three sections.

### Section A: Enantioselective synthesis of (+)-L-733,060

Potent neurokinin substance p receptor antagonists **36** and **37** are known for having a variety of biological activities including neurogenic inflammation, pain transmission and regulation of the immune response and are also implicated in a variety of disorders including migraine, rheumatoid, arthritis and pain.<sup>16</sup> (**Fig. 3**)

We have designed a synthetic route for **36** employing Sharpless asymmetric aminohydroxylation as the source of chirality. The synthesis started from cheaply available starting material cinnamic acid **38** which was smoothly converted into its corresponding isopropyl ester **39**. The asymmetric aminohydroxylation of olefin **39** gave the aminohydroxy product **40** in excellent enantio and regioselectivity which was hydrolyzed and amino group protected with di-*tert*-butyl-pyrocarbonate for the convenient of the synthesis. The ester group of **42** was reduced to alcohol **43**. Subsequent oxidation and Wittig olefination furnished **44**. The double bond and ester group of **44** was reduced and resultant compound was cyclized to afford **45**. Finally compound **45** was coupled with 3,5-bis (trifluoromethyl) benzyl bromide followed by deprotection of Boc group to furnish the target molecule **36**. (**Scheme 10**)

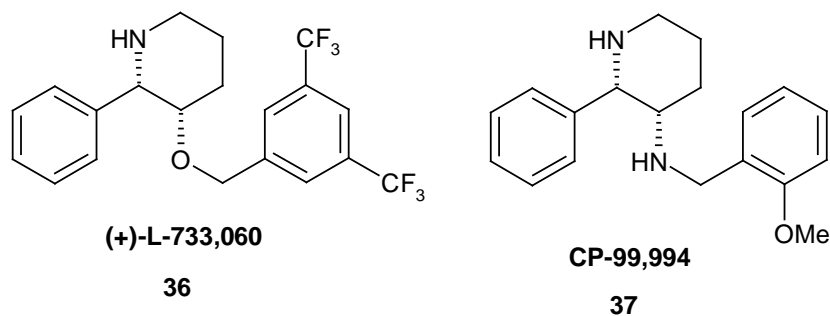

**Fig. 3**

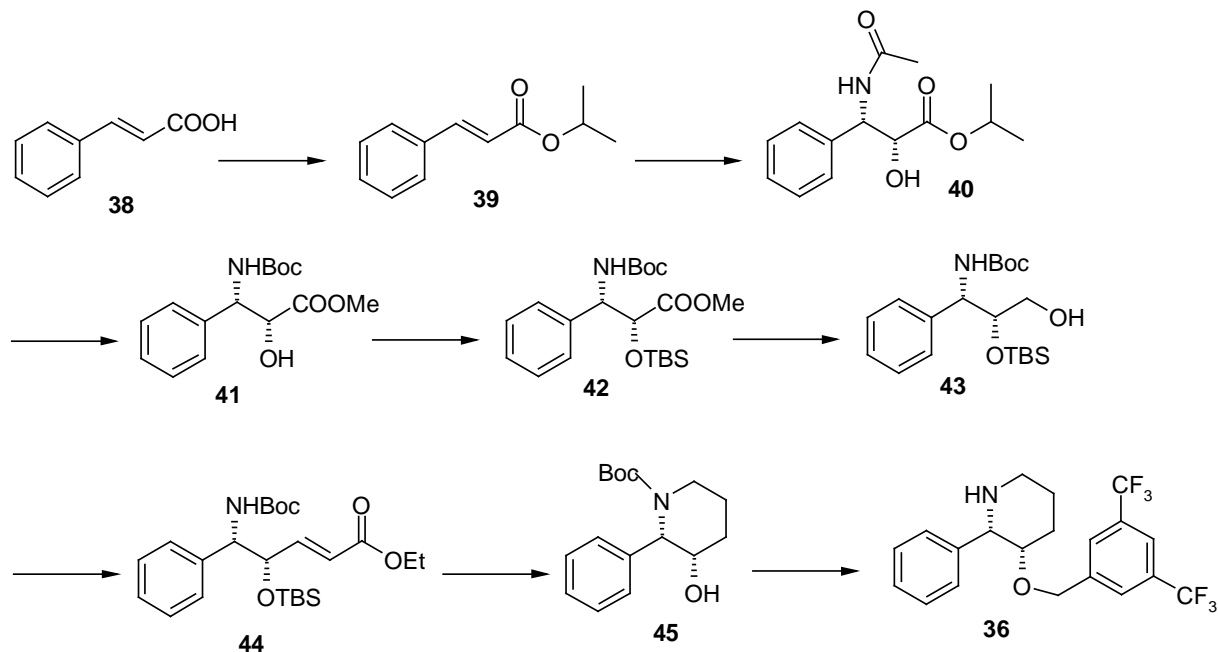

Scheme 9

Thus, an efficient asymmetric synthesis of (+)-L-733,060 is achieved using aminohydroxylation as the key step.

### Section B: Enantioselective synthesis of *L*-threo-sphinganine

Sphinganine (dihydrosphingosine) and 4-hydroxy sphinganine (phytosphingosine) (**Fig. 4**) are the predominant free long-chain bases present in lipid extracts of plant tissues.<sup>17</sup>

These are the predominant free long chain amino alcohols possessing generally 18 or 20 carbon atoms and important constituents of cellular membranes, plays critical role in many physiological processes including modulation of immune, signaling and cell recognition.

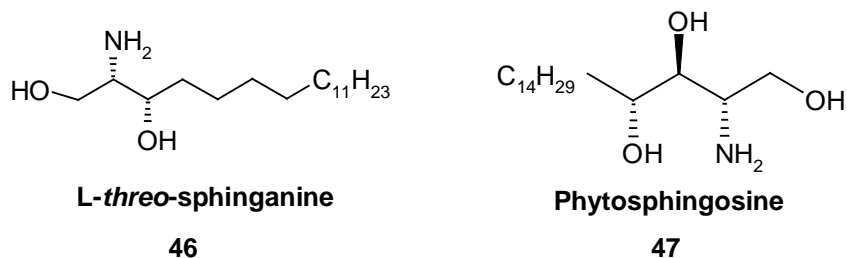

**Fig. 4**

We have developed two different synthetic routes for enantioselective synthesis of *L-threo*-sphinganine in a highly concise manner.

As shown in **Scheme 10**, the asymmetric aminohydroxylation of olefin **49** using benzyl carbamate as nitrogen source and (DHQ)<sub>2</sub>AQN as chiral ligand gave the amino alcohol **50**. Reduction of ester group in **50** using LAH afforded the aminodiol which was converted to the known triacetate **51** in good yield.

An alternative route for **51** is shown in **Scheme 11** where we used Sharpless kinetic resolution and tethered aminohydroxylation as key steps. The Sharpless kinetic resolution of **52** using (-)-DIPT gave the required chiral hydroxy olefin **53** in excellent enantioselectivity which was subsequently treated with trichloroacetyl isocyanate to produce the carbamate **55**. Tethered aminohydroxylation of **55** gave **56** in good diastereoselectivity which was converted to the target molecule sphinganine as its triacetate derivative **51**.



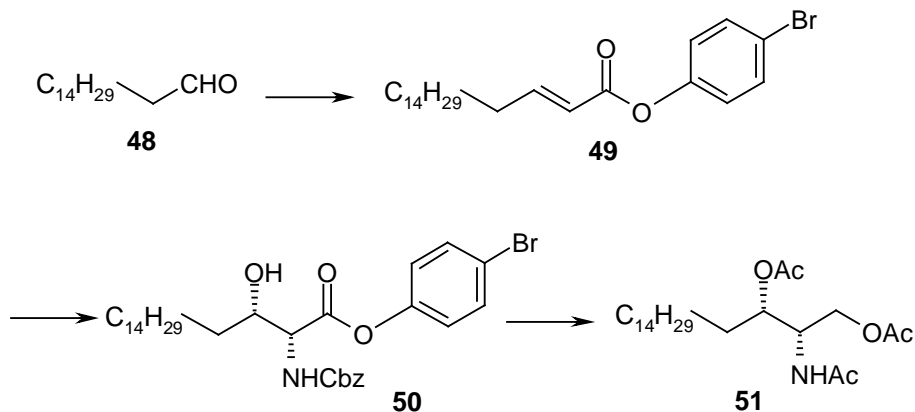

Scheme 10

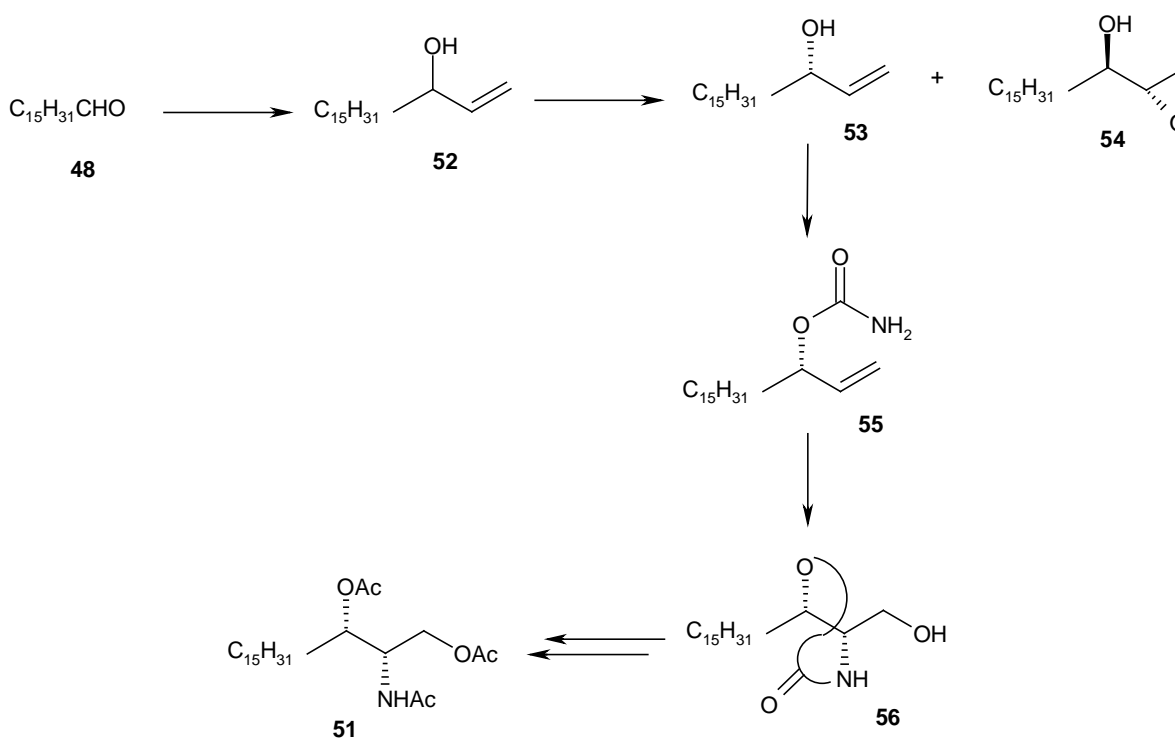

Scheme 11

In conclusion, an efficient enantioselective synthesis of *L-threo*-sphinganine has been accomplished in a highly concise manner.

### Section C: Enantioselective synthesis of (-)-deoxocassine

All *cis*-2,6-disubstituted 3-piperidinols such as cassine or its analogues (**Fig. 5**) display interesting naturally occurring structures with three centers of asymmetry in the

piperidine ring.<sup>18</sup> After discovery and structure elucidation of different 3-piperidinol alkaloids, much effort has been directed towards efficient, stereoselective syntheses of this class of compounds owing to a variety of their biological activities and the difficulty in isolating these compounds in pure form from natural sources.<sup>19</sup> We have developed a general synthetic strategy for all *cis*-2,6-disubstituted-3-piperidinols using asymmetric aminohydroxylation as the source of chirality.

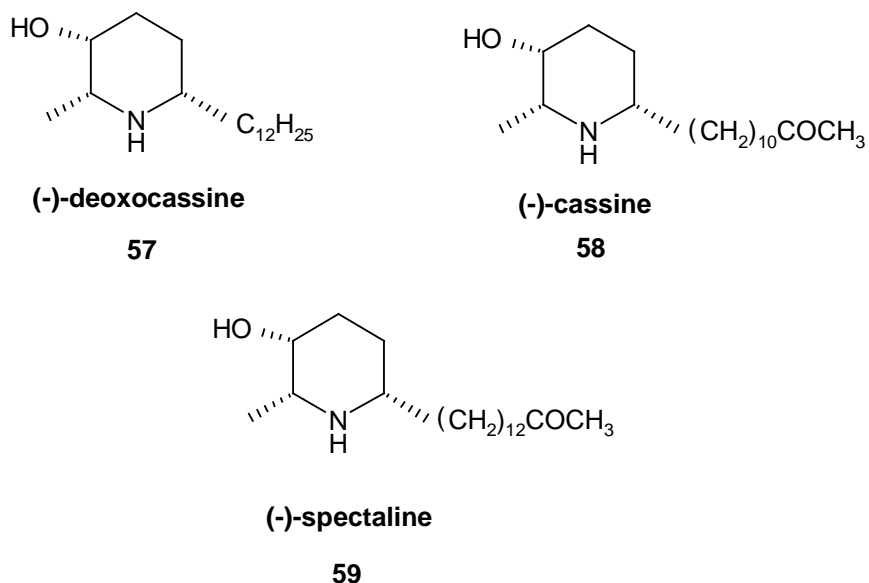

**Fig. 5**

As shown in **Scheme 12** the Sharpless asymmetric aminohydroxylation of *t*-butyl crotonate **60** using benzyl carbamate as nitrogen source gave **61** with good regioselectivity as well as enantioselectivity. Subsequently, the free hydroxyl group of **61** was protected as silyl ether. The ester group of **62** was reduced to aldehyde followed by two carbon Wittig olefination to give **63**. At this stage our attempts to displace the ester group of **63** with  $C_{12}H_{25}SO_2Ph$  using different types of bases were unsuccessful. Therefore, we thought it would be appropriate to convert **63** into lactone **65** which was then successfully opened with  $C_{12}H_{25}SO_2Ph$  using *n*-BuLi as base to furnish **66**.

Finally, desulfurization of **66** using 6% Na-Hg followed by subsequent cyclization produced the target compound **57**.

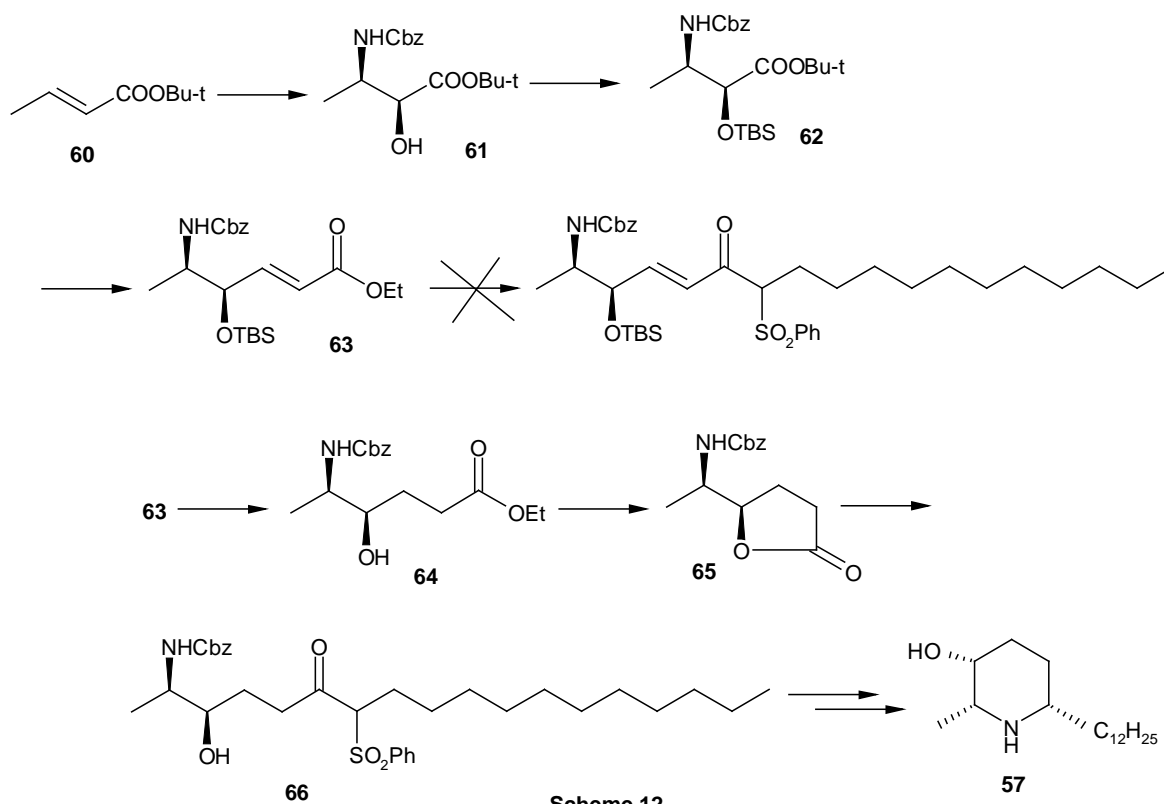

### Chapter 5: Stereoselective synthesis of C<sub>1</sub>-C<sub>6</sub> fragment of fumonisin B

Fumonisin (**Fig. 6**), a representative member of mycotoxins are potent toxic materials isolated from *fusarium maniloforme* which is one of the most prevalent molds on corn, sorghum and other grain through the world.<sup>20</sup> *Fusarium maniloforme* has been shown to be cancer promoting activity in animals. These fumonisins bear a remarkable structural similarity to sphinganine and sphingosine. Fumonisin will be valuable in studies of complex biochemical events involved in sphingolipid metabolism and function.

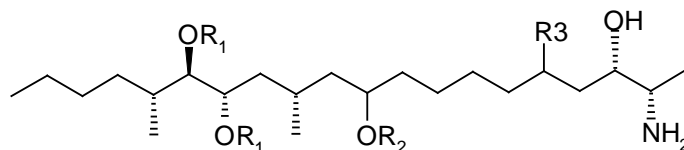

Fumonisin B<sub>1</sub> ( R<sub>2</sub> = OH, R<sub>3</sub> = OH )

Fumonisin B<sub>2</sub> ( R<sub>2</sub> = H, R<sub>3</sub> = OH )

Fumonisin B<sub>3</sub> ( R<sub>2</sub> = OH, R<sub>3</sub> = H )

**Figure 6**

Furthermore, fumonisins may serve as templates for development of therapeutic agents for treatment of diseases related to sphingolipid turnover, such as Forber's disease.

We have developed a synthetic route for the synthesis of amino alcohol functionality which is present in fumonisin. Initially, we tried to explore the asymmetric aminohydroxylation to synthesize the amino alcohol functionality but we did not succeed due to the low yield of aminohydroxy product. We then made a successful attempt to synthesize the amino alcohol fragment of fumonisin using Sharpless kinetic resolution.

(*S*)-Malic acid **67** used as the starting material which was converted to the acetonide alcohol **68** by known method. Alcohol **68** was oxidized and subsequently converted to olefin **69** using Panek protocol. The Sharpless asymmetric aminohydroxylation of olefin **69** using different nitrogen sources like chloramines-T, chloramine-M, benzyl carbamate and *N*-bromo acetamide gave the amino alcohol **70** only in 10-20% yield. (**Scheme 13**)

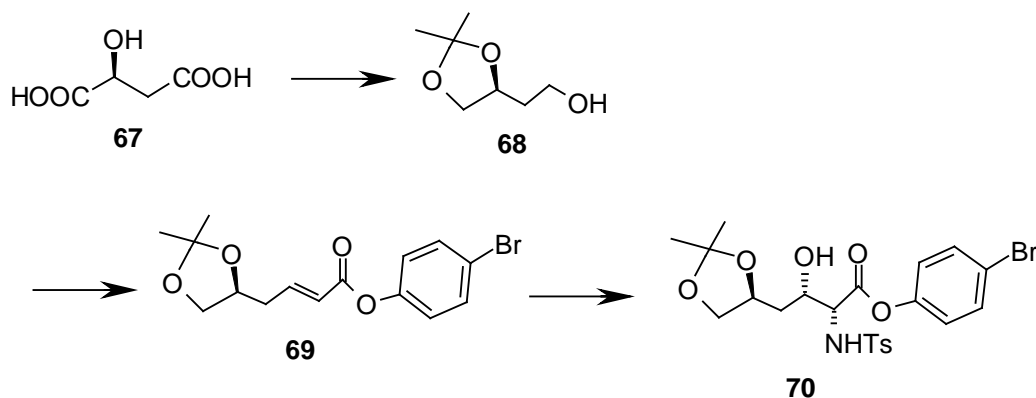

**Scheme 13**

Due to the low yield of aminohydroxy product **70**, an alternative route was planned to convert **68** first into allylic alcohol type substrate which would then be subjected to Sharpless epoxidation and kinetic resolution. Towards this end, compound **68** was transformed into a allylic alcohol **71** which was then subjected to Sharpless kinetic resolution to afford the chiral epoxy alcohol **73** in 93% de. (**Scheme 14**)

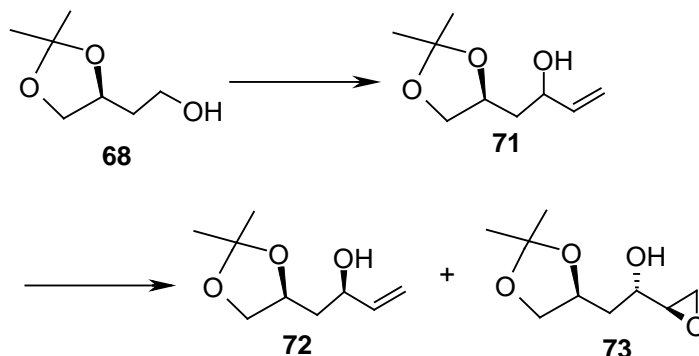

**Scheme 14**

Compound **73** was protected with benzyl bromide and subsequently regioselective opening of epoxide was achieved using LAH. At this stage, we converted free hydroxyl group of **75** to azide **76**. Treatment of **76** with 10% HCl followed by selective tosylation and formation of epoxide **77** completed the partial synthesis of fumonisins B. (**Scheme 15**)

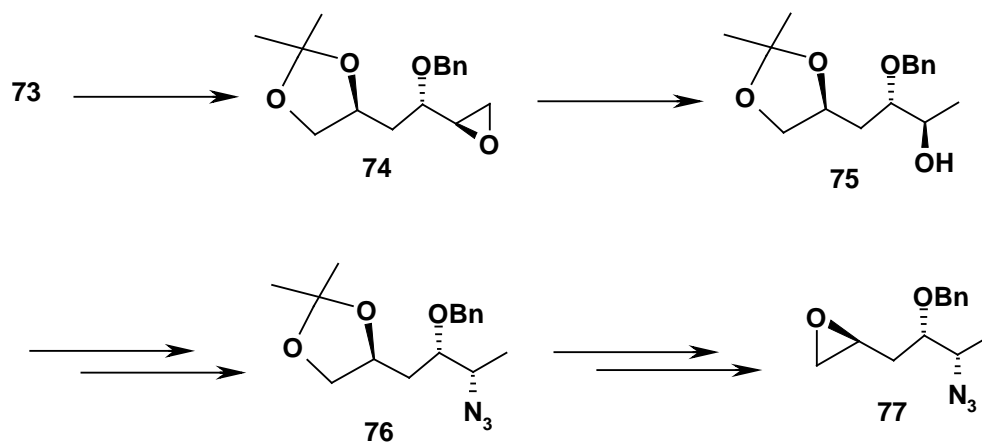

**Scheme 15**

### References:

1. (a) Seebach, D.; Zimmermann, J.; Gysel, U.; Ziegler, R.; Ha, T-K. *J. Am. Chem. Soc.* **1988**, *110*, 4763 ; (b) Sato, M.; Murakami, M.; Sunami, S.; Kaneko, C.; Furuya, T.; Kurihara, H. *J. Am. Chem. Soc.* **1995**, *117*, 4279.
2. Adachi, K.; Kobayashi, S.; Ohno, M. *Chima* **1986**, *40*, 311 ; (b) Whitesell, J. K.; Lawrence, R. M. *Chima* **1986**, *40*, 318.
3. King, S. B. ; Sharpless, K. B. *Tetrahedron Lett.* **1994**, *35*, 5611.
4. Oppolzer, W.; Chapuis, C.; Bernanrdinelli, G. *Helv. Chim. Acta.* **1984**, *67*, 1397.
5. For recent reviews, see: Catalytic Asymmetric synthesis; Ojima, I., Ed.; VCH publishers: New York, **1993**.
6. Kolb, H. C.; VanNieuwenhze, M. S. ; Sharpless, K. B. *Chem. Rev.* **1994**, *94*, 2483.
7. Casiraghi, G.; Zanardi, F.; Rasso, G.; Spanu, P. *Chem. Rev.* **1995**, *95*, 1677.
8. Spaeth, E.; Adler, E. *Monatsh Chem.* **1933**, *63*, 127.
9. Enders, D; Nolte, B.; Raabe, G.; Runsink, J. *Tetrahedron: Asymmetry* **2002**, *13*, 285.
10. Subba Rao, K. V.; Kumar, P. *Tetrahedron Lett.* **2003**, *44*, 1957.
11. Bell, F. P.; Ed. J. R. Prous, *Science Publishers*, **1986**, pp. 409.
12. Naganuma, S.; Sakai, K.; Endo, A. *J. Antibiot.* **1992**, *45*, 1216.
13. Subba Rao, K. V.; Kumar, P. *Tetrahedron Lett.* **2003**, *44*, 6149.
14. Martin, D.; Hauthal, H. G. *Dimethyl Sulfoxide*, Halsted Press, division of John Wiley & Sons, New York, **1975** ; (b) Jacob, S. W.; Rosenbaum, E. E.; Wood, D. C. Eds. *Dimethyl Sulfoxide*, vol. 1. *Basic concepts of DMSO*, Marcel Dekker, Inc., New York.
15. Durst, T.; in *Advances in Organic Chemistry : Methods and Results*, Vol. 6, E. C. Taylor, H. Wynberg, Eds., Interscience-JohnWiley & Sons, New York, **1969**, 285 ;

- (b) Epstein, W. W.; Sweat, F. W. *Chem. Rev.* **1967**, *67*, 247 ; (c) Butterworth, R. F.; Hanessian, S. *Synthesis* **1971**, 70 ; (d) Moffat, J. G.; *in Oxidation*, Vol 2, Augustine, R. L.; Trecker, D. J. Eds., Dekker, M.; Inc., New York, **1971**, 1.
16. (a) Lotz, M.; Carson, D. A.; Vaughan, J. H. *Science* **1987**, *235*, 893 ; (b) Mantyh, C. R.; Gates, T. S.; Zimmerman, R. P.; Welton, M. L.; Passaro, E. P.; Vigna, S. R.; Maggio, J. E.; Kruger, L.; Mantyh, P. W. *Proc. Natl. Acad. Sci. U.S.A.* **1988**, *85*, 3235.
17. Abbas, H. K.; Tanka, T.; Duke, S. D.; Porter, J. K.; Wray, E. M.; Hodges, L.; Session, A. E.; Wang, E.; Messill Jr, A. H.; Riley, R. J. *Plant Physiol.* **1994**, *106*, 1085.
18. Schwartz, G. K.; Jiang, J.; Kelsen, D.; Albino, A. P. *J. Nat. Cancer. Inst.* **1993**, *85*, 402.
19. Bezuidenhout, S. C.; Gelderbolm, W. C. A.; Gorst-Allman, C. P.; Horak, R. M.; Marssas, W. F. O.; Spiteller, G.; Vleggar, R. *J. Chem. Soc., Chem. Commun.* **1988**, 743.
20. Hoye, T. R.; Jimenez, J. I.; Shier, W. T. *J. Am. Chem. Soc.* **1994**, *116*, 9409.

## **PUBLICATIONS/CONFERENCES/SYMPOSIA PARTICIPATED/AWARDS**

---

1. Enantioselective synthesis of (-)- $\alpha$ -conhydrine via cyclic sulfate methodology

**Subba Rao V. Kandula** and Pradeep Kumar\*

*Tetrahedron Letters* **2003**, *44*, 1957.

2. Synthesis of novel chiral spirodione, (6 *R*, 7 *R*)-7-phenyl-1-oxaspiro[5.5]undec-3-ene-2,5-dione: application to the asymmetric Diels-Alder reaction with high  $\pi$ -facial selectivity

**Subba Rao V. Kandula**, Vedavati G. Puranik and Pradeep Kumar\*

*Tetrahedron Letters* **2003**, *44*, 5015.

3. Asymmetric synthesis of (-)-acaterin

**Subba Rao V. Kandula** and Pradeep Kumar\*

*Tetrahedron Letters* **2003**, *44*, 6149.

4. An asymmetric aminohydroxylation route to (+)-L-733,060

**Subba Rao V. Kandula** and Pradeep Kumar\*

*Tetrahedron : Asymmetry* **2005**, *16*, 3579

5. Asymmetric synthesis of (-)- $\alpha$ -conhydrine

**Subba Rao V. Kandula** and Pradeep Kumar\*

*Tetrahedron : Asymmetry* **2005**, *16*, 3268.

6. Concise and straightforward enantioselective synthesis of L-*threo*-sphinganine

**Subba Rao V. Kandula** and Pradeep Kumar\* (To be communicated)

7. General strategy of asymmetric aminohydroxylation to *cis*-2,6-disubstituted-3-piperidinols : Total synthesis of (-)-deoxocassine

**Subba Rao V. Kandula** and Pradeep Kumar\* (To be communicated)

8. Stereoselective synthesis of C<sub>1</sub>-C<sub>6</sub> fragment of fumonisin B

**Subba Rao V. Kandula** and Pradeep Kumar\* (To be communicated)



9. Application of the asymmetric aminohydroxylation reaction for the syntheses of HIV-protease inhibitor, hydroxy ethylene dipeptide isostere and  $\gamma$ -amino acid derivative

N. B. Kondekar, **Subba Rao V. Kandula** and Pradeep Kumar\*

*Tetrahedron Letters* **2004**, *45*, 5477.

10. Enantioselective synthesis of (-)-galantinic acid

S. K. Pandey, **Subba Rao V. Kandula** and Pradeep Kumar\*

*Tetrahedron Letters* **2004**, *45*, 5877.

11. A new reagent for oxidation of alcohols to carbonyls

**Subba Rao V. Kandula**, Abhishek Dubey and Pradeep Kumar\*

(To be communicated)

12. A simple and an efficient general procedure for stereoselective syntheses of three centered amino alcohols : Total synthesis of *L-arabino* and *xylo*-phytosphingosine

Abhishek Dubey, **Subba Rao V. Kandula** and Pradeep Kumar\*

(manuscript in preparation)

## Presentations at Symposia

---

1. Asymmetric Transformations Employing  $\Pi$ -face stereoselection and Synthesis of Biologically Active Molecules

**Participated as speaker in the First Junior National Organic Symposium Trust conducted by NOST-2004 , India**

2. Total synthesis of Fuminisin B<sub>2</sub>

**Subba Rao V. Kandula** and Pradeep Kumar\*

Presented a poster at Sixth National symposium in Chemistry, IIT, Kanpur, India, February 7-9 2003

3. Asymmetric dihydroxylation and aminohydroxylation routes to  $\alpha$  and  $\beta$ -conhydrine

**Subba Rao V. Kandula** and Pradeep Kumar\*

Presented a poster at Fifth National symposium in Chemistry,  
CLRI, Chennai, India, February 7-9 2002

4. Synthesis of novel chiral spirodione, (6*R*,7*R*)-7-phenyl-1-oxaspiro[5.5]undec-3-ene-2,5-dione: application to the asymmetric Diels-Alder reaction with high  $\pi$ -facial selectivity

**Subba Rao V. Kandula**, Vedavati G. Puranik and Pradeep kumar\*

Presented a poster at Fourth National symposium in Chemistry,  
NCL, Pune, India, February 7-9 2001

## AWARDS

---

1. The Keerti Sangoram Endowment award for **Best Research Scholar of the year 2004** (Chemical Sciences), NCL Research Foundation.
2. Enantioselective synthesis of (-)-galantinic acid

This work won the **Best Poster Award** on the occasion of National Science Day of India, NCL symposium, Feb'-2004.

# 1. CHIRAL AUXILIARY BASED ORGANIC TRANSFORMATIONS

## 1.1 Introduction

Facial selectivity during addition to  $sp^2$  carbon such as olefins, carbonyls etc. is at the heart of stereogenesis. Before realizing the importance of stereoelectronic effect, the more obvious steric effects were formulated and discussed. According to Cram's rule,<sup>1</sup> the approach of a nucleophile (Nu) to a carbonyl flanked by three different size of groups, e.g., Rs (small), Rm (medium), and Rl (large) would be preferentially from the direction occupied by the small substituent (Rs) as shown below (**Scheme 1**).

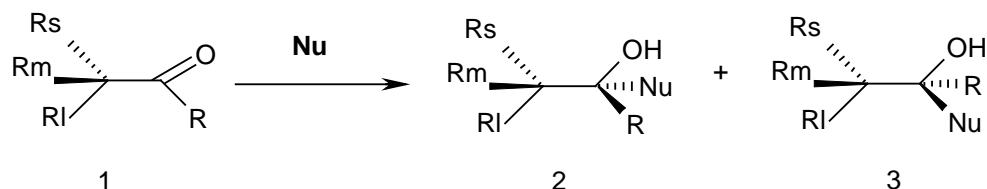

**Scheme 1**

However, the recent interest in stereoelectronic effect,<sup>2</sup> has contributed significantly for the explanation of  $\pi$ -face stereoselection. Various theories, have been developed which focus on the analysis of the intrinsic ground state properties of  $sp^2$  centers in substrates and also on the relative stabilities of diastereomeric states. A brief overview of some of them are discussed here.

1. FMO theory of stereoselection
2. Theory of steric consideration
3. Polar group effect
4. Nucleophilic and electrophilic surface theory
5. Stabilization due to hyperconjugative interaction (Cieplak effect)
6. Theory of  $\pi$ -electron density distortion by  $\sigma/\pi$ -mixing
7. Electrostatic interactions
8. Torsional and steric control

### 1. FMO (FRONTIER MOLECULAR ORBITAL) THEORY OF STEREOSELECTION

FMO theory developed by Fukui *et al.*<sup>3</sup> focusing mainly on the intrinsic inbuilt ground

state properties of substrates of  $\pi$ -facial diastereoselection have shown that the 2p

electron density is not disturbed symmetrically about the  $sp^2$  plane of a trigonal atom

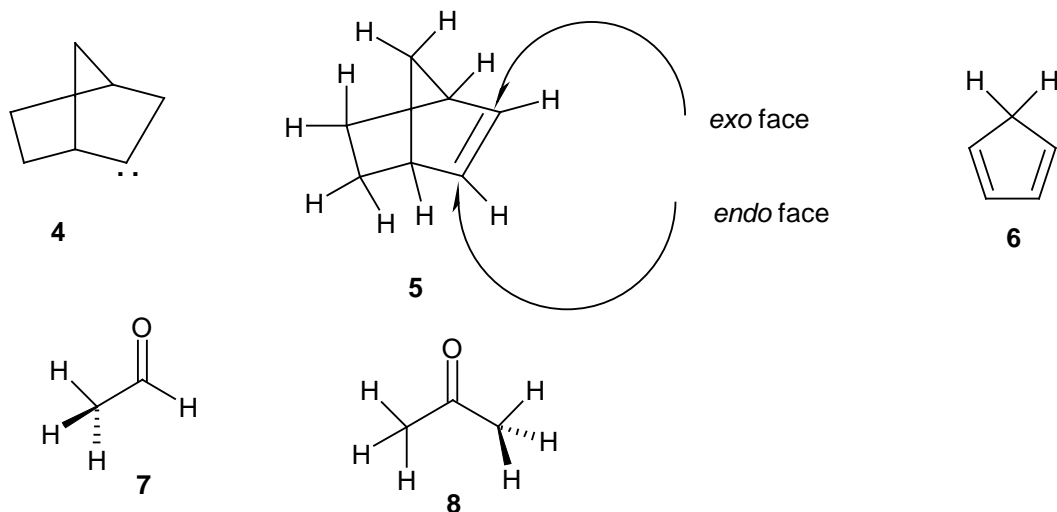

**Fig. 1**

which is placed in an asymmetric environment. The importance of non-equivalency in frontier

orbital extension is exemplified by electrophilic exo addition to norbornene and related compounds, e. g., 2-norbornyl radicals **4**,<sup>4</sup> norbornene **5**,<sup>5</sup> 5-substituted cyclopentadienes **6**<sup>6</sup> etc. Anh *et al.*<sup>7</sup> proposed non equivalent distribution of  $\pi$ -electron density of the carbonyl group in chiral aldehydes and ketones **7** and **8** (**Fig 1**).

FMO calculations carried out by extended Huckel method propose that in reaction such as electrophilic additions to alkenes or cycloadditions of electron deficient dienophiles i.e. reactions controlled by the interaction of HOMO of the chiral substrates with LUMO of the electrophiles will occur preferentially on the  $sp^2$  face where the HOMO is more extended. In the case of inverse electron demand cycloaddition reaction, reversal of the induction is expected.

In order to visualize the spatial extension of HOMO in norbornene, a contour map of the plane perpendicular to C(1)C(2)-C(3)C(4) coplane was examined, where the nonequivalence of the *exo* and *endo* face is self evident as shown in **Fig. 2**.

Some of the representative examples of exo-selective additions to norbornene are presented here (**Scheme 2**).

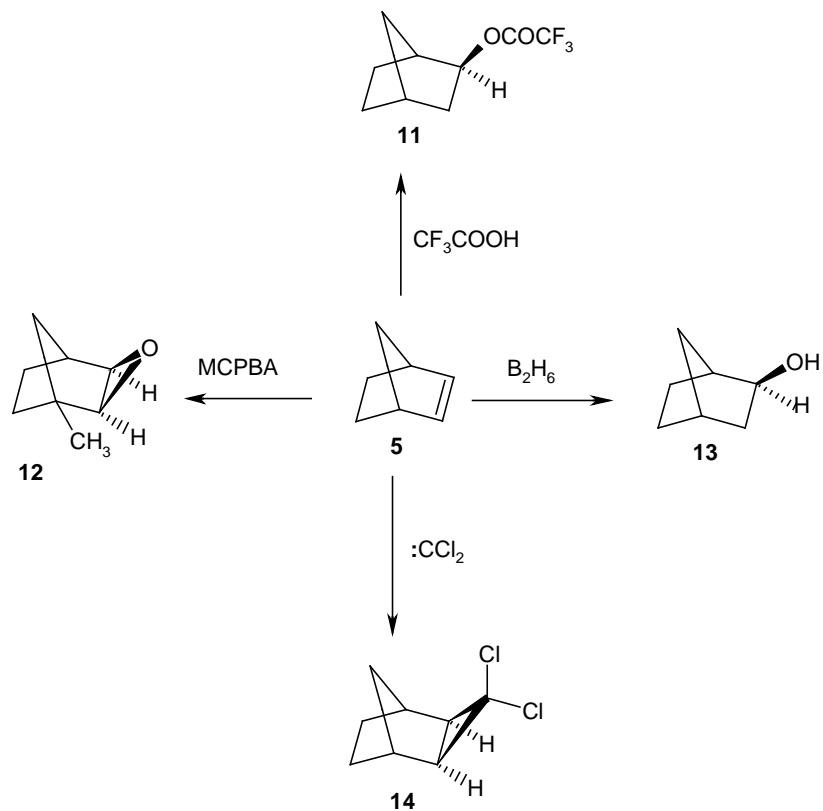

**Scheme 2**

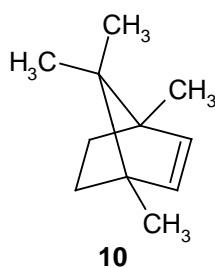

**Fig. 2**

## 2. THEORY OF STERIC CONSIDERATION

In system such as **5** and **15**, reactions at the olefinic center exhibit preference for the *exo*

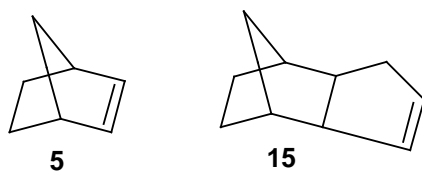

**Fig. 3**

product. Hydroboration and oxidation of **5** and **15** gave the *exo:endo* product ratios 99.5:0.5 and 99.5:0.1 respectively. Epoxidation gave epoxides predominantly (**Fig. 3**).

Compounds of this type have shown high degree of *exo*-selectivity towards a variety of reagents. It has been proposed by Brown<sup>8</sup> that, steric factors contribute greatly for this observations, where C-H of methano and ethano bridge create steric congestion for the incoming groups. Thus, in **5** there is one methano C-H and two ethano C-Hs, hence the approach from ethano side will have a considerable steric hindrance thereby explaining the stereoselectivity.

### 3. POLAR GROUP EFFECTS

Ginsburg *et al.*<sup>9</sup> observed a significant  $\pi$ -facial diastereoselection in the Diels-Alder reactions of a variety of tetraenic propellenes **16a-d** with 4-phenyl-1,2,4-triazoline-3,5-dione **18** (**Fig 4**). Thus, the reactions of **16d** with **18** furnished the product **19** from the cyclohexadiene face, i. e. *syn* addition (**Fig 5**). Ginsburg interpreted these observations in terms of polar group effect. This stereochemical preference was explained in terms of relative steric contributions of the flanking bridges in **16d** when carbonyl groups of the transition state of *syn* attack is stabilized by interaction between *n*-lobes of N=N lone pairs and the anti symmetric  $\pi^*$  orbital of the CO-X-CO bridge of **16a-c**.

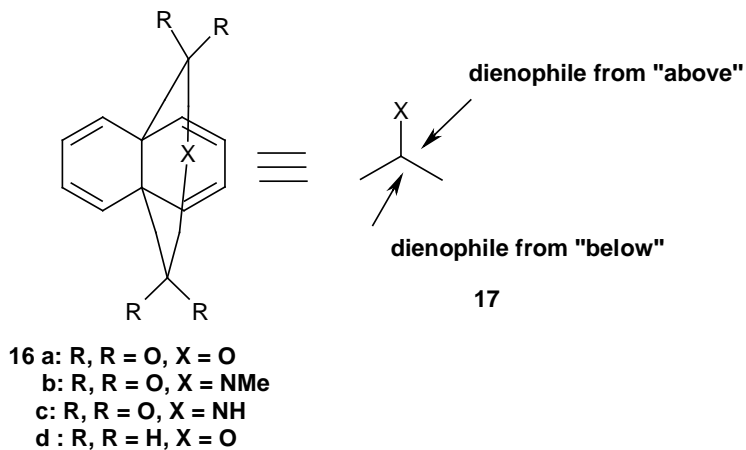

Fig. 4

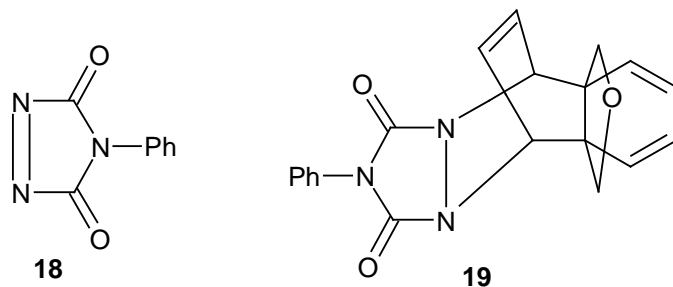
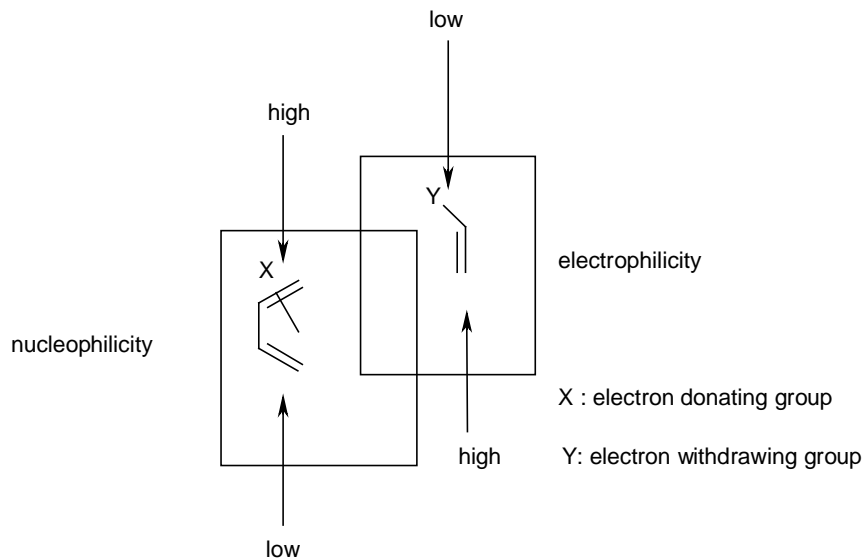

Fig. 5

#### 4. Nucleophilic and electrophilic surface theory

Hehre *et al.*<sup>10</sup> utilized the development of fast computational methods to probe the differences in the total electrostatic interactions on diastereofaces of a perturbed  $\pi$ -system. This methodology was already used by Muller & Brown<sup>11</sup> having the concept of total electrostatic interaction energy to evaluate the reactivity of two faces of a non-polar enamine towards electrophiles by using proton as a probe which was subsequently utilized to explain the mechanism of aldol catalysis by chiral amines.<sup>12</sup> Also a hydride probe was used in the calculations of electrostatic potential on the two faces of cyclohexanone complexed by a lithium cation<sup>13</sup> and hydride together with proton probes were used on bicyclo[2.2.1]heptane to understand the selectivity.

Before understanding the  $\pi$ -face selectivity, Hehre *et al.*<sup>10</sup> established that the observed regiochemistry in Diels-Alder reactions with one partner electron rich and another electron poor could be explained by matching the atomic reactivity surfaces obtained independently for each of the molecules. In case of normal Diels-Alder reaction where dienes HOMO and dienophile's LUMO interaction is presumed to exert the dominant influence on regioselectivity, the diene is probed with a test electrophile, e.g.,  $H^+$  and dienophile with a test nucleophile, e.g.,  $H^-$ . Reaction of regiochemistry is then determined in order to effect a best match of the complementary (electrophilic and nucleophilic) surfaces. In the case of inverse Diels-Alder reactions diene LUMO and



**Fig. 5**

dienophile

HOMO interact, probes are reversed and comparison of the potential of the diene towards dienophiles and dienophiles towards electrophiles are effected.

Modelling studies indicate that in extrapolation of the above ideas for  $\pi$ -face diastereoselection in the Diels-Alder reactions involving electron rich dienes and electron



deficient dienophiles, addition occurs preferentially onto the face diene which is more reactive towards electrophiles and onto the face of the dienophile which is more reactive towards nucleophile (**Fig. 5**)

These generalizations will reverse for reactions of electron deficient dienes and electron rich dienophiles (i. e. inverse electron demand reaction<sup>14</sup>).

## **5. STABILIZATION DUE TO HYPERCONJUGATIVE INTERACTION (CIEPLAK EFFECT)**

Of all the rationalizations for  $\pi$ -face diastereoselection, transition state stabilization and destabilization by electronic factors have widest acceptance. In the case of reaction in a cyclohexane moiety where one of the carbons of the ring is involved in the reaction, the first hypothesis suggests that equatorial transition state is more stabilized than the axial one by torsional strain. In equatorial attack the incipient bond is eclipsing the axial C<sub>2</sub> and C<sub>6</sub> carbon-hydrogen bonds which is a destabilizing interaction. The second hypothesis suggests that the axial transition state is stabilized by interaction with the  $\sigma^*$  antibonding orbitals of the axial C<sub>2</sub> and C<sub>6</sub> carbon-hydrogen bonds. In 1981, Cieplak *et al.*<sup>15</sup> put forward a hypothesis to explain about the transition state stabilization, where the interaction with the neighbouring occupied orbitals is considered as a dominant factor.

Cieplak stereoelectronic effect is one of the recent arrivals of this category based on the nature of donor acceptor bonds and has significant predictive capabilities. In the case of an addition of an anionic nucleophile Y<sup>-</sup> to a carbonyl group where the  $\pi_{CO}$  bond is being broken and a new carbon nucleophile  $\sigma_{CY}$  is being formed, the factor which competes with the steric hindrance during the axial approach (both approaches are

possible) originates in the non bonded interaction of the partially formed bond with neighbouring orbitals. There are three types of such interactions:

1. The four electron destabilizing interaction ( $\Sigma_{\neq} \Sigma_i$ ) with the vicinal covalent bonds eclipsing the incipient bond with the carbon-carbon or C-H bonds may lead to a destabilization of either transition state.
2. The two electron stabilizing interaction ( $\Sigma_{\neq}, \Sigma_i^*$ ) with the adjacent antibonding orbitals and
3. The two electron stabilizing interaction ( $\Sigma_i, \Sigma_{\neq}^*$ ) of the vicinal occupied orbitals with the antibonding orbitals of the incipient bond.

Further the  $\Sigma_i, \Sigma_{\neq}^*$  interaction is the dominant conjugative interaction in the bond forming process because the very definition of the incipient bond suggests that this bond is electron deficient. Thus postulating “the feature of transition state for nucleophile addition, critical for the stereochemistry of the reaction is a low lying orbital  $\Sigma_{\neq}^*$  associated with the  $\sigma$  bond being formed in the reaction. Thus, the non equivalence of the two faces of a carbonyl group with respect to electron donating power of the neighbouring orbitals might lead to a preference for the approach which assures maximum overlap of the  $\Sigma_{\neq}^*$  orbital with the best donating orbitals. This proposition attempts to generalize the concepts of the kinetic anomeric effect<sup>16</sup> and according to le Noble<sup>17</sup> extends the concepts of  $\sigma$ -assistance in the formation of carbonium ions to the reverse process of nucleophile capture. Thus, the electronic nature of the antiperpendicular bonds with respect to the incipient bonds (i. e., can be electron rich or poor) is important, but stabilization of the transition state by hyperconjugative interaction is expected only from the electron rich bond. Thus, on

the basis of nature of the respective antiperiplanar bonds towards the approach of the reagents from both faces the  $\pi$ -facial differentiation can be predicted. To illustrate this in the following examples **20**, **21** and **22** the approach of the hydride towards C=O is preferred from, axial and equatorial sides respectively. (**Fig. 6**)

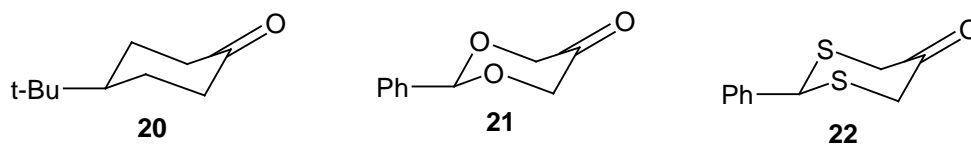

**Fig. 6**

In **20** the antiperiplanar bond C-H is better donor than C-C bonds, in **21** C-H is better than C-O whereas in **22** C-S is a better donor than C-H. Cieplak has graded various bonds according to their relative donating abilities.

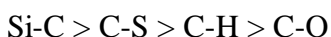

## 6. THEORY OF $\pi$ -ELECTRON DENSITY DISTORTION BY $\Sigma/\Pi$ .<sup>18</sup>

Extension of FMO concept by introducing  $\sigma$ -bonds besides  $\pi$ -bonds in their calculations led to the development of a new concept. The observed  $\pi$ -face diastereoselection was exemplified by isodicyclopentadiene **23** (**Fig. 7**) by its reactivity in [4+2] cycloaddition reactions where many experiments reveal that exclusive below plane bonding occurs with all dienophiles except maleic anhydride and singlet oxygen. The cause cannot be steric in origin because the bond formation on the diene surface is *syn* to the ethano bridge. Polar interactions can also be excluded because compound **23** and similar hydrocarbons have very low dipole moment. So the observed stereoselectivity can be explained in terms of  $\sigma/\pi$  interactions.

Paquette and Gleiter have formulated the FMO theory by introducing  $\sigma/\pi$  interactions in their calculations. Thus, broadly the reacting diene and dienophile components were divided into easily distinguishable regions. Active centers (AC); atomic sites where the new bonds are formed, the active frame (AF); atoms which are involved in  $\sigma/\pi$  reorganization during the reaction and the inactive frame (IF); comprising the remaining molecular fragments not involved in the reaction. (**Fig 8**)

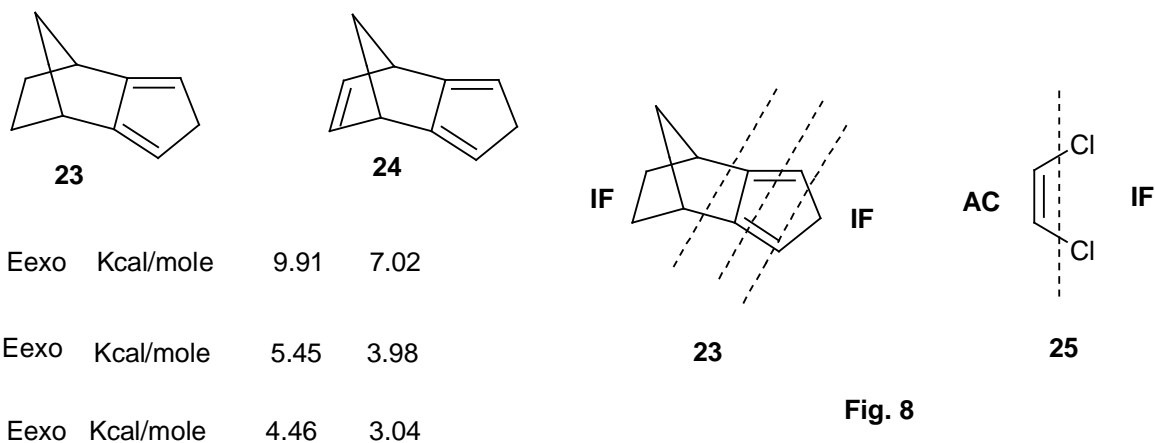

**Fig. 7**

Since in this analysis the influence of  $\sigma$ -orbitals at the reactive centers are also considered the  $E_{tot}$  can be written as  $E_{tot} = E_1 + E_2 + E_p + E_{\sigma/\pi}$  Where  $E_1$  is the energy gained or lost at the active centers,  $E_2$  is the energy gained or lost at the centers other than active centers,  $E_p$  is the energy due to the polar groups present on inactive frame which may disturb the proximal  $\pi$ -system, and  $E_{\sigma/\pi}$  accounts for interaction of  $\pi$ -orbitals of active centers and active frame with  $\pi$ -orbitals.

For the calculations of  $E_{\text{tot}}$ , semiempirical SPINDO (EHT, modified INDO) was used

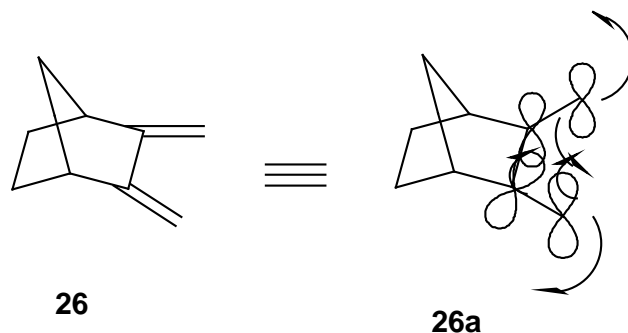

**Fig. 9**

together with abinitio (STO-3G) computational method, where a strong mixing between lowest occupied  $\pi$ -orbitals ( $\Pi_s$ ) and high lying  $\sigma$ -orbitals take place. The rotation  $P\pi$  lobes in the XZ plane **26** is in such a way that the lobes above the plane come to each other and lobes below the plane move apart as shown in **Fig. 9 (26a)**.

The kind of tilting gives rise to significant differences in the frontier electron distribution on the *exo* and *endo* diene surfaces.

From the energy calculated for **23** and **24** it is clear that the value for the reaction from the *exo* face is more than that for the *endo* face by 4.46 Kcal/mol. Therefore, *endo* face or bottom approach of the reagent is energetically favourable.

Some of the Diels-Alder reactions of **23** and its  $\pi$ -face preferences are shown in **Scheme**

**3.**

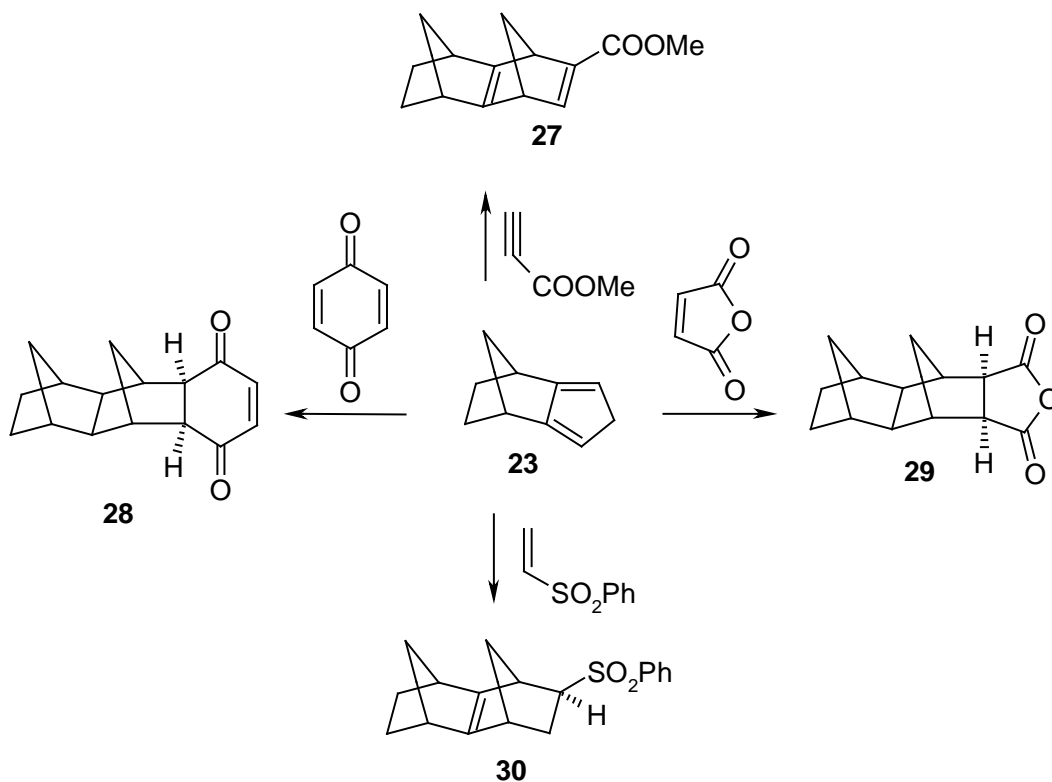

**Scheme 3**

## 7. ELECTROSTATIC INTERACTIONS<sup>19</sup>

In the reactions such as Diels-Alder, the role of solvent has been assumed to be static, i.e., its effect is roughly given through the contribution of the solvation energy of the reactants and transition states. Though the direct participation of the solvent molecules in the reaction coordinate in this case is unlikely. The electric field created by the solvent changes the shape of the potential energy surface and can modify the position of the stationary points.

In the case of Diels-Alder reaction of menthyl acrylate with cyclopentadiene where the diastereoselectivity of the reaction is governed by the chirality of the menthyl group, one cycloadduct is obtained in a series of solvents which requires a preferential approach of

the diene on *Si* face of the dienophile. Experimental data show that diastereomeric excess increases with solvent over the other. In all the cases parameters such as activation barriers, solvation energies, equilibrium geometries etc. have been taken into consideration.

## 8. TORSIONAL AND STERIC CONTROL<sup>20</sup>

Paquette<sup>18</sup> *et al.* proposed that the origin of  $\pi$ -facial selectivity is a function of orbital

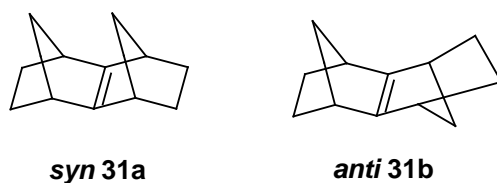

**Fig 10**

tilting of terminal  $P\pi$ -lobes of the diene frame work. But, Houk<sup>20</sup> *et al.* with the help of MM2 calculations, carried out on isocyclopentadiene and related molecules argued that the  $\pi$ -facial diastereoselectivity was due to torsional and steric effects. MNDO calculations predict that the double bond of *syn*-sesquiorbornene is flat and that the difference in energy between *anti* and *syn* sesquiorbornene **31a** and **31b** is 0.3 kcal/mol in favour of *anti* sesquiorbornene. Experimentally derivatives of *syn*-sesquiorbornene are bent by 16-18 and several Kcal/mol stable than *anti* sesquiorbornene which has the planar alkene moiety. Because of the unsatisfactory results from MNDO calculations, MM2 calculations were tried, which predicted the *syn* and *anti* geometries clearly and obtained reasonable energy difference.

With the help of MM2 calculations on isodicyclopentadiene (**Fig. 10**), Houk *et al.* suggested that the  $\pi$ -facial selectivity is due to the torsional strain about the  $C_1-C_2$  and  $C_6-C_7$  bond of the diene in the Diels-Alder transitional state. For the top attack, the

torsional interactions are increased due to more eclipsed arrangement. The difference in torsional strain about the C<sub>1</sub>-C<sub>2</sub> bond is 0.3 Kcal/mole and about C<sub>6</sub>-C<sub>7</sub> bond is also 0.3 Kcal/mole ultimately favouring the bottom attack of the diene skeleton.

Seebach *et al.*<sup>21</sup> work on (*R*)-3-hydroxy butanoic acid **32** as a chiral synthetic building block, after converting it into the dioxenone **33**, shows importance of stereoelectronic effect in deciding the stereochemistry of the carbon centers (**Scheme 4**). Reactions such as 1,4-additions, catalytic hydrogenations on **33** were found to afford single diastereomer. This observed stereoselectivity of addition to the dioxenone double bond is shown not to be due to steric effects. A kinetic stereoselection effect [*n*->(σ\*)<sup>#</sup> interaction] is proposed to cause the predominance of axial attack on the rather flat dioxenone molecule.

Demuth *et al.*<sup>22</sup> synthesized spirocyclic enones using menthone as chiral auxiliary to induce chirality in [2+2] cycloaddition reactions based on the novel principle of stereofacial differentiation.



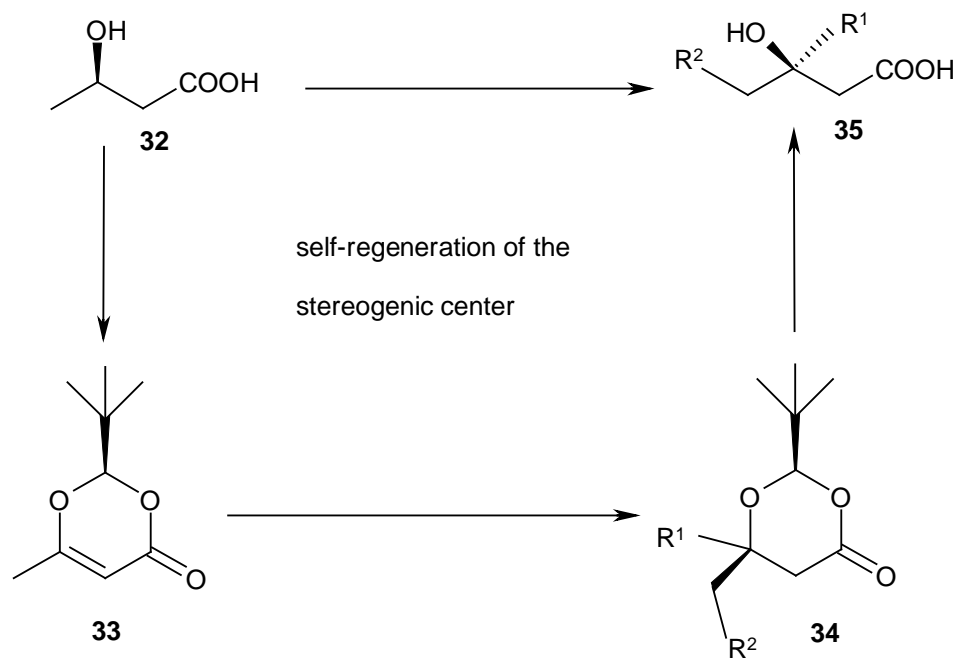

**Scheme 4**

Addition of olefins occurred exclusively from 'a' side which rules out effective shielding by the isopropyl group. (**Fig. 11**) It was assumed that the dioxacyclohexenone ring could adopt a twisted boat conformation in solution, an arrangement that exposes only 'a' side.

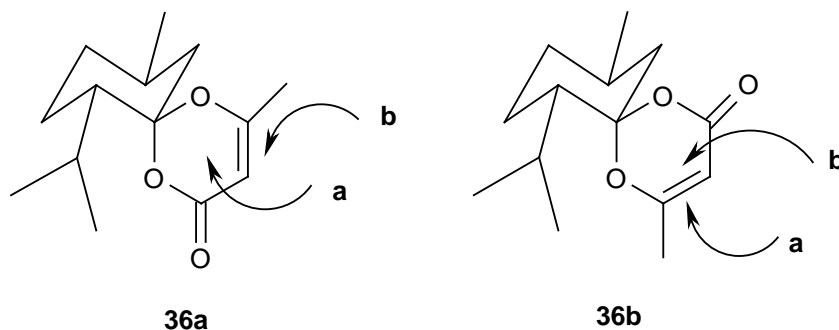

**Fig. 11**

## 1.2 Present work

### *Objective*

All the aforementioned theories were very fascinating in the field of asymmetric synthesis and all these developments prompted us for the pursuit of a new chiral antipode

which can be used efficiently for the chiral induction. Many novel chiral skeletons have also been reported which exhibited chiral induction e. g. Whitesell<sup>23</sup> **37**, Oppolzer<sup>24</sup> **38**, Enders<sup>25</sup> **39**, Meyers<sup>26</sup> **40**, Evans<sup>27</sup> **41** (**Fig. 12**). In all these studies normally an ester, amide, ether or hydrazone bonds were utilized for joining the auxiliary. We have developed a novel chiral spirodione (6*R*, 7*R*)-7-phenyl-1-oxaspiro[5.5]undec-3-ene-2,5-dione **42** utilizing carbon-carbon bond formation. The Diels-Alder reaction of **42** was examined using different dienes, and also an efficient method has been developed to cleave C-C bond from Diels-Alder cycloadducts. Due to the fascinating chemistry reported in the literature we wondered whether our rigid spiro system **42** attached to Whitesell chiral auxiliary could work as well or not.

### 1.3 Synthesis of (-)-*trans*-2-phenyl cyclohexanol

We attempted two synthetic routes to prepare (-)-*trans*-2-phenylcyclohexanol (Whitesell chiral auxiliary). One method involves enzymatic resolution of phenyl cyclohexylacetate **46** whereas the other method employs Sharpless asymmetric dihydroxylation of phenyl cyclohexene **50**.

As shown in **Scheme 5**, cyclohexene **43** was treated with 30% H<sub>2</sub>O<sub>2</sub> in the presence of potassium carbonate to give cyclohexene oxide **44** in 66% yield. Treatment of **44** with phenyl magnesium bromide in presence of catalytic amount of CuCl at -30 °C for 3 h gave racemic *trans*-phenylcyclohexanol **45** in excellent yield. Acetylation of **45** using acetic anhydride, pyridine and catalytic amount of DMAP in THF afforded **46** in 94% yield. IR spectrum of **46** indicated the absence of strong absorption of hydroxyl group and presence of acetyl group.

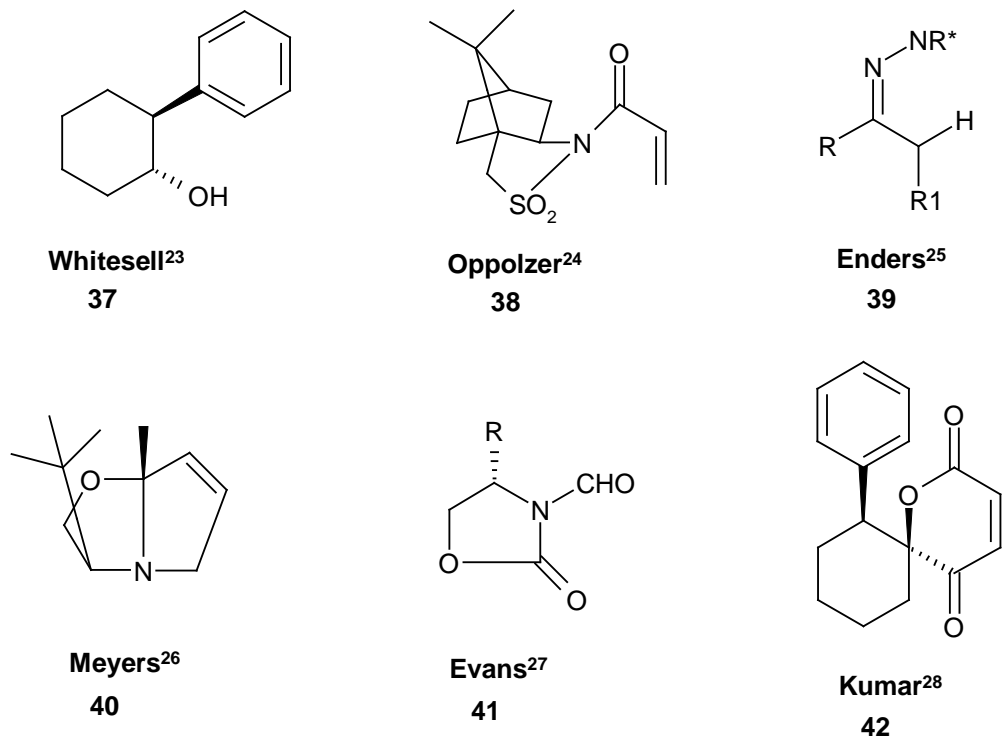
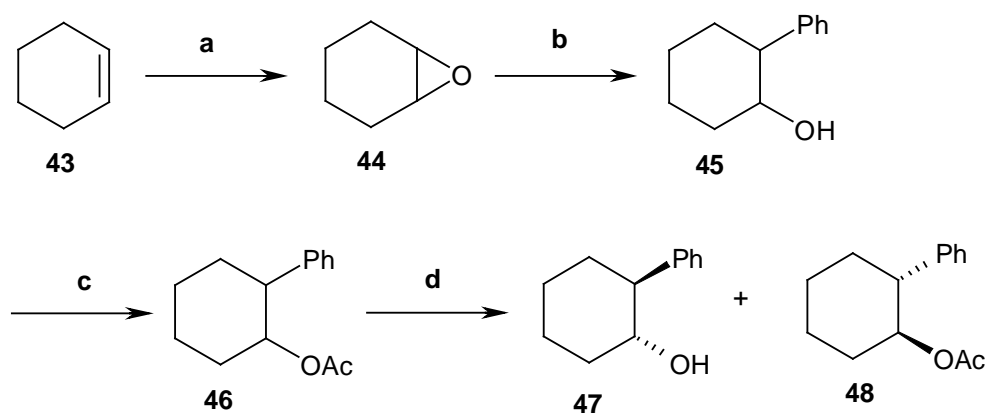

Fig. 12



Scheme 5

**Scheme 5 : Reaction conditions :** (a) 30% H<sub>2</sub>O<sub>2</sub>, CH<sub>3</sub>CN, K<sub>2</sub>CO<sub>3</sub>, 12 h, 66% ; (b) PhMgBr, CuCl, dry THF, -30 °C, 3 h, 81% ; (c) Ac<sub>2</sub>O, pyridine, DMAP, THF, 94% ; (d) PLAP, K<sub>2</sub>HSO<sub>4</sub>+KH<sub>2</sub>SO<sub>4</sub>, acetone, pH = 8, 10 days, 15%.

Treatment of **46** with freshly prepared PLAP<sup>29</sup> (Pig Liver Acetone Powder, a crude form of the enzyme Pig Liver Esterase) in phosphate buffer [K<sub>2</sub>HPO<sub>4</sub>+KH<sub>2</sub>PO<sub>4</sub>] of pH 8 at

25 °C for 10 days afforded (-)-*trans*-2-phenylcyclohexanol **47** in excellent enantiomeric purity and in low yield. The optical rotation of **47** was in full agreement with the literature value.<sup>39</sup> As we planned to carry out various organic transformations, therefore in order to obtain substantial amount of (-)-*trans*-2-phenylcyclohexanol **47** we attempted an alternative synthetic route where we used Sharpless asymmetric dihydroxylation<sup>30</sup> as key step shown in **Scheme 6**.

**Scheme 6** summarizes the synthesis of Whitesell chiral auxiliary **47** which commenced from cyclohexanone **49**. Phenyl Grignard of cyclohexanone **49** in the presence of CuCl at – 30 °C in dry THF solvent and subsequent dehydration gave phenyl cyclohexene **50** in 69% yield. In the <sup>1</sup>H NMR spectrum, presence of aromatic group at δ 7.30-7.47 (m) and olefin peak at δ 6.19 (t) clearly indicated the formation of product. Phenyl cyclohexene **50** was subjected to Sharpless asymmetric dihydroxylation using osmium tetroxide as oxidant and potassium ferricyanide as co-oxidant in the presence of (DHQD)<sub>2</sub>PHAL chiral ligand in *t*-BuOH:H<sub>2</sub>O (1:1) to give the diol **51** in excellent enantioselectivity<sup>31</sup> and in good yield. The optical rotation of **51** was in full agreement with the literature value.<sup>31</sup> IR spectrum clearly showed stretching at 3522 cm<sup>-1</sup> for hydroxyl functionality and in the <sup>1</sup>H NMR spectrum there was no olefin peaks. Removal of benzylic alcohol of **51** was achieved using Raney Ni in ethanol under heating conditions. The physical and spectroscopic data of **47** were in full agreement with the known literature data.<sup>31</sup>

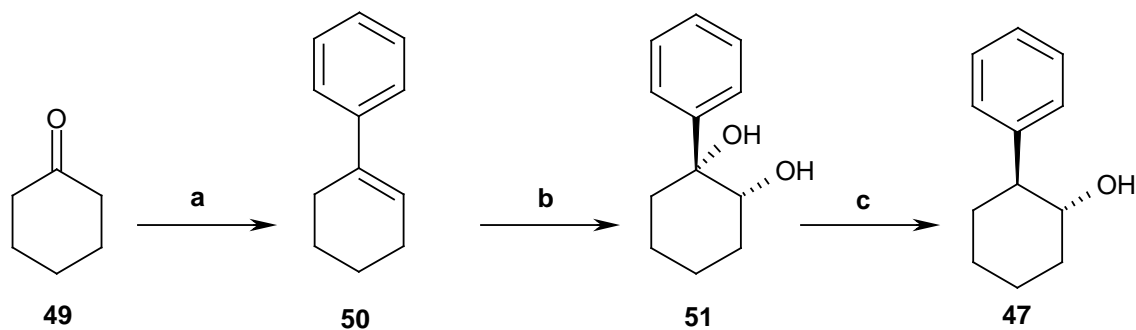

**Scheme 6**

**Scheme 6 : Reaction conditions :** (a) (i) PhMgBr, dry THF -30 °C ; (ii) *p*-TSA, benzene, Dean-Stark apparatus, 69% ; (b) (DHQD)<sub>2</sub>PHAL, OsO<sub>4</sub>, CH<sub>3</sub>SO<sub>2</sub>NH<sub>2</sub>, K<sub>3</sub>Fe(CN)<sub>6</sub>, K<sub>2</sub>CO<sub>3</sub>, *t*-BuOH:H<sub>2</sub>O (1:1), 24 h, rt, 99% ; (c) Raney Ni, ethanol, reflux, 2 h, 93%.

### 1.4 Synthesis of novel chiral spirodione: (6*R*,7*R*)-7-phenyl-1-oxaspiro[5.5]undec-3-en-2,5-dione

With substantial amount of Whitesell chiral auxiliary **47** in hand, we then proceeded with the synthesis of chiral spirodione **42** with an aim to examine if this rigid spiro system attached to *trans*-2-phenylcyclohexanol would work like the reported chiral auxiliary derived from menthone. Thus, the Whitesell chiral auxiliary **47** was first oxidized to (-)-phenyl cyclohexanone **52** using sodium dichromate. IR spectrum of **52** showed the presence of keto stretching at 1700 cm<sup>-1</sup>. Now the optically pure (-)-2-phenylcyclohexanone **52** was treated with 2-lithiated furan at 0 °C to give **53** quantitatively as a single diastereomer. The product **53** was characterized using IR which showed the presence of hydroxyl absorption at 3450 cm<sup>-1</sup> and absorption due to furan at 750 cm<sup>-1</sup>. <sup>1</sup>H NMR spectrum showed signals at δ 5.66-5.78 (dd), 6.0-6.10 (dd) and 6.80-7.30 (dd) which indicated the presence of furan moiety. <sup>13</sup>C NMR spectrum showed the presence of a single diastereomer and signals at δ 161.14, 140.61, 110.02 and 103.90 corresponding to furan carbons and signal at δ 76.21 (fu-C-OH) clearly indicated the formation of product. Finally the molecular ion peak confirmed the product. Treatment of

**53** with *m*CPBA at 10 °C afforded **54** in 74% yield which resulted due to a stereospecific oxidation–rearrangement sequence<sup>32</sup> on furan nucleus. Thus, IR spectrum showed strong absorptions at 3480-3280 cm<sup>-1</sup>, 1680 cm<sup>-1</sup> indicating the presence of hydroxyl group and enone ketone. In <sup>1</sup>H NMR, the broad singlet at δ 3.10-3.32 indicated the presence of hydroxyl group and peaks at δ 5.65-5.75 (m), 5.77-5.90 (dd) showed the presence of olefinic protons. In <sup>13</sup>C NMR two peaks for each carbon with equal intensity confirmed the presence of a mixture 1:1 diastereomers (due to the stereoisomer at anomeric center OH). The compound **54** was then treated with Jones' reagent at 0 °C to give **42** as a pale yellow solid (**Scheme 7**). The structure of **42** was confirmed by normal spectroscopic analysis and single crystal X-ray analysis. The strong absorption peaks in IR spectrum at 1730 cm<sup>-1</sup> and 1690 cm<sup>-1</sup> indicated the presence of ester and enone respectively. In <sup>1</sup>H NMR, signals at δ 6.37 (d) and 6.23 (d) indicated the presence of olefinic protons. In <sup>13</sup>C NMR, peaks at 196.31, 160.57 confirmed the keto and ester functionalities and signals at δ 137.2 and 134.3 indicated the presence of olefinic carbons along with the peak at δ 91.28 due to the presence of spirocarbon with one oxygen attached. In mass spectrum the molecular ion peak confirmed the product. The structure and absolute stereochemistry of compound **42** was confirmed by single crystal X-ray analysis.

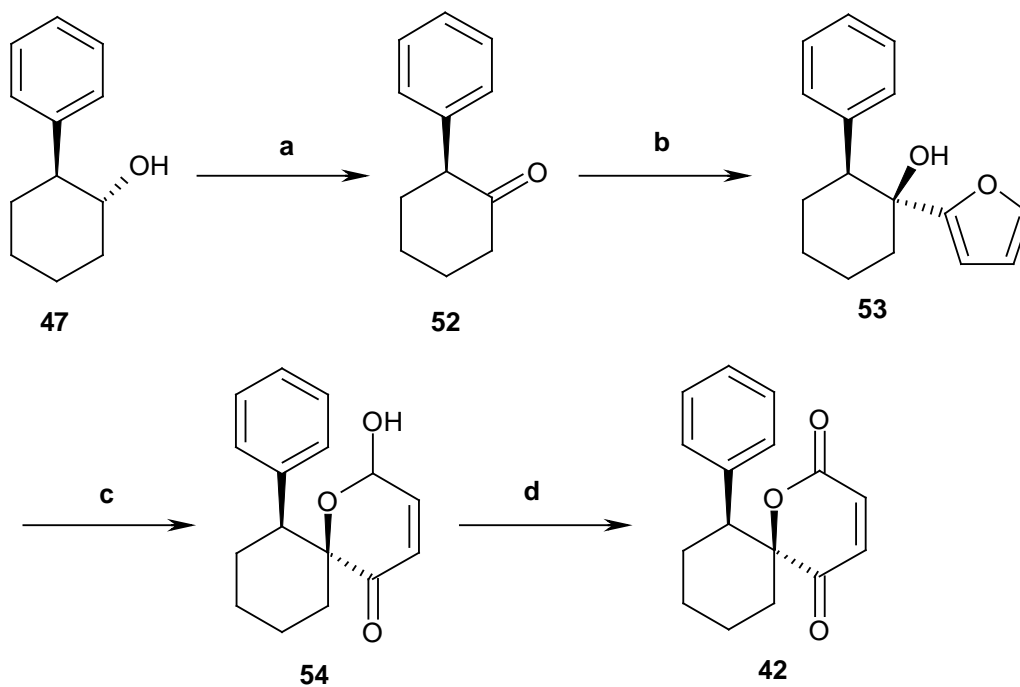

Scheme 7

**Scheme 7 : Reaction conditions :** (i)  $\text{Na}_2\text{Cr}_2\text{O}_7$ ,  $\text{H}_2\text{O}$ , 30 min, 75% ; (ii) Furan,  $n\text{-BuLi}$ , 6 h,  $-10^\circ\text{C}$  to rt, 93% ; (iii)  $m\text{CPBA}$ , dry DCM,  $10^\circ\text{C}$ , 4 h, 74% ; (iv) Jones' reagent, acetone, rt, 30 min, 95%.

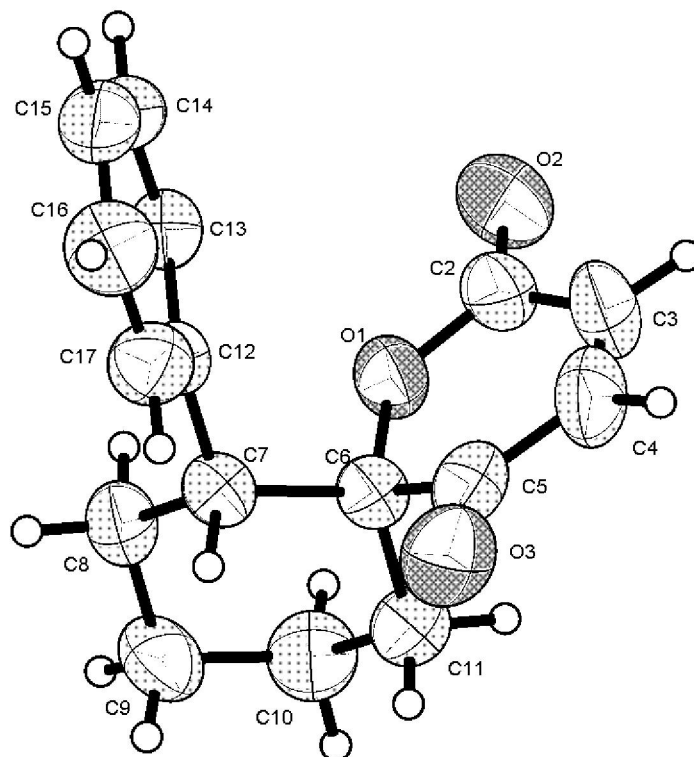

**Figure 13: ORTEP diagram of 42; thermal ellipsoids are drawn at 50% probability**

**CRYSTAL DATA OF 42 :** Single crystals were grown by slow evaporation of a solution in ethyl acetate/pet.ether. Colourless thin needles of approximate size 0.425 x 0.210 x 0.085 mm, were used for data collection on Bruker SMART APEX CCD (CCDC Ref. No. 197048) diffractometer using Mo K $\alpha$  radiation. C<sub>16</sub>H<sub>16</sub>O<sub>3</sub>; M.Wt = 256.29. Crystals belong to monoclinic space group P2<sub>1</sub>/c, a = 10.637 (1), b = 7.922 (1), c = 15.781 (2) Å,  $\beta$  = 97.200 (2)°, V = 1319.4(3) Å<sup>3</sup>, Z = 4, D<sub>c</sub> = 1.290 mg m<sup>-3</sup>,  $\mu$  (Mo–K $\alpha$ ) = 0.088 mm<sup>-1</sup>, T = 293(2) K, 7552 reflections measured, 2994 unique [I > 2 $\sigma$ (I)], R value 0.0593, wR<sub>2</sub> = 0.1564. All the data were corrected for Lorentzian, polarisation and absorption effects. SHELX-97 (SHELXTL) was used for structure solution and full matrix least squares refinement on F<sup>2</sup>. Hydrogen atoms were included in the refinement as per the riding model.

### 1.5 Asymmetric Diels-Alder reaction



The Diels-Alder reaction, one of the most useful synthetic reactions in organic chemistry, is one of the general class of cyclo-addition reactions. Since its discovery in 1928, it has become one of the most exploited and powerful reactions for carbon-carbon bond formation in organic synthesis. As far as the asymmetric synthesis is concerned in this reaction, with the formation of two bonds simultaneously, there can be a creation of up to four chiral centers at the reaction site with largely predictable relative stereochemistry.

Asymmetric Diels-Alder reactions are normally carried out by using either chiral reactants (diene and dienophile) or chiral catalysts. Quite a good number of examples are available in the literature where the use of chiral dienophile is found extensive and also a few reports for the use of chiral dienes and catalysts. As a review a few of them are discussed here briefly. We anticipated that our skeleton **42** would be highly reactive dienophile and give *endo* products.

### CHIRAL DIENOPHILE

A number of chiral auxiliaries have been used upon which the dienophile part was built. For example menthol or menthone, camphor, 8-phenyl menthol etc. are the more promising and commercially available. The usual bond pattern e.g., esters/amides in which the dienophile component is attached with, the cause of the stereospecificity etc. are discussed below for each of the methods.

#### Camphor as chiral sultam : (W. Oppolzer *et al.*)<sup>33</sup>

*N*-Acrolyl and *N*-crotonyl sultams were derived from (+)-camphor-10-sulfonyl chloride and were used for the Lewis-acid promoted Diels-Alder reactions to give good to

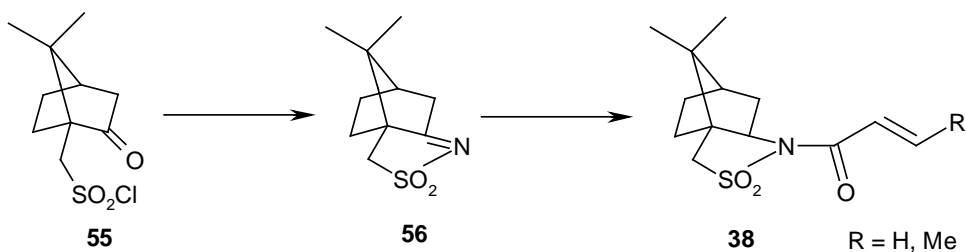

Scheme 8

excellent stereoselection (**Scheme 8**).

Excellent diastereoselectivities were observed when the Diels-Alder reaction of **38** were carried out with various dienes. A number of Lewis acids such as  $\text{TiCl}_4$ ,  $\text{SnCl}_4$ ,  $\text{BF}_3\text{-Et}_2\text{O}$ ,  $\text{Et}_2\text{AlCl}$ ,  $\text{EtAlCl}_2$  were used, out of which  $\text{TiCl}_4$  and  $\text{EtAlCl}_2$  turn out to be the best. The chiral sultams was later removed non-destructively by reducing with LAH (**Scheme 9**).X-

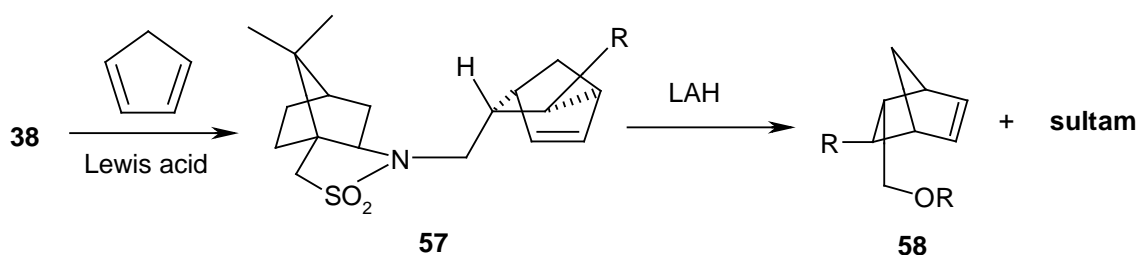

**Scheme 9**

Ray crystallography of **38** showed the *syn* planarity of the  $\text{C}\alpha$ ,  $\text{C}\beta$ -double bond with the carbonyl group which is *anti* to the  $\text{SO}_2$  group. To rationalize this Lewis acid promoted acceleration and diastereoselection in Diels-Alder reactions it is assumed that the dienophile is chelated to the Lewis acid, which apparently restricts rotation of the C (O) N and C (O)  $\text{C}\alpha$  bonds (**Fig. 14**).

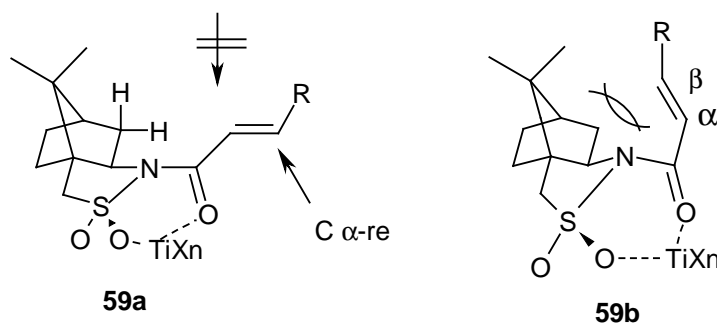
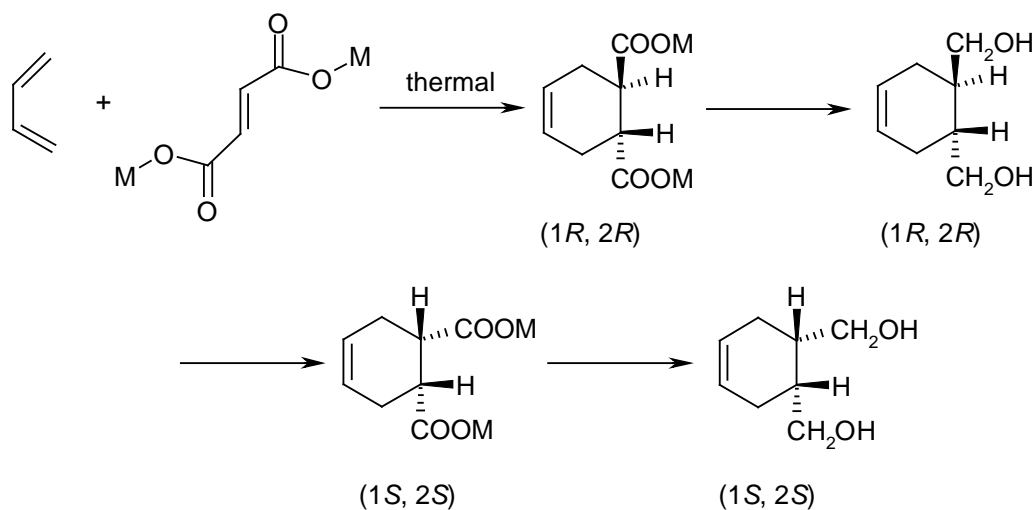

**Fig. 14**

Conformation **59a** is favoured over **59b** (for reasons of steric repulsion between  $C\beta$  and  $C\alpha$ ), *endo* attack of the diene from the less hindered face  $C\alpha$ -re occurs. The chiral auxiliary can be recycled and the other antipode is easily available.

### Menthol as dimethyl fumarate ; (H. W. Wolborsky *et al.*)<sup>34</sup>

Diels-Alder reaction of (-)-dimethyl fumarate with butadiene without the Lewis acid afforded the adducts in 1-3% optical purity, but when Lewis acids aids such as  $\text{SnCl}_4$ ,  $\text{TiCl}_4$  or  $\text{AlCl}_3$  were used, optical purities up to 78% were observed (**Scheme 10**). Parameters such as solvent, temperature and catalysts were shown to have effect on the optical purity. In the case of Lewis acid catalyzed reaction only the Si-face (complexes shown above in **Fig. 15**) attack is favoured thus giving the reverse stereoselection.



**Scheme 10**

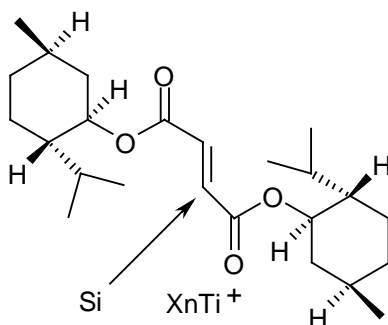

**Fig. 15**

**CHIRAL ACRYLATES (J. Sauer *et al.*)<sup>35</sup>**

Initial work by Sauer *et al.* and the reinvestigation by Oppolzer *et al.* on chiral acrylates derived from (-)-menthol and 8-phenyl menthol show that they are quite efficient in asymmetric Diels-Alder reactions. Selectivity up to 93% ee was observed after detaching the chiral auxiliary by reduction with LAH (**Scheme**

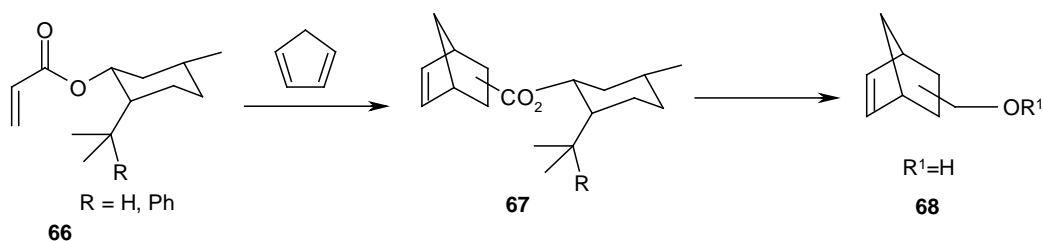

**Scheme 11**

11).

The rate and chiral induction in the reaction are dependent completely on the Lewis acid used. In 1975 Corey *et al.*<sup>36</sup> have used this methodology for the synthesis of lactone intermediate of prostaglandin. 8-Phenyl menthol was used as the chiral auxiliary to get the required (1*S*)-isomer.

**1.6 Asymmetric Diels-Alder reaction with chiral dienophile**

As mentioned in the **Scheme 7** compound **42** was obtained in optically pure form. We found that our system was unique and rigid, with a carbon-carbon bond attached to the auxiliary for Diels-Alder reaction studies in comparison to the other systems studied by Oppolzer, Enders. The chiral spirodione **42** can exhibit two different facial selectivities as reported for a similar kind of skeleton.<sup>37</sup> Thus, reagents can approach from the 'a' side *cis* to the phenyl group or from the 'b' side opposite to the phenyl group, as shown in **Figure 16**. The reactivity of our dienophile was anticipated to be fairly high due to strain and two electron withdrawing groups attached to the double bond.

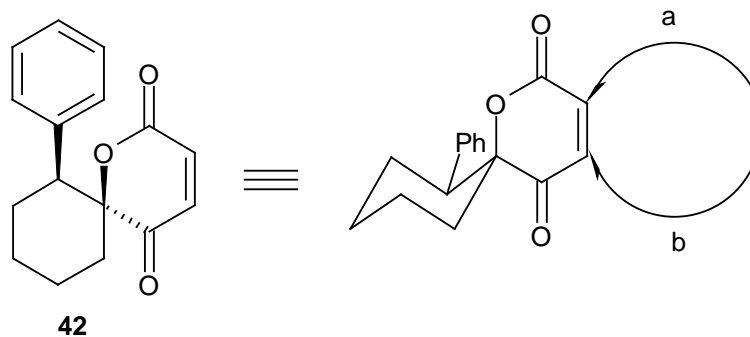

**Fig. 16**

By taking advantage of the diastereotopic face differences in **42**, we have examined the Diels-Alder reaction with a view to preparing an optically active skeleton. The approach of the diene is based on the chiral auxiliary **42**, which is expected to undergo  $\pi$ -face selective cycloaddition with a variety of dienes. Thus, the Diels-Alder reaction between dienophile **42** and diene cyclopentadiene in the presence of diethylaluminium chloride as Lewis acid gave the cycloadducts **69** as single diastereomers in 92-94% yield (**Scheme 12**). Diastereoselectivity was determined on the basis of  $^{13}\text{C}$  NMR spectroscopy. Compound **69** was characterized by spectroscopic and analytical methods. IR Spectrum showed sharp peaks at  $1750\text{ cm}^{-1}$  and  $1710\text{ cm}^{-1}$  for ester and ketone carbonyl. In  $^1\text{H}$  NMR, signals at  $\delta$  2.82-2.95 (dd, 1H) for proton on the carbon attached to the phenyl ring, at  $\delta$  6.00-6.10 (m, 1 H) and  $\delta$  6.14-6.22 (m, 1 H) for two olefinic protons clearly indicated the formation of product.  $^{13}\text{C}$  NMR showed a single diastereomer where signals at  $\delta$  136.48 for olefinic carbons and at  $\delta$  48.37 for bridge  $-\text{CH}_2-$  clearly indicated the product. Finally the molecular ion peak 322 ( $\text{M}^+$ ) in mass spectrum confirmed the product. We have examined the generality of the Diels-Alder cycloaddition reaction of **42** with other dienes such as 2,3-dimethyl-1,3-butadiene ; 2-methyl-1,3-pentadiene. In all cases excellent yields and diastereoselectivities were observed.

Thus, remarkable stereofacial differentiation, 100% preference for 'b' side to 'a' side as depicted in **Figure 16** in the Diels-Alder reaction was observed. In contrast to the literature reports<sup>37</sup> the Diels-Alder reaction with new chiral spiro skeleton **42** proceeded with high stereoselectivity but with complete reverse stereofacial selectivity. The reason for this unexpected reactivity pattern may be that the approach of the reagent, i.e. diene from side 'a' would cause appreciable steric hindrance between the phenyl group and diene, hence the attack of the reagent occurs preferentially from the 'b' side.

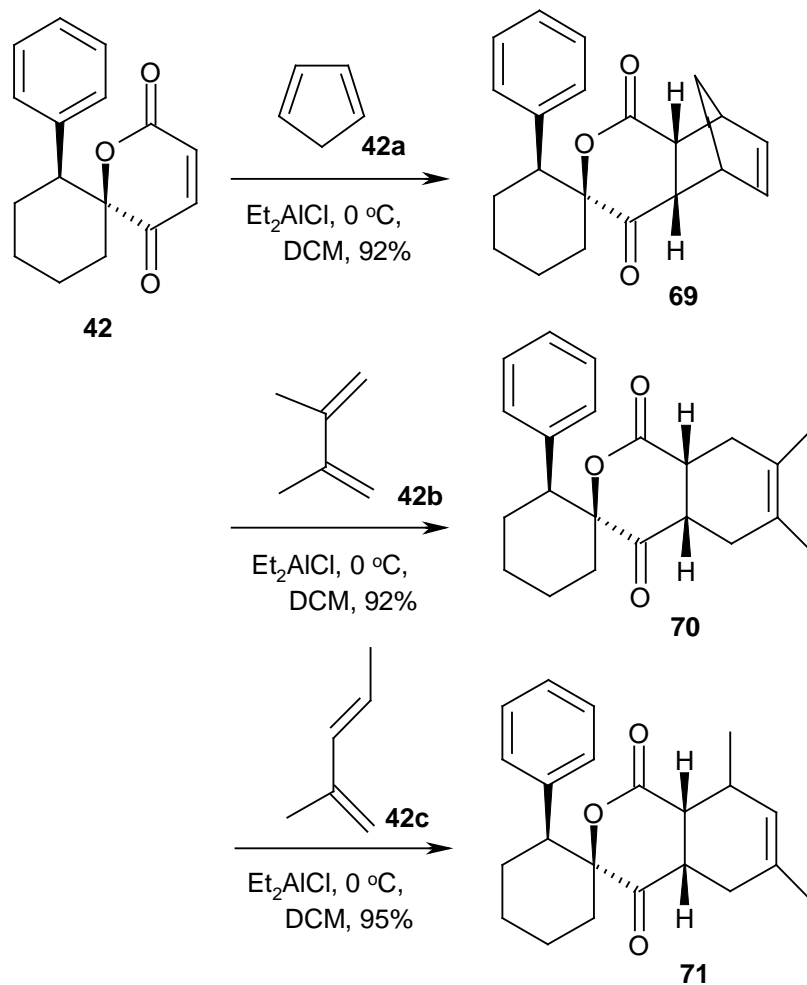

**Scheme 12**

Demuth *et al.*<sup>37</sup> have reported the preferential formation of cycloadduct with similar kind of skeleton. i.e., dioxacyclohexenones in which attack of the diene preferentially occurs from ‘a’ side. It was assumed that dioxacyclohexenone ring could adopt of a sofa conformation just as in crystallines, an arrangement that exposes ‘a’ side of the alkene. The stereoselectivities for thermal and photochemical addition to dioxenones were correlated with unidirectional pyramidalization of reacting centers. Similar observations were made by computational studies as well, which were experimentally verifiable.<sup>38</sup> It may be pertinent to mention here that complete reversal of selectivity (i.e., preferentially attack from ‘b’ side) has been reported in the literature for hydrogenation and methylation reactions with chiral synthons like spirodioxenones.

### 1.7 Detachment of chiral auxiliary from cycloadducts

In order to obtain the optically pure Diels-Alder product, we next attempted the detachment of the chiral auxiliary from the adduct **69** and successfully developed a two steps processes. Initially a number of methods were attempted to detach the auxiliary under mild conditions. A number of unisolable products were obtained by hydrolysis using KOH or NaOH at room temperature. Bayer-villeger oxidation of **69** was also unsuccessful. Finally, we adopted strategy to detach the auxiliary by the reduction of the

adducts. Thus, reduction of **69** using lithium aluminium hydride in THF under reflux conditions gave a triol **72** which was then cleaved using lead tetraacetate in benzene at room temperature to give optically pure (-)-*trans*-phenyl cyclohexanone **52** and the lactol **73** as shown in **Scheme 13**. Optical rotation of (-)-*trans*-phenyl cyclohexanone **52** was compared with the authentic and found identical. Thus, in IR spectrum of **73** showed broad peak at  $3390\text{ cm}^{-1}$  corresponding to  $-\text{OH}$  group. In  $^1\text{H}$  NMR signals at  $\delta$  3.38-3.45 (dd, 2H) indicated the presence of  $-\text{CH}_2-$  peak at  $\delta$  3.90-4.00 (q, 1H) corresponds to hydrogen on carbon which is attached to  $-\text{OH}$  group and olefinic protons appeared at  $\delta$  6.02-6.09 (m, 1H),  $\delta$  6.14-6.20 (m, 2H).  $^{13}\text{C}$  NMR showed a single isomer where signals at  $\delta$  136.2 and 135.5 indicated the olefinic carbons, peak at  $\delta$  65.0 and  $\delta$  46.9 showed the  $-\text{CH}_2\text{O}-$  carbon attached to  $-\text{OH}$  group.

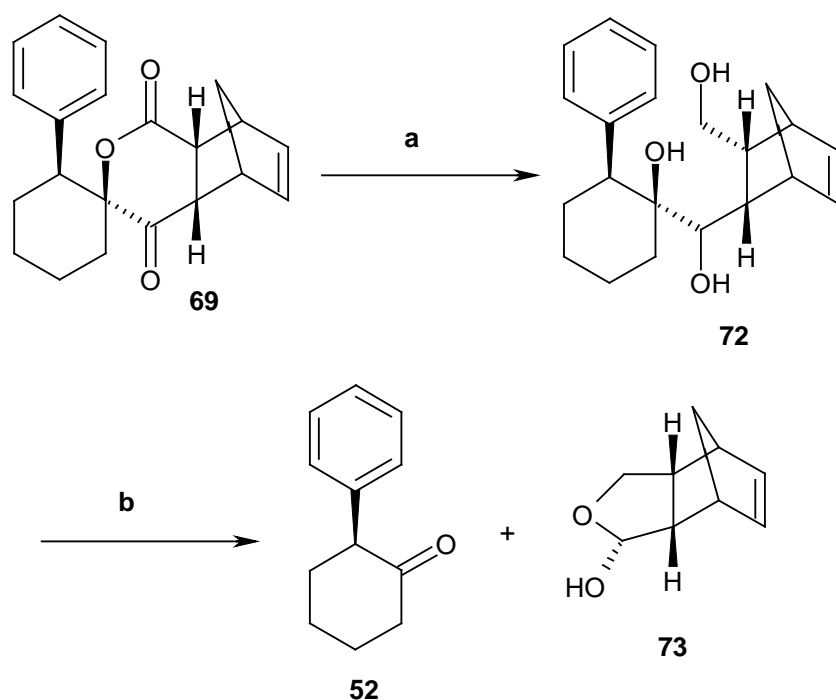

**Scheme 13**

**Scheme 3. Reagents and conditions :** (i)  $\text{LiAlH}_4$ , THF, reflux, 3 h, 65%; (ii)  $\text{Pb}(\text{OAc})_4$ , benzene,  $0\text{ }^\circ\text{C}$ , 30 min., 64%.

## 1.8 Conclusion

In conclusion, the synthesis of a new chiral spiro skeleton has been achieved. The efficient application of this chiral auxiliary to a highly versatile Diels-Alder reaction has been demonstrated and a methodology has been developed to cleave the auxiliary from cycloadducts.

## 1.9 Experimental Section

All reactions were performed under an inert atmosphere of argon, using freshly distilled and degassed solvents. Infrared spectra were recorded on a Perkin-Elmer 599B spectrometer. NMR spectra were recorded on a Bruker AC 200 operating at  $^1\text{H}$  (200 MHz) and  $^{13}\text{C}$  (50.3 MHz) and Bruker MSL-300 operating at  $^1\text{H}$  (300 MHz) and  $^{13}\text{C}$  (75.48 MHz) spectrometers in  $\text{CDCl}_3$ . Chemical shifts are reported in ppm downfield from TMS. Elemental analyses were carried out on a Carlo-Erba 1100 automatic analyzer. Melting points in the Celsius scale were determined in open capillary tubes on a Thermo-nik Campbell melting point apparatus and are uncorrected.

### Preparation of cyclohexene oxide

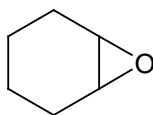

**44**

In a 500 mL round bottom flask cyclohexene **43** (20 g, 0.24 mol), methanol (34 mL), acetonitrile (25.5 mL, 0.48 mol) and potassium bicarbonate (4.26 g, 42.6 mmol) were taken. To this 30%  $\text{H}_2\text{O}_2$  (26 mL, 0.25 mol) was added dropwise with cooling at a rate that maintains the temperature of the reaction between 25-30 °C. Following the addition of  $\text{H}_2\text{O}_2$ , the ice bath was allowed to stir at room temperature overnight. After completion of the reaction, the reaction mixture was extracted with dichloromethane, washed with aqueous sodium chloride solution and dried over anhydrous  $\text{Na}_2\text{SO}_4$ , and concentrated under reduced pressure to give crude cyclohexene oxide **44** which was distilled to give pure cyclohexene oxide **44** (15.8 g).

**Yield :** 66%

$^1\text{H}$  NMR ( $\text{CDCl}_3$ , 200 MHz) :  $\delta$  0.90-1.53 (m, 4H), 1.86 (brs, 4H), 3.10 (s, 2H)

$^{13}\text{C}$  NMR ( $\text{CDCl}_3$ , 50 MHz) :  $\delta$  23.0, 28.1, 58.4

### Preparation of racemic-2-phenyl-cyclohexanol

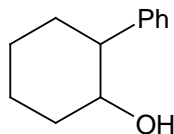

**45**

A solution of phenyl magnesium bromide was prepared from Mg (3.6 g, 0.15 mol) and bromo benzene (24 g, 0.15 mol) using standard procedures. The Grignard reagent solution was cooled to -30 °C and purified Cu(I)Cl (0.66 g, 6.7 mmol) was added. The resulting solution was allowed to stir for 10 min. and then a solution of cyclohexene oxide **44** (10 g, 0.1 mol) in 15 mL of dry THF was added dropwise. The reaction mixture was allowed to warm to 0 °C and stirred for 3 h, before quenching by the addition of 50 mL of saturated ammonium chloride. The organic layer was washed with saturated ammonium chloride until the aqueous layer were extracted with chloroform, dried over anhydrous  $\text{Na}_2\text{SO}_4$  and concentrated to near dryness. The crude product was purified on silica gel column chromatography using ethyl acetate:pet. ether (1:9) as eluent to give the desired racemic alcohol **45** as a light yellow solid (14.5 g).

**Yield :** 81%

**M. p. :** 56-57 °C [lit.<sup>39</sup> 57-58 °C]

$^1\text{H}$  NMR ( $\text{CDCl}_3$ , 200 MHz) :  $\delta$  1.26-1.53 (m, 4H), 1.63 (s, 1H), 1.76 (m, 1H), 1.84 (m, 2H), 2.12 (m, 1H), 2.43 (dt, 1H), 3.64 (dt, 1H), 7.13-7.39 (m, 5H)

$^{13}\text{C}$  NMR ( $\text{CDCl}_3$ , 50 MHz) :  $\delta$  24.8, 25.8, 33.1, 34.3, 52.8, 73.8, 126.2, 127.6, 128.2, 143.3

### Preparation of racemic-2-phenyl-cyclohexyl acetate



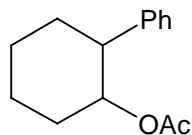

**46**

To a solution of *N,N* dimethylamino pyridine (0.19 g, 1.5 mmol) and pyridine (7.9 mL, 97.83 mmol) in dry dichloromethane (28 mL) was added dropwise with stirring a solution of racemic 2-phenyl cyclohexanol **45** (8.2 g, 46.5 mmol) in dichloromethane (7 mL). After stirring for 10 min, acetic anhydride (8.8 mL, 93.1 mmol) in dichloromethane (7 mL) was added dropwise over 1.5 h. After 2 h, the reaction mixture was poured into a mixture of 20 mL 6N HCl, 40 mL of ice water and 100 mL of ether. The organic layer was washed with 2 N HCl (4X60 mL), the combined aqueous layers were extracted with ether, the combined organic layers were washed with saturated NaHCO<sub>3</sub> and dried over anhydrous Na<sub>2</sub>SO<sub>4</sub> and concentrated to near dryness. The crude product was purified on silica gel column chromatography using ethyl acetate:pet.ether (9:1) to afford **46** (9.6 g) as a colorless liquid.

**Yield** : 94%

**IR** (neat, cm<sup>-1</sup>) :  $\nu_{\max}$  3070, 2940, 1730, 1610, 1490

**<sup>1</sup>H NMR** (CDCl<sub>3</sub>, 200 MHz) :  $\delta$  1.25-1.70 (m, 4H), 1.8 (s, 3H), 1.85-2.05 (m, 3H), 2.10-2.20 (m, 1H), 2.60-2.77 (td, 1H), 4.95-5.07 (m, 1H), 7.15-7.35 (m, 5H)

**<sup>13</sup>C NMR** (CDCl<sub>3</sub>, 50 MHz) :  $\delta$  17.6, 21.4, 24.5, 27.9, 28.8, 37.5, 76.6, 126.7, 128.2, 144.8, 171.0

#### Preparation of Pig Liver Acetone Powder

Fresh pig liver (500 g) was homogenized in 2L cold acetone by using a mixture and the residue was collected by filtration. The residue was further washed with cold acetone (1Lit) to remove the fatty material as cleanly as possible. The acetone powder thus obtained was dried at room temperature, powdered and sieved to obtain 80 g of fine PLAP.

#### Preparation of (1*R*,2*S*)-*trans*-2-phenylcyclohexanol (Enzymatic resolution of racemic-2-phenylcyclohexyl acetate)

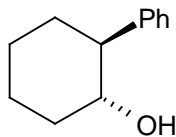

**47**

In a 2 L round bottom flask 2-phenyl cyclohexyl acetate **46** (13 g) was taken in 65 mL of acetone along with 500 mL of buffer [Na<sub>2</sub>HPO<sub>4</sub>+NaH<sub>2</sub>PO<sub>4</sub>] of pH 8 and stirred for 5 days at room temperature (25 °C). The stirring was continued for another 5 days with 0.6 g of additional amount of PLAP. Added 300 mL of diethyl ether and enough sodium chloride to the above mixture and stirred for 15 min. PLAP was filtered through cotton, the organic layer and the aqueous layer was separated. The aqueous layer was extracted with ether. The organic layer was dried over anhydrous Na<sub>2</sub>SO<sub>4</sub> and concentrated. The column chromatography on silica gel using pet.ether:ethyl acetate (95:5) as eluent afforded **47** (0.8 g) as light yellow solid.

**Yield** : 15%

**[ $\alpha$ ]<sub>D</sub><sup>25</sup>** : -58.0 (c 10, MeOH) [lit.<sup>39</sup> [ $\alpha$ ]<sub>D</sub><sup>25</sup> : -58.02 (c = 10, MeOH)]

**M. p.** : 63-65 °C [lit.<sup>39</sup> 64-65 °C]

#### Preparation of phenyl cyclohexene

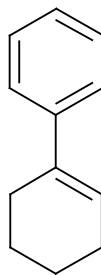

**50**

A solution of cyclohexanone **49** (10 g, 0.1 mol) in dry THF (50 mL) was added dropwise over 30 min with cooling below 20 °C to a Grignard reagent prepared from bromo benzene (32 g, 21.4 mL, 0.2 mol) and magnesium (4.8 g) in dry THF. Reaction was completed by heating under reflux for 2 h, when the mixture was cooled and treated with 6 N HCl. The organic layer was separated, washed with 2 N HCl, aqueous sodium carbonate and water, dried and solvent distilled off. The residual oil was dissolved in benzene (88 mL), *p*-TSA (0.7 g) was added and the solution heated in a Dean-Stark apparatus until separation of water was complete. The solution was washed with dilute sodium carbonate, then with water, dried and the solvent distilled off. The residue oil was distilled under vacuum to give desired phenyl cyclohexene **50** as a colorless oil.

**Yield** : 69%

**<sup>1</sup>H NMR (200 MHz, CDCl<sub>3</sub>)** : δ 1.71-1.87 (m, 4H), 2.27 (d, *J* = 2 Hz, 2H), 2.48-2.52 (m, 2H), 6.19 (t, *J* = 8 Hz, 1H), 7.30-7.47 (m, 5H)

**<sup>13</sup>C NMR (50 MHz, CDCl<sub>3</sub>)** : δ 22.1, 23.0, 25.8, 27.4, 124.5, 124.9, 128.0, 136.6, 142.6

#### Preparation of (1*R*,2*R*)-1-phenyl-cyclohexane-1,2-diol

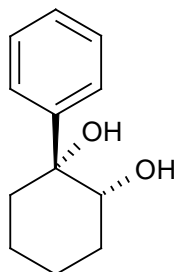

**51**

To a mixture of K<sub>3</sub>Fe(CN)<sub>6</sub> (6.2 g, 18.9 mmol), K<sub>2</sub>CO<sub>3</sub> (2.6 g, 18.9 mmol) and (DHQD)<sub>2</sub> PHAL (49 mg, 1 mol%) in *t*-BuOH-H<sub>2</sub>O (1:1) cooled at 0 °C was added osmium tetroxide (0.13 mL, 0.1 M solution in toluene, 0.2 mol%) followed by methanesulfonamide (0.6 g, 6.3 mmol). After stirring for 5 min at 0 °C, the olefin **50** (1 g, 6.3 mmol) was added in one portion. The reaction mixture was stirred at 0 °C for 24 h and then quenched with solid sodium sulfite (2.5 g). The stirring was continued for an additional 45 min and then the solution was extracted with ethyl acetate (5x50 mL). The combined organic phases were washed with 10% aqueous KOH, brine, dried (Na<sub>2</sub>SO<sub>4</sub>) and concentrated. Silica gel column chromatography of the crude product using pet.ether:EtOAc (4:6) as eluent gave diol **50** (1.2 g).

**Yield** : 99%

[α]<sub>D</sub><sup>25</sup> : +18.8 (*c* = 1.22, benzene) [lit.<sup>31</sup> [α]<sub>D</sub><sup>25</sup> : +18.9 (*c* = 1.29, benzene)]

**M.p.** : 120-121 °C [lit.<sup>31</sup> 121-122 °C]

**<sup>1</sup>H NMR (CDCl<sub>3</sub>, 200 MHz)** : δ 1.52-1.98 (m, 8H), 2.54 (s, 1H), 3.98-4.12 (dd, *J* = 8, 6 Hz, 1H), 7.32-7.49 (m, 5H)

**<sup>13</sup>C NMR (CDCl<sub>3</sub>, 50 MHz)** : δ 20.3, 23.5, 28.5, 37.8, 73.6, 75.0, 124.4, 126.1, 127.5, 145.8

#### Preparation of (-)-(1*R*,2*S*)-*trans*-2-phenylcyclohexanol

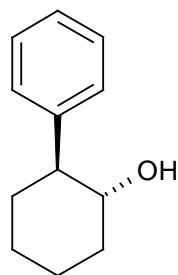

**47**

In a single-neck round bottom flask equipped with reflux condenser was dissolved **51** (5 g) in ethanol (125 mL). Raney® Ni (50 g) was added to this solution with the aid of ethanol (125 mL) and this stirred suspension was heated to reflux. After 2 h, the suspension was allowed to cool and then filtered through a pad of celite, and the celite was rinsed with ethanol (2 X 50 mL). The ethanol was concentrated and the crude product dried in vacuo to give a white solid. This solid was purified on silica gel column chromatography using pet.ether:ethyl acetate (9.5:0.5) as a eluent to give **47** (4.3 g).

**Yield** : 93%

$[\alpha]_D^{25}$  : -56.9 ( $c = 1.12$ , MeOH) [lit.<sup>31</sup>  $[\alpha]_D^{25}$  : -56.8 ( $c = 1.42$ , MeOH)]

**M.p.** : 64-65 °C [lit.<sup>31</sup> 64-65 °C]

$^1\text{H NMR}$  ( $\text{CDCl}_3$ , 200 MHz) :  $\delta$  1.26-1.56 (m, 4H), 1.72-1.98 (m, 2H), 2.14-2.25 (m, 2H), 2.43-2.49 (m, 1H), 3.67-3.72 (m, 1H), 7.27-7.62 (m, 5H)

$^{13}\text{C NMR}$  ( $\text{CDCl}_3$ , 50 MHz) :  $\delta$  24.8, 25.8, 33.1, 34.3, 52.8, 73.8, 126.2, 127.6, 128.2, 143.3

**Preparation of (-)-2-Phenyl cyclohexanone**

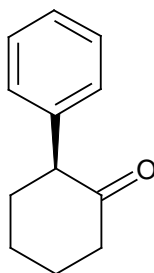

**52**

In a round bottom flask sodium dichromate (5.28 g, 17.6 mmol) and 18 mL of water was taken. To this was added slowly 4.5 mL of conc.  $\text{H}_2\text{SO}_4$  and the flask was cooled to 15 °C followed by addition of (-)-2-phenyl cyclohexanol **47** (4.5 g, 25 mmol) in portions at 15 °C with stirring. The reaction mixture was stirred for an additional 30 min at room temperature. 100 mL of water was added and reaction mixture extracted with dichloromethane repeatedly. The extract was washed repeatedly with water and dried over  $\text{Na}_2\text{SO}_4$ . Column chromatography on silica gel using pet.ether:ethyl acetate (97:3) afforded **52** (3.7 g) as a colorless low melting solid.

**Yield** : 75%

**M. p.** : 37-38 °C

$[\alpha]_D^{25}$  : -112.8 ( $c$  0.5, benzene)

**IR** ( $\text{CHCl}_3$ ,  $\text{cm}^{-1}$ ) :  $\nu_{\text{max}}$  1700, 1450

$^1\text{H NMR}$  ( $\text{CDCl}_3$ , 200 MHz) :  $\delta$  1.43-1.52 (m, 4H), 1.58-1.70 (m, 2H), 2.24-2.34 (m, 1H), 2.68-2.81 (m, 1H), 5.14-5.17 (m, 1H), 7.24-7.33 (m, 5H)

$^{13}\text{C NMR}$  ( $\text{CDCl}_3$ , 50 MHz) :  $\delta$  24.5, 27.1, 34.4, 41.4, 56.4, 126.0, 127.5, 127.9, 138.3, 209.1

**Preparation of 1-(2-furyl)-2-phenylcyclohexan-1-ol**

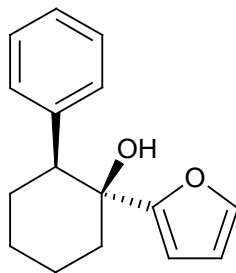

**53**

To a solution of freshly distilled furan (2 g, 11.49 mmol) in anhydrous ether (15 mL), was added *n*-BuLi (5.3 mL, 2.0 M solution in *n*-hexane, 11.49 mmol) dropwise under argon atmosphere at a temperature maintained between  $-10\text{ }^{\circ}\text{C}$  to  $-5\text{ }^{\circ}\text{C}$ . The reaction was then allowed to come to room temperature and stirred for 1h. The temperature was then brought down to  $0\text{ }^{\circ}\text{C}$ . (-)-Phenyl cyclohexanone **52** (2.0 g, 11.49 mmol) was added in 10 mL of anhydrous ether dropwise over a period of 30 min. The reaction temperature was gradually brought up to room temperature and stirred for 4 h. The contents of the flask were then poured into a beaker containing 10 mL of saturated ammonium chloride solution and stirred for 15 min. The organic layer was then separated and washed with brine and water (20 mL each) and dried over anhydrous  $\text{Na}_2\text{SO}_4$ . Concentration under reduced pressure and column chromatography on silica gel using pet.ether:ethyl acetate (98:2) afforded **53** (2.58 g) as yellow oil.

**Yield :** 93%

**IR (neat,  $\text{cm}^{-1}$ ) :**  $\nu_{\text{max}}$  3540, 3025, 2940, 2860, 1620, 1500, 1450

**$^1\text{H}$  NMR ( $\text{CDCl}_3$ , 200 MHz) :**  $\delta$  1.20-2.33 (m, 8H), 2.2 (s, 1H), 3.20 (dd,  $J = 16, 8\text{ Hz}$ , 1H), 5.78 (d,  $J = 10\text{ Hz}$ , 1H), 6.10 (d,  $J = 10\text{ Hz}$ , 1H), 6.80-7.30 (m, 6H)

**$^{13}\text{C}$  NMR ( $\text{CDCl}_3$ , 50 MHz) :**  $\delta$  21.2, 26.0, 27.4, 38.0, 51.5, 73.6, 104.2, 109.9, 127.7, 128.2, 140.3, 141.8, 160.2

**Analysis :**  $\text{C}_{16}\text{H}_{18}\text{O}_2$  (242.13) requires C, 79.31 ; H, 7.49. Found. C, 79.28 ; H, 7.44.

**Preparation of 2-hydroxy-7-phenyl-1-oxaspiro [5.5] undec-3-en-5-one**

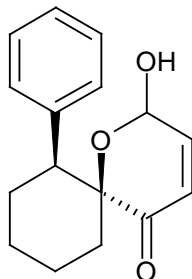

**54**

To a stirred solution of **53** (3 g, 12.39 mmol) in anhydrous dichloromethane (40 mL) maintained around  $10\text{ }^{\circ}\text{C}$  was added *m*-CPBA (3.4 g, 19.8 mmol) in small portions and stirring was continued at room temperature for 5 h. The progress of the reaction was monitored by TLC. The mixture was then cooled to  $0\text{ }^{\circ}\text{C}$  and the precipitated solid was removed by filtration. The filtrate was washed successively with 25 mL of 20% aqueous KI, 30 mL of 30% aqueous  $\text{Na}_2\text{SO}_4$ . The solvent was evaporated and the crude product was chromatographed on silica gel using pet.ether:ethyl acetate (90:10) to yield **54** (2.36 g) as a viscous liquid.

**Yield :** 74%

**IR (neat,  $\text{cm}^{-1}$ ) :**  $\nu_{\text{max}}$  3420, 3020, 2940, 1690, 1615, 1450, 1240

**$^1\text{H}$  NMR ( $\text{CDCl}_3$ , 200 MHz) :**  $\delta$  1.45-1.95 (m, 8H), 3.10-3.35 (bm, 2H), 5.65-5.75 (m, 1H), 5.77-5.90 (dd,  $J = 10, 4\text{ Hz}$ , 1H), 6.60-6.75 (dd,  $J = 12, 6\text{ Hz}$ , 1H), 7.10-7.45 (m, 5H).

**$^{13}\text{C}$  NMR ( $\text{CDCl}_3$ , 50 MHz) :**  $\delta$  18.8, 25.6, 27.4, 27.7, 35.7, 83.6, 86.8, 125.8, 127.2, 129.2, 129.6, 142.5, 142.6, 199.3

**Analysis :**  $\text{C}_{16}\text{H}_{18}\text{O}_3$  (258.13) requires C, 74.39 ; H, 7.02. Found. C, 74.33 ; H, 7.01.

**Preparation of (6*R*, 7*R*)-7-phenyl-1-oxaspiro [5.5] undec-3-ene-2,5-dione**

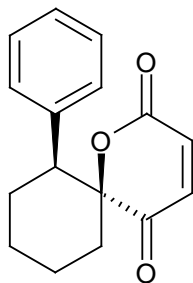

**42**

To an ice cold stirred solution of **54** (2.25 g, 9.5mmol) in 40 mL of acetone, was added 2.5 mL of Jones' reagent [prepared by dissolving 2.7g of CrO<sub>3</sub> in 7 mL of water followed by the careful addition of 2.3 mL of concentrated H<sub>2</sub>SO<sub>4</sub>] dropwise. After stirring for an additional 30 min the inorganic materials were filtered off. The filtrate was concentrated on rotavapor and partitioned between 75ml of ether and 50ml of water. The organic layer was separated, washed with water (3X20ml) and dried over anhydrous Na<sub>2</sub>SO<sub>4</sub>. Removal of the solvent and subsequent column chromatography on silica gel using pet.ether:ethyl acetate (96:4) as eluent afforded **42** (2.20 g) as a yellow solid. It was then further recrystallized from *n*-hexane to give compound **42** as yellow needles.

**Yield:** 95%

**M.p:** 97 °C

$[\alpha]_D^{25}$  : + 74.9 (*c* =10, CHCl<sub>3</sub>)

**IR** (CHCl<sub>3</sub>, cm<sup>-1</sup>) :  $\nu_{\max}$  2910, 2840, 1735, 1690, 1625, 1470, 1385, 1330, 1310

**<sup>1</sup>H NMR** (CDCl<sub>3</sub>, 200 MHz) :  $\delta$  1.45-1.65 (m, 1H), 1.68-1.80 (m, 2H), 1.85-2.10 (m, 4H), 2.22 (dd, *J* = 16, 4 Hz, 1H), 3.20 (dd, *J* = 16, 4 Hz, 1H), 6.22 (d, *J* = 16 Hz, 1H), 6.4 (d, *J* = 16 Hz, 1H), 7.05-7.15 (m, 2H), 7.17-7.29 (m, 3H).

**<sup>13</sup>C NMR** (CDCl<sub>3</sub>, 50 MHz) :  $\delta$  20.0, 25.5, 26.8, 35.8, 51.4, 91.2, 127.7, 128.7, 128.9,

134.3, 137.2, 139.4, 160.5, 196.3

**MS m/z** : 256 (M<sup>+</sup>, 14%) : 212, 165, 139, 131, 126, 117, 104, 91, 82.

**Analysis** : C<sub>16</sub>H<sub>16</sub>O<sub>3</sub> (256.11) requires C, 74.13 ; H, 6.29. Found. C, 74.96 ; H, 6.25.

#### General Procedure for Diels-Alder Reaction

To stirred solution of **42** (0.1 g, 0.39 mmol) in dry toluene (3 mL) was added cyclopentadiene **42a** (0.05 g, 0.78 mmol) then the solution was cooled to 0 °C. Et<sub>2</sub>AlCl (0.63 mL, 1 M solution in toluene) was added dropwise to the above solution and the reaction mixture was stirred for 3 h followed by dropwise addition of 5 mL of saturated solution of NH<sub>4</sub>Cl and stirred for 10 min. The organic layer was separated and the aqueous layer was extracted with 20 mL of ether. The combined organic extracts were washed with brine and dried over anhydrous Na<sub>2</sub>SO<sub>4</sub>. Concentration on rotavapor and column chromatography on silica gel using pet.ether:ethyl acetate (95:5) as eluent afforded **69** (0.112 g) as a liquid.

#### Spectral data of **69**

**Yield** : 92%

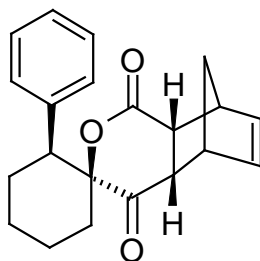

**69**

$[\alpha]_{25}^D$  : +16.6 ( $c = 1.1$ ,  $\text{CHCl}_3$ )

**IR (neat,  $\text{cm}^{-1}$ )** :  $\nu_{\text{max}}$  1750, 1710, 1455, 1250

**$^1\text{H NMR}$  (200 MHz)** :  $\delta$  0.98-1.08 (m, 1H), 1.22-1.47 (m, 2H), 1.55-1.73 (m, 4H), 1.75-2.05 (m, 4H), 2.12-2.25 (m, 1H), 2.88 (dd,  $J = 16, 4$  Hz, 1H), 3.26-3.40 (m, 2H), 6.00-6.10 (m, 1H), 6.14-6.22 (m, 1H), 7.07-7.18 (m, 2H), 7.21-7.35 (m, 3H).

**$^{13}\text{C NMR}$  (50 MHz)** :  $\delta$  19.7, 25.3, 26.7, 33.9, 42.2, 48.3, 48.9, 52.0, 91.5, 127.9, 128.8, 129.5, 136.4, 139.2, 169.8, 208.8

**MS  $m/z$**  : 322 ( $\text{M}^+$ , 5%) : 256, 212, 165, 148, 139, 130, 120, 91.

**Analysis** :  $\text{C}_{16}\text{H}_{16}\text{O}_3$  (322.39) requires C, 78.23 ; H, 6.88. Found. C, 78.31 ; H, 6.78.

**Spectral data of 70**

**Yield** : 92%

$[\alpha]_{25}^D$  : +22.4 ( $c = 0.98$ ,  $\text{CHCl}_3$ )

**IR (neat,  $\text{cm}^{-1}$ )** :  $\nu_{\text{max}}$  1744, 1699, 1432, 1122

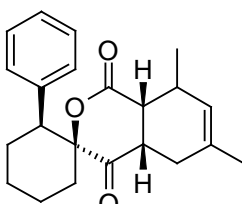

**70**

**$^1\text{H NMR}$  (200 MHz)** :  $\delta$  1.16 (d,  $J = 8$  Hz, 3H), 1.32-1.46 (m, 4H), 1.71-1.73 (m, 5H), 1.92 (t,  $J = 6$  Hz, 2H), 2.20 (d,  $J = 7.2$  Hz, 2H), 2.69-2.76 (m, 2H), 3.14 (t,  $J = 7.2$  Hz, 1H), 3.53 (t,  $J = 10$  Hz, 1H), 5.37 (d,  $J = 6$  Hz, 1H), 7.08-7.18 (m, 5H)

**$^{13}\text{C NMR}$  (50 MHz)** : 17.3, 18.7, 24.5, 25.2, 32.2, 36.8, 42.2, 47.8, 98.3, 124.3, 125.6, 128.2, 141.3, 144.4, 176.0, 214.4

**MS  $m/z$  338 ( $\text{M}^+$ )** : 338, 312, 286, 268, 240, 202, 185, 175, 158, 143, 130, 117, 104, 91,

77, 65

**Analysis** :  $\text{C}_{22}\text{H}_{26}\text{O}_3$  (338.19) requires C, 78.07 ; H, 7.74. Found. C, 78.06 ; H, 7.72.

**Spectral data of 71**

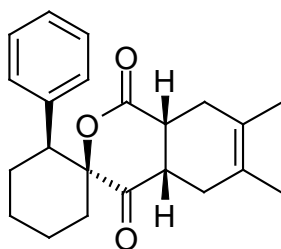

**71**

**Yield** : 94%

$[\alpha]_{25}^D$  : +26.2 ( $c = 0.62$ ,  $\text{CHCl}_3$ )

**IR (neat,  $\text{cm}^{-1}$ )** :  $\nu_{\text{max}}$  1722, 1622, 1332, 1144

**$^1\text{H NMR}$  (200 MHz)** :  $\delta$  1.44-1.46 (m, 4H), 1.71-1.73 (m, 8H), 1.92 (t,  $J = 6$  Hz, 2H), 2.20-2.31 (m, 4H), 2.70 (t,  $J = 8$  Hz, 1H), 3.14 (t,  $J = 8$  Hz, 1H), 3.53 (t,  $J = 10$  Hz, 1H), 7.08-7.08 (m, 5H).

$^{13}\text{C}$  NMR (50 MHz) : 16.3, 24.5, 25.2, 26.1, 31.4, 32.4, 36.8, 45.0, 98.3, 125.6, 126.2, 128.4, 133.7, 144.8, 174.5, 214.4

MS  $m/z$  338 (M<sup>+</sup>) : 338, 314, 286, 254, 239, 225, 202, 185, 175, 152, 130, 117, 104, 91,

71

**Analysis :** C<sub>22</sub>H<sub>26</sub>O<sub>3</sub> (338.19) requires C, 78.07 ; H, 7.74. Found. C, 78.02 ; H, 7.71.

**Cleavage of the Diels-Alder adduct**

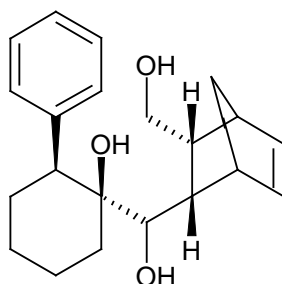

**72**

To a suspension of LAH (24 mg, 0.62 mmol) in anhydrous THF (5 mL) was added a solution of **69** (0.1 g, 0.31 mmol) in anhydrous THF (2 mL) at room temperature. The reaction mixture was refluxed for 3 h and subsequently quenched with ethyl acetate followed by dropwise addition of water. The upper liquid layer was decanted and the separated solid was removed. The organic layer was separated and the aqueous layer was extracted repeatedly with ether (3x5 mL). The combined extracts were washed with brine and dried over anhydrous Na<sub>2</sub>SO<sub>4</sub>. Concentration on rotavapour and column chromatography on silica gel using pet.ether:ethyl acetate ( 8:2 ) as eluent gave **72** (71 mg) as a colorless liquid.

**Yield :** 65%

$[\alpha]_{\text{D}}^{25}$  : -23.3 ( $c=1.0$ , CHCl<sub>3</sub>)

**IR (CHCl<sub>3</sub>, cm<sup>-1</sup>) :**  $\nu_{\text{max}}$  3390, 2900, 2870, 1251, 1085, 1045, 995

**$^1\text{H}$  NMR (CDCl<sub>3</sub>, 200 MHz) :**  $\delta$  1.32-1.36 (m, 2H), 1.41-1.45 (m, 4H), 1.55 (d,  $J = 8$  Hz, 2H), 1.62-1.68 (m, 4H), 1.70 (m, 2H), 1.94 (d,  $J = 6$  Hz, 1H), 2.12 (brs, 1H), 2.80

(q,  $J = 6$  Hz, 1H), 3.27 (d,  $J = 6$  Hz, 1H), 3.49-3.52 (m, 2H), 5.59 (dd,  $J = 12, 8$  Hz, 2H), 7.03-7.18 (m, 5H)

$^{13}\text{C}$  NMR ( $\text{CDCl}_3$ , 50MHz):  $\delta$  12.2, 18.2, 19.3, 25.1, 25.8, 29.9, 33.6, 35.2, 36.6, 40.5, 63.8, 77.6, 80.5, 125.3, 126.5, 128.8, 144.8

### Spectral data of lactol **73**

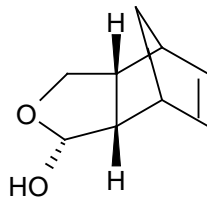

**73**

To a solution of triol **72** (0.1 g, 0.28 mmol) in dry benzene (5 mL) was added lead tetraacetate (0.24 g, 0.56 mmol) at 0 °C. The reaction mixture was stirred for an additional 15 min. The precipitate formed was filtered and the benzene solution was concentrated. Column chromatography on silica gel using petroleum ether:ethyl acetate (1:9) as eluent gave optically pure (-)-phenyl cyclohexanone **52** and lactol **73** as colorless liquid.

**Yield** : 64%

$[\alpha]_{\text{D}}^{25}$  : -23.3 ( $c = 1.0$ ,  $\text{CHCl}_3$ )

**IR** ( $\text{CHCl}_3$ ,  $\text{cm}^{-1}$ ) :  $\nu_{\text{max}}$  3390, 2900, 2870, 1251, 1085, 1045, 995

$^1\text{H}$  NMR ( $\text{CDCl}_3$ , 200 MHz) :  $\delta$  1.30-1.45 (m, 2H), 2.80-3.02 (m, 4H), 3.40 (dd,  $J = 8, 4$  Hz, 2H), 3.90-4.00 (m, 1H), 4.95 (s, 1H), 6.02-6.09 (m, 1H), 6.14-6.20 (m, 1H)

$^{13}\text{C}$  NMR ( $\text{CDCl}_3$ , 50MHz):  $\delta$  43.7, 136.3, 135.5, 88.2, 65.1, 55.4, 46.9, 44.3, 44.2, 43.7

**MS**  $m/z$  : 152 ( $\text{M}^+$ , 2%) : 135, 122, 105, 91, 66.



## 1.10 Spectra

1.  $^1\text{H}$  &  $^{13}\text{C}$  NMR spectra of 47
2.  $^1\text{H}$  &  $^{13}\text{C}$  NMR spectra of 51
3.  $^1\text{H}$  &  $^{13}\text{C}$  NMR spectra of 52
4.  $^1\text{H}$  &  $^{13}\text{C}$  NMR spectra of 53
5.  $^1\text{H}$  &  $^{13}\text{C}$  NMR spectra of 42
6.  $^1\text{H}$  &  $^{13}\text{C}$  NMR spectra of 69
7.  $^1\text{H}$  &  $^{13}\text{C}$  NMR spectra of 73

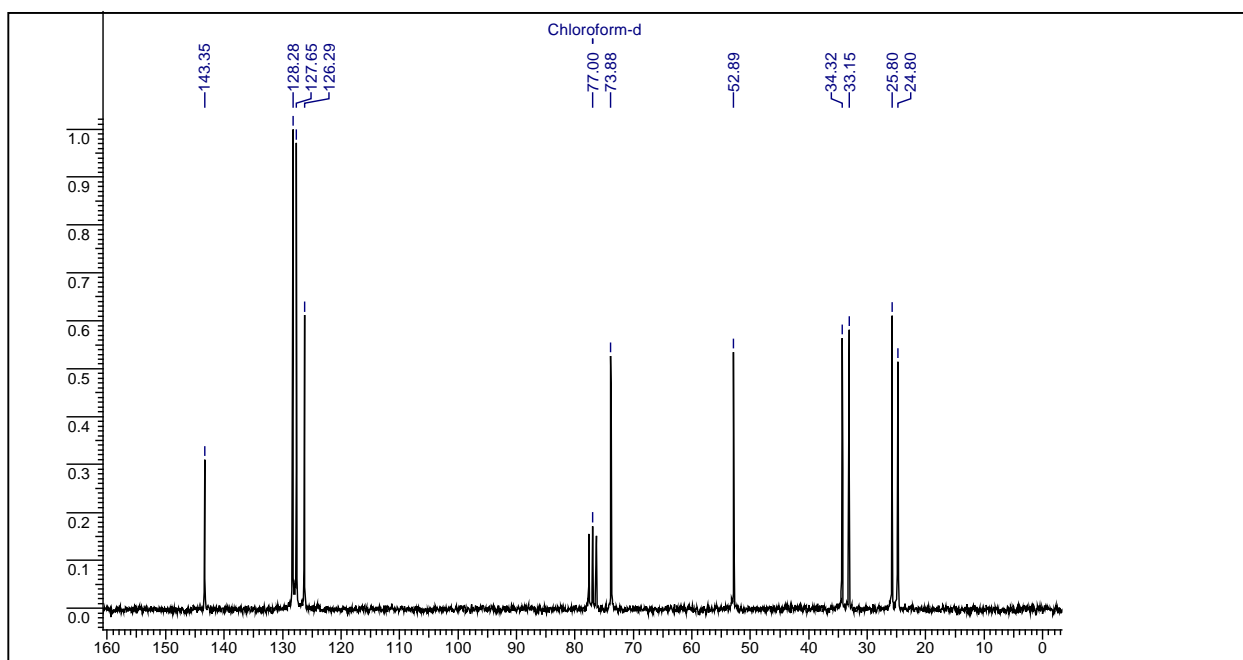
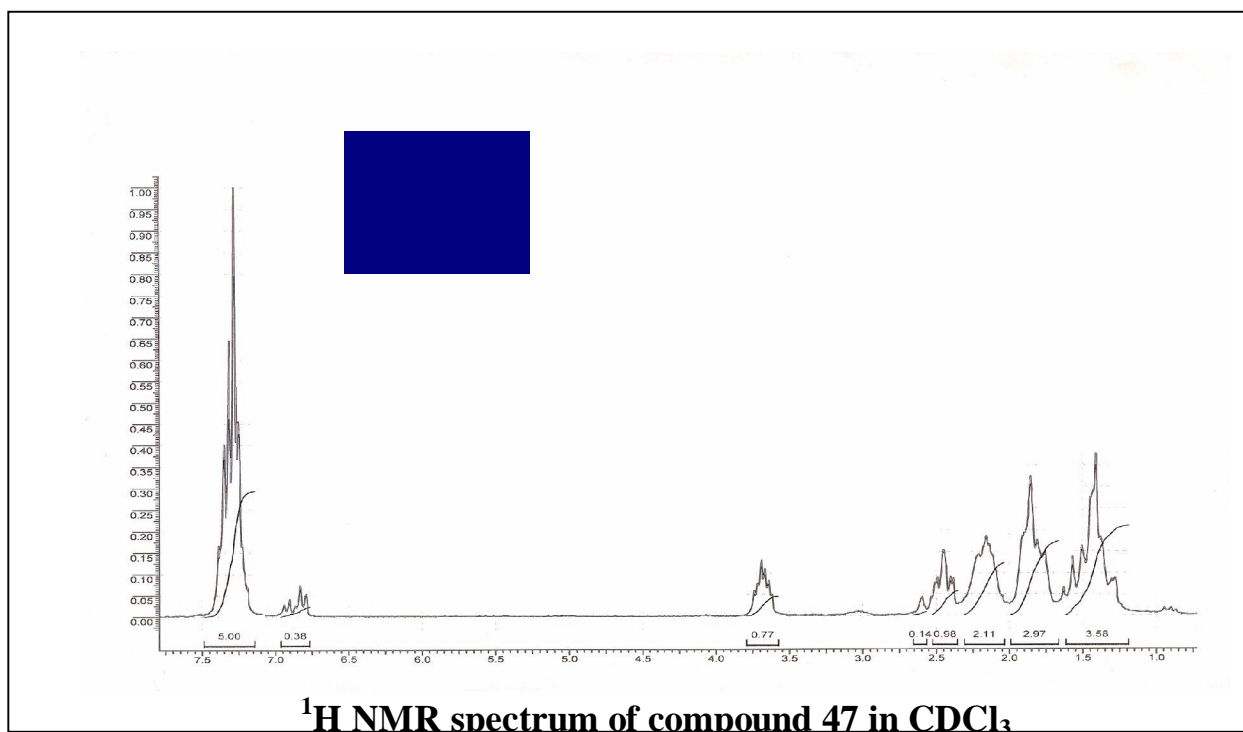

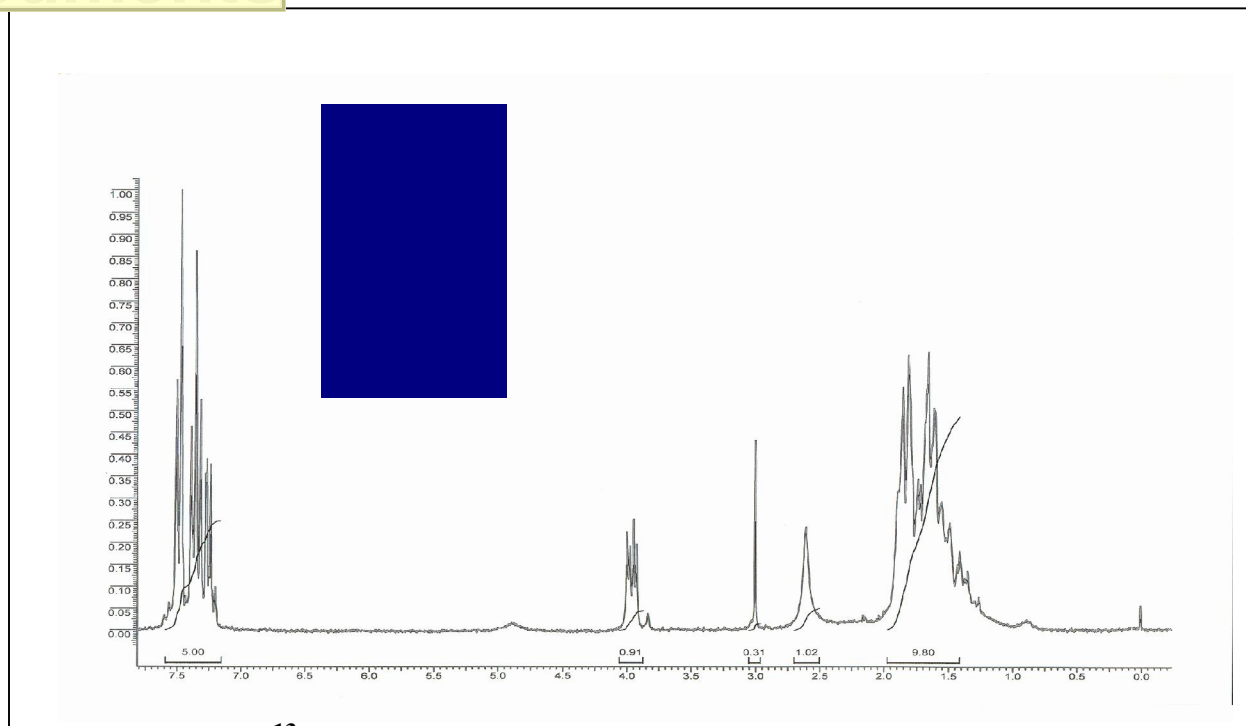

$^{13}\text{C}$  NMR spectrum of compound 47 in  $\text{CDCl}_3$

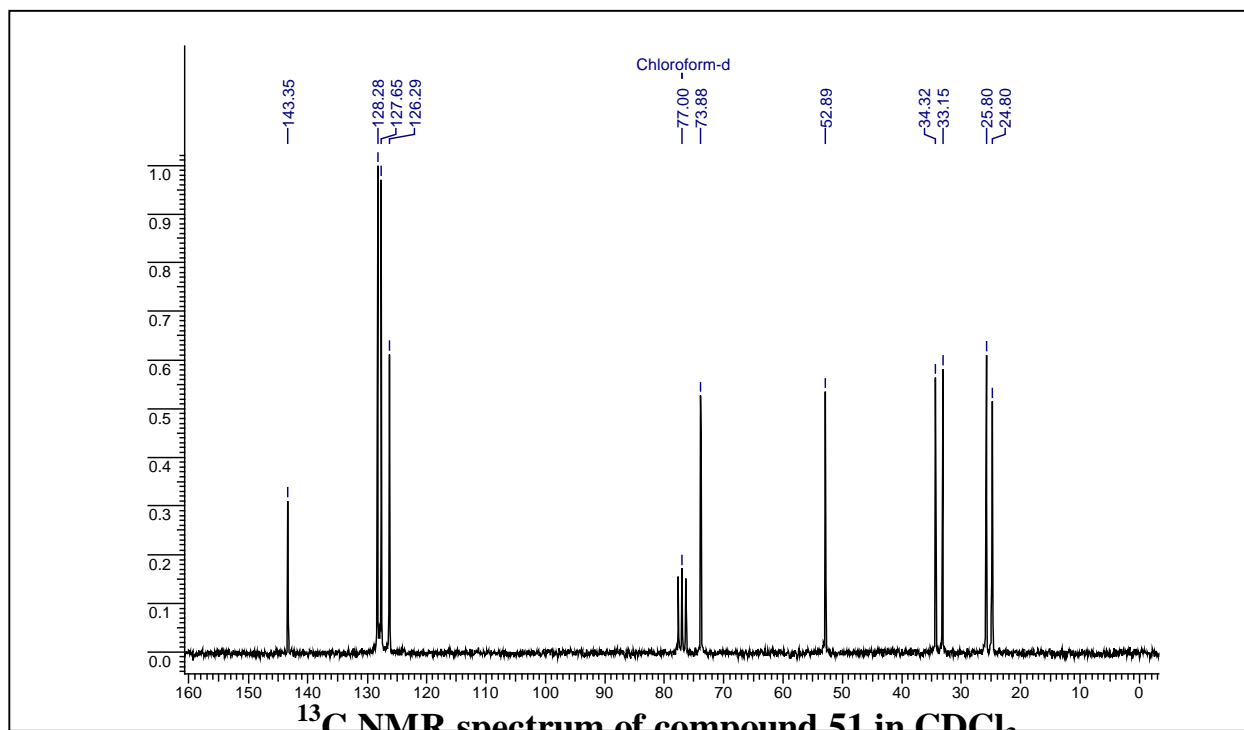

$^{13}\text{C}$  NMR spectrum of compound 51 in  $\text{CDCl}_3$

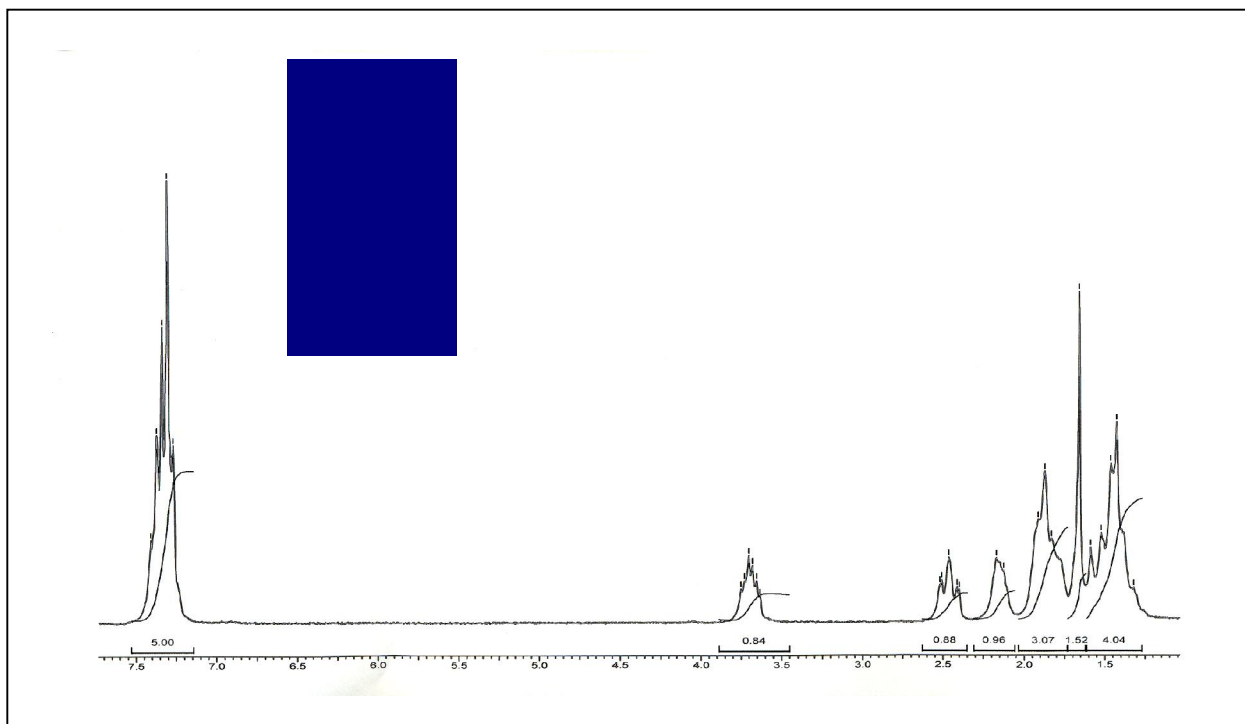

$^1\text{H}$  NMR spectrum of compound 52 in  $\text{CDCl}_3$

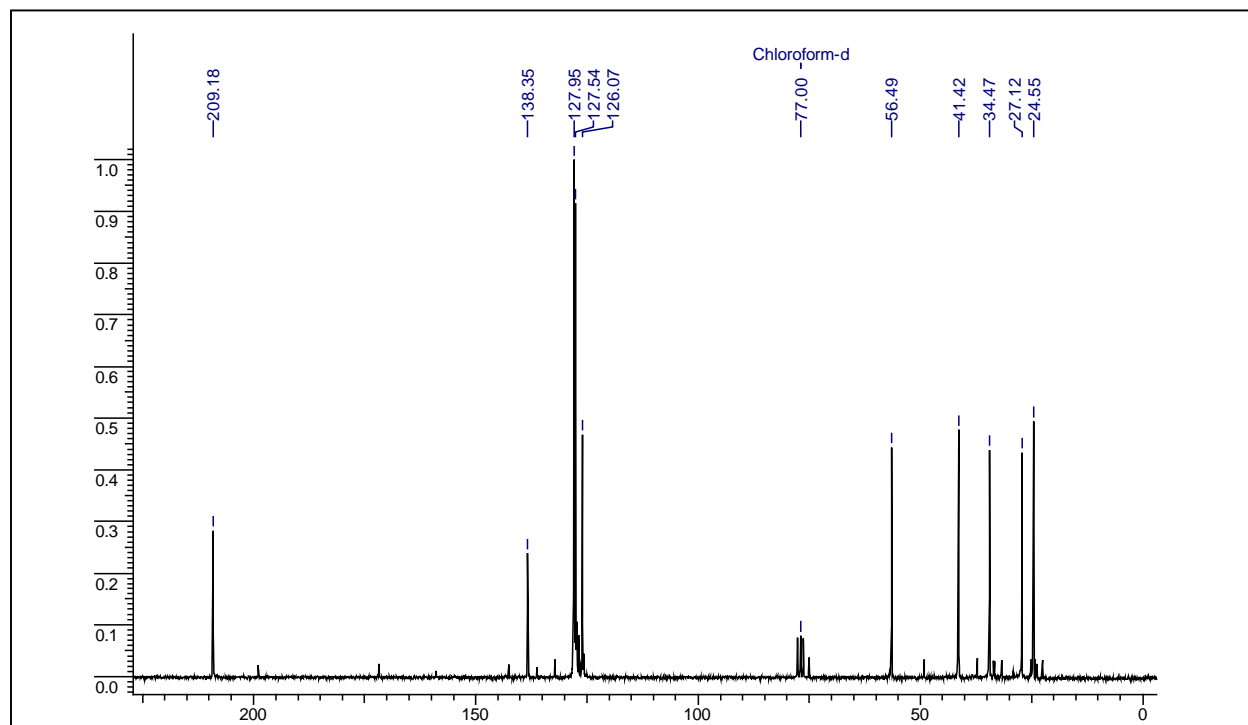

$^{13}\text{C}$  NMR spectrum of compound 52 in  $\text{CDCl}_3$

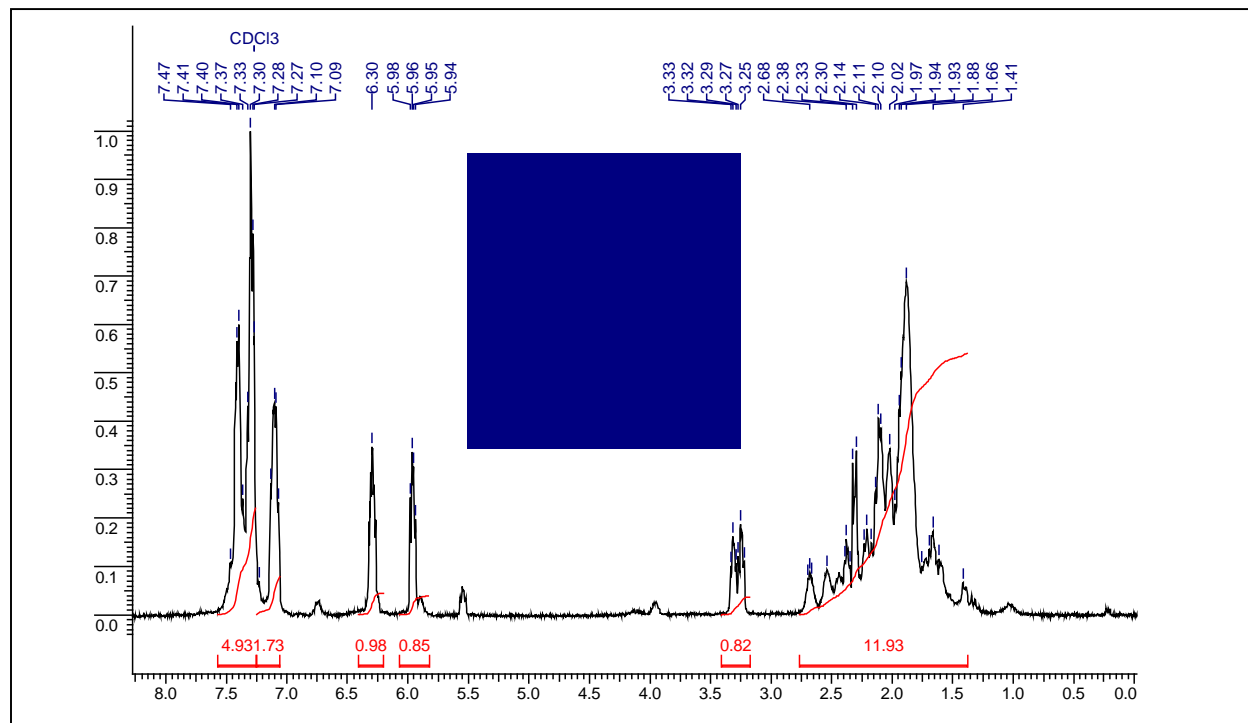

**<sup>1</sup>H NMR spectrum of compound 53 in CDCl<sub>3</sub>**

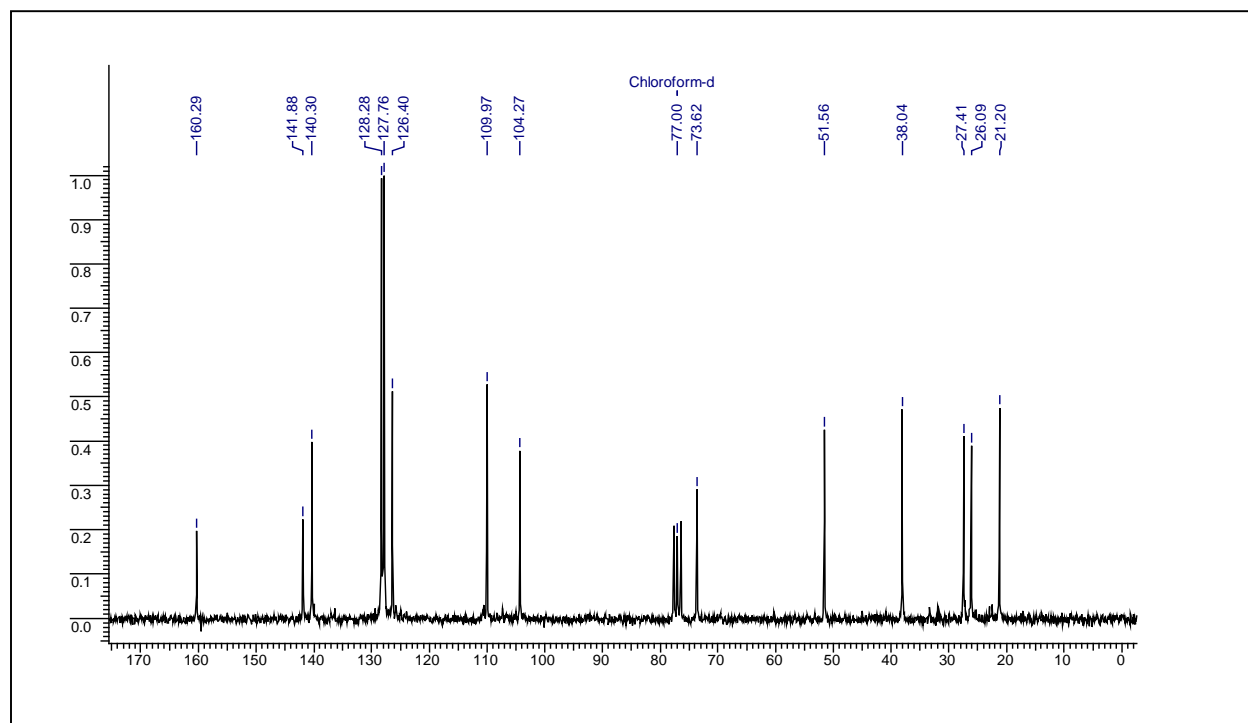

**<sup>13</sup>C NMR spectrum of compound 53 in CDCl<sub>3</sub>**

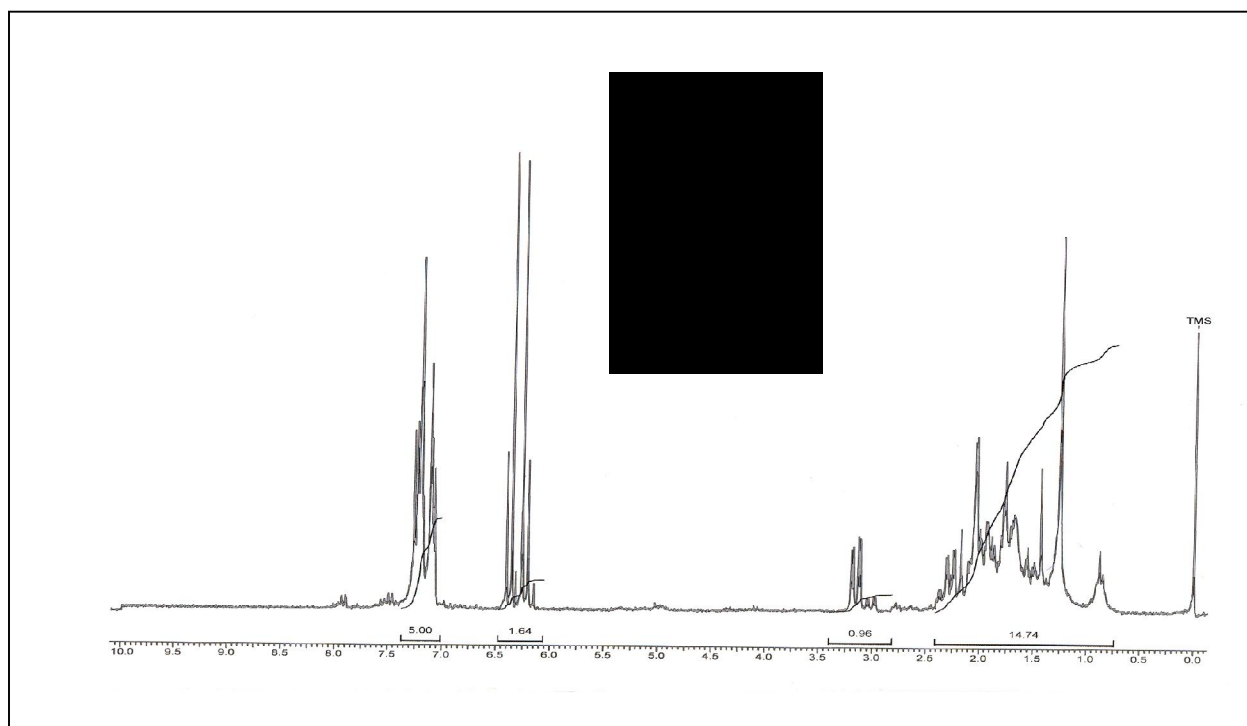

$^1\text{H}$  NMR spectrum of compound 42 in  $\text{CDCl}_3$

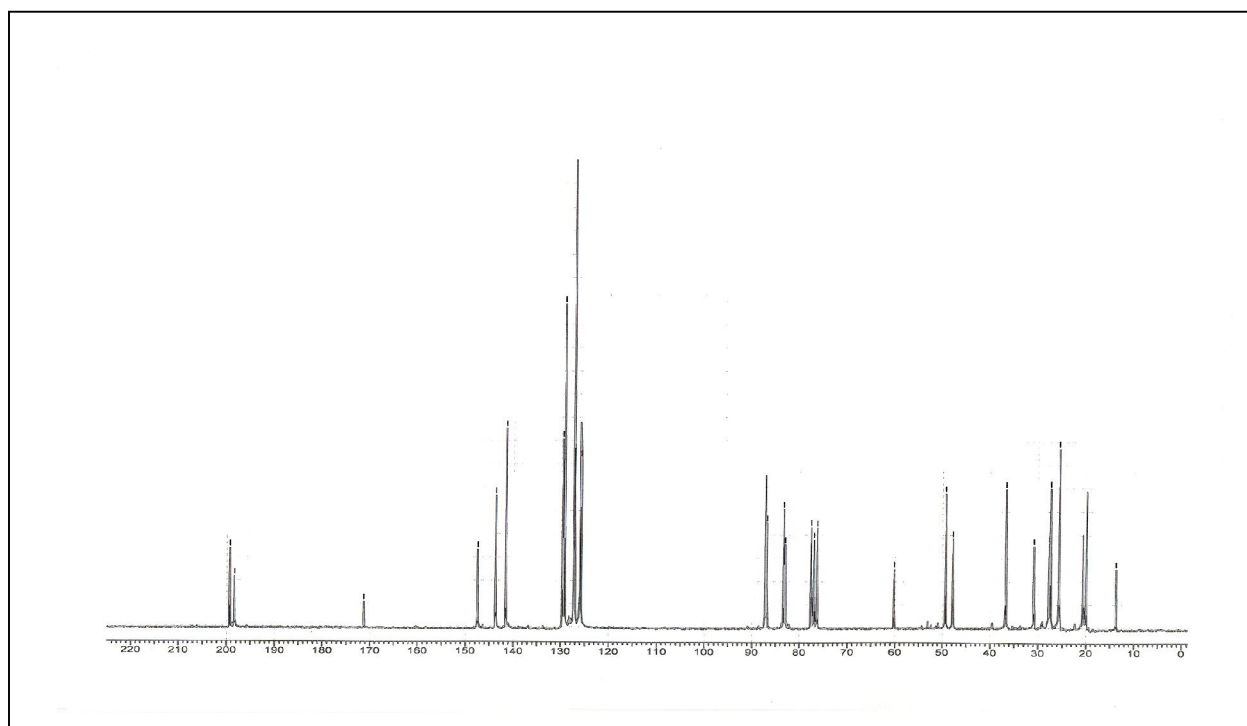

$^{13}\text{C}$  NMR spectrum of compound 42 in  $\text{CDCl}_3$

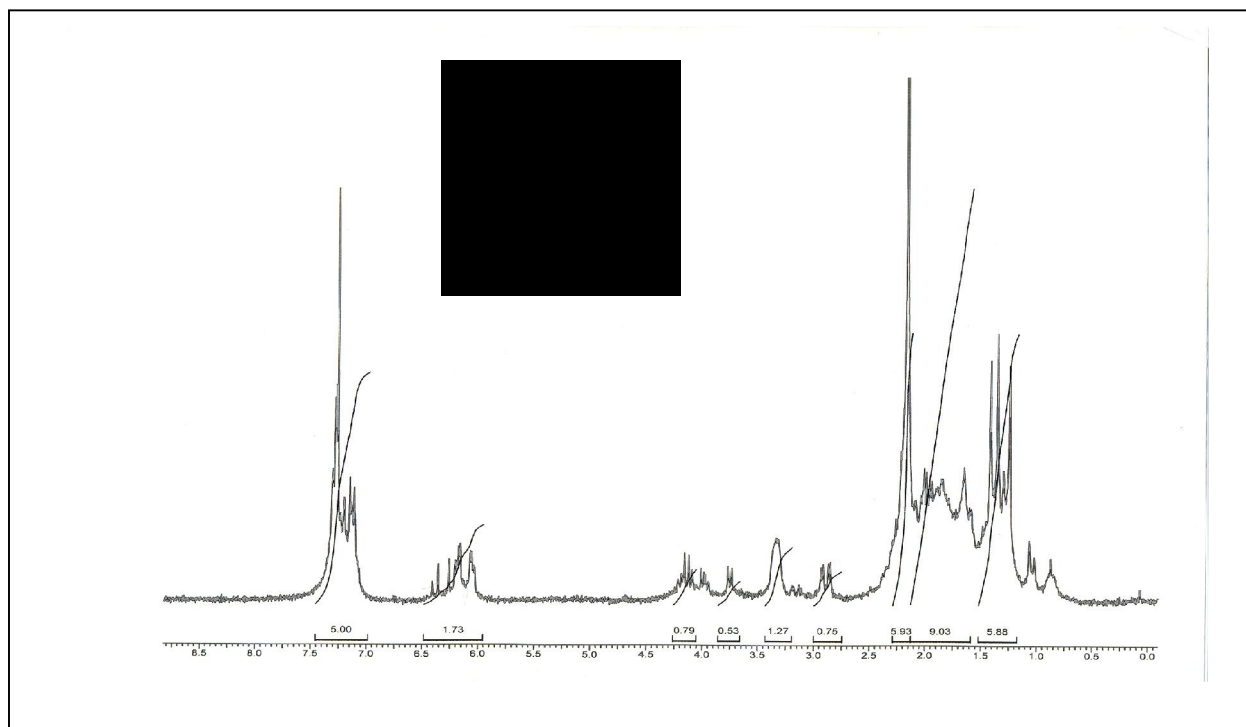

**$^1\text{H}$  NMR spectrum of compound 69 in  $\text{CDCl}_3$**

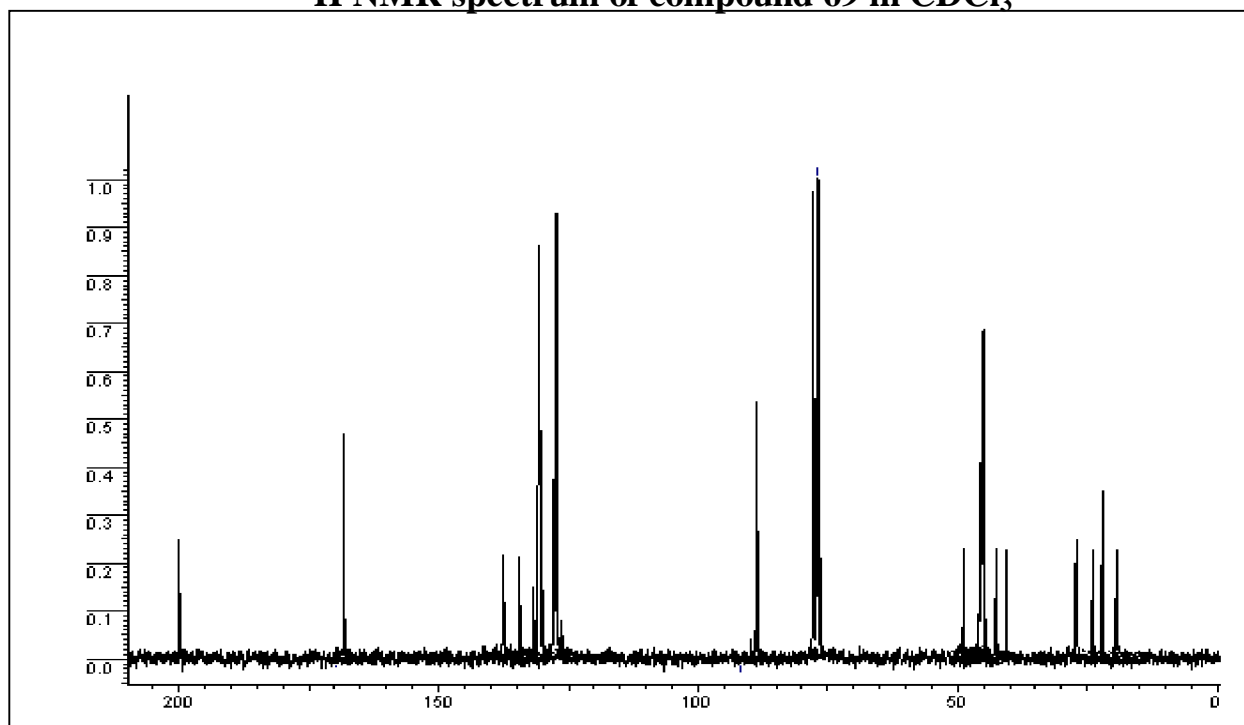

**$^{13}\text{C}$  NMR spectrum of compound 69 in  $\text{CDCl}_3$**

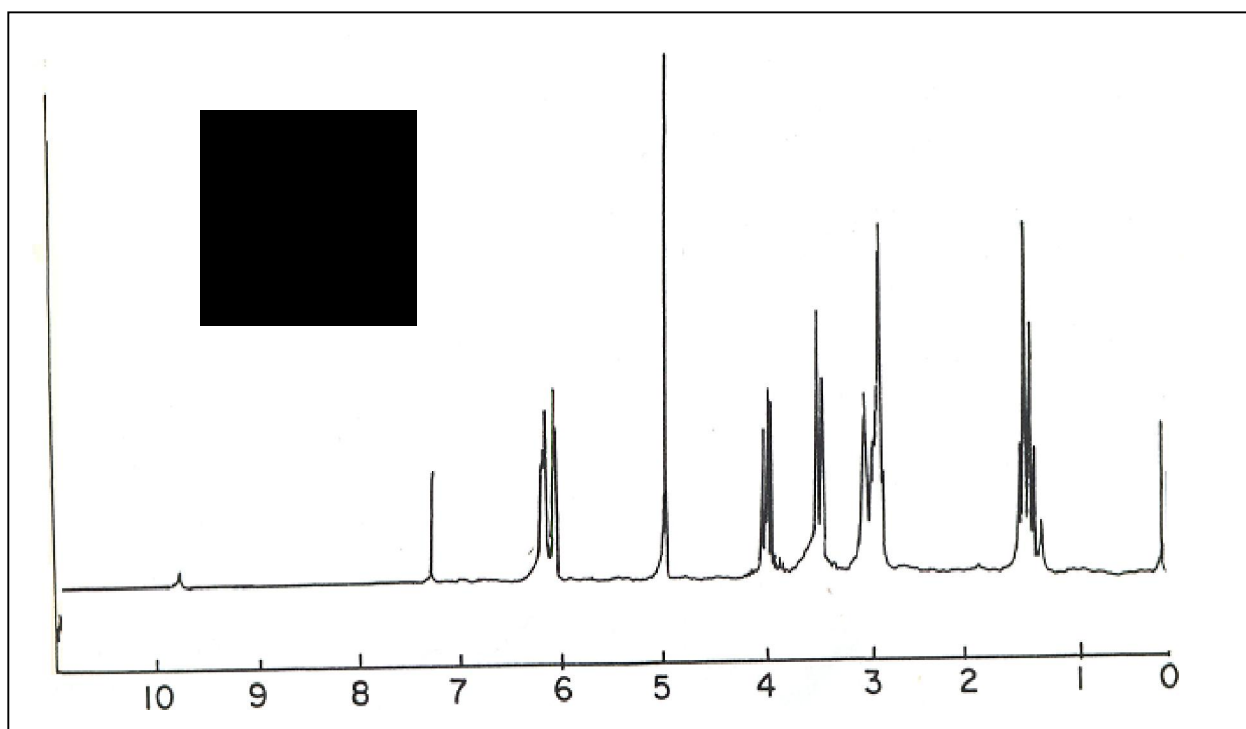

**$^1\text{H}$  NMR spectrum of compound 73 in  $\text{CDCl}_3$**

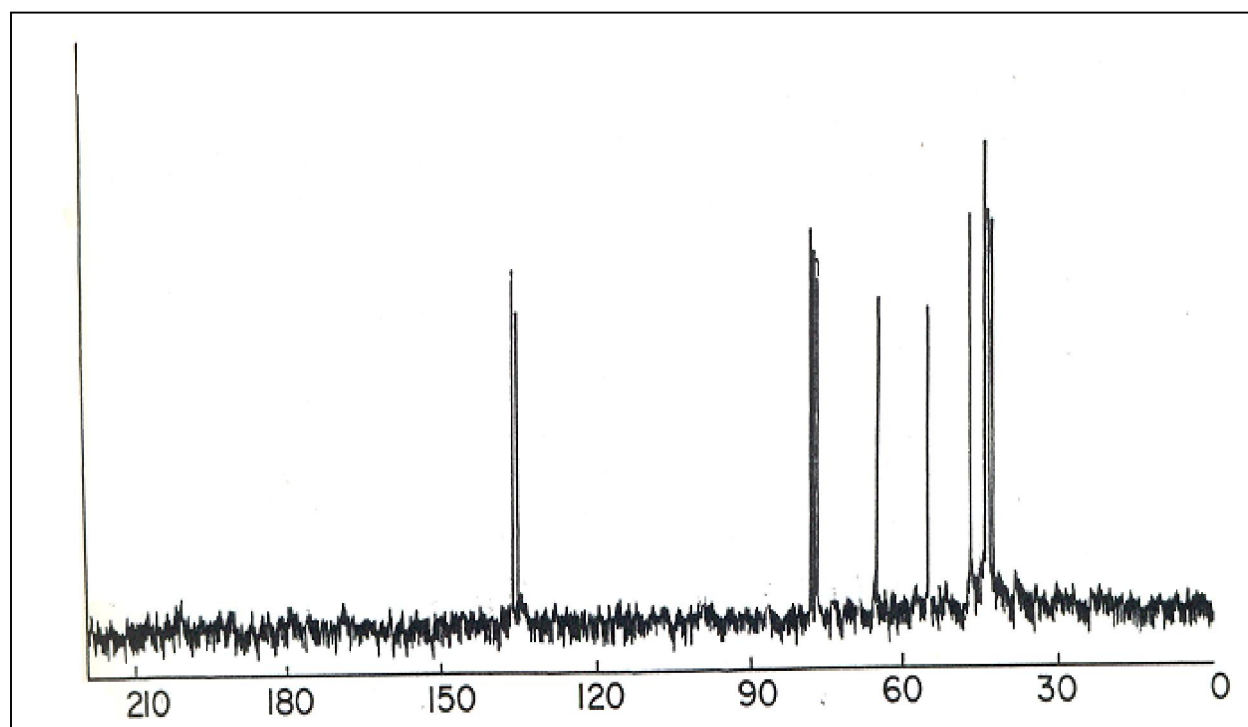

**$^{13}\text{C}$  NMR spectrum of compound 73 in  $\text{CDCl}_3$**

### 1.11 References

1. Cram, D. J.; Elhafez, F. A. A. *J. Am. Chem. Soc.* **1952**, *74*, 5828.
2. Deslongchamps, P.; Moreau, C.; Frehel, D.; Malval, A.; Moreau, C. *Can. J. Chem* 1974, **53**, 3651.
3. Fukui, K. *Theory of Orientation and Stereoselection*, Springer Verlag, Heidelberg 1979.
4. Fujimoto, H.; Fukui, K. *Tetrahedron Lett.* 1966, 5551.
5. Fukui, K.; Inagaki, S. *Chem Lett.* 1974, 509
6. Inagaki, S.; Fujimoto, H.; Fukui, K. *J. Am. Chem. Soc.* 1976, **98**, 4504.
7. Anh, N. T.; Eisenstein, O.; Lefour, J-M.; Tran Huudan, M-E. *J. Am. Chem. Soc.* 1973, **95**, 6146.



8. (a) Brown, H. C.; Hammar, W. J.; Kawakami, J. H.; Royhberg, I.; Jagt, D. L. *V. J. Am. Chem. Soc.* 1967, *89*, 6381 ; (b) Brown, H. C.; Kawakami, J. H.; Liu, K-Y. *J. Am. Chem. Soc.* 1973, *95*, 2209.
9. (a) Korat, M.; Tatarsky, D.; Ginsburg, D. *Tetrahedron* 1972, *28*, 2315 ; (b) Amith, C.; Gindburg, D. *Tetrahedron* 1974, *30*, 3415 ; (c) Kalo, J.; Ginsburg, D.; Vogel, E. *Tetrahedron* 1977, *33*, 1177.
10. (a) Kahn, S. D.; Pau, C. F.; Overmann, L. E.; Hehre, W. J. *J. Am. Chem. Soc.* 1986, *108*, 7381 ; (b) Kahn, S. D.; Hehre, W. J. *J. Am. Chem. Soc.* 1987, *109*, 663.
11. Muller, K.; Brown, L. D. *Helv. Chim. Acta.* 1978, *61*, 1407.
12. Brown, K. L. damm, L.; Dunitz, J. D.; Eschenmoser, A.; Hobi, R.; Kratky, C. *Helv. Chim. Acta.* 1978, *61*, 3108.
13. Royer, J. *Tetrahedron Lett.* 1978, 1343.
14. Wipff, G.; Morokuma, K. *Tetrahedron Lett.* 1980, 4445.
15. Cieplak, ; A. S. *J. Am. Chem. Soc.* 1981, *103*, 4540.
16. Deslongchamps, P. *Tetrahedron* 1975, *31*, 2463.
17. Cheung, C. K.; Tseng, L. T.; Lin, M-H.; Srivastava, S.; le Noble, W. J. *J. Am. Chem. Soc.* 1986, *108*, 1598.
18. Gleiter, R.; Paquette, L. A. *Acc. Chem. Res.* 1983, *16*, 328.
19. Ruiz-Lopez, M. F.; assfeld, X.; Garcia, J. I.; Mayoral, J. A.; Salvatella, L. *J. Am. Chem. Soc.* 1993, *115*, 8780.

20. (a) Houk, K. N.; Paddon, M. N.; Rondan, N. G.; Wu, Y-N.; Brown, F. K.; Spellmeyer, D. C.; Metz, J. T.; Li, Y.; Loncharich, R. J. *Science* 1986, **231**, 1108 ; (b) Brown, F. K.; Houk, K. N. *J. Am. Chem. Soc.* 1987, **109**, 908.
21. Seebach, D.; Zimmermann, J.; Gysel, U.; Ziegler, R.; Ha, T-K. *J. Am. Chem. Soc.* 1988, **110**, 4763.
22. Demuth, M.; Palomer, A.; Sluma, H-D.; Dey, A. K.; Kruger, C.; Tsay, Y-H. *Angew. Chem. Int. Ed. Engl.*, 1986, **25**, 1117.
23. Whitesell, J. K.; Bhattacharya, A.; Henke, K. *J. Chem. Soc., Chem. Commun.* 1982, **988**.
24. Oppolzer, W.; Chapuis, C.; Bernardinelli, G. *Helv. Chim. Acta.* 1984, **67**, 1397.
25. Enders, D. in *Asymmetric Synthesis*, Ed. Morrison, J. D. Academic Press **1984**, **3**, 275.
26. Meyers, A. I.; Wallace, R. H. *J. Org. Chem.* **1989**, **106**, 2506.
27. Evans, D. A.; Champmann, K. T.; Bisaha, J. *J. Am. Chem. Soc.* **1984**, **106**, 4261.
28. Subba Rao, K. V.; Vedavati, G. P.; Kumar, P. *Tetrahedron Lett.* **2003**, **44**, 5015.
29. Adachi, K.; Kobayashi, S.; Ohno, M. *Chimia* **1986**, **40**, 311.
30. (a) Becker, H.; Sharpless, K. B. *Angew. Chem., Int. Ed. Engl.* **1996**, **35**, 448; (b) Torri, S.; Liu, P.; Bhuvanewari, N.; Amatore, C.; Jutand, A. *J. Org. Chem.* **1996**, **61**, 3055; (c) For a review on asymmetric dihydroxylation, see: Kolb, H. C.; VanNieuwenhze, M. S.; Sharpless, K. B. *Chem. Rev.* **1994**, **94**, 2483.
31. King, S. B.; Sharpless, K. B. *Tetrahedron Lett.* **1994**, **35**, 5611.
32. Georgiadis, M. P.; Tsekouras, A.; Kotretsou, S. I.; Horoutounian, S. A.; Polissiou, M. G. *Synthesis* **1999**, 929.
33. Oppolzer, W.; Chapuis, C.; Bernardinelli, G. *Helv. Chim. Acta.* **1984**, **67**, 1397.
34. Walborsky, H. M.; Barash, L.; Davis, T. C. *Tetrahedron* **1963**, **19**, 2333.
35. Sauer, J.; Kredel, J. *Tetrahedron Lett.* **1966**, 6359.
36. Corey, E. J.; Ensley, H. E. *J. Am. Chem. Soc.* **1975**, **97**, 6908.
37. Seebach, D.; Zimmermann, D. J. *Helv. Chim. Acta* **1986**, **69**, 1147; (b) Gautschi, M.; Seebach, D. *Angew. Chem., Int. Ed. Engl.* **1992**, **31**, 1083; (c) Demuth, M.; Palomer, A.; Sluma, H. D.; Dey, A.K.; Kruger, C.; Tsay, Y. H. *Angew. Chem., Int. Ed. Engl.* **1986**, **25**, 1117.
38. Seebach, D.; Zimmermann, J.; Gysel, U.; Ziegler, R.; Ha, T-K. *J. Am. Chem. Soc.* **1988**, **110**, 4763.
39. Whitesell J. K.; Lawrence, R. M. *Chimia* **1986**, **40**, 318.

## 2.1 SECTION A: ASYMMETRIC EPOXIDATION (AE)

---

### 2.1.1 Introduction

Asymmetric synthesis of optically pure organic compounds is a challenging task for organic chemists. Nature provides thousands of enantiomerically pure compounds, but quite a few of them are either not easily isolated or not available in useful amounts. However it is more elegant and more economical to prepare just the wanted enantiomer by asymmetric synthesis. Epoxides are versatile and important intermediates in organic chemistry. The strain of three membered heterocyclic ring makes them accessible to a large variety of reagents. Sharpless and Katsuki discovered a system for the asymmetric epoxidation of primary and secondary allylic alcohols that utilizes titanium tetrakisopropoxide, a dialkyl tartrate as a chiral ligand, and *tert*-butyl hydroperoxide as the oxidant.<sup>1</sup> Notably, this reaction exhibits high levels of enantioselectivity. Like other metal catalyzed epoxidations, this reaction also proceeds under mild conditions with good chemical yield and with high regio- and chemoselectivity.

### 2.1.2 Asymmetric epoxidation with the titanium (IV) tartrate catalyst

The combination of  $\text{Ti}(\text{OPr}^i)_4$ , a dialkyl tartrate, and *tert*-butyl hydroperoxide epoxidizes most allylic alcohols in good chemical yield and with predictably high enantiofacial selectivity according to the empirical rule illustrated in Scheme 1. When an allylic alcohol ( $\text{R}^4, \text{R}^5 = \text{H}$ ) is drawn in a plane with the hydroxymethyl group positioned at the lower right, the delivery of oxygen occurs from the bottom side of the olefin to give the (*2S*)-epoxide if an (*R,R*)-dialkyl tartrate is used as the chiral auxiliary. When an (*S,S*)-dialkyl tartrate is employed, oxygen is delivered from the top side. The enantiofacial selectivity of the reaction is > 90% ee for substrate without a *Z*-olefinic substituent ( $\text{R}^3 = \text{H}$ ). The degree of facial selectivity for a *Z*-allylic alcohol depends on the nature of the *Z* substituent  $\text{R}^3$ . The enantioselectivity for substrate with unbranched  $\text{R}^3$  substituents ranges from 80 to 94% ee, but that for substrates with branched substituent is lower.<sup>2</sup>

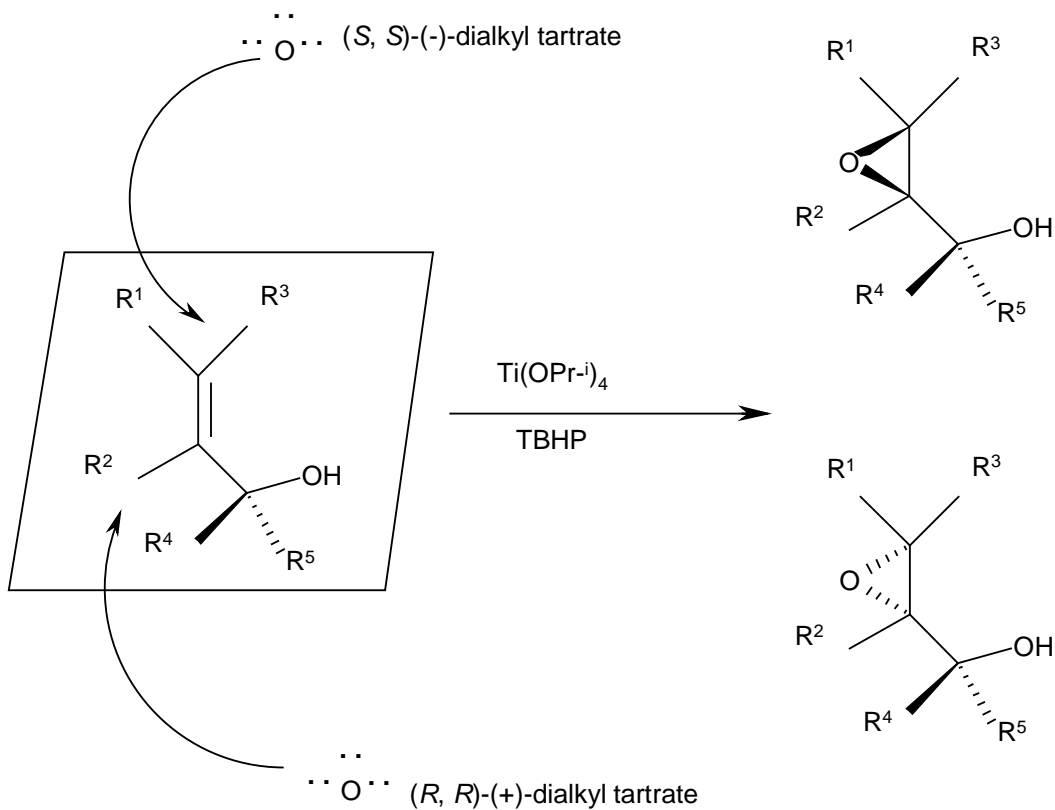

**Scheme 1**

### 2.1.3 Mechanism

The reaction sequence proposed for the metal-catalyzed epoxidation of allylic alcohols is shown in **Scheme 3**.<sup>7</sup> Metal alkoxides generally undergo rapid ligand exchange with alcohols. When a metal alkoxide, an allylic alcohol, and an alkyl hydroperoxide are mixed, ligand exchange occurs to afford a mixture of complexes  $\text{M(OR)}_{n-x-y}\text{-(OCH}_2\text{CH=CH}_2\text{)}_x\text{(OOR)}_y$ . Among them, only species such as 'a', bearing both allylic alkoxide and alkyl hydroperoxide groups, are responsible for the epoxidation. The incorporated alkyl hydroperoxide is thought to be further activated by coordination of the

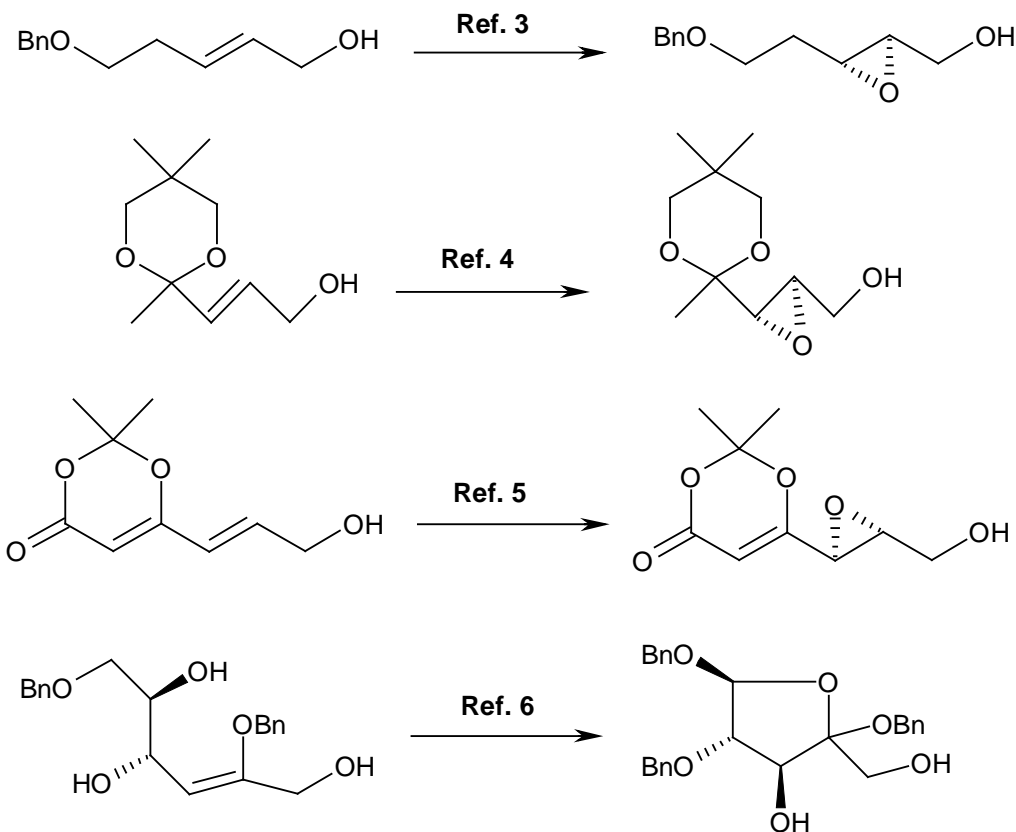

### Scheme 2 : Representative examples of epoxidations of allylic alcohols

second oxygen atom (O-2) to the metal center. The ensuing transfer of O-1 to the double bond of the allylic alcohol occurs in an intramolecular fashion is supported by comparison of the epoxidation rate of allylic alcohol with that of allyl methyl ether.<sup>8</sup> However controversy still surrounds the oxygen transfer process (b-e). One suggestion is that the double bond first coordinates to the metal center and then inserts into the  $\mu$ -2-alkyl hydroperoxide ligand to give an epoxide via the peroxometalocycle intermediate.<sup>9</sup> An alternative proposal is that the double bond attacks the distal oxygen along the axis of the O-O bond that is broken.<sup>2,7d,9</sup> Frontier molecular orbital treatment of peroxometal complexes also suggests that d-transition metal complexes of ROO<sup>-</sup> exhibit electrophilic behaviour.<sup>10</sup> Finally, exchange of *tert*-butoxide and the epoxy alkoxide so formed with allylic alcohol and alkyl hydroperoxide completes the reaction cycle.

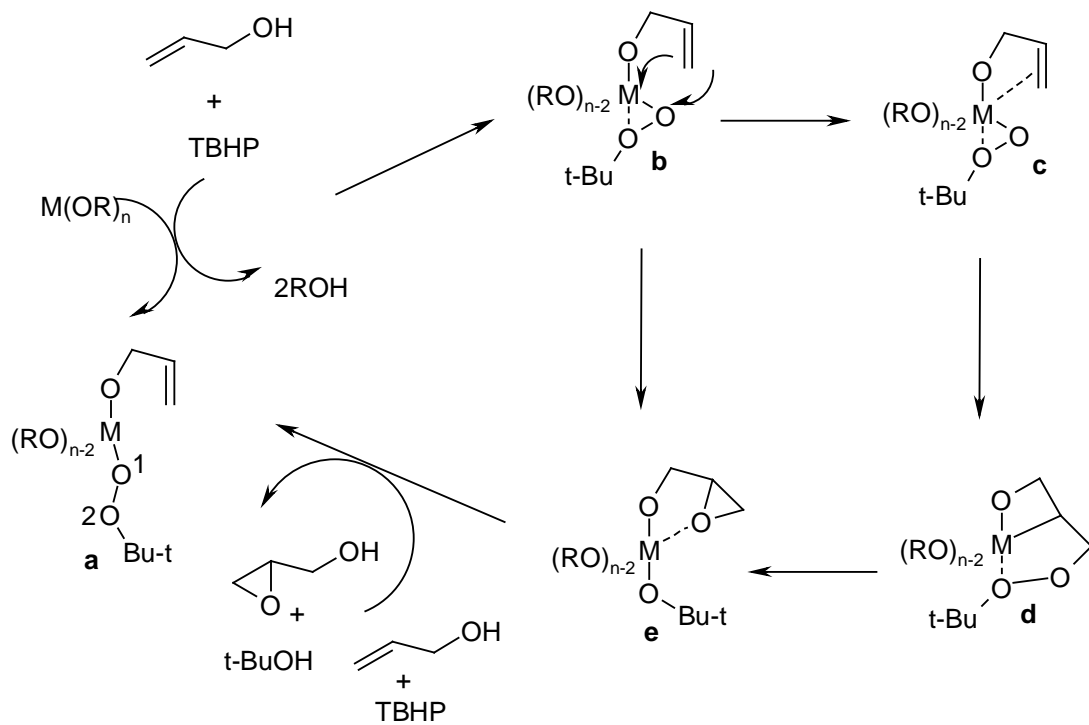

**Scheme 3**

The titanium tartrate mediated asymmetric epoxidation of allylic alcohols also follows the same basic reaction pathway of **Scheme 3**. Therefore the remaining mechanistic question is how oxygen is transferred enantioselectively to substrates. To answer this question, structures of titanium-dialkyl tartrate complexes,<sup>9,11</sup> as well as those prepared from  $Ti(OPr^i)_4$  and (*R,R*)-*N,N'* dibenzyltartramide and from  $Ti(OEt)_4$ , (*R,R*)-diethyl tartrate, and  $Ph(CO)-N(OH)Ph$  were determined.<sup>12</sup> Based on the X-ray analysis of these complexes, the structure of the asymmetric epoxidation catalyst (**Fig. 1**) has been proposed.

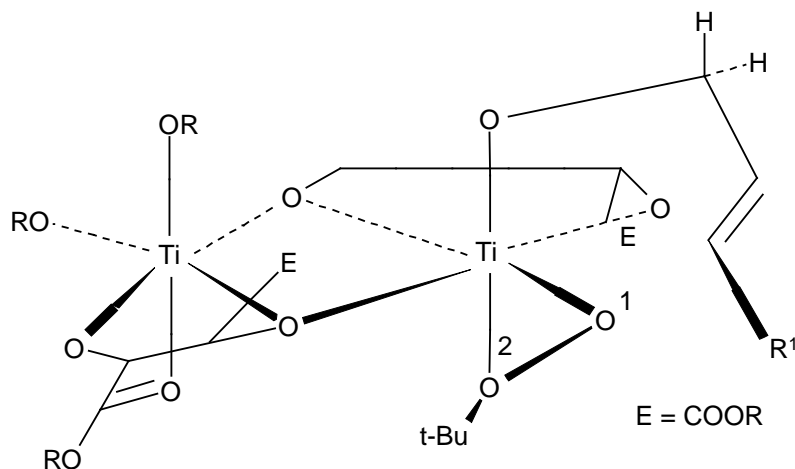

**Fig. 1**

When structure shown in **Fig. 1** is viewed down the distal peroxide oxygen-titanium bond axis ( $O^1-Ti$ ), the symmetry of the tartrate “windmill arms” becomes apparent. Within this model, conformer (**Shown in Fig 2**), in which the allylic alcohol and the TBHP-ligand align meridionally and the  $TiO-C-C=C$  dihedral angle is as small as  $30^\circ$ , has been suggested as a transition state.<sup>2</sup>

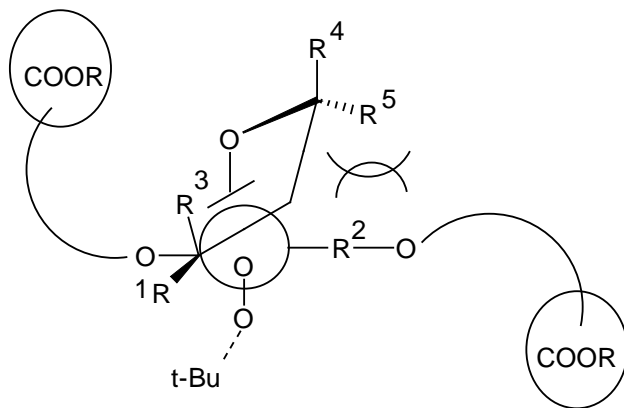

**Fig 2.**

This conformer experiences severe steric interactions only when  $R^5 \neq H$ . This explains the high efficiency of kinetic resolution of racemic secondary allylic alcohols where one enantiomer ( $R^4 = \text{alkyl}$ ,  $R^5 = H$ ) reacts much faster than the other isomer ( $R^4 = H$ ,  $R^5 = \text{alkyl}$ ). The poor reactivity of *tertiary* allylic alcohols ( $R^4$  and  $R^5 = \text{alkyl}$ ) is rationalized analogously.<sup>13</sup> We also see that the *Z* olefinic substituent ( $R^3$ ) is close to the hydroxymethyl group bound to titanium because of the small  $O-C-C=C$  dihedral angle. These interactions destabilize conformer (**Shown in Fig. 3**) and lower the reactivity of this complex. The C-2 substituent ( $R^2$ )

(Shown in Fig. 2) is also in the vicinity of the titanium complex, and only the E olefinic substituent ( $R^1$ ) projects toward an open quadrant. This model explains following three observations.

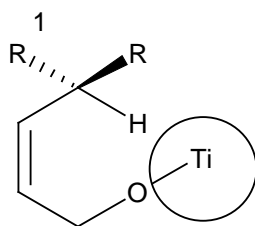

**Fig 3.**

1. Bulky Z olefinic substituents retard epoxidation reactions, and substrate with branched Z substituents exhibit poor reactivity and decreased enantioselectivity. This may be rationalized by the conformational requirements for minimization of allylic strain due to the small C=C-C-OTi dihedral angle.<sup>2</sup> That is, the conformation in which H is in the plane of the olefin is energetically more accessible than the other two conformations (R and R' in-plane conformations). Thus the disposition of an alkyl group ( $R^1$ ) to the bottom side raises the energy of the transition state depicted in Fig. 3 [using (*R,R*) tartrate], causing retardation of the reaction and decreased enantioselectivity. When  $R \neq R^1$ , each enantiomer of a racemic substrate has different reactivity and treatment of such a racemic mixture with  $Ti(OPr^i)_4$ - tartrate affects kinetic resolution.
2. The C-2 substituent is near the Ti-tartrate moiety, its chirality also affects substrate reactivity. Thus enantiomers of a racemic substrate bearing a chiral C-2 substituent have different reactivities, and in some cases a good level of kinetic resolution is observed.
3. Except for a few examples, the E substituent, which is located in an open quadrant, has little effect on the stereoselectivity of the reaction. Therefore, the epoxidation of chiral *E*-allylic alcohols should proceed with same high level of enantioselectivity seen with achiral *E*-allylic alcohols.<sup>14</sup>

Since the principal difficulties (isolation of unstable and/or water soluble epoxy alcohols) with the stoichiometric reaction are mainly attributed to the mild Lewis acidity of titanium alkoxide and the aqueous workup required for hydrolysis of the stoichiometric catalyst, Sharpless discovered that addition of molecular sieves to the reaction mixture allows epoxidation to proceed to completion in the presence of only 5-10 mol% of the  $Ti(OPr^i)_4$  and 6 mol% tartrate has been recommended as the most widely applicable system for asymmetric epoxidation.<sup>15</sup> Below the 5 mol% level, the enantioselectivity of the reaction



decreases remarkably. The amount of tartrate ester must be carefully controlled, because a large excess of tartrate (>100 % excess) decreases the reaction rate while with too little tartrate (<10 % excess).

#### 2.1.4 Kinetic Resolution of secondary allylic alcohols

**The kinetic resolution of secondary allylic alcohols was first reported in 1981,<sup>16</sup> wherein some examples were performed with as little as 13-25% catalyst and there onwards complete catalytic manner developed , key feature of this catalytic procedure is molecular sieves (zeolites).**

With cyclohexyl (*E*)-1-propenyl carbinol as the model ( $R^1 = \text{CH}_3$ ,  $R^2 = R^3 = R^4 = \text{H}$ ,  $R^5 = \text{C}_6\text{H}_{11}$  and  $R^1 = \text{CH}_3$ ,  $R^2 = R^3 = \text{H}$ ,  $R^4 = \text{C}_6\text{H}_{11}$  in **Scheme 4**), it was found that the *S* enantiomer reacts 74 times faster than the *R* enantiomer at 0 °C when (*R,R*)-(+)-diisopropyl tartrate is used as the chiral auxiliary. As in the epoxidation of primary allylic alcohols, the stereochemical course of the kinetic resolution processes has been highly predictable. When the secondary allylic alcohol is drawn so that the hydroxy group lies in the lower right corner of the plane (**Scheme 4**), the enantiomer that reacts rapidly with (*R,R*)-(+)-dialkyl tartrate is the one in which the substituent ( $R^4$ ) on C-1 is located above the plane. Epoxidation occurs from the underside to give the usual 2*S* epoxide (*erythro* selectivity, 98:2).

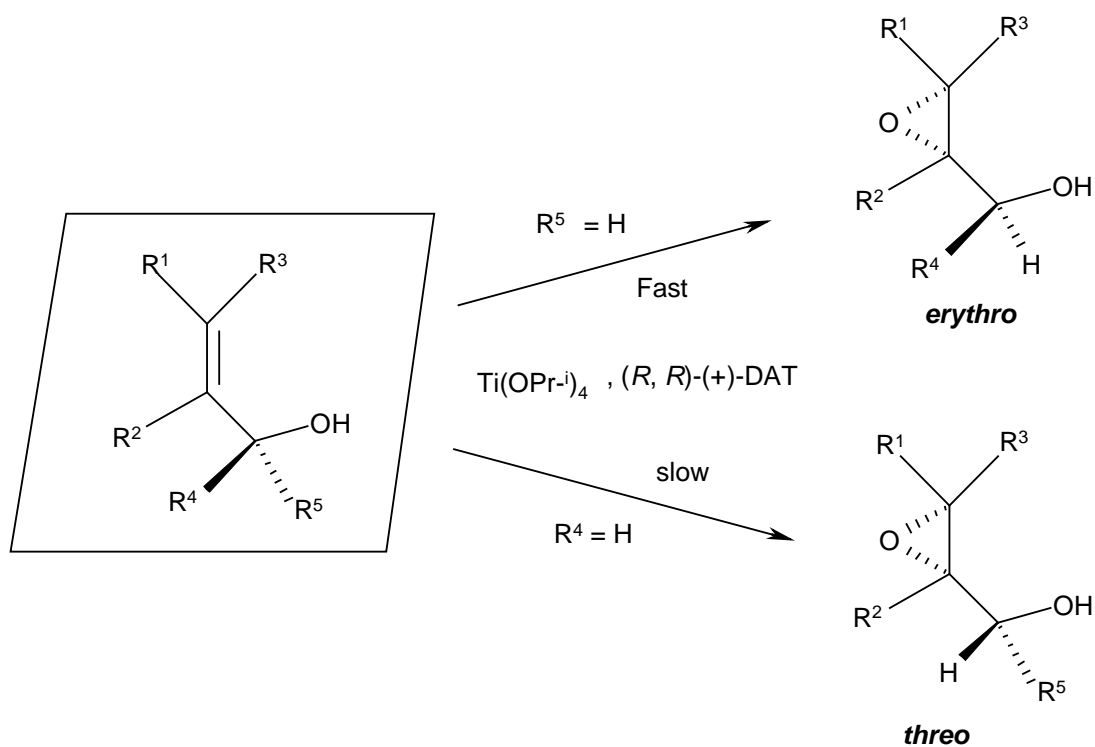

**Scheme 4**

The slow-reacting enantiomer is the one in which the C-1 substituent ( $R^5$ ) is located on the underside, interfering with the 'normal' delivery of the oxygen atom. This interference reduces the expected *threo* selectivity for the slow-reacting enantiomer (38 *erythro*:62 *threo*, **Scheme 5**).

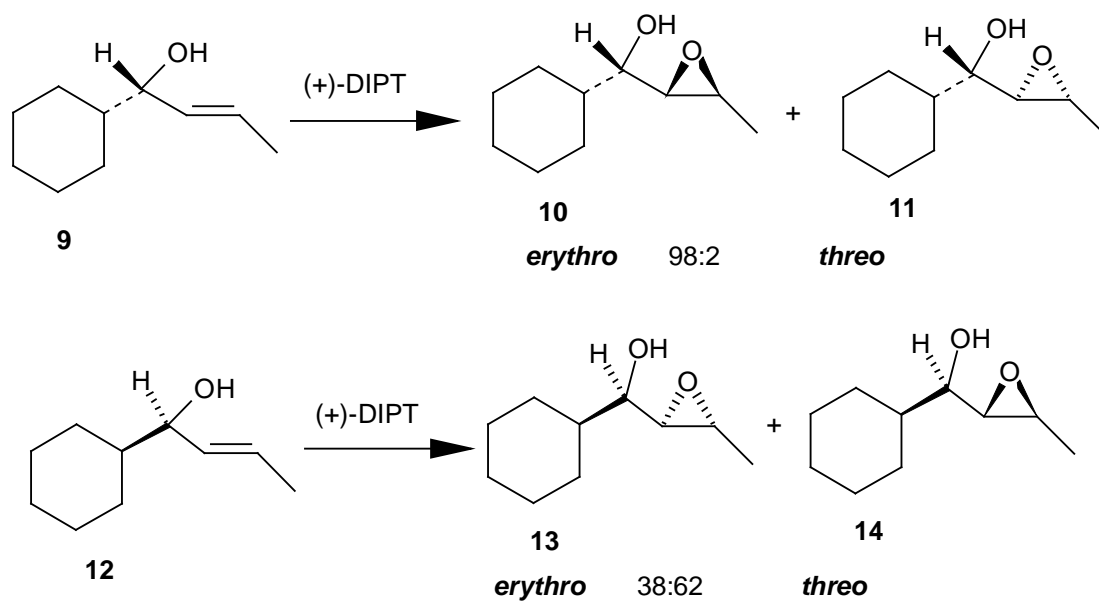

**Scheme 5**

This enantioselection rule has consistently been observed for all secondary allylic alcohols except for those bulky Z substituents and 1,2-divinylethylene glycols. Kinetic resolution is very poor for allylic alcohols with bulky Z substituents, and reversed but high enantioselectivity is observed in the kinetic resolutions of 1,2-divinylethylene glycols<sup>17</sup> (**Scheme 6**).

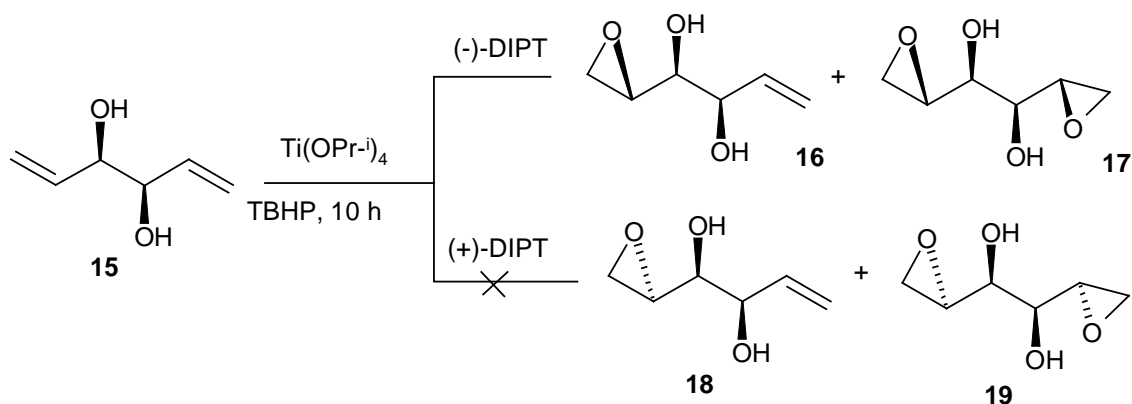

**Scheme 6**

### 2.1.5 Various synthetic manipulations of epoxide

The significant utility of the titanium mediated asymmetric epoxidation in organic synthesis is attributable to its enantioselectivity and to the numerous applications of epoxy alcohols as precursors to diversely functionalized compounds. However since epoxy alcohols have three reactive sites regio- and stereoselective reactions are essential for their use and many studies have been directed toward developing regioselective transformations of epoxy alcohols. For convenience, these reactions are classified into three categories (**Fig. 4**).

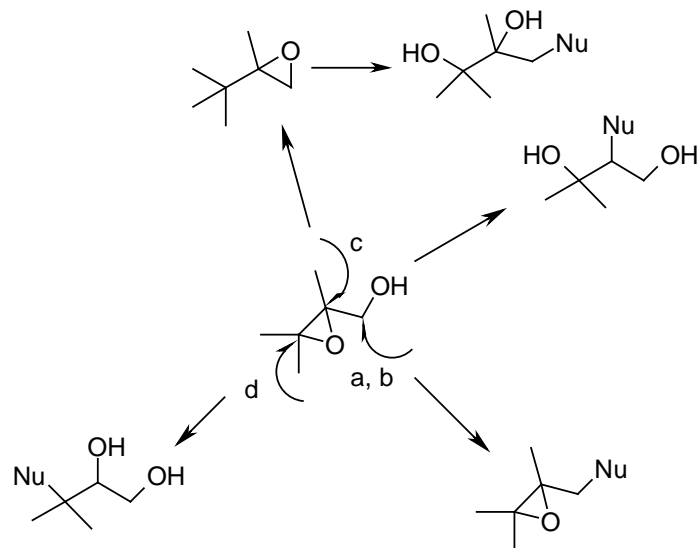
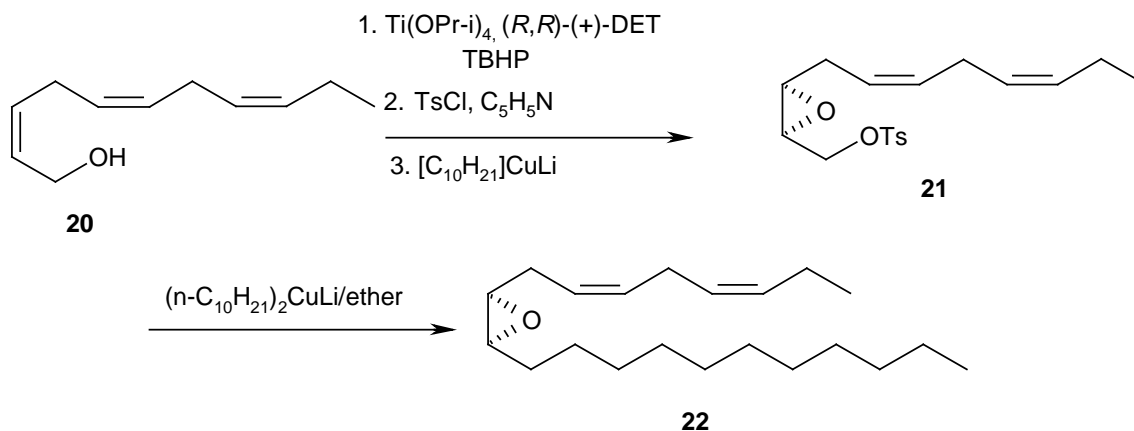

Fig 4

### 1. Transformations of the Hydroxy Group at C-1:

Epoxy alcohols can be converted directly into the corresponding epoxy ethers by using Mitsunobu procedures.<sup>18</sup> Activation of the hydroxy group as the corresponding mesylate or tosylate also provides a useful means of replacing it with various nucleophiles like organolithium or organocopper reagents<sup>19</sup> and hydride sources.<sup>1</sup> (Scheme 7)



Scheme 7

The reactions of epoxy iodides with vinylmagnesium bromide-cuprous iodide provide allylic alcohols, but ordinary substitution products can be obtained when vinylmagnesium bromide is added to a solution of an

epoxy iodide in the presence of hexamethyl phosphoric triamide.<sup>20</sup> Treatment of epoxy iodides with *tert*-butyl lithium also gives allylic alcohols.<sup>21</sup> (Scheme 8)

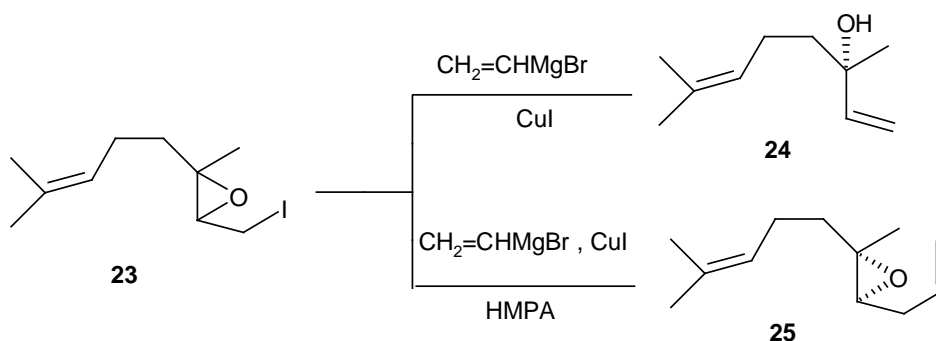

Scheme 8

Treatment of epoxy alcohols with triphenyl phosphine-carbon tetrachloride, which are converted into propargylic alcohols by further treatment with 3 equivalents of an alkyl lithium or lithium diisopropyl amide.<sup>22</sup> On the other hand, treatment with 1 equivalent of an alkyl lithium instead of lithium amide gives a mixture of propargylic alcohol and vinyl chloride.<sup>23</sup> (Scheme 9)

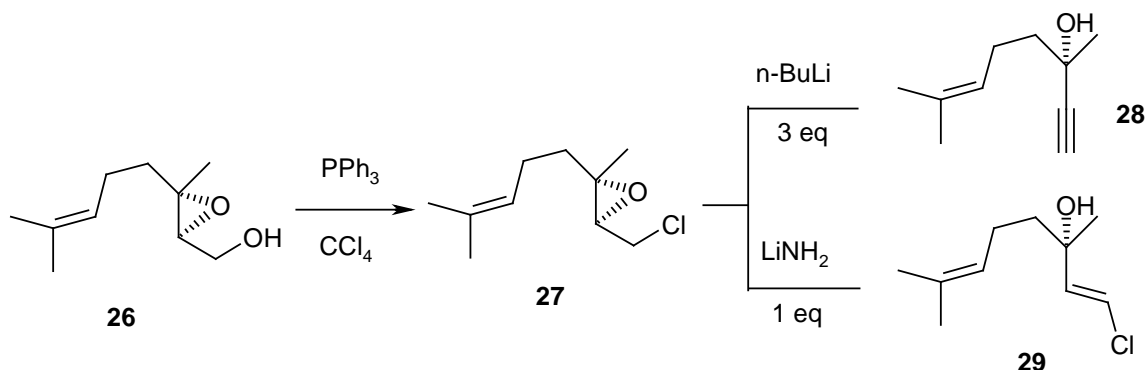

Scheme 9

## 2. Payne rearrangement-Epoxyde opening sequence:

2,3-Epoxy alcohols are rapidly equilibrated with 1,2-epoxy alcohols under alkaline conditions.<sup>24</sup> The equilibrium ratio of 1,2 to 2,3-epoxy alcohol is remarkably dependent on the substrate. However, as 1,2-epoxide is considerably more reactive than 2,3-epoxide, treatment of the equilibrium mixture with a nucleophile provides preferentially the product from the 1,2-epoxide.<sup>25</sup> (Scheme 10)

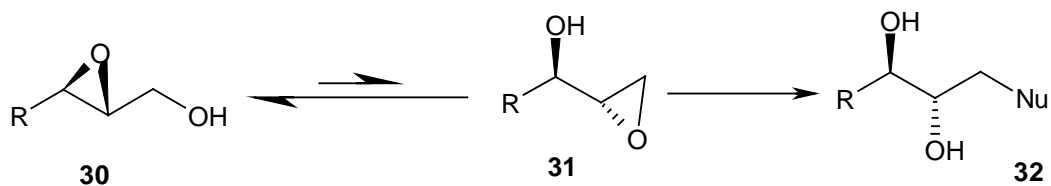

**Scheme 10**

Thus, the Payne rearrangement-epoxide opening sequence is a useful alternative for activating C-1 for substitution<sup>26</sup> although this provides 2,3-diols while direct C-1 substitution provides 2,3-epoxides. For example, the Payne rearrangement epoxide- opening sequence has permitted the straightforward synthesis of sugars via iterative asymmetric epoxidation cycles,<sup>27</sup> other nucleophiles including OH<sup>28</sup>, TsHN<sup>29</sup>, CN<sup>30</sup>, N<sub>3</sub><sup>-31</sup> and R<sub>2</sub>NH<sup>32</sup> have also been used successfully. (**Scheme 11**)

Enantiomeric *erythro* 1,2-epoxy alcohols (**Scheme 12**) can be derived stereoselectively from common 2,3-epoxy alcohols via dihydroxy mesylate and dihydroxy sulfide intermediates.<sup>33</sup>

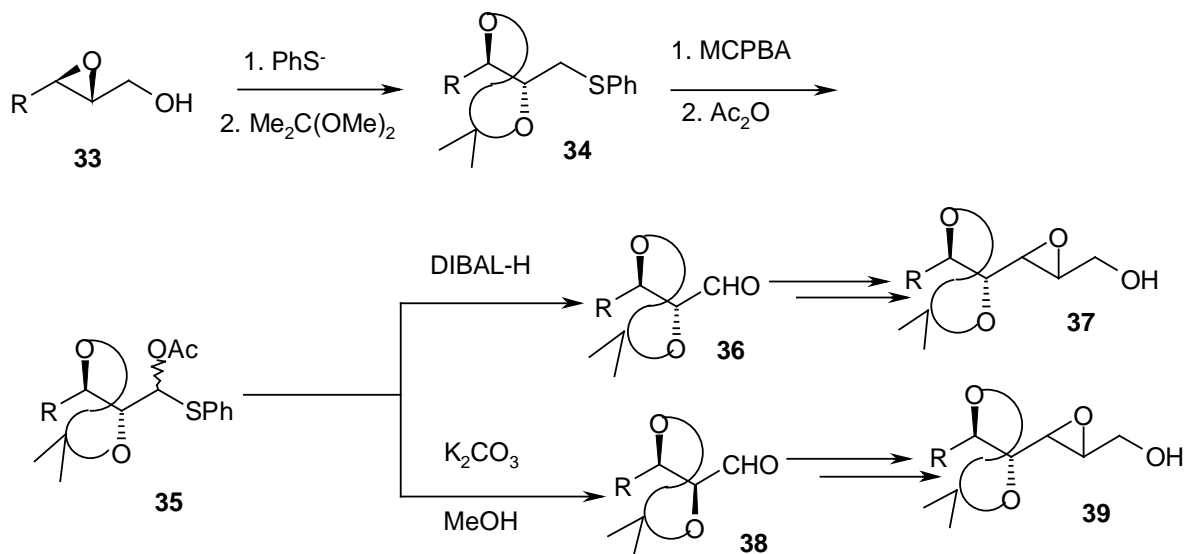

**Scheme 11**

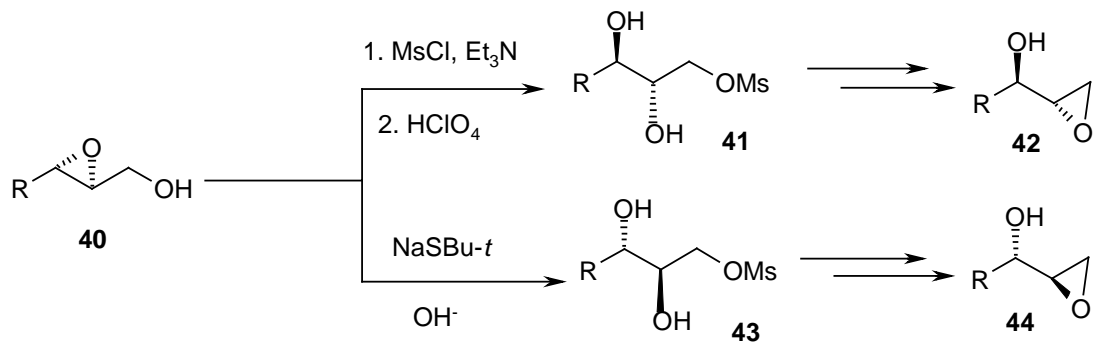

**Scheme 12**

### 3. Epoxide ring opening at C-2 or C-3:

The region and stereo-chemistry in epoxide-opening reactions of 2, 3-epoxy alcohols depend on the steric and electronic factors in the substrates and on reaction conditions. Nucleophilic substitution under neutral and basic conditions occurs preferentially from the less substituted side in an S<sub>N</sub>2 manner, where the configuration of the attacked carbon is inverted.<sup>26</sup> Nucleophilic attack under acidic conditions occurs at the more substituted side in an S<sub>N</sub>2 manner.<sup>27</sup> With sterically unbiased epoxy alcohols or their *O*-protected derivatives, epoxide opening with nucleophiles occurs preferentially at C-3 (**Scheme 13**).<sup>33</sup> This regioselectivity is attributed to the presence of the electronegative hydroxy group at C-1, which retards S<sub>N</sub>2 substitution at the vicinal carbon.

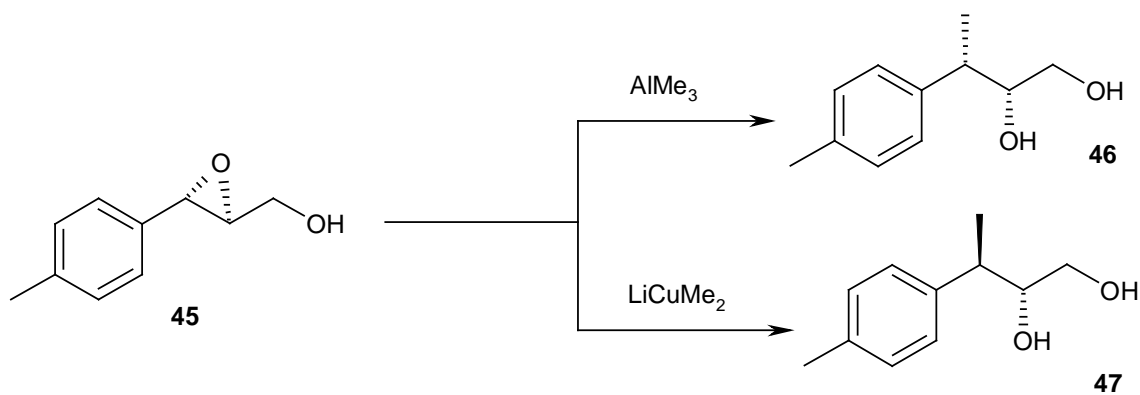

**Scheme 13**

### 2.1.6 Applications of epoxidation in bioactive molecules

A few selected literature report of the application of AE reaction are described below.

1. Sharpless and his group<sup>34</sup> prepared sugars such as D-arabinitol **53** and ribitol **54** starting

from chiral allylic alcohol **48**. (**Scheme 14**)



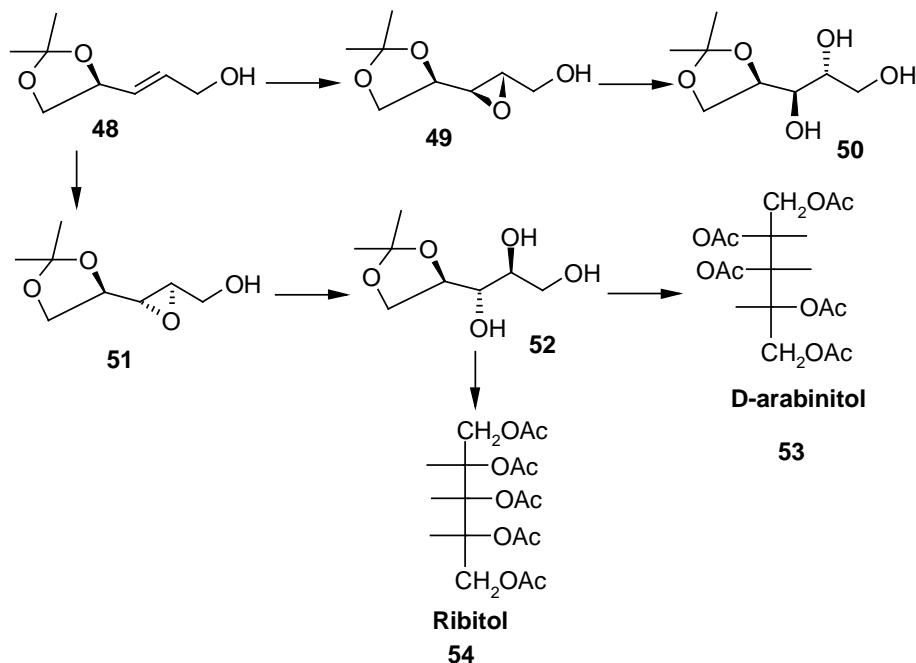

Scheme 14

2. Yamada and group used trans,trans-Farnesol **55** as starting material for the synthesis of (10*R*, 11*R*)-(+)-squalene-10, 11-epoxide **57**,<sup>35</sup> a natural product isolated from red algae *Laurencia okamurai* by employing Sharpless asymmetric epoxidation of **55**. (Scheme 15)

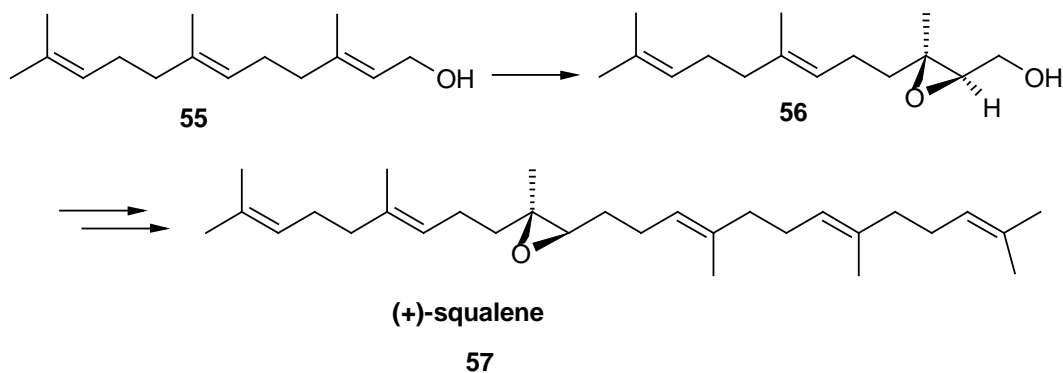

Scheme 15

3. *D-Erythro*-sphingosine<sup>36</sup> was synthesized in a highly enantioselective manner by a modified asymmetric epoxidation reaction. Allylic alcohol **58** was oxidised with titanium tetra[*t*-butoxide] and *D*-(-)-diethyl tartrate as chiral catalyst to give epoxide **59** which was converted to **60**. (Scheme 16)

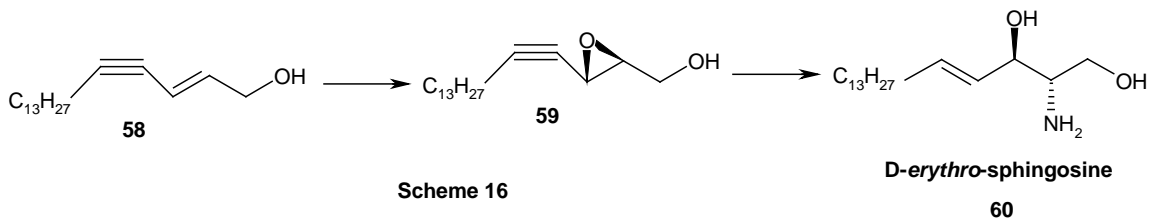

4. Both chiral catalysts have been utilized by Yadav et al.<sup>37</sup> for the stereoselective synthesis of altholactone **66** and isoaltholactone **67**. (**Scheme 17**)

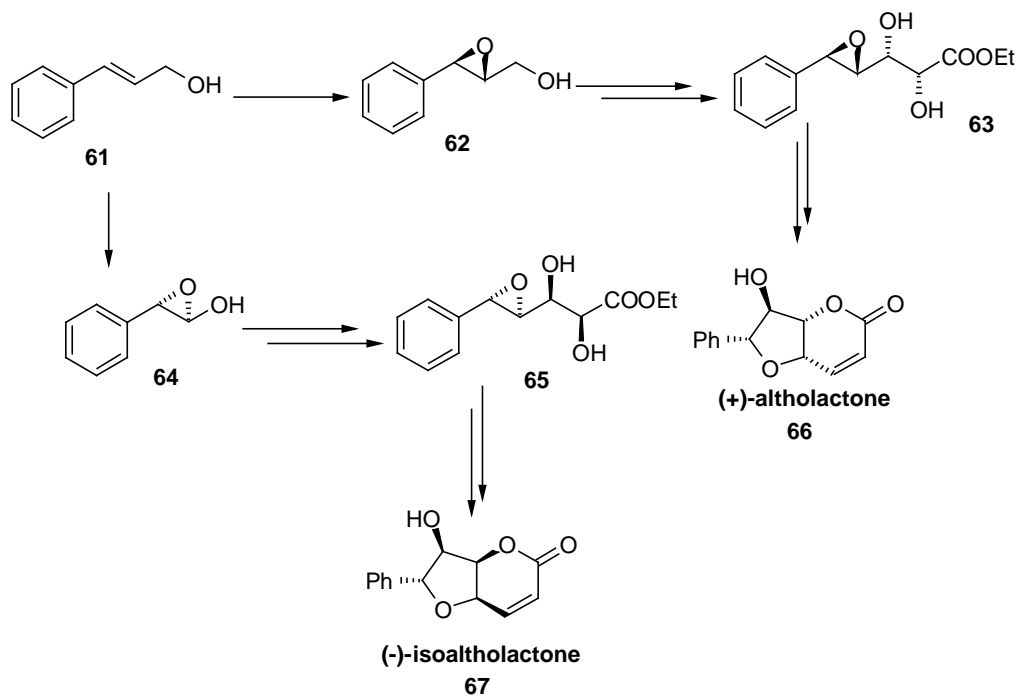

5. Recently, stereoselective total synthesis of (+)-tanikolide **71** was reported by Nishiyama<sup>38</sup> group by employing Sharpless asymmetric epoxidation of allylic alcohol **69** as one of the key steps. (**Scheme 18**)

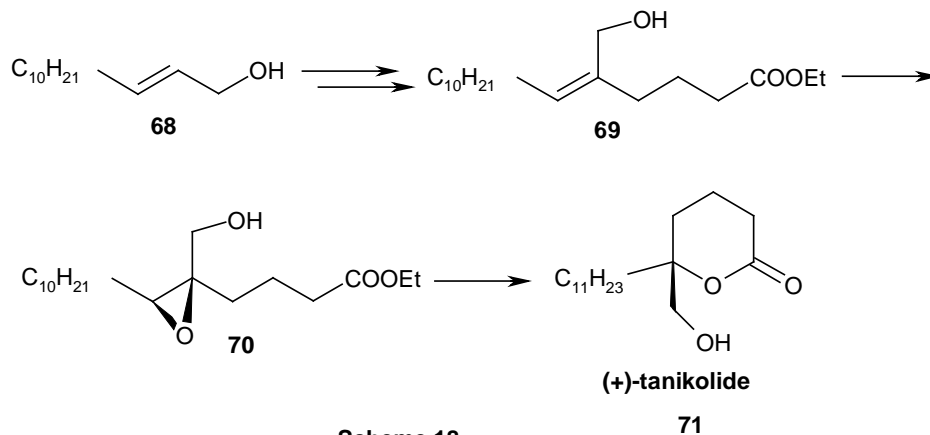

6. AE was successfully employed in the synthesis of verbalactone **76**.<sup>39</sup> (**Scheme 19**)

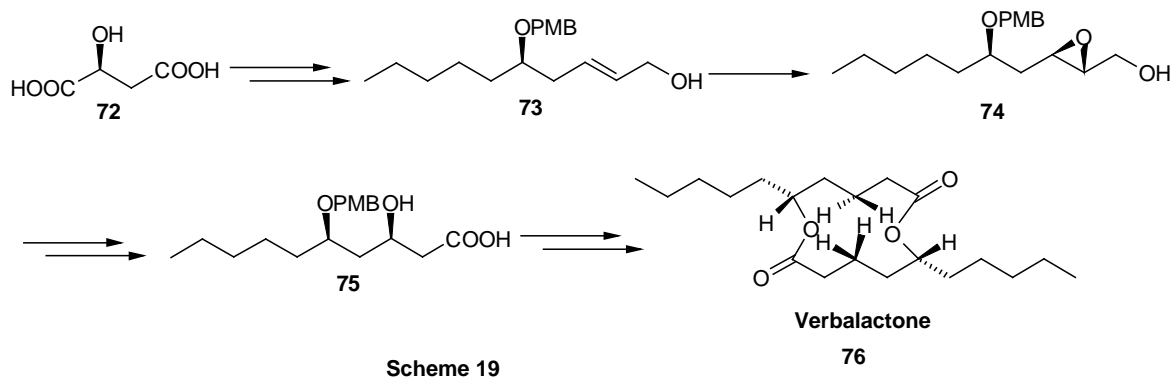

7. An efficient synthesis of prelactone B **80**<sup>40</sup> has been achieved by Sharpless kinetic resolution of allylic alcohol **78**. (**Scheme 20**)

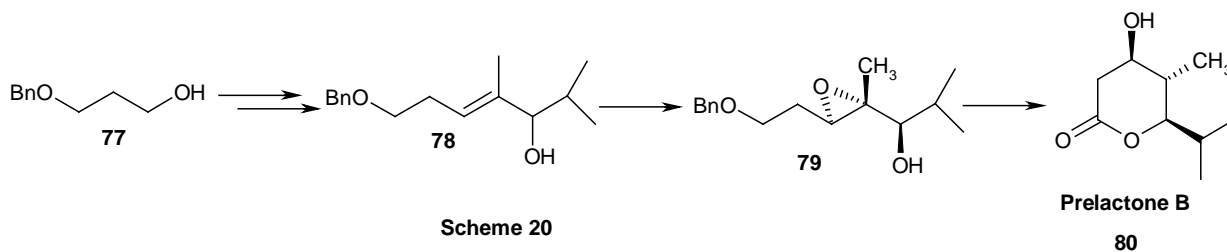

8. Kumar *et al.*<sup>41</sup> have synthesized *trans*-3-hydroxypipercolic acid **84** employing Sharpless asymmetric epoxidation as a key step. (**Scheme 21**)

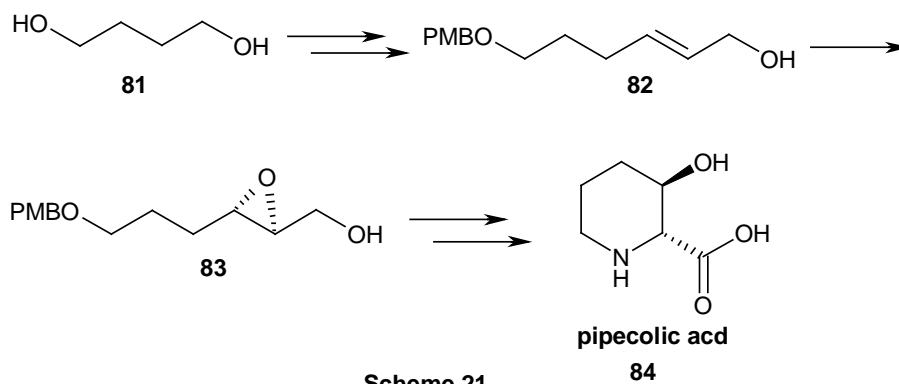

9. Interesting synthesis of (+)-asperlin was reported by Zhou *et al.*<sup>42</sup> using Sharpless kinetic resolution of **85** to give the chiral epoxy alcohol **86** which was converted to natural (+)-asperlin **89**. (**Scheme 22**)

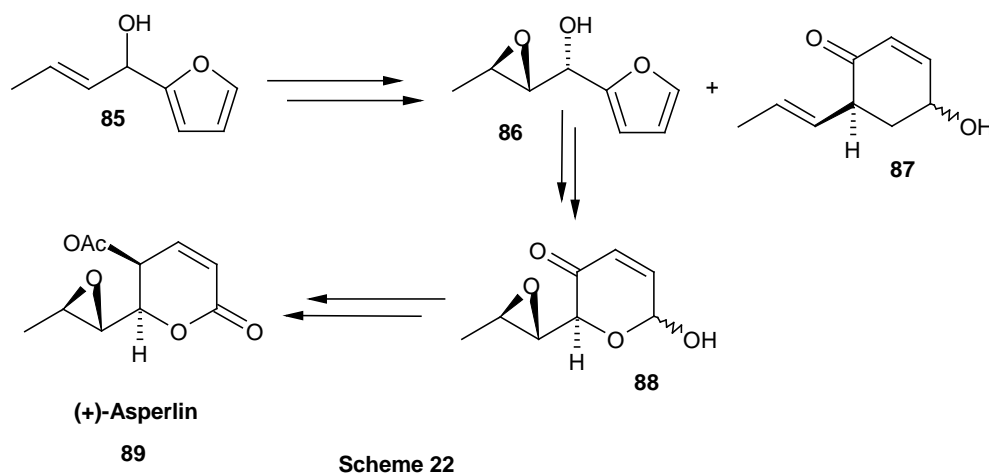

10. Enantioselective synthesis of C<sub>17</sub>-C<sub>21</sub> epoxy acid segment<sup>43</sup> of azinomycins **92** was accomplished by Coleman *et al.* utilizing Sharpless kinetic resolution of **90**. (**Scheme 23**)

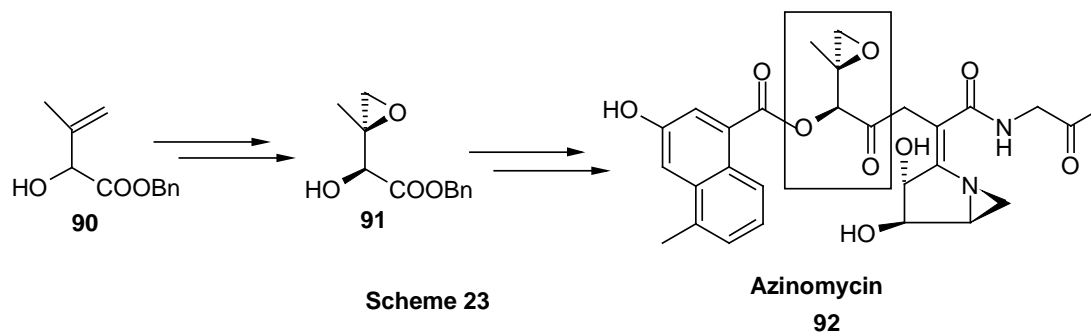

## 2.2 SECTION B: ASYMMETRIC DIHYDROXYLATION (AD)

### 2.2.1 Introduction

During the last decade, a number of powerful asymmetric reactions have emerged as a result of the growing need to develop efficient and practical syntheses of biological active compounds. Catalytic asymmetric reactions provide an especially practical entry into the chiral world due to their economical use of asymmetry inducing agents.<sup>44</sup> Especially useful are the carbon-hetero atom bond forming reactions, since the resulting functionality can be readily manipulated to produce many important classes of compounds. Therefore the oxidative addition of heteroatoms to olefins has been a fruitful area in recent years. Consequently a number of transition metal mediated methods for the epoxidation,<sup>45</sup> oxidative cyclization,<sup>46</sup> aminohydroxylation,<sup>47</sup> halohydrin formation,<sup>48</sup> and dihydroxylation,<sup>49</sup> have been developed (**Scheme 24**).

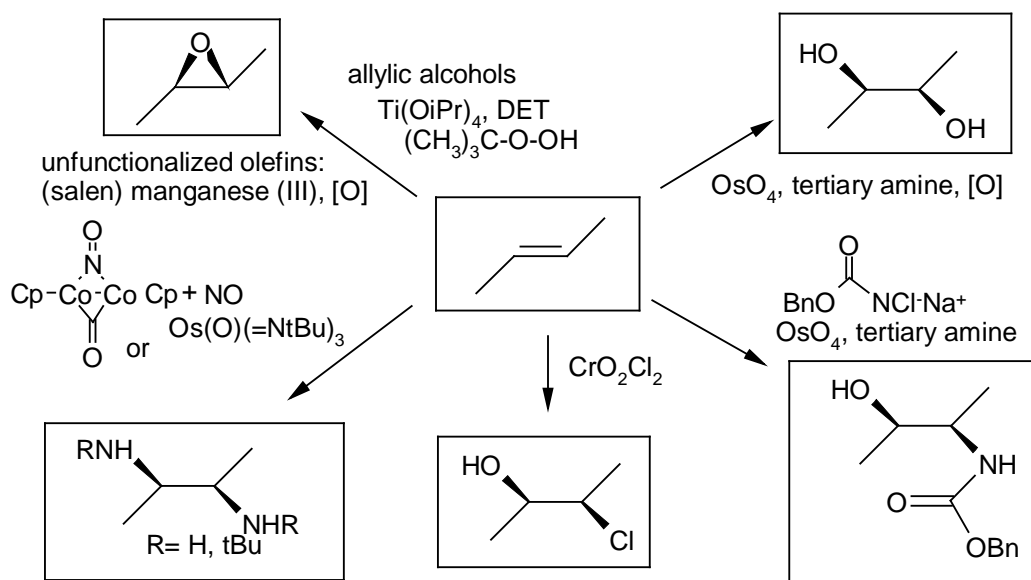

**Scheme 24. Transition metal mediated suprafacial 1,2 difunctionalization of olefins**

A common feature of most of these processes is the phenomenon of ligand acceleration,<sup>50</sup> wherein a metal catalyzed process turns over faster in the presence of a co-ordinating ligand. Consequently reaction funneled through the ligated pathway with the additional consequence that the ligand may leave its imprint on the selectivity determining step. Hence, the ligand can influence the chemo-, regio-, and stereoselectivity of the reaction in a profound way, since ligand acceleration ensures that the unligated

pathway moves into the background. The principle of ligand acceleration is proving to be a powerful tool for discovering new reactivity and new asymmetric processes.

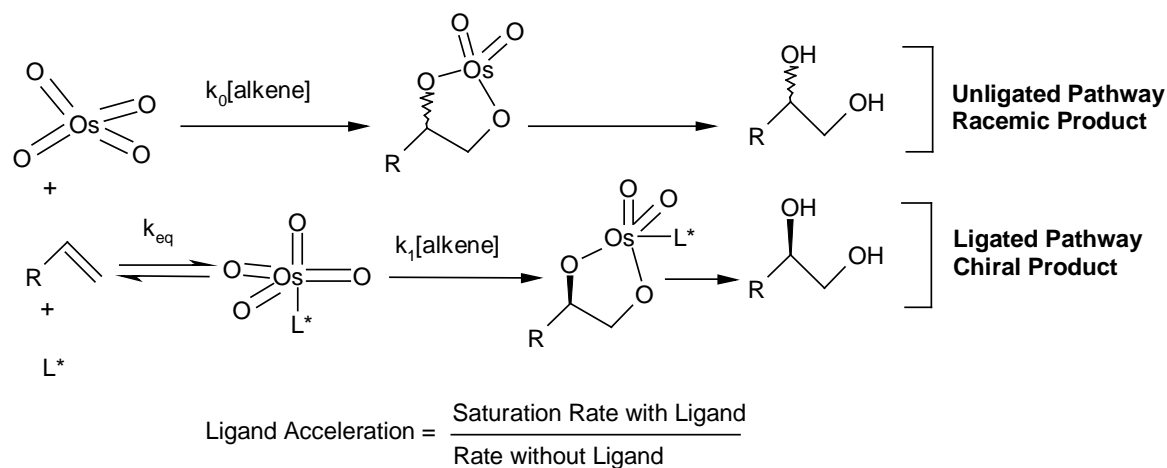

**Scheme 25. Ligand accelerated catalysis-dihydroxylation of olefins**

The Sharpless asymmetric dihydroxylation of olefin catalyzed by  $\text{OsO}_4$  is extremely useful and reliable method to prepare chiral dihydroxy compounds. Initially, Criegee showed that pyridine accelerates the reaction considerably,<sup>51</sup> however cost consideration made stoichiometric osmylation uneconomical. Later, several developments were made but results were obtained with alkaline *tert*-butyl hydroperoxide, introduced by Sharpless and Akashi,<sup>52</sup> or *N*-methylmorpholine *N*-oxide,<sup>53</sup> (Upjohn Process). Minato *et al.* demonstrated that potassium ferricyanide in the presence of  $\text{K}_2\text{CO}_3$  provides a powerful system for the osmium catalyzed dihydroxylation of olefins.<sup>54</sup> Initial efforts by Sharpless and Hentges to induce enantioselectivity in the osmylation with chiral pyridine derivatives failed due to the low affinity of these ligands for  $\text{OsO}_4$ ,<sup>55</sup> since binding constant of a ligand is extremely sensitive to the steric hindrance near the reactivity center. Consequently, quinuclidine derivatives were used instead of pyridines for further investigations due to their intrinsically higher affinity for  $\text{OsO}_4$ .<sup>55</sup> Subsequently, moderate to good enantiomeric excesses using acetate esters of cinchona alkaloids was obtained as chiral ligands.<sup>56</sup> Good results have been achieved using chiral diamine ligands for the asymmetric osmylation of olefins,<sup>57</sup> but a serious drawback is formation of stable chelate complexes due to their bidentate nature. Hence, all the reactions involving bidentate ligands are stoichiometric in both  $\text{OsO}_4$  and the chiral ligand.

## 2.2.2 Mechanism of Osmylation

The osmium-catalyzed dihydroxylation reaction has been the center of extensive mechanistic investigations and two efficient mechanisms have been suggested. Boseken<sup>60e</sup> and Criegee<sup>53</sup> originally proposed a concerted [3+2] pathway while Sharpless *et al.*<sup>60f</sup> suggested a stepwise reaction which is initiated by [2+2]-like addition of the olefin across an Os=O bond followed by rearrangement of the resulting osmaoxetane intermediate to the glycolate product. The recent observation of a nonlinear Eyring relationship between ee and temperature<sup>61</sup> is inconsistent with Criegee's one-step [3+2] mechanism, but it can be explained by a reaction pathway with at least two selectivity determining steps which are weighed differently according to temperature, owing to their different activation parameters, hence this observation suggests that the stepwise [2+2]-like mechanism is operative.

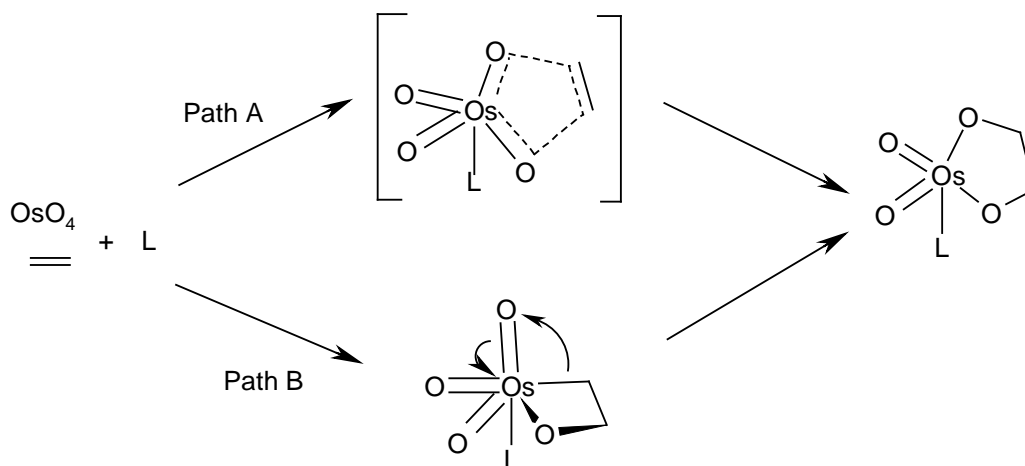

**Scheme 26. Schematic presentation of [3+2] mechanism<sup>60e</sup> (Path A) and the stepwise osmaoxetane mechanism (Path B)<sup>60f</sup>**

The mechanism of osmylation of olefin across double bond can be explained using two different catalytic cycles. The first catalytic version of the asymmetric dihydroxylation was based on the Upjohn process, using *N*-morpholine-*N*-oxide (NMO)<sup>53</sup> as the stoichiometric reoxidant. However, it was found that the enantioselectivities in the catalytic version were inferior to those obtained under stoichiometric conditions. Mechanistic studies revealed that the culprit is a second catalytic dihydroxylation, which proceeds with poor to no face selectivity, since it does not involve the chiral ligand.

The primary cycle proceeds with high face selectivity, since it involves the chiral ligand in its selectivity determining step, the formation of the osmium (VI) glycolate is oxidized to the Os (VIII) glycolate by the co-oxidant (NMO) resulting in loss of chiral ligand (**Fig. 6**). Intermediate plays a crucial role in determining the selectivity for it lies at the point of bifurcation of the good and bad catalytic cycles. The desired path involves hydrolysis of Os(VIII) glycolate to  $\text{OsO}_4$  and the optically active diol whereas the undesired, secondary molecule of olefin, yielding the osmium(VI)bisglycolate and hence diol of low



(a) Cinchona Alkaloid Ligands for AD under Catalytic Conditions<sup>55</sup>

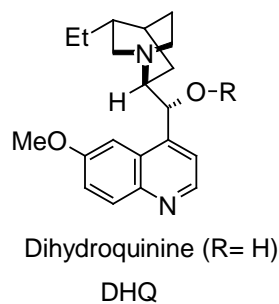
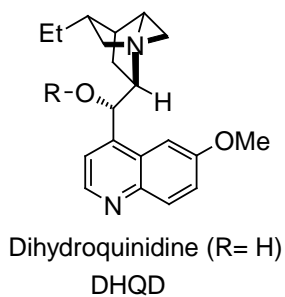

(b) Recent Monodentate Ligands for AD under Catalytic Conditions

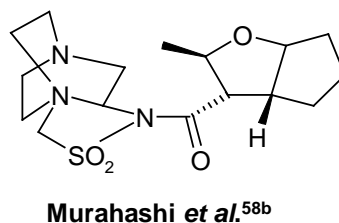
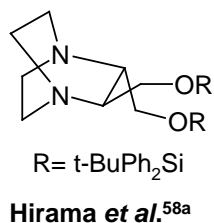

(c) Chiral Diamine Ligands for AD under Stoichiometric Conditions

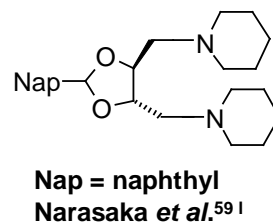
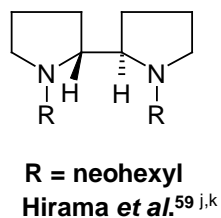
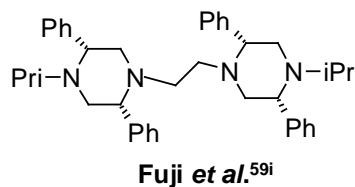
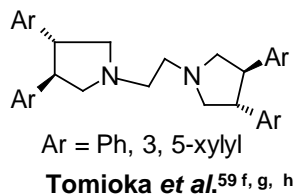
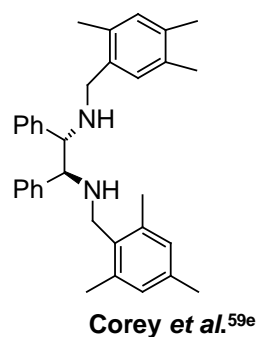
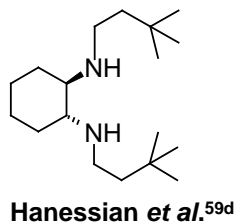
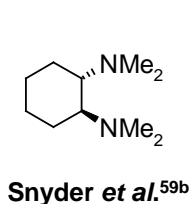
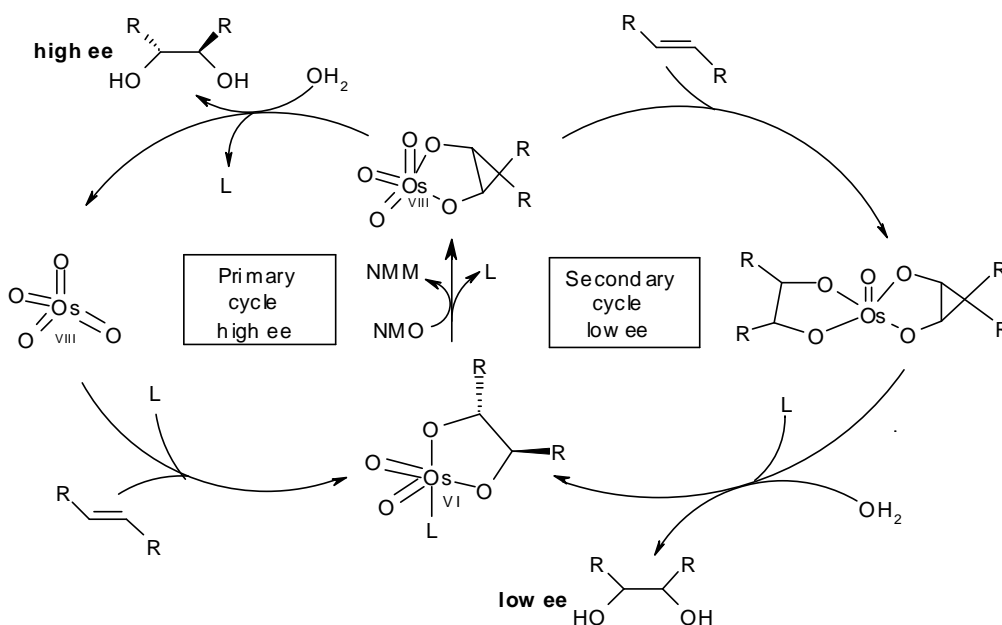

Fig 5. Some ligands for AD reaction



**Fig. 6** Two catalytic cycles for the AD reaction using NMO as the co-oxidant

enantiopurity. Wai and Sharpless developed a remedy for better selectivity by slow addition of olefin.<sup>62</sup> Another, simpler protocol was developed<sup>63</sup> which was based on the use of potassium ferricyanide as the stoichiometric reoxidant<sup>64</sup> in heterogeneous solvent system, typically *tert*-butanol/water (**Fig.7**). The actual osmylation takes place in the organic layer, giving rise to the Os(VI)glycolate which can not be oxidised to an Os(VIII) glycolate, because of the absence of the inorganic stoichiometric oxidant,  $K_3Fe(CN)_6$ , in the organic layer. Consequently, the second catalytic cycle can not occur. Further, reaction requires hydrolysis of the Os(VI)glycolate to the diol and a water soluble inorganic Os(VI) species which enters the basic aqueous layer ready to be oxidized by  $K_3Fe(CN)_6$  to  $OsO_4$ . The latter returns to the organic phase, completing the catalytic cycle. The enantiomeric purities of diols obtained under these heterogeneous conditions are essentially identical to those obtained under stoichiometric conditions. Amberg and

Xu<sup>65</sup> discovered that alkyl sulfonamides (e.g.  $\text{CH}_3\text{SO}_2\text{NH}_2$ ) accelerates the hydrolysis of the Os(VI) glycolate under heterogeneous conditions, and the reaction times can be up to 50 times shorter in the presence of this additive.

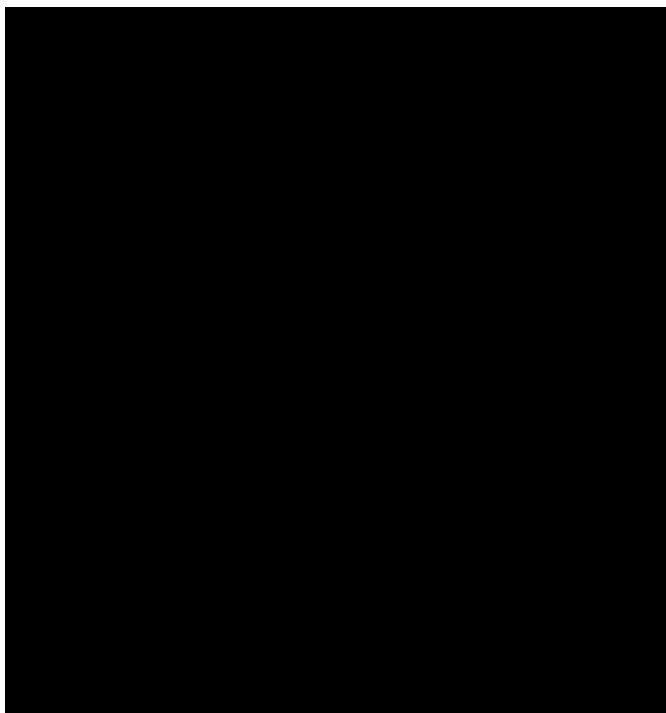
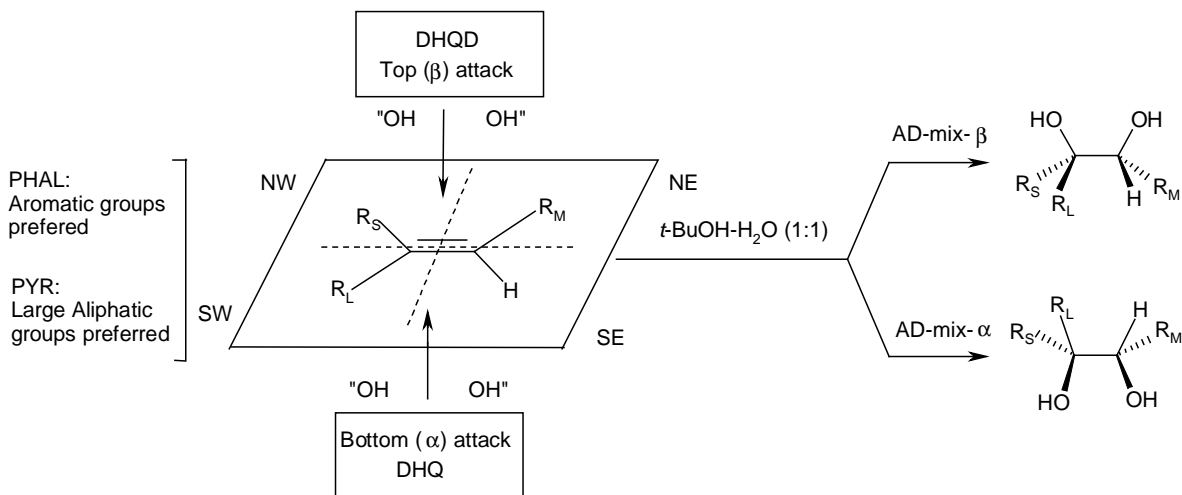

Figure. 7 Catalytic cycle of the AD reaction with  $\text{K}_3\text{Fe}(\text{CN})_6$  as the co-oxidant<sup>63</sup>

### 2.2.3 Empirical rules for predicting the face selectivity

Despite the mechanistic investigations, the face selectivity of the dihydroxylation can reliably be predicted using an empirical 'mnemonic device'.<sup>66</sup> The plane of the olefin is divided into the four quadrants according to a simple set of rules. The SE quadrant is sterically inaccessible and, with few exceptions, no substituent other than hydrogen can be placed here. The NW quadrant, lying diagonally across from the SE quadrant, is slightly more open and the NE quadrant appears to be quite spacious. The SW quadrant is special in that its preferences are ligand dependent. Even though this SW quadrant normally accepts the largest group, especially in the case of PYR ligands, it is especially attractive for aromatic groups in the case of PHAL ligands.<sup>66c</sup> An olefin which is placed into this olefin according to the above constraints

receives the two OH groups from above, i.e. from the  $\beta$ -face, in the case of DHQD derived ligands and from the bottom, i.e. from the  $\alpha$ -face, in the case of DHQ derivatives (**Scheme 27**).



**Scheme. 27** The mnemonic device for predicting the face selectivity

## 2.2.4 Reaction Conditions

The catalytic asymmetric dihydroxylation is performed in a 1:1 mixture of water and *t*-BuOH and the olefin concentration is usually 0.1 M.<sup>67</sup> The key reagents are 3 equivalents of  $K_3Fe(CN)_6$  as the re-oxidant, 0.2-0.4 mol% osmium, 1 mol% of ligand, 3 equivalents of  $K_2CO_3$  and 1 equivalent of  $CH_3SO_2NH_2$ . Additionally, the ligand can be recovered especially when large scale reactions are carried out. For PHAL ligand, the combined organic layers are extracted with 3% aq.  $H_2SO_4$  saturated with  $K_2SO_4$  (ca. 40 mL/1g of ligand). The ligand enters the aqueous phase as the hydrogen sulphate salt and the solution can be reused directly for the subsequent AD reaction without further purification. However, the amount of  $K_2CO_3$  in the subsequent reaction should be increased in order to neutralize excess  $H_2SO_4$  and also to release the ligand salt as its free base, and the volume of aqueous ligand solution added to the reaction mixture.

## 2.2.5 The cinchona alkaloid ligands and their substrate preferences

### Phthalazine (PHAL) ligands

Due to the ready availability of second generation ligands i.e. PHAL<sup>68</sup> (Phthalazine) ligands are widely used and this ligand class reacts especially when aromatic groups are present, and remarkably high enantioselectivities were observed when the aromatic substituents appear in certain optimal locations<sup>69</sup> like

in *trans*-stilbene for which the enantioselectivity is as high as 99.8%.<sup>70</sup> However, PHAL ligands give inferior results with aliphatic olefins, especially if they are branched near the double bond or if they have very small substituents.

### Anthraquinone (AQN) ligands

The anthraquinone ligands are well suited for almost all olefins having aliphatic substituents<sup>71</sup> and diols derived from allyl halides or allyl alcohols can be obtained with satisfactory enantiomeric purity, thereby giving access to valuable chiral building blocks. The AQN derivatives are the ligands of choice for the AD reaction, except for olefins with aromatic or sterically demanding substituents.

### Pyrimidine (PYR) ligands

The pyrimidine ligands are the ligands of choice for olefins with sterically demanding substituents.<sup>72</sup>





### Diphenyl pyrazinopyridazine (DPP) and diphenyl phthalazine (DP-PHAL) ligands

These ligands give improved enantioselectivities for almost all olefins except for terminal alkyl olefins which are better served by the AQN or PRY ligands.<sup>73</sup> The DPP ligand is normally slightly superior to the DP-PHAL ligand. The DPP derivatives are the optimal ligands for aromatic olefins and for certain *cis*-1,2-disubstituted olefins.

### Indoline (IND) ligands

*Cis*-1,2-disubstituted olefins generally are poor substrates for the AD reaction and the IND derivatives are normally the ligands of choice.<sup>74</sup> However, in certain cases better results are obtained with the new second generation ligands.<sup>75</sup>

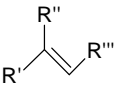
**Table 1. Recommended ligands for each olefin class**

Olefin Class						
Preferred Ligands	<u>R = Aromatic</u> DPP, PHAL <u>R = Aliphatic</u> AQN <u>R = Branched</u> PYR	<u>R<sup>1</sup>, R<sup>2</sup> = Aromatic</u> DPP, PHAL <u>R<sup>1</sup>, R<sup>2</sup> = Aliphatic</u> AQN <u>R<sup>1</sup>, R<sup>2</sup> = Branched</u> PYR	<u>Acyclic</u> IND <u>Cyclic</u> PYR, DPP, AQN	<u>R<sup>1</sup>, R<sup>2</sup> = Aromatic</u> DPP, PHAL <u>R<sup>1</sup>, R<sup>2</sup> = Aliphatic</u> AQN	PHAL, DPP, AQN	PYR, PHAL

## 2.2.6 Cyclic sulfites/sulfates

### Introduction

Indeed cyclic sulfite esters have been known since 1932,<sup>76</sup> the lack of an efficient method for preparing cyclic sulfates limited their applications. The oxidation of cyclic sulfites with sodium periodate catalyzed by ruthenium tetroxide<sup>77</sup> represents an important development that has broadened the use of cyclic sulfate intermediate in synthesis. The advent of the catalytic asymmetric dihydroxylation reaction provides a route to chiral 1,2 diols from a wide spectrum of olefins,<sup>78</sup> which can be further elaborated to cyclic sulfate.<sup>79</sup>

The number of advantages of cyclic sulfates have originated from several following properties.

1. Cyclic sulfites/sulfates have high reactivity toward various nucleophiles and are more reactive than epoxide.
2. They can activate nucleophilic attack at one position while serving as a protecting group at a second position and at vigorous conditions they can source as an activator for two sequential reactions.
3. The reactions of five-membered cyclic sulfates with nucleophiles provide two contiguous stereocenters and moreover a remote stereocenter can be controlled by cyclic sulfates of 1,3 and 1,4-diols.

4. Since the intermediate of nucleophilic substitution is generally the salt form of a mono sulfate ester, separation of the product from the nonsalt by product is typically a facile process.

### 2.2.7 Preparation of cyclic sulfites/sulfates

1. Cyclic sulfates have been prepared by the reaction of epoxides with  $\text{SO}_2$  and by the reaction of 1,2 and 1,3-diols with  $\text{Et}_2\text{NSF}_3$  (DAST).<sup>80</sup> (Scheme 27)

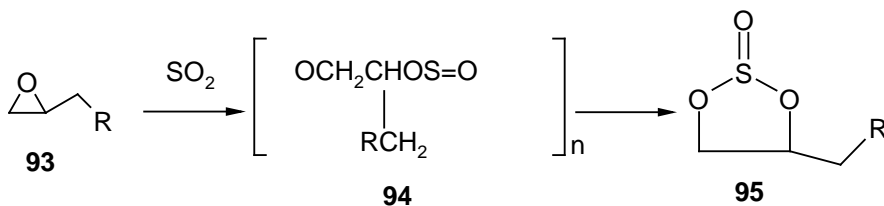

Scheme 27

2. An efficient synthesis of cyclic sulfites is the reaction of thionyl chloride with a diol or transesterification of a dialkyl sulfite with a diol.<sup>81</sup> (Scheme 28)

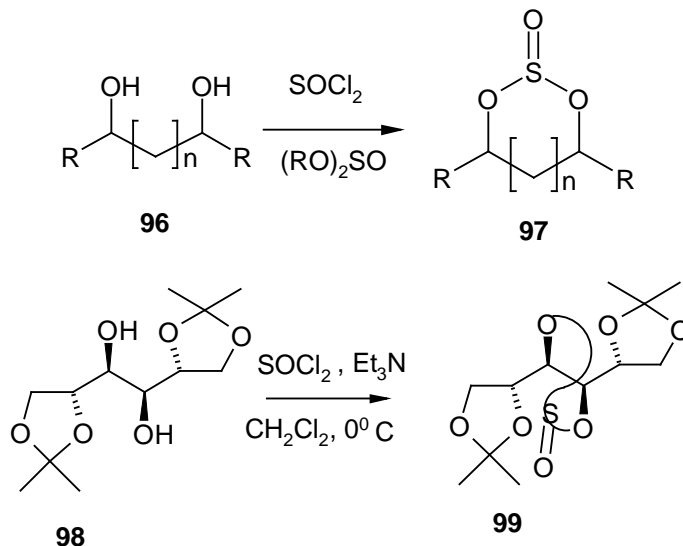

Scheme 28

3. Cyclic sulfates have been prepared by treatment of acyclic diols with sulfuryl chloride ( $\text{SO}_2\text{Cl}_2$ ) at extremely low temperature, but only moderate yields were obtained because of the chlorinating nature of  $\text{SO}_2\text{Cl}_2$ .<sup>82</sup> (Scheme 29)

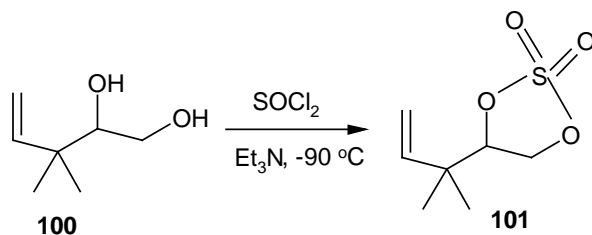

**Scheme 29**

4. Alternatively, the oxidation of cyclic sulfites with a stoichiometric amount of ruthenium tetroxide furnishes cyclic sulfate in satisfactory yield.<sup>83</sup> Due to expensive of RuO<sub>4</sub>, it is limited to small scale preparations. Catalytic amount of RuO<sub>4</sub> is generated *in situ* by the reaction of ruthenium trichloride or ruthenium dioxide with sodium periodate made available an expedited route for the oxidation of cyclic sulfites.<sup>82,84</sup> (**Scheme 30**)

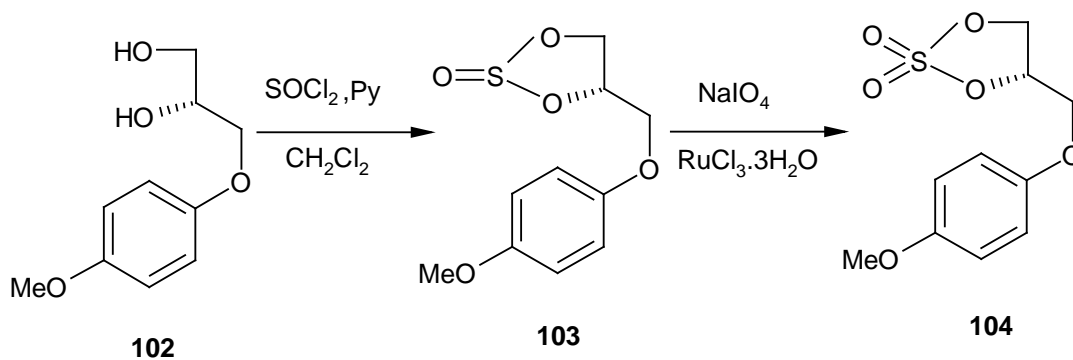

**Scheme 30**

### 2.2.8 Reactions of cyclic sulfites/sulfates

Analogous to epoxides, cyclic sulfites/sulfates can be opened by the attack of a nucleophile at either carbon center giving a sulfite/sulfate monoester. These monoesters allow some interesting transformations, which make the chemistry of cyclic sulfite/sulfate more versatile than of epoxides. Hydrolysis of the monoesters leads to hydroxy compounds that parallel those obtained from oxirane.<sup>82</sup> However, the sulfate monoester can function as a leaving group, leading to disubstitution products.

Cyclic sulfites and especially sulfate react with a variety of nucleophiles and a few examples are Cl<sup>-</sup> (LiCl),<sup>85</sup> Br<sup>-</sup> (NH<sub>4</sub>Br),<sup>85</sup> F<sup>-</sup> (Et<sub>4</sub>NF·2H<sub>2</sub>O, n-Bu<sub>4</sub>NF),<sup>86</sup> N<sup>3-</sup> (LiN<sub>3</sub>, NaN<sub>3</sub>),<sup>87</sup> RNH<sub>2</sub>,<sup>87</sup> PhCOO<sup>-</sup> (PhCOONH<sub>4</sub>),<sup>82, 86</sup> ROH,<sup>88</sup> NO<sup>3-</sup> (n-Bu<sub>4</sub>NNO<sub>3</sub>),<sup>82</sup> SCN<sup>-</sup> (NH<sub>4</sub>SCN),<sup>85</sup> PhS<sup>-</sup> (PhSNa),<sup>89</sup> AcS<sup>-</sup>,<sup>90</sup> H<sup>-</sup> (NaBH<sub>4</sub>, NaBH<sub>3</sub>CN),<sup>82</sup> PhCH<sub>2</sub><sup>-</sup> (PhCH<sub>2</sub>MgBr, Li<sub>2</sub>CuCl<sub>4</sub>),<sup>82</sup> RC=C<sup>-</sup> (RC=CsiMe<sub>3</sub>+MeLi),<sup>91</sup> (RS)<sub>2</sub>CH<sup>-</sup> (with 1, 4-cyclic sulfates).<sup>92</sup>



The hydrolysis of sulfate monoester is carried out with an equal volume of 20% aq. sulfuric acid and ether.<sup>82</sup> However, a chemoselective hydrolysis of sulfate ester in the presence of acid-labile groups (acetonide and silyloxy) is carried out with a catalytic amount of sulfuric acid and 0.5-1.0 equivalents of water in THF. The use of a minimum of water is crucial to achieve the desired chemoselectivity.<sup>86</sup>

### 2.2.9 Applications of asymmetric dihydroxylation and cyclic sulfites/sulfates in bioactive molecules

The application of asymmetric dihydroxylation and cyclic sulfites/sulfates is very vast. A few selected literature reports are described below.

1. Bruckner *et al.*<sup>93</sup> have synthesized (+)- montecristin which is class of *annonaceous acetogenins* employing AD on *trans*-olefinic bond followed by standard organic transformation. (**Scheme 31**)

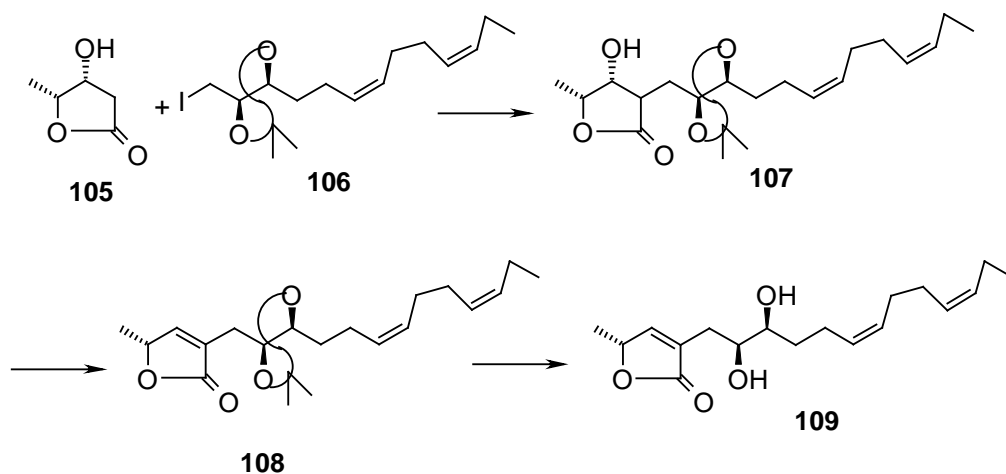

**Scheme 31**

2. A stereoselective synthesis of the polyhydroxy indolizidine alkaloids castanospermine<sup>94</sup> has been achieved using double stereodifferentiation in Sharpless asymmetric dihydroxylation as a key step. (**Scheme 32**)

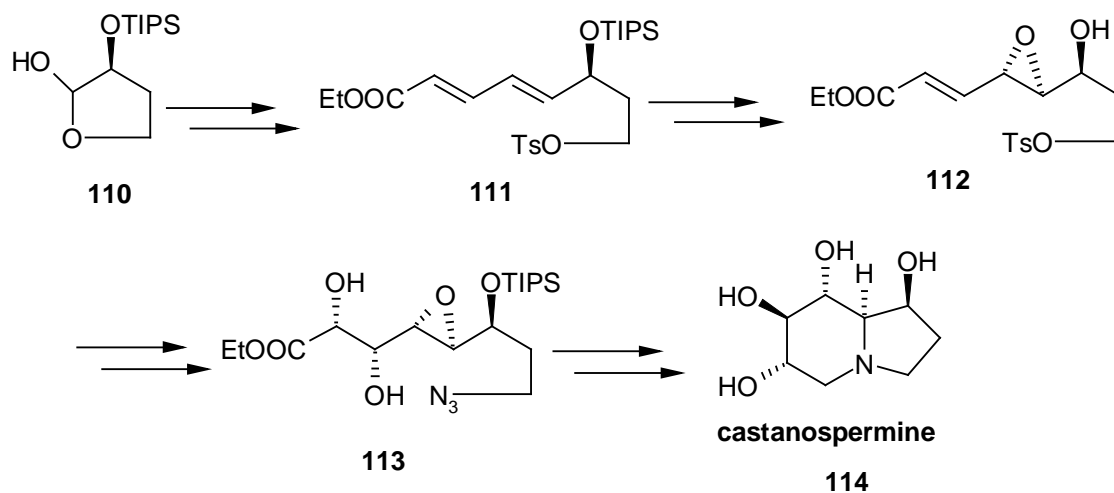

3. Bonini<sup>95</sup> and co-workers have achieved the thiophene containing analog of the HIV protease inhibitor nelfinavir utilizing Sharpless asymmetric dihydroxylation. (**Scheme 33**)

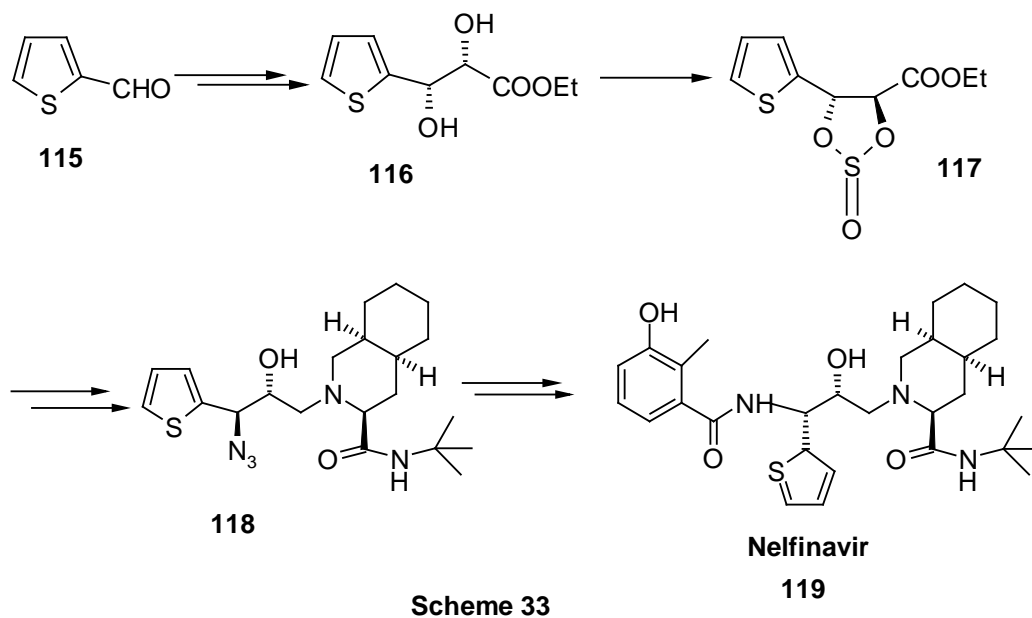

4. Kumar<sup>96</sup> and co-workers, successfully synthesized galantinic acid, a non-proteogenic amino acid using AD and regioselective opening of a cyclic sulfite as key steps starting from commercially available 1,3-propanediol. (**Scheme 34**)

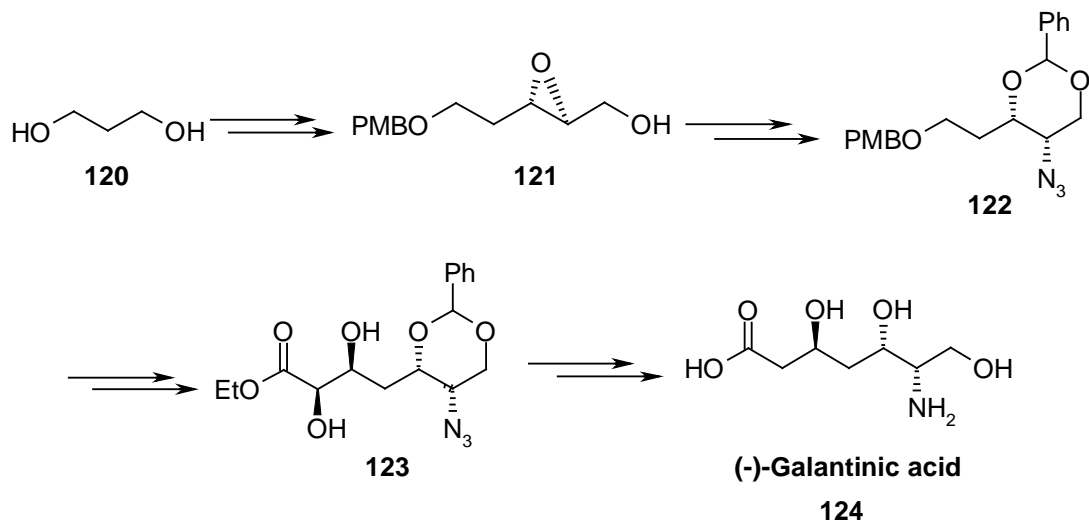

**Scheme 34**

5. A highly enantioselective synthesis of both enantiomers of a novel first *trans*-epoxide sex pheromone posticlure<sup>97</sup> has been achieved by P. Kumar *et al.* using dihydroxylation approach. (**Scheme 35**)

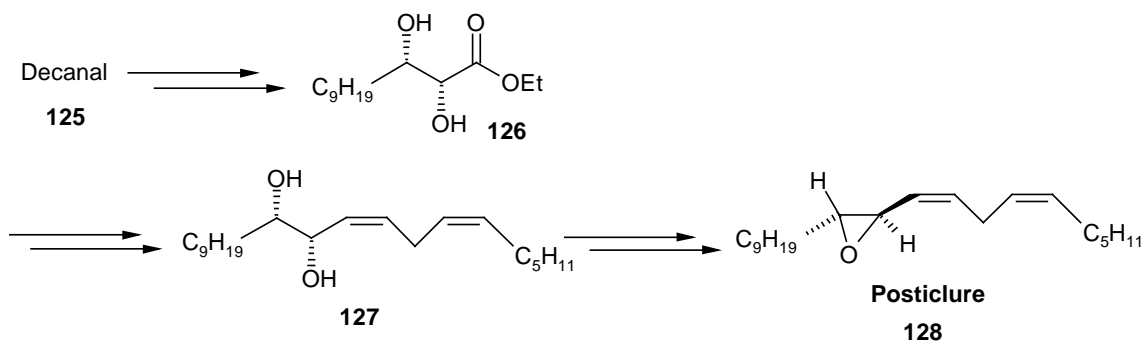

**Scheme 35**

6. An asymmetric synthesis of (*S*)-oxybutynin,<sup>98</sup> a muscarinic receptor antagonist has been reported by P. Kumar *et al.* using Sharpless asymmetric dihydroxylation of  $\alpha$ -cyclohexyl styrene, as key step. (**Scheme 36**)

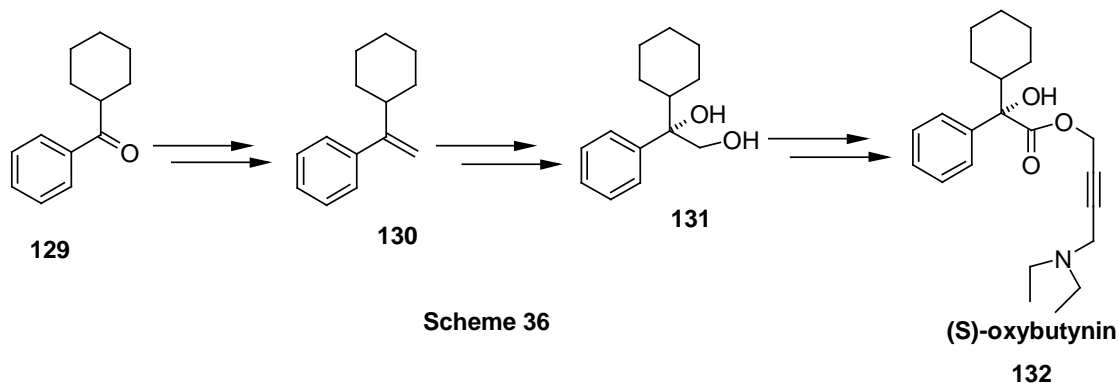

7. Interesting synthesis of (*R*)-(-)-mevalonolactone<sup>99</sup> has been achieved via cyclic sulfate methodology. (**Scheme 37**)

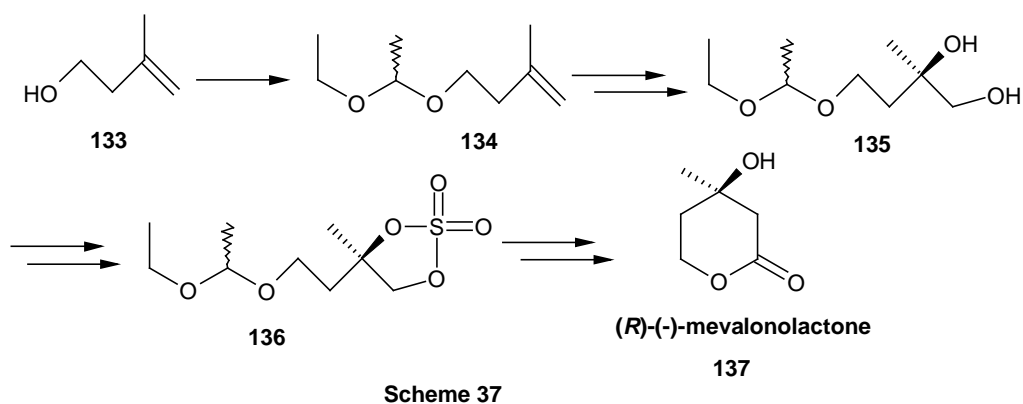

8. AD is successfully employed in the synthesis of *D*-ribo-(2*S*,3*S*,4*R*)-C<sub>18</sub>-phytosphingosine as its tetraacetate derivative, starting from *D*-mannitol.<sup>100</sup> (**Scheme 38**)

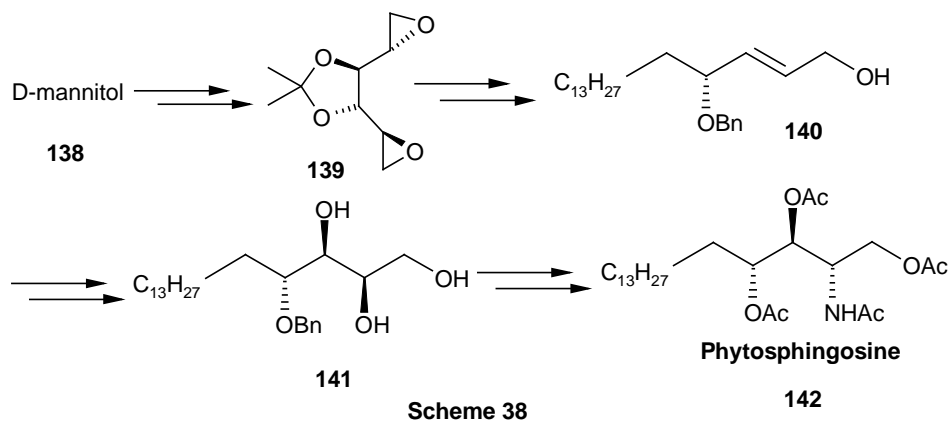

## 2.3 SECTION C: ASYMMETRIC AMINOHYDROXYLATION (AA)

### 2.3.1 Introduction

Among all catalytic processes, asymmetric aminohydroxylation<sup>101</sup> is the most versatile as it facilitates a single step introduction of two functional groups viz amino (protected) and hydroxy group, from a wide range of simple alkene starting materials. The significance of this invention was immediately apparent to many researchers<sup>102</sup> as the AA reaction provides straightforward access to the amino alcohol array and in a wide variety of biologically active agents and natural products.<sup>103</sup> As a result, the reaction rapidly gained the prominence of its forerunners, the AE<sup>1</sup> and AD<sup>49</sup> processes. The reaction typified by the conversion shown in **Scheme 39**, employs catalyst constituting of cinchona alkaloid derived ligands and an osmium species in combination with a stoichiometric nitrogen source that also functions as the oxidant. The chiral ligands give rise to the observed enantioselectivity by favouring addition to one enantiotopic face of the prochiral alkene substrate. In this way, the 1,4-bis-(9-*O*-dihydroquininyl)-phthalazine [(DHQ)<sub>2</sub>PHAL] ligand directs addition to the α-face of an alkene **143** to form amino alcohol products such as **144** or **145** (**Scheme 39**). Alternatively, the 1,4-bis-(9-*O*-dihydroquinidinyl)-phthalazine [(DHQD)<sub>2</sub>PHAL] ligand directs addition to the β-face of **143**.

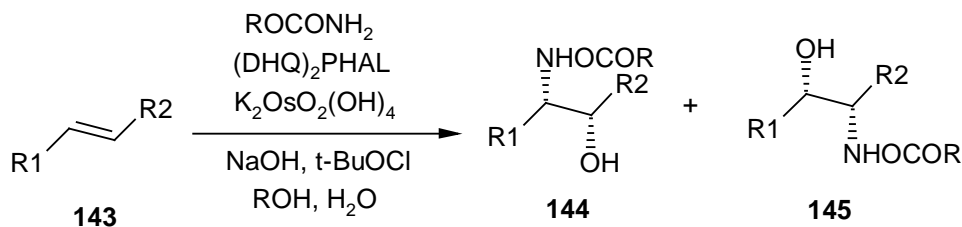

**Scheme 39**

An additional complexity that is not manifested in the AD process involves the regioselectivity of the AA reaction. The oxidation of unsymmetrical alkene such as

143 ( $R_1 \neq R_2$ ) can, in principle, give rise to two regioisomeric amino alcohol products 144 and 145. In many cases, the conditions or the aromatic linker of the chiral ligand, for example phthalazine (PHAL) or anthraquinone (AQN), strongly influence the regioselectivity of the reaction.<sup>104</sup>

### 2.3.2 Mechanism

The proposed mechanism for the asymmetric aminohydroxylation is closely based on mechanistic studies of its forerunner, the AD reaction. The intermediate implicated in the key bond forming step is the imidotrioxosmium (VIII) species **146**, which adds with 'syn' stereospecificity to the alkene to give the azaglycolate complex **148**. Like in AD, two different mechanisms have been proposed, both of which addresses the preferences of **146** to effect aminohydroxylation rather than dihydroxylation and other key aspects such as enantio- and regio selectivity.

The first mechanism involves a formed [2+2] cycloaddition of the alkene to the imidotrioxosmium species **146** to give the osmaazetidone **150**, followed by ligand co-ordination to form **151** and 1,2 migration of the carbon-osmium bond to give the osmium azaglycolate addition product **148**. This mechanism uses electronic arguments to account for the frequently observed preference for the nitrogen to add regioselectivity to the  $\beta$ -carbon of alkenes bearing an electron withdrawing group.<sup>105</sup> The beneficial effects of the ligand on the enantio and regioselectivity of the reaction occur by influencing the position of the equilibrium thereby favouring one of the diastereomeric complexes represented by **151** or by controlling the relative rate of final bond migration to give **150**.<sup>106</sup>

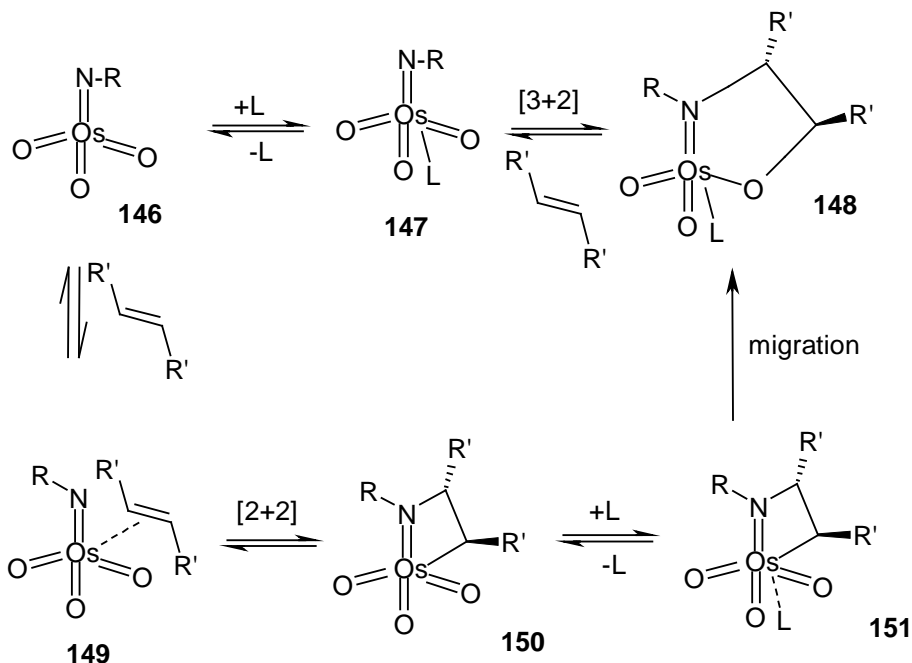

**Scheme 40**

The second mechanism is [3+2] cycloaddition of ligand-bound complex **147** to the alkene, analogous to the Criegee mechanism for osmium-mediated dihydroxylation. In this, ligand co-ordination with imidotrioxo osmium (VIII) followed by [3+2] cycloaddition with olefin gives **148**. (**Scheme 40**)

Based on these results, a mechanistic scheme has been proposed in which two catalytic cycles, each giving different results for selectivity of the transformation (**Fig. 8**). The primary cycle is mediated by the alkaloid derived ligand and in all but one of the AA methods reported to date,<sup>107</sup> the ligand is observed to improve catalytic turnover relative to the non-ligand-mediated reaction. Ligand mediated addition of imidotrioxoosmium(VIII) species **146** to the alkene gives azaglycolate species **148**. Reoxidation of **148** by the nitrogen source gives **152**, which can undergo hydrolysis to regenerate the initial osmium species and liberate product. The oxidized azaglycolate species **152** may also enter the

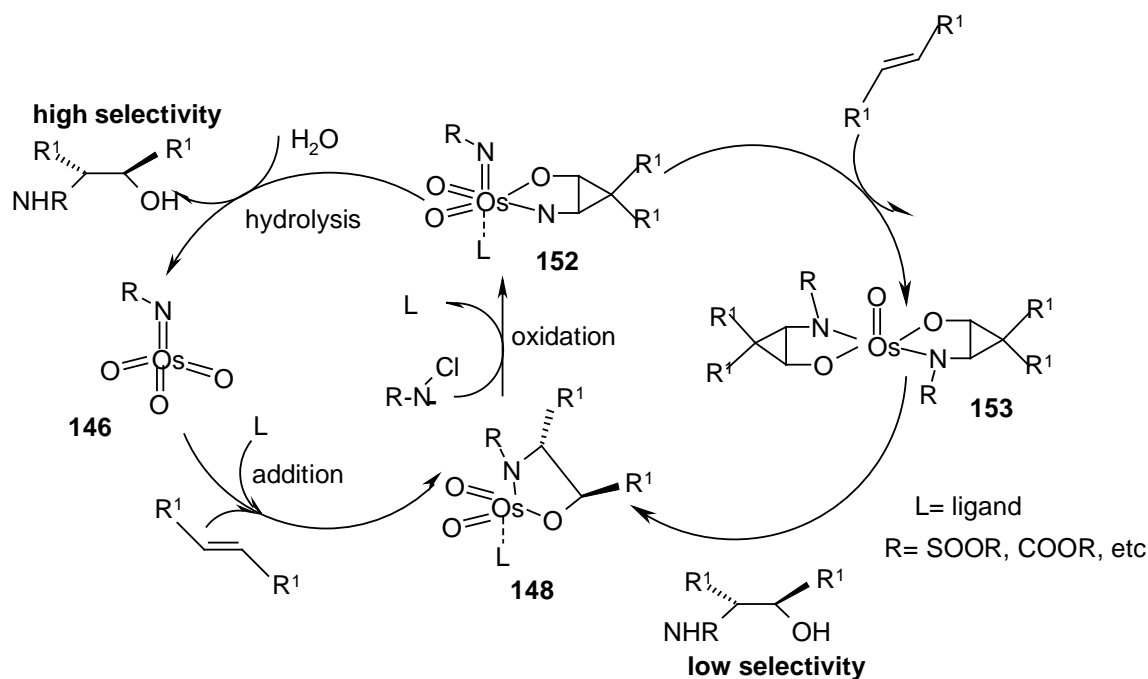

Fig. 8

secondary cycle and add to a second alkene to give the bis(azaglycolate)osmium species **153**. The addition step of this cycle is independent of the *Cinchona* alkaloid derived ligand and as a result, gives addition products with low enantio and regio-selectivity. Hydrolysis of **153** leads back to **148**, which can then re-enter either the primary or secondary cycle. The turnover-limiting step in both catalytic cycles is the hydrolysis of azaglycolate complexes **152** or **153**.<sup>108</sup> Control of the oxidation pathway is achieved by conducting the reaction in aqueous solvent mixtures, thereby favouring hydrolysis of **152**<sup>108a</sup> and dominance of the primary cycle. In comparison, all of the AA processes reported to date have been carried out under homogeneous conditions and suppression of the secondary cycle relies on effective hydrolysis.

### 2.3.3 Nitrogen sources

There are three main classes of nitrogen source that have been used to date in the AA reaction. The *N*-halogenated species derived from (i) sulfonamides (ii) carbamates and (iii) amides. All are converted into the respective alkali metal salt prior to addition to the alkene. (Fig. 9)



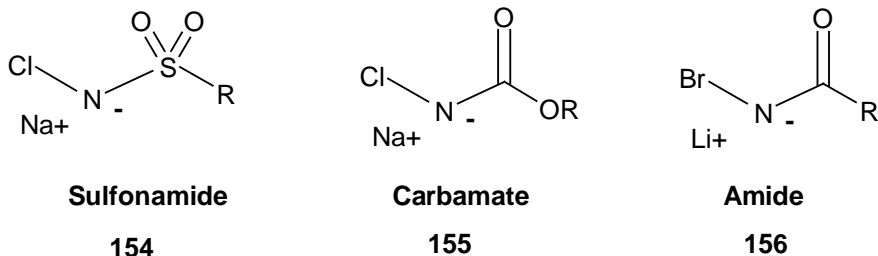

**Fig. 9**

**(i) Sulfonamide variant :** The sulfonamide method was first to be developed, stemming directly from the use of chloramine-T [TsN(Na)Cl] in the catalytic but non-asymmetric forerunner to the AA.<sup>109</sup> Chloramine-T remains the most frequently used reagent, due to its low cost and commercial availability. Subsequent studies have revealed that the size of the sulfonamide group has a tremendous influence on the outcome of the reaction, the smaller the residue the better the results.<sup>110</sup> Thus the methane sulfonamide based chloramine-M reagent generally gives superior results in terms of enantio and regioselectivity, catalytic turnover, and yield, compared to chloramine-T. Additionally, the chloramine-M system shows ligand acceleration, while the toluene sulfonamide based system is ligand decelerated. The robust nature of the sulfonamide product requires harsh deprotection condition such as reductive cleavage of sulfonamides under Birch conditions<sup>111</sup> or with Red-Al.<sup>112</sup> In addition, 33% HBr/CH<sub>3</sub>COOH has been used to cleave toluene sulfonamides.<sup>113</sup> Sulfonamide method is limited in its substrate scope, encompassing  $\alpha$ ,  $\beta$ -unsaturated esters, phosphonates and amides, as well as some terminal and trisubstituted alkenes, but excluding alkenes such as styrenes and vinyl arenes.<sup>114</sup>

**(ii) Carbamate variant :** The discovery of carbamate based nitrogen sources<sup>115</sup> greatly expanded the scope of the AA reaction to include many styrenes and terminal alkenes. This coupled with the facile deprotection of carbamates under milder conditions,<sup>116</sup> gave the AA much greater synthetic utility than was the case using the original sulfonamide based approach. The commonly used carbamates include ethyl, benzyl, *tert*-butyl and 2-(trimethylsilyl) ethyl carbamate (Teoc). All except Teoc are commercially available, and all can be used without purification. The carbamate is typically converted, *in situ*, into the corresponding chloramine salt by reaction with sodium hydroxide and 3 mol equiv. of *tert*-butyl hypochlorite.<sup>117</sup> One frequently encountered difficulty with the carbamate variant of the AA is the removal of unreacted from the reaction mixture, with extensive column chromatography often being required.<sup>118</sup> As

with sulfonamides, carbamates with less sterically demanding N-substituents were found to give better results.

**(iii) Amide variant** : The most recent major variant of the AA reaction is based on *N*-halogenated amides.<sup>119</sup> This variant is comparable in scope to the carbamate based method and works well with cinnamates, acrylates, styrenes, and terminal alkenes. It is advantageous in that only one equivalent of the *N*-haloamide is required, greatly simplifying isolation of the AA products. As alkali metal salts of *N*-chlorocarbamides are susceptible to Hoffmann rearrangement,<sup>120</sup> the lithium salt of commercially available *N*-bromoacetamide was found to be the most viable alternative. By carrying out the reaction at 4 °C, complete suppression of the Hoffmann rearrangement was achieved.<sup>121</sup>

### 2.3.4 Regioselectivity

Control of regioselectivity in the AA is arguably the single greatest challenge when applying the reaction in synthesis. Greater understanding of the factors responsible for controlling regioselectivity would significantly expand the scope of the AA reaction and assist in the development of synthetic strategies that centre on this transformation. The problem of regioselectivity is a complex one and many factors have been invoked to explain one and many observed trends, such as alkene substitution, alkene polarisation and ligand-substrate interactions.

**Alkene substitution** : The AA of the homoallylic alcohol derivatives shown in **Scheme 41** explains the general trend that the nitrogen prefers to add to the less substituted end of the alkene.

The above observation may be explained by the steric demand of the substituted imidoosmium ( $\text{Os} = \text{NR}$ ) relative to the unsubstituted oxo-counterpart ( $\text{Os} = \text{O}$ ) in the reactive complex, which favours approach of the former to the less substituted olefinic carbon.

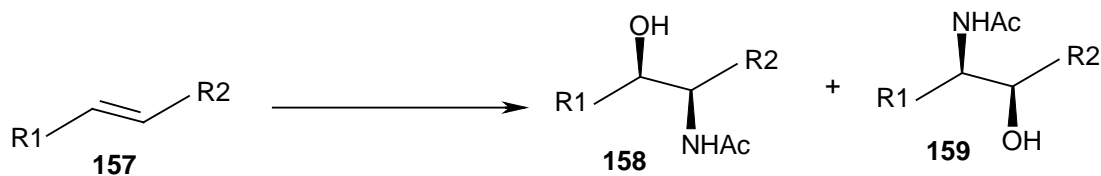

Substrate	R1	R2	158 : 159
157a	TBDPSOCH <sub>2</sub> CH <sub>2</sub>	H	>20 : 1
157b	<i>p</i> -OMe-C <sub>6</sub> H <sub>4</sub> OCH <sub>2</sub> CH <sub>2</sub>	H	1.2 : 1
157c	TBDPSOCH <sub>2</sub> CH <sub>2</sub>	Et	2.0 : 1
157d	<i>p</i> -OMe-C <sub>6</sub> H <sub>4</sub> OCH <sub>2</sub> CH <sub>2</sub>	Et	1 : 3.5

**Scheme 41**

#### Alkene polarisation

Polarisation of the alkene has been suggested as a contributing influence on the preference of  $\alpha$ ,  $\beta$ -unsaturated esters to afford the  $\beta$ -amino product with phthalazine derived ligands. Though the precise rationale varies depending on whether the formal [2+2] or [3+2] cycloaddition is invoked as the preferred mechanistic path way, it has been suggested that the  $\beta$ -amino isomer predominates due to the greater nucleophilic character of the imidoosmium grouping (Os=NR) relative to (Os=O) which favours addition to the more electrophilic carbon of the alkene. However changing the aromatic linker of the chiral ligand to an anthraquinone unit results, for a range of  $\alpha$ ,  $\beta$ -unsaturated esters, in a reversal in regioselectivity such that the  $\alpha$ -aminated products are now favoured. This fact speaks against a strong electronic bias.

#### Ligand-substrate interaction

The most comprehensive study of ligand-substrate interactions has been reported by Janda and co-workers.<sup>110</sup> They propose a model for the AA reaction with phthalazine derived ligands analogous to that proposed by Corey<sup>120</sup> for the AD reaction. As shown in **Fig. 10** in the putative active complex, the osmium lies at the centre of a distorted trigonal bipyramid composed of equatorial oxygens, with the nitrogens from both the quinuclidine ring and the nitrogen source occupying axial positions.<sup>110</sup> Assuming the proposed geometry of the  $\text{OsO}_3\text{N}_2$  species, the regioselectivity of the AA then arises from the mode in which the alkene binds to the catalyst. It is clear that an unsymmetrically substituted alkene could orient in two different ways with regarding to the binding cleft of the catalyst (mode A and mode B) to produce two different regioisomeric products. It follows that ligand-substrate interactions will be important in determining the mode in which an alkene will approach the catalyst.<sup>121</sup>

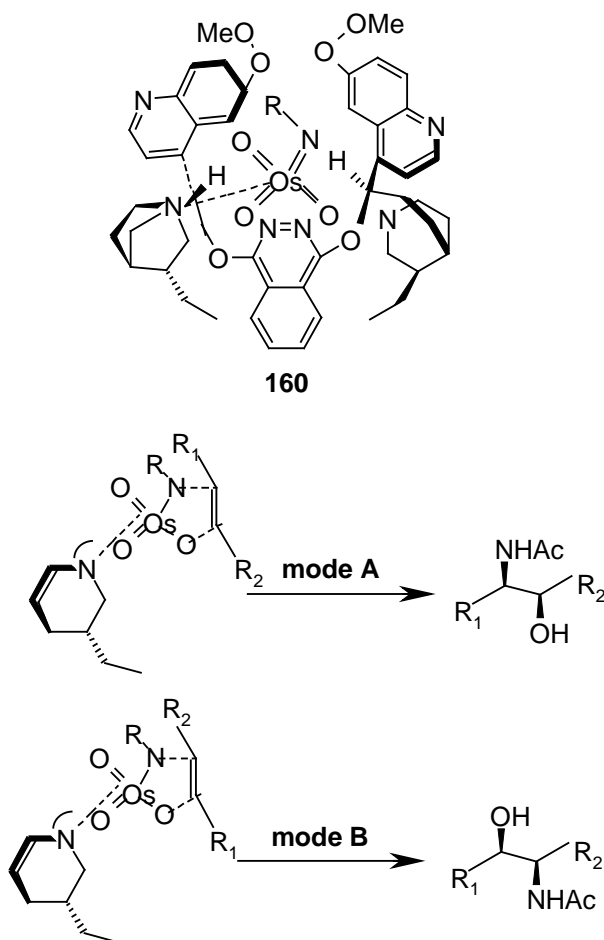

**Fig. 10 : Proposed structure of the  $\text{AcN}=\text{OsO}_3-(\text{DHQD})_2\text{PHAL}$  catalyst **160**, and alternative alkene binding modes A and B.**

### Panek protocol:

Asymmetric synthesis of  $\beta$ -hydroxy- $\alpha$ -amino acid can be performed, by making aryl ester substrates **161** successfully using Panek protocol. The reversal of regioselection may arise from a conformational change induced by the aryl ester functionality.<sup>122</sup>

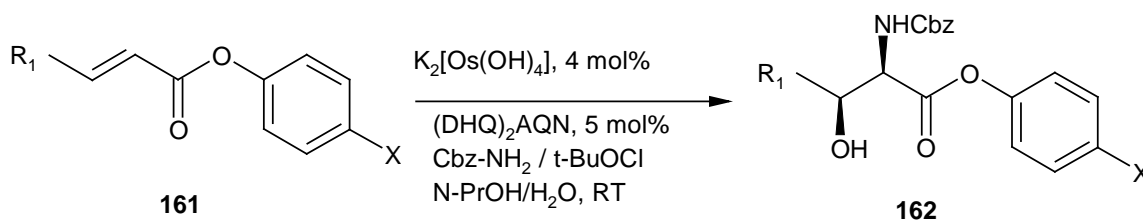

Scheme 42

### 2.3.5 Tethered aminohydroxylation

The discovery of asymmetric aminohydroxylation by Sharpless group has evolved and revolutionized the synthesis of protected amino alcohol functionality in single step. Though it has advantage of one-pot processes, several complicated problems has still to be solved. The major complication with this methodology is a lack of regiochemistry when unsymmetrical alkenes are oxidized. Recently, Donohoe and group<sup>123</sup> demonstrated the complete achievement of regioselectivity through tethering the nitrogen source to both chiral and achiral allylic alcohols. (Scheme 43)

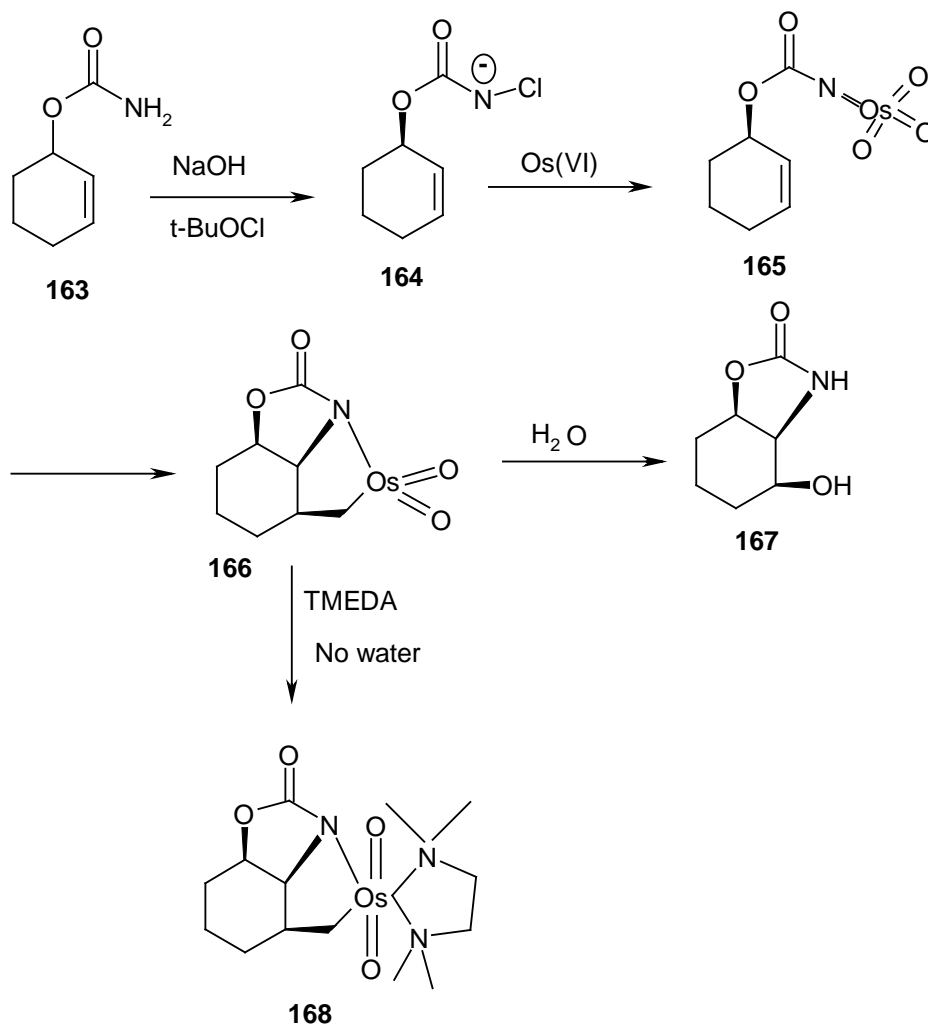

**Scheme 43**

The complete regioselectivity can be explained by the mechanism shown in **Scheme 43**. This mechanism suggests that *in situ* chlorination and deprotonation of the allylic carbamate gives a species **164** (a nitrene equivalent) that is capable of oxidizing potassium osmate [Os (VI)] to the osmium tetroxide analogue **165** [Os (VIII)]. Addition to the alkene gives azaglycolate osmate ester [Os (VI)] **166** which is oxidized and hydrolyzed *in situ*. Representative examples of tethered aminohydroxylation are shown in **Scheme 44** and **Scheme 45**.

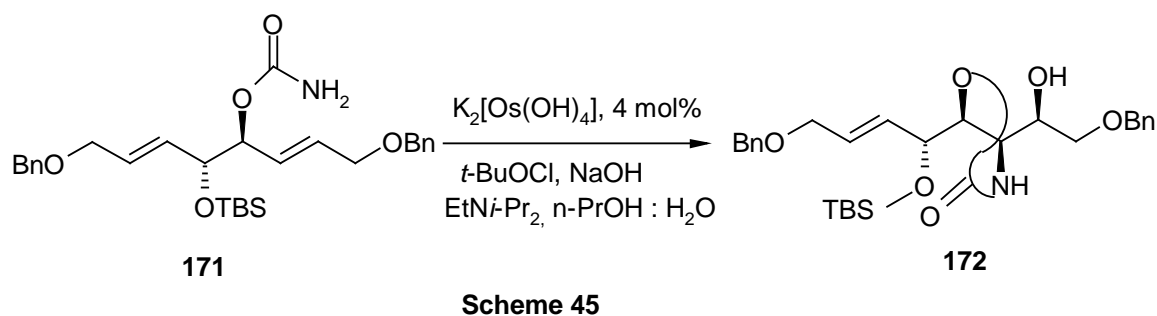
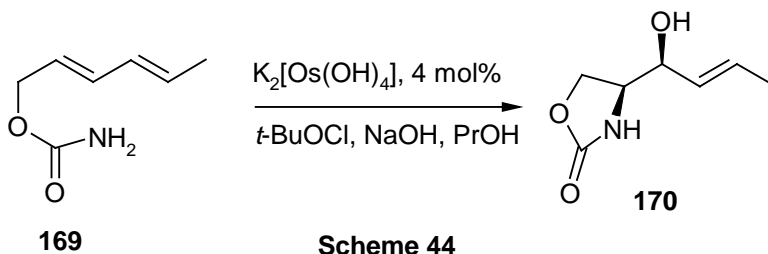

### 2.3.6 Applications of asymmetric aminohydroxylation in bioactive molecules

1. Asymmetric synthesis of (+)-loline<sup>124</sup> was accomplished by White *et al.* employing Sharpless asymmetric aminohydroxylation as one of the key step. (Scheme 46)

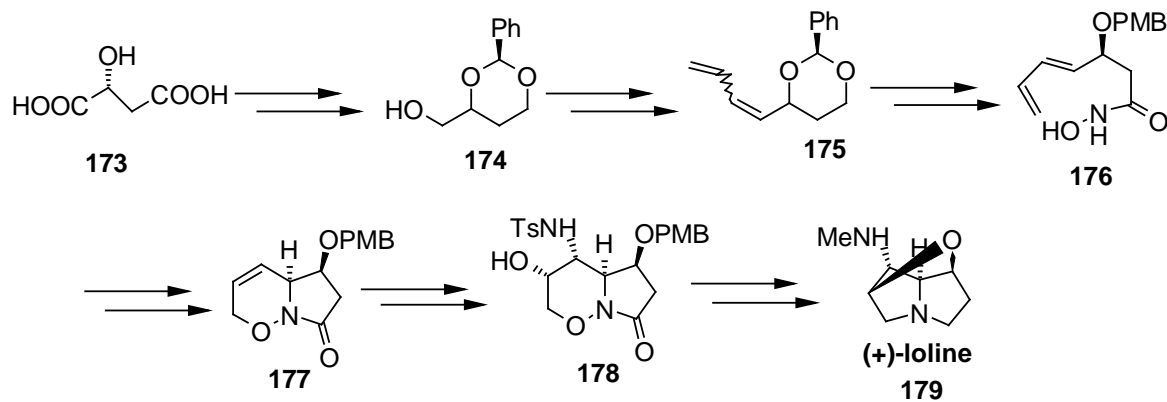

Scheme 46

2. The Sharpless asymmetric aminohydroxylation has been applied to 2-vinyl furan and subsequently asymmetric synthesis of L-deoxymannojirimycin 182 was achieved by O'Doherty *et al.*<sup>125</sup> (Scheme 47)

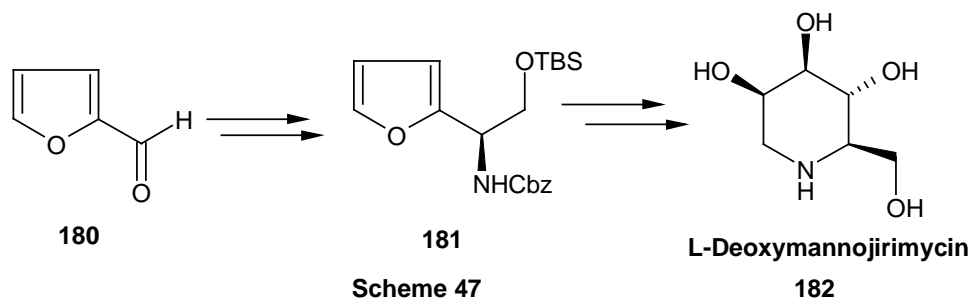

Scheme 47

3. The synthesis of (+)-lactacystin 185 (Scheme 48) which has significant neurotropic activity, was achieved by Panek and co-workers using modified asymmetric aminohydroxylation.<sup>126</sup>

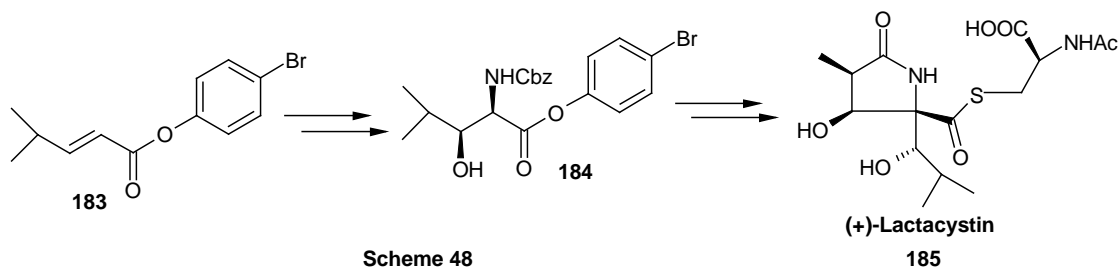

Scheme 48

4. Interesting synthesis of azepine core of (-)-balanol 188 (Scheme 49) has been reported by Panek *et al.*<sup>127</sup>



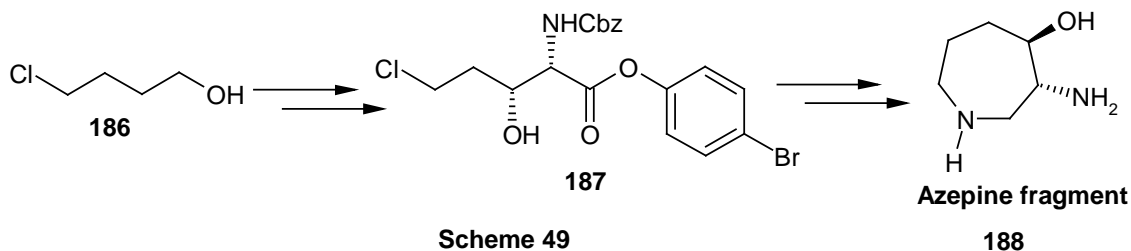

5. A core unit of the potent renin inhibitor Zankerin 191 has been accomplished by Chandrasekhar *et al.*<sup>128</sup> using Sharpless asymmetric aminohydroxylation where chloramine-T was used as nitrogen source.

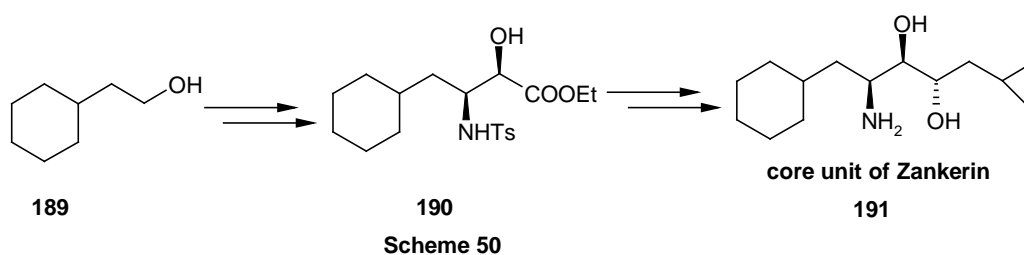

6. More than 100 g of taxol side chain 194 has been prepared by Sharpless *et al.*<sup>129</sup> using asymmetric aminohydroxylation.

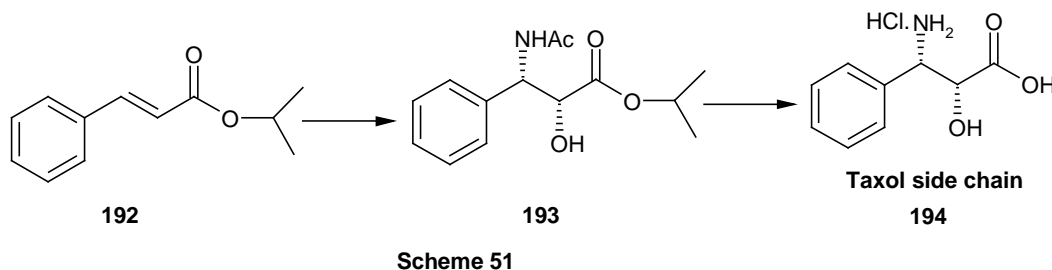

7. Han *et al.*<sup>130</sup> have synthesized several polyhydroxylated pyrrolidines such as DMDP using asymmetric aminohydroxylation.

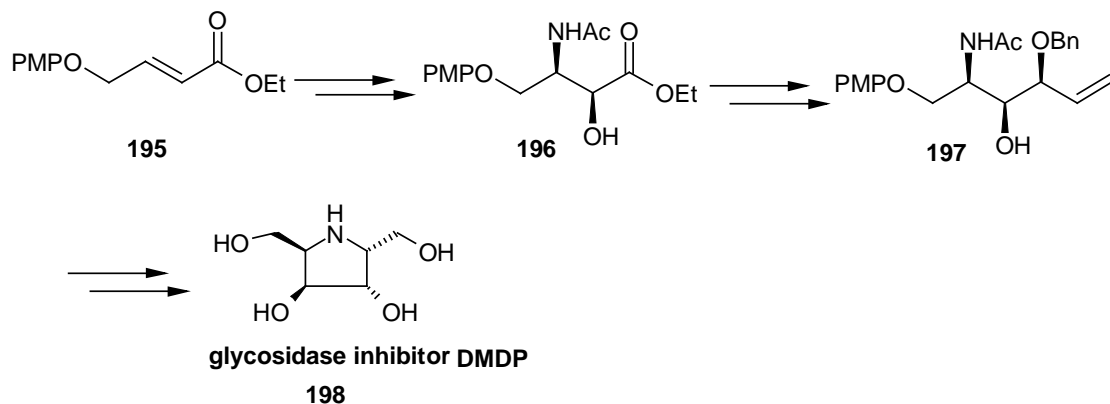

**Scheme 52**

8. An enantioselective synthesis of lactone **1**, a precursor to the (2*R*,4*S*,5*S*) hydroxyethylene dipeptide isostere and amino acid AHPPA **2** has been accomplished by Kumar and co-workers<sup>131</sup> from the common intermediate **3** employing Sharpless asymmetric aminohydroxylation as the key step. (**Scheme 53**)

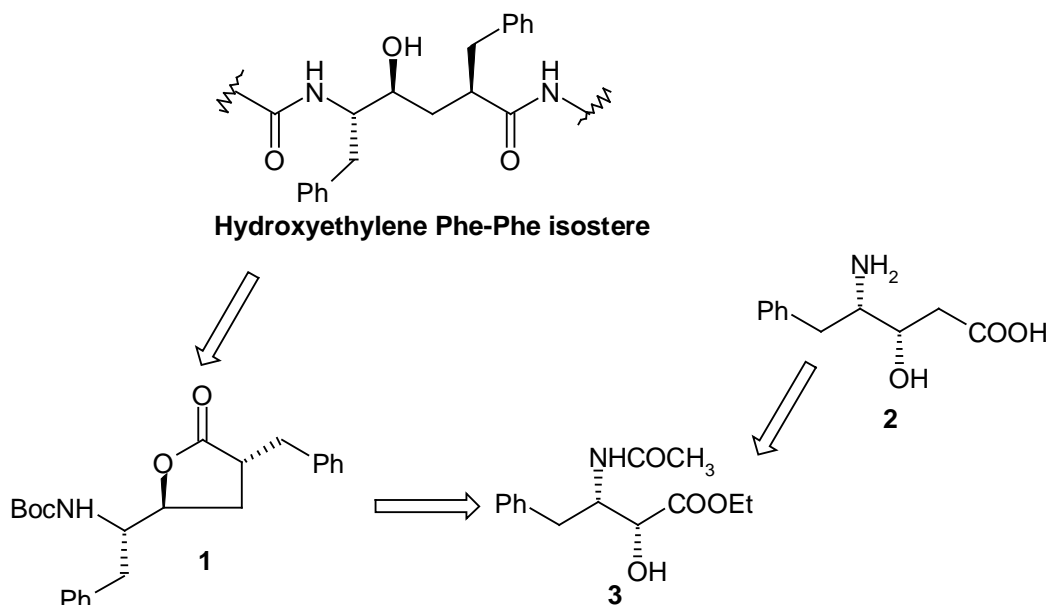

**Scheme 53**

## 2.4 References

1. Katsuki, T.; Sharpless, K. B. *J. Am. Chem. Soc.* **1980**, *102*, 5974.
2. (a) Wood, R. D.; Ganem, B. *Tetrahedron Lett.* **1982**, *23*, 707 ; (b) Erickson, T. J. *J. Org. Chem.* **1986**, *51*, 934.
3. Hirai, Y.; Chintani, M.; Yamazaki, T.; Momose, T. *Chem. Lett.* **1989**, 1449.
4. White, J. D.; Botton, G. L. *J. Am. Chem. Soc.* **1990**, *112*, 1626.
5. (a) Sakai, J.; Sugita, Y.; Sato, M.; Kaneko, C. *J. Chem. Soc., Chem. Commun.* **1991**, 434.
6. (a) Sugita, Y.; Sakai, J.; Sato, M.; Kaneko, C. *J. Chem. Soc., Perkin Trans 1*, **1992**, 2855. (b) Boschetti, A.; Panza, L.; Ronchetti, F.; Russo, G.; Toma, L. *J. Chem. Soc., PerkinTrans. 1*, **1988**, 3353.
7. (a) Parker, R. E.; Issacs, N. S. *Chem. Rev.* **1959**, *59*, 737; (b) Swern, D. In *Organic peroxides*, D. Swern, Ed., Wiley-Interscience, New York, **1971**, vol 2, ch. 5.; (c) Rao, A. S.; Paknikar, S. K.; Kirtane, J. G. *Tetrahedron* **1983**, *39*, 2323 ; (d) Sharpless, K. B.; Verhoeven, J. R. *Aldrichim. Acta.* **1979**, *12*, 63.
8. Sharpless, K. B. Proceedings of the Robert A. Welch Foundation Conferences on Chemical Research XXVII, Houston, Texas, **1983**, pp. 59.
9. (a) Chaumette, P.; Mimoun, H.; Sussine, L.; Fischer, J.; Mitschler, A. *J. Organomet. Chem.* **1983**, *250*, 291; (b) Mimoun, H.; Charpentier, R.; Mitschler, A.; Fische, J.; Weiss, R. *J. Am. Chem. Soc.* **1980**, *102*, 1047 ; (c) Mimoun, H. *Angew Chem Int. Ed. Engl.* **1982**, *21*, 737 ; (d) Sharpless, K. B.; Woodard, S. S.; Finn, M. G. *Pure & Appl. Chem.* **1983**, *55*, 1823 ; (e) Woodard, S. S.; Finn, M. G.; Sharpless, K. B. *J. Am. Chem. Soc.* **1991**, *113*, 106 ; (f) Finn, M. G.; Sharpless, K. B. *J. Am. Chem. Soc.* **1991**, *113*, 106; (g) Mckee, B. H.; Kalantar, T.

- H.; Sharpless, K. B. *J. Org. Chem.* **1991**, *56*, 6966; (h) Narula, A. S. *Tetrahedron Lett.* **1982**, *23*, 5579.
10. Bach, R. D.; Wolber, G. J.; Coddens, B. A. *J. Am. Chem. Soc.* **1984**, *106*, 6098.
11. (a) Rossiter, B. E.; Sharpless, K. B. *The Scripps Research Institute*, La Jolla, CA, unpublished results ; (b) Puchot, C.; Samuel, O.; Dunach, E.; Zhao, S.; Agami, C.; Kagan, H. B. *J. Am. Chem. Soc.* **1986**, *108*, 2353 ; (c) Woodward, S. S.; Ph.D Dissertation, *Stanford University*, California, **1981** ; (d) Burgess, K.; Jennings, L. D. *J. Am. Chem. Soc.*, **1990**, *112*, 7434 ; (e) Carlier, P. R.; Sharpless, K. B. *J. Org. Chem.* **1989**, *54*, 4016.
12. (a) Williams, I. D.; Pedersen, S. F.; Sharpless, K. B. *J. Am. Chem. Soc.* **1987**, *109*, 1279 ; (b) Sharpless, K. B. *Chem. Scripta* **1987**, *27*, 521 ; (c) Pedersen, S. F.; Dewan, J. C.; Eckman, R. R.; Sharpless, K. B. *J. Am. Chem. Soc.* **1987**, *109*, 1279.
13. Katsuki, T.; Sharpless, K. B. *Kyushu University*, Unpublished results.
14. Masamune, S.; Choy, W.; Peterson, J. S.; Sita, L. R. *Angew. Chem. Int. Ed. Engl.* **1985**, *24*, 1.
15. (a) Hanson, R. M.; Sharpless, K. B. *J. Org. Chem.* **1986**, *51*, 1922 ; (b) Gao, Y.; Hanson, R. M.; Kluder, J. M.; Ko, S. Y.; Masamune, H.; Sharpless, K. B. *J. Am. Chem. Soc.* **1987**, *109*, 5765.
16. Martin, V. S.; Woodward, S. S.; Katsuki, T.; Yamada, Y.; Ikeda, M.; Sharpless, K. B. *J. Am. Chem. Soc.* **1981**, *103*, 6237. .
17. (a) Takano, S.; Iwabuchi, Y.; Ogasawara, K. *J. Am. Chem. Soc.* **1991**, *113*, 2786 ; (b) Takano, S.; Setoh, M.; Takahashi, M.; Ogasawara, K. *Tetrahedron Lett.* **1992**,

- 33, 5365.
18. (a) Mitsunobu, O. *Synthesis*, **1981**, 1 ; (b) Walba, D. M.; Vohra, R. T.; Clark, N. A.; Handschy, M. A.; Xue, J.; Parmar, D. S.; Langerwall, S. T. Skarp, K. *J. Am. Chem. Soc.* **1986**, *108*, 7424.
19. (a) Mori, K.; Ebata, T. *Tetrahedron Lett.* **1981**, *22*, 4281 ; (b) Mori, K.; Ebata, T. *Tetrahedron* **1986**, *42*, 3471.
20. (a) Nicolaou, K. C.; Duggan, M. E.; Ladduwahetty, T. *Tetrahedron Lett.* **1984**, *25*, 2069 ; (b) Millar, J. G.; Underhill, E. W. *J. Org. Chem.* **1986**, *51*, 4726.
21. Williams, D. R.; Jass, P. A.; Tse, H.-L. A.; Gaston, R. D. *J. Am. Chem. Soc.* **1990**, *112*, 4552.
22. (a) Takano, S.; Samizu, K.; Sigihara, T.; Ogasawara, K. *J. Chem. Soc., Chem. Commun.* **1989**, 1344 ; (b) Mhaskar, S. Y.; Lakshminarayana, G. *Tetrahedron Lett.* **1990**, *31*, 7227.
23. (a) Yadav, J. S.; Deshpande, P. K.; Sharma, G. V. M. *Pure & Appl. Chem.* **1990**, *62*, 1333 ; (b) Yadav, J. S.; Deshpande, P. K.; Sharma, G. V. M. *Tetrahedron*. **1990**, *46*, 7033 ; (c) Marshall, J. A.; Luke, G. P. *Synlett* **1992**, 1007.
24. Payne, G. B. *J. Org. Chem.* **1962**, *27*, 3819.
25. Behrens, C. H.; Ko, S. Y.; Sharpless, K. B.; Walker, F. J. *J. Org. Chem.* **1985**, *50*, 5687.
26. (a) Behrens, C. H.; Sharpless, K. B. *Aldrichim. Acta* **1983**, *16*, 67 ; (b) Katsuki, T.; Lee, A. W. M.; Ma, P.; Martin, V. S.; Masamune, S.; Sharpless, K. B.; Tuddenham, D.; Walker, F. J. *J. Org. Chem.* **1982**, *47*, 1373 ; (c) Wrobel, J. E.; Ganem, B. *J. Org.*

- Chem.* **1983**, 48, 3761 ; (d) Behrens, C. H.; Ko, S. Y.; Sharpless, K. B.; Walker, F. J. *J. Org. Chem.* **1985**, 50, 5687.
27. Lee, A. W. M.; Martin, V. S.; Masamune, S.; Sharpless, K. B.; Walker, F. J. *J. Am. Chem. Soc.* **1982**, 104, 3515.
28. (a) Sharpless, K. B.; Behrens, C. H.; Katsuki, T.; Lee, A. W. M.; Martin, V. S.; Takatani, M.; Viti, S. M.; Walker, F. J.; Woodward, S. S. *Pure & Appl. Chem.* **1983**, 55, 589 ; (b) Bromacombe, J. S.; Hanna, R.; Kabir, A. K. M. S. *J. Org. Chem.* **1989**, 54, 5854.
29. (a) Wrobel, J. E.; Ganem, B. *J. Org. Chem.* **1983**, 48, 3761 ; (b) Takano, S.; Morimoto, M.; Ogasawara, K. *Synthesis* **1984**, 834.
30. (a) Behrens, C. H.; Ko, S. Y.; Sharpless, K. B.; Walker, F. J. *J. Org. Chem.* **1985**, 50, 5687; (b) Garner, P.; Park, J. M.; Rotello, V. *Tetrahedron Lett.* **1985**, 26, 3299.
31. Behrens, C. H.; Ko, S. Y.; Sharpless, K. B.; Walker, F. J. *J. Org. Chem.* **1983**, 50, 5687.
32. (a) Behrens, C. H.; Ko, S. Y.; Sharpless, K. B.; Walker, F. J. *J. Org. Chem.* **1985**, 50, 5687; (b) Behrens, C. H.; Sharpless, K. B. *J. Org. Chem.* **1985**, 50, 5696.
33. (a) Tung, R. D.; Rich, D. H.; *Tetrahedron Lett.* **1987**, 28, 1139; (b) Takano, S.; Yanase, M.; Sugihara, T.; Ogasawara, K. *J. Chem. Soc., Chem. Commun.* **1988**, 1538.
34. Katsuki, T.; Lee, A. W. M.; Ma, P.; Martin, V. S.; Masamune, S.; Sharpless, K. B.; Tuddenham, D.; Walker, F. J. *J. Org. Chem.* **1982**, 47, 1373.
35. Kigoshi, H.; Ojika, M.; Shizuri, Y.; Niwa, H.; Yamada, K. *Tetrahedron Lett.* **1982**, 23, 5413.
36. Bernet, B.; Vasella, A. *Tetrahedron Lett.* **1983**, 24, 5491.

37. Yadav, J. S.; Rajaiah, G.; Krishnam Raju, A. *Tetrahedron Lett.* **2003**, *44*, 5831.
38. Ohgiya, T.; Nishiyama, S. *Tetrahedron Lett.* **2004**, *45*, 8273.
39. Sharma, G. V. M.; Govardhan, R. C. *Tetrahedron Lett.* **2004**, *45*, 7483.
40. Chakraborty, T. K.; Tapadar, S. *Tetrahedron Lett.* **2003**, *44*, 2541.
41. Kumar, P.; Bodas, M. *J. Org. Chem.* **2005**, *70*, 360.
42. Yang, Z. C.; Zhou, W. S. *Tetrahedron Lett.* **1995**, *36*, 5617.
43. Coleman, R.; Sarko, C. R.; Gittinger, J. P. *Tetrahedron Lett.* **1997**, *38*, 5917.
44. For recent reviews, see : *Catalytic asymmetric synthesis*; Ojima, I., Ed.; VCH publishers : New York **1993**.
45. (a) Katsuki, T.; Martin, V. S. *Org. React.* **1996**, *48*, 1; (b) Johnson, R. A.; Sharpless, K. B. *Catalytic asymmetric synthesis*, VCH, New York, **1993**, 101 ; (c) Katsuki, T. *J. Mol. Catal. A: Chem.* **1996**, *113*, 87 ; (d) Jacobsen, E. N. *Catalytic asymmetric synthesis*, VCH, New York, **1993**, 159.
46. (a) Mc Donald, F. E.; Towne, T.B. *J. Org. Chem.* **1995**, *60*, 5750 ; (b) Kennedy, R. M.; Yang, S. *Tetrahedron Lett.* **1992**, *33*, 3729 ; (c) Tand, S.; Kennedy, R. M. *Tetrahedron Lett.* **1992**, *33*, 5299 ; (d) Tand, S.; Kennedy, R. M. *Tetrahedron Lett.* **1992**, *33*, 5303 ; (e) Boyce, R. S.; Kennedy, R. M. *Tetrahedron Lett.* **1994**, *35*, 5133.
47. (a) Li, G.; Chang, H.-T.; Sharpless, K. B. *Angew. Chem., Int. Ed. Engl.* **1996**, *35*, 451 ; (b) Li, G.; Sharpless, K. B. *Acta Chem. Scand.* **1996**, *50*, 649 ; (c) Rudolph, J.; Sennhenn, P. C.; Vlar, C. P.; Sharpless, K. B. *Angew. Chem., Int. Ed. Engl.* **1996**, *35*, 2810 ; (d) Li, G.; Angert, H. H.; Sharpless, K. B.; *Angew. Chem., Int. Ed. Engl.* **1996**, *35*, 2813 ; (e) Angelaud, R.; Landais, Y.; Schenk, K. *Tetrahedron Lett.* **1997**, *38*, 1407.

48. Sharpless, K. B.; Teranishi, A. Y.; Backvall, J. E. *J. Am. Chem. Soc.* **1997**, *99*, 312.
49. (a) Kolb, H. C.; VanNieuwenhze, M. S.; Sharpless, K. B. *Chem. Rev.* **1994**, *94*, 2483 ;  
(b) Li, G.; Sharpless, K. B. *Acta Chem. Scand.* **1996**, *50*, 649.
50. Berrisford, D. J.; Bolm, C.; Sharpless, K. B. *Angew. Chem., Int. Ed. Engl.* **1995**, *34*, 1059.
51. (a) Criegee, R. *Justus Liebigs Ann. Chem.* **1936**, *75*, 522 ; (b) Criegee, R. *Angew. Chem.* **1937**, *50*, 153 ; (c) Criegee, R. *Angew. Chem.* **1938**, *51*, 519 ; (d) Criegee, R.; Marchand, B.; Wannowias, H. *Justus Liebigs Ann. Chem.* **1942**, *550*, 99.
52. Sharpless, K. B.; Akashi, K. *J. Am. Chem. Soc.* **1976**, *98*, 1986.
53. (a) Schneider, W. P.; McIntosh, A. V. U. S. Patent 2, 769, 824 Nov 6, **1956** ; (b) VanRheenen, V.; Kelley, R. C.; Cha, D. Y. *Tetrahedron Lett.* **1976**, 1973.
54. Minato, M.; Yamamoto, K.; Tsuji, J. *J. Org. Chem.* **1990**, *55*, 766
55. Hentges, S. G.; Sharpless, K. B. *J. Am. Chem. Soc.* **1980**, *102*, 4263.
56. (a) Cleare, M. J.; Hydes, P. C.; Griffith, W. P.; Wright, M. J. *J. Chem. Soc.; Dalton Trans.* **1977**, 941 ; (b) Griffith, W. P.; Skapski, A. C.; Woode, K. A.; Wright, M. J. *Inorg. Chim. Acta.* **1978**, *31*, 1413.
57. Hentges, S. G.; Sharpless, K. B. *J. Am. Chem. Soc.* **1980**, *102*, 4263.
58. (a) Oishi, T.; Hirama, M. *Tetrahedron Lett.* **1992**, *49*, 10793 ; (b) Imada Y.; Saito, T.; Kawakami, T.; Murahashi, S.-I. *Tetrahedron Lett.* **1992**, *33*, 5081.
59. (a) Johnson, R.A.; Sharpless, K. B. *Catalytic Asymmetric Dihydroxylation in Catalytic Asymmetric synthesis*; Ojima, I., Ed.; VCH Publishers; New York **1993**, pp 227 ; (b) Tokles, M.; Snyder, J. K. *Tetrahedron Lett.* **1986**, *27*, 3951 ; (c) Loharay, B.B. *Tetrahedron: Asymmetry* **1992**, *3*, 1306 ; (d) Hanessian, S.; Meffre,



- P.; Girarad, M.; Beaudoin, S.; Scanceau, J.-Y.; Bennani, Y. L. *J. Org. Chem.* **1993**, *58*, 1991 ; (e) Corey, E. J.; Jardine, P. D.; Virgil, S.; Yuen, P.-W.; Connell, R. D. *J. Am. Chem. Soc.* **1989**, *111*, 9243 ; (f) Tomioka, K.; Nakajima, M.; Koga, K. *J. Am. Chem. Soc.* **1987**, *109*, 6213 ; (g) Tomioka, K.; Nakajima, M.; Iitaka, Y.; Koga, K. *Tetrahedron Lett.* **1988**, *29*, 573 ; (h) Tomioka, K.; Nakajima, M.; Koga, K. *Tetrahedron Lett.* **1996**, *31*, 1741 ; (i) Fuji, K.; Tanaka, K.; Miyamoto, H. *Tetrahedron Lett.* **1992**, *33*, 4021 ; (j) HIRAMA, M.; Oishi, T.; Ito, S. *J. Chem. Soc., Chem. Commun.* **1989**, 665 ; (k) Oishi, T.; HIRAMA, M. *J. Org. Chem.* **1989**, *54*, 5834 ; (l) Yamada, T.; Narasaka, K. *Chem. Lett.* **1986**, 131.
60. (a) Criegee, R. *Justus Leibigs Ann. Chem.* **1936**, *522*, 75 ; (b) Criegee, R. *Angew. Chem.* **1937**, *50*, 153 ; (c) Criegee, R. *Angew. Chem.* **1938**, *51*, 519 ; (d) Criegee, R.; Marchand, B.; Wannowias, H. *Justus Leibigs Ann. Chem.* **1942**, *550*, 99. The [3+2] mechanism was proposed by Boseken ; (e) Boseken, J. *Recl. Trav. Chim.* **1922**, *41*, 199. For the [2+2] mechanism, see: (f) Sharpless, K. B.; Teranishi, A. Y.; Backvall, J.-E. *J. Am. Chem. Soc.* **1977**, *99*, 3120 ; (g) Jorgensen, K. A.; Schiott, B. *Chem. Rev.* **1990**, *90*, 1483.
61. Gobel, T.; Sharpless, K. B. *Angew. Chem., Int. Ed. Engl.* **1993**, *32*, 1329.
62. Wai, J. S. M.; Marko, I.; Svendsen, J. S.; Fimm, M. G.; Jacobsen, E. N.; Sharpless, K. B. *J. Am. Chem. Soc.* **1989**, *111*, 1123.
63. Kwong, K.-L.; Sorto, C.; Ogino, Y.; Chen, H.; Sharpless, K. B. *Tetrahedron Lett.* **1990**, *31*, 2999.

64. Sharpless, K. B.; Amberg, W.; Bennani, Y. L.; Crispino, G. A.; Hartung, J.; Jeong, K.-S.; Kwong, H.-L.; Morikawa, K.; Wang, Z.-M.; Xu, D.; Zhang, X.-L. *J. Org. Chem.* **1992**, *57*, 2768.
65. Sharpless, K. B.; Amberg, W.; Bennani, Y. L.; Crispino, G. A.; Hartung, J.; Jeong, K.-S.; Kwong, H.-L.; Morikawa, K.; Wang, Z.-M.; Xu, D.; Zhang, X.-L. *J. Org. Chem.* **1992**, *57*, 2768.
66. (a) Kolb, H. C.; Andersson, P. G.; Sharpless, K. B. *J. Am. Chem. Soc.* **1994**, *116*, 1278 ; (b) Sharpless, K. B.; Amberg, W.; Bennani, Y. L.; Crispino, G. A.; Hartung, J.; Jeong, K.-S.; Kwong, H.-L.; Morikawa, K.; Wang, Z.-M.; Xu, D.; Zhang, X.-L. *J. Org. Chem.* **1992**, *57*, 2768 ; (c) Vanhessche K. P. M.; Sharpless, K. B. *J. Org. Chem.* **1996**, *61*, 7978.
67. Sharpless, K. B.; Amberg, W.; Bennani, Y. L.; Crispino, G. A.; Hartung, J.; Jeong, K.-S.; Kwong, H.-L.; Morokawa, K.; Wang, Z.-M.; Xu, D.; Zhang, X.-L. *J. Org. Chem.* **1992**, *57*, 2768.
68. Kolb, H. C.; Andersson, P. G.; Bennani, Y. L.; Crispino, G. A.; Jeong, K.-S.; Kwong, H.-L.; Sharpless, K. B. *J. Am. Chem. Soc.* **1993**, *115*, 12226.
69. Becker, H.; Sharpless, K. B. *Angew. Chem. Int. Ed. Engl.* **1996**, *35*, 448.
70. Crispino, G. A.; Jeong, K.-S.; Kolb, H. C.; Wang, Z.-M.; Xu, D.; Sharpless, K. B. *J. Org. Chem.* **1993**, *58*, 3785.
71. Becker, H.; King, S. B.; Taniguchi, M.; VanHessche, K. P. M.; Sharpless, K. B. *J. Org. Chem.* **1995**, *60*, 3940.
72. Wang, L.; Sharpless, K. B. *J. Am. Chem. Soc.* **1992**, *114*, 7568.
73. Wang, Z.-M.; Kakiuchi, K.; Sharpless, K. B. *J. Org. Chem.* **1994**, *59*, 6895.

74. (a) Baker, W.; Field, F.B. *J. Chem. Soc.* **1932**, 86 ; (b) Catlson, W. W.; Cretcher, L. H. *J. Am. Chem. Soc.* **1947**, 69, 1952.
75. Gao, Y.; Sharpless, K. B. *J. Am. Chem. Soc.* **1988**, 110, 7538.
76. For a review of cyclic sulfites/sulfates, see: (a) Lohray, B. B. *Synthesis* **1992**, 1035. (b) Lohray, B. B.; Bhushan, V. *Adv. Heterocycl. Chem.* **1997**, 68, 89.
77. Shellhamer, D. F.; Anstine, D. T.; Gallego, K. M.; Ganesh, B. R.; Hanson, A. A.; Hanson, K. A.; Henderson, R. D.; Prince, J. M.; Heasley, V. L. *J. Chem. Soc., Perkin Trans 2* **1995**, 861.
78. For a comprehensive review of organic sulfites see: Van woerden, H. F. *Chem. Rev.* **1963**, 63, 557.
79. King, S. A.; Pipik, B.; Conlon, D. A.; Bhupamy, M. *Synth. Commun.* **1997**, 27, 701.
80. (a) Jones, J. K. N.; Perry, M. B.; Turner, J. C. *Can. J. Chem.* **1960**, 38, 1122 ; (b) Bragg, P. D.; Jones, J. K. N.; Yurner, J. C. *Can. J. Chem.* **1959**, 37, 1412.
81. (a) Denmark, S. E. *J. Org. Chem.* **1981**, 46, 3144 ; (b) Lowe, G.; Salamone, S. J. *J. Chem. Soc. Chem. Commun.* **1983**, 1392.
82. Gao, Y.; Sharpless, K. B. *J. Am. Chem. Soc.* **1988**, 110, 7538.
83. Gao, Y.; Zepp, C. M. *Tetrahedron Lett.* **1991**, 52, 3155.
84. Vanhessche, K.; Van der Eycken, E.; Vanderwalk, M.; Roper, H. *Tetrahedron Lett.* **1990**, 31, 2337.
85. Gao, Y.; Zepp, C. M. *Tetrahedron Lett.* **1991**, 52, 3155.
86. Vanhessche, K.; Van der Eycken, E.; Vanderwalk, M.; Roper, H. *Tetrahedron Lett.* **1990**, 31, 2337.

87. Lohray, B. B.; Gao, Y.; Sharpless, K. B. *Tetrahedron Lett.* **1989**, 30, 2623
88. (a) Kalantar, T. H.; Sharpless, K. B. *Acta. Chem. Scand.* **1993**, 47, 307. (b) Gao, Y.; Zepp, C. M.; *Tetrahedron Lett.* **1991**, 32, 3155.
89. Tomalia, D. A.; Falk, J. C. *J. Heterocycl. Chem.* **1972**, 9, 891.
90. Pilkington, M.; Wallis, J. D. *J. Chem. Soc. Chem. Commun.* **1993**, 1857.
91. Bates, R. W.; Fernandez-Moro, R.; Lay, S. V. *Tetrahedron Lett.* **1991**, 32, 2651.
92. Vanderklein, P. A. M.; de Nooy, A. E. J.; vander Marel, G. A.; van Boom, J. H. *Synthesis* **1991**, 347.
93. Harcken, C.; Bruckner, R. *New J. Chem.* **2001**, 25, 40.
94. Kim, N. S. Choi, J. R.; Cha, J. K. *J. Org. Chem.* **1993**, 58, 7096.
95. Bonini, C.; Chiummiento, L.; Bonis, M. D.; Funicello, M.; Lupattelli, P. *Tetrahedron Lett.* **2004**, 45, 2797.
96. S. K. Pandey.; Subba Rao, K. V.; Kumar, P. *Tetrahedron Lett.* **2004**, 45, 5877.
97. Fernandes, R. A.; Kumar, P. *Tetrahedron* **2002**, 58, 6685.
98. Gupta, P.; Fernandes, R. A.; Kumar, P. *Tetrahedron Lett.* **2003**, 44, 4231.
99. Fernandes, R. A.; Kumar, P. *Tetrahedron Asymmetry* **1999**, 10, 4349.
100. Naidu, S. V.; Kumar, P. *Tetrahedron Lett.* **2003**, 44, 1035.
101. Li, G.; Chang, H.-T., and Sharpless, K. B. *Angew. Chem. Int. Ed. Engl.* **1996**, 35, 451.
102. Reiser, O. *Angew. Chem. Int. Ed. Engl.* **1996**, 35, 1308.
103. Bergmier, S. C. *Tetrahedron* **2000**, 56, 2561.
104. Tao, B.; Schlingloff, G.; Sharpless, K. B. *Tetrahedron Lett.* **1998**, 39, 2507.
105. Kolb, H. C.; Sharpless, K. B. *Transition Metals for Organic Synthesis, Eds.*

- Beller, M.; Bolm, C. Wiley-VCH, Weinheim, **1998**, 2, 243.
106. Sharpless, K. B.; Li, G. G. USP 5 767 304/1997
107. Han, K.; Cho, C.-W.; Janda, K. D. *Chem. Eur. J.* **1999**, 5, 1565.
108. (a) Sharpless, K. B.; Fokin, V. V. USP 6, 350, 905/2002 (*Chem Abstr.*, 134, 178, 819) ; (b) Rudolph, J.; Sennhenn, P. C.; Vlaar, C. P.; Sharpless, K. B. *Angew. Chem. Int. Ed. Engl.*, **1996**, 35, 2810.
109. (a) Sharpless, K. B.; Chong, A. O.; Oshima, K. *J. Org. Chem.* **1976**, 41, 177 ; (b) Herranz, E.; Sharpless, K. B. *J. Org. Chem.* **1978**, 43, 177 ; (c) Herranz, E.; Biller, S. A.; Sharpless, K. B. *J. Am. Chem. Soc.* **1978**, 100, 3596 ; (d) Herranz, E.; Sharpless, K. B. *J. Org. Chem.* **1980**, 45, 2710.
110. Rudolph, J.; Sennehenn, P. C.; Vlaar, C. P.; Sharpless, K. B. *Angew. Chem. Int. Ed. Engl.* **1996**, 35, 2810.
111. (a) Sharpless, K. B.; Chong, A. O.; Oshima, K.; *J. Org. Chem.* **1976**, 41, 177 ; (b) Back, J. E.; Oshima, K.; Palermo, R. E.; Sharpless, K. B. *J. Org. Chem.* **1979**, 44, 1953 ; (b) Ji, S.; Gantler, L. B.; Waring, A.; Battisti, A.; Bank, S.; Closson, W. D. *J. Am. Chem. Soc.* **1967**, 89, 5311.
112. Gold, E. H. Babad, *J. Org. Chem.* **1972**, 37, 2208.
113. Li, G.; Sharpless, K. B. *Acta Chem. Scand.* **1996**, 50, 649.
114. Andersson, M. A.; Epple, R. Fokin, V. V.; Sharpless, K. B. *Angew. Chem. Int. Ed. Engl.*, **2002**, 41, 472.
115. Li, G.; Angert, H. H.; Sharpless, K. B. *Angew. Chem. Int. Ed. Engl.*, **1996**, 35, 2813.

116. Green, T. W.; Wuts, P. G. M. *Protective Groups in Organic Synthesis*, Wiley & Sons Inc., New York, 2<sup>nd</sup> edn., 1991.
117. (a) O'Brien, P. *Angew. Chem. Int. Ed. Engl.*, **1999**, *38*, 326 ; (b) O'Brien, P.; Osborne, S. A.; Parker, D. D. *J. Chem. Soc. Perkin Trans.* **1998**, *1*, 2519 ; (c) O'Brien, P.; Osborne, S. A.; Parker, D. D. *Tetrahedron Lett.* **1998**, *39*, 4099.
118. Brucncko, M.; Schlingolff, G.; Sharpless, K. B. *Angew. Chem. Int. Ed. Engl.*, **1997**, *36*, 1483.
119. Wallis, E. S.; Lane, J. F. in *Organic reactions*, ed. R. Adams, Wiley & Sons, Inc,
120. Corey, E. J.; Noe, M. C. *J. Am. Chem. Soc.* **1996**, *118*, 11038.
121. Han, H.; Yoon, J.; Janda, K. D. *J. Org. Chem.* **1998**, *63*, 2045.
122. Morgan, A. J.; Masse, C. E.; Panek, J. S. *Org. Lett.* **1999**, *1*, 1949.
123. (a) Donohoe, T. J.; Johnson, P. D.; Helliwell, M.; Keenan, M. *Chem. Commun.* **2001**, 2078 ; (b) Donohoe, T. J.; Johnson, P. D.; Cowley, A.; Keenan, M. *J. Am. Chem. Soc.* **2002**, *124*, 12934 ; (c) Donohoe, T. J.; Johnson, P. D.; Pye, R. J.; Keenan, M. *Org. Lett.* **2004**, *6*, 2583.
124. Blakemore, P. R.; Schulze, V. K.; White, J. D. *Chem. Commun.* **2000**, 1263.
125. Haukaas, M. H.; O'Doherty, G. *Org. Lett.* **2001**, *3*, 401.
126. Panek, J. S.; Masse, C. E. *Angew. Chem. Int. Ed.* **1999**, *38*, 1093.
127. Masse, C. E.; Panek, J. S.; Morgan, A. J. *Org. Lett.* **2000**, *2*, 2571.
128. Chandrasekhar, S.; Mohapatra, S.; Yadav, J. S. *Tetrahedron* **1999**, *55*, 4763.
129. Runcko, M.; Schlingloff, G.; Sharpless, K. B. *Angew. Chem. Int. Ed.* **1997**, *36*, 1483.
130. Chikkanna, D.; Han, H. *Synlett* **2005**, *13*, 2311.

131. Kondekar, N. B.; Subba Rao, K. V.; Kumar, P. *Tetrahedron Lett.* **2004**, *45*, 5477.

## 3.1 SECTION A: ENANTIOSELECTIVE SYNTHESIS OF (-)- $\alpha$ -CONHYDRINE

---

### 3.1.1 Introduction

Alkaloid mimics with a nitrogen in the ring, including naturally occurring and synthetic monocyclic and bicyclic derivatives, constitute a realm of important functional molecules which have drawn considerable attention by virtue of their potent and varied biological activities.<sup>1</sup> A search of the chemical and patent literatures reveal thousands of references concerning this simple ring system, both in clinical and pre-clinical states. Due to the extension of life expectancy in industrial countries, neurological disorders, like Alzheimer's or Parkinson's disease pose an important public health problem. Thus, the discovery of effective agents for the treatment of these pathologies is one of the major challenges in medicine for the future.

Biologically active alkaloids containing a 2-(1-hydroxyalkyl) piperidine unit **1** are abundant in nature.<sup>1</sup> Conhydrine **2** and **3**, is one such compound which falls into hydroxy alkyl piperidine category (**Fig. 1**), conhydrine was isolated from seeds and leaves of the poisonous plant *Conium maculatum* L<sup>2</sup> in 1856 and elucidation of its structure was made in 1933,<sup>3</sup> whose extracts were used in the ancient Greece for the execution of criminals. The indolizidine alkaloids castanospermine **4**, slaframine **5** and swainsonine **6** also fall into this category and have attracted considerable attention from the synthetic community due to their antiviral and antitumor activities.<sup>4</sup> (**Fig. 1**) It is believed that Socrates was a stone mason by trade and was also a hoplite in the Athenian military and was accused of



impiety and of neglect of the Gods whom the city worships and the practice of religious novelties and of the corruption of young. In the trial which followed Socrates was condemned to death. At that time it was considered a humane method of execution for the condemned person to drink a potent solution from the hemlock plant. Socrates was thus expected to take his own life in this way, which being a man of honour, he did.

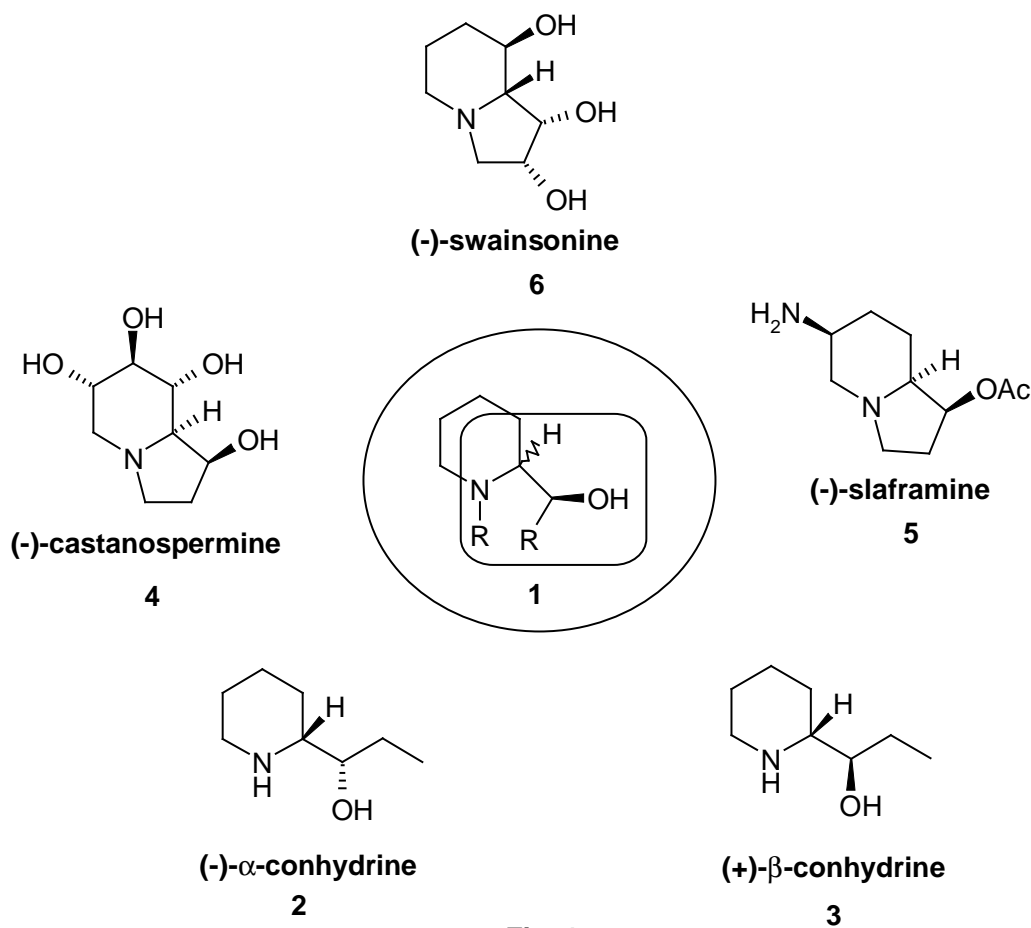

Fig. 1

### 3.1.2 Review of Literature

Many synthetic approaches have been documented in the literature for (+)-α-conhydrine,<sup>5</sup> and (+)-β-conhydrine based on either resolution method or auxiliary supported procedure,<sup>6</sup> or chiral pool approaches,<sup>7</sup> but less attention has been paid to (-)-α-conhydrine **2**. The first asymmetric synthesis of (-)-α-conhydrine **2**

and its structural assignment has been reported by Enders *et al.*<sup>8</sup> using his RAMP/SAMP hydrazone methodology. Some of the interesting syntheses of  $\alpha$  and  $\beta$ -conhydrine are described below.

**Enders *et al.* (2002)<sup>8</sup>**

The first asymmetric synthesis of the conium alkaloid (-)- $\alpha$ -conhydrine **2** has been achieved by Enders *et al.* based on his RAMP/SAMP methodology.<sup>8</sup> Towards this end iodo acetal **11** was first prepared from 4-bromo-butyric acid ester **7** by DIBAL-H reduction to the aldehyde **8** followed by acetalization to **9** and subsequent Finkelstein reaction with lithium iodide led to the desired iodide **10**. The required acetal containing organolithium reagent was prepared by halogen-metal exchange reaction from the corresponding iodoacetal **11** following the procedure of Negishi and Bailey<sup>9</sup> (Scheme 1). The enantiopure TBS-protected glycol aldehyde SAMP hydrazone **12** which was prepared from (*Z*)-butenediol was alkylated at low temperature to give **13**. Diastereoselective 1,2 addition of **11** to this compound gave **12**. Removal of the remaining part of the auxiliary was facilitated by a reductive nitrogen-nitrogen bond cleavage followed by reduction with NaBH<sub>4</sub> to give (-)- $\alpha$ -conhydrine **2** (Scheme 2).

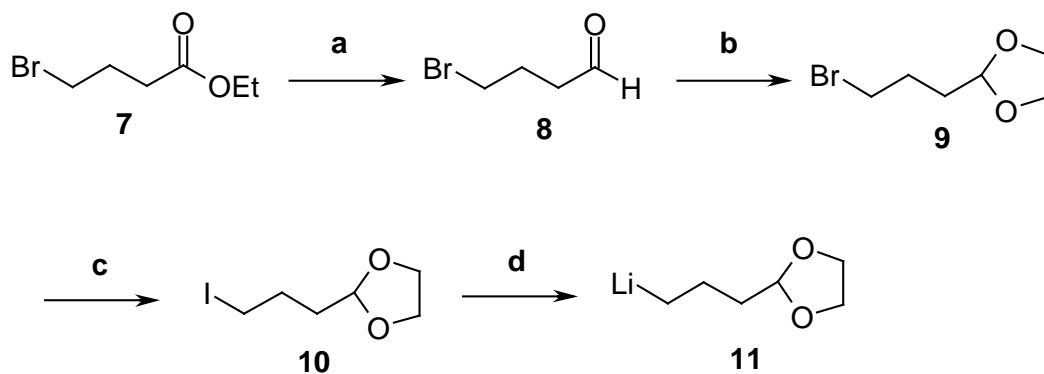

**Scheme 1**

**Scheme 1 : Reaction conditions :** (a) DIBAL-H, Et<sub>2</sub>O, -78 °C, 99% ; (b) 1,2-ethane diol, toluene, *p*-TSA, reflux, 90% ; (c) LiI, THF, reflux, 68% ; (d) *t*-BuLi, Et<sub>2</sub>O, -78 °C-0 °C.

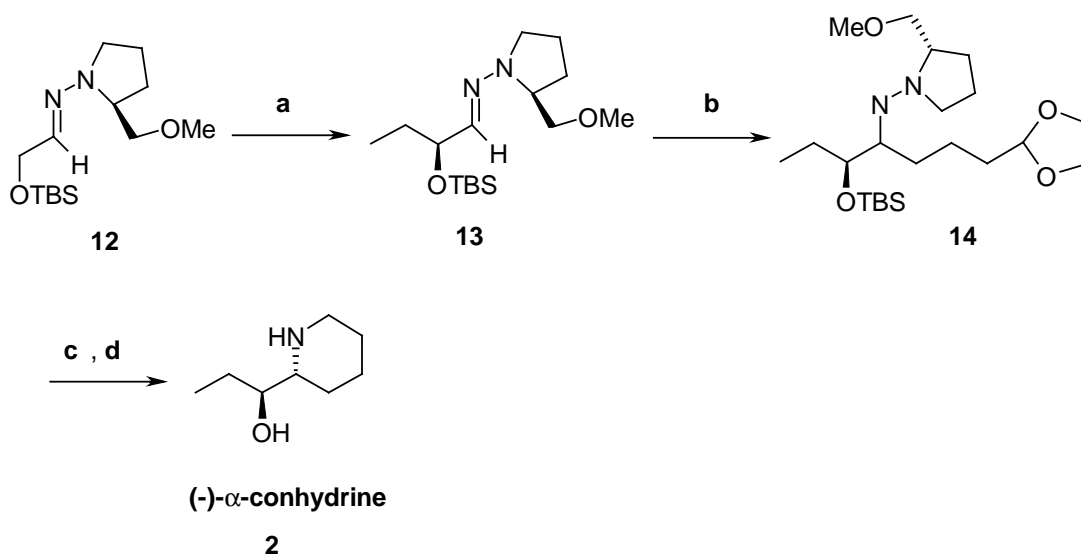

**Scheme 2**

**Scheme 2 : Reaction conditions :** (a) LDA, THF, -78 °C, then EtI, -78 °C ; (b) compound **11**, THF, then, NaHCO<sub>3</sub> (aq) ; (c) BH<sub>3</sub>·THF, THF, reflux, then 3M HCl (aq), CH<sub>2</sub>Cl<sub>2</sub>, rt ; (d) NaBH<sub>4</sub>, EtOH, rt.

**Comins et al. (2000)** <sup>6b</sup>

Comins and co-workers have developed an iodocyclocarbamation procedure for the stereoselective preparation of (+)-α-conhydrine **ent-2**. *Cis*-propenyl magnesium bromide was added to a mixture of 4-methoxy-3-(triisopropyl)pyridine and chloroformate of (-)-TCC to give **16**. One-pot removal of the

chiral auxiliary and TIPS groups gave enantiopure dihydropyridone **17**. Treatment of **17** with benzyl chloroformate provided the intermediate **18**. Conjugate addition of **18** with L-selectride followed by addition of *N*-(5-chloro-2-pyridyl)triflimide afforded vinyl triflate **19** which was subjected to the iodocyclocarbamation reaction to give **20**. Dehydrohalogenation of **20** was carried out to afford an enol carbamate **21**. Catalytic hydrogenation of **21** from the convex face gave the desired oxazolidinone **22** which was hydrolyzed to afford **ent-2**.

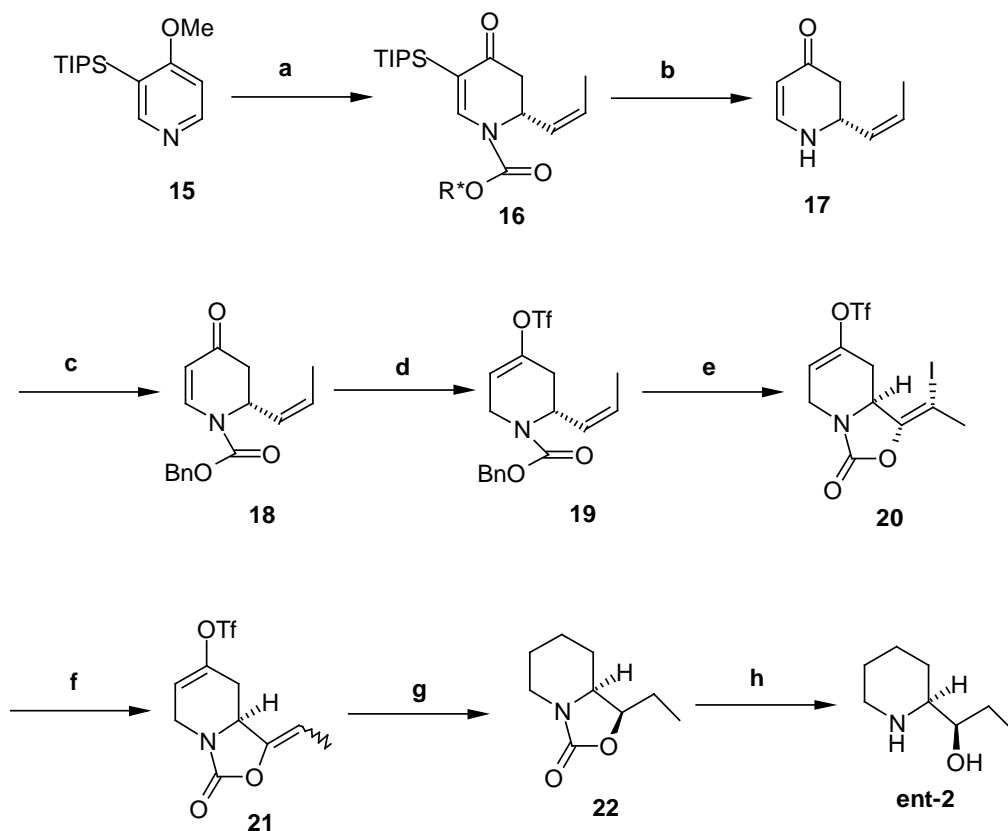

**Scheme 3**

**Scheme 3 : Reaction conditions :** (a) (-)-TCCOCOC1, C<sub>3</sub>H<sub>5</sub>Cl, H<sub>3</sub>O<sup>+</sup>, 78% ; (b) (i) NaOMe, MeOH, reflux, (ii) 10% HCl, 80% ; (c) *n*-BuLi, BnOCOCl, 85% ; (d) L-selectride, *N*-(5-chloro-2-pyridyl)triflimide, 80% ; (e) Li<sub>2</sub>CO<sub>3</sub>, I<sub>2</sub>, CH<sub>3</sub>CN, 70% ; (f) BDU, THF, rt, 2 h, 99% ; (g) H<sub>2</sub>, PtO<sub>2</sub>, Li<sub>2</sub>CO<sub>3</sub>, iodine, EtOAc, 78% ; (h) KOH, EtOH, reflux, 79%.

Masaki *et al.* (1989)<sup>7d</sup>

Enantiospecific synthesis of (+)- $\beta$ -conhydrine **3**, was achieved via partial ring opening of 6,8-dioxabicyclo[3.2.1]-octane skeleton **25** prepared from (*S,S*)-tartaric acid **23**. Compound **25** was converted into epoxide **27** through mesylate and subsequently homologated with Gillman's reagent on the terminal position of the epoxide **27** followed by protection of the free alcohol as benzyl ether and oxidation of acetal portion to afford the lactone **29**. Methanolysis of **29** followed by the Mitsunobu type reaction of the ester-alcohol using hydrazoic acid gave the azide ester **31**. Reduction of azido group and subsequent cyclization of the intermediate amino ester **31** gave lactam **32**. Reduction of the lactam **32** with  $\text{LiAlH}_4$  afforded *O*-benzyl conhydrine which was deprotected by hydrogenolysis to give (+)- $\beta$ -conhydrine **3**. (**Scheme 4**)

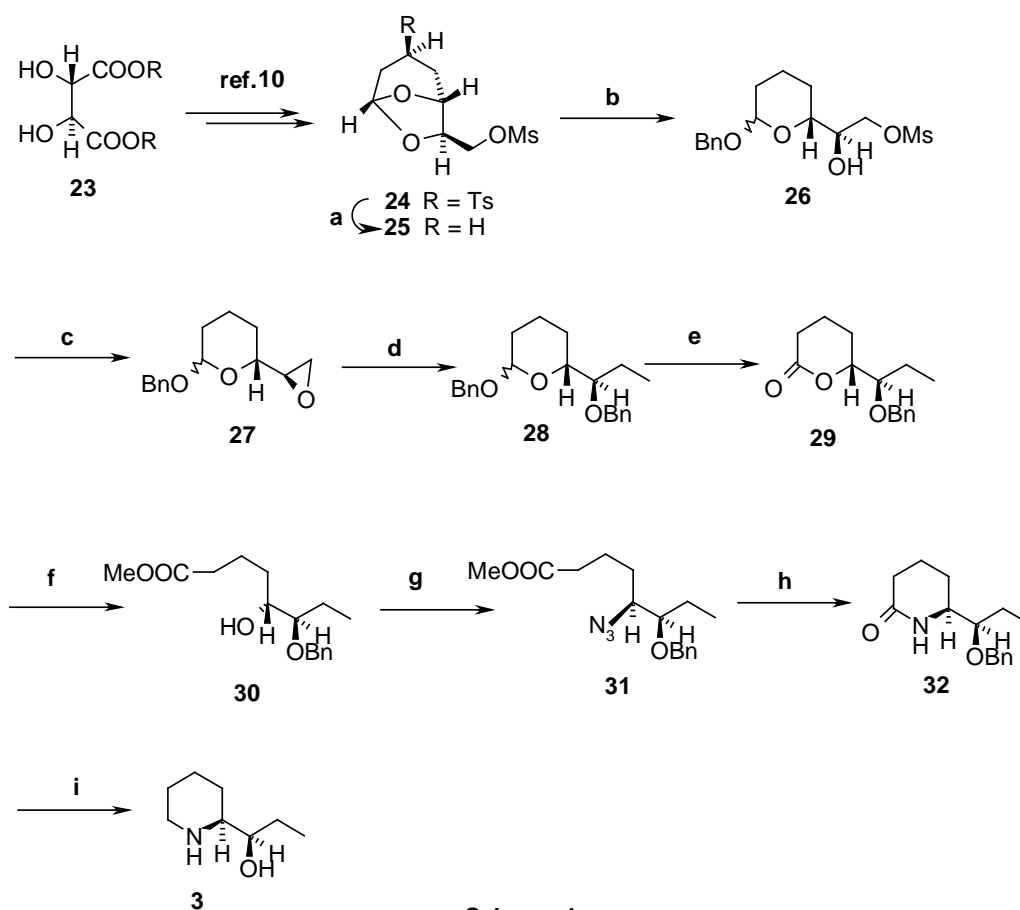

**Scheme 4 : Reaction conditions :** Na (10 equiv)/EtOH (10 equiv)/THF/-20 °C/2 h, 78% ; (b) PhCH<sub>2</sub>OH, BF<sub>3</sub>.Et<sub>2</sub>O (2eq), rt, 15 h, 74% ; (c) K<sub>2</sub>CO<sub>3</sub>, MeOH, 0 °C, 0.5 h, 92% ; (d) (i) Me<sub>2</sub>CuLi, Et<sub>2</sub>O, -50 °C, 4 h, 90% ; (ii) NaH, PhCH<sub>2</sub>Br, DME, rt, 15 h, 79% ; (e) (i) MCPBA, BF<sub>3</sub>.Et<sub>2</sub>O (cat), CH<sub>2</sub>Cl<sub>2</sub>, rt, 2 h, (ii) Et<sub>3</sub>N, 0 °C, 1.5 h, 75% ; (f) K<sub>2</sub>CO<sub>3</sub>, MeOH, 0 °C, 2 h (quant) ; (g) HN<sub>3</sub>, Ph<sub>3</sub>P, DEAD, Benzene, rt, 2 h, 75% ; (h)

(i) H<sub>2</sub>/Pd-black, MeOH, (ii) toluene, 120 °C, 15 h, 82% ; (i) (i) LiAlH<sub>4</sub>, THF, rt, 0.5 h, 80% ; (ii) H<sub>2</sub>/C, 5% Pd-C, EtOH, Conc. HCl (cat), 88%.

**Couty *et al.* (2001)<sup>7c</sup>**

Couty and group developed a synthetic route based on *N*-Boc-2-acyloxazolidene chemistry combined with ring closing metathesis for a 2-(1-hydroxyalkyl) side chain which is commonly found in natural alkaloids.

Weinreb amide **35** derived from (*S*)-phenyl **Scheme 5 : Reaction conditions** : (a) (i) Ethyl oxalate (ii) (Boc)<sub>2</sub>O (iii) LiOH, 77% overall ; (b) Isobutyl chloroformate, NHMe(OMe), HCl, 79% ; (c) Ethyl

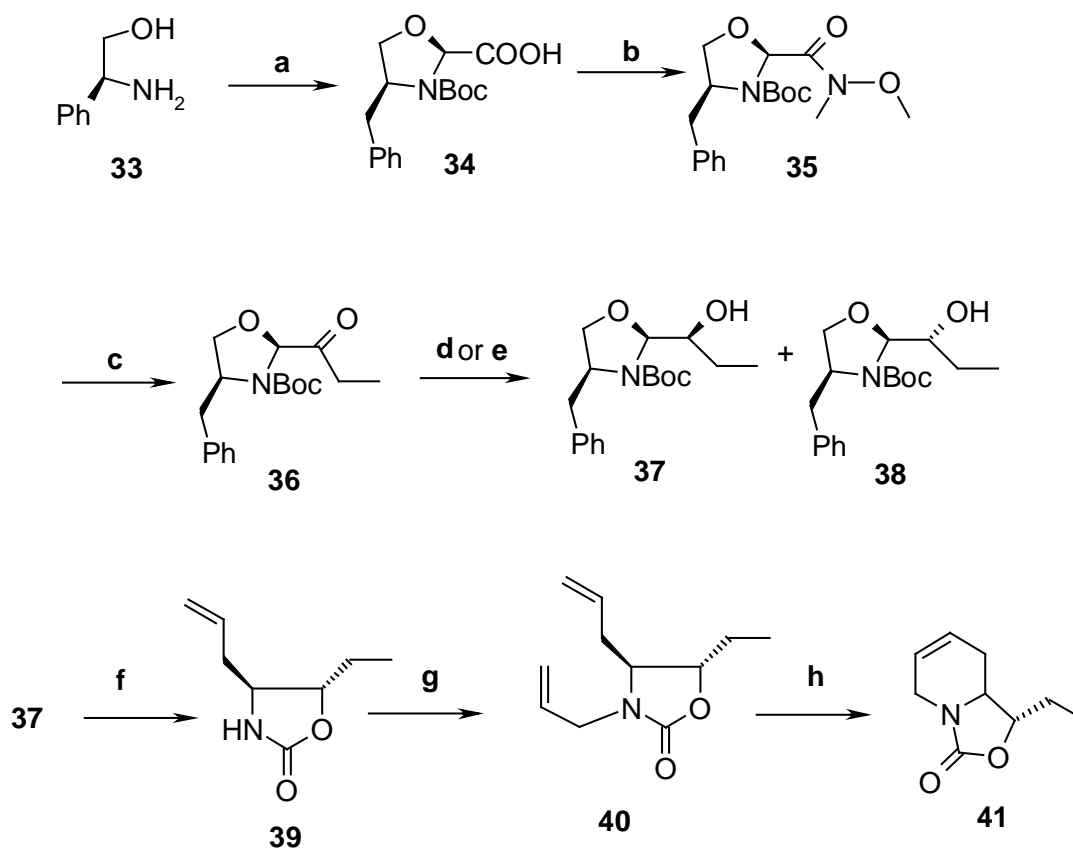

**Scheme 5**

magnesium bromide, Et<sub>2</sub>O, rt, 75% ; (d) NaBH<sub>4</sub>, EtOH, -78 °C, 72% ; (e) NaBH<sub>4</sub>, EtOH, CeCl<sub>3</sub>, -78 °C, 54% ; (f) Na, EtOH, THF, NH<sub>3</sub>, 93% ; (g) NaH, DMF, C<sub>3</sub>H<sub>5</sub>Br, 74% ; (h) Grubb's catalyst, CH<sub>2</sub>Cl<sub>2</sub>, reflux, 79%.

alaninol was stereoselectively reduced. Treatment of isomeric alcohol **37** with NaH led to transcarbamation product **39** which was subjected to *N*-alkylation with corresponding olefin chain followed by ring closing

metathesis to give bicyclic oxazolidinone **41** which is a common structural pattern for conhydrine and its analogue.

**Husson *et al.* (1985) <sup>6a</sup>**

Husson *et al.* described the enantiospecific synthesis of (+)- $\beta$ -conhydrine **3** using 2-cyano-6-oxazolo-piperidine **42**. Preparation of the anion using LDA and its reaction with propan-1-al led to the formation of a single product **43**. The complete reduction of **43** using NaBH<sub>4</sub> was stereospecific giving the amino alcohol **44**, which was cleanly debenzylated to (+)- $\beta$ -conhydrine **3**. An alternative route to **3** was the chemoselective decyation of aminonitrile **43**. Reaction of **43** with Zn(BH<sub>4</sub>)<sub>2</sub> at -60 °C in THF after complexation of the cyano group with AgBF<sub>4</sub> afforded **45**. The same product was also obtained using liq Na/NH<sub>3</sub>. Finally, hydrogenolytic cleavage of the *N*-benzyl and aminoether groups gave (+)- $\beta$ -conhydrine **3**.

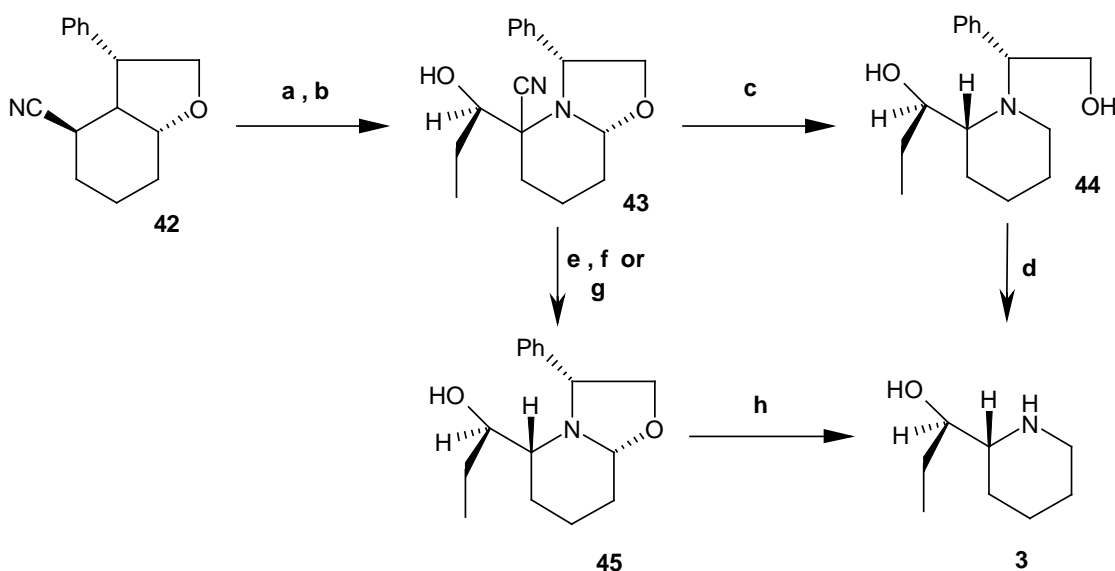

**Scheme 6**

**Scheme 6 : Reaction conditions :** (a) LDA, THF, -78 °C, 30 min ; (b) C<sub>2</sub>H<sub>5</sub>CHO, THF, -78 °C, 5 min ; (c) NaBH<sub>4</sub>, EtOH, reflux, 5 h ; (d) H<sub>2</sub>, Pd/C 5 % ; MeOH, 15 h ; (e)



$\text{AgBF}_4$ , THF, rt, 10 min. ; (f)  $\text{Zn}(\text{BH}_4)_2$ , THF,  $-60^\circ\text{C}$ , 1 h ; (g) Na, liq.  $\text{NH}_3$ ,  $-78^\circ\text{C}$ , 1 h ;  
 (h)  $\text{H}_2$ ,  $\text{Pd}(\text{OH})_2$ , MeOH, 4 days.

**Kumar *et al.* (2005)<sup>5c</sup>**

Very recently, Kumar *et al.* described a general strategy for all the isomers of conhydrine by diastereoselective alkylation of an amino aldehyde derivative **47** with ethylmagnesium bromide and diethylzinc.

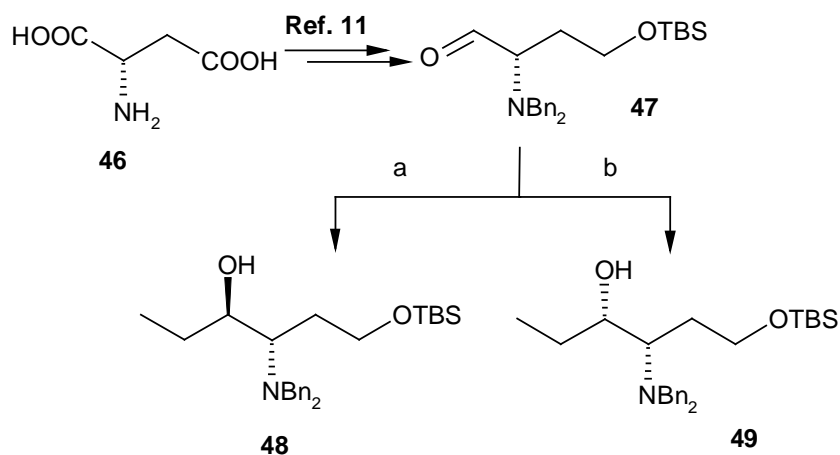

**Scheme 7 : Reaction conditions:** (a)  $\text{EtMgBr}$ , dry  $\text{Et}_2\text{O}$ ,  $0^\circ\text{C}$ , 2 h, 73% ; (b)  $\text{Et}_2\text{Zn}$ , toluene,  $0^\circ\text{C}$ , 8 h, 76%.

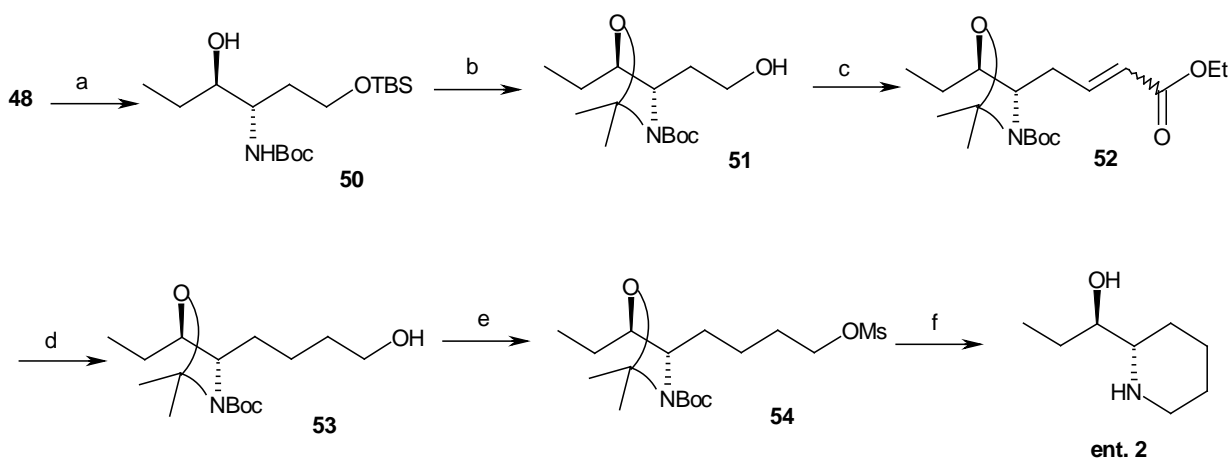

**Scheme 8 : Reaction conditions :** (a)  $H_2/Pd(OH)_2$ ,  $Boc_2O$ ,  $EtOAc$ , 12 h, 83% ; (b) 2,2-DMP, *p*-TsOH,  $CH_2Cl_2$ , 0 °C-rt, 1 h, 87% ; (c) (i)  $(COCl)_2$ , DMSO, dry  $CH_2Cl_2$ , -78 °C,  $Et_3N$ , -60 °C, 1 h (ii)  $Ph_3P=CHCOOEt$ , dry THF, rt, 24 h, 96% ; (d)  $LiAlH_4$ , dry THF, rt, 4 h, 78% ; (e)  $MsCl$ ,  $Et_3N$ , -78 °C, 1 h ; (f)  $CF_3COOH$ , dry DCM, 88%.

### 3.1.3 Present work

#### *Objective*

**The advent of Sharpless asymmetric dihydroxylation (AD)<sup>12</sup> greatly facilitated the synthesis of optically active dihydroxy compounds that serve as important synthons to a vast array of natural products. This section discloses a new approach from chiral dihydroxy compounds to poisonous alkaloid (-)- $\alpha$ -conhydrine 2. We have employed two different synthetic strategies towards the target molecule depending on the olefinic substrates chosen. The key steps are asymmetric dihydroxylation, regioselective opening of cyclic sulfate and Wittig olefination.**

**The retrosynthetic analysis of (-)- $\alpha$ -conhydrine 2 is shown in Scheme 9. Compound 55 is the ultimate precursor to obtain the target molecule and it can be derived from two different fragments 56 and 58, prepared by two different synthetic strategies. The Boc protected amino alcohol ester 56 could be obtained from regioselective opening of a cyclic sulfate 59 which in turn could be obtained from the Sharpless asymmetric dihydroxylation of  $\alpha$ ,  $\beta$ -unsaturated ester 63 which can be derived from propionaldehyde 64. In the second synthetic route, compound 58 could be derived from azido benzyldiene 61 which in turn would be obtained from Sharpless asymmetric dihydroxylation of allylic alcohol 67.**

The common fragment, salt **57** could be prepared from bromo propanol which in turn would be obtained from 1,3-propanediol **60**.

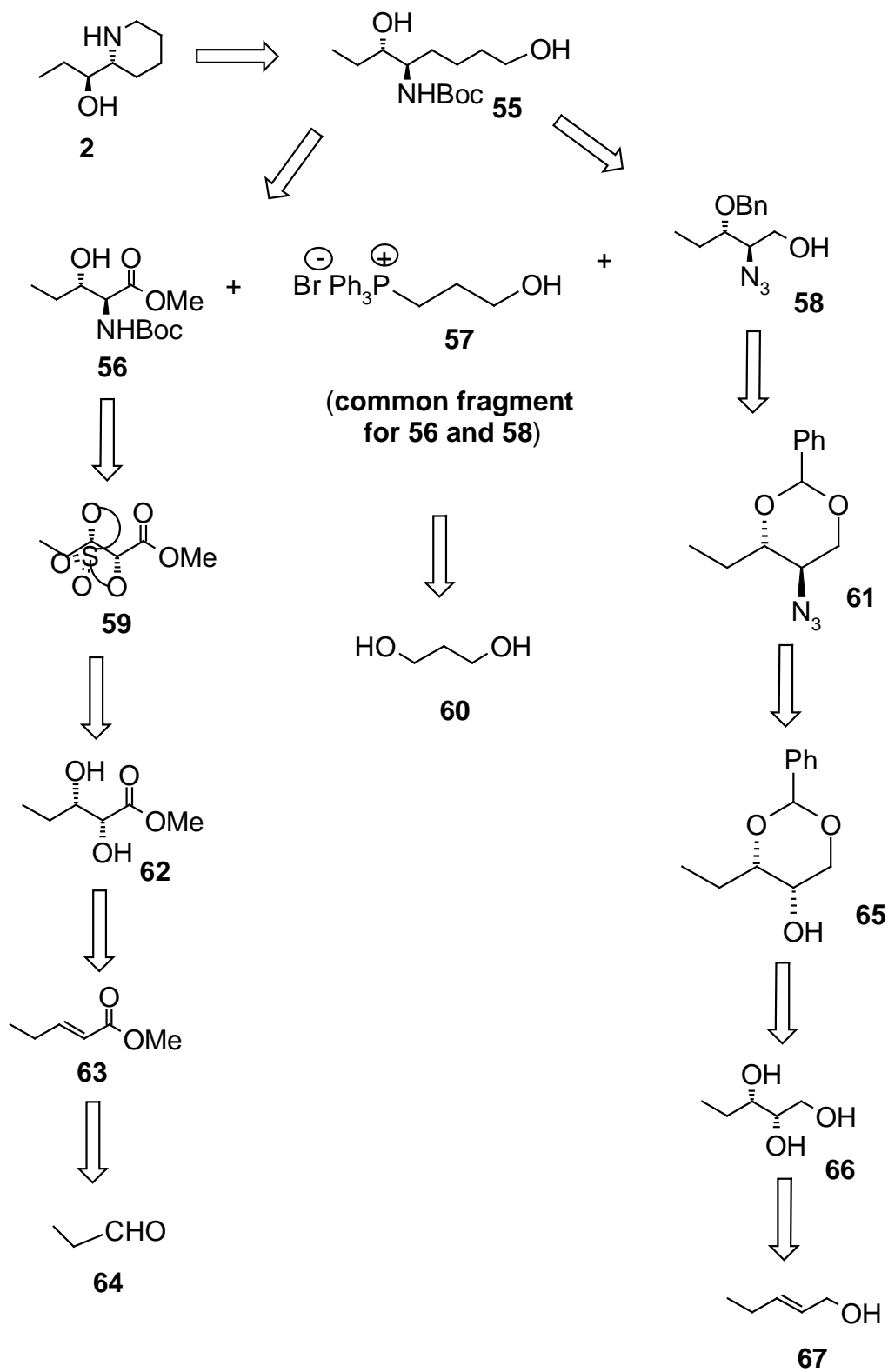

**Scheme 9 : Retrosynthetic analysis of (-)- $\alpha$ -conhydrine**

### 3.1.4 Results and Discussion

The detailed synthetic strategy involving AD and regiospecific opening of cyclic sulfate by nucleophile as key steps is illustrated in **Scheme 10**.

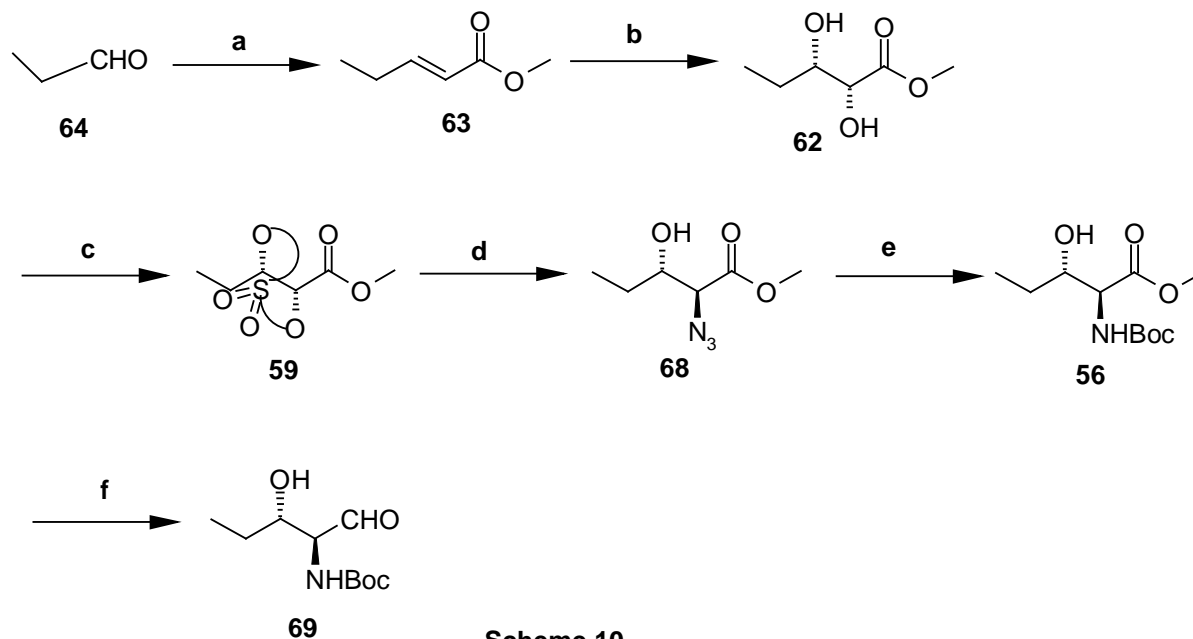

**Scheme 10. Reaction conditions :** (a)  $\text{Ph}_3\text{P}=\text{CHCOOMe}$ , benzene, reflux, 2 h, 85% ; (b)  $(\text{DHQ})_2\text{PHAL}$ ,  $\text{OsO}_4$ ,  $\text{CH}_3\text{SO}_2\text{NH}_2$ ,  $\text{K}_3\text{Fe}(\text{CN})_6$ ,  $\text{K}_2\text{CO}_3$ ,  $t\text{-BuOH}:\text{H}_2\text{O}$  (1:1), 24 h, 0 °C , 88% ; (c) (i)  $\text{SOCl}_2$ ,  $\text{Et}_3\text{N}$ , 15 min. (ii)  $\text{RuCl}_3/\text{NaIO}_4$ , 1 h, 88% ; (d)  $\text{NaN}_3$ , acetone, 1 h, 20% aq. $\text{H}_2\text{SO}_4$ , ether, 10 h, 78% ; (e)  $\text{Boc}_2\text{O}$ ,  $\text{Pd/C}$ ,  $\text{H}_2$ ,  $\text{EtOAc}$ , 6 h, 98% ; (f)  $\text{DIBAL-H}$ , -78 °C, 1 h.

The synthesis of (-)- $\alpha$ -conhydrine **2** commenced from propionaldehyde **64**, a readily available starting material. Compound **64** was treated in benzene under reflux conditions with (methoxycarbonylmethylene)triphenyl phosphorane to give the Wittig product in 85% yield. The IR spectrum of **63** showed C=C stretching at  $1648\text{ cm}^{-1}$  and C=O stretching at  $1712\text{ cm}^{-1}$ .  $^1\text{H}$  NMR spectrum showed the presence of olefinic peaks at  $\delta$  5.74 (d,  $J = 16\text{ Hz}$ ), 6.87-6.98 (m). The methoxy signal appeared at  $\delta$  3.64 (s). The dihydroxylation of **63** with osmium tetroxide and potassium ferricyanide as co-

oxidant in the presence of (DHQ)<sub>2</sub>PHAL as chiral ligand under the Sharpless asymmetric dihydroxylation conditions gave the diol in 88% yield with 95% ee,  $[\alpha]_D^{25} : -5.5$  (c 1.0, CHCl<sub>3</sub>) [lit.<sup>13</sup>  $[\alpha]_D^{25} : -5.9$  (c 0.35, CHCl<sub>3</sub>)]. The enantiomeric excess was determined using chiral HPLC. The presence of strong hydroxyl absorption stretching at 3450 cm<sup>-1</sup> and absence of C=C stretching in the IR spectrum clearly indicated the formation of product **62**. <sup>1</sup>H NMR spectrum showed absence of the olefinic peaks, and presence of broad singlets for hydroxyl protons at  $\delta$  2.05. The diol **62** was then treated with thionyl chloride and triethyl amine to give the cyclic sulfite which was further oxidized using NaIO<sub>4</sub> and a catalytic amount of ruthenium trichloride to furnish the corresponding cyclic sulfate **59** in excellent yield. The IR spectrum of **59** showed the absence of hydroxyl absorption. A downfield shift in the <sup>1</sup>H NMR spectrum, of -CH<sub>2</sub>OSO<sub>2</sub>- protons to  $\delta$  4.89-4.93 as multiplet was observed in comparison to the same protons ( $\delta$  3.73-4.14) of diol **62**. The essential feature of our synthetic strategy shown in **Scheme 10** was based on the presumption that the nucleophilic opening of cyclic sulfate would occur in a regiospecific manner at the  $\alpha$ -carbon atom.<sup>14</sup> Indeed, the cyclic sulfate reacted with NaN<sub>3</sub> with apparent complete selectivity for attack at the C-2, giving azide **68** in 78% yield. The carbonyl group must be responsible for the increased reactivity of the  $\alpha$ -position. The IR spectrum of **68** showed hydroxyl absorption at 3378 cm<sup>-1</sup> and strong azide absorption at 2112 cm<sup>-1</sup>. Reduction of the azide **68** under hydrogenation conditions in the presence of Boc<sub>2</sub>O gave the Boc protected amino alcohol **56**. The absence of azide stretching in the IR spectrum and the presence of 9 protons for Boc group at  $\delta$  1.44 as singlet in the <sup>1</sup>H NMR spectrum showed the formation of **56**. The ester group of **56** was reduced to aldehyde **69** using DIBAL-H at -78 °C. The <sup>1</sup>H NMR spectrum showed doublet at  $\delta$  9.38 for aldehyde.

The other fragment to reach the target molecule (-)- $\alpha$ -conhydrine has been synthesized as shown in **Scheme 11**. The synthesis of salt **57** was carried out from commercially available 1,3-propanediol **60**. Mono bromination of 1,3-propanediol using 48% aqueous HBr under Dean-Stark apparatus in benzene solvent gave **70** which was treated with triphenyl phosphine in acetonitrile under reflux conditions to give salt **57**.

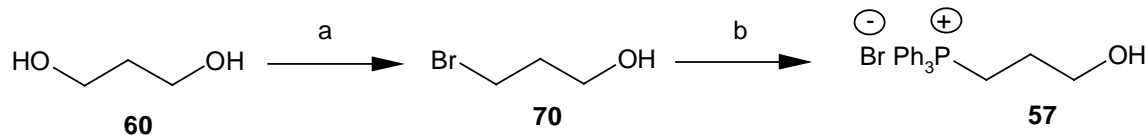

**Scheme 11 : Reaction conditions :** (a) 48% aq. HBr, benzene, 28 h, 79% ; (b) PPh<sub>3</sub>, K<sub>2</sub>CO<sub>3</sub>, dry acetonitrile, reflux, 7 h, 26%.

As shown in **Scheme 12** the coupling between the aldehyde **69** and salt **57** through Wittig olefination using *n*-BuLi gave the olefin **71** in 40% yield. The IR spectrum of **71** showed the olefin stretching at 1602 cm<sup>-1</sup>. In the <sup>1</sup>H NMR spectrum, olefinic peaks appeared at δ 5.99 and 6.53. The reduction of the double bond in **71** was achieved using Pd/C in ethyl acetate. The IR and <sup>1</sup>H NMR spectrum revealed absence of olefinic peaks. The compound **55** was subjected to cyclization using methanesulfonyl chloride and triethyl amine at -78 °C to give the piperidine. Finally, the Boc group was deprotected using trifluoroacetic acid in dichloromethane to furnish the target molecule (-)-α-conhydrine **2** in 74% yield.

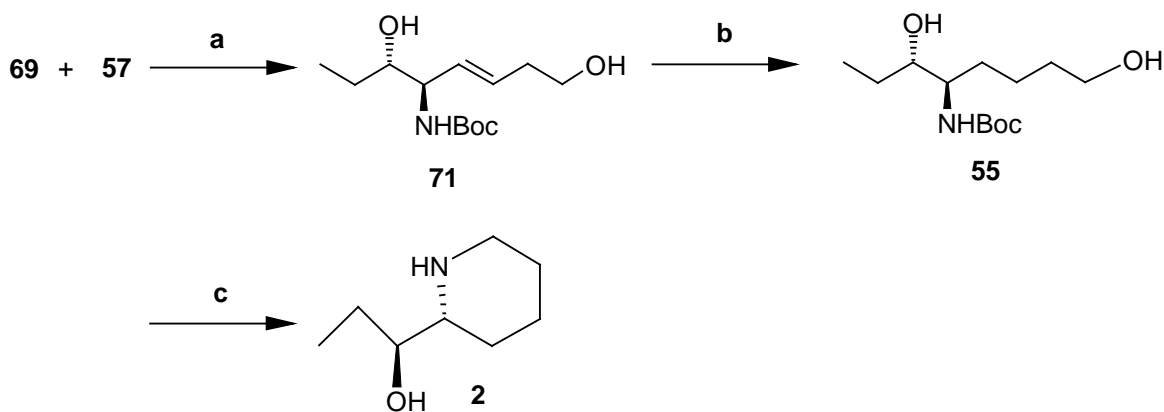

**Scheme 10 : Reaction conditions :** (a) *n*-BuLi, -78 °C, 40% ; (b) Pd/C, H<sub>2</sub>, MeOH, 4 h, 95% ; (c) (i) MsCl, Et<sub>3</sub>N, -78 °C, 1 h ; (ii) CF<sub>3</sub>COOH, CH<sub>2</sub>Cl<sub>2</sub>, 74%.

Though we successfully achieved the synthesis of target molecule **2** in high ee, the yield obtained at the Wittig step was not very satisfactory. Therefore, we looked into the alternative synthetic strategy with an aim to synthesize the target molecule in high yield and good enantiomeric excess. An alternative sequence of reactions to arrive at the target molecule is depicted in **Scheme 13**. In this case the required amino alcohol functionality is arrived through selective 1,3-benzylidene formation. As shown in **Scheme 13**, the Sharpless asymmetric dihydroxylation of allylic alcohol *trans*-pent-2-ene-1-ol **67** with osmium tetroxide and potassium ferricyanide as co-oxidant in the presence of 1,4-bis(9-*O*-dihydroquinine)phthalazine [(DHQ)<sub>2</sub>PHAL] ligand gave (2*S*,3*S*)-triol **66** in good yield,  $[\alpha]_D^{25} : -6.7$  (*c* 1.0, CHCl<sub>3</sub>). The IR spectrum of **66** showed hydroxyl absorption at 3400-3200 cm<sup>-1</sup> and absence of olefin C=C stretching. In the <sup>1</sup>H NMR spectrum the olefinic proton disappeared and corresponding protons related to stereogenic centres appeared at  $\delta$  3.67-3.73 as multiplets. In order to achieve the amino alcohol functionality from triol **66**,

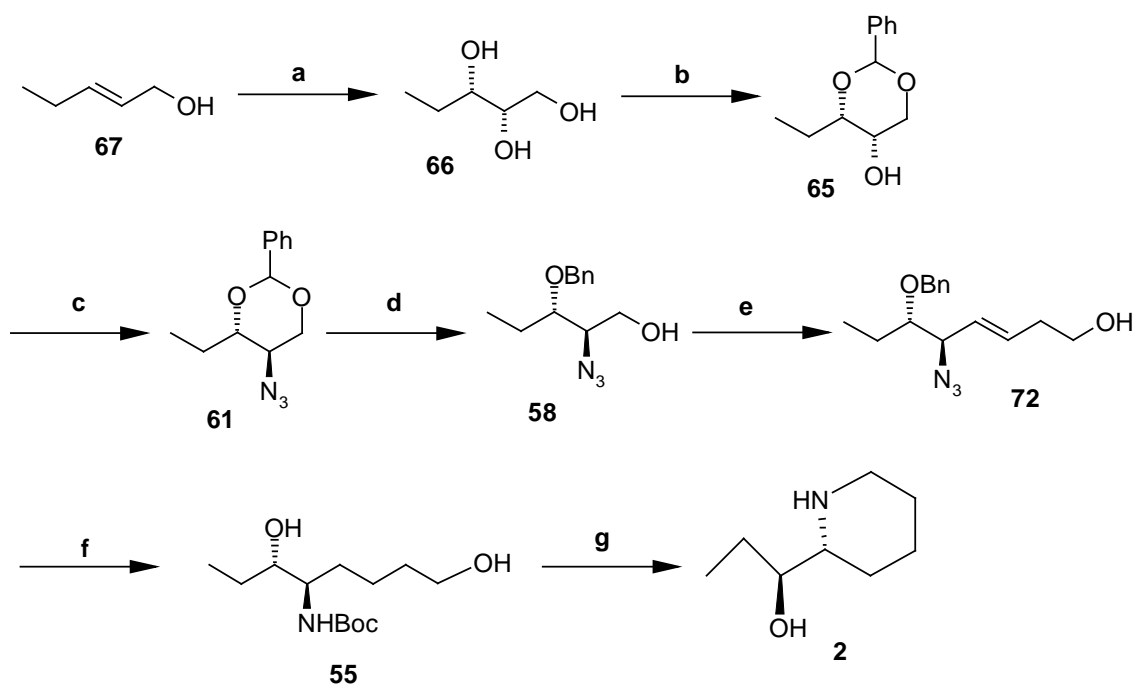

**Scheme 13**

**Scheme 13 : Reaction conditions** : (a) (DHQ)<sub>2</sub>PHAL, OsO<sub>4</sub>, CH<sub>3</sub>SO<sub>2</sub>NH<sub>2</sub>, K<sub>2</sub>CO<sub>3</sub>, *t*-BuOH:H<sub>2</sub>O (1:1), 24 h, 0 °C, 75% ; (b) C<sub>6</sub>H<sub>5</sub>CH(OMe)<sub>2</sub>, dry CH<sub>2</sub>Cl<sub>2</sub>, *p*-TSA, rt, 24 h, 74% ; (c) (i) CH<sub>3</sub>SO<sub>2</sub>Cl, dry CH<sub>2</sub>Cl<sub>2</sub>, rt ; (ii) NaN<sub>3</sub>, dry DMF, 80 °C, 24 h, 86% ; (d) DIBAL-H, -78 °C, dry CH<sub>2</sub>Cl<sub>2</sub>, 12 h, 90% ; (e) (i)



PCC, anhydrous  $\text{CH}_3\text{COONa}$ , celite ; (ii) salt **57**, *n*-BuLi, dry THF, 0 °C-rt, 74% ; (f) Pd/C,  $\text{H}_2$ ,  $\text{Boc}_2\text{O}$ , EtOAc, 86% ; (g) (i) MsCl,  $\text{Et}_3\text{N}$ , -78 °C, 1h ; (ii)  $\text{CF}_3\text{COOH}$ ,  $\text{CH}_2\text{Cl}_2$ .

we required the transformation of C-2 hydroxyl group to azido with concomitant reversal of stereochemistry. Towards this end, the benzylidene protection of triol **66** was effected with benzaldehyde dimethyl acetal in the presence of catalytic amount of *p*-TsOH to afford a mixture of 1,3-and 1,2-benzylidene compounds in 9:1 ratio. The desired major 1,3-benzylidene compound **65** was separated by flash silica gel column chromatography and obtained in 74% yield. The  $^1\text{H}$  NMR spectrum of **65** showed acetal proton at  $\delta$  5.58 as singlet and aromatic protons appeared at  $\delta$  7.37-7.58 (m). Compound **65** was then converted into 5-*O*-mesylate with methanesulfonyl chloride using  $\text{Et}_3\text{N}$  and catalytic amount of DMAP. The crude mesylate was treated with sodium azide in DMF to give the azido compound **61** with desired stereochemistry at 5-position. The IR spectrum of compound **61** showed absence of hydroxyl absorption and presence of strong azide absorption at  $2122\text{ cm}^{-1}$ . The opening of benzylidene compound **61** was achieved using DIBAL-H at -78 °C.<sup>15</sup> The  $^1\text{H}$  NMR and  $^{13}\text{C}$  NMR spectra showed absence of acetal proton and carbon respectively. Compound **58** was oxidised under PCC conditions to afford the aldehyde which was subsequently treated with salt **57** using *n*-BuLi as a base to give the olefin **72** as a *cis-trans* mixture. The IR spectrum of **72** showed olefin absorption at  $1616\text{ cm}^{-1}$  and in the  $^1\text{H}$  and  $^{13}\text{C}$  NMR spectra olefin peaks appeared at  $\delta$  5.48-5.55 and  $\delta$  127.9 and 28.4 respectively. Our next objective was to prepare compound **55** in one step, which was achieved, by reducing double bond and azide under hydrogenation conditions using 10% Pd/C and subsequent protection of free amine with  $\text{Boc}_2\text{O}$ . Compound **55** showed similar physical and chemical properties, as obtained by synthetic strategy described in **Scheme 12**. Subsequent conversion into the target compound **2** was carried out following the same reaction as described in **Scheme 12**.

### 3.1.5 Conclusion

In conclusion, we have accomplished enantioselective synthesis of (-)- $\alpha$ -conhydrine by two different synthetic strategies employing Sharpless asymmetric dihydroxylation, regioselective opening of a cyclic sulfate and Wittig olefination as the key steps. The merits of this synthesis are high enantioselectivity and various possibilities available for structural modifications. The other enantiomer can be synthesized by  $\beta$ -dihydroxylation of olefin **64** and **67** and following the reaction sequence as shown above.

### 3.1.6 Experimental section

#### General Information

Solvents were purified and dried by standard procedures before use; petroleum ether of boiling range 60-80 °C was used. Optical rotations were measured using sodium D line on JASCO-181 digital polarimeter. Infrared spectra were recorded on a Perkin-Elmer model 683 grating infrared spectrometer. <sup>1</sup>H (200 MHz) and <sup>13</sup>C (50 MHz) NMR spectra were recorded in CDCl<sub>3</sub> solution with residual CHCl<sub>3</sub> as internal standard.

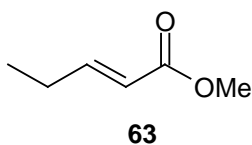

#### Preparation of Methyl-*trans*-pent-2-enoate

To a solution of (methoxycarbonylmethylene)triphenylphosphorane (63.46 g, 0.19 mol) in benzene (200 mL) was added propionaldehyde 64 (10 g, 0.172 mol). The reaction mixture was refluxed for 2 h and solvent concentrated to near dryness. Column chromatography on silica gel using EtOAc/pet ether (0.2:9.8) as eluent gave the Wittig product 63 (16.72 g) as a colorless oil.

Yield : 85%

IR (neat, cm<sup>-1</sup>) :  $\nu_{\max}$  1617, 1722

<sup>1</sup>H NMR (200 MHz, CDCl<sub>3</sub>) :  $\delta$  0.98 (t, *J* = 8 Hz, 3H), 2.08-2.18 (m, 2H), 3.64 (s, 3H), 5.74 (d, *J* = 16 Hz, 1H), 6.87-6.98 (m, 1H)

<sup>13</sup>C NMR (50 MHz, CDCl<sub>3</sub>) :  $\delta$  9.8, 25.1, 53.8, 122.2, 135.5, 174.2

## Preparation of Methyl (2*S*,3*S*)-2,3-dihydroxypentanoate

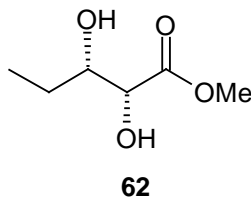

To a mixture of  $K_3Fe(CN)_6$  (42.80 g, 0.13 mol),  $K_2CO_3$  (17.96 g, 0.13 mol),  $(DHQ)_2PHAL$  (341 mg, 1 mol%) in *t*-BuOH:H<sub>2</sub>O (1:1) was added osmium tetroxide (1.75 mL, 0.1 M solution in toluene, 0.4 mol%) followed by methane sulfonamide (4.16 g, 43.80 mol). After stirring for 5 min at 0 °C, the olefin **63** (5 g, 43.80 mmol) was added in one portion. The reaction mixture was stirred at 0 °C for 24 h and then quenched with solid sodium sulfite (2.5 g). The stirring was continued for an additional 45 min and then the solution extracted with ethyl acetate (5x100 mL). The combined organic phases were washed with 10% aq. KOH, brine, dried ( $Na_2SO_4$ ) and concentrated. Silica gel column chromatography of the crude product using EtOAc/pet ether (4:6) as eluent gave **62** (5.71 g) as a viscous liquid.

**Yield** : 88%

$[\alpha]_D^{25}$  : -5.5 (*c* 1.0,  $CHCl_3$ )

**IR** (neat,  $cm^{-1}$ ) :  $\nu_{max}$  3562, 1722

**<sup>1</sup>H NMR** (200 MHz,  $CDCl_3$ ):  $\delta$  1.0 (t, *J* = 6 Hz, 3H), 1.57-1.72 (m, 2H), 2.05 (brs, 2H), 3.73-3.78 (m, 1H), 3.83 (s, 3H), 4.14 (d, *J* = 4 Hz, 1H)

**<sup>13</sup>C NMR** (50 MHz,  $CDCl_3$ ):  $\delta$  9.8, 26.0, 53.3, 72.8, 73.8, 173.4

**Analysis** :  $C_6H_{12}O_4$  (148.16) requires C, 48.64 ; H, 8.16. Found. C, 48.52 ; H, 8.09.

Preparation of (2*S*,3*S*)-5-ethyl-2,2-dioxo-[1,3,2]dioxathiolane-4-carboxylic acid methyl ester

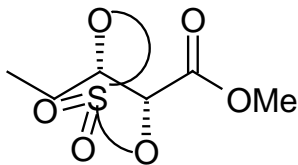

59

To a solution of diol 62 (2 g, 13.49 mmol) in dry  $\text{CH}_2\text{Cl}_2$  (12 mL) was added  $\text{Et}_3\text{N}$  (5.46 g, 7.52 mL, 53.99 mmol). The mixture was cooled in an ice bath and thionyl chloride (2.4 g, 1.47 mL, 20.17 mmol) was added dropwise. The reaction mixture was stirred for 20 min. and then quenched by adding water (10 mL). The phases were separated and aqueous phase was extracted with  $\text{CH}_2\text{Cl}_2$  (3x20 mL). The combined organic phases were dried ( $\text{Na}_2\text{SO}_4$ ) and concentrated. Then the solution was cooled with an ice-water bath and diluted with  $\text{CH}_3\text{CN}$  (32 mL) and  $\text{CCl}_4$  (32 mL).  $\text{RuCl}_3 \cdot \text{H}_2\text{O}$  (15 mg, 0.072 mmol) and  $\text{NaIO}_4$  (6.16 g, 28.83 mmol) were added followed by water (47 mL). The resulting orange mixture was stirred at room temperature for 1 h. The mixture was then diluted with ether (50 mL), and the two phases were separated. The organic layer was washed with water (40 mL), saturated aq.  $\text{NaHCO}_3$  (30 mL), brine and dried ( $\text{Na}_2\text{SO}_4$ ), and concentrated. Silica gel column chromatography of the crude product using  $\text{EtOAc}/\text{pet.ether}$  (2:8) as eluent gave 59 (2.5 g) as a colorless liquid.

Yield : **88%**

$[\alpha]_D^{25}$  : **-15.6 (c 1, CHCl<sub>3</sub>)**

IR (neat, cm<sup>-1</sup>) :  $\nu_{\max}$  3142, 3022, 2914, 1722

<sup>1</sup>H NMR (200 MHz, CDCl<sub>3</sub>):  $\delta$  **1.12 (t, *J* = 7.4 Hz, 3H), 1.97-2.09 (m, 2H), 3.89 (s, 3H), 4.89-4.93 (m, 1H), 5.30-5.32 (m, 1H)**

<sup>13</sup>C NMR (50 MHz, CDCl<sub>3</sub>):  $\delta$  **8.5, 25.8, 52.7, 79.3, 85.2, 164.4.**

Analysis : C<sub>6</sub>H<sub>10</sub>O<sub>6</sub> (210.21) requires C, 34.28 ; H, 4.80. Found. C, 34.16 ; H, 4.72.

Preparation of Methyl (2*R*,3*S*)-2-azido-3-hydroxypentanoate

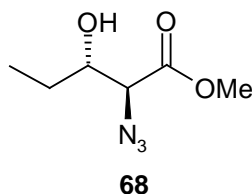

To a solution of cyclic sulfate 59 ( 2.5 g, 11.89 mmol) in acetone (15 mL) cooled to 0 °C was added NaN<sub>3</sub> (3.86 g, 59.46 mmol) and the resulting mixture was stirred for 1 h at room temperature until no cyclic sulfate remained as indicated by TLC. The solution was then concentrated, and the residue was stirred with 20% aq. H<sub>2</sub>SO<sub>4</sub> and ether (5 mL of each phase/mmol substrate) for 12 h. The resultant solution was then extracted with ether. The combined organic phases were washed with water, brine and dried (Na<sub>2</sub>SO<sub>4</sub>), and concentrated. Silica gel column

chromatography of the crude product using EtOAc/pet ether (1:9) as eluent furnished 68 (1.60 g) as a colorless liquid.

Yield : 78%

$[\alpha]_D^{25}$  : -4.68 (*c* 1, CHCl<sub>3</sub>)

IR (neat, cm<sup>-1</sup>) :  $\nu_{\max}$  3429, 2112, 1744

<sup>1</sup>H NMR (200 MHz, CDCl<sub>3</sub>):  $\delta$  1.0 (t, *J* = 7.43 Hz, 3H), 1.50-1.69 (m, 2H), 2.33 (brs, 1H, OH), 3.83 (s, 3H), 3.87-3.91 (m, 1H), 3.97 (d, *J* = 5.87 Hz, 1H)

<sup>13</sup>C NMR (50 MHz, CDCl<sub>3</sub>):  $\delta$  9.5, 25.6, 51.7, 61.0, 73.0, 168.9

Analysis : C<sub>6</sub>H<sub>11</sub>N<sub>3</sub>O<sub>3</sub> (173.17) requires C, 41.61 ; H, 6.40. Found. C, 41.59 ; H, 6.36.

Preparation of Methyl (2*R*,3*S*)-2-*tert*-butoxycarbonylamino-3-

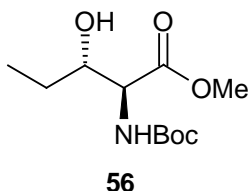

hydroxypentanoate

To a solution of azide 68 (2.0 g, 11.54 mmol) in ethyl acetate (10 mL) was added 10% Pd/C (75 mg) and Boc<sub>2</sub>O (3.97 mL, 17.32 mmol). The resulting solution was stirred under hydrogen atmosphere at room temperature until disappearance of the azido alcohol as monitored by

**TLC. The reaction mixture was filtered through a celite pad to remove the catalyst and the filtrate was concentrated in vacuo. Silica gel column chromatography of the crude product using EtOAc/pet ether (3:7) as eluent gave 56 (2.8 g) as a liquid.**

**Yield : 98%**

$[\alpha]_D^{25}$  : -6.9 (c 2, CHCl<sub>3</sub>)

**IR (neat, cm<sup>-1</sup>)** :  $\nu_{\max}$  3522, 3342, 1719

**<sup>1</sup>H NMR (200 MHz, CDCl<sub>3</sub>)**:  $\delta$  0.99 (t, *J* = 8 Hz, 3H), 1.44 (s, 9H), 1.52-1.63 (m, 2H), 2.54 (brs, OH, 1H), 3.62 (s, 3H), 3.83-3.86 (m, 1H), 4.38-4.40 (m, 1H), 5.54 (brs, 1H)

**<sup>13</sup>C NMR (50 MHz, CDCl<sub>3</sub>)**:  $\delta$  10.1, 26.3, 28.1, 52.3, 58.0, 74.3, 80.3, 155.8, 171.2

**Analysis** : C<sub>11</sub>H<sub>21</sub>NO<sub>5</sub> (247.27) requires C, 53.43 ; H, 8.56 ; N 5.66.

**Found.** C, 53.40 ; H, 8.52.

Synthesis of salt (3-hydroxypropyl)triphenylphosphoniumbromide 57

3-bromopropanol

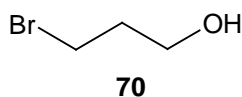

**To a stirred solution of 1,3-propanediol 60 (5 g, 65.70 mmol) in benzene (100 mL) was added 48% aq. HBr (12.7 mL, 78.84 mmol) and the mixture stirred under reflux for 28 h while trapping the water formed**

using a Dean-stark water separator. The mixture was washed with 6N NaOH solution (50 mL), 10% HCl (50 mL), water (2x100mL) and brine (75 mL). The organic layer was dried over anhydrous Na<sub>2</sub>SO<sub>4</sub> and concentrated to near dryness. The crude product was purified by silica gel column chromatography using EtOAc/pet ether (1:9) to give 70 (7.2 g) as a colorless oil.

<sup>1</sup>H NMR (200 MHz, CDCl<sub>3</sub>) : δ 2.05-2.25 (m, 3H), 2.55 (brs, 1H), 3.54 (t, *J* = 6 Hz, 2H), 3.78 (t, *J* = 8 Hz, 2H)

<sup>13</sup>C NMR (50 MHz, CDCl<sub>3</sub>) : δ 30.1, 34.6, 59.5

Preparation of (3-hydroxypropyl)-triphenylphosphoniumbromide

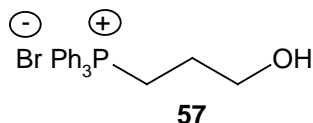

A solution of 3-bromopropanol 70 (5 g, 35.97 mmol), triphenylphosphine (9.43 g, 35.97 mmol), and K<sub>2</sub>CO<sub>3</sub> (4.97 g, 35.97 mmol) in dry CH<sub>3</sub>CN (50 mL) was heated at reflux under nitrogen for 7 h. K<sub>2</sub>CO<sub>3</sub> was filtered off and the filtrate was diluted with ether and the solution allowed to stand, during which the product 57 was precipitated out as white crystals (3.8 g, 26%).

<sup>1</sup>H NMR (200 MHz, CDCl<sub>3</sub>) : δ 1.88-1.92 (m, 2H), 3.70-3.85 (m, 3H), 4.60-4.66 (m, 2H), 7.71-7.79 (m, 15H)



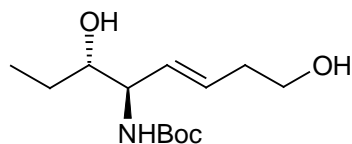

71

[5-hydroxy-1-(1-hydroxypropyl)-pent-2-enyl]-carbamic acid *tert*-butyl ester

To a solution of 56 (0.3 g, 1.21 mmol) dissolved in dry DCM (5 mL) was added DIBAL-H (0.48 mL, 1.21 mmol, 2.5 M solution of DIBAL-H in toluene) dropwise at -78 °C. The reaction mixture was stirred for 1 h until disappearance of the starting material as indicated by TLC and then quenched with saturated sodium potassium tartrate. The precipitate obtained was filtered off and the combined organic layers were dried over Na<sub>2</sub>SO<sub>4</sub> and concentrated to near dryness which was used as such in the next step without further purification.

To a suspension of Wittig salt 57 (0.4 g, 1.01 mmol) in dry THF (5 mL) was added *n*-BuLi (1.1 mL, 2.3 mmol) at 0 °C and stirred for 30 min. To this solution the above crude aldehyde was added and stirred at rt for 12 h, and then quenched with sat. aq. NH<sub>4</sub>Cl. The aqueous layer was extracted with EtOAc (4x50 mL). The combined organic extracts were

washed with brine and dried over  $\text{Na}_2\text{SO}_4$  and concentrated.

Purification of the residue by silica gel column chromatography using EtOAc/pet ether (6:4) as eluent gave 71 (0.127 g) as a colorless oil.

Yield : 40 %

$[\alpha]_D^{25}$  : -10.3 (*c* 1,  $\text{CHCl}_3$ )

IR (neat,  $\text{cm}^{-1}$ ) :  $\nu_{\text{max}}$  3511, 3328, 1609

$^1\text{H}$  NMR (200 MHz,  $\text{CDCl}_3$ ):  $\delta$  0.98 (t,  $J = 10$  Hz, 3H), 1.25-1.36 (m, 2H), 1.47 (s, 9H), 2.1 (brs, 2H), 2.15-2.30 (m, 2H), 2.89-2.97 (m, 2H), 4.20 (q,  $J = 6$  Hz, 1H), 4.30 (t,  $J = 6$  Hz, 1H), 5.42 (brs, 1H), 5.98-5.99 (m, 1H), 6.53 (t,  $J = 6$  Hz, 1H)

$^{13}\text{C}$  NMR (50 MHz,  $\text{CDCl}_3$ ):  $\delta$  12.6, 21.6, 28.0, 30.5, 61.0, 64.9, 71.2, 80.1, 128.5, 132.0, 153.2.

Analysis :  $\text{C}_{13}\text{H}_{25}\text{NO}_4$  (259.34) requires C, 60.21 ; H, 9.79 ; N, 5.40.

Found. C, 60.18 ; H, 9.73 ; N, 5.38.

Preparation of [5-Hydroxy-1-(1-hydroxypropyl)-pentyl]-carbamic acid *tert*-butyl ester

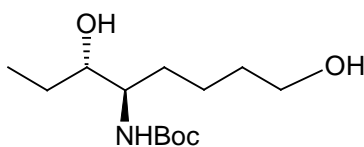

To a solution of 71 (0.50 g, 1.93 mmol) in methanol (10 mL) was added Pd/C (50 mg) under hydrogen atmosphere and mixture stirred for 4 h. After completion of the reaction, the mixture was filtered through celite pad and concentrated to near dryness. The crude product was purified by silica gel column chromatography using EtOAc/pet ether (6:4) as eluent to give 55 (0.478 g) as a liquid.

Yield : **95%**

$[\alpha]_D^{25}$  : -9.8 (*c* 1, CHCl<sub>3</sub>)

IR (neat, cm<sup>-1</sup>) :  $\nu_{\max}$  3520, 3318

<sup>1</sup>H NMR (200 MHz, CDCl<sub>3</sub>):  $\delta$  0.98 (t, *J* = 10 Hz, 3H), 1.23-1.25 (m, 2H), 1.43 (s, 9H), 1.46-1.49 (m, 4H), 1.55-1.62 (m, 2H), 2.01 (brs, 2H), 3.52 (t, *J* = 8 Hz, 2H), 3.66-3.83 (m, 2H), 5.56 (brs, 1H)

<sup>13</sup>C NMR (50 MHz, CDCl<sub>3</sub>):  $\delta$  8.2, 19.0, 22.7, 25.6, 28.0, 31.7, 56.2, 62.2, 64.9, 77.8, 153.2.

Analysis : C<sub>13</sub>H<sub>27</sub>NO<sub>4</sub> (261.36) requires C, 59.74 ; H, 10.41 ; N, 5.36.

Found. C, 59.72 ; H, 10.38 ; N, 5.32.

Preparation of 2-(1-Hydroxypropyl)-piperidine-1-carboxylic acid-*tert*-butyl

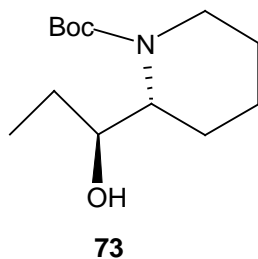

ester

To a stirred solution of compound 55 (0.4 g, 1.53 mmol) in dry  $\text{CH}_2\text{Cl}_2$  (6 mL) was added methanesulfonyl chloride (0.14 mL, 1.83 mmol) at  $-78^\circ\text{C}$  and then triethyl amine (0.25 mL, 1.83 mmol) was added dropwise. After the mixture was stirred at  $-78^\circ\text{C}$  for 1 h, aqueous ammonium chloride (3 mL) was added. The mixture was warmed to room temperature and diluted with  $\text{CH}_2\text{Cl}_2$  (5 mL), washed with brine, and dried over  $\text{Na}_2\text{SO}_4$ . The solvent was removed, and the residue was purified by flash chromatography using EtOAc/pet ether (4:6) to give 73 (0.31 g) as a colorless liquid.

Yield : 84%

$[\alpha]_{\text{D}}^{25}$  : -12.2 (*c* 1,  $\text{CHCl}_3$ )

IR (neat,  $\text{cm}^{-1}$ ) :  $\nu_{\text{max}}$  3422, 1688

$^1\text{H}$  NMR (200 MHz,  $\text{CDCl}_3$ ) :  $\delta$  0.96 (t,  $J = 6$  Hz, 3H), 1.32-1.45 (m, 6H), 1.45 (s, 9H), 1.52-1.63 (m, 2H), 2.02 (t,  $J = 8$  Hz, 2H), 2.96 (brs, 1H), 3.32-3.42 (m, 2H)

$^{13}\text{C}$  NMR (50 MHz,  $\text{CDCl}_3$ ) :  $\delta$  **9.8, 23.3, 24.4, 25.3, 26.2, 27.3, 53.2, 60.2, 70.9, 75.5, 164.9**

Analysis :  $\text{C}_{13}\text{H}_{25}\text{NO}_3$  (243.18) requires C, 64.16 ; H, 10.36 ; N, 5.76.  
Found. C, 64.12 ; H, 10.33 ; N, 5.72.

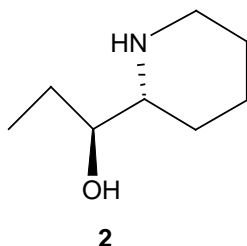

### Synthesis of (-)- $\alpha$ -conhydrine

To an ice-bath solution of **73** (23 mg, 0.095 mmol) in dry  $\text{CH}_2\text{Cl}_2$  (1 mL) was added trifluoroacetic acid (0.2 mL, 0.095 mmol). The reaction mixture was stirred at room temperature for 12 h and then saturated aq.  $\text{NaHCO}_3$  added and mixture extracted with dichloromethane (3x5 mL). The combined organic layers were washed with brine and dried over  $\text{Na}_2\text{SO}_4$  and concentrated under reduced pressure to near dryness. The crude product was purified by silica gel column chromatography using  $\text{CH}_3\text{OH}/\text{CH}_2\text{Cl}_2$  (4:6) as eluent to give **2** (12 mg) as a solid.  $[\alpha]_{\text{D}}^{25}$  : - 8.9 (c 1.0, ethanol). The physical and spectroscopic data of **2** were in full agreement with the literature data.<sup>8</sup>

Yield : **74%**

M.p. : **116-118 °C [lit.<sup>8</sup> 118 °C]**

$[\alpha]_{\text{D}}^{25}$  : **-8.9 (c 1, ethanol) [lit.<sup>8</sup>  $[\alpha]_{\text{D}}^{25}$ : - 8.6 ; ethanol].**

$^1\text{H}$  NMR (200 MHz,  $\text{CDCl}_3$ ) :  $\delta$  **0.96 (t,  $J$  = 6 Hz, 3H), 1.32-1.55 (m, 5H), 1.55 (m, 2H), 1.88 (m, 1H), 2.52 (t,  $J$  = 8 Hz, 1 H), 2.72 (t,  $J$  = 10 Hz, 1H), 3.11-3.16 (m, 1H), 3.22 (brs, 2 H), 3.42-3.44 (m, 1H)**

$^{13}\text{C}$  NMR (50 MHz,  $\text{CDCl}_3$ ) :  $\delta$  7.8, 24.0, 25.9, 26.3, 28.1, 46.0, 58.1, 78.1

### Preparation of (2*S*,3*S*)-Pent-1, 2, 3-triol

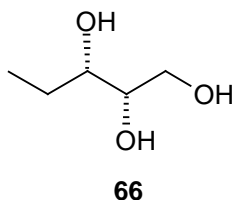

To a mixture of  $\text{K}_3\text{Fe}(\text{CN})_6$  (55.97 g, 0.17 mmol),  $\text{K}_2\text{CO}_3$  (23.49 g, 0.17 mmol) and  $(\text{DHQ})_2\text{PHAL}$  (452 mg, 1 mol%) in *t*-BuOH- $\text{H}_2\text{O}$  (1:1) cooled at 0 °C was added osmium tetroxide (2.3 mL, 0.1 M solution in toluene, 0.4 M mol%) followed by methanesulfonamide (5.5 g, 58.09 mmol). After stirring for 5 min. at 0 °C, the olefin **67** (5 g, 58.09 mmol) was added in one portion. The reaction mixture was stirred at 0 °C for 24 h and then quenched with solid sodium sulfite. The stirring was continued for an additional 45 min. and then the solution was extracted with ethyl acetate (5x100 mL). The combined organic phases were washed with 10% aq. KOH, brine, dried ( $\text{Na}_2\text{SO}_4$ ) and concentrated. Silica gel column chromatography of the crude product using EtOAc/pet ether (6:4) as eluent gave **66** (5.21 g) as a viscous liquid.

Yield : **75%**

$[\alpha]_{\text{D}}^{25}$  : -6.7 (*c* 1,  $\text{CHCl}_3$ )

IR (neat,  $\text{cm}^{-1}$ ) :  $\nu_{\text{max}}$  3400-3200, 2919, 2851, 1455, 1375, 1074

$^1\text{H}$  NMR (200 MHz,  $\text{CDCl}_3$ ):  $\delta$  0.9 (t,  $J = 6$  Hz, 3H), 1.42-1.56 (m, 2H), 2.11 (brs, 2H), 3.51-3.59 (m, 2H), 3.67-3.73 (m, 3H)

Analysis :  $\text{C}_5\text{H}_{12}\text{O}_3$  (261.36) requires C, 49.98 ; H, 10.07 . Found. C, 49.96 ; H, 10.02.

### Preparation of (2*S*,3*S*)-1,3-*O*-Benzylidenepentane-1, 2, 3-triol

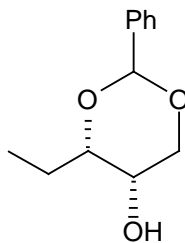

**65**

To a solution of **66** (3 g, 24.96 mmol) in dry CH<sub>2</sub>Cl<sub>2</sub> (40 mL) were added *p*-TsOH (80 mg) and benzaldehyde dimethyl acetal (4.56 g, 4.49 mL, 29.96 mmol). The reaction mixture was stirred at room temperature for 12 h. Subsequently, it was neutralized with saturated aq. NaHCO<sub>3</sub>. The organic phase was separated and the aqueous phase extracted with CH<sub>2</sub>Cl<sub>2</sub>. The combined organic extracts were washed with aq. NaHCO<sub>3</sub>, brine, dried (Na<sub>2</sub>SO<sub>4</sub>) and concentrated. Column chromatography over silica gel using EtOAc/pet ether (1:9) as eluent furnished the major product **65** (3.82 g) as a colorless liquid.

Yield : **74%**

[α]<sub>D</sub><sup>25</sup> : -11.5 (c 0.48, CHCl<sub>3</sub>)

IR (neat, cm<sup>-1</sup>) : ν<sub>max</sub> 3512, 2922, 2849, 1451, 1377, 1276, 1215

<sup>1</sup>H NMR (200 MHz, CDCl<sub>3</sub>): δ **1.0 (t, *J* = 7.4 Hz, 3H), 1.69-1.87 (m, 2H), 2.52 (brs, 1H, OH), 3.45-3.74 (m, 1H), 3.63-3.72 (m, 1H), 3.93 (dd, *J* = 2, 12 Hz, 2H) , 5.58 (s, 1H), 7.37-7.58 (m, 5H)**

<sup>13</sup>C NMR (50 MHz, CDCl<sub>3</sub>): δ **9.2, 24.0, 72.7, 79.8, 81.5, 101.3, 125.8, 128.1, 134.3, 137.9.**

Analysis : C<sub>12</sub>H<sub>16</sub>O<sub>3</sub> (261.36) requires C, **69.21** ; H, **7.74**. Found. C, **69.18** ; H, **7.71**.

### Preparation of (2*R*,3*S*)-2 azido- 1,3-*O*-benzylidenepentane-1,3-diol

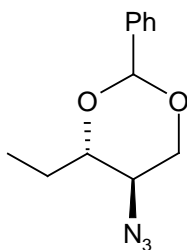

**61**

To a solution of **65** (2 g, 9.6 mmol) in dry CH<sub>2</sub>Cl<sub>2</sub> (20 mL) at 0 °C was added methanesulfonyl chloride (1.65 g, 1.1 mL, 14.40 mmol), Et<sub>3</sub>N (2.27 mL, 16.32 mmol) and DMAP (cat). The reaction mixture was stirred at room temperature for 6 h and then poured into Et<sub>2</sub>O-H<sub>2</sub>O mixture. The organic phase was separated and the aqueous phase extracted with Et<sub>2</sub>O. The combined organic phases were washed with water, brine, dried (Na<sub>2</sub>SO<sub>4</sub>) and concentrated to a white solid which was dissolved in dry DMF (20 mL). Sodium azide (3.4 g, 48.01 mmol) was added and the reaction mixture stirred at 80 °C for 24 h. It was then cooled and poured into water and extracted with ethyl acetate. The organic extracts were washed with water, brine and dried (Na<sub>2</sub>SO<sub>4</sub>) and concentrated. Column chromatography on silica gel using EtOAc/pet ether (0.7:9.3) as eluent gave **61** (1.92 g) as a colorless liquid.

**Yield : 85%**

[α]<sub>D</sub><sup>25</sup> : -8.8 (*c* 1, CHCl<sub>3</sub>)

**IR (neat, cm<sup>-1</sup>)** : ν<sub>max</sub> 2122, 2752, 1432, 1327, 1256, 1225

**<sup>1</sup>H NMR (200 MHz, CDCl<sub>3</sub>)**: δ **1.09 (t, *J* = 4 Hz, 3H), 1.62-1.76 (m, 2H), 3.50-3.62 (m, 2H), 3.99-4.01 (m, 2H), 5.97 (s, 1H), 7.39-7.53 (m, 5H)**

**<sup>13</sup>C NMR (50 MHz, CDCl<sub>3</sub>)**: δ **9.8, 25.4, 51.7, 69.0, 80.0, 103.2, 126.4, 128.4, 129.2, 137.3**



Analysis :  $C_{12}H_{15}N_3O_2$  (261.36) requires C, 61.79 ; H, 6.48 ; N 18.01.

Found. C, 61.76 ; H, 6.44 ; N, 17.98.

Preparation of (2*R*,3*S*)-2-azido-3-benzyloxypentan-1-ol

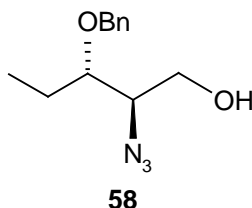

To a solution of **61** (0.4 g, 1.71 mmol), in dry  $CH_2Cl_2$  (10 mL) was added dropwise DIBAL-H (2.57 mL, 2 M solution in toluene, 5.14 mmol) at  $-78^\circ C$  under argon atmosphere. The mixture was gradually allowed to warm to room temperature and the stirring was continued overnight. The reaction mixture was cooled to  $0^\circ C$  and to this was added successively saturated  $NH_4Cl$  (3 mL) and ethyl acetate (5 mL). After being stirred for 1 h at room temperature the mixture was filtered through a celite pad. The filtrate was dried over anhydrous  $Na_2SO_4$  and concentrated under reduced pressure. The crude product was purified by silica gel column chromatography using EtOAc/pet ether (1:9) as eluent to give **58** (0.36 g) as a colorless oil.

Yield : **90%**

$[\alpha]_D^{25}$  : -12.2 (*c* 1,  $CHCl_3$ )

IR (neat,  $cm^{-1}$ ) :  $\nu_{max}$  3433, 2126, 1322, 1216, 1156, 1025

$^1H$  NMR (200 MHz,  $CDCl_3$ ):  $\delta$  **0.96** (t, *J* = 6.8 Hz, 3H), **1.29-1.41** (m, 2H), **2.08** (brs, 1H), **2.11-2.14** (m, 1H), **3.37-3.43** (m, 1H), **3.60** (d, *J* = 5.9 Hz, 2H), **4.69** (s, 2H), **7.33-7.40** (m, 5H)

$^{13}C$  NMR (50 MHz,  $CDCl_3$ ):  $\delta$  **9.3, 24.4, 59.6, 61.2, 74.2, 76.3, 127.6, 128.3, 129.6, 137.4**

Analysis :  $C_{12}H_{17}N_3O_2$  (261.36) requires C, 61.26 ; H, 7.28 ; N, 17.86.

Found. C, 61.22 ; H, 7.25 ; N, 17.85.

### Preparation of (5*R*,6*S*)-5-azido-6-benzyloxy-Oct-3-ene-1-ol

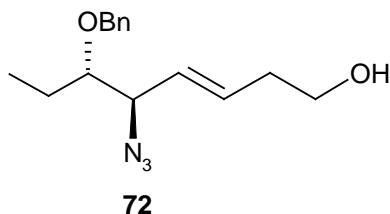

To a stirred solution of PCC (0.68 g, 3.19 mmol), anhydrous sodium acetate (0.26 g, 3.19 mmol) and celite in dry  $CH_2Cl_2$  (5 mL) at 0 °C was added alcohol **58** (0.5 g, 2.12 mmol) in dry  $CH_2Cl_2$  (3 mL) under argon atmosphere and the stirring was continued for 4 h at room temperature until the completion of reaction as indicated by TLC. The reaction mixture was washed thoroughly with diethyl ether and concentrated to give aldehyde which was used immediately in the next step without further purification.

To a stirred solution of salt **57** (1.70 g, 4.25 mmol) in dry THF (20 mL) was added *n*-BuLi (2.12 mL, 2 M solution in hexane, 4.25 mmol) at 0 °C and stirring was continued for further 30 min. The above aldehyde was added to the reaction mixture and stirred for 12 h at ambient temperature and quenched with saturated ammonium chloride solution. The organic layer was separated and aqueous layer extracted with ethyl acetate (3x20 mL) and dried over  $Na_2SO_4$  and concentrated to near dryness. Purification by silica gel column chromatography using EtOAc/pet ether (7:3) as eluent gave **72** (0.35 g) as a viscous liquid.

**Yield** : 78%

$[\alpha]_D^{25}$  : - 19.3 (*c* 0.52,  $CHCl_3$ )

**IR** (neat,  $cm^{-1}$ ) :  $\nu_{max}$  3429, 2133, 1616, 1221, 1156, 1025

**$^1H$  NMR** (200 MHz,  $CDCl_3$ ):  $\delta$  0.96 (t, *J* = 6.0 Hz, 3H), 1.32-1.46 (m, 2H), 2.02 (s, 1H), 2.15-2.23 (m, 2H), 2.62-2.66 (m, 1H), 3.01 (q, *J* = 8.2 Hz, 1H), 3.62 (t, *J* = 10.5 Hz, 2H), 4.69 (s, 2H), 5.48 (t, *J* = 12.6 Hz, 1H), 5.55 (q, *J* = 12.6 Hz, 1H), 7.15-7.28 (m, 5H)

**$^{13}C$  NMR** (50 MHz,  $CDCl_3$ ) :  $\delta$  **9.4, 24.6, 36.5, 62.2, 64.6, 73.9, 81.2, 126.4,**

**127.6, 128.4, 129.3, 132.6, 137.5**

Analysis :  $C_{15}H_{21}N_3O_2$  (275.35) requires C, 65.43 ; H, 7.69 ; N, 15.26

Found. C, 65.40 ; H, 7.63 ; N, 15.21.

Preparation of [5-Hydroxy-1-(1-hydroxypropyl)-pentyl]-carbamic acid *tert*-butyl ester

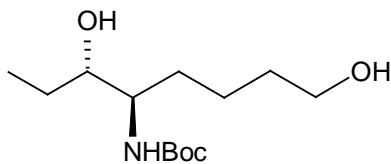

**55**

To a solution of azide **72** (0.3 g, 1.09 mmol) in ethyl acetate was added 10% Pd/C (75 mg) and  $Boc_2O$  (0.3 mL, 1.3 mmol). The resulting solution was stirred under hydrogen atmosphere for 24 h at room temperature until disappearance of the azido alcohol as monitored by TLC. The reaction mixture was filtered through a celite pad to remove the catalyst and the filtrate was concentrated in vacuo. Silica gel column chromatography of the crude product using EtOAc/pet ether (3:7) as eluent gave **55** (0.24 g) as a colorless liquid. yield: 86% ;  $[\alpha]_D^{25}$ : - 8.9 (c 0.86,  $CHCl_3$ ). The physical and spectroscopic data were in accord with those described in **Scheme 12**. The transformation of **55** to the target compound **2** is already described in **Scheme 12**.

### 3.1.7 Spectra

#### 1. $^1H$ & $^{13}C$ NMR spectra of **62**

2.  $^1\text{H}$  &  $^{13}\text{C}$  NMR spectra of 59
3.  $^1\text{H}$  &  $^{13}\text{C}$  NMR spectra of 68
4.  $^1\text{H}$  &  $^{13}\text{C}$  NMR spectra of 56
5.  $^1\text{H}$  &  $^{13}\text{C}$  NMR spectra of 71
6.  $^1\text{H}$  &  $^{13}\text{C}$  NMR spectra of 55
7.  $^1\text{H}$  &  $^{13}\text{C}$  NMR spectra of 65
8.  $^1\text{H}$  &  $^{13}\text{C}$  NMR spectra of 61
9.  $^1\text{H}$  &  $^{13}\text{C}$  NMR spectra of 58
10.  $^1\text{H}$  &  $^{13}\text{C}$  NMR spectra of 2

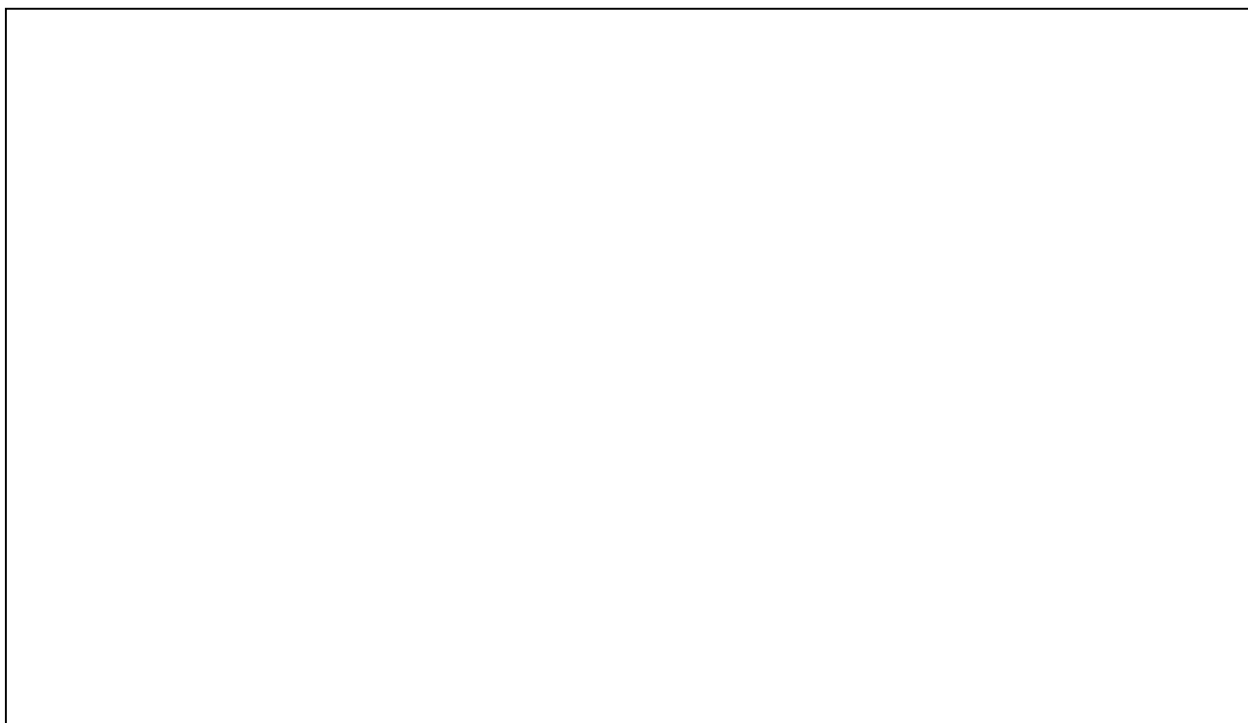

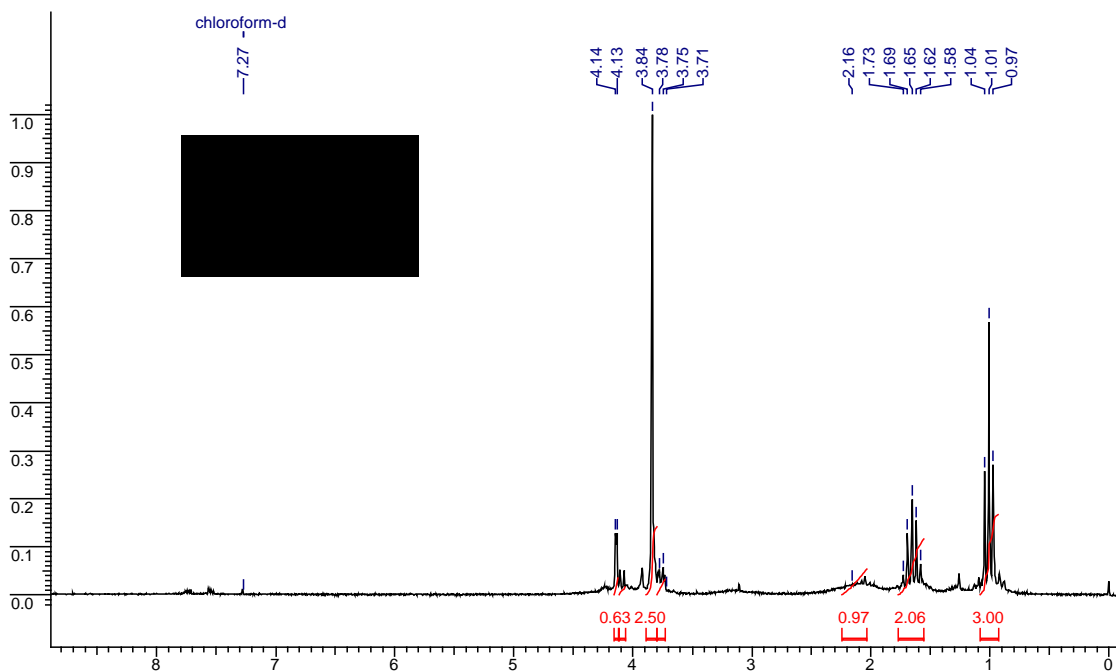

<sup>1</sup>H NMR Spectrum of compound 62 in CDCl<sub>3</sub>

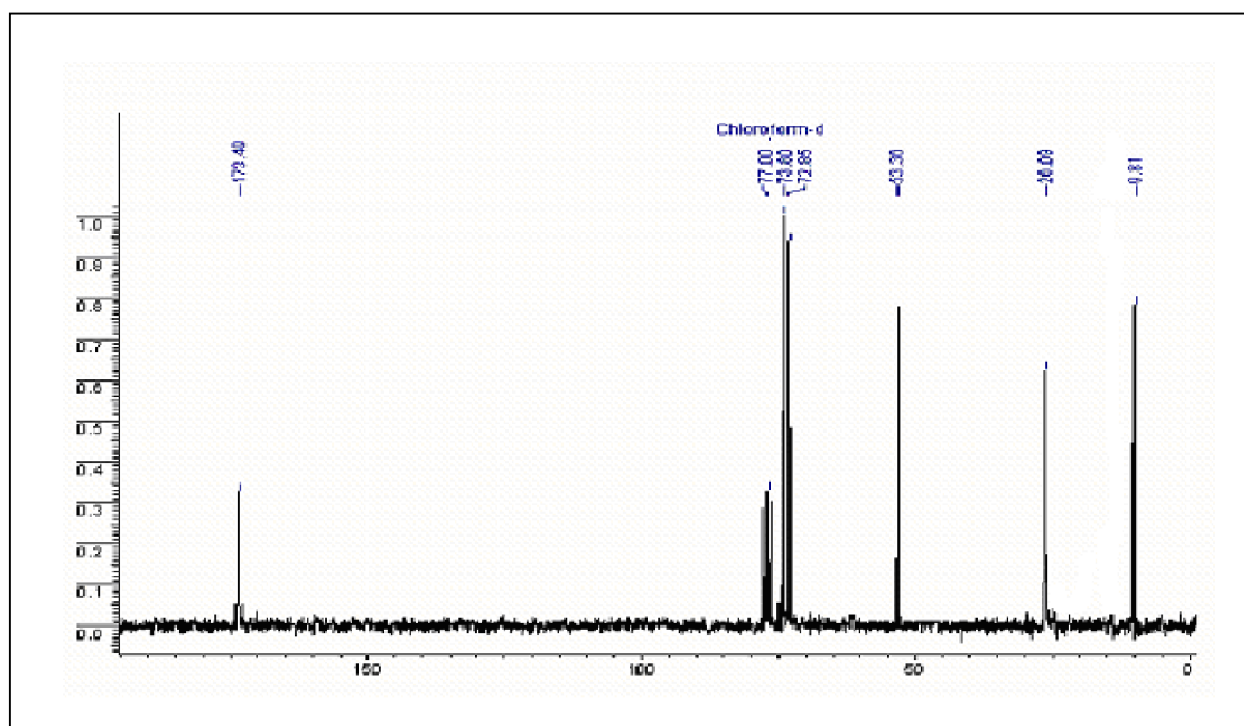

<sup>13</sup>C NMR Spectrum of compound 62 in CDCl<sub>3</sub>



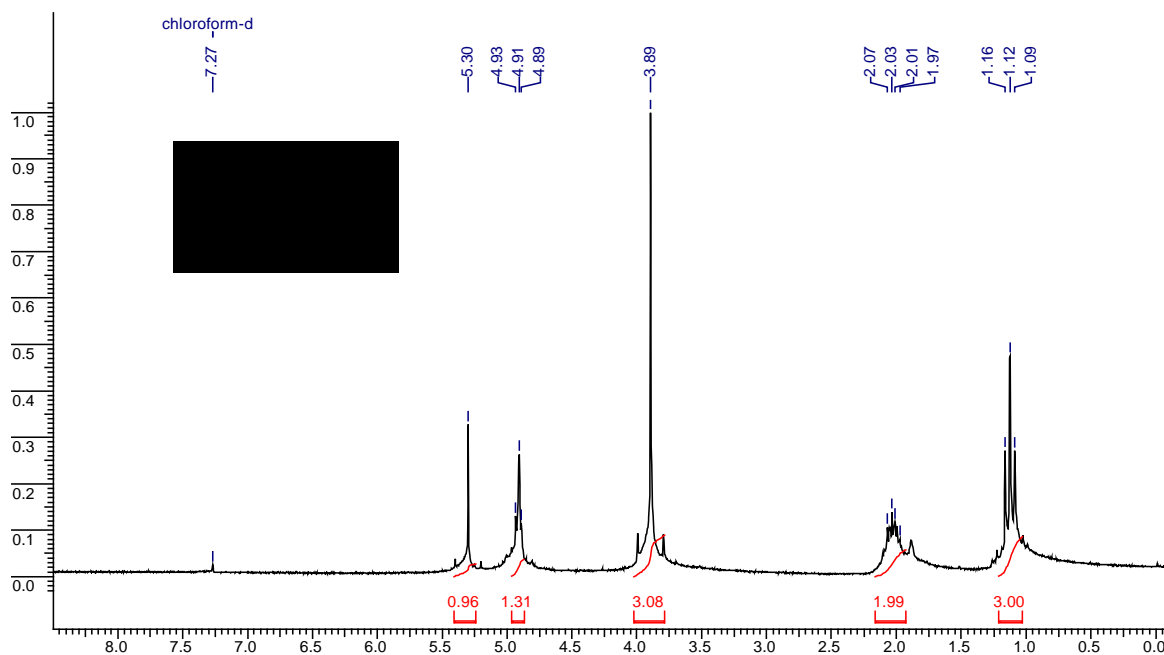

<sup>1</sup>H NMR Spectrum of compound 59 in CDCl<sub>3</sub>

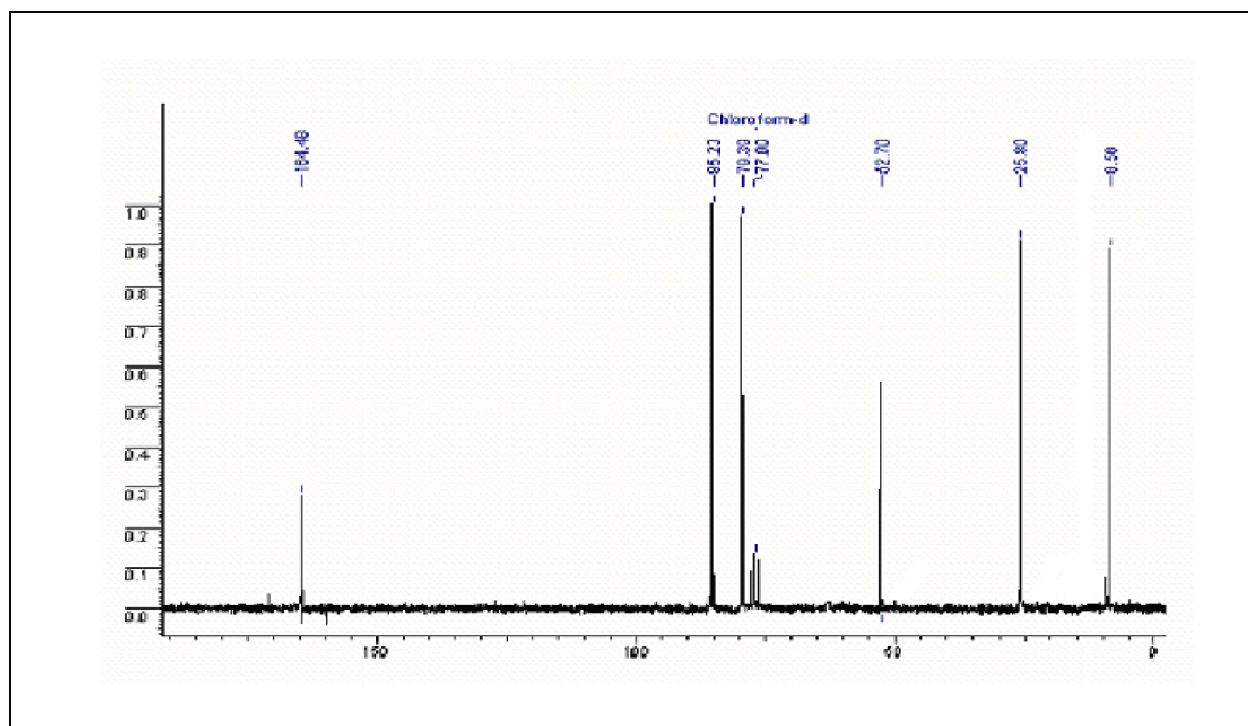

<sup>13</sup>C NMR Spectrum of compound 59 in CDCl<sub>3</sub>

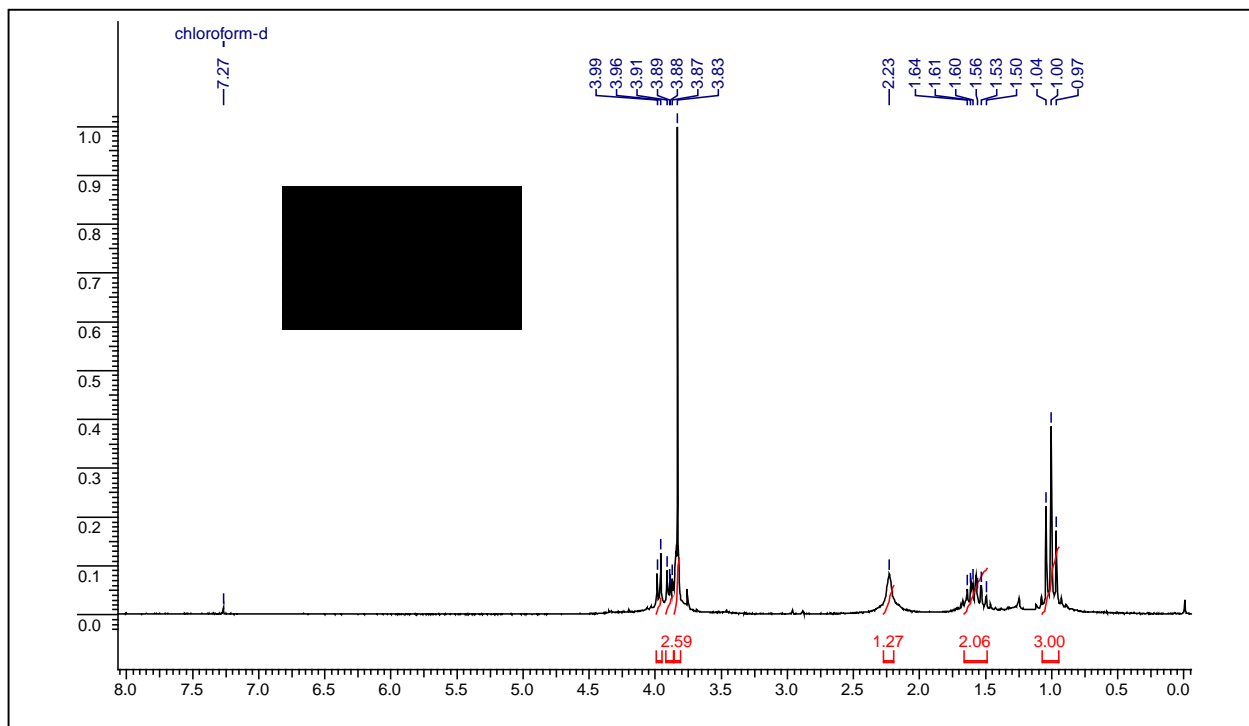

<sup>1</sup>H NMR Spectrum of compound 68 in CDCl<sub>3</sub>

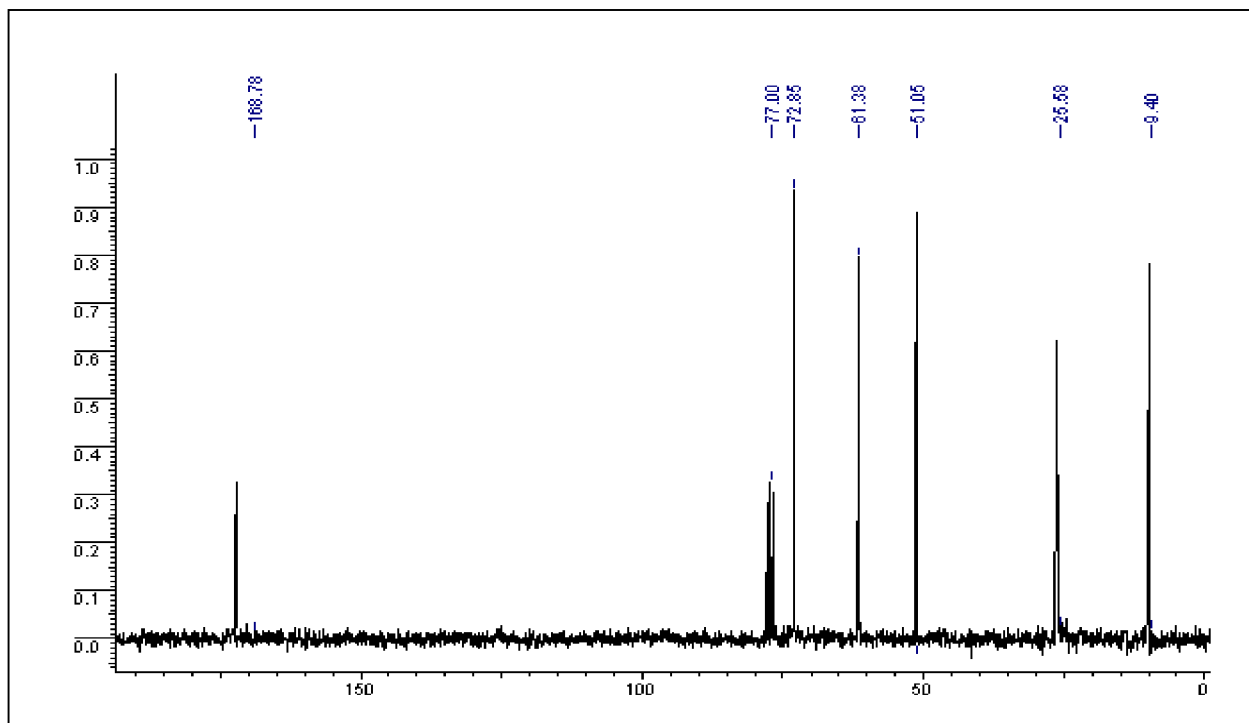

<sup>13</sup>C NMR Spectrum of compound 68 in CDCl<sub>3</sub>

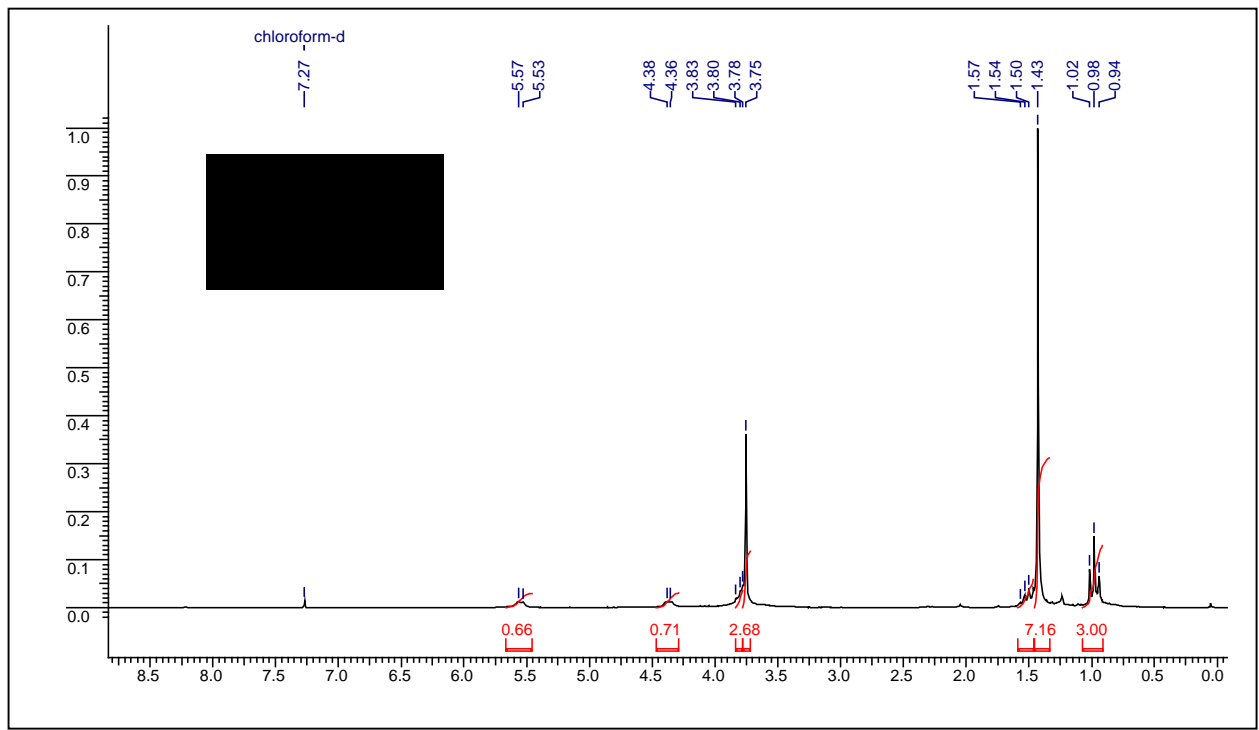

**<sup>1</sup>H NMR Spectrum of compound 56 in CDCl<sub>3</sub>**

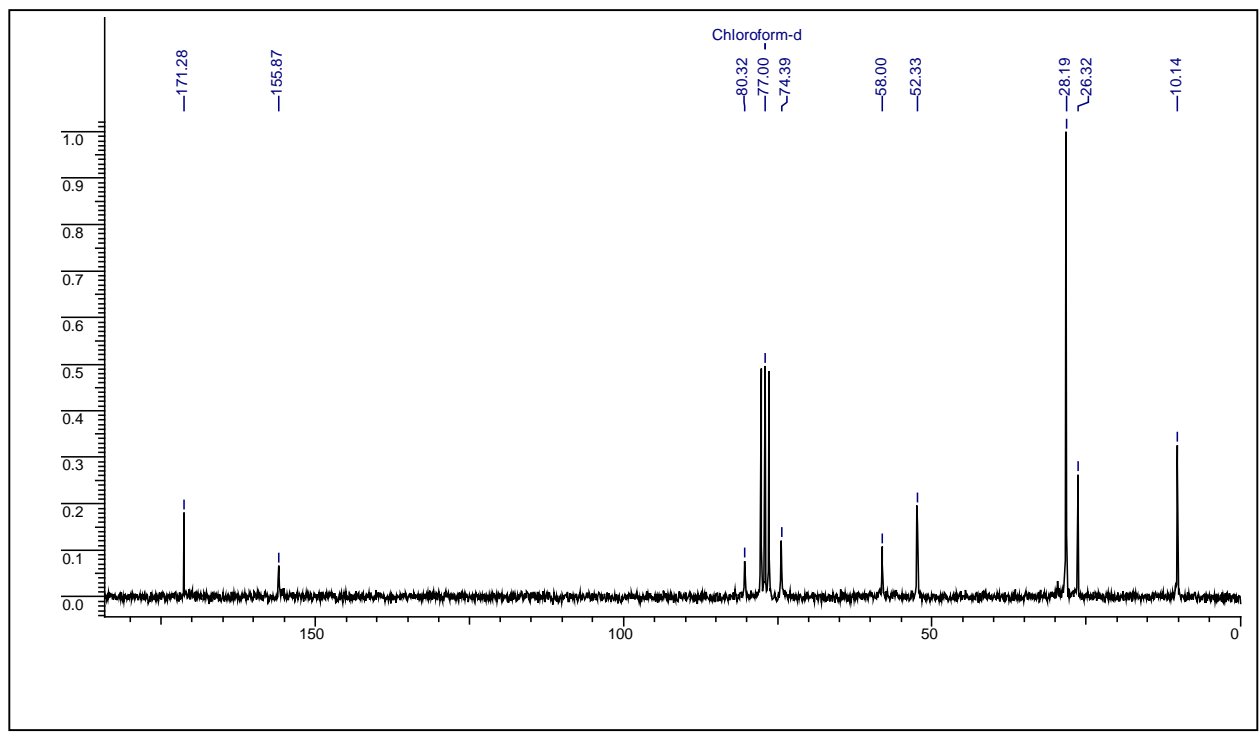

**<sup>13</sup>C NMR Spectrum of compound 56 in CDCl<sub>3</sub>**



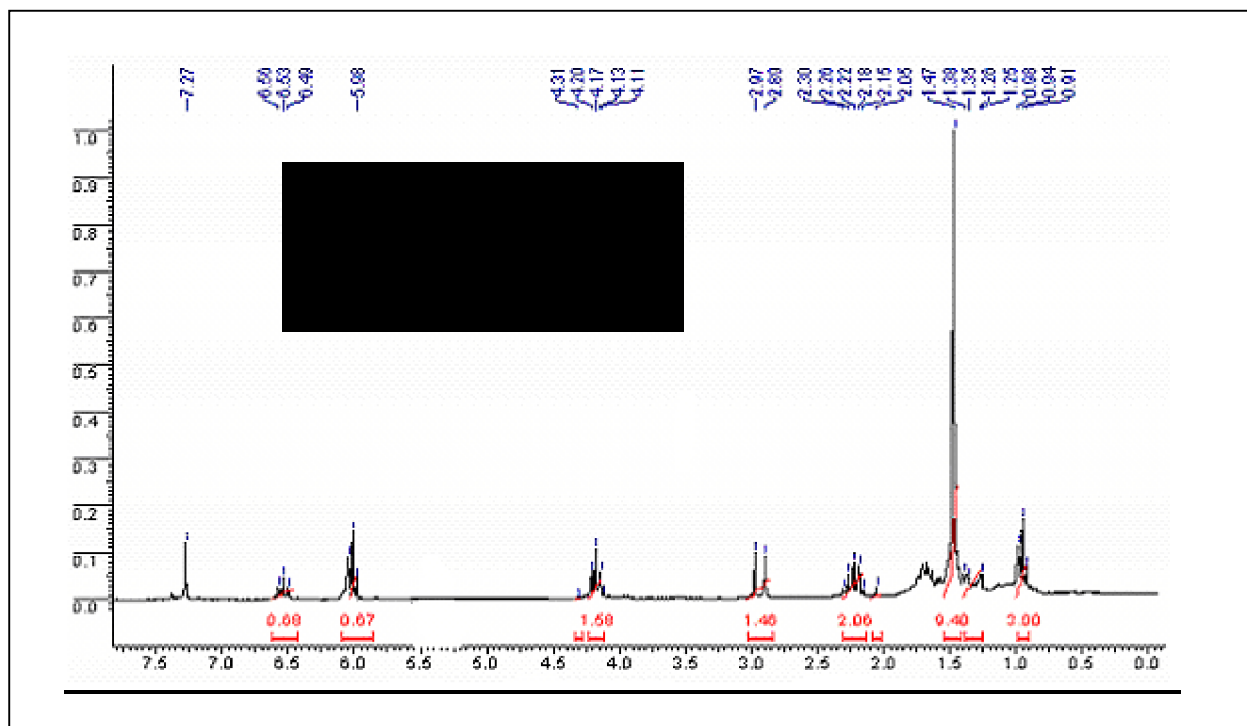

<sup>1</sup>H NMR Spectrum of compound 71 in CDCl<sub>3</sub>

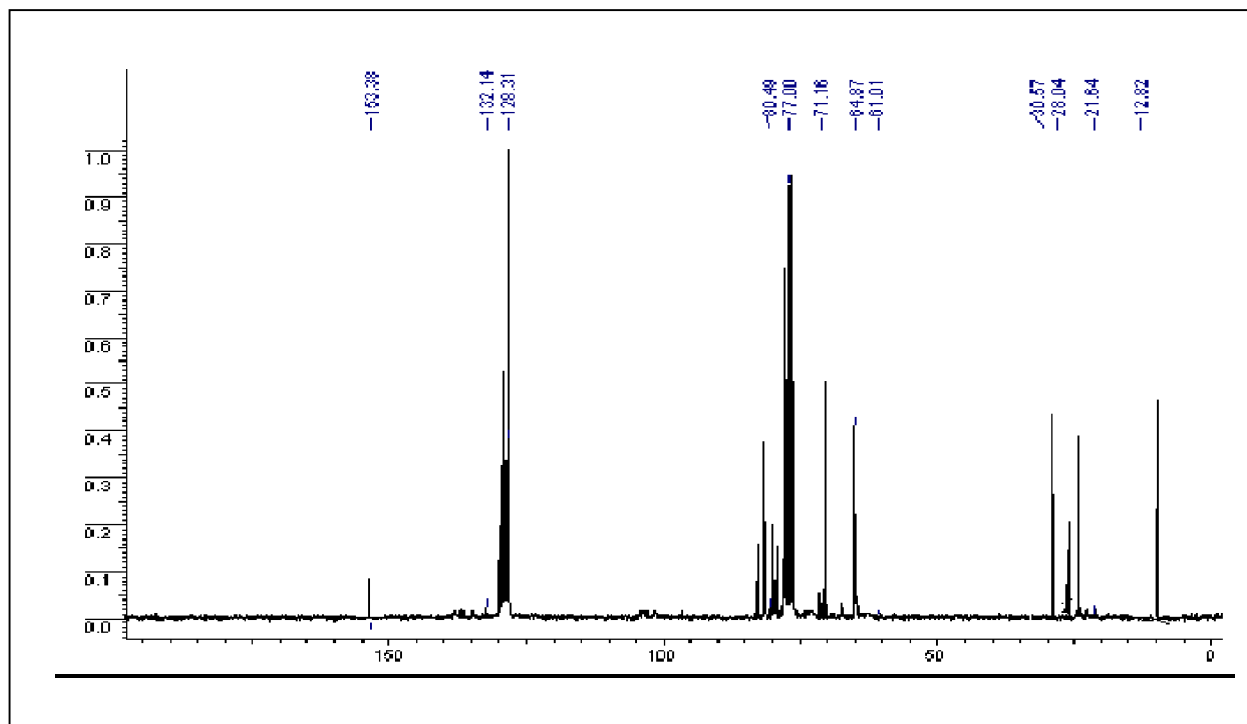

<sup>13</sup>C NMR Spectrum of compound 71 in CDCl<sub>3</sub>

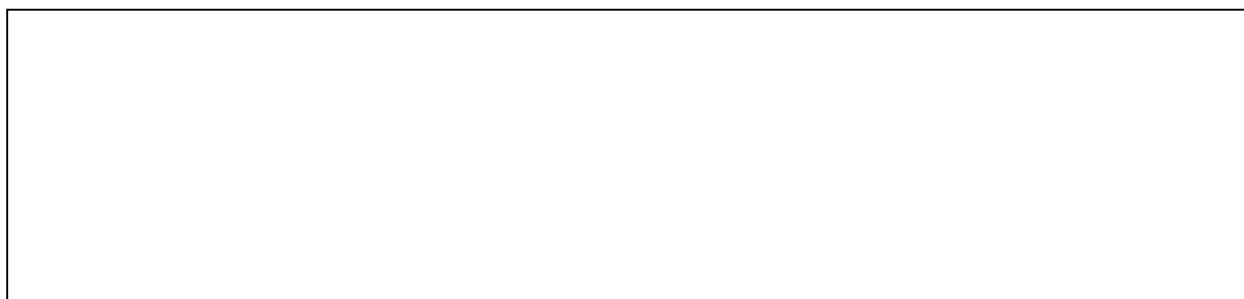

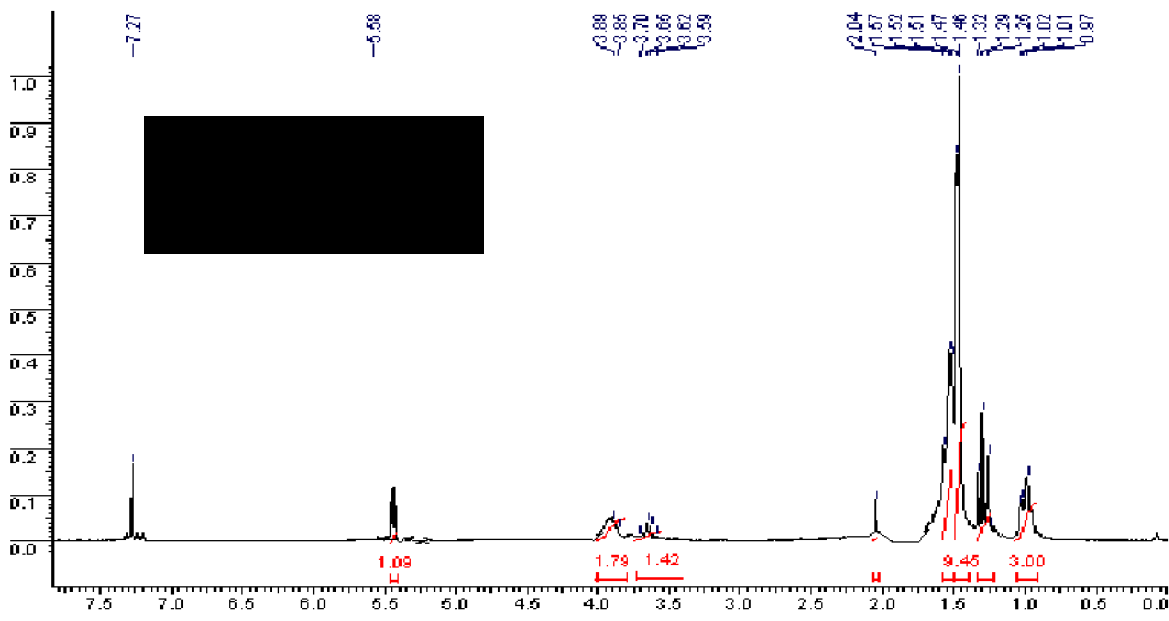

<sup>1</sup>H NMR Spectrum of compound 55 in CDCl<sub>3</sub>

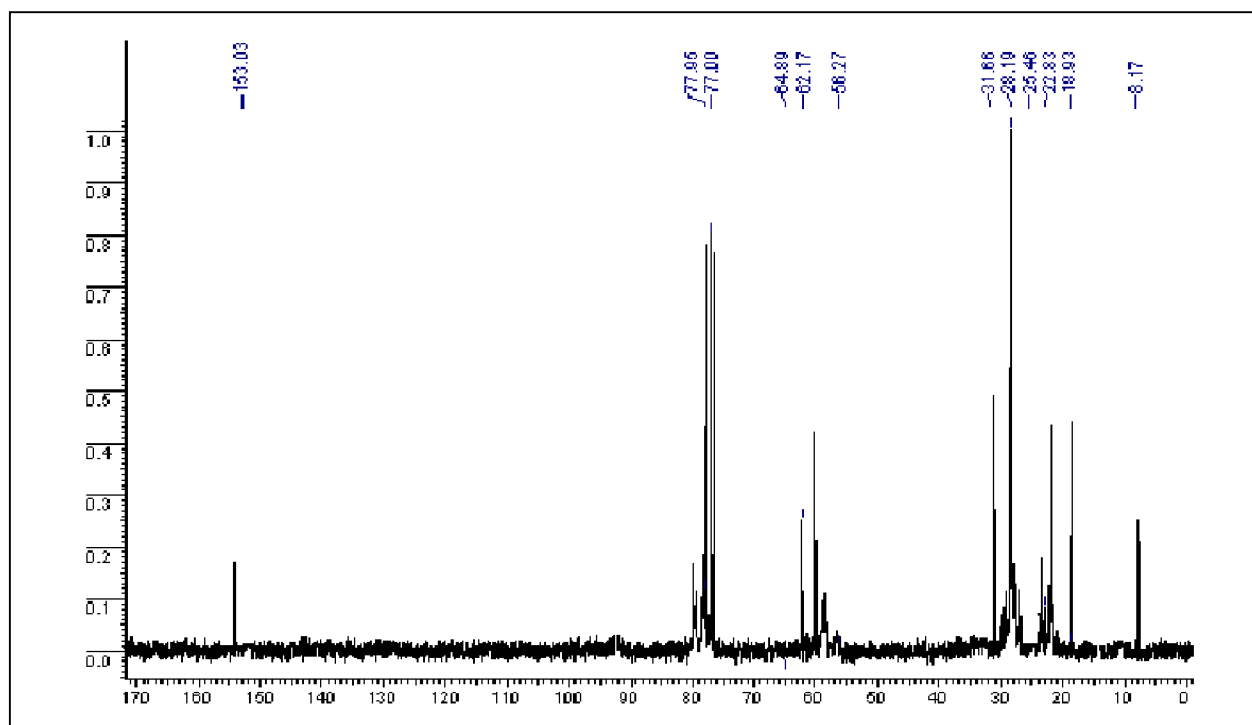

<sup>13</sup>C NMR Spectrum of compound 55 in CDCl<sub>3</sub>

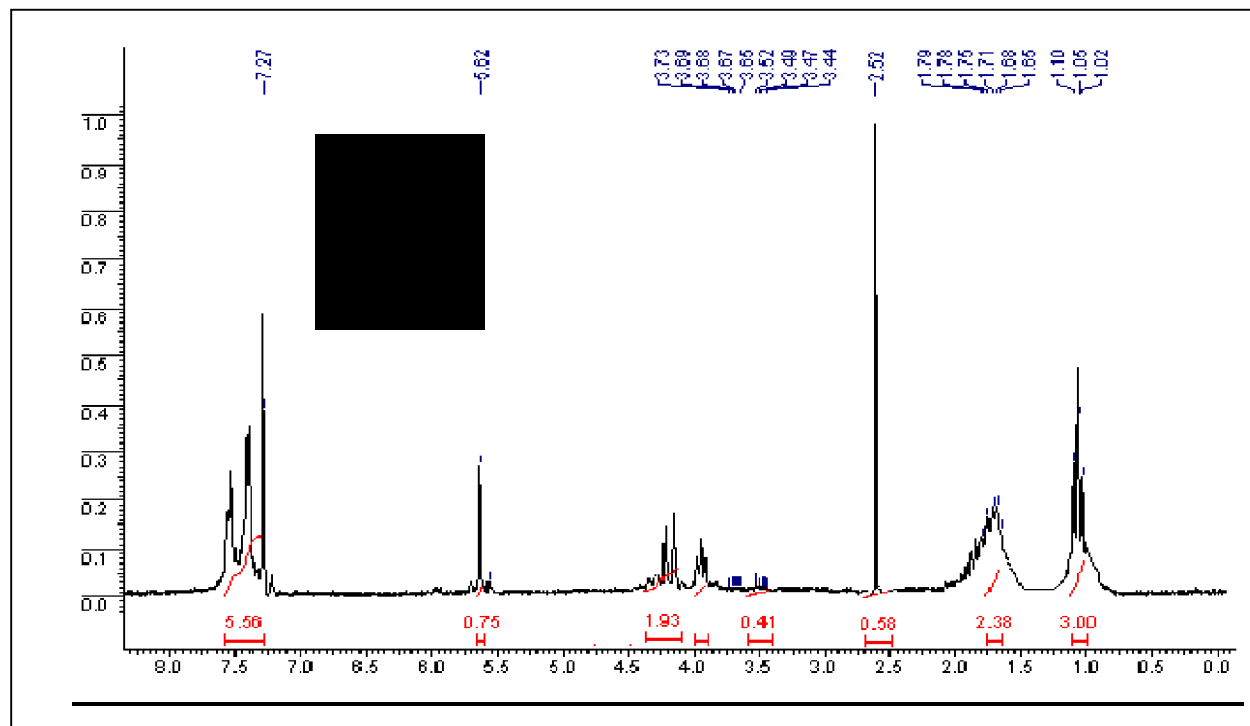

<sup>1</sup>H NMR Spectrum of compound 65 in CDCl<sub>3</sub>

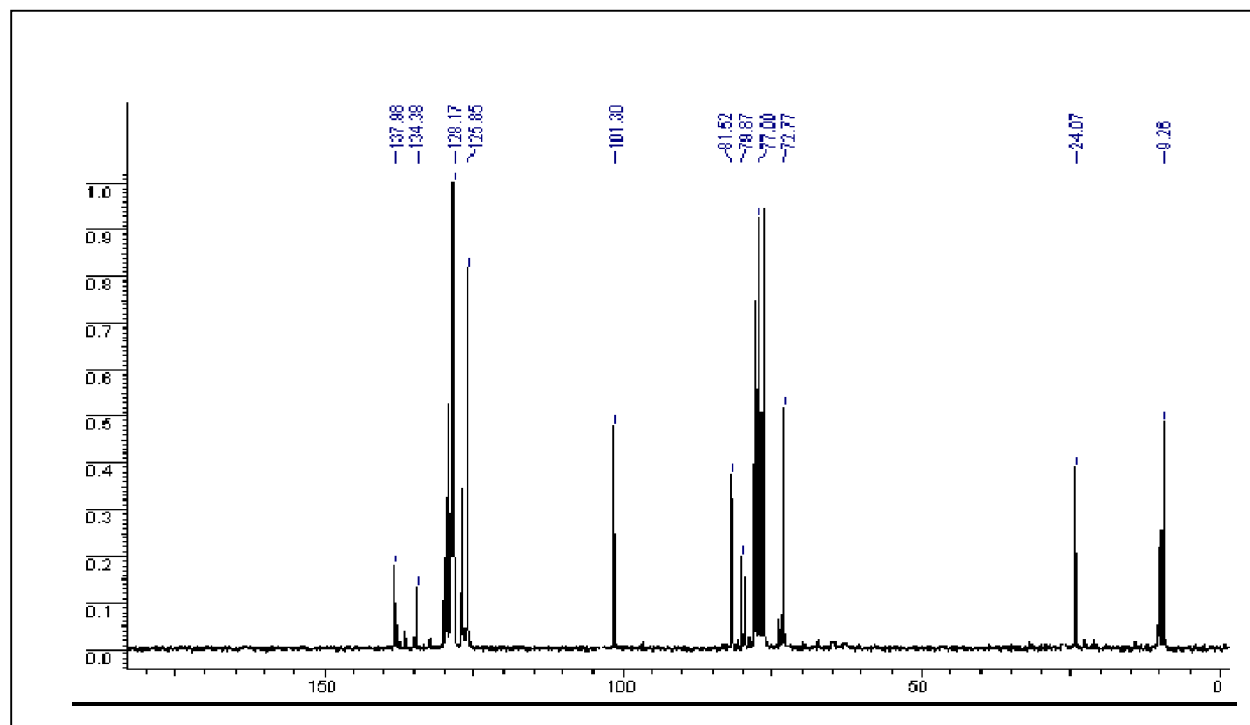

<sup>13</sup>C NMR Spectrum of compound 65 in CDCl<sub>3</sub>



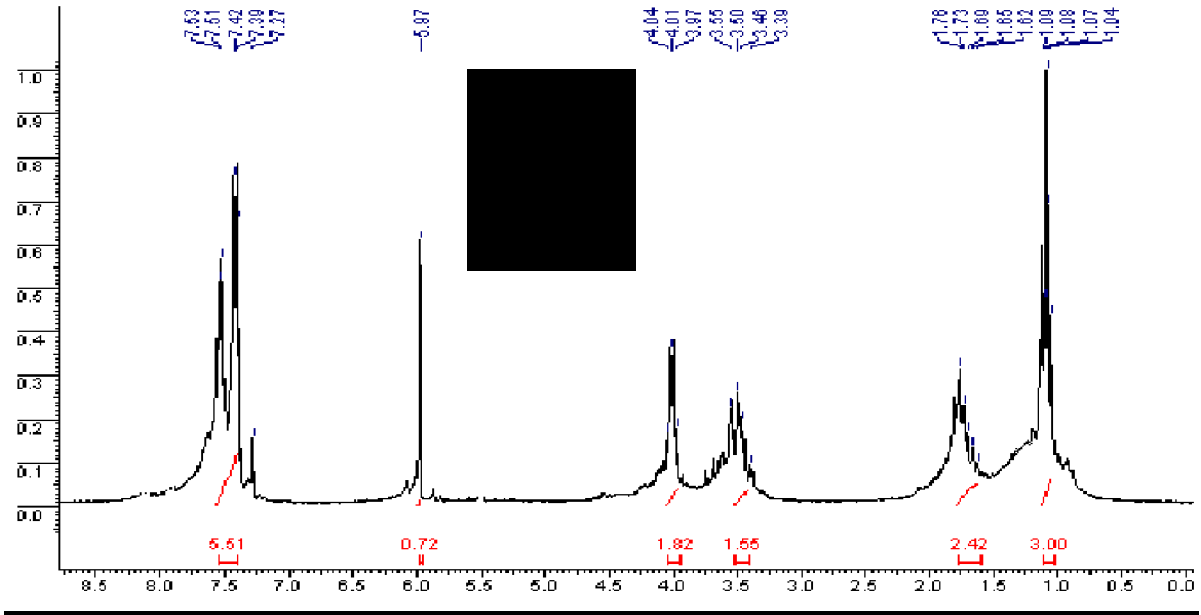

<sup>1</sup>H NMR Spectrum of compound 61 in CDCl<sub>3</sub>

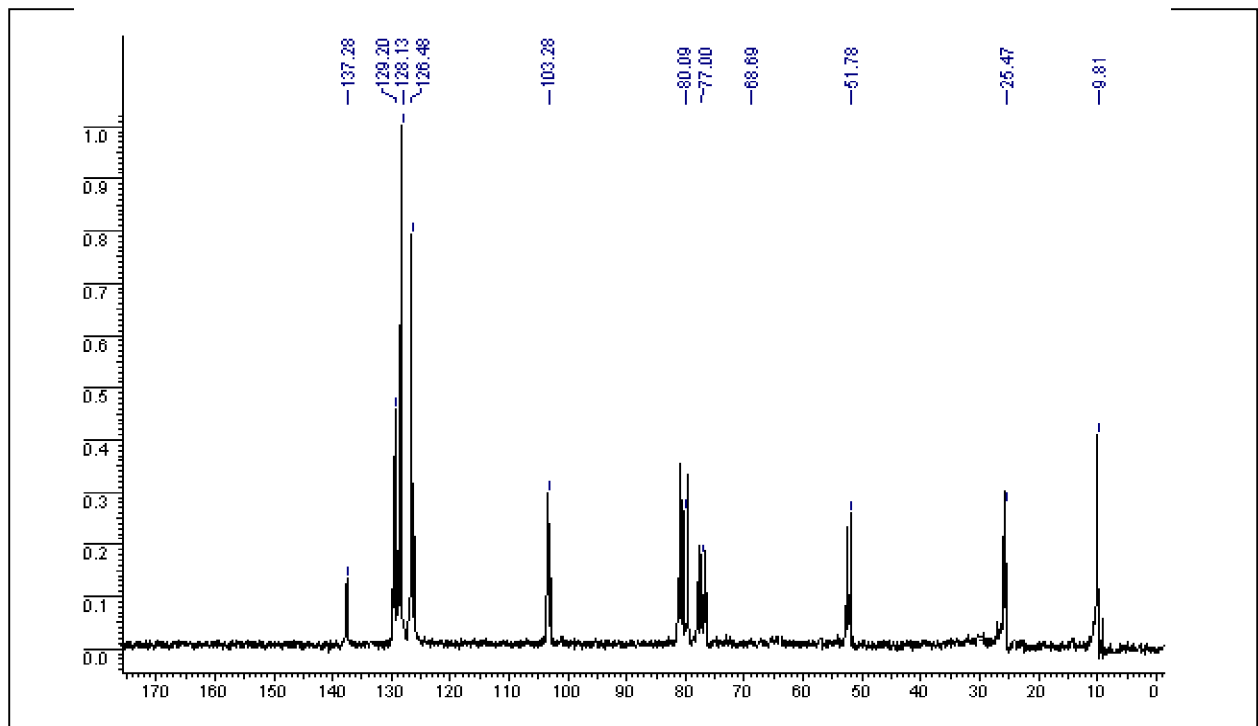

<sup>13</sup>C NMR Spectrum of compound 61 in CDCl<sub>3</sub>



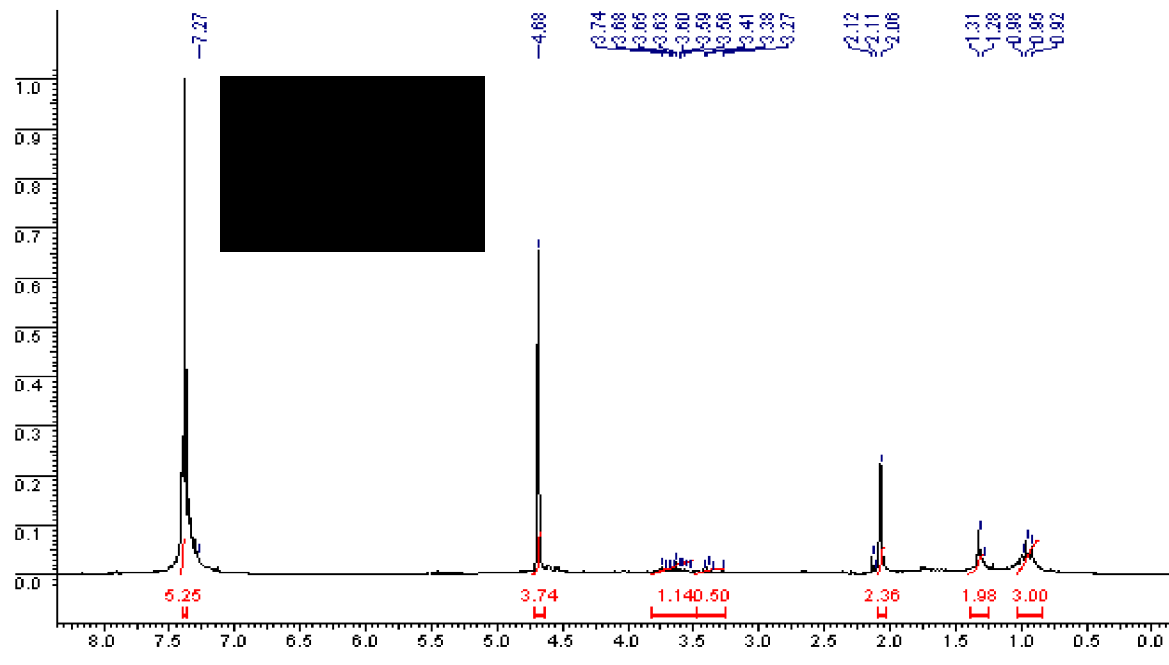

$^1\text{H}$  NMR Spectrum of compound 58 in  $\text{CDCl}_3$

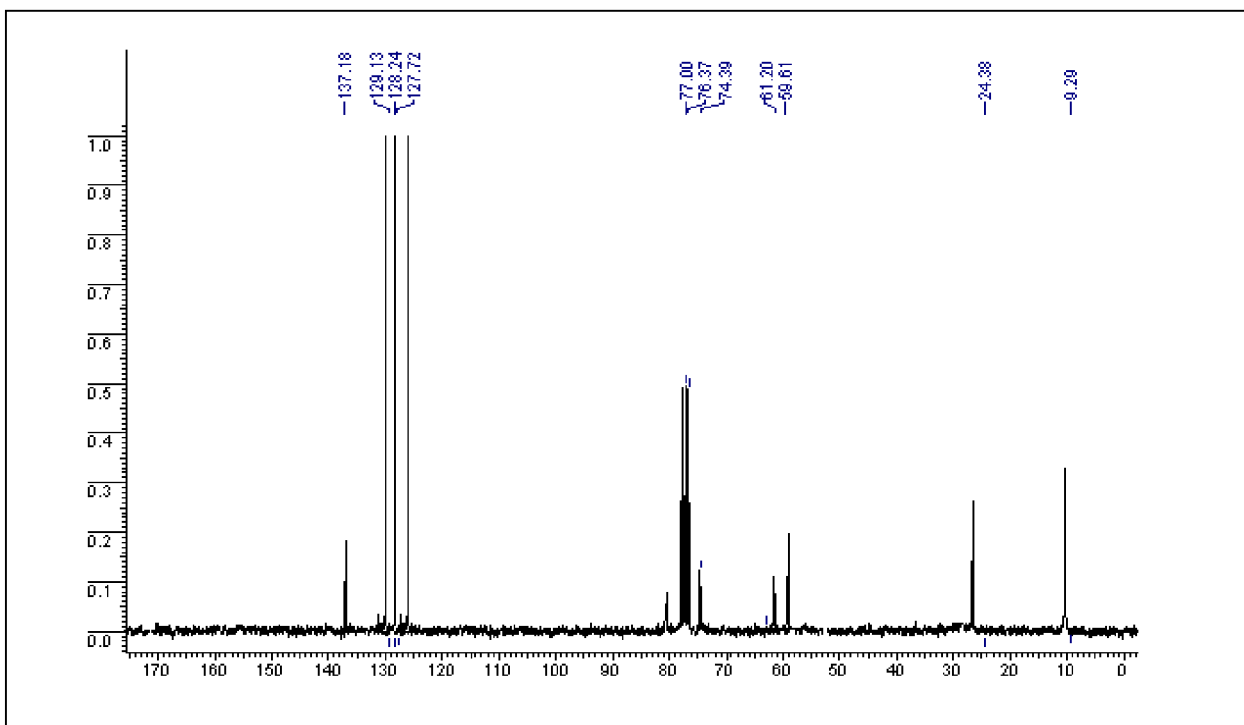

$^{13}\text{C}$  NMR Spectrum of compound 58 in  $\text{CDCl}_3$



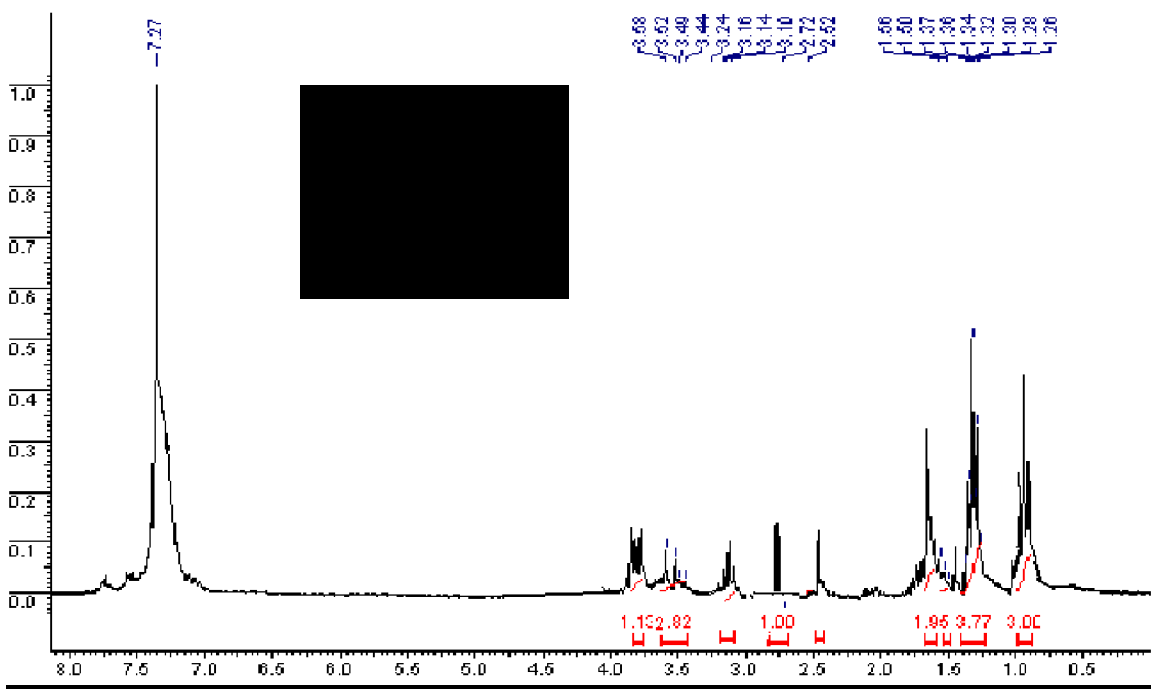

<sup>1</sup>H NMR Spectrum of compound 2 in CDCl<sub>3</sub>

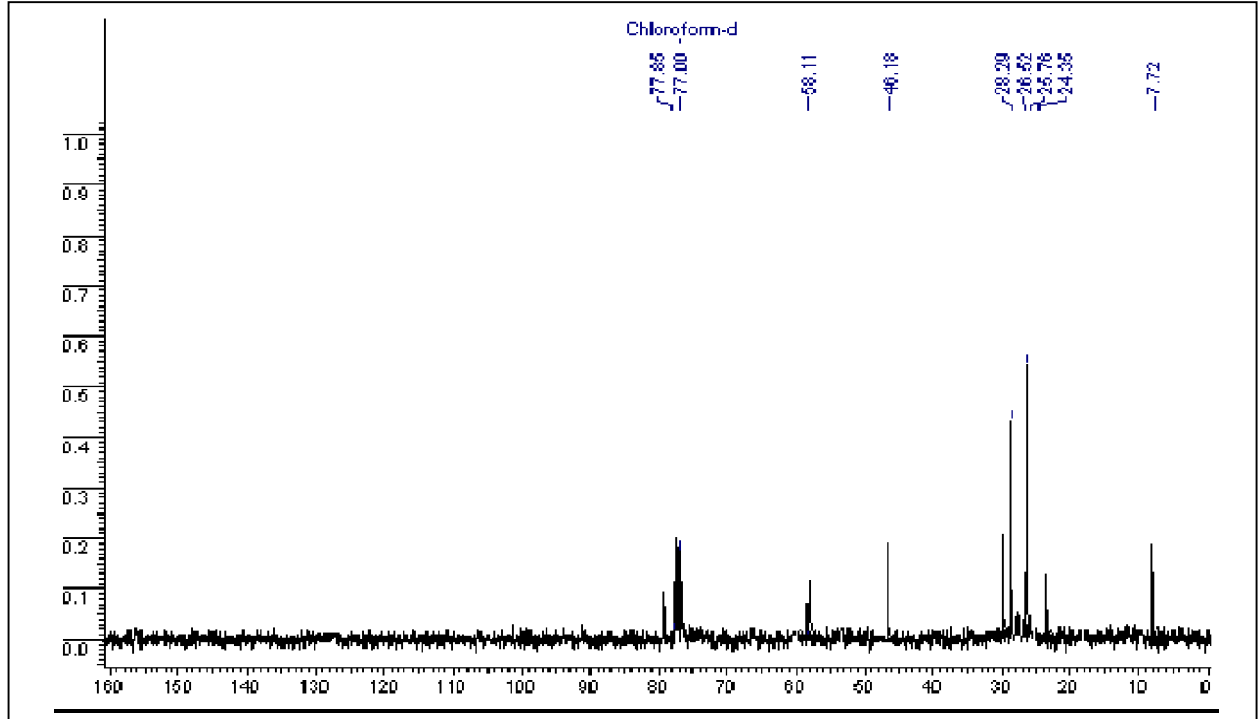

<sup>13</sup>C NMR Spectrum of compound 2 in CDCl<sub>3</sub>

## 3.2 SECTION B: ASYMMETRIC SYNTHESIS OF (-)-ACATERIN

---

### 3.2.1 Introduction

Acyl-CoA cholesterol acyltransferase (ACAT), a microsomal enzyme catalyzes the synthesis of cholesteryl esters from acyl-CoA and cholesterol<sup>16</sup> and cholesteryl accumulation in macrophages incubated with modified low density lipoprotein (LDL), such as acetylated LDL.<sup>17</sup> It plays important role in the control of intracellular cholesterol content via its cholesterol esterifying.<sup>18</sup> ACAT inhibitors play an essential role both in intestinal absorption of cholesterol and cholesteryl ester formation in a variety of tissues and cells.<sup>19</sup> Since elevated plasma of cholesterol is related to an increased risk of coronary heart disease and massive accumulation of cholesteryl esters in macrophage-derived foam cells, is a hallmark of the atherosclerotic plaques. Inhibitors of acyl-CoA : cholesterol acyltransferase (ACAT) activity are expected to be effective for treatment of atherosclerosis and hypercholesterolemia.<sup>20</sup> Although, several synthetic ACAT inhibitors are known,<sup>21</sup> those of natural origin have rarely been reported.<sup>22</sup> (**Fig. 2**)

Acaterin<sup>23</sup> (**Fig. 3**), a novel inhibitor of acylCoA : cholesterol acyltransferase (ACAT), was isolated from a culture broth of pseudomonas sp. A 92 by Dianion HP-20 column chromatography, solvent extraction and reverse phase HPLC. Spectroscopic analyses of the compound yielded 3-(1-hydroxyoctyl)-5-methyl-2(5H)-furanone as the proposed structure. In the presence of oxidised low density lipoprotein, acaterin inhibited the synthesis of cholesteryl ester in macrophage J774 by 50% at a concentration of 45 micro M.

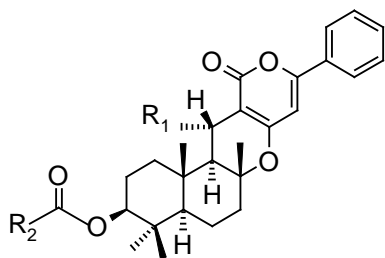

GER1-BP00 M  $R_1 = H$   $R_2 = CH_3$  (74A)

GER1-BP00 A  $R_1 = OH$   $R_2 = CH_3$  (74B)

GER1-BP00 B  $R_1 = H$   $R_2 = CH_2CH_3$  (74C)

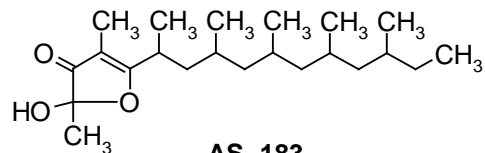

AS-183

75

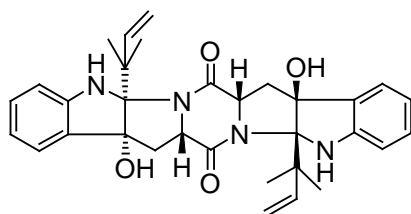

Gypsetin

76

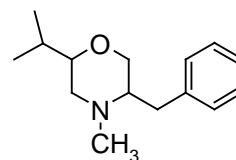

Lateritin

77

Figure 2

Acaterin also inhibited ACAT activity in the rat liver microsomes by 50% at a concentration of 120 micro M. Kinetic studies showed that inhibition of ACAT by acaterin was noncompetitive with respect to Oleoyl-CoA. Acaterin contains butenolide skeleton with alkyl chain at C-2 position, which is related to *annonaceous acetogenins*,<sup>24</sup> such as Uvaricin,<sup>25</sup> with remarkable antitumor activity.

### 3.2.2 Review of Literature

**Kitahara *et al.*<sup>26</sup> first synthesized all stereoisomers of cholesterol inhibitor acaterin through determination of its absolute configuration.**

**Since then very few synthetic approaches have appeared in the literature. Biosynthesis of acaterin was described by Fujimoto *et al.*<sup>27</sup> using labelling studies. Very recently, two similar synthetic routes have been presented using Baylis-Hillman reaction as key step. Singh<sup>28</sup> and co-workers have used direct Baylis-Hillman reaction followed by ring-closing metathesis as key steps, whereas the first synthetic application of the Baylis-Hillman reaction to  $\alpha,\beta$ -unsaturated lactones was utilized for the synthesis of acaterin by Figadere *et al.*<sup>29</sup>**



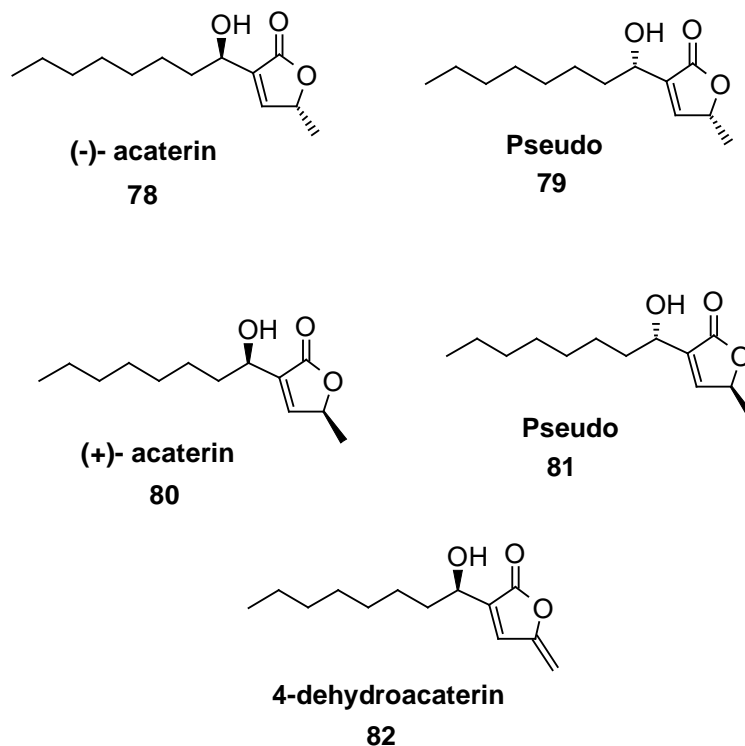
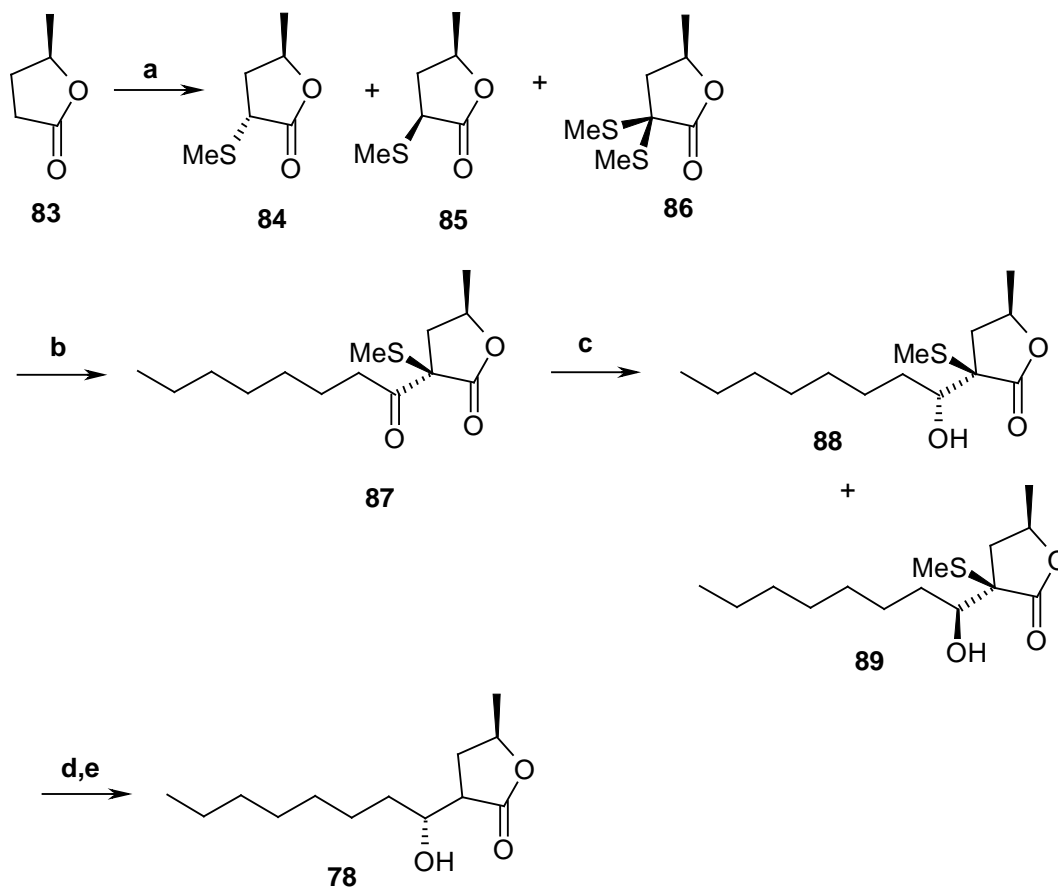

Figure 3

Kitahara *et al.*<sup>26</sup> (Scheme 14)

The synthetic sequence of Kitahara group was based on the construction of  $\alpha$ -alkyl thio- $\gamma$ -lactones from readily available chiral source, ethyl 3-hydroxybutanoate, (*S*)- and (*R*) 83. In order to establish the synthetic scheme and relative stereochemistry, (*R*)- and (*S*)- $\gamma$ -valerolactones were prepared from corresponding 3-hydroxybutanoates. (*R*)- $\gamma$ -Valerolactone was treated with LDA and methyl methanethiosulfonate and resultant separable product was treated with LDA and octanoyl chloride to afford single  $\beta$ -keto lactone 87. Reduction of 87 with  $\text{NaBH}_4$  in aqueous THF followed by MCPBA oxidation and pyrolysis gave natural acaterin 78.



**Scheme 14**

**Scheme 14 : Reaction conditions :** (a) LDA, MeSSO<sub>2</sub>, THF, -78 °C to -20 °C, 2.5 h, 69% ; (b) LDA, *n*-C<sub>7</sub>H<sub>15</sub>COCl, THF, -78 °C to -10 °C, 2.5 h, 73% ; (c) NaBH<sub>4</sub>, THF-H<sub>2</sub>O (10:1), -5 °C, 1 h, 44% ; (d) MCPBA, CH<sub>2</sub>Cl<sub>2</sub>, -78 °C, 15 min ; (e) CaCO<sub>3</sub>, toluene, reflux, 3 h, 64% in two steps.

Fujimoto *et al.*<sup>27</sup> (Scheme 15)

**Fujimoto's approach explains the biosynthesis of acaterin through feeding experiments with <sup>2</sup>H-and <sup>13</sup>C labelled decanoic acid which suggested that acaterin is biosynthesized via coupling of a C<sub>5</sub> unit with octanoate, rather than via introduction of a C<sub>3</sub> unit at the  $\alpha$ -position of a decanoate derivative. Further feeding study of [2,3-<sup>13</sup>C<sub>2</sub>] decanoic acid concluded that the former route is operating in the biosynthesis of acaterin.**

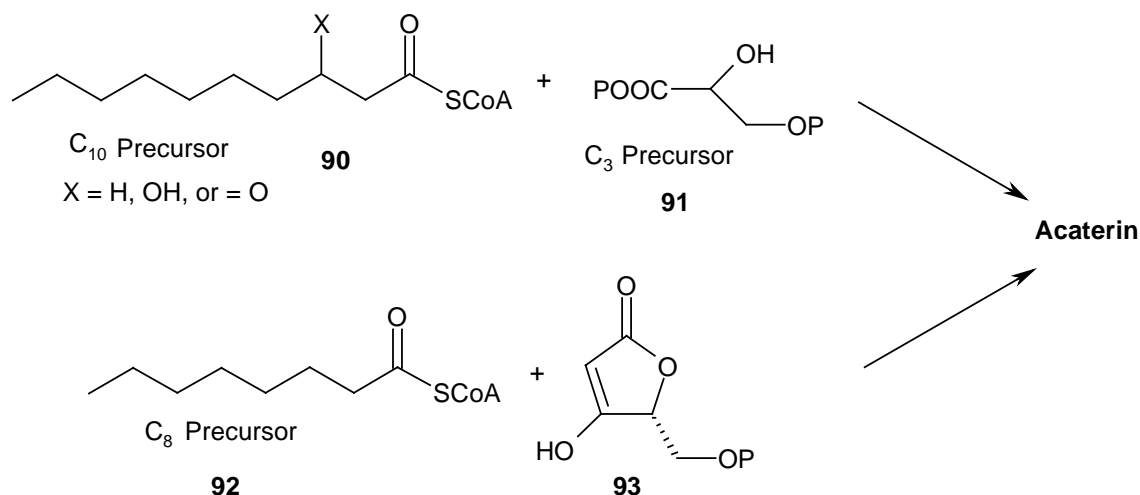

Scheme 15 : Two possible modes in the biosynthesis of acaterin

Singh *et al.*<sup>28</sup> (Scheme 16)

**Singh and co-workers reported the asymmetric synthesis of (-)-acaterin 78 and its diastereomer through ring closing metathesis. The Baylis-Hillman reaction of caprylic aldehyde 94 with methyl acrylate in the presence of a catalytic amount of quinuclidine gave 95 followed by protection of free hydroxy group using 2-methoxy ethoxymethyl chloride. Hydrolysis of ester 96 and subsequent DCC coupling with *R*-(*-*)-3-buten-2-ol furnished 98. Finally, the butenolide skeleton was achieved using RCM which gave a 1:1 diastereomeric mixture of cyclized products 99 and 100 which were separated by radial chromatography. The absolute configurations were assigned after conversion to natural acaterin and its diastereomer using  $TiCl_4$ .**

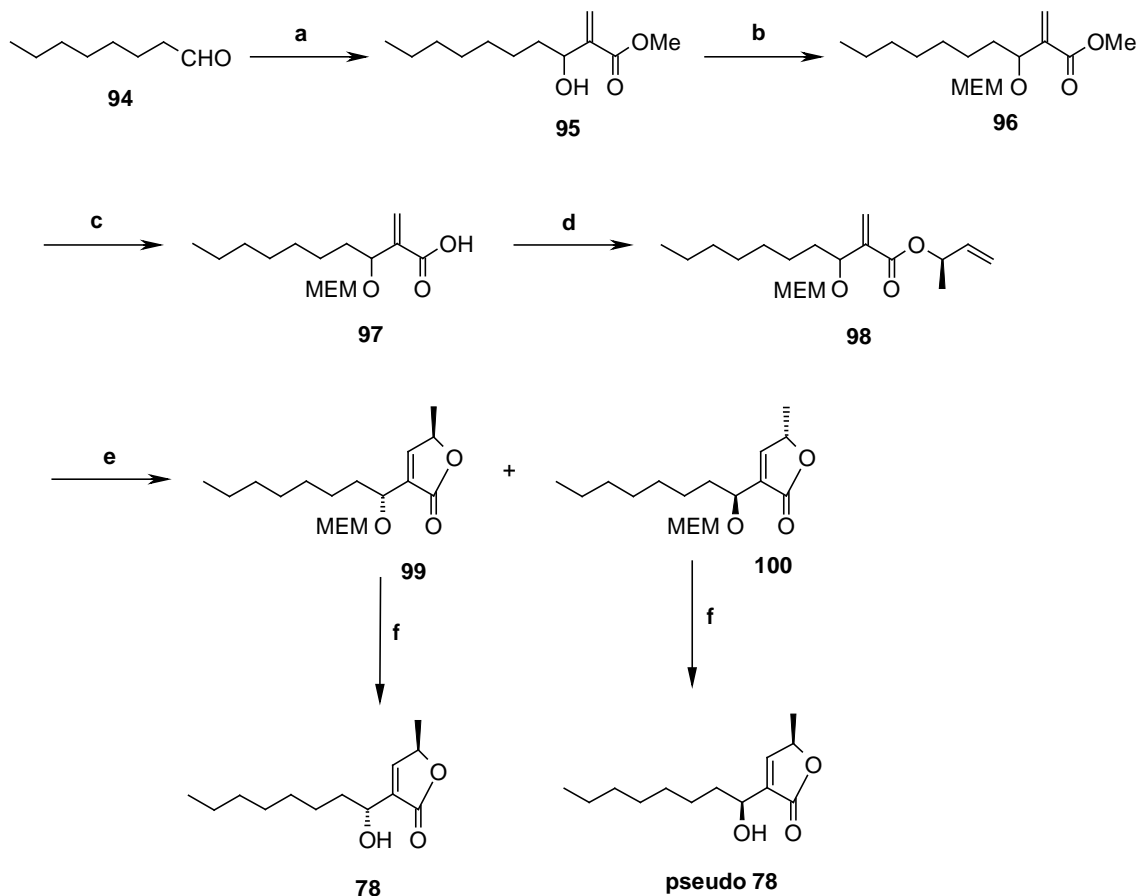

**Scheme 16**

**Scheme 16 : Reaction conditions :** (a) Methyl acrylate, quiniclidine, 48 h, 72% ; (b) 2-methoxyethoxy chloride, *N*-ethyl-diisopropyl amine, DCM, 6 h, 83% ; (c) 1 N aq. LiOH, THF/water (2:1), 24 h ; (d) *R*-(-)-3-buten-2-ol, DCC, DMAP, DCM, 24 h ; (e) Grubb's catalyst (30 mol%), DCM, reflux, 48 h ; (f) TiCl<sub>4</sub>, DCM, 8 h.

Figadere *et al.*<sup>29</sup> (Scheme 17)

**The first application of the Baylis-Hillman reaction to  $\alpha,\beta$ -unsaturated lactones was used for the synthesis of acaterin as shown in Scheme 17. In this report, Baylis-Hillman conditions were employed for the synthesis of racemic acaterin via the coupling of  $\delta$ -butyrolactone with octanal. However, their attempts to employ this strategy for obtaining enantiopure acaterin starting from 101 which was prepared by asymmetric reduction of the required  $\alpha$ -chlorinated ketone with Baker's yeast<sup>30</sup> were unsuccessful due to the possible racemization as shown in Scheme 18.**

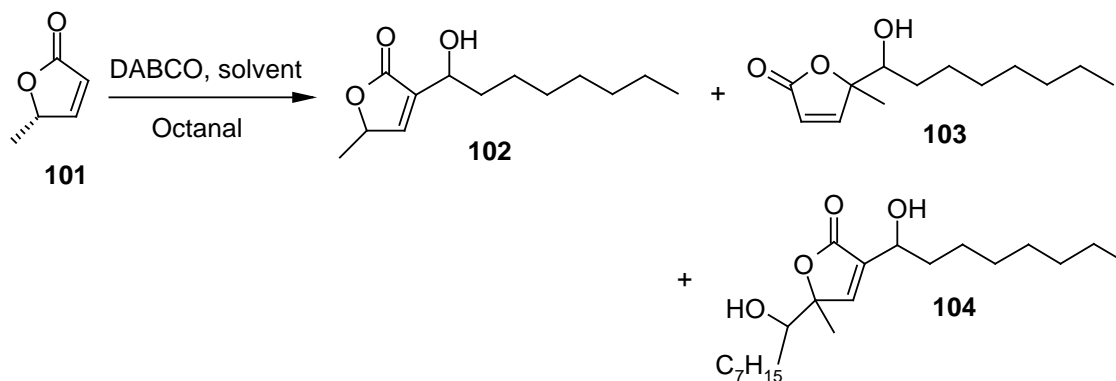

Scheme 17

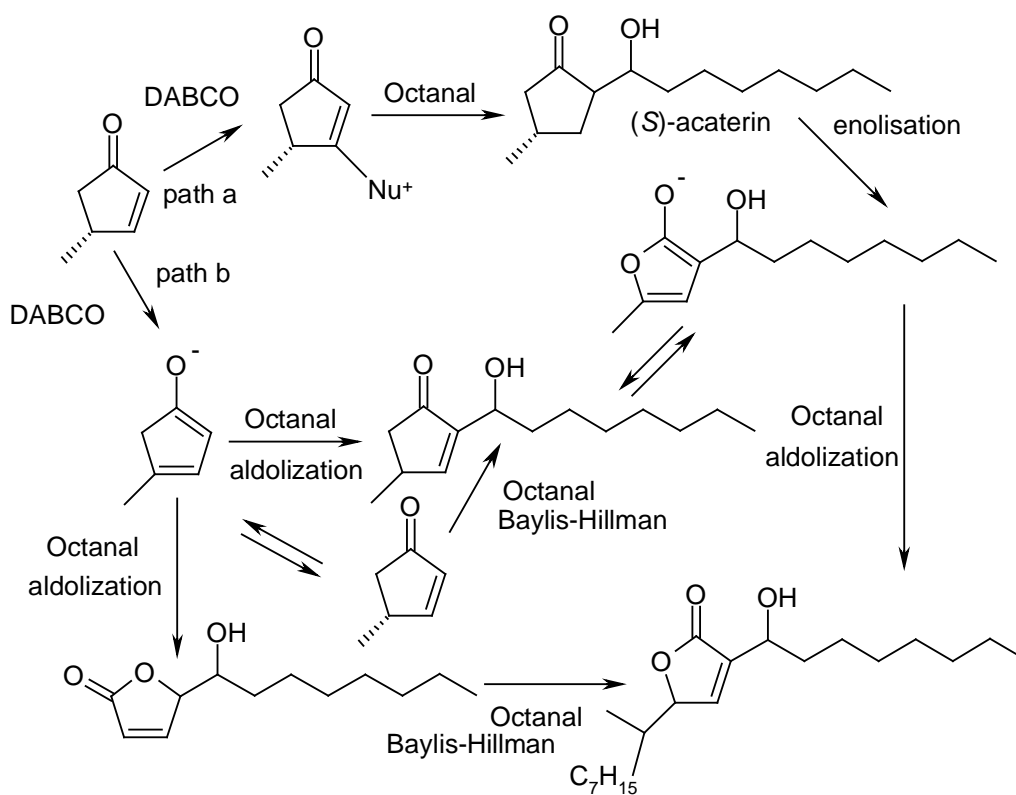

Scheme 18

### 3.2.3 Present work

#### Objective

A very few syntheses of (-)-acaterin were documented in the literature mainly using Baylis-Hillman reaction and ring closing metathesis as key steps. Hence, a general strategy with limited steps and higher optical purity to achieve the synthesis of all the stereoisomers of acaterin is still

desirable. The Sharpless asymmetric dihydroxylation of  $\alpha,\beta$ -unsaturated esters is an excellent method to prepare chiral diols in a highly enantiomeric purity. Thus, the objective of present work is to devise a new synthesis of (-)-acaterin employing AD as the key step and source of chirality.

### 3.2.4 Results and Discussion

The retrosynthetic analysis for the asymmetric synthesis of (-)-acaterin 78 is shown in Scheme 19. The left half of (-)-acaterin is represented by the fragment 105, which could be derived from regioselective conversion of diol 107 which in turn would be obtained from the Sharpless asymmetric dihydroxylation of  $\alpha,\beta$ -unsaturated olefin 109. The olefin 109 in turn could be easily derived from octanol 110. The right half fragment 106 of (-)-acaterin would be easily obtained from commercially available methyl-(*R*)-lactate 108. Thus, the hydroxyl center in (-)-acaterin 78 would be obtained from AD and the butenolide ring can be constructed using Wittig olefination and subsequent cyclization.

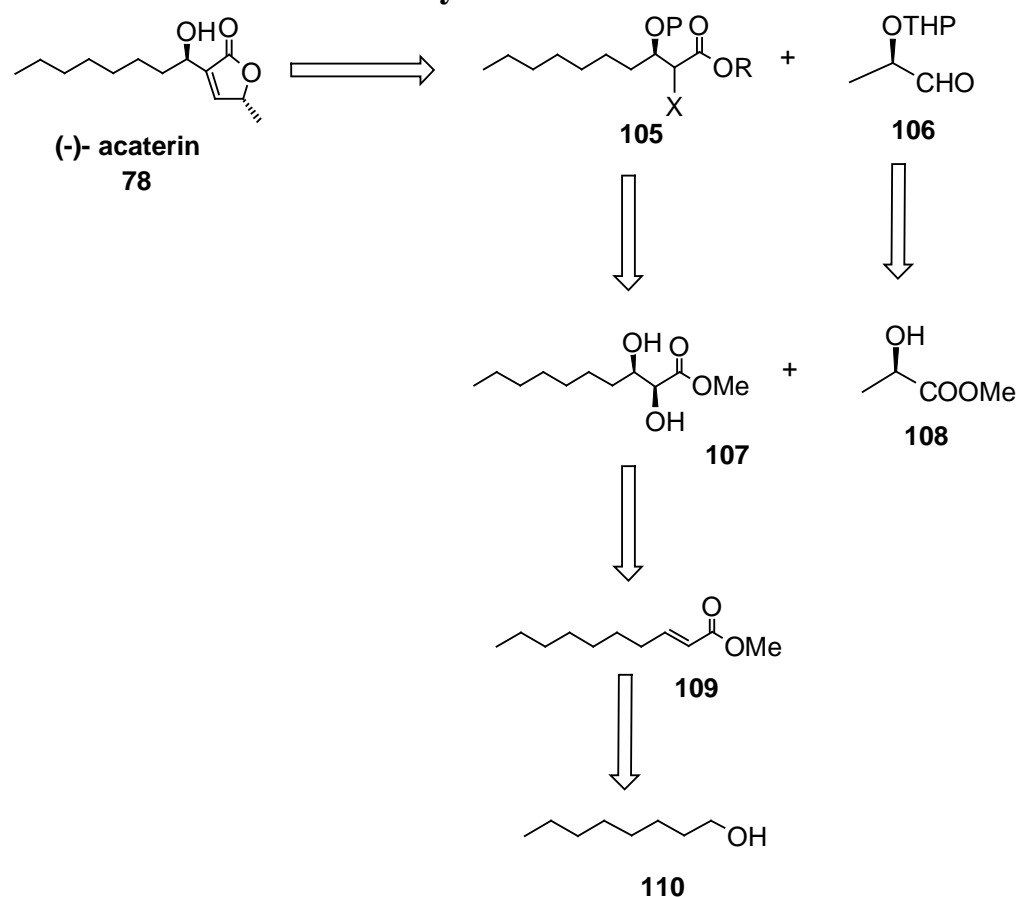

Scheme 19 : Retrosynthetic analysis of (-)-acaterin

The detailed synthetic route and reaction conditions are given in Scheme 20. The synthesis of (-)-acaterin 78 started from commercially available octan-1-ol 110 which was oxidised using  $P_2O_5$ , dry dimethyl sulfoxide and triethyl amine in dry dichloromethane at  $0\text{ }^\circ\text{C}$  to afford aldehyde which was used in the next step without further purification. The crude  $^1\text{H}$  NMR of aldehyde showed singlet at  $\delta$  9.2 indicating the presence of product aldehyde. The aldehyde was subsequently treated in dry THF under reflux conditions with (methoxycarbonylmethylene)triphenylphosphorane to give the *trans*-olefin 109 in excellent yield. The IR spectrum of 109 showed strong absorption peaks for olefin and carbonyl at  $\delta$  1610, 1720  $\text{cm}^{-1}$  respectively. Olefin peaks were confirmed by  $^1\text{H}$  and  $^{13}\text{C}$  NMR which showed 5.77 (doublet,  $J = 14\text{ Hz}$ ), 6.88-6.99 (multiplet) and 121.1, 148.8 respectively. The Sharpless asymmetric dihydroxylation of olefin 109 using  $(\text{DHQD})_2\text{PHAL}$  as chiral ligand and catalytic  $\text{OsO}_4$  as oxidant and potassium ferricyanide as co-oxidant in *t*-butanol/water gave the diol 107 in 98% yield with excellent enantiomeric purity [ $[\alpha]_D^{25} : + 10.1$  ( $c$  1.42,  $\text{CHCl}_3$ ), [lit.<sup>31</sup> $[\alpha]_D^{25} : + 11.23$  ( $c$  1,  $\text{CHCl}_3$ )]. The IR spectrum of 107 showed hydroxyl absorption at  $3452\text{ cm}^{-1}$ . In the  $^1\text{H}$  NMR spectrum, the olefinic protons disappeared and in the  $^{13}\text{C}$  NMR spectrum, the hydroxyl carbons appeared at  $\delta$  72.4 and 73.2. Regioselective conversion of dihydroxy compound 107 to bromohydrin 111 was achieved employing the protocol developed by Sharpless.<sup>32</sup> Thus, treatment of 107 with hydrogen bromide in acetic acid and methanol at  $50\text{ }^\circ\text{C}$  gave 111 in 83% yield. The  $^1\text{H}$  NMR spectrum of 107 showed a downfield shift of -CH-Br proton as observed at  $\delta$  4.26 (doublet) and 4.09 (multiplet) in comparison to the same protons of dihydroxy compound. Finally, the mass spectrum clearly showed presence of bromine with indication of peak at 279 ( $M^+ - 2$ ). The preparation of salt 113 carried out in following manner completed the synthesis of left fragment. Thus, the free hydroxyl group of 111 was protected as silyl ether 112 using *tert*-butyldimethylsilyl chloride, imidazole and catalytic amount of DMAP. The IR spectrum of 112 showed absence of hydroxyl absorption and in the  $^1\text{H}$  NMR spectrum three singlets appeared at  $\delta$  0.03, 0.07 and 1.26 showing the presence of TBS group. Consequently, bromo silyl compound 112 was treated with triphenyl phosphine in dry acetonitrile under reflux conditions to furnish the salt 113 in moderate yield. The presence of three phenyl groups in the form of 15 protons at  $\delta$  7.73 and

down field shifting of -CH-P to  $\delta$  5.26 in  $^1\text{H}$  NMR spectrum clearly confirmed the formation of salt.

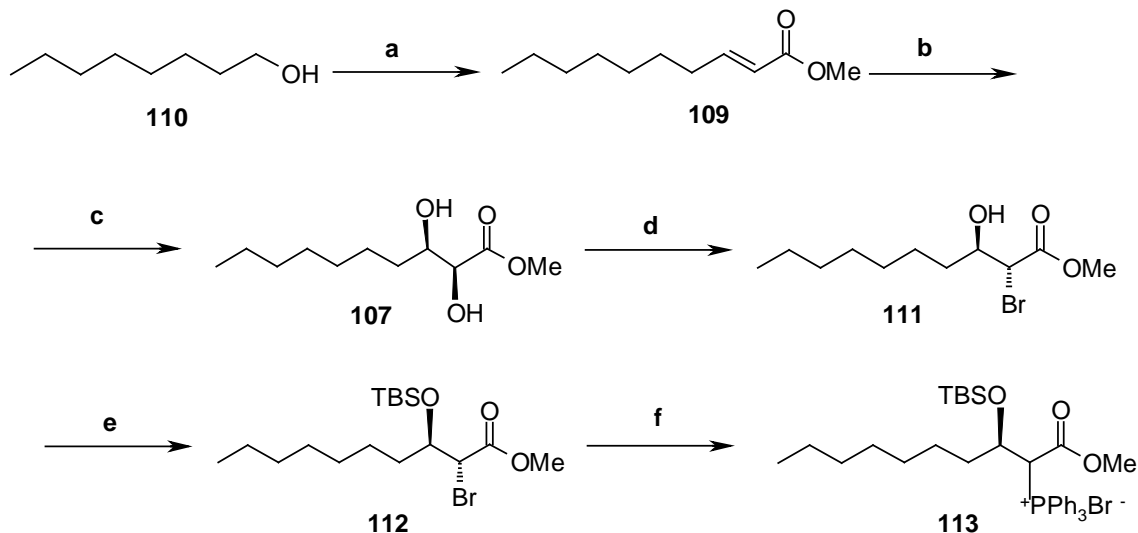

Scheme 20

**Scheme 20 : Reagents and conditions :** (a) (i)  $\text{P}_2\text{O}_5$ , DMSO,  $\text{CH}_2\text{Cl}_2$ ,  $\text{Et}_3\text{N}$ ,  $0^\circ\text{C}$ , 4 h, 96%; (ii)  $\text{Ph}_3\text{P}=\text{CHCOOMe}$ , THF, reflux, 12 h, 93%; (b)  $(\text{DHQD})_2\text{PHAL}$ ,  $\text{OsO}_4$ ,  $\text{CH}_3\text{SO}_2\text{NH}_2$ ,  $\text{K}_3\text{Fe}(\text{CN})_6$ ,  $\text{K}_2\text{CO}_3$ ,  $t\text{-BuOH}:\text{H}_2\text{O}$  (1:1), 24 h,  $0^\circ\text{C}$ , 98%; (c)  $\text{HBr}/\text{AcOH}$ , dry MeOH,  $45^\circ\text{C}$ , 24 h, 83%; (d)  $\text{TBDMSCl}$ , imidazole, DMAP(cat.),  $\text{CH}_2\text{Cl}_2$ , 36 h, 92%; (e)  $\text{PPh}_3$ ,  $\text{CH}_3\text{CN}$ , reflux, 12 h, 66%.

As shown in Scheme 21, the synthesis of right fragment 106 of (-)-acaterin commenced from (*R*)-methyl lactate. The protection of free hydroxyl group of 108 was achieved using dihydropyran and *p*-TSA in dry DCM. The IR spectrum of 114 showed the absence of hydroxyl group. In the  $^1\text{H}$  NMR spectrum, presence of *tert*-proton at  $\delta$  4.80 and in the  $^{13}\text{C}$  NMR *tert*-carbon at  $\delta$  98.69 confirmed the formation of compound 114. The ester group of 114 was reduced using  $\text{LiAlH}_4$  in dry THF, to afford 115 in excellent yield. The presence of strong absorption at  $3560\text{ cm}^{-1}$  in IR spectrum and the absence of methyl protons in the  $^1\text{H}$  NMR and carbonyl group in the  $^{13}\text{C}$  NMR spectrum confirmed the reduction of ester to alcohol 115. The PCC oxidation of alcohol 115 using PCC, anhydrous  $\text{CH}_3\text{COONa}$  and celite gave the aldehyde 106. The crude  $^1\text{H}$  NMR spectrum of 106 showed the doublet at  $\delta$  9.23, indicating the presence of aldehyde functionality (Scheme 21).



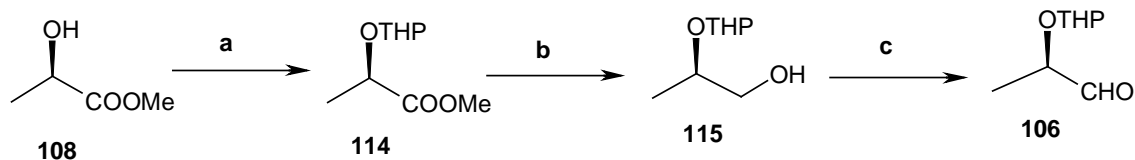

Scheme 21

**Scheme 21 : Reaction conditions :** (a) DHP, *p*-TsOH (cat), dry CH<sub>2</sub>Cl<sub>2</sub>, 96%; (b) LiAlH<sub>4</sub>, dry THF, 0 °C-rt, 12 h, 92%; (c) PCC, anhydrous CH<sub>3</sub>COONa, celite, 4 h.

The final step and one of the key reaction involved the construction of butenolide skeleton through Wittig olefination by coupling of phosphonium salt 113 with aldehyde 106 and subsequent cyclization.

Towards this end, the Wittig olefination between 113 and 106 was carried out in the presence of LiHMDS at -78 °C to give the olefin 116 in 73% yield. The IR spectrum of 116 showed peak at 1666 cm<sup>-1</sup> indicating the presence of olefin and in the <sup>1</sup>H NMR spectrum, olefin peaks appeared at δ 6.83 with coupling constant (*J*) 8.74 Hz which showed the presence of *cis* olefin. Presence of olefin peak at δ 128.1 in <sup>13</sup>C NMR also suggested the formation of 116. With olefin 116 in hand we proceeded for cyclization using catalytic amount of *p*-TSA in methanol and successfully achieved the target molecule (-)-acaterin 78 in good yield and in high optical purity [ $\alpha$ ]<sub>D</sub><sup>25</sup> : -21.33 (*c* 0.3, CHCl<sub>3</sub>) [lit.<sup>26</sup> [ $\alpha$ ]<sub>D</sub><sup>25</sup> : -19.7 (*c* 0.61, CHCl<sub>3</sub>)]. The physical and spectroscopic data exactly matched with the literature values.<sup>26</sup>

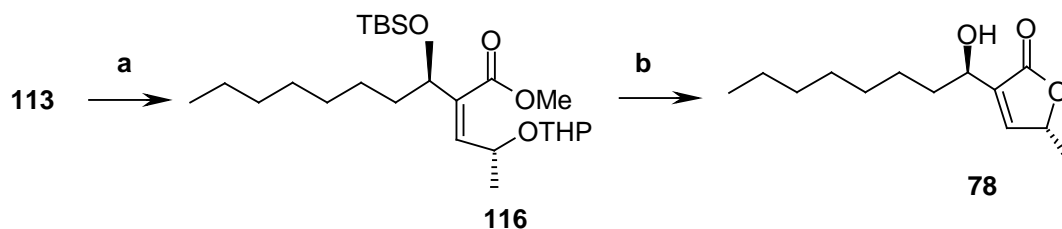

Scheme 22

**Scheme 22: Reaction conditions:** (a) LiHMDS, dry THF, - 78 °C, 30 min. then 106, 10 h, 73%; (b) cat. *p*-TsOH, MeOH, overnight, 68%.

### 3.2.5 Conclusion

In conclusion, a short and high yielding asymmetric synthesis of (-)-acaterin has been achieved through the Sharpless asymmetric dihydroxylation and Wittig olefination as key steps for the first time. A short reaction sequence and high yielding steps to (-)-acaterin renders our strategy a good alternative to the known methods. The pseudo of acaterin could also be synthesized via  $\alpha$ -dihydroxylation using (DHQ)<sub>2</sub>PHAL instead of (DHQD)<sub>2</sub> PHAL as the chiral ligand. The protocol is amenable to the synthesis of other isomers of (-)-acaterin i.e (+)-acaterin and its pseudo isomer could also be synthesized via  $\alpha$ - and  $\beta$ -dihydroxylations and using (S)-methyl lactate as starting material.

### 3.2.6 Experimental section

#### General Information

Solvents were purified and dried by standard procedures before use; petroleum ether of boiling range 60-80 °C was used. Melting points are uncorrected. Optical rotations were measured using the sodium D line of a JASCO-181 digital polarimeter. Infrared spectra were recorded with an ATI MATT-SION RS-1 FT-IR spectrometer. <sup>1</sup>H NMR spectra were recorded on Bruker AC-200 and DRX-500 NMR spectrometers. Mass spectra were obtained with GC-MS. Elemental analysis was carried out on Carlo Erba CHNSO-analyzer.

#### Preparation of Methyl *trans*-dec-2-enoate

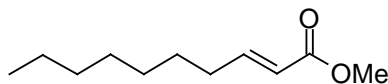

To a solution of 1-octanol **110** (10 g, 76.78 mmol) in dry CH<sub>2</sub>Cl<sub>2</sub> (100 mL) was added dry DMSO (11.99 g, 10.64 mL, 0.15 mmol) under nitrogen atmosphere and cooled to 0 °C. To this solution P<sub>2</sub>O<sub>5</sub> (21.29 g, 0.15 mol) was added in portion wise. The reaction mixture was stirred and allowed to warm to room temperature until the TLC diagnosis showed complete disappearance of the starting material (45 min). The round bottom flask was cooled to 0 °C and triethyl amine (36.23 mL, 0.26 mol) was added dropwise over one minute and stirring was continued for further 45 min. in ice bath and another 45 min. at room temperature. The reaction mixture was quenched with 150 ml of 10% aq. HCl and the solution extracted with CH<sub>2</sub>Cl<sub>2</sub> (3x100 mL). The combined organic extracts were washed with brine, dried (Na<sub>2</sub>SO<sub>4</sub>), filtered and concentrated in vacuo to give the octanal, which was used as such in the next Wittig olefination.

**To a solution of (methoxycarbonylmethyl)triphenylphosphorane (25.78 g, 77.22 mmol) in dry THF (60 mL) was added dropwise a solution of aldehyde (9 g, 70.2 mmol) in THF (20 mL) at room temperature. The reaction mixture was refluxed for 12 h and concentrated to near dryness. Silica gel column chromatography of the crude product using pet. ether:ethyl acetate (9.5:0.5) as eluent gave the olefin 109 (12.0 g).**

Yield : 93%

IR (neat, cm<sup>-1</sup>) : ν<sub>max</sub> 1616, 1724

<sup>1</sup>H NMR(200 MHz, CDCl<sub>3</sub>) : δ 0.83 (t, *J* = 4 Hz, 3H), 1.24-1.26 (m, 10H), 2.11-2.18 (m, 2H), 3.70 (s, 3H), 5.79 (d, *J* = 14 Hz, 1H), 6.88-6.99 (m, 1H)

<sup>13</sup>C NMR (50 MHz, CDCl<sub>3</sub>) : δ 13.9, 22.3, 27.8, 28.8, 31.4, 31.9, 59.9, 121.1, 148.2, 166.2

Analysis : C<sub>11</sub>H<sub>20</sub>O<sub>2</sub> (184.28) requires C, 71.70 ; H, 10.94. Found. C, 71.68 ; H, 10.91.

**Preparation of Methyl (2*R*,3*S*)-2,3-dihydroxydecanoate**

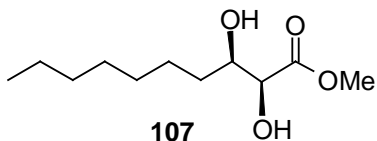

To a mixture of K<sub>3</sub>Fe(CN)<sub>6</sub> (5.36 g, 16.27 mmol), K<sub>2</sub>CO<sub>3</sub> (2.25 g, 16.27 mmol) and (DHQD)<sub>2</sub>PHAL (42 mg, 1 mol%) in *t*-BuOH-H<sub>2</sub>O (1:1) cooled at 0 °C was added osmium tetroxide (0.22 mL, 0.1 M solution in

toluene, 0.4 M mol%) followed by methanesulfonamide (0.52 g, 5.42 mmol). After stirring for 5 min. at 0 °C, olefin **109** (1 g, 5.42 mmol) was added in one portion. The reaction mixture was stirred at 0 °C for 24 h and then quenched with solid sodium sulfite (2.5 g). The stirring was continued for an additional 45 min. and then the solution was extracted with ethyl acetate (5x50 mL). The combined organic phases were washed with 10% aq. KOH, brine, dried (Na<sub>2</sub>SO<sub>4</sub>) and concentrated. Silica gel column chromatography of the crude product using pet. ether:EtOAc (7:3) as eluent gave the diol **107** (1.5 g) as a low melting solid.

**Yield : 98%**

**M.p. : 42 °C**

$[\alpha]_D^{25} : +11.23$  (c 1, CHCl<sub>3</sub>)

**IR (CHCl<sub>3</sub>, cm<sup>-1</sup>)** :  $\nu_{\max}$  3506, 1723

**<sup>1</sup>H NMR (200 MHz, CDCl<sub>3</sub>)** :  $\delta$  0.87 (t, *J* = 6 Hz, 3H), 1.31-1.34 (m, 10H), 1.35-1.59 (m, 2H), 3.82 (s, 3H), 4.10-4.20 (m, 2H)

**<sup>13</sup>C NMR (50 MHz, CDCl<sub>3</sub>)** :  $\delta$  13.8, 22.4, 25.5, 29.0, 28.9, 31.6, 33.2, 52.3, 72.4, 73.2, 174.0

**Analysis : C<sub>11</sub>H<sub>22</sub>O<sub>4</sub> (218.29) requires C, 60.52 ; H, 10.16. Found. C, 60.48 ; H, 10.13.**

#### Preparation of Methyl (2*R*,3*R*)-2-bromo-3-hydroxydecanoate

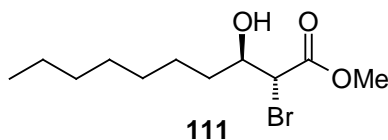

Methyl-2,3-dihydroxydecanoate **107** (2 g, 9.16 mmol) was placed in a one neck round bottom flask followed by addition of hydrogen bromide (14 mL, 33% HBr in AcOH, 45.80 mmol) at room temperature, and the reaction mixture was heated at 45 °C. After 1 h of stirring, MeOH (28 mL) was added dropwise. The mixture was stirred overnight at 45 °C, and then allowed to cool to rt over 1 h. The mixture was quenched by slowly pouring into ice-water, diluted with ether and neutralized by addition of saturated NaHCO<sub>3</sub>. The precipitate sodium acetate was filtered off and the filtrate extracted with ether. The extract was washed with brine, dried over Na<sub>2</sub>SO<sub>4</sub>, and concentrated under reduced pressure. The residue was

purified by silica gel column chromatography using ethyl acetate:pet. ether (1:9) to give **111** (2.14 g) as a low melting white solid.

**Yield :** 83%

$[\alpha]_D^{25}$  : + 36.14

**M. p. :** 41-41.5 °C

**IR (CHCl<sub>3</sub>, cm<sup>-1</sup>) :**  $\nu_{\max}$  3604, 3019, 2928, 2400, 1735, 1658, 1215, 756, 669

**<sup>1</sup>H NMR (200 MHz, CDCl<sub>3</sub>) :**  $\delta$  0.85 (t,  $J$  = 6.3 Hz, 3H), 1.26-1.42 (m, 10H), 1.81-1.92 (m, 2H), 3.01 (bs, 1H), 3.77 (s, 3H), 4.11 (d,  $J$  = 8 Hz, 1H), 3.97-3.99 (m, 1 H)

**<sup>13</sup>C NMR (50 MHz, CDCl<sub>3</sub>) :**  $\delta$  13.8, 22.4, 25.0, 28.9, 29.1, 31.5, 33.2, 47.8, 52.7, 72.1, 169.7

**MS :**  $m/z$  279 ( $M^+ - 2$ ), 263, 197, 183, 168, 152, 140, 123, 111, 95, 81.

**Analysis :** C<sub>11</sub>H<sub>21</sub>BrO<sub>3</sub> (281.19) requires **C, 46.98 ; H, 7.52 ; Br, 28.41.**

**Found. C, 47.07 ; H, 7.65 ; Br, 28.14.**

#### Preparation of Methyl (2*R*,3*R*)-2-bromo-3-*tert*-butyldimethylsilanyloxydecanoate

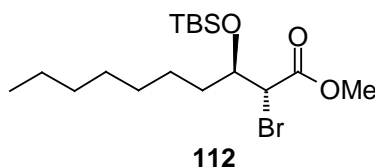

To a solution of **111** (1 g, 3.55 mmol) in dry CH<sub>2</sub>Cl<sub>2</sub> (15 mL) was added imidazole (0.26 g, 4.27 mmol), catalytic amount of DMAP (100 mg), TBDMSCl (0.64 g, 4.27 mmol) sequentially. The reaction mixture was diagnosed using TLC. To the reaction mixture was added water and extracted with dichloromethane and combined organic layers were washed with brine solution, dried (Na<sub>2</sub>SO<sub>4</sub>). The residue was purified by silica gel

column chromatography using ethylacetate:pet. ether (0.5:9.5) to give **112** (1.29 g) as a colorless oil.

**Yield :** 92%

**IR (neat,  $\text{cm}^{-1}$ ) :**  $\nu_{\text{max}}$  3019, 2929, 2857, 1746, 1463, 759, 594

**$^1\text{H}$  NMR (200 MHz,  $\text{CDCl}_3$ ) :**  $\delta$  0.03 (s, 3H), 0.07 (s, 3H), 0.83 (t,  $J = 5.6$  Hz, 3H), 1.26 (s, 9H), 1.28-1.32 (m, 10H), 1.61-1.69 (m, 2H), 3.76 (s, 3H), 4.11-4.24 (m, 2H)

**$^{13}\text{C}$  NMR (50 MHz,  $\text{CDCl}_3$ ) :**  $\delta$  -5.1, -4.4, 14.0, 18.0, 22.4, 25.6, 29.1, 29.6, 31.7, 33.2, 47.4, 52.6, 72.8, 169.5

**Analysis :**  $\text{C}_{17}\text{H}_{35}\text{BrO}_3\text{Si}$  (395.45) requires **C, 51.63 ; H, 8.92 ; Br, 20.21**

**Found. C, 51.60 ; H, 8.89 ; Br, 20.19.**

#### Preparation of salt 113

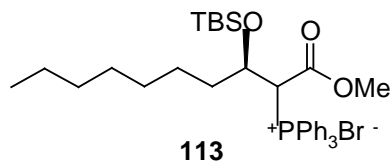

To a solution of **112** (0.5 g, 1.26 mmol) in dry acetonitrile (5 mL) was added triphenyl phosphine (0.33 g, 1.26 mmol). The reaction mixture was refluxed till the disappearance of the starting material. Then, the solvent was concentrated under reduced pressure and residue thus obtained was thoroughly washed with petroleum ether to remove the unreacted triphenyl phosphine. The crude salt was used as such in the next reaction.

**Yield :** 66%

**$^1\text{H}$  NMR (200 MHz,  $\text{CDCl}_3$ ) :**  $\delta$  -0.03 (s, 3H), 0.00 (s, 3H), 0.89-0.92 (m, 13 H), 1.22 (s, 9H), 1.42-1.53 (m, 2H), 3.76 (s, 3H), 4.12-4.34 (m, 1H), 5.34 (d,  $J = 16$  Hz, 1H), 7.35-7.49 (m, 15H)

### Preparation of Methyl (2*R*)-2-(Tetrahydropyran-2-yloxy)-propionate

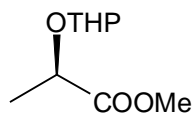

**114**

To a solution of methyl-(*R*)-lactate **108** (5 g, 48.03 mmol) in dry CH<sub>2</sub>Cl<sub>2</sub> (30 mL) was added 3,4-dihydro-2*H*-pyran (4.38 mL, 48.03 mmol) and cat. *p*-TSA (100 mg) sequentially. The reaction mixture was stirred overnight and neutralized with solid NaHCO<sub>3</sub>. The crude product was purified over silica gel column chromatography using ethyl acetate:pet. ether (0.5:9.5) as eluent to give **114** (8.7 g) as a colorless liquid.

**Yield :** 96%

**IR (neat, cm<sup>-1</sup>) :**  $\nu_{\max}$  1723, 1329, 1222, 765

**<sup>1</sup>H NMR (200 MHz, CDCl<sub>3</sub>) :**  $\delta$  1.25 (d, *J* = 6.06 Hz, 3H), 1.55-1.69 (m, 4H), 1.74-1.78 (m, 2H), 3.60 (t, *J* = 8.2 Hz, 2H), 3.67 (s, 3H), 3.85 (d, *J* = 7.5 Hz, 1H), 4.95 (t, *J* = 6.3 Hz, 1H)

**<sup>13</sup>C NMR (50 MHz, CDCl<sub>3</sub>) :**  $\delta$  15.9, 19.2, 28.0, 35.6, 52.7, 63.6, 72.8, 98.4, 171.6

**Analysis :** C<sub>9</sub>H<sub>16</sub>O<sub>4</sub> (188.22) requires C, 57.43 ; H, 8.57. Found. C, 57.41 ; H, 8.53.

### Preparation of (2*R*)-2-(Tetrahydropyran-2-yloxy)-propan-1-ol

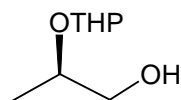

**115**

To a stirred solution of LAH (0.6 g, 15.94 mmol) in dry THF (60 mL) was added ester **114** (3 g, 15.94 mmol) in dry THF (10 mL) at 0 °C dropwise. The reaction mixture was stirred at ambient temperature till disappearance of starting material and it was cooled to 0 °C. The excess of LAH was quenched with 2N NaOH and filtered. The white

precipitate was washed repeatedly and the combined layers were concentrated to near dryness. The residue was purified on silica gel column chromatography using ethyl acetate:pet. ether (1:9) to furnish the alcohol **115** (2.3 g) as a colorless liquid.

**Yield :** 92%

**IR (neat, cm<sup>-1</sup>) :**  $\nu_{\max}$  3466, 1226, 852, 788

**<sup>1</sup>H NMR (200 MHz, CDCl<sub>3</sub>) :**  $\delta$  1.23 (d,  $J$  = 6.1 Hz, 3H), 1.49-1.78 (m, 6H), 2.12 (brs, 1H), 3.17-3.20 (m, 1H), 3.33 (t,  $J$  = 6.8 Hz, 2H), 3.66 (dd,  $J$  = 10.3, 3.1 Hz, 2H), 4.93 (td,  $J$  = 4.4 Hz, 1H)

**<sup>13</sup>C NMR (50 MHz, CDCl<sub>3</sub>) :**  $\delta$  18.4, 20.3, 30.2, 33.6, 61.7, 66.1, 70.4, 98.4

**Analysis :** C<sub>8</sub>H<sub>16</sub>O<sub>3</sub> (160.21) requires C, 59.97 ; H, 10.07. Found. C, 59.96 ; H, 10.04

**Preparation of 2-[1-*tert*-Butyldimethylsilyloxy]-octyl]-4-(tetrahydropyran-2-yloxy)-pent-2-enoic acid methyl ester**

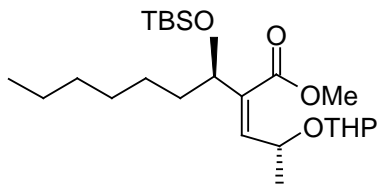

**116**

To a stirred solution of PCC (1.0 g, 4.68 mmol), anhydrous CH<sub>3</sub>COONa (0.38 g, 4.68 mmol) and celite was added alcohol **115** (0.5 g, 3.12 mmol) at 0 °C. The reaction mixture was stirred for 4 h. After removal of dichloromethane the crude was extracted with ether several times. The combined ether extracts were concentrated to afford the desired aldehyde which was used as such in the next step.

To a suspension of the Wittig salt **113** (1.12 g, 1.77 mmol) in dry THF (20 mL) was added LiHMDS (2.13 mL, 2.13 mmol, 1 M solution in THF) dropwise at -78 °C. The reaction mixture was stirred till all solids dissolved (30 min). To the dark red solution



was added the above aldehyde (0.28 g, 1.77 mmol) in dry THF (5 mL) dropwise at  $-78$  °C. The reaction mixture was stirred for 10 h at  $-78$  °C. It was quenched with sat. aq. ammonium chloride and extracted with EtOAc (3x30 mL). The combined organic layers were washed (brine), dried ( $\text{Na}_2\text{SO}_4$ ) and concentrated. Silica gel column chromatography of the crude product using petroleum ether : ethyl acetate (9:1) as eluent gave **116** (0.53) as a colorless liquid.

**Yield :** 73%

$[\alpha]_D^{25}$  : -12.67

**IR (neat,  $\text{cm}^{-1}$ ) :**  $\nu_{\text{max}}$  1723, 1666

**$^1\text{H}$  NMR (500 MHz,  $\text{CDCl}_3$ ) :**  $\delta$  0.03 (s, 3H), 0.08 (s, 3H), 0.86-0.89 (t,  $J = 6.3$  Hz, 3H), 1.28-1.31 (m, 10H), 1.27 (s, 9H), 1.41-1.46 (dd,  $J = 17.7, 7.90$  Hz, 3H), 1.52-1.56 (m, 2H), 1.59-1.87 (m, 6H), 3.74 (s, 3H), 4.24-4.26 (t,  $J = 11.2$  Hz, 2H), 4.32-4.44 (m, 1H), 4.70-4.71, (m, 1H), 4.95-4.97 (m, 1H), 6.83-6.84 (d,  $J = 8.7$  Hz, 1H)

**$^{13}\text{C}$  NMR (125 MHz,  $\text{CDCl}_3$ ) :**  $\delta$  -3.79, -4.72, 13.80, 17.94, 18.91, 22.40, 25.26, 28.95, 28.93, 29.25, 30.15, 31.57, 36.42, 41.09, 60.73, 62.14, 97.39, 115.19, 128.19, 173.19, 156.37

**GC-MS :**  $m/z$  456 ( $\text{M}^+$ )

Analysis :  $\text{C}_{25}\text{H}_{48}\text{O}_5\text{Si}$  (456.73) requires C, 65.74 ; H, 10.59 ; Found. C, 65.52 ; H, 10.21.

**Synthesis of (-)-acaterin**

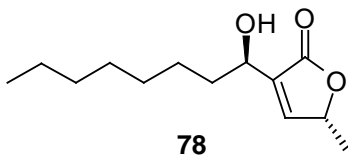

To a stirred solution of **116** (0.36 g) in methanol (5 mL) was added catalytic amount of *p*-toluene sulfonic acid (50 mg) and the reaction mixture stirred overnight. After TLC diagnosis, saturated NaHCO<sub>3</sub> (5 mL) was added and the reaction mixture was extracted with dichloromethane. The combined organic layers were dried over Na<sub>2</sub>SO<sub>4</sub> and concentrated to near dryness. Purification of the crude product on silica gel column chromatography using ethyl acetate:pet. ether (8:2) gave (-)- acaterin **78** in 68% yield. The physical and spectroscopic data of compound **78** were in full agreement with natural acaterin.

**Yield :** 68%

$[\alpha]_D^{25}$  :  $[\alpha]_D^{25}$  -21.33 (*c* 0.3, CHCl<sub>3</sub>) [lit.<sup>28</sup> -19.7 (*c* 0.61, CHCl<sub>3</sub>)]

**<sup>1</sup>H NMR (500 MHz, CDCl<sub>3</sub>) :** δ 0.88 (t, *J* = 7 Hz, 3H), 1.26-1.32 (m, 10H), 1.43-1.53 (m, 3H), 1.82-2.04 (m, 2H), 3.33 (s, 1H), 4.12-4.15 (m, 1H), 5.11-5.24 (m, 1H), 6.84 (dd, *J* = 6, 2 Hz, 1H)

**<sup>13</sup>C NMR (125 MHz, CDCl<sub>3</sub>) :** δ 14.3, 19.4, 23.1, 24.2, 30.0, 30.7, 32.5, 72.1, 75.3, 135.6, 137.7, 165.0

### 3.2.7 Spectra

1.  $^1\text{H}$  &  $^{13}\text{C}$  NMR spectra of 107
2.  $^1\text{H}$  &  $^{13}\text{C}$  NMR spectra of 111
3.  $^1\text{H}$  &  $^{13}\text{C}$  NMR spectra of 112
4.  $^1\text{H}$  &  $^{13}\text{C}$  NMR spectra of 116
5.  $^1\text{H}$  &  $^{13}\text{C}$  NMR spectra of 78



$^1\text{H}$  NMR spectrum of compound 107 in  $\text{CDCl}_3$



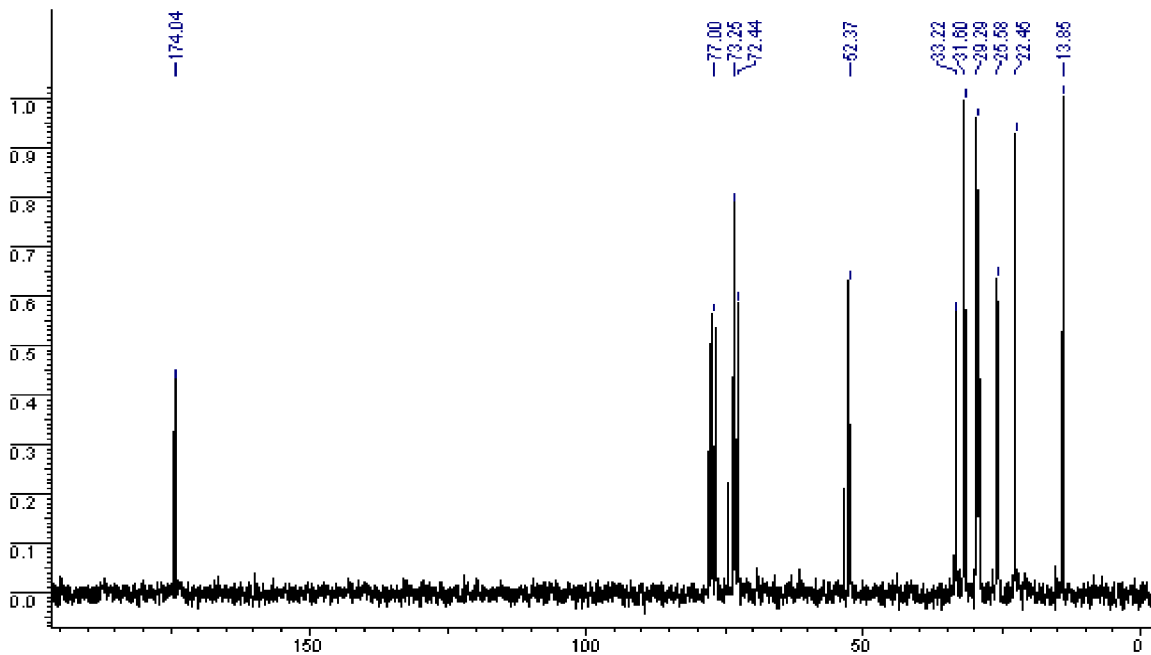

$^{13}\text{C}$  NMR spectrum of compound 107 in  $\text{CDCl}_3$

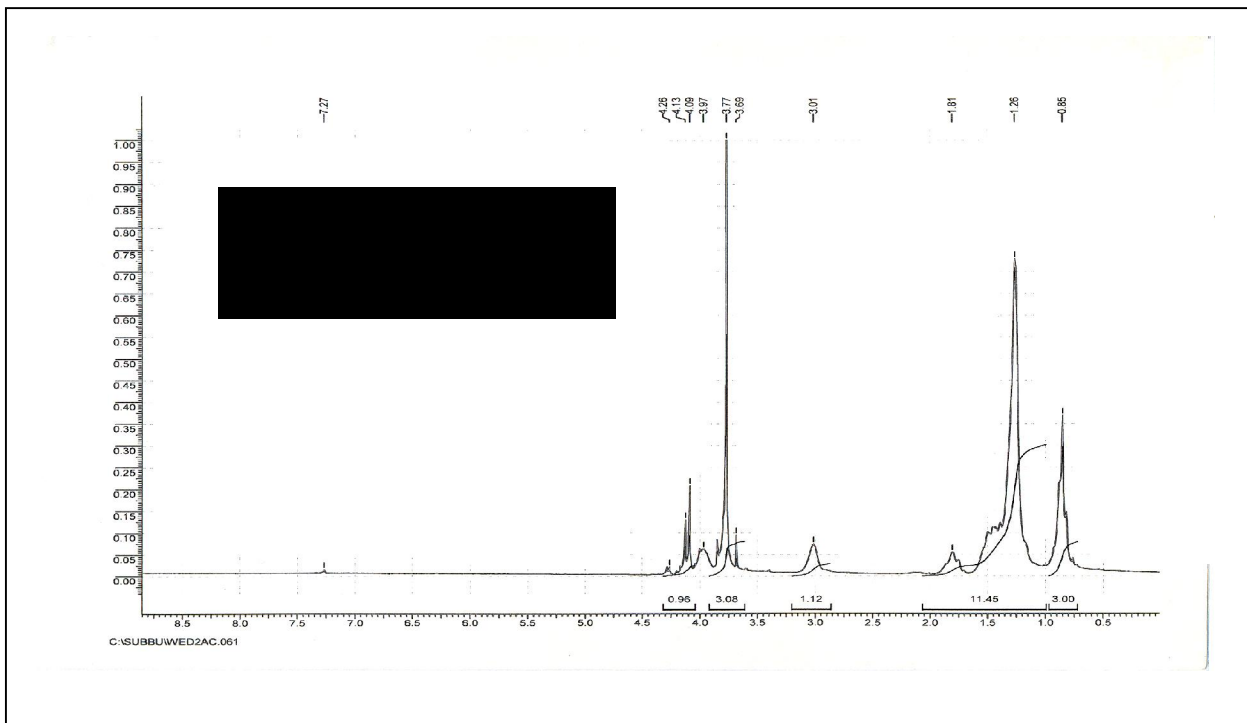

### $^1\text{H}$ NMR spectrum of compound 111 in $\text{CDCl}_3$

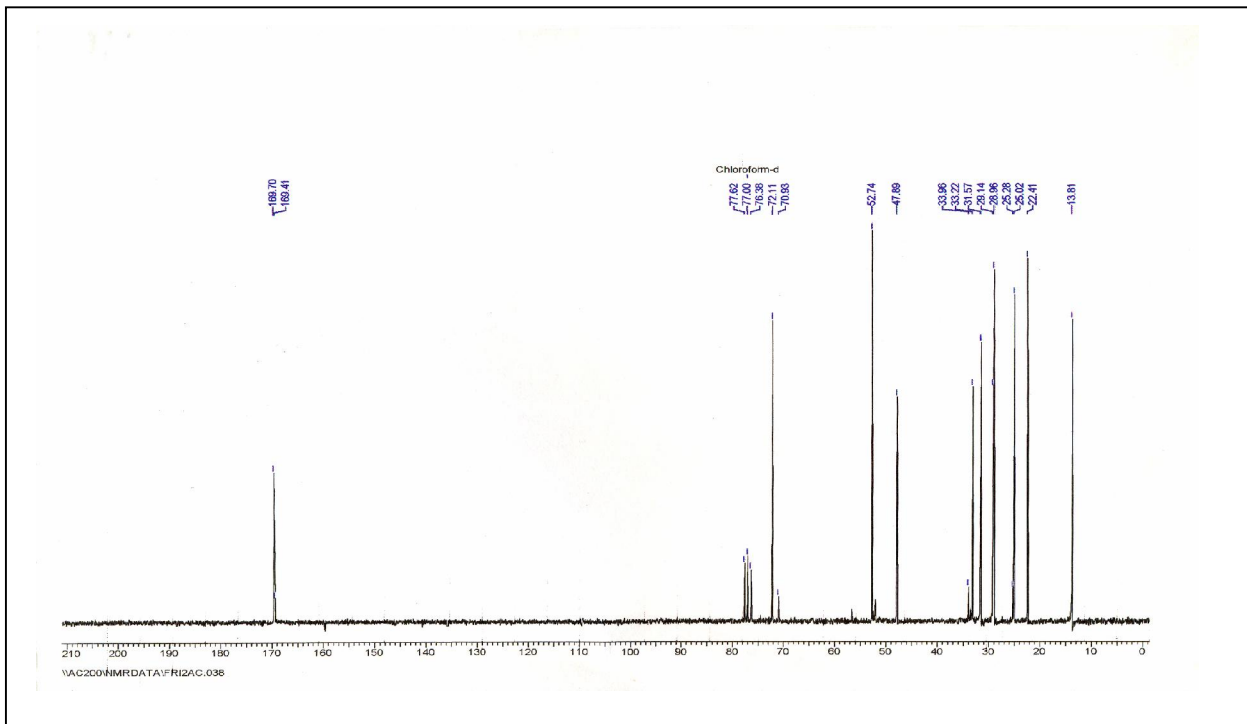

### $^{13}\text{C}$ NMR spectrum of compound 111 in $\text{CDCl}_3$

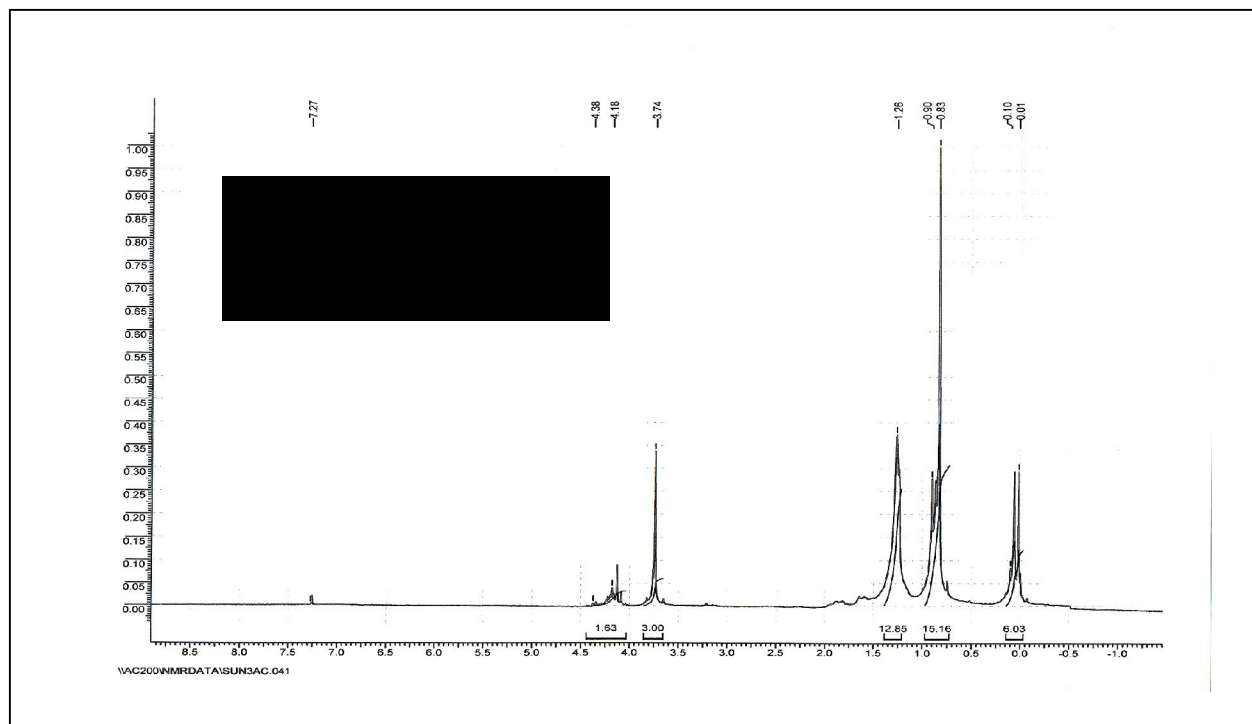

$^1\text{H}$  NMR spectrum of compound 112 in  $\text{CDCl}_3$

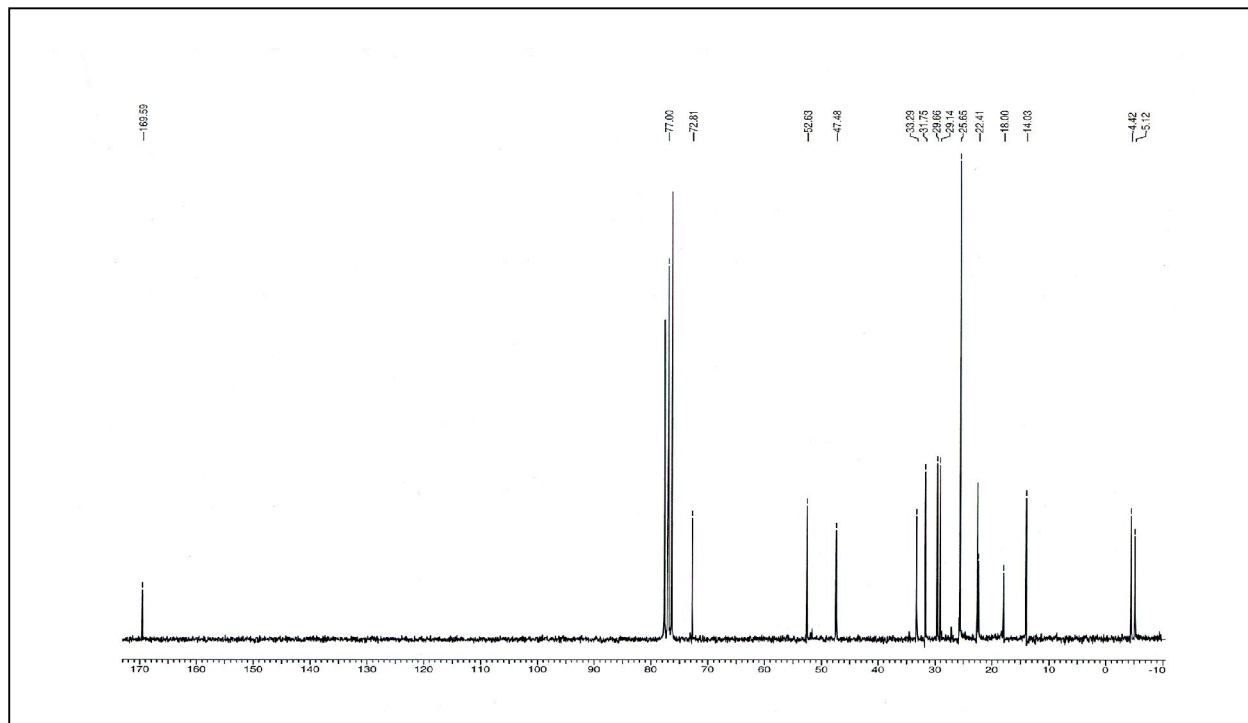

$^1\text{H}$  NMR spectrum of compound 112 in  $\text{CDCl}_3$

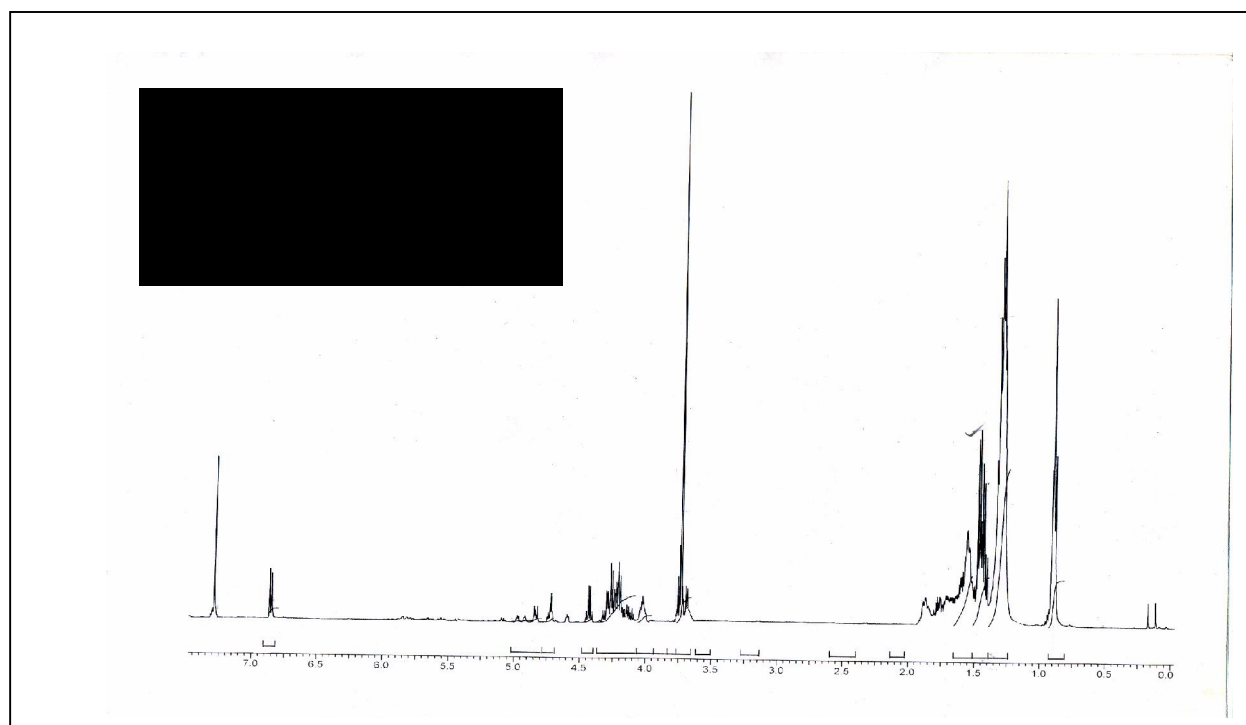

### $^1\text{H}$ NMR spectrum of compound 116 in $\text{CDCl}_3$

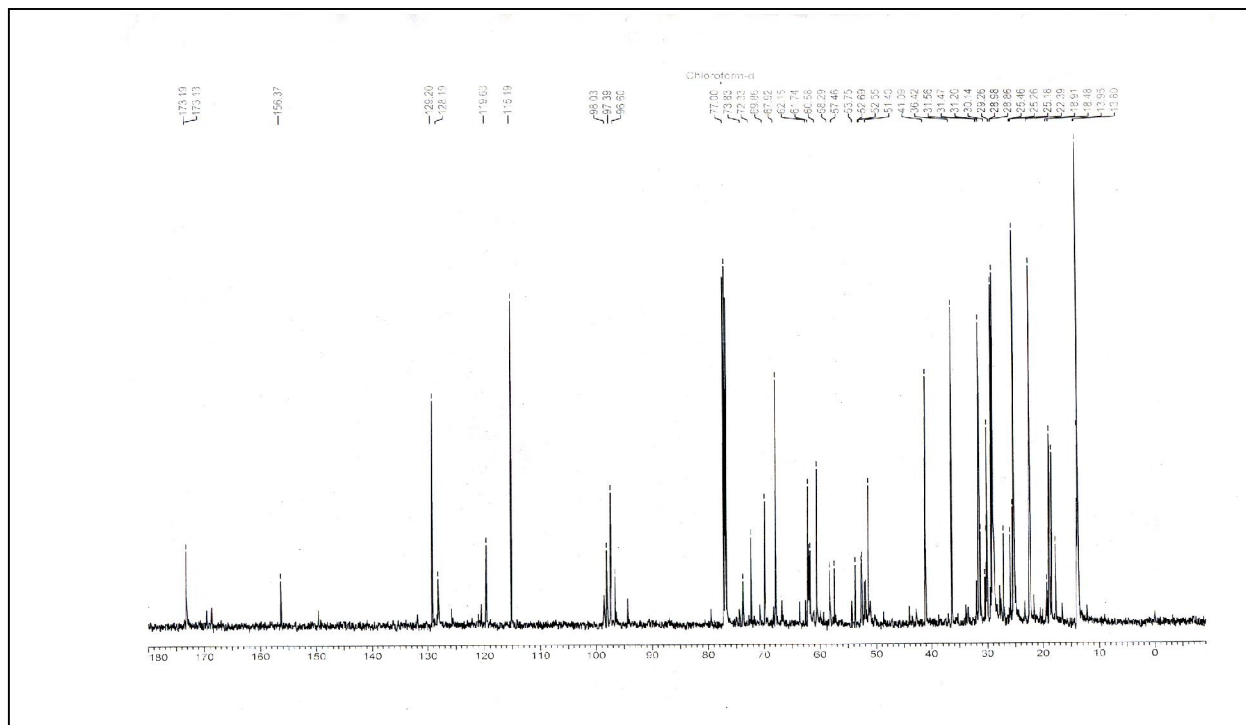

### $^{13}\text{C}$ NMR spectrum of compound 116 in $\text{CDCl}_3$

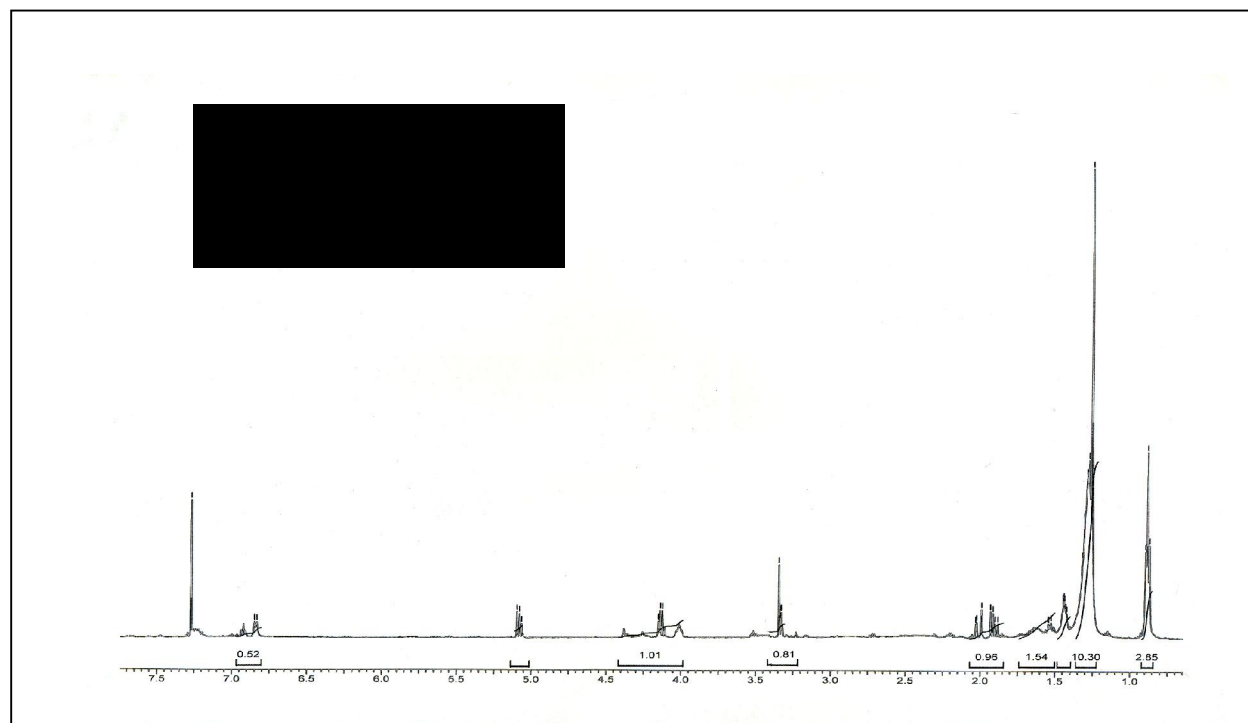

### $^1\text{H}$ NMR spectrum of compound 78 in $\text{CDCl}_3$

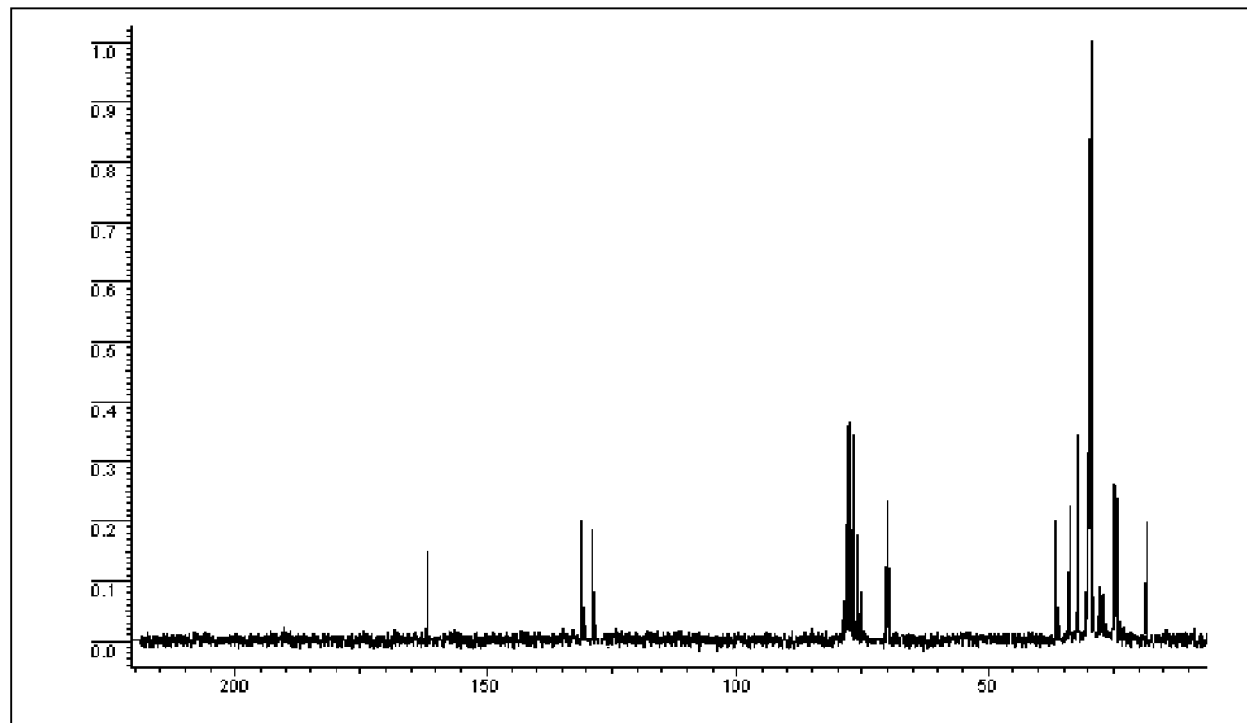

### $^{13}\text{C}$ NMR spectrum of compound 78 in $\text{CDCl}_3$

## 3.3 References

1. Casiraghi, G.; Zanardi, F.; Rasso, G.; Spanu, P. *Chem. Rev.* **1995**, *95*, 1677.
2. Michael, J. P. *Nat. Prod. Rep.* **1997**, 619 and references cited therein.
3. Wertheim, T. *Liebigs. Ann. Chem.* **1856**, *100*, 328.
4. Spath, E.; Adler, E. *Monatsh. Chem.* **1933**, *63*, 127.
5. Fodor, G.; Bawerschmidts, E. *J. Heterocycl. Chem.* **1968**, *5*, 205; (b) Galinovsky, F.; Mulley, H. *Monatsh. Chem.* **1948**, *79*, 426 ; (c) Pandey, S. K.; Kumar, P. *Tetrahedron Lett.* **2005**, *46*, 4091.
6. (a) Ratovelomanana, V.; Royer, J.; Husson, H.-P. *Tetrahedron Lett.* **1985**, *26*, 3803; (b) Comins, D. L.; Williams, A. L. *Tetrahedron Lett.* **2000**, *41*, 2839.
7. Guerreiro, P.; Ratovelomanana-Vidal, V.; Genet, J.-P. *Chirality* **2000**, *12*, 408; (b) Agami, C.; Couty, F.; Rabasso, N. *Tetrahedron Lett.* **2000**, *41*, 4113; (c) Agami, C.; Couty, F.; Rabasso, N.



- Tetrahedron* **2001**, 57, 5393; (d) Masaki, Y.; Imaeda, T.; Nagata, K.; Oda, H.; Ito, A. *Tetrahedron Lett.* **1989**, 30, 6395.
8. Enders, D.; Nolte, B.; Raabe, G.; Runsink, J. *Tetrahedron Asymmetry* **2002**, 13, 285.
9. (a) Bailey, W. F.; Punzalan, E. R. *J. Org. Chem.* **1990**, 55, 5404; (b) Negishi, E.; Swanson, D. R.; Rousset, C. J. *J. Org. Chem.* **1990**, 55, 5406.
10. Masaki, Y.; Serizawa, Y.; Nagata, K.; Oda, H.; Nagashima, H.; Kaji, K. *Tetrahedron Lett.* **1986**, 27, 231; (b) Masaki, Y.; Kaji, K. *Chem. Lett.* **1983**, 1835.
11. Hmieir, P.; Junge, H.; Kartner, A. *J. Org. Chem.* **1994**, 59, 6766; (b) Oestrich, M.; Frohlich, R.; Hoppe, D. *Tetrahedron Lett.* **1988**, 39, 1745.
12. Becker, H.; Sharpless, K. B. *Angew. Chem., Int. Ed Engl.* **1996**, 35, 448 ; (b) Torri, S.; Liu, P.; Bhuvaneswari, N.; Amatore, C.; Jutand, A. *J. Org. Chem.* **1996**, 61, 3055; (c) For a review on asymmetric dihydroxylation, see: Kolb, H. C.; VanNiewenhze, M. S.; Sharpless, K. B. *Chem. Rev.* **1994**, 94, 2483.
13. Hayashi, Y.; Shoji, M.; Yamaguchi, J.; Sato, K.; Yamaguchi, S.; Mukaiyama, T.; Sakai, K.; Asami, Y.; Kakeya, H.; Osada, H. *J. Am. Chem. Soc.* **2002**, 124, 12078.
14. Lowry, T. H.; Richardson, K. S. *Mechanism and Theory in Organic Chemistry*. 3<sup>rd</sup> edn, Harper & Row New York p. 321 and references cited therein.
15. (a) Takano, S.; Akiyama, M.; Sat, S.; Ogasawara, K. *Chem. Lett.* **1983**, 1593; (b) Mikami, T.; Asano, H.; Mitsunobu, O. *Chem. Lett.* **1987**, 2033.
16. Stange, E. F.; Dietschy, J. M. *In New Comprehensive Biochemistry. Vol. 12. Sterols and Bile acids*. Eds. Danielsson, H.; Sjoval J. 121-148, Elsevier Science Publishers, **1985**.
17. Brown, M. S.; Goldstein, J. L. *Annu. Rev. Biochem* **1983**, 52, 233.
18. (a) Levy, R. I. ; *Circ.* **1985**, 72, 686; (b) Mahley, R. W.; Innerrarity, T. L.; Jall, S. C.; Weisgraber, Jr. & K. H. *J. Lipid. Res.* **1984**, 25, 1277.
19. Matson, J. A.; Colson, K. L.; Belofsky, G. N. *J. Antibiot.* **1993**, 46, 162.
20. (a) Bell, F. P. ; Prous, J. R. *Ed. Science Publishers.* **1986**, 409; (b) Heilder, J. G. Prous, J. R. *Ed. Science Publishers* **1986**, 423.

21. Tomoda, H.; Nishida, H.; Masuma, R.; Cao, J.; Okuda, S.; Omura, S. *J. Antibiot.* **1991**, *44*, 136; (b) Nishida, H.; Tomoda, H.; Cao, J.; Okuda, S.; Omura, S. *J. Antibiot.* **1991**, *44*, 144; (c) Nishida, H.; Tomoda, H.; Cao, J.; Araki, S.; Okuda, S.; Omura, S. *J. Antibiot.* **1991**, *44*, 152; (d) Naganuma, S.; Sakai S.; Sakai, K.; Hasumi, K.; Endo, A. *J. Antibiot.* **1992**, *45*, 1216.
22. Shinohara, C.; Hasumi, K.; Takai, Y.; Endo, A. *J. Antibiot.* **1993**, *47*, 163; (b) Jeong, T. S.; Kim, S. U.; Son, K. H.; Kwon, B. M.; Kim, Y. K.; Choi, M. U.; Bok, S. H. *J. Antibiot.* **1994**, *48*, 751 ; (c) Kuroda, K.; Yoshida, M.; Uosaki, Y.; Ando, K.; Kawamoto, I.; Oishi, E.; Onuma, H.; Yamada, K.; Matsuda, Y. *J. Antibiot.* **1993**, *46*, 1196 ; (d) Hasumi, K.; Takizawa, K.; Takahashi, F.; Park, J. K.; Endo, A. *J. Antibiot.* **1995**, *48*, 1419.
23. Naganuma, S.; Sakai, K.; Hasumi, K.; Endo, A. *J. Antibiot.* **1995**, *48*, 1419.
24. For overview readings, see the following reviews and articles and references cited therein.  
(a) Geran, R. I.; Greenberg, N. H.; MacDonald, M. M.; Schumacher, A. M.; Abbott, B. *J. Cancer Chemotherapy. Rep.* **1972**, *3*, 1; (b) Rupperecht, J. K.; Hui, Y-H.; McLaughlin, J. L. *J. Nat. Prod.* **1990**, *53*, 237; (c) Fang, X-P.; Reiser, M. J.; Gu, Z-M.; Zhao, G-X.; McLaughlin, J. L. *Phytochem. Anal.* **1993**, *4*, 27.
25. Jolad, S. D.; Hoffmann, J. J.; Schran, K. H.; Cole, J. R. *J. Org. Chem.* **1982**, *47*, 3151.
26. Ishigami, K.; Kitahara, T. *Tetrahedron* **1995**, *51*, 3, 6341.
27. Sekiyama, Y.; Fujimoto, Y.; Hasumi, K.; Endo, A. *J. Org. Chem.* **2001**, *66*, 5649.
28. Vijay Anad, R.; Baktharaman, S.; Singh, V. K. *Tetrahedron Lett.* **2002**, *43*, 5393.
29. Franck, X.; Figadere, B. *Tetrahedron Lett.* **2002**, *43*, 1449.
30. Tsuboi, S.; Sakamoto, J.; Jawano, T.; Utaka, M.; Takeda, A. *J. Org. Chem.* **1991**, *56*, 7177.
31. Gurjar, M. K.; Sylesh Kumar, V.; Venkateswara Rao, B. *Tetrahedron* **1999**, *55*, 12563.
32. Fleming, R. P.; Sharpless, K. B. *J. Org. Chem.* **1991**, *56*, 2869.

## 4. ASYMMETRIC SYNTHESSES OF VICINAL AMINO ALCOHOLS VIA ASYMMETRIC AMINOHYDROXYLATION

---

### 4.1 Introduction

The vicinal amino alcohol moiety **1** is a common structural component in a vast group of naturally occurring and synthetic molecules. The common name for this group varies, from vicinal amino alcohol, to  $\beta$ -amino alcohol, to 1,2-amino alcohol. Either the amine or the alcohol can be acylated, alkylated or contained within rings. The presence of moiety and the relative (as well as absolute) stereochemistry are generally important for the biological activity of molecules containing a vicinal amino alcohol. As such, a variety of stereoselective synthetic methods have been developed.

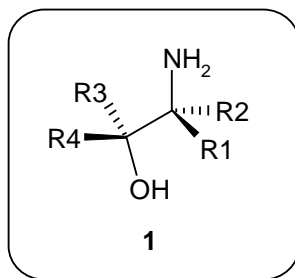

Mainly three general groups of vicinal amino alcohols have been reported in the literature. These are

#### **1. Naturally occurring molecules containing vicinal amino alcohols**

Hydroxy amino acids are one of the most common naturally occurring that contain a vicinal amino alcohol. The naturally occurring amino alcohols, serine and threonine are both biologically significant as well as being useful members of the chiral pool.<sup>1</sup> Some

well known examples are shown in **Fig. 1**. Probably the most synthesized of this group is the dipeptide bestatin **2**.<sup>2</sup> Structurally bestatin is an aminopeptidase inhibitor that exhibits immunomodulatory activity, and is used clinically as an adjuvant in cancer chemotherapy. Cyclic depsipetides are a large group of naturally occurring molecules that commonly contain nonproteogenic acids. Hapalysin **3** is an *anti*- $\beta$ -hydroxy- $\gamma$ -amino acids containing depsipeptide recently isolated from blue green algae.<sup>3</sup>

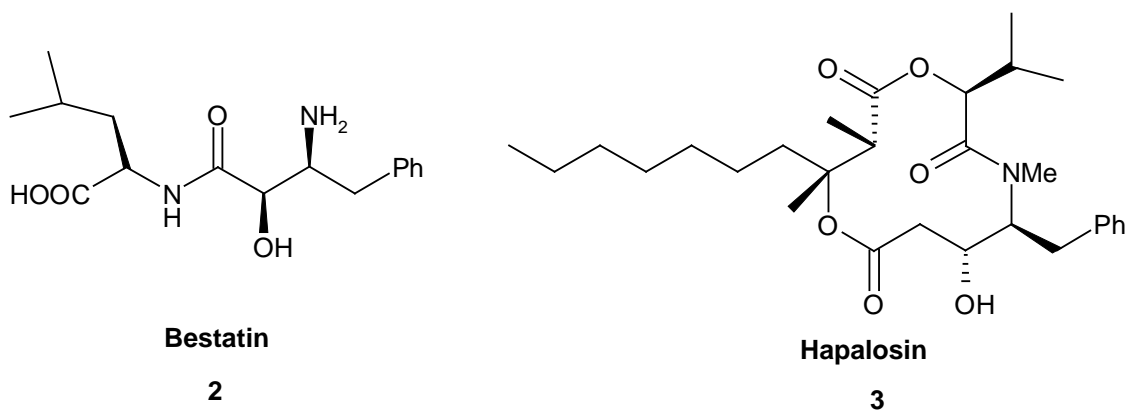

**Fig. 1**

Lipids and lipid-like molecules make up of a large class of naturally occurring molecules containing the vicinal amino alcohol moiety (**Fig. 2**). Possibly, the most synthesized molecule of all amino alcohols is sphingosine **4**.<sup>4</sup> Sphingosine **4** is a compound which was originally considered to be important in cell signaling.<sup>5</sup> Structurally sphingosine and analogues are 2-amino-1,3-diols. Frequently the amino group is acylated and the 1-hydroxyl is substituted. Sulfobacin B **5** is an interesting sphingosine analogue recently isolated.<sup>6</sup> This lipid is a von Willebrand factor receptor antagonist and as such should be a useful antithrombotic agent. Myriocin **6** is one member of a group of structurally similar lipids. This densely functionalized amino alcohol contains additional hydroxyl

groups as well as a carboxylic acid. These compounds, which are isolated from the thermophilic ascomycete *M. albomyces*, are potent immunostimulatory agents.

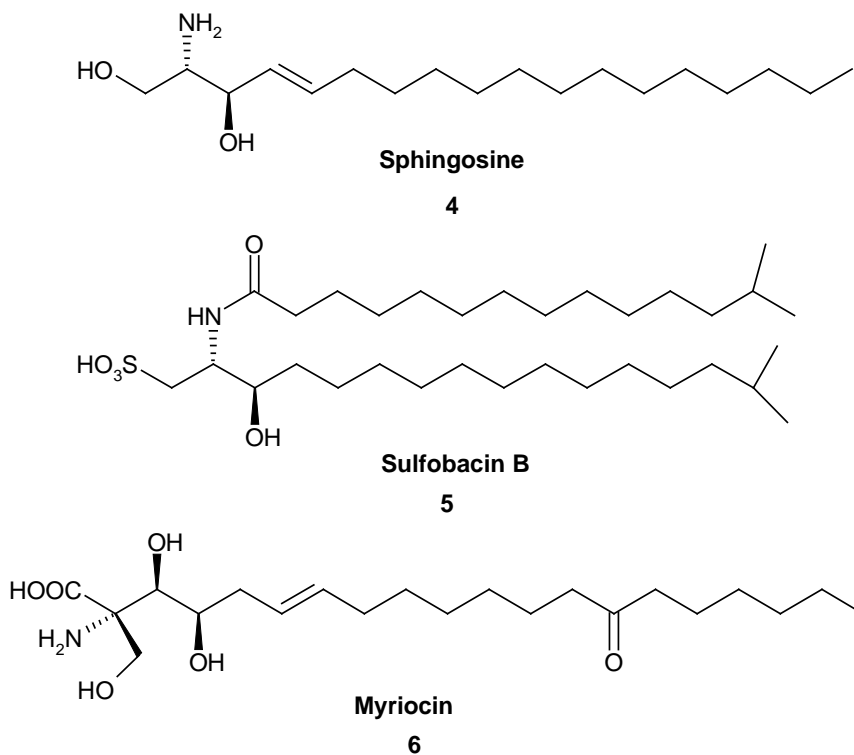

**Fig. 2**

A third large group of amino alcohols are the cyclic amino alcohols in which the amino group of the vicinal amino alcohol is contained within a ring. Some well-known examples<sup>7</sup> are shown in **Fig. 3**.

## 2. Synthetic pharmacologically active molecules

A host of synthetic molecules used as drugs or pharmacological agents also contain the vicinal amino alcohol moiety. Often these compounds are analogues of natural products which also contain a vicinal amino alcohol. Among the best known are the hydroxyethylene isostere peptidomimetics. This group of peptide analogues is typified by the HIV protease inhibitor squinavir **11**.<sup>8</sup> Recently, the amino alcohol **12** has been

reported to selectively interact with RNA.<sup>9</sup> This molecule was discovered in a random screening of commercially available amino alcohols. Molecules such as **12** which contain the vicinal

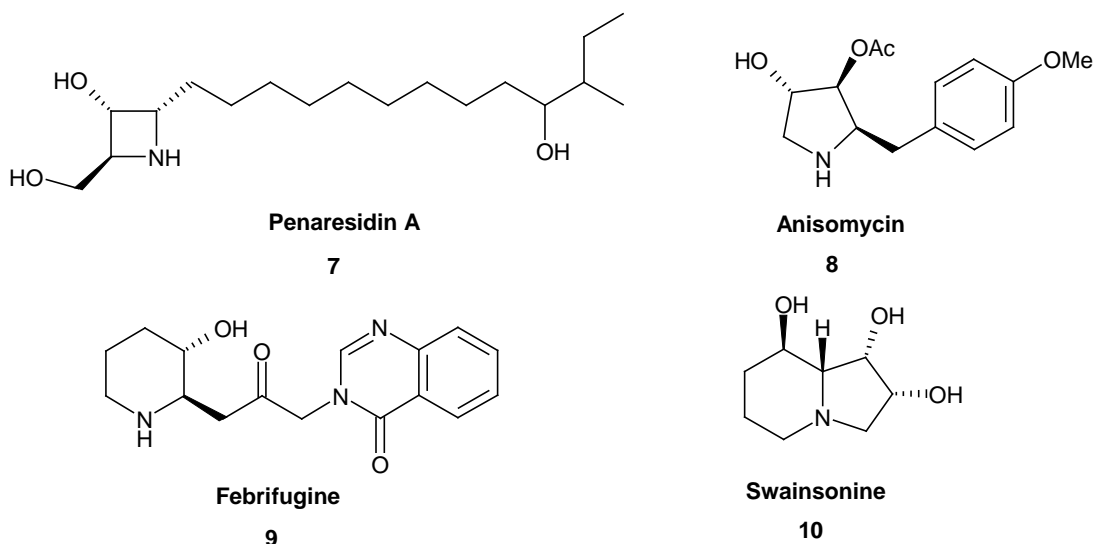

Fig. 3

amino alcohols are being investigated as anti-HIV agents. The amidine containing molecule **13** is reported to be an inhibitor of nitric oxide synthetase and has therapeutic implications for the treatment of a wide range of disease states<sup>10</sup> (**Fig. 4**). The presence of the vicinal amino alcohol moiety in these pharmacologically active molecules is essential for their biological activity. The need to prepare these compounds as well as analogues has dramatically increased the importance of the development of methods for the synthesis of vicinal amino alcohols.

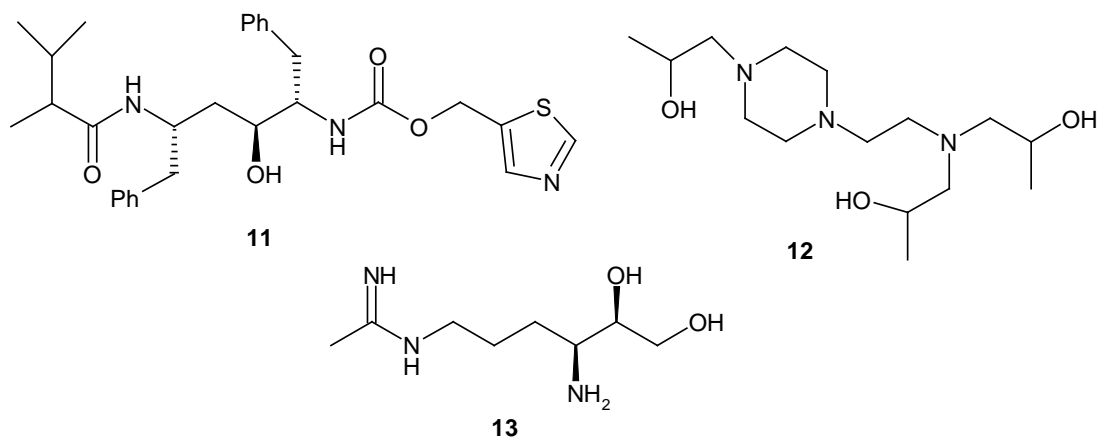

Fig. 4

### 3. Ligands and chiral auxiliaries

A number of chiral reagents utilize enantiomerically pure amino alcohols as ligands or chiral auxiliaries<sup>11</sup> (Fig. 5). The best known are the Evans auxiliaries **14**.<sup>12</sup> These amino alcohol derived oxazolidinones have been used for a host of reactions ranging from aldol condensations to Diels-Alder reactions. The oxazaborolidines **15** derived from proline have been extensively used for the asymmetric reductions of carbonyl compounds.<sup>13</sup> The ephedrine **16** derivative has been used as a chiral proton quench to deracemize an enolate.<sup>14</sup>

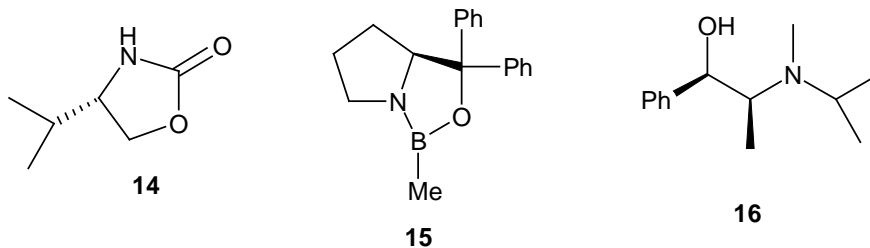

Fig. 5

Just as there are many examples of molecules containing the vicinal amino alcohol moiety, there are an equally large number of synthetic routes to these molecules. The most common variant of functional group manipulation is the addition of a nucleophile to

an  $\alpha$ -amino carbonyl compound. The generation of high levels of diastereoselectivity and the stability of the  $\alpha$ -amino carbonyl compound have sometimes been problems with this method. For example, the addition of allyl magnesium bromide to the  $\alpha$ -amino aldehyde **17** produces only a moderate yield of a 7:1 mixture of *syn*- and *anti*-isomers **18** and **19** (Scheme 1).<sup>15</sup>

The corresponding reactions between a protected  $\alpha$ -hydroxy imine and a nucleophile are not as well represented due to the relative instability of the imines. One example in which

a

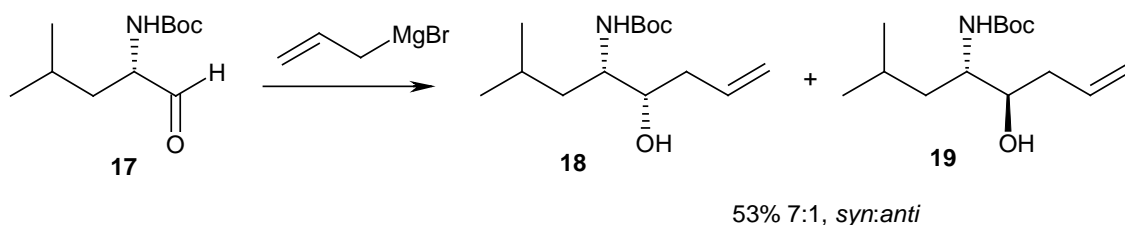

Scheme 1

protected  $\alpha$ -hydroxy imine used directly is shown in Scheme 2.<sup>16</sup> Imine **20** is treated with an organometallic reagent to provide the *syn*-isomer **21** as the major product. Yields for this reaction are generally good (37-78%).

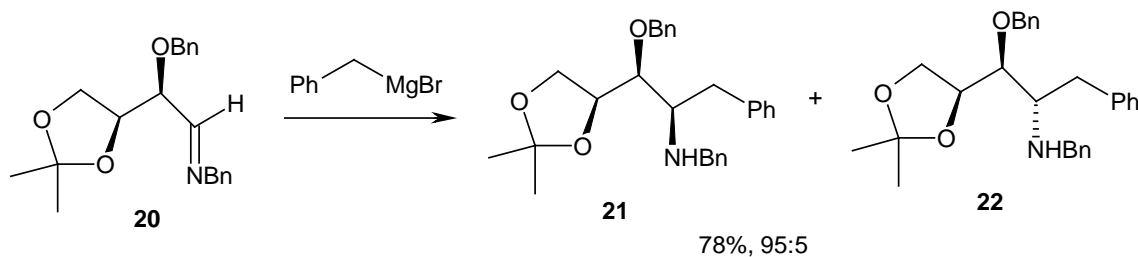

Scheme 2

Amines and azide ion can readily open epoxides to form a vicinal amino alcohol or azido alcohol.<sup>17</sup> Azido alcohols are readily converted to the amino alcohols.<sup>18</sup> An example of



this reaction is shown in **Scheme 3**.<sup>19</sup> Epoxide **24** is prepared from the corresponding allylic alcohol via a Katsuki-Sharpless asymmetric epoxidation. Treatment of **24** with benzyhydral amine provides vicinal amino alcohol **25** in good yield. Reaction of similarly substituted epoxides generally provides the regiochemistry shown. Similarly, reaction with azide provides the azido alcohol **23** in near quantitative yield.

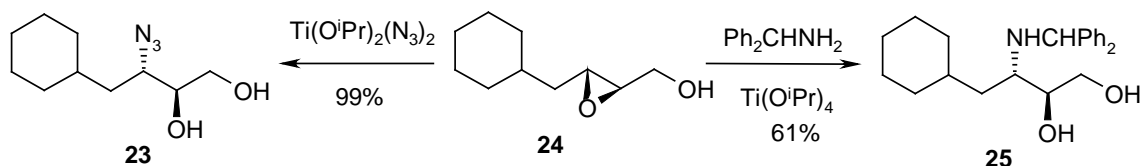

**Scheme 3**

There are number of methods by which one hetero atom can be added to a molecule already containing a hetero atom. One method that has been utilized is the intramolecular addition of nitrogen to an electrophilic carbon, typically an olefin which has been activated by an electrophilic reagent.<sup>20</sup> A particularly interesting route is the intramolecular cyclization of the allenyl carbamate **26**. Reaction of **26** with an aryliodonium salt and a palladium catalyst provides oxazolidinone **27** (**Scheme 4**).

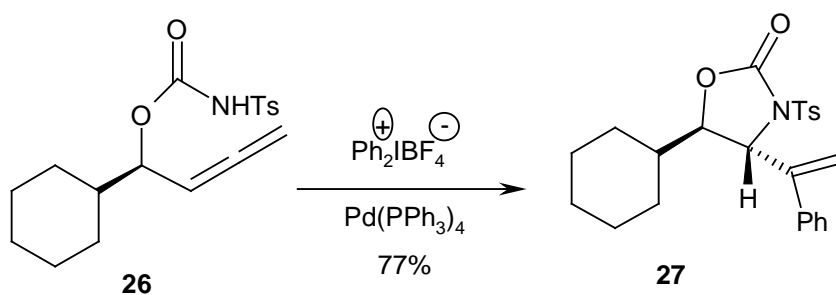

**Scheme 4**

The addition of oxygen to a molecule already containing nitrogen is not a commonly used route to vicinal amino alcohols. A method analogous to the chemistry shown in scheme 5 is the intramolecular reaction of a hemiaminal **29** with an olefin.<sup>21</sup> The nitrogen counterpart (nitrogen adds to olefin) has been reported.<sup>22</sup> In this

interesting reaction, treatment of 25 with Pd(OAc)<sub>2</sub> provides a separable mixture of oxazolidines 30 and 31 in fair yield (Scheme 5). The diastereoselectivity in this very interesting reaction is unfortunately not particularly good. Conversion of 30 or 31 to the N-Boc amino alcohol is accomplished by ester hydrolysis, anodic oxidation and a final hydrolysis to the vicinal amino alcohol in > 90% yield.

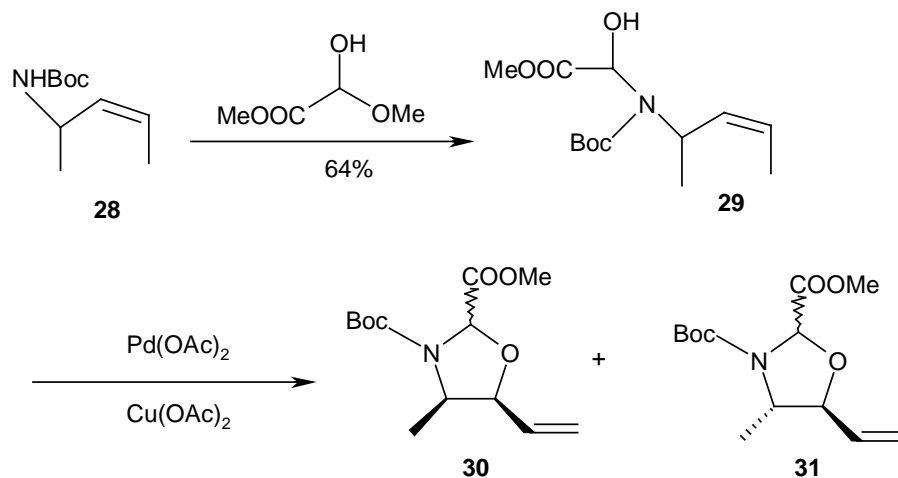

Scheme 5

There are two general types of coupling reactions that have been used in the synthesis of vicinal amino alcohols. Aldol reaction in the presence of a chiral catalyst. The Henry reaction is a typical example<sup>23</sup> (Scheme 6) and Pinacol-type reaction<sup>24</sup> (Scheme 7).

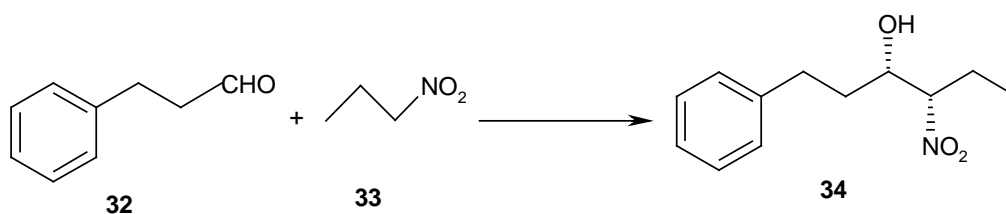

Scheme 6

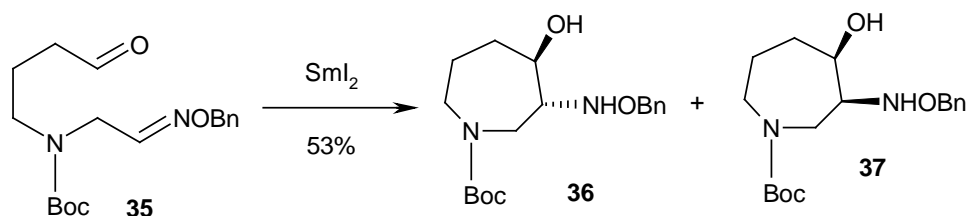

Scheme 7

Asymmetric aminohydroxylation of olefin is possibly the most basic route to vicinal amino alcohols which can be prepared in single step using Sharpless<sup>25</sup> method in the presence of cinchona alkaloid ligands (Scheme 8).

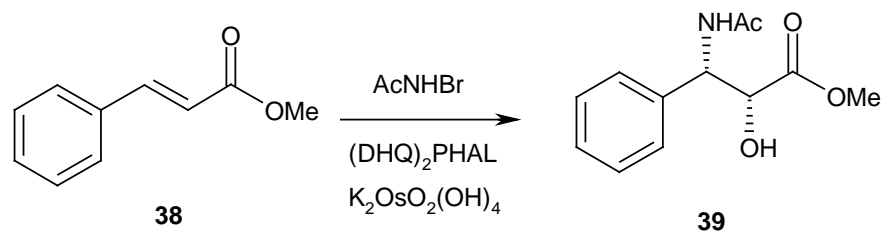

**Scheme 8**

Thus, there are numerous routes to the vicinal amino alcohol moiety. The choice of synthetic route for a given application will vary depending upon substitution, as well as the relative and/or absolute stereochemistry desired. A key theme in many of these methods is the generation of enantiomerically pure compounds. We have utilized asymmetric aminohydroxylation, a recent discovery of Sharpless<sup>25</sup> to synthesize the target molecules such as (+)-L-733 060, *L-threo*-sphinganine and (-)-deoxocassine.

This chapter consisting of three sections mainly focuses on the synthesis of

- (i) **(+)-L-733,060** : A non-peptide neurokinin NK1 receptor antagonist having variety of biological activities including neurogenic inflammation, pain transmission and regulation of the immune response.
- (ii) ***L-threo*-sphinganine** : a biosynthetic precursor to sphingolipids, which is a long chain amino alcohol, generally possessing 18 or 20 carbon atoms as the backbone structure. The amino alcohol moiety has been arrived via Sharpless asymmetric aminohydroxylation in a single step.
- (iii) **(-)-Deoxocassine** : It is class of 3-hydroxy-2,6-disubstituted piperidine endowed with important biological activities. The Sharpless asymmetric aminohydroxylation was used as the key step in this synthesis.

## 4.2 SECTION A: ENANTIOSELECTIVE SYNTHESIS OF (+)-L-733,060

---

### 4.2.1 Introduction

Substance P (SP), a peptide neurotransmitter, is a member of the tachykinin family of peptides, which include neurokinins A and B (NKA, NKB)<sup>26</sup> (**Fig. 6**). These peptides bind to a series of three neurokinin receptors, NK<sub>1</sub>, NK<sub>2</sub>, and NK<sub>3</sub>, which have selective affinity for SP, NKA, and NKB respectively.<sup>27</sup> For example SP has been shown to elicit a IL-1 production in macrophages,<sup>28</sup> sensitize neutrophils,<sup>29</sup> and enhance dopamine release in the substantia nigra region in cat brain.<sup>30</sup> Its key position at the interface between the immune system and CNS suggests SP may be involved in a variety of important disease. Substance P shows number of biological activities like neurogenic inflammation,<sup>31</sup> pain transmission and regulation of the immune response.<sup>32</sup> There is SP's role in rheumatoid arthritis,<sup>33</sup> ulcerative colitis<sup>34</sup> and migraine.<sup>34</sup> The non-peptidic neurokinin NK<sub>1</sub> receptor antagonists **41** and **42** are good synthetic targets due to variety of biological activities since *cis*-relationship between the two substituents on the piperidine ring is essential for high-affinity binding to the human NK<sub>1</sub> receptor.

### 4.2.2 Review of Literature

Various asymmetric syntheses of non-peptidic neurokinin NK<sub>1</sub> receptor antagonist (+)-L-733,060 **41** and several synthesis of intermediate (2*S*,3*S*)-3-hydroxy-2-phenyl piperidine **40** have been documented in the literature. A different and highly enantioselective synthesis based on the asymmetric dihydroxylation of silyl enol ether has been reported by Stadler *et al.*<sup>35</sup> Other interesting methodologies involve the use of chiral epoxides<sup>36</sup>

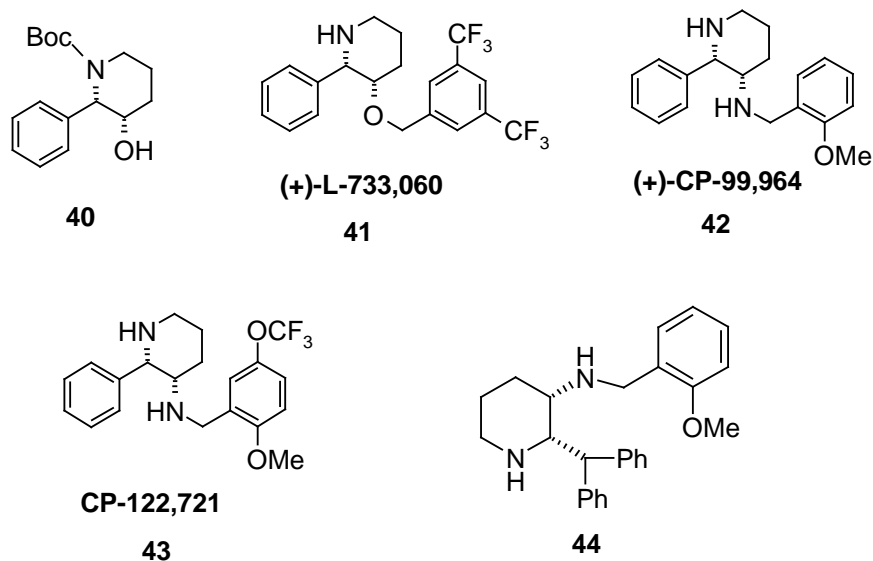

Figure 6

followed by intramolecular opening and a novel 1,4-aryl migration from silicon to carbon which was developed by Tomooka group.<sup>37</sup> Very recent methods describe the use of chiral pool<sup>38</sup> and chiral auxiliary<sup>39</sup> procedures.

Some of the interesting and important synthetic routes to (2S,3S)-3-hydroxy-2-phenyl piperidine **40** and (+)-L-733,060 **41** are described below.

Stadler *et al.* (1999)<sup>35</sup>

In this synthetic approach, Stadler utilized Sharpless asymmetric dihydroxylation as the source of chirality. The AD reaction of **46** provided **47** which was subjected to hydrogenolytic condition leading to a mixture of *cis*- and *trans*-isomers **48** and **49** which was separated by crystallization to yield **48**. (Scheme 9)

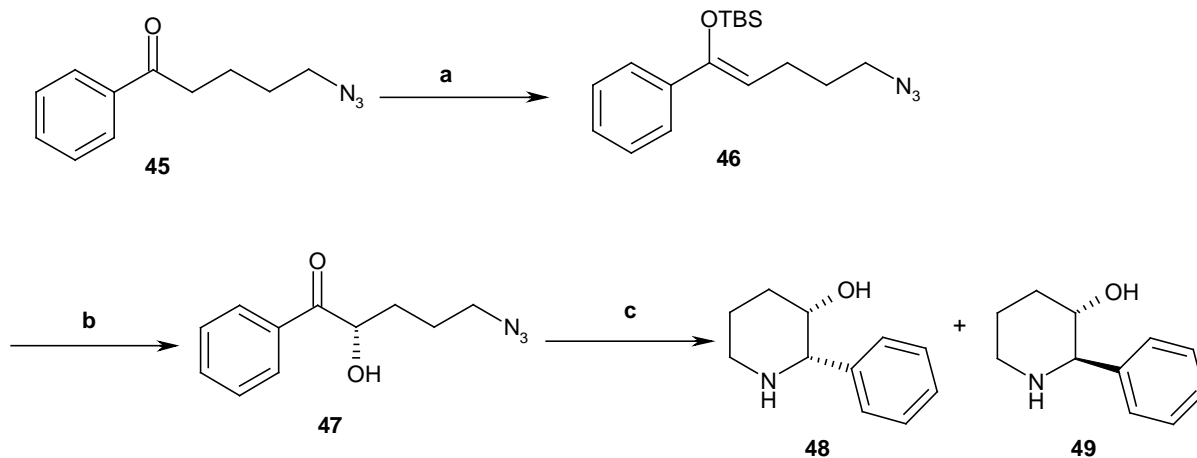

Scheme 9

**Scheme 9 : Reaction conditions :** (a) Et<sub>3</sub>N, TBDMS-Cl, CH<sub>3</sub>CN, 84% ; (b) K<sub>3</sub>FeCN<sub>6</sub>, K<sub>2</sub>CO<sub>3</sub>, CH<sub>3</sub>SONH<sub>2</sub>, OsO<sub>4</sub> (DHQ)<sub>2</sub>PHAL, H<sub>2</sub>O/*t*-BuOH ; (c) Pd/C, MeOH.

Kumar *et al.* (2004)<sup>40</sup>

Another interesting short synthesis of **40** was achieved by P. Kumar and co-workers where chelation-controlled Grignard addition to an aldehyde was employed as the key step. L-Phenyl glycine **50** was converted to known alcohol **52**. The alcohol **52** was oxidized to aldehyde and treated with Grignard reagent to afford **53**. Deprotection of –OTHP in **53** followed by cyclization and deprotection steps completed the synthesis of **40**. (Scheme 10)

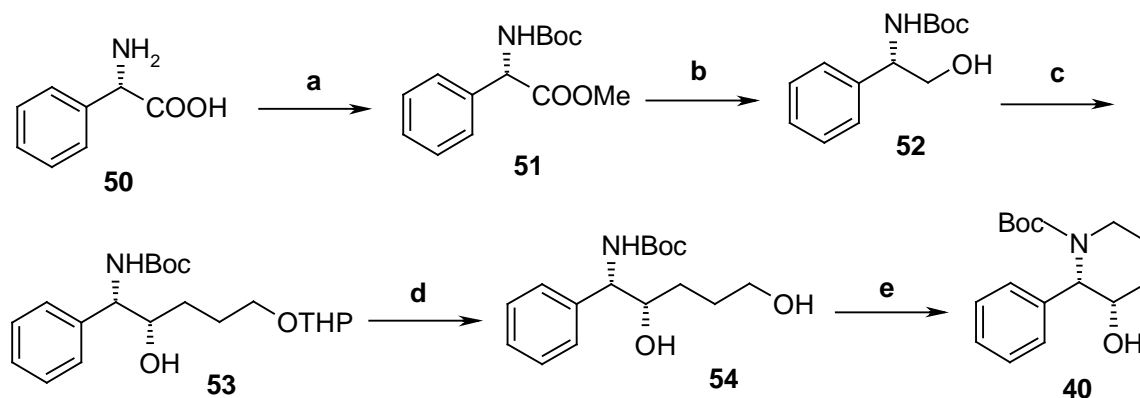

Scheme 10

**Scheme 10 : Reaction conditions :** (a) (i) (Boc)<sub>2</sub>O, 1N NaOH, dioxane, 2 h, 0 °C–rt, 95% ; (ii) K<sub>2</sub>CO<sub>3</sub>, CH<sub>3</sub>I, 1 h, 0 °C –rt, 85% ; (b) LAH, THF, 1 h, 0 °C –rt, 89% ; (c) DMSO, (COCl)<sub>2</sub>, DCM, <sup>i</sup>-Pr<sub>2</sub>NEt then

BrMgCH<sub>2</sub>CH<sub>2</sub>CH<sub>2</sub>OTHP, THF, 2 h, rt, 58% ; (d) *p*-TsOH, MeOH, 2 h, rt, 85% ; (e) (i) MsCl, Et<sub>3</sub>N, DCM, 3 h, 0 °C–rt, (ii) NaH, THF, rt, 78%.

B. V. Rao *et al.* (2003)<sup>38a</sup>

Rao *et al.* described stereoselective synthesis of (+)-L-733,060 using ring-closing metathesis as a key step. The commercially available L-phenyl glycine **50** was converted to *N*-Boc methyl ester **51** followed by reduction to afford the alcohol **52**. Oxidation of **52** and *in situ* vinyl Grignard gave **55**. The hydroxyl group of **55** was protected as TBS ether followed by treatment with allyl bromide to give **57**. Desilylation of **57** followed by ring-closing metathesis gave **58**. Hydrogenation, coupling of free hydroxyl group with 3,5-bis(trifluoromethyl)-benzyl bromide followed by deprotection of Boc group afforded the target molecule **41**.

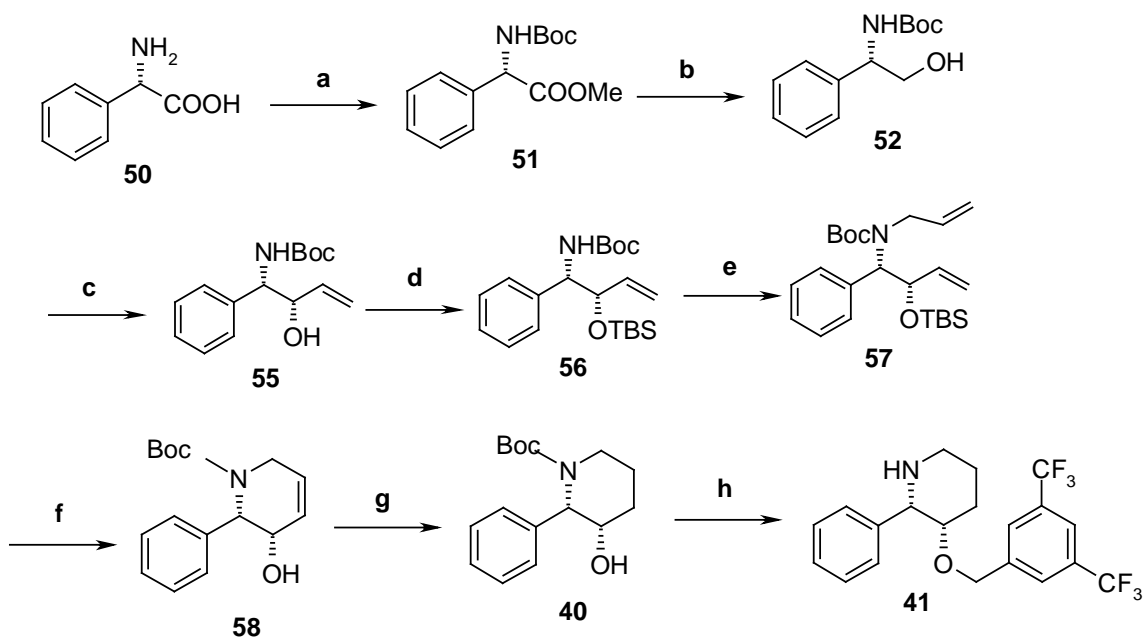

**Scheme 11**

**Scheme 11 : Reaction conditions :** (a) AcCl, MeOH then (Boc)<sub>2</sub>, Et<sub>3</sub>N, THF, 0 °C–rt, 8 h, 97% ; (b) LiCl, NaBH<sub>4</sub>, EtOH, THF, 0 °C–rt, 12 h, 87% ; (c) DMSO, (COCl)<sub>2</sub>, DCM, <sup>i</sup>Pr<sub>2</sub>NEt then CH<sub>2</sub>=CHMgBr, THF, 2 h, rt, 61% ; (d) TBDMS-Cl, imidazole, DCM, 0 °C–rt, 24 h, 90% ; (e) CH<sub>2</sub>=CHCH<sub>2</sub>Br, NaH, DMF, 0 °C–rt, 24 h, 90% ; (f) (i) TBAF-AcOH, THF, 0 °C–rt, 24 h, 85% ; (ii) Grubbs' catalyst, DCM, rt, 6 h, 82% ; (g) Pd/C, H<sub>2</sub>, EtOH, 4 h, rt, 65% ; (h) (i) 3, 5-bis(trifluoromethyl)benzyl bromide, NaH, DMF, 80 °C, 13 h, 80% ; (ii) trifluoroacetic acid, rt, 1 h, 79%.

Huang *et al.* (2003)<sup>38b</sup>

Huang and co-workers synthesized (+)-L-733,060 starting from a new (3*S*)-piperidinol synthon **62** derived from L-glutamic acid **59**. Initially L-glutamic acid was converted to **60** which was treated with *p*-methoxybenzyl amine to give lactone-amide **61**. The ring expansion of the lactone-amide **61** to glutarimide **62**, followed by free hydroxyl group protection and reduction of keto group afforded predominantly the desired regioisomer **63**. At this stage Lewis-acid promoted Si to C-2 phenyl group migration of **63** followed by reduction of keto group gave **65**. Subsequent hydrogenolysis, coupling with 3,5-bis(trifluoromethyl)benzyl bromide and Boc group deprotection gave the target compound **41**.

(Scheme 12)

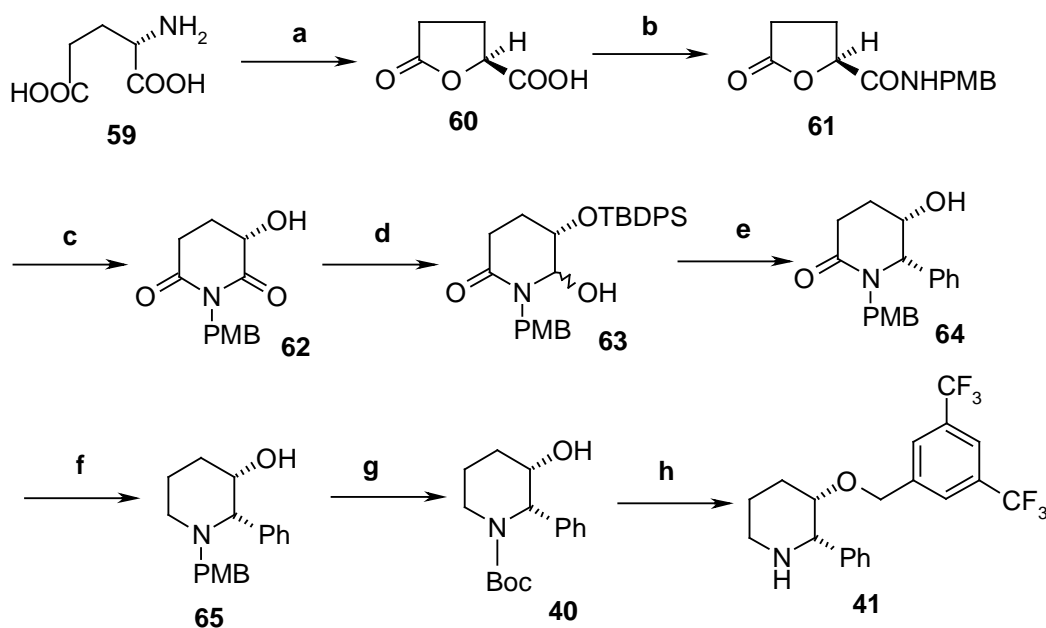

Scheme 12

**Scheme 12: Reaction conditions** : (a) H<sub>2</sub>SO<sub>4</sub>, NaNO<sub>3</sub> ; (b) (i) SOCl<sub>2</sub>, 60 °C ; (ii) PMB-NH<sub>2</sub>, CH<sub>2</sub>Cl<sub>2</sub>, rt, 70% ; (c) *t*-BuOK, THF, -78 °C-40 °C, 90% ; (d) (i) TBDPS-Cl, imidazole, CH<sub>2</sub>Cl<sub>2</sub>, -20 °C, 94% ; (ii) NaBH<sub>4</sub>, MeOH, -20 °C, 94% ; (e) BF<sub>3</sub>.OEt<sub>2</sub>, CH<sub>2</sub>Cl<sub>2</sub>, rt, 80% ; (f) LAH, THF, rt, 81% ; (g) 20% Pd(OH)<sub>2</sub>/C, H<sub>2</sub>, EtOH, (Boc)<sub>2</sub>O, rt, 88% ; (h) (i) NaH, DMF, 3,5-bis-trifluoromethyl benzylbromide, rt, 75% ; (ii) TFA, CH<sub>2</sub>Cl<sub>2</sub>, rt, 93%.

Charette *et al.* (2004)<sup>39c</sup>



Charette *et al.* described the addition of nucleophiles to 3-substituted pyridinium salts prepared from *N*-methylbenzamide and this methodology has been applied to synthesis of antipode of 41. Activation of amide 71 in the presence of pyridine 68 followed by the addition of phenylmagnesium bromide led to 1, 2-dihydropyridine 69 as a single regio- and diastereomer. The diastereoselective hydrogenation of 69 from the opposite face of the phenyl ring at C-2 afforded piperidine antipode of 41 as a single diastereomer.

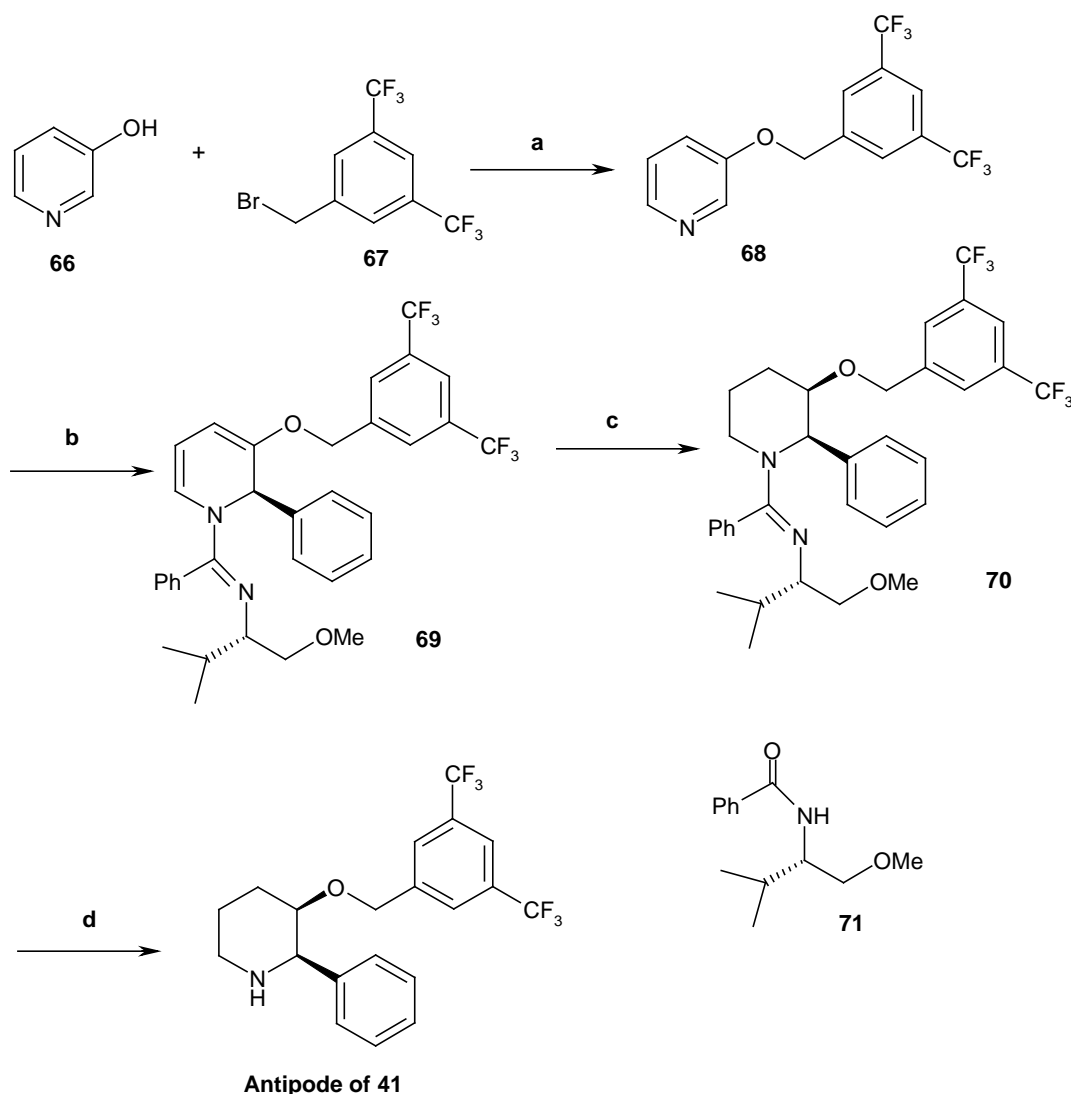

Scheme 13

**Scheme 13 : Reaction conditions :** (a)  $\text{NaH}$ , DMF,  $0\text{ }^\circ\text{C}$  to rt, 70% ; (b) 70,  $\text{Tf}_2\text{O}$ ,  $\text{PhMgBr}$ ,  $-40\text{ }^\circ\text{C}$  to  $-10\text{ }^\circ\text{C}$ , 84% ; (c)  $\text{H}_2$  (250psi),  $\text{PtO}_2$ , AcOH, rt, 52% ; (d)  $\text{AlH}_3$ ,  $\text{Et}_2\text{O}$ ,  $0\text{ }^\circ\text{C}$  to rt, 75%.

Ham *et al.* (2005)<sup>38c</sup>

In this approach Ham *et al.* demonstrated the asymmetric synthesis of 41 which involves diastereoselective oxazoline formation catalyzed by Pd(0) and intramolecular cyclization by catalytic hydrogenation of oxazoline. *Trans*-oxazoline 73 was obtained from *L*-*N*-benzoyl phenylglycinol 72 in enantiopure form which was subjected to ozonolysis followed by Wittig olefination to give 74. 1,4-Reduction of 74 and subsequent hydrogenolysis led to 75. Compound 75 was reduced followed by subsequent coupling and deprotection steps to give the target molecule 41.

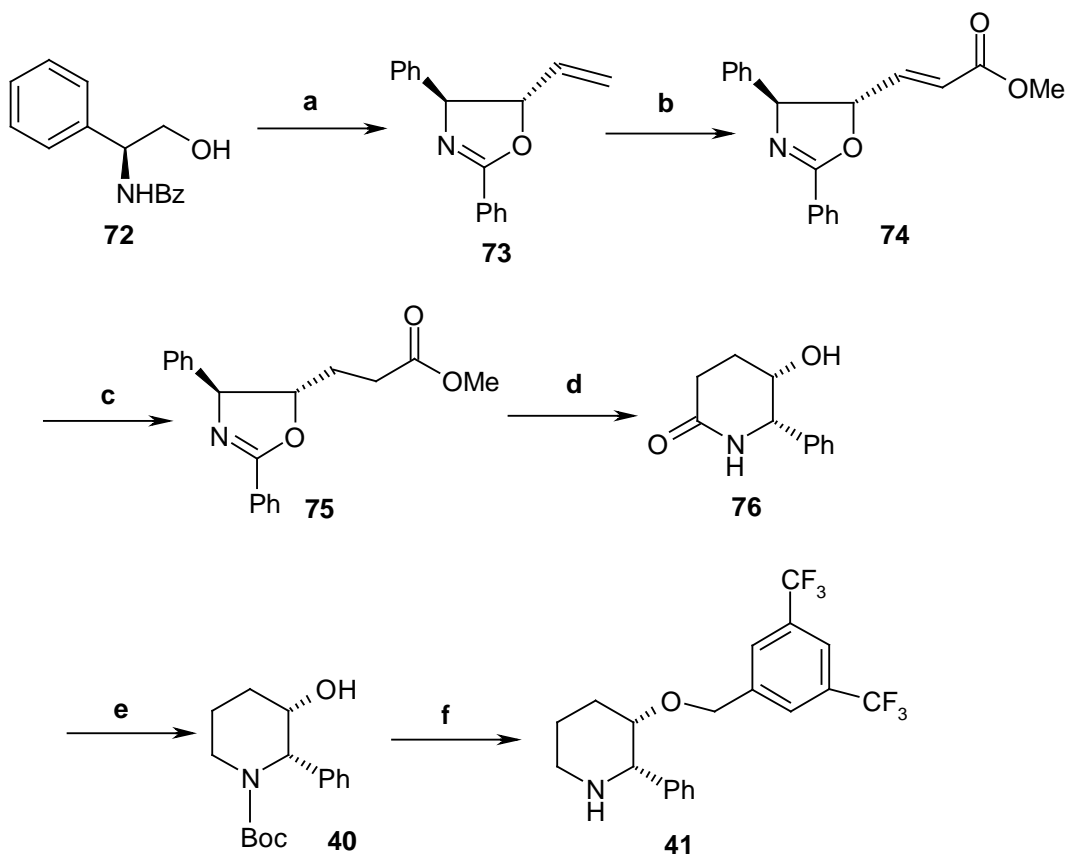

Scheme 14

**Scheme 14 : Reaction conditions :** (a) ref.41 (b) (i) O<sub>3</sub>, MeOH, -78 °C, then DMS ; (ii) (OMe)<sub>2</sub>POCH<sub>2</sub>COOMe, LiCl. <sup>i</sup>-Pr<sub>2</sub>NEt, CH<sub>3</sub>CN, 87% ; (c) CuBr, Red-Al, 2-butanol, THF, 83% ; (d) 20% Pd(OH)<sub>2</sub>/C, 70 psi, H<sub>2</sub>, MeOH/AcOH (10:1), 76% ; (e) (i)

BH<sub>3</sub>.SMe<sub>2</sub>, MeOH, THF ; (ii)(Boc)<sub>2</sub>O, CH<sub>2</sub>Cl<sub>2</sub>, 62% ; (f) (i) 3,5-bis(trifluoromethyl)benzyl bromide, NaH, DMF, 76% ; (ii) trifluoroacetic acid, 93%.

### 4.2.3 Present work

#### *Objective*

All the literature methods for the synthesis of **41** involves the use of either chiral pool or chiral auxiliary methods. Hence a general strategy and highly enantioselective synthesis of (+)-L-733,060 is still desirable. The asymmetric aminohydroxylation of  $\alpha$ ,  $\beta$ -unsaturated ester with *trans*-olefinic bond provides a suitable approach to *threo*-amino alcohols in high enantiomeric purity. Since (+)-L-733,060 has a *threo*-amino alcohol configuration, it can easily be derived through asymmetric aminohydroxylation.

The retro-synthetic analysis for **41** is outlined in **Scheme 15**. We envisioned that the target molecule could be constructed through the coupling reaction between the key intermediate **40** and 3,5-bis(trifluoromethyl)benzyl bromide **77**. The intermediate **40** in turn could be prepared from **78** which in turn would be derived from amino alcohol **79**. Compound **79** could easily be obtained in a single step by the aminohydroxylation of cinnamic acid **80**.

### 4.2.4 Results and Discussion

The detailed information regarding the reagents, solvents and reaction conditions followed by usual workup is provided in **Scheme 16** and in the experimental section. The synthesis of (+)-L-733,060 commences from the commercially available, cinnamic acid **80** which was first converted to isopropyl cinnamate **81** using isopropanol and catalytic amount of HCl under reflux conditions. In the <sup>1</sup>H NMR spectrum two methyl peaks appeared at  $\delta$  1.32 and 1.33 as two singlets and  $-CH(CH_3)_2$  proton appeared at 5.14-5.17 as multiplet. Olefin **81** was subjected to Sharpless asymmetric aminohydroxylation using freshly

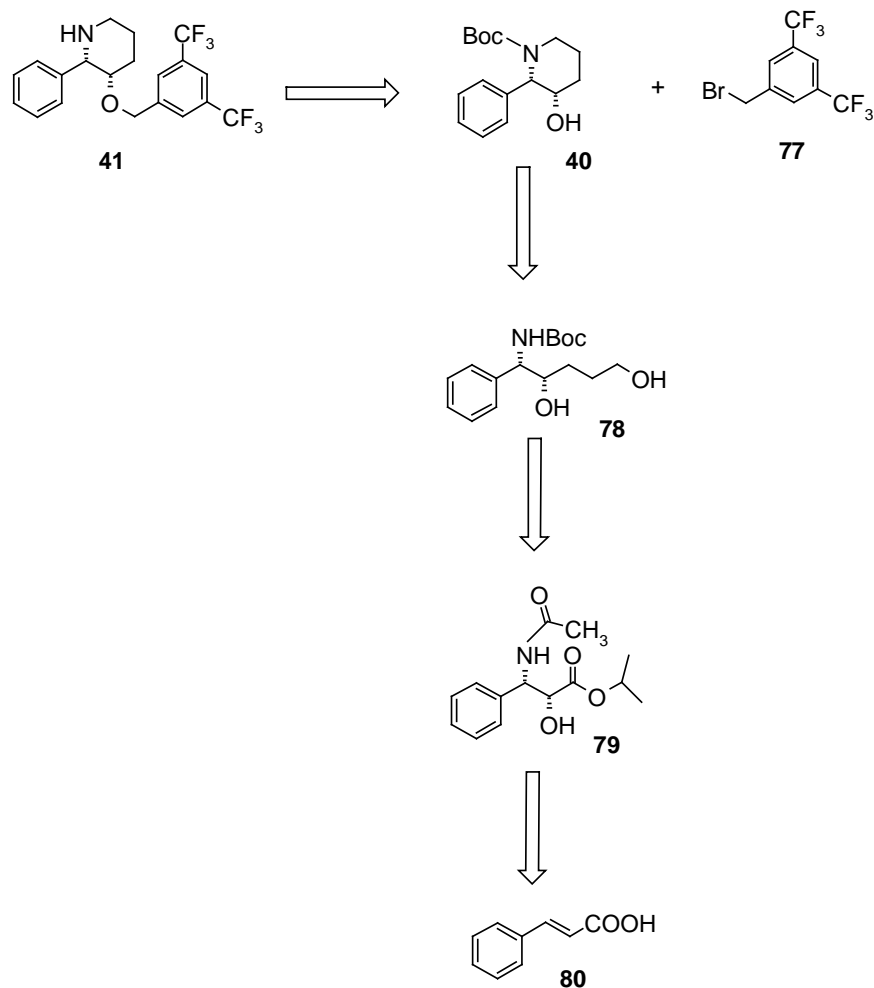

**Scheme 15 : Retrosynthetic analysis of (+)-L-733,060**

prepared *N*-bromoacetamide<sup>42a</sup> as nitrogen source, (DHQ)<sub>2</sub>PHAL ligand and potassium osmate as oxidant to give the desired amino alcohol **79** as a single isomer in 76% yield and with >99% ee<sup>42b</sup>, [ $\alpha$ ]<sub>D</sub><sup>25</sup>: + 28.5 (*c* 1.0, CHCl<sub>3</sub>) {Lit.<sup>42b</sup> [ $\alpha$ ]<sub>D</sub><sup>18</sup>: + 28.3 (*c* 1.0, CHCl<sub>3</sub>)}. IR spectrum of **79** showed strong hydroxyl absorption and –NH stretching at 3492 and 3362 cm<sup>-1</sup> respectively. In the <sup>1</sup>H NMR spectrum olefin peaks disappeared and acetyl –CH<sub>3</sub> appeared at  $\delta$  2.02 as singlet and –CH(NHCOCH<sub>3</sub>), –CH(OH) and –NH protons appeared at  $\delta$  5.57 (d) and 4.49 (s)  $\delta$  6.27 (d) respectively. In the <sup>13</sup>C NMR spectrum absence of olefin peaks and presence of acetyl carbonyl at  $\delta$  169.6 and –CH(NHCOCH<sub>3</sub>) and –CH(OH) carbons at  $\delta$  54.4 and 73.3 respectively confirmed the formation of product. Further, in order to achieve the synthesis of target compound **41** from **79**, we required a suitable amino protecting group for further synthetic manipulations. To this end the amide **79** was subjected to hydrolysis in methanol under reflux to furnish

free amine with concomitant *trans* esterification to the methyl ester.<sup>42c</sup> The successive conversion of amine into the Boc protected amino alcohol **82** was carried out using Boc<sub>2</sub>O in the presence of triethyl amine. The <sup>1</sup>H NMR spectrum of **82** indicated the presence of Boc methyl protons at δ 1.43 as singlet and –OMe peak at δ 3.85 as singlet. In the <sup>13</sup>C NMR spectrum Boc carbonyl peak appeared at δ 155.1 clearly indicating the formation of product. Having achieved the synthesis of **82** in high enantiomeric purity, we then proceeded with the protection of hydroxyl group as the TBS-ether to afford **83** in 91% yield. Compound **83** was characterized using normal spectroscopic methods. In the <sup>1</sup>H NMR spectrum methyl protons of TBS group appeared at δ 0.17 and 0.08 as two singlets and singlet for 9 protons at δ 0.75. Compound **83** was reduced to the corresponding alcohol **84** using DIBAL-H in dry DCM at 0 °C-rt. The IR spectrum of **84** showed absence of carbonyl absorption and presence of strong hydroxyl stretching at 3520 cm<sup>-1</sup>. In the <sup>1</sup>H NMR spectrum, –OMe peak disappeared. The oxidation of alcohol **84** was carried out using PCC to give the corresponding aldehyde which on subsequent Wittig reaction with (ethoxycarbonylmethylene)triphenylphosphorane afforded the olefin **85** in good yield. The IR spectrum of **85** showed olefin absorption at 1621 cm<sup>-1</sup> and in the <sup>1</sup>H NMR and <sup>13</sup>C NMR spectra olefin peaks appeared at δ 6.00 (d, *J* = 15 Hz), 6.97-7.01 (m) and δ 116.4, 122.1 respectively. The olefin reduction by hydrogenation using 10% Pd/C resulted in concomitant deprotection of the TBS group to furnish compound **86** in excellent yield. The spectroscopic data clearly indicated the absence of olefin and deprotection of TBS group as confirmed from <sup>1</sup>H and <sup>13</sup>C NMR spectra.

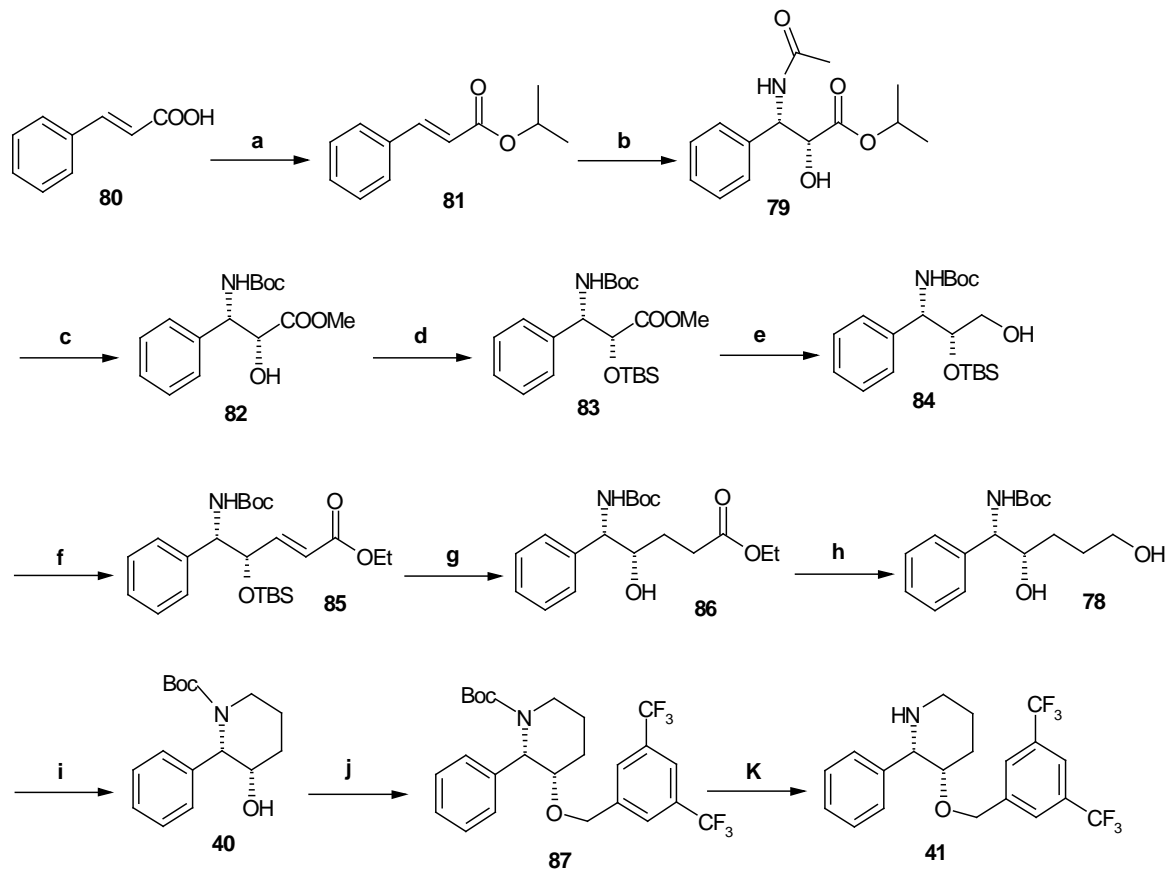

Scheme 16

**Scheme 16 : Reaction conditions :** (a) isopropanol, HCl (cat.), reflux, 12 h, 76%; (b) (DHQ)<sub>2</sub>PHAL, K<sub>2</sub>[OsO<sub>2</sub>(OH)<sub>4</sub>], CH<sub>3</sub>CONHBr, LiOH, *t*-BuOH:H<sub>2</sub>O (1:1), 4 h, 76%; (c) (i) 0.5M HCl, MeOH, reflux, 15 h, (ii) Boc<sub>2</sub>O, Et<sub>3</sub>N, dry CH<sub>2</sub>Cl<sub>2</sub> 0 °C-rt, 24 h, 94%; (d) TBDMSCl, imidazole, DMAP(cat.), dry CH<sub>2</sub>Cl<sub>2</sub>, rt, 10 h, 91%; (e) DIBAL-H, dry CH<sub>2</sub>Cl<sub>2</sub>, 0 °C-rt, 3 h, 93%; (f) (i) PCC, anhy.CH<sub>3</sub>COONa, celite, 5 h, rt, (ii) Ph<sub>3</sub>P=CHCOOEt, dry THF, rt, 24 h, 91%; (g) 10% Pd/C, MeOH, 6 h, 93%; (h) DIBAL-H, dry CH<sub>2</sub>Cl<sub>2</sub>, 0 °C-rt, 3 h, 90%; (i) CH<sub>3</sub>SO<sub>2</sub>Cl, Et<sub>3</sub>N, dry CH<sub>2</sub>Cl<sub>2</sub>, -78 °C, 1 h, 77%; (j) 3,5-bis-(trifluoromethyl)benzylbromide, NaH, dry DMF, 80 °C, 12 h, 78%; (k) CF<sub>3</sub>COOH, methanol, rt, 1 h, 70%.

The ester group of **86** was reduced to corresponding alcohol **78** using DIBAL-H in dry DCM at 0 °C-rt. The IR spectrum of **78** showed the absence of carbonyl stretching and presence of strong hydroxyl absorption at 3520-3422 cm<sup>-1</sup>. The <sup>1</sup>H and <sup>13</sup>C NMR spectra of **78** clearly showed the absence of ester functionality. Compound **78** was subjected to cyclization using methanesulfonyl chloride and triethyl amine as base in dry dichloromethane at -78 °C to give cyclized piperidine derivative **40** in good yield. The IR spectrum of

**40** showed absence of –NH– stretching and in the  $^1\text{H}$  NMR spectrum there was no peak for –NH. Etherification of hydroxyl group with 3,5-bis(trifluoromethyl)benzyl bromide using NaH as base gave **87** in 78% yield. Finally, *N*-Boc deprotection of **87** using TFA afforded the target molecule **41** in good yield. The physical and spectroscopic data of **2** were in full agreement with those reported.<sup>38a</sup>

### 4.2.5 Conclusion

In conclusion, a highly enantioselective synthesis of (+)-L-733,060 has been achieved employing a Sharpless asymmetric aminohydroxylation and Wittig reaction as key steps. The merits of this synthesis are high yielding steps and high enantioselectivity. To the best of our knowledge this is the first asymmetric synthesis employing Sharpless asymmetric aminohydroxylation as the source of chirality. The synthetic strategy described here has significant potential of further extension to other NK<sub>1</sub> receptor antagonists.

### 4.2.6 Experimental Section

#### General Information

Solvents were purified and dried by standard procedures before use. Petroleum ether of boiling range 60-80 °C was used. Melting points are uncorrected. Optical rotations were measured using the sodium D line of a JASCO-181 digital polarimeter. Infrared spectra were recorded with an ATI MATSISON RS-1 FT-IR spectrometer.  $^1\text{H}$  NMR and  $^{13}\text{C}$  NMR spectra recorded with a Bruker AC-200 spectrometer. Enantiomeric excess was

measured using either the chiral HPLC or by comparison with optical rotation. Elemental analyses were carried out with a Carlo Erba CHNS-O analyzer.

Preparation of *Trans*-isopropyl cinnamate

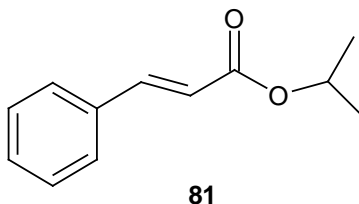

To a solution of cinnamic acid **80** (10 g, 67.49 mmol) in isopropanol (60 mL) was added cat. amount of HCl. The reaction mixture was refluxed for 12 h and neutralized with solid NaHCO<sub>3</sub> and filtered off. Solvent was evaporated and residue thus obtained was purified by silica gel column chromatography using EtOAc:pet.ether (0.5:9.5) as eluent to give **81** (9.76 g) as a colorless oil.

**Yield :** 76%

**IR (neat, cm<sup>-1</sup>):**  $\nu_{\max}$  1713, 1620, 1502, 1486, 1393

**<sup>1</sup>H NMR (CDCl<sub>3</sub>, 200 MHz):**  $\delta$  1.32 (d, *J* = 5 Hz, 6H), 5.14-5.17 (m, 1H), 6.43 (d, *J* = 20 Hz, 1H), 7.38-7.52 (m, 3H), 7.50 (d, *J* = 20 Hz, 1H), 7.68 (d, *J* = 20 Hz, 2H)

**<sup>13</sup>C NMR (CDCl<sub>3</sub>, 50 MHz):**  $\delta$  21.8, 67.6, 118.7, 127.8, 128.7, 129.9, 134.4, 144.1, 166.3

**Preparation of Isopropyl-(2*R*,3*S*)-3-(acetylamino)-2-hydroxy-3-phenylpropionate**

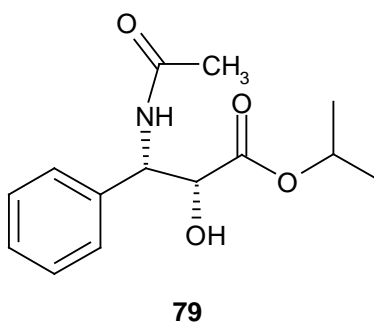

K<sub>2</sub>[OsO<sub>2</sub>(OH)<sub>4</sub>] (90 mg, 1.5 mol%) was dissolved with stirring in 60 mL of aqueous solution of LiOH.H<sub>2</sub>O (0.69 g, 16.42 mmol). After addition of *t*-BuOH (90 mL), (DHQ)<sub>2</sub>PHAL [123 mg, 1 mol%] was added and the mixture was immersed in a cooling bath set at 4 °C. After addition of isopropyl cinnamate **81** (3 g, 15.77 mmol), *N*-bromo acetamide (2.37 g, 17.77 mmol) was added in one portion which resulted in an immediate color change to green and the mixture was vigorously stirred at the same temperature. The



reaction was monitored by TLC, and pH (full conversion is indicated when the pH 7 of reaction mixture is attained). After 4 h, the reaction mixture was treated with Na<sub>2</sub>SO<sub>3</sub> (2.5 g) and stirred at rt for 30 min. The organic layer was separated and the water layer extracted with ethyl acetate (3x60 mL) and the combined organic extracts were washed with brine and dried over Na<sub>2</sub>SO<sub>4</sub>. The residue was purified by silica gel column chromatography using EtOAc:pet.ether (6:4) to afford **79** (3.2 g) as a white solid.

**Yield :** 76%

$[\alpha]_D^{25} : + 28.5$  (*c* 1.0, CHCl<sub>3</sub>) {Lit.<sup>42b</sup>  $[\alpha]_D^{18} : + 28.3$  (*c* 1.0 CHCl<sub>3</sub>)}

**M. p :** 112° [Lit.<sup>42b</sup> M.p. 111-112 °C]

**IR (CHCl<sub>3</sub>, cm<sup>-1</sup>):**  $\nu_{\max}$  3492, 3362, 1713, 1620, 1562, 1446, 1343

**<sup>1</sup>H NMR (CDCl<sub>3</sub>, 200 MHz):**  $\delta$  1.31 (d, *J* = 6.4 Hz, 6H), 2.02 (s, 3H), 3.32 (brs, 1H, OH), 4.49 (dd, *J* = 2.2, 3.6 Hz, 1H), 5.10-5.15 (m, 1H), 5.57 (d, *J* = 10 Hz, 1H), 6.27 (d, *J* = 10 Hz, 1H), 7.31-7.41 (m, 5H)

**<sup>13</sup>C NMR (CDCl<sub>3</sub>, 50 MHz):** 21.4, 21.5, 22.9, 54.4, 70.5, 73.3, 125.9, 126.8, 127.6, 128.5, 169.6, 172.3

**Analysis:** C<sub>14</sub>H<sub>19</sub>O<sub>4</sub>N (265.37) requires. C, 63.45 ; H, 7.22 ; N, 5.28 ; Found. C, 63.42 ; H, 7.20 ; N, 5.26.

Preparation of Methyl-(2*R*,3*S*)-3-(*tert*-butoxy carbonylamino)-2-hydroxy-3-phenyl propionate

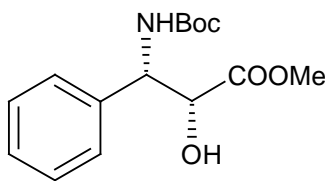

**82**

Amino alcohol **79** (0.52 g, 1.95 mmol) was treated with 0.5 M HCl in methanol (50 mL), and heated under reflux for 15 h. After removal of solvent under reduced pressure, the residue was dissolved in fresh methanol (2x50 mL) and evaporated. Dry CH<sub>2</sub>Cl<sub>2</sub> (20 mL) was added to the residue and solution cooled to 0 °C. To this suspension was added triethyl amine (0.68 mL, 4.08 mmol) in dry CH<sub>2</sub>Cl<sub>2</sub> (3 mL) followed by Boc<sub>2</sub>O (0.67 mL, 2.9 mmol) in dry CH<sub>2</sub>Cl<sub>2</sub> (2 mL). The reaction mixture was stirred for 30 min. at 0 °C and then for 24 h at room temperature. After TLC diagnosis, the reaction mixture was evaporated to near dryness and purified by silica gel column chromatography using EtOAc:pet.ether (3:7) to afford **82** (0.54 g) as a white crystalline solid.

**Yield :** 94%

**M. p :** 129°

$[\alpha]_D^{25}$  : - 7.1° (*c* 0.89, CHCl<sub>3</sub>) {Lit.<sup>42b</sup>  $[\alpha]_D^{25}$  = - 7.3 (*c* 1, CHCl<sub>3</sub>)}

**IR (CHCl<sub>3</sub>, cm<sup>-1</sup>) :**  $\nu_{\max}$  3521, 3362, 1722, 1682, 1517

**<sup>1</sup>H NMR (CDCl<sub>3</sub>, 200 MHz):**  $\delta$  1.43 (s, 9H), 1.62 (brs, 1H), 3.84 (s, 3H), 4.48-4.49 (m, 1H), 5.22 (d, *J* = 8 Hz, 1H), 5.40 (d, *J* = 6 Hz, 1H), 7.29-7.37 (m, 5H)

**<sup>13</sup>C NMR (CDCl<sub>3</sub>, 50 MHz):**  $\delta$  28.1, 52.8, 56.0, 73.4, 78.9, 126.6, 127.5, 128.4, 139.0, 155.1, 173.2

**Analysis:** C<sub>15</sub>H<sub>21</sub>NO<sub>5</sub> (295.33) requires. C, 61.07 ; H, 7.17 ; N, 4.74 ; Found. C, 61.03 ; H, 7.02 ; N, 4.69.

Preparation of Methyl-(2*R*,3*S*)-3-(*tert*-butoxycarbonylamino)-2-(*tert*-butyl-dimethyl-silyloxy)-3-phenyl propionate

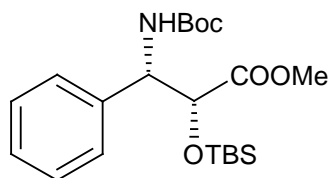

**83**

To a solution of 82 (0.3 g, 1.02 mmol), in dry CH<sub>2</sub>Cl<sub>2</sub> (10 mL) was added imidazole (72 mg, 1.06 mmol), TBDMSCl (0.24 g, 1.59 mmol) and cat. DMAP (6 mg, 0.051 mmol) sequentially. The resulting solution was stirred at rt for 10 h. The solvent was evaporated under reduced pressure and residue was extracted with dichloromethane. The organic layer was separated and dried over Na<sub>2</sub>SO<sub>4</sub>. The crude product was purified by silica gel column chromatography using EtOAc:pet.ether (1:9) to give 83 (0.38 g) as a colorless liquid.

**Yield :** 91%

$[\alpha]_D^{25}$  : + 11.05 (*c* 0.92, CHCl<sub>3</sub>)

**IR(CHCl<sub>3</sub>, cm<sup>-1</sup>) :**  $\nu_{\max}$  3368, 1734, 1634, 1533, 1414

**<sup>1</sup>H NMR (CDCl<sub>3</sub>, 200 MHz):**  $\delta$  -0.17 (s, 3H), -0.08 (s, 3H), 0.75 (s, 9H), 1.43 (s, 9H), 3.78 (s, 3H), 4.44 (d, *J* = 10 Hz, 1H), 5.21 (d, *J* = 9.2 Hz, 1H), 5.53 (d, *J* = 8.7 Hz, 1H), 7.24-7.34 (m, 5H)

$^{13}\text{C}$  NMR ( $\text{CDCl}_3$ , 50 MHz):  $\delta$  -6.1, -5.7, 0.9, 18.0, 25.3, 28.1, 52.0, 57.0, 75.7, 126.4, 127.2, 128.1, 139.5, 155.0, 171.6

**Analysis:**  $\text{C}_{21}\text{H}_{35}\text{NO}_5\text{Si}$  (409.59) requires. C, 61.58 ; H, 8.61 ; N, 3.41 ; Found. C, 61.43 ; H, 8.57 ; N, 3.39.

Preparation of (2*R*,3*S*)-2-[(*tert*-butyl-dimethyl-silyloxy)-3-hydroxy-1-phenyl-propyl]-carbamic acid *tert*-butyl ester

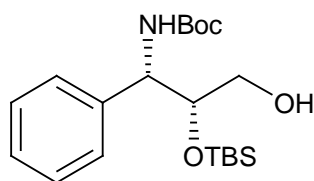

**84**

To a solution of **83** (0.225 g, 0.57 mmol) in dry dichloromethane (5 mL) was added 1 M solution of DIBAL-H (1.42 mL, 1.42 mmol) dropwise at 0 °C and reaction mixture stirred for 3 h. The solution was cooled to 0 °C and quenched with saturated sodium potassium tartrate (2 mL), filtered through celite pad and concentrated to near dryness. The crude product was purified by silica gel column chromatography using EtOAc:pet.ether (7:3) as eluent to give **84** (0.195 g) as a colorless oil.

**Yield : 93%**

$[\alpha]_D^{25}$  : + 34.29 (*c* 1,  $\text{CHCl}_3$ )

**IR** ( $\text{CHCl}_3$ ,  $\text{cm}^{-1}$ ) :  $\nu_{\text{max}}$  3520, 3312, 1562, 1423, 1399

$^1\text{H}$  NMR ( $\text{CDCl}_3$ , 200 MHz):  $\delta$  -0.17, (s, 3H), -0.08 (s, 3H), 0.75 (s, 9H), 1.43 (s, 9H), 1.62, (brs, 1H, OH), 3.78 (d,  $J = 8.7$  Hz, 2H), 4.38-4.41 (m, 1H), 4.71 (d,  $J = 9.2$  Hz, 1H), 5.53 (d,  $J = 8.7$  Hz, 1H), 7.24-7.34 (m, 5H)

$^{13}\text{C}$  NMR ( $\text{CDCl}_3$ , 50 MHz) :  $\delta$  -5.7, -5.4, 17.8, 25.5, 28.2, 29.6, 60.1, 64.6, 70.4, 126.5, 126.7, 127.5, 128.4, 137.2, 153.6

**Analysis:**  $\text{C}_{20}\text{H}_{35}\text{NO}_4\text{Si}$  (381.58) requires. C, 62.95 ; H, 9.24 ; N, 3.67 ; Found. C, 62.92 ; H, 9.21 ; N, 3.62.

Preparation of (4*S*,5*S*)-5-*tert*-Butoxycarbonylamino-4-[(*tert*-butyl-dimethyl-silyloxy)-5-phenyl-pent-2-enoic acid ethyl ester

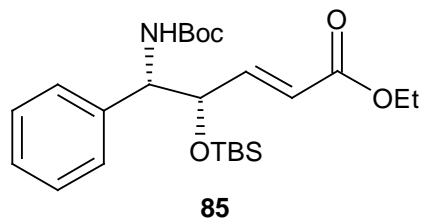

To a mixture of PCC (0.144 g, 0.67 mmol), celite powder (200 mg) and anhydrous  $\text{CH}_3\text{COONa}$  (0.54 g, 0.67 mmol) in dry  $\text{CH}_2\text{Cl}_2$  (5 mL) was added alcohol 84 (0.17 g, 0.45 mmol) at 0 °C. The reaction mixture was stirred for 5 h at rt. Solvent was evaporated and to the residue was added ether. The slurry was stirred and filtered through a pad of celite. The residue was washed 4 to 5 times with ether. The filtrate was concentrated to give the aldehyde which was used in the next reaction without any further purification.

To a solution of (ethoxycarbonylmethylene)triphenylphosphorane (0.15 g, 0.43 mmol) in dry THF (5 mL) was added the solution of above crude aldehyde (0.12 g, 0.32 mmol) in THF (3 mL) at 0 °C. The ice-bath was removed and the reaction mixture was stirred at rt for 24 h and concentrated. Silica gel column chromatography of the crude product using EtOAc:pet.ether (0.5:9.5) as eluent gave 85 (0.13 g) as a colorless liquid.

**Yield :** 91%

$[\alpha]_D^{25}$  : + 10.6 (c 0.74,  $\text{CHCl}_3$ )

**IR** ( $\text{CHCl}_3$ ,  $\text{cm}^{-1}$ ) :  $\nu_{\text{max}}$  3342, 1719, 1621, 1522, 1463, 1322

**$^1\text{H}$  NMR** ( $\text{CDCl}_3$ , 200 MHz):  $\delta$  -0.23 (s, 3H), 0.04 (s, 3H), 0.77 (s, 9H), 0.86 (t,  $J = 6.2$  Hz, 3H), 1.22 (s, 9H), 4.16 (q,  $J = 14.2$  Hz, 2H), 4.46-4.53 (m, 1H), 4.84 (d,  $J = 7.4$  Hz, 1H), 5.28 (d,  $J = 13.3$ , 1H), 5.99 (d,  $J = 15.1$  Hz, 1H), 6.99 (dd,  $J = 15.6, 4.9$  Hz, 1H), 7.20-7.35 (m, 5H)

**$^{13}\text{C}$  NMR** ( $\text{CDCl}_3$ , 50 MHz):  $\delta$  -6.0, -5.0, 0.9, 14.1, 18.0, 25.7, 28.2, 29.6, 60.4, 122.1, 126.4, 127.3, 128.2, 147.6, 155.4, 166.1

**Analysis:** C<sub>24</sub>H<sub>39</sub>NO<sub>5</sub>Si (449.66) requires. C, 64.10 ; H, 8.74 ; N, 3.11 ; Found. C, 63.98 ; H, 8.71 ; N, 3.08.

Preparation of (4*S*,5*S*)-5-(*tert*-Butoxycarbonylamino)-4-hydroxy-5-phenyl-pentanoic acid ethyl ester

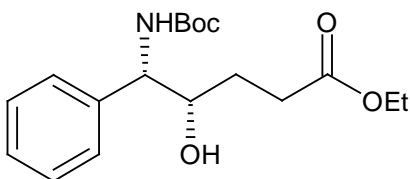

**86**

To a solution of **85** (0.2 g) in methanol (10 mL) was added 20 mg of 10% Pd/C and mixture stirred under hydrogen atmosphere for 6 h. After completion of reaction, the solution was filtered and the filtrate was concentrated. The crude product was purified on silica gel column using EtOAc:pet.ether (1:9) as eluent to give **86** (0.14 g) as a viscous liquid.

**Yield :** 93%

$[\alpha]_D^{25}$  : + 10.8 (*c* 0.68, CHCl<sub>3</sub>)

**IR (CHCl<sub>3</sub>, cm<sup>-1</sup>) :**  $\nu_{\max}$  1722, 1533, 1462, 1366, 1252

**<sup>1</sup>H NMR (CDCl<sub>3</sub>, 200 MHz) :**  $\delta$  0.93 (t, *J* = 9.2 Hz, 3H), 1.45 (s, 9H), 1.84-1.94 (m, 2H), 2.02 (brs, 1H), 2.41-2.50 (m, 2H), 3.87-3.90 (m, 1H), 4.12 (q, *J* = 8 Hz, 2H), 4.74-4.81 (m, 1H), 5.44 (d, *J* = 4 Hz, 1H), 7.19-7.40 (m, 5H)

**<sup>13</sup>C NMR(CDCl<sub>3</sub>, 50 MHz):** 14.0, 25.3, 26.3, 29.2, 64.8, 66.7, 67.8, 71.7, 126.8, 127.8, 127.9, 128.3, 157.2, 170.0

**Analysis:** C<sub>18</sub>H<sub>27</sub>NO<sub>5</sub> (337.41) requires. C, 64.07 ; H, 8.07 ; N, 4.15 ; Found. C, 64.03 ; H, 8.06 ; N, 4.13.

Preparation of (4*S*,5*S*)-(2, 5-dihydroxy-1-phenyl-pentyl)-carbamic acid *tert*-butyl ester

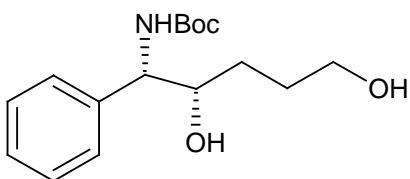

**78**

To a stirred solution of **86** (0.19 g, 0.56 mmol) was added DIBAL-H (2.3 M solution in toluene, 0.8 mL, 2.5 mmol) at 0 °C. The reaction mixture was stirred for another 3 h at room temperature and then quenched

with saturated sodium potassium tartrate, filtered through celite powder and concentrated to near dryness. The crude product was purified by silica gel column chromatography using EtOAc:pet ether (3:7) as eluent to give **78** (0.15 g) as a colorless liquid.

**Yield :** 90%

$[\alpha]_D^{25} : + 15.13$  (*c* 0.32, CHCl<sub>3</sub>)

**IR (CHCl<sub>3</sub>, cm<sup>-1</sup>) :**  $\nu_{\max}$  3541, 3326, 1523, 1463, 1262

**<sup>1</sup>H NMR (CDCl<sub>3</sub>, 200 MHz) :**  $\delta$  1.44-1.48 (m, 4H), 1.46 (s, 9H), 2.12 (brs, 2H), 3.52-3.57 (m, 2H), 4.52-4.63 (m, 1H), 4.73 (d, *J* = 12 Hz, 1H), 5.54 (d, *J* = 12.5 Hz, 1H), 7.19-7.42 (m, 5H)

**<sup>13</sup>C NMR (CDCl<sub>3</sub>, 50 MHz) :** 26.7, 27.0, 29.3, 29.6, 63.3, 70.6, 77.6, 124.2, 126.4, 127.1, 129.3, 156.5

**Analysis :** C<sub>16</sub>H<sub>25</sub>NO<sub>4</sub> (295.37) requires. C, 65.06 ; H, 8.53 ; N, 4.74 ; Found. C, 65.03 ; H, 8.50 ; N, 4.72.

Preparation of (2*S*,3*S*)-3-Hydroxy-2-phenyl-piperidine-1-carboxylicacid-*tert*-butylester

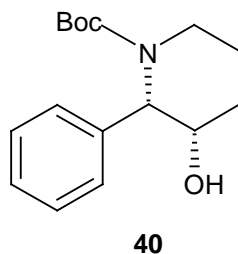

To a stirred solution of **78** (0.1 g, 0.34 mmol) in dry dichloromethane (5 mL) was added methanesulfonyl chloride (0.028 mL, 0.37 mmol) at -78 °C followed by triethyl amine (0.051 mL, 0.37 mmol). After the mixture was stirred at -78 °C for 1 h, aqueous ammonium chloride (3 mL) was added. The mixture was warmed to room temperature and diluted with dichloromethane (10 mL), washed with brine and dried over Na<sub>2</sub>SO<sub>4</sub>. The solvent was removed and residue was purified by flash chromatography using EtOAc:pet ether (8:2) as eluent to give **40** (72 mg) as a yellow liquid.

**Yield :** 77%

$[\alpha]_D^{25} : + 36.2$  (*c* 0.66, CHCl<sub>3</sub>) {Lit.<sup>38a</sup>  $[\alpha]_D^{25} : + 38.30$  (*c* 1.92, CHCl<sub>3</sub>) }

**IR (CHCl<sub>3</sub>, cm<sup>-1</sup>) :**  $\nu_{\max}$  3445, 2933, 1702, 1410, 1352, 1230, 1160

**<sup>1</sup>H NMR (CDCl<sub>3</sub>, 200 MHz) :**  $\delta$  1.40 (s, 9H), 1.52-1.67 (m, 4H), 2.81 (ddd, *J* = 6.2, 10.5, 12.6 Hz, 1H), 3.88-4.05 (m, 1H), 4.12-4.24 (m, 1H), 4.48 (d, *J* = 7.4 Hz, 1H), 5.31 (d, *J* = 5.6 Hz, 1H), 7.17-7.36 (m, 5H)

**<sup>13</sup>C NMR (CDCl<sub>3</sub>, 50 MHz) :**  $\delta$  24.1, 27.3, 28.2, 39.0, 62.1, 69.4, 80.0, 127.1, 128.2, 128.3, 138.0, 156.0

**Analysis:** C<sub>16</sub>H<sub>23</sub>NO<sub>3</sub> (277.36) requires. C, 69.28 ; H, 8.35 ; N, 5.05 ; Found. C, 68.25 ; H, 8.32 ; N, 4.98.

Preparation of (2*S*,3*S*)-1-(*tert*-Butyloxycarbonyl)-2-phenyl-3-[(3,5-bis(trifluoromethyl)benzyloxy] piperidine

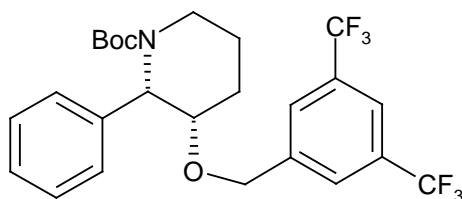

87

To a stirred solution of sodium hydride (10 mg, 60% dispersion in mineral oil, 0.43 mmol) and dry DMF (1 mL) at 0 °C, was added a solution of 40 (0.1 g , 0.36 mmol) and 3,5-bis(trifluoromethyl)benzyl bromide (110 mg, 0.36 mmol) in dry DMF (1 mL). The reaction mixture was stirred for 12 h at 80 °C. The reaction was quenched with water (3 mL) and extracted with Et<sub>2</sub>O (5 mL). The combined organic layers were washed with brine (3mL), dried over anhydrous Na<sub>2</sub>SO<sub>4</sub>, filtered and concentrated. The residue was purified by flash chromatography on silica gel column using EtOAc:pet.ether (3:7) to provide 87 (0.14 g) as a colorless oil.

**Yield :** 78%

$[\alpha]_D^{25}$  : + 31.45 (*c* 1.0, CHCl<sub>3</sub>)

**IR** (neat, cm<sup>-1</sup>) :  $\nu_{\max}$  2945, 1644, 1381, 1345, 1253, 1172, 875, 665

**<sup>1</sup>H NMR** (CDCl<sub>3</sub>, 200 MHz) :  $\delta$  1.42 (s, 9H), 1.32-1.66 (m, 2H), 1.78-2.12 (m, 2H), 2.76 (ddd, *J* = 11.2, 9.8, 4.6 Hz, 1H), 3.79-3.98 (m, 2H), 4.66 (d, *J* = 11.4 Hz, 1H), 4.74 (d, *J* = 12.2 Hz, 1H), 5.67 (d, *J* = 4.6 Hz, 1H), 7.22-7.38 (m, 3H), 7.42-7.52 (m, 2H), 7.66 (s, 2H), 7.78 (s, 1H)

**<sup>13</sup>C NMR** (CDCl<sub>3</sub>, 50 MHz) : 20.2, 25.3, 26.3, 27.2, 44.4, 63.2, 71.2, 77.0, 120.2, 123.1, 126.7, 127.3, 127.8, 132.4, 141.2, 142.4, 159.0

**Analysis:** C<sub>25</sub>H<sub>27</sub>F<sub>6</sub>NO<sub>3</sub> (503.48) requires. C, 59.64 ; H, 5.41 ; N, 2.78 ; Found. C, 59.61 ; H, 5.38 ; N, 2.76.

Preparation of (2*S*,3*S*)-2-Phenyl-3-[(3,5)-bis(trifluoromethyl)benzyloxy]piperidine

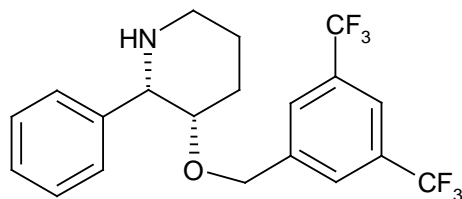

**41**

To an ice-bath solution of **87** (25 mg, 0.05 mmol) in dry  $\text{CH}_2\text{Cl}_2$  (1 mL) was added trifluoroacetic acid (73  $\mu\text{ mL}$ , 0.05 mmol). The reaction mixture was stirred at room temperature for 12 h and then quenched with saturated  $\text{NaHCO}_3$  and extracted with dichloromethane (3x5 mL). The combined organic layers were washed with brine and dried over  $\text{Na}_2\text{SO}_4$ , filtered and concentrated under reduced pressure. The crude product was purified by silica gel column chromatography using  $\text{CH}_3\text{OH}:\text{CHCl}_3$  (1:9) as eluent to give **41** (14 mg),  $[\alpha]_{\text{D}}^{25} : + 36.2$  (*c* 0.66,  $\text{CHCl}_3$ ) {Lit.<sup>38a</sup>  $[\alpha]_{\text{D}}^{25} : + 34.3$  (*c* 1.32,  $\text{CHCl}_3$ )}.

The physical and spectroscopic data of **41** were in full agreement with those reported.<sup>38a</sup>

**Yield :** 70%

$[\alpha]_{\text{D}}^{25} : + 36.2$  (*c* 0.66,  $\text{CHCl}_3$ ) {Lit.<sup>38a</sup>  $[\alpha]_{\text{D}}^{25} : + 34.3$  (*c* 1.32,  $\text{CHCl}_3$ )}.

**$^1\text{H}$  NMR ( $\text{CDCl}_3$ , 200 MHz) :**  $\delta$  1.42-2.04 (m, 3H), 2.22 (br d,  $J = 13$  Hz, 1H), 2.62 (s, 1H), 2.76-2.81 (m, 1H), 3.23-3.38 (m, 1H), 3.66 (s, 1H), 3.84 (brs, 1H), 4.12 (d,  $J = 12$  Hz, 1H), 4.54 (d,  $J = 12.2$  Hz, 1H), 7.20-7.50 (m, 7H), 7.78 (s, 1H)

**$^{13}\text{C}$  NMR ( $\text{CDCl}_3$ , 50 MHz) :** 20.2, 28.2, 46.8, 64.0, 69.9, 77.4, 121.2, 123.1, 126.7, 127.3, 127.8, 132.4, 142.2, 142.4.

## 4.2.7 Spectra

- $^1\text{H}$  &  $^{13}\text{C}$  NMR spectra of **79****
- $^1\text{H}$  &  $^{13}\text{C}$  NMR spectra of **82****
- $^1\text{H}$  &  $^{13}\text{C}$  NMR spectra of **83****



4.  $^1\text{H}$  &  $^{13}\text{C}$  NMR spectra of 84
5.  $^1\text{H}$  &  $^{13}\text{C}$  NMR spectra of 85
6.  $^1\text{H}$  &  $^{13}\text{C}$  NMR spectra of 86
7.  $^1\text{H}$  &  $^{13}\text{C}$  NMR spectra of 40
8.  $^1\text{H}$  &  $^{13}\text{C}$  NMR spectra of 41

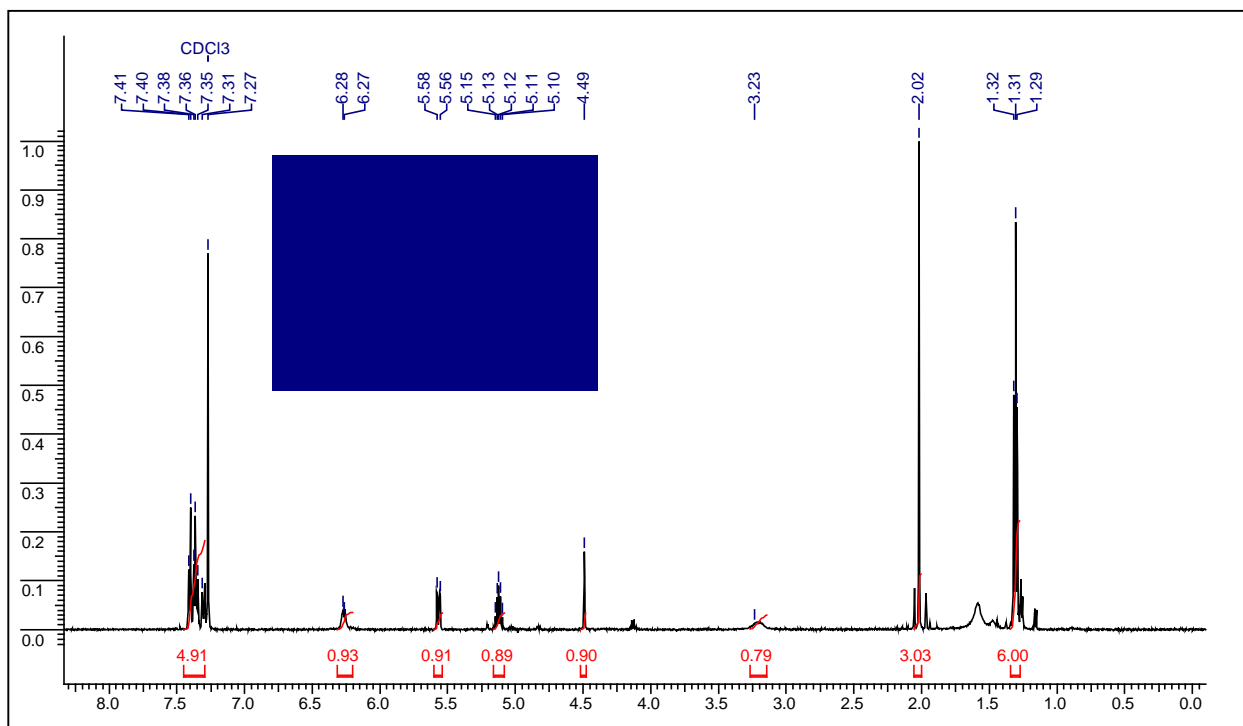

$^1\text{H}$  NMR spectrum of compound 79 in  $\text{CDCl}_3$

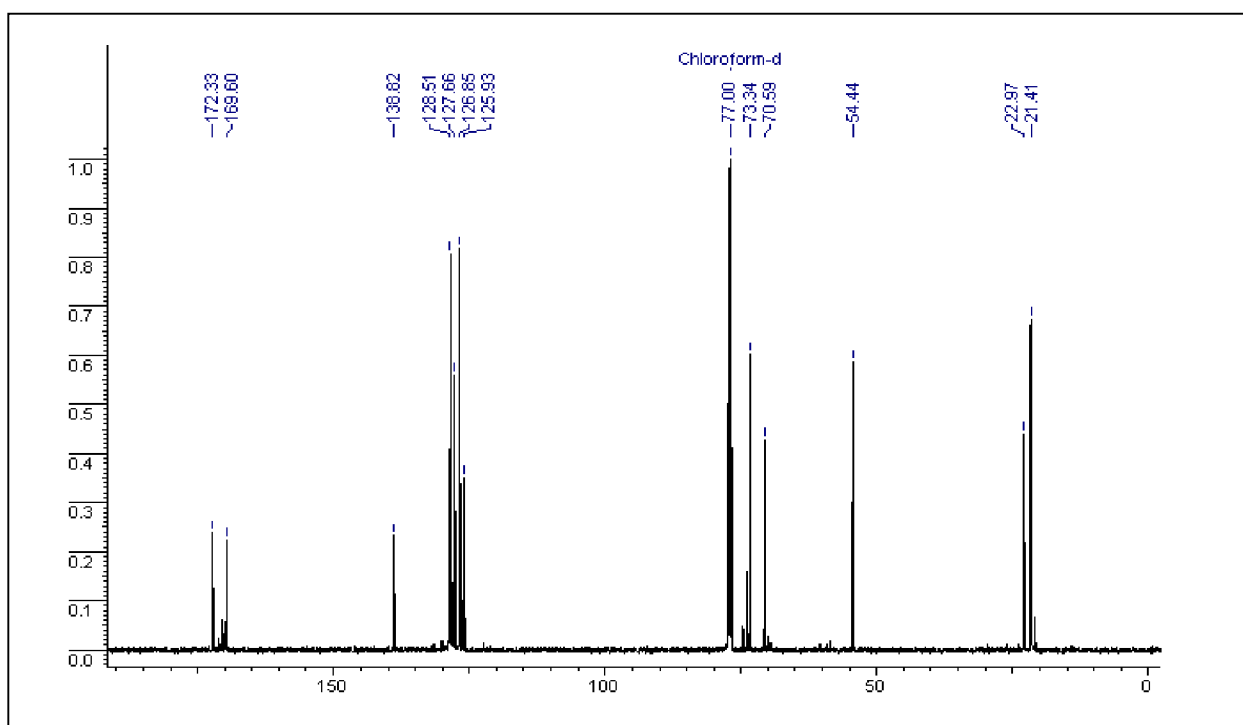

$^{13}\text{C}$  NMR spectrum of compound 79 in  $\text{CDCl}_3$

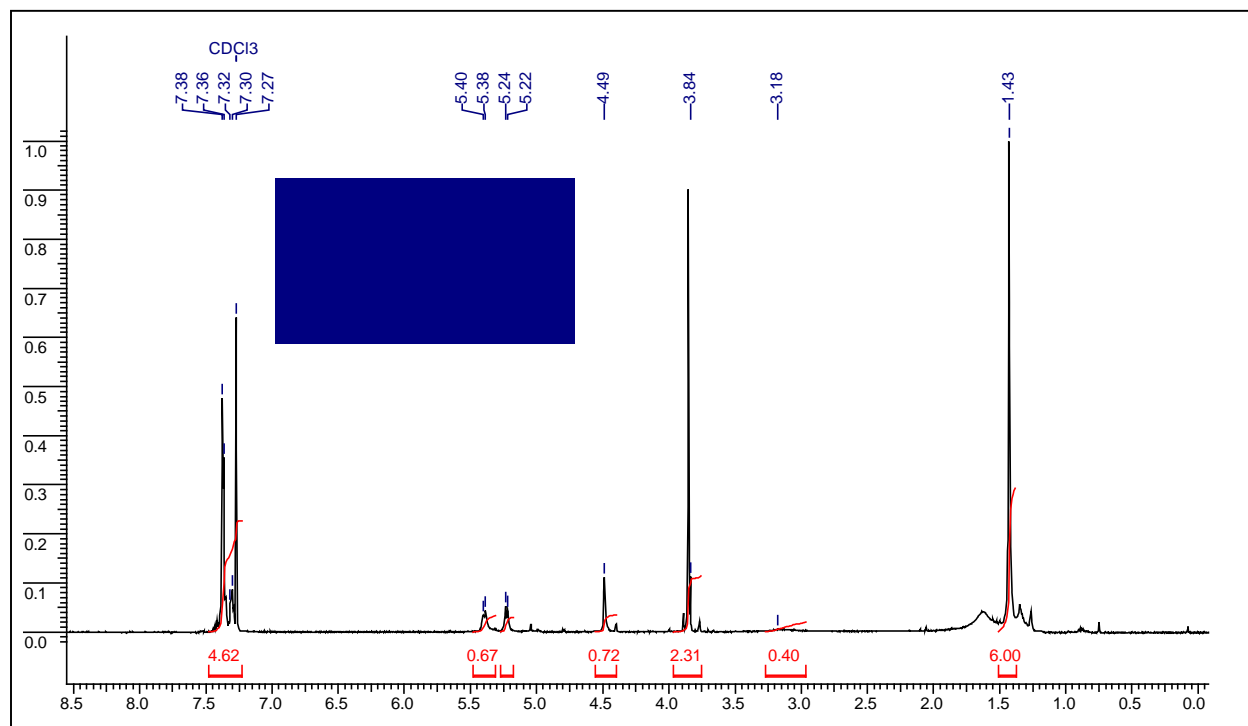

$^1\text{H}$  NMR spectrum of compound 82 in  $\text{CDCl}_3$

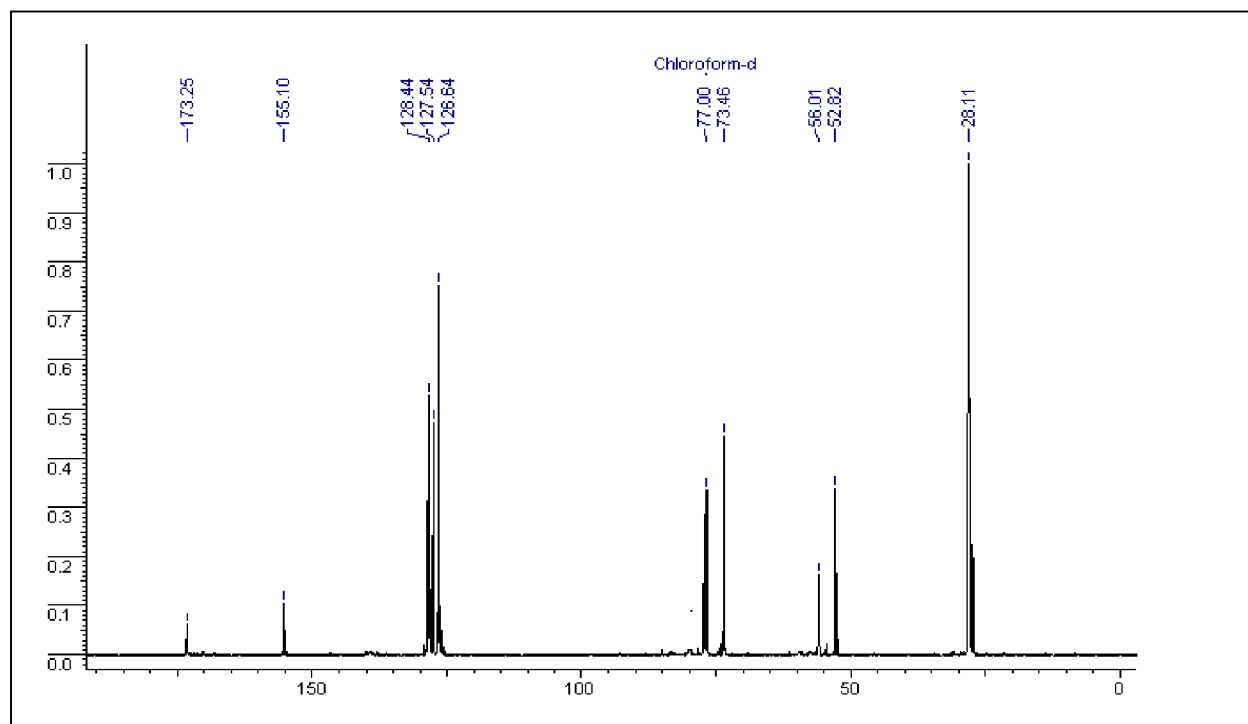

$^{13}\text{C}$  NMR spectrum of compound 82 in  $\text{CDCl}_3$

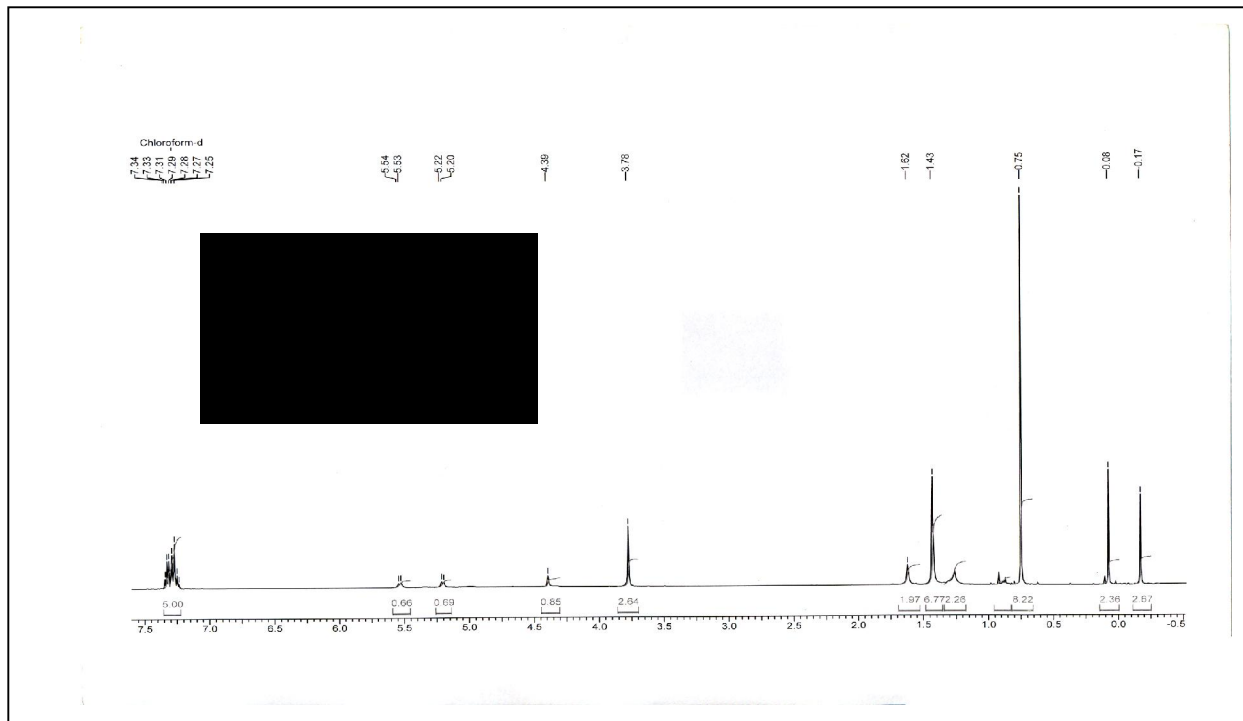

$^1\text{H}$  NMR spectrum of compound 83 in  $\text{CDCl}_3$

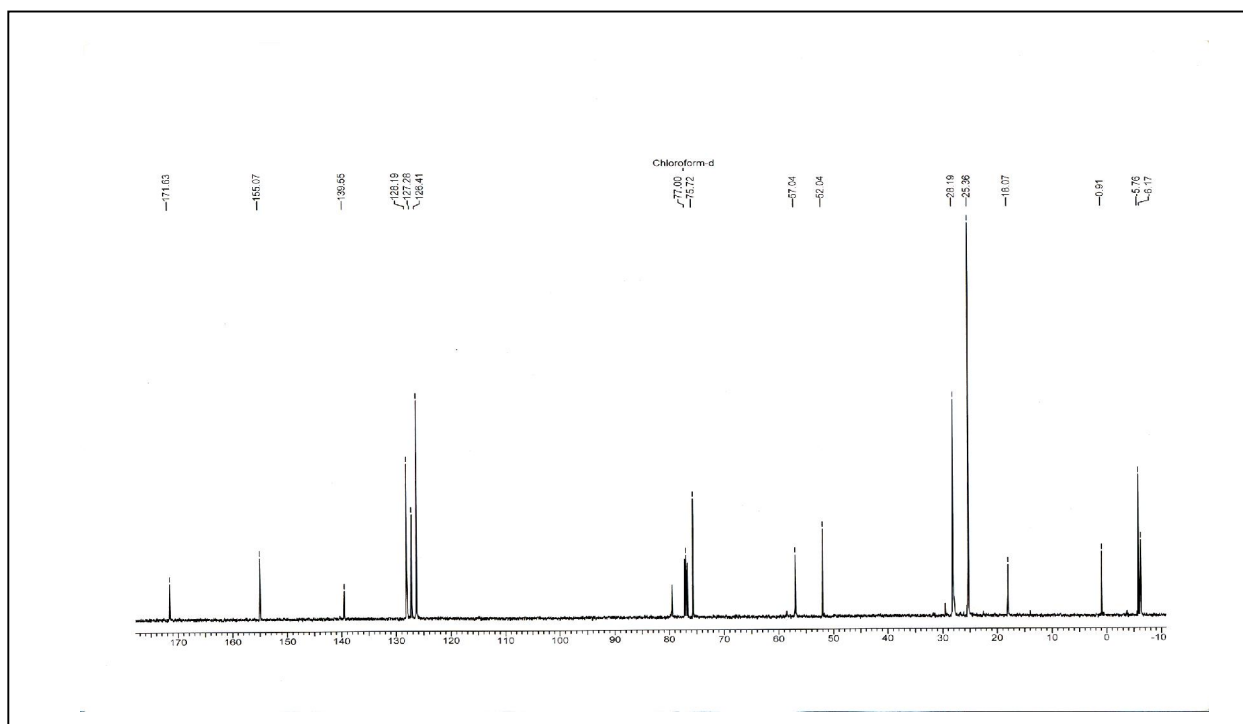

$^{13}\text{C}$  NMR spectrum of compound 83 in  $\text{CDCl}_3$

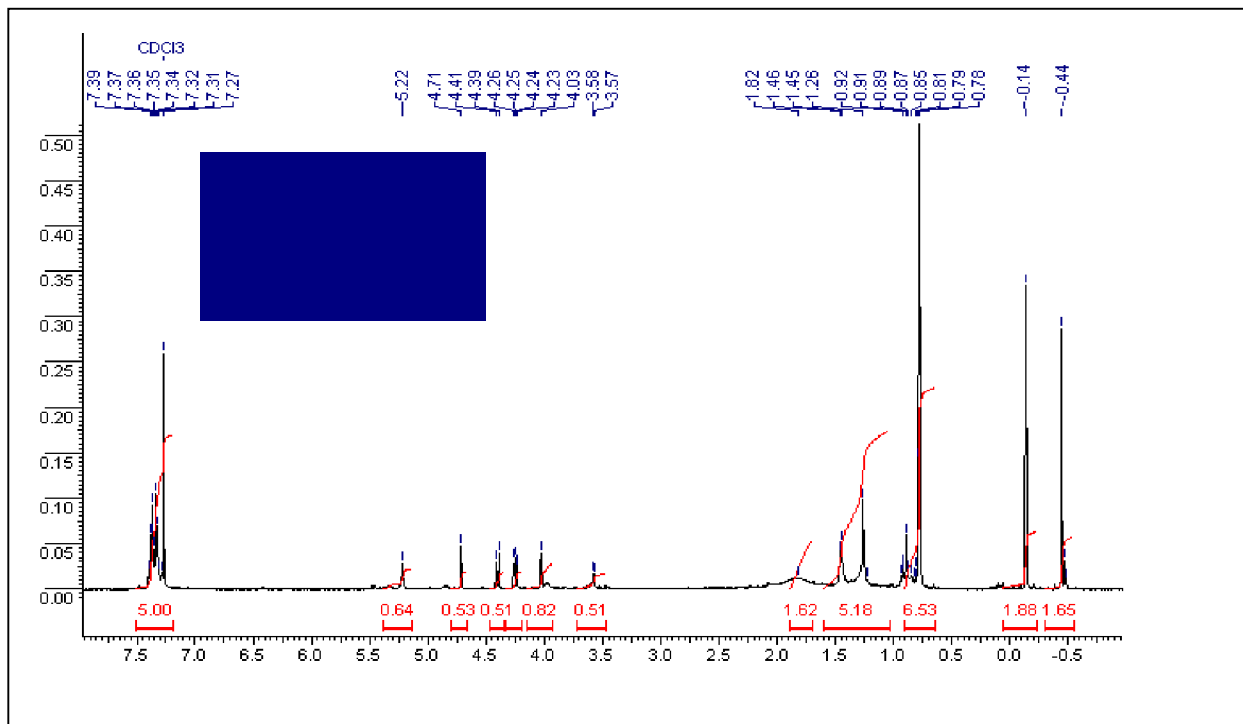

$^1\text{H}$  NMR spectrum of compound 84 in  $\text{CDCl}_3$

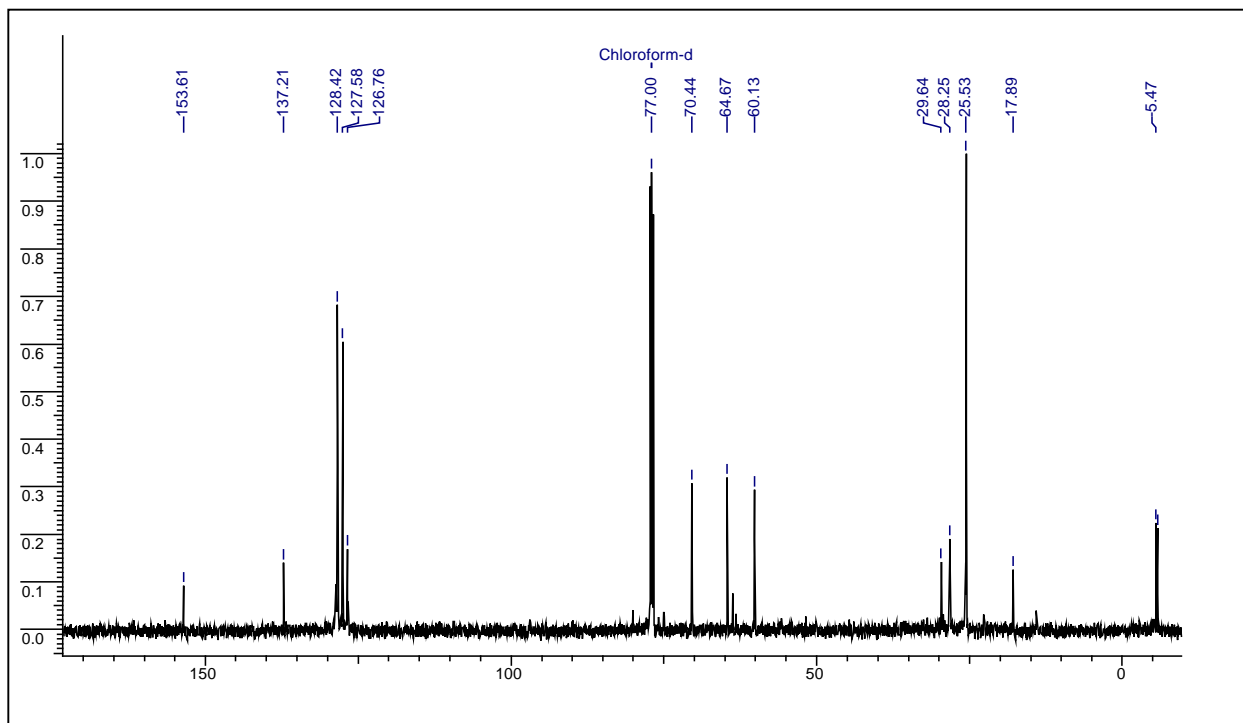

$^{13}\text{C}$  NMR spectrum of compound 84 in  $\text{CDCl}_3$

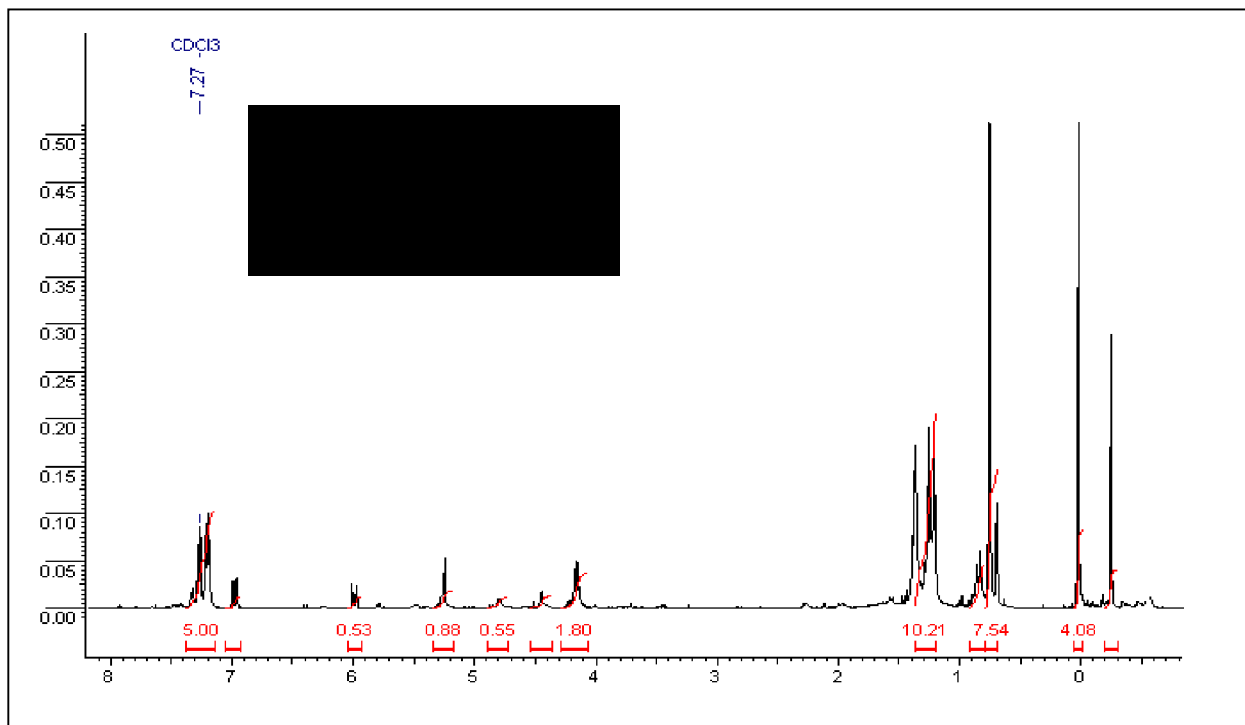

<sup>1</sup>H NMR spectrum of compound 85 in CDCl<sub>3</sub>

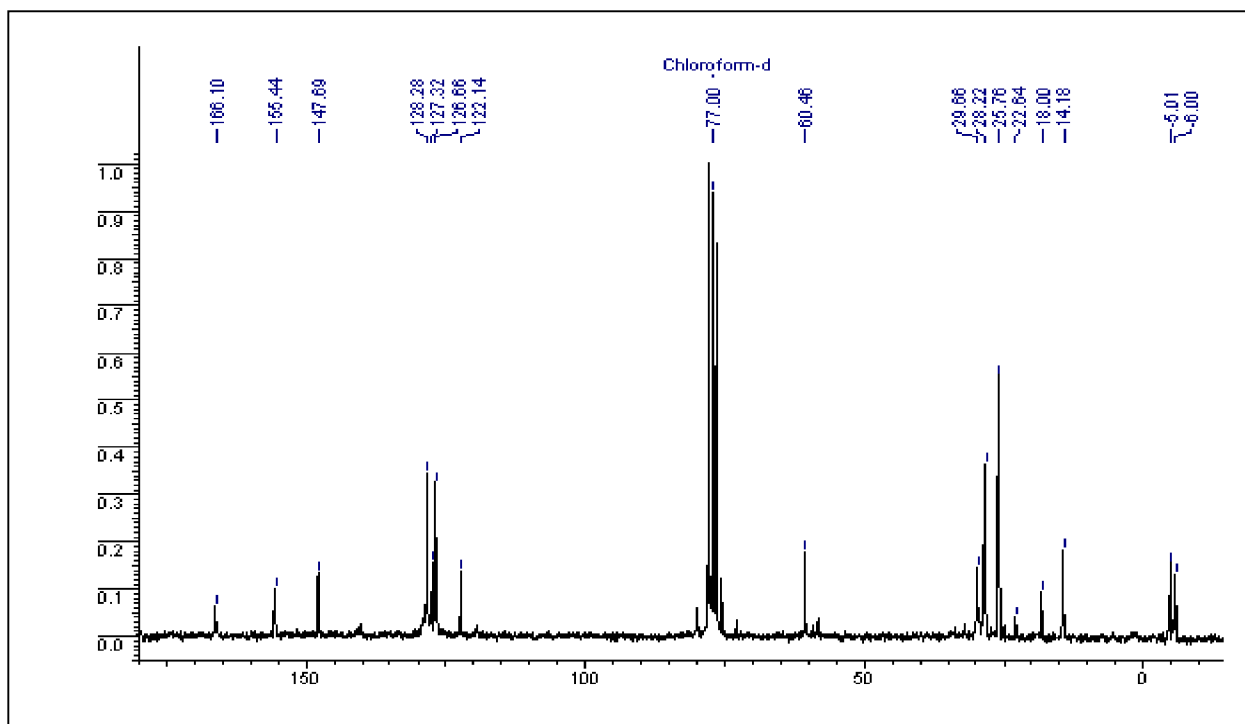

<sup>13</sup>C NMR spectrum of compound 85 in CDCl<sub>3</sub>

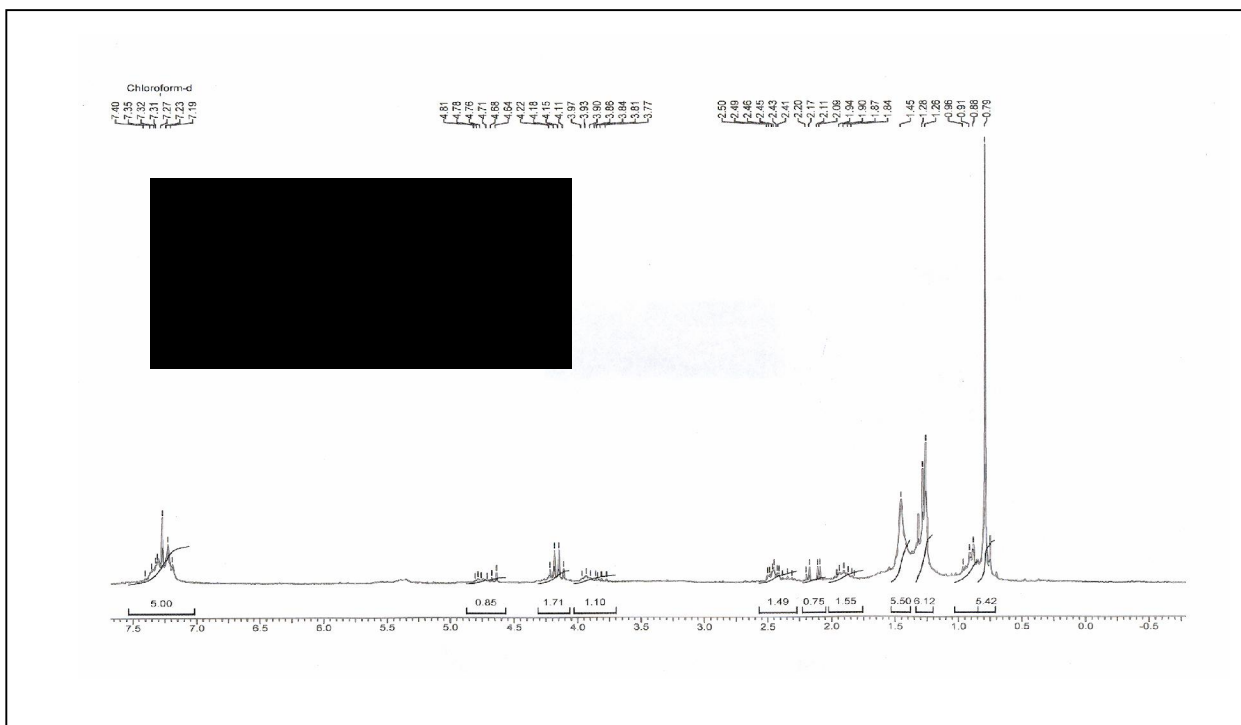

**$^1\text{H}$  NMR spectrum of compound 86 in  $\text{CDCl}_3$**

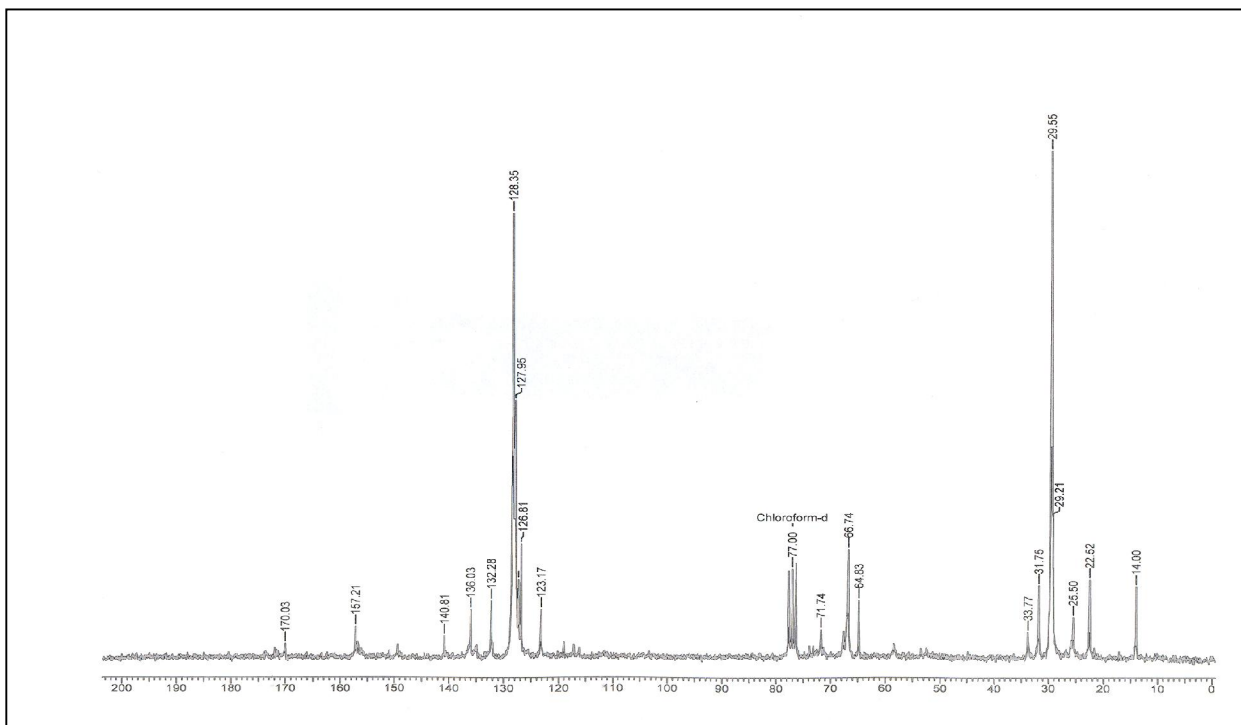

**$^{13}\text{C}$  NMR spectrum of compound 86 in  $\text{CDCl}_3$**

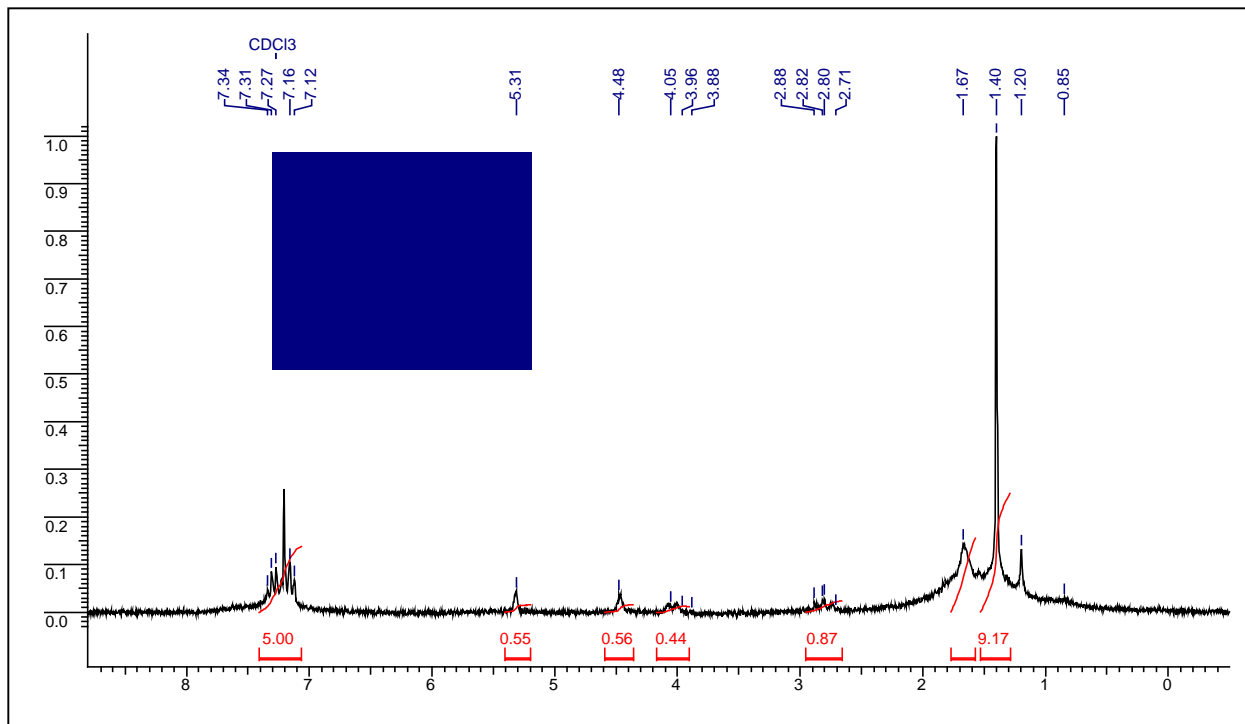

<sup>1</sup>H NMR spectrum of compound 40 in CDCl<sub>3</sub>

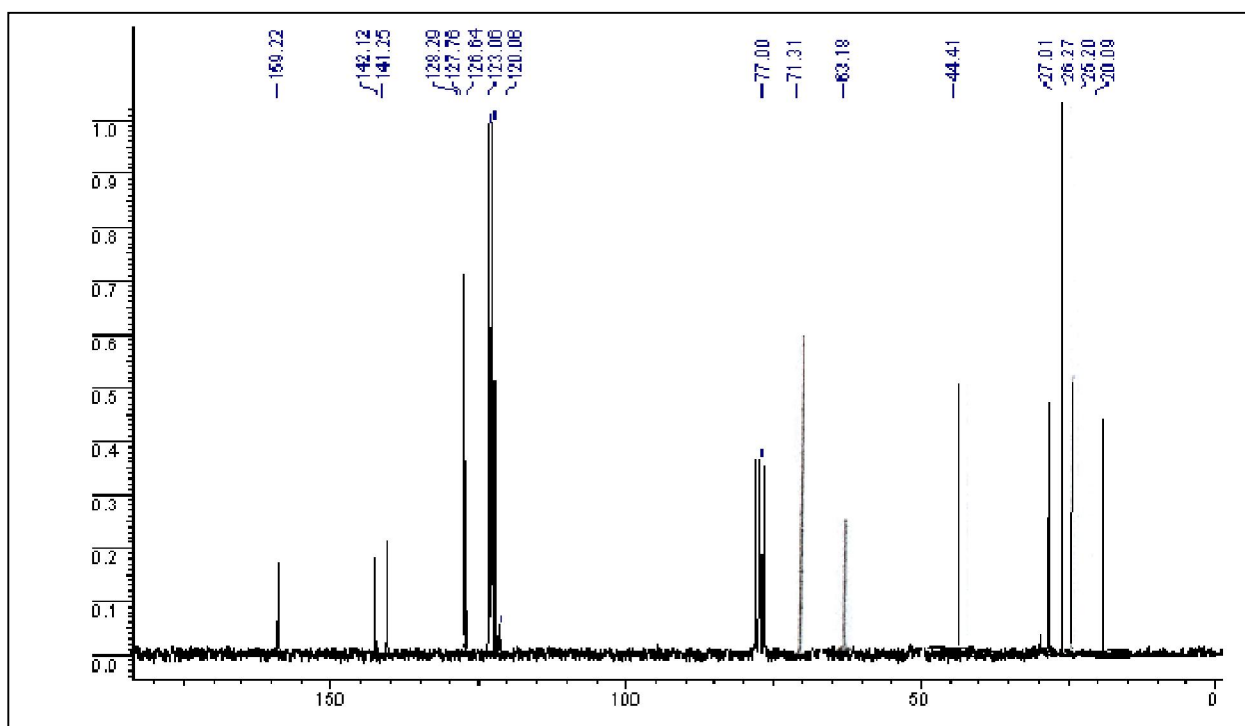

<sup>13</sup>C NMR spectrum of compound 40 in CDCl<sub>3</sub>

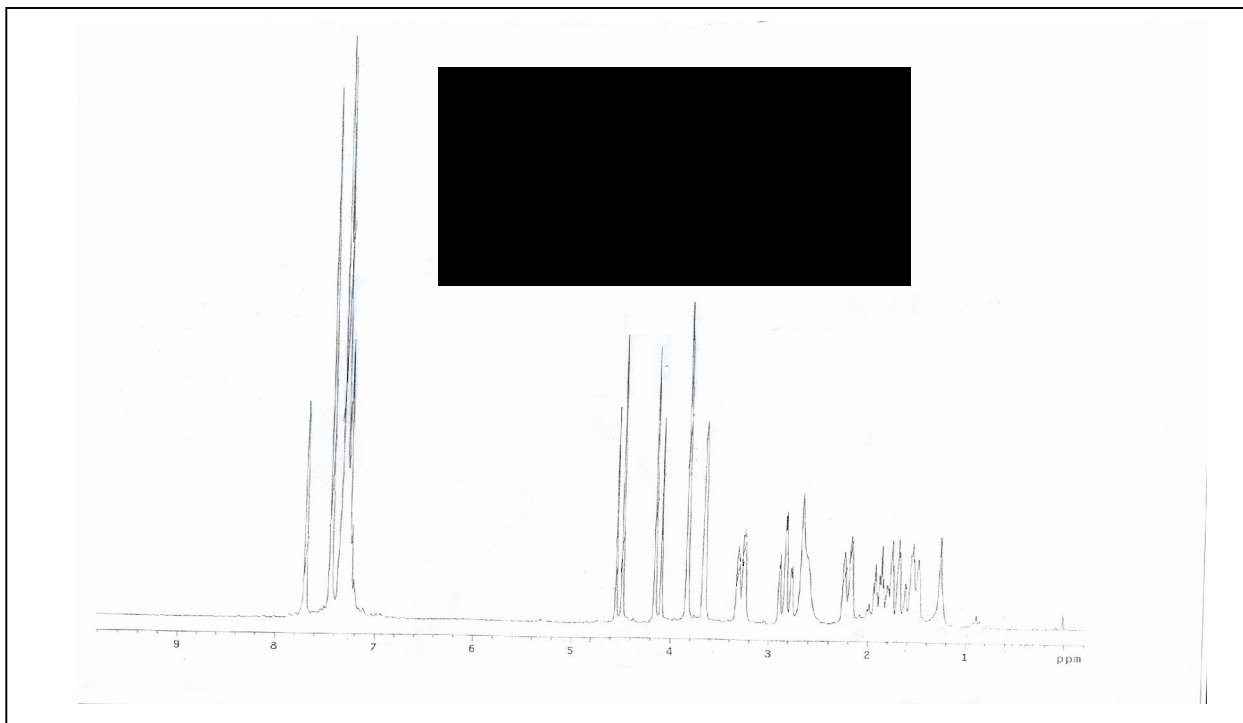

**$^1\text{H}$  NMR spectrum of compound 41 in  $\text{CDCl}_3$**

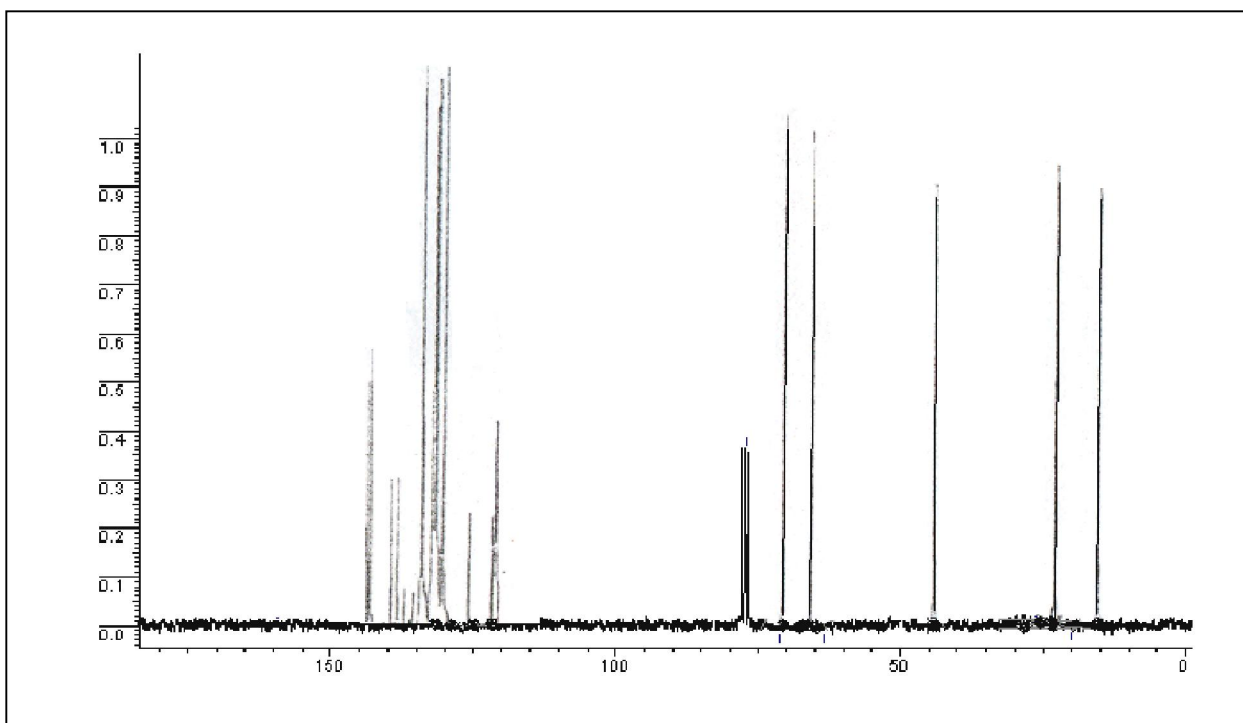

**$^{13}\text{C}$  NMR spectrum of compound 41 in  $\text{CDCl}_3$**



## 4.3 SECTION B: ENANTIOSELECTIVE SYNTHESIS OF L-THREO-SPHINGANINE

---

### 4.3.1 Introduction

**Sphingosine 88 and its biosynthetic precursor, dihydrosphingosine 89, 90 and 4-hydroxy sphinganine (phytosphingosine) 91 (Fig. 7) are the most abundant long chain amino alcohols possessing generally 18 or 20 carbon atoms.<sup>43</sup> Sphingosine 89 and 90 are intermediates in the biosynthesis of sphingolipids such as ceramides, sphingomyeline, cerebroside and gangliosides which play important role in cell regulation and signal transduction,<sup>44</sup> with sphinganine itself found to be an inhibitor of protein kinase C.<sup>45</sup>**

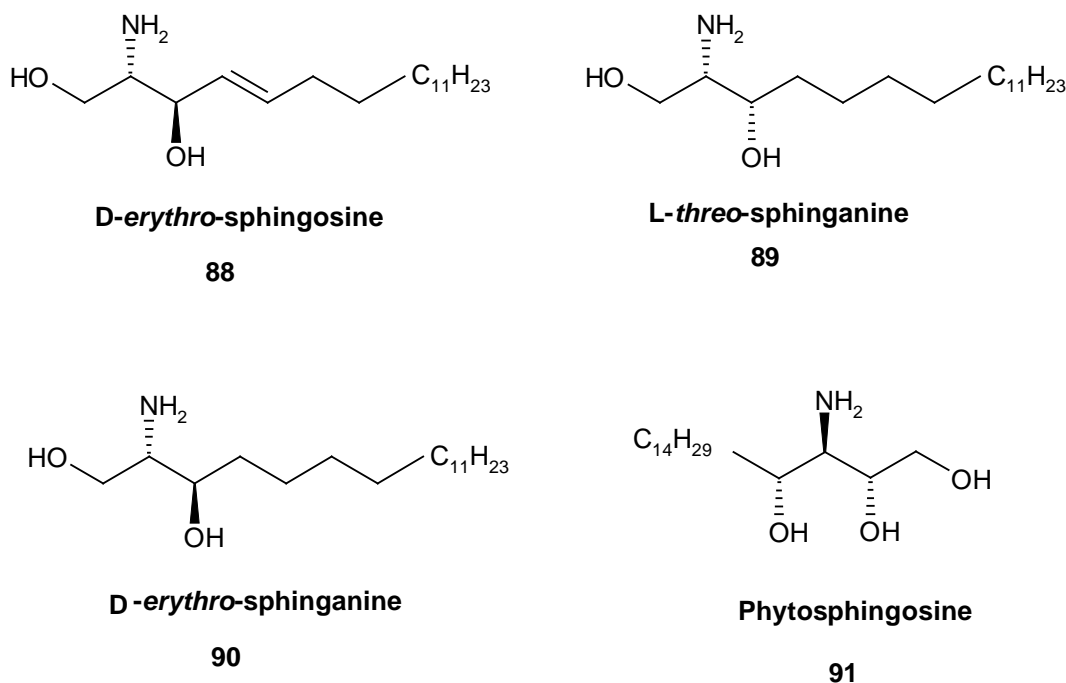

Fig. 7

**Glycosphingolipids contain two basic structural motifs : carbohydrate and ceramide (figure 8). The ceramide portion consists of a sphingoid base and an amide-linked**

fatty acyl chain, e.g. stearyl or palmitoyl. The structural variation in fatty acids (*N*-acyl portion, sphingosines and carbohydrates) results in a great variety of chemically distinct glycosphingolipids.<sup>43</sup>

Glycosphingolipids are found in the cell membrane of all animal and many plant cells, where they serve as identifying markers and regulate cellular recognition, growth and development.<sup>46</sup> They are thought to function by anchoring the hydrophobic ceramide portion in the plasma membrane exposing the hydrophilic carbohydrate portion to the surrounding exterior which specifies the intended biological function.<sup>47</sup> They are involved in several biological functions such as (i) HIV binding to galactosyl ceramide receptor sites in cells lacking the principal CD4 cellular receptor,<sup>48</sup> (ii) being unambiguous links between specific sphingolipids and malignant tumors which enables them to be used as 'biological markers', for possibly early detection of cancer<sup>46</sup> and (iii) potent and reversible inhibition of protein kinase C by breakdown products of glycosphingolipids e.g. sphingosine, sphinganine and lysosphingolipids.

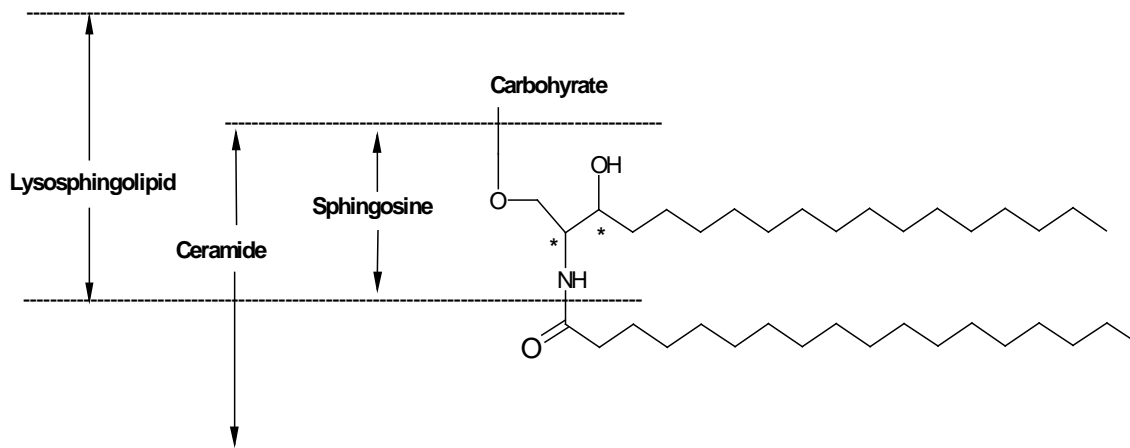

Fig 8. Glycosphingolipid structure

#### 4.3.2 Review of Literature

Glycosphingolipids and sphingomyelins that are biomembrane components serve physiologically important roles in bioorganisms. Physiologically, sphingosines have been reported to function as a positive regulator of cell growth in swiss 3T3 fibroblast and a potent inhibitor of protein kinase C in vitro. Until now, however, sphingosines, dihydrosphingosines, and phytosphingosines have been independently synthesized by many research workers. The asymmetric borane reduction of  $\alpha$ -oxoketoxime<sup>49</sup> has been utilized as key step by Shioiri *et al.* In the other approach Cook *et al.* have employed Pd-catalyzed isomerization of 5-vinylloxazolines for the stereoselective synthesis of *D-erythro* and *L-threo*-sphinganine.<sup>50</sup> Other synthetic methodologies involve the use of chiral pool materials such as L-serine<sup>51</sup> and sugars.<sup>52</sup> Apart from these methods a variety of asymmetric strategies were employed starting from achiral substrates.<sup>53</sup> Some of the interesting methods are described below.

##### Grob *et al.* (1951)<sup>54</sup>

An early synthesis of racemic sphinganine was reported by Grob and co-workers employing nitro-aldol reaction. Condensation of nitro ethanol **92** with palmityl aldehyde **93** gave the aldol product. Reduction of the nitro group in **94** afforded racemic sphinganine **89**.

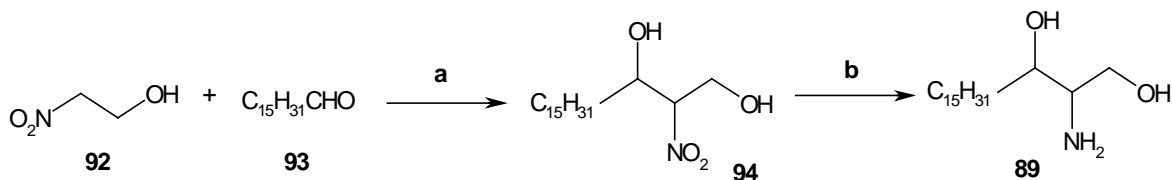

**Scheme 17**

**Scheme 17 : Reaction conditions :** (a) OH<sup>-</sup> ; (b) H<sub>2</sub>/Ni

In another approach, Grob and Gradient carried out nitro aldol reaction on hexadecanal to give 1:1 mixture of *threo*- and *erythro*-products **96** and **97** respectively. Diastereomers were separated by fractional crystallization. Sequential nitro group reduction followed by complete reduction of the triple bond furnished *L-threo*-sphinganine. (**Scheme 18**)

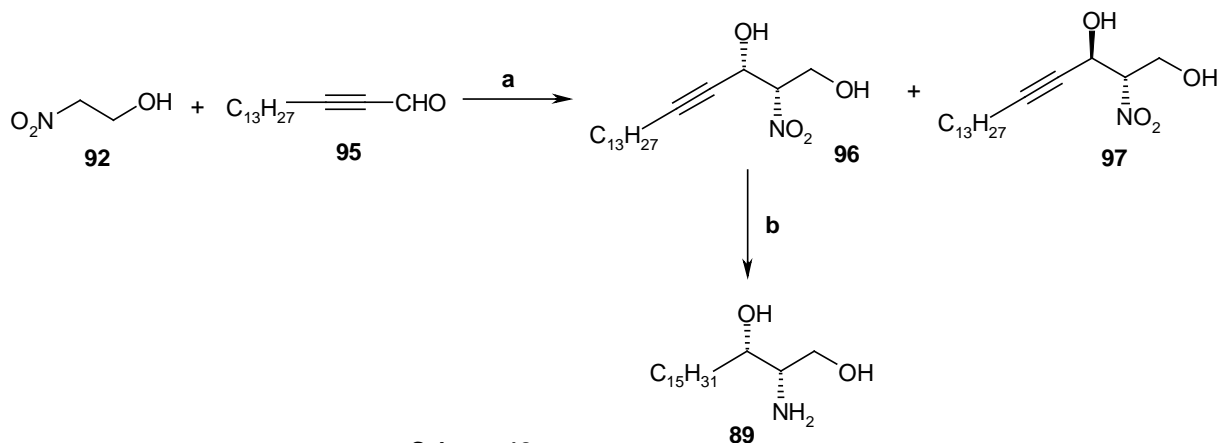

**Scheme 18**

**Scheme 18 : Reaction conditions :** (a) K<sub>2</sub>CO<sub>3</sub>, MeOH ; (b) (i) Zn, HCl ; (ii) H<sub>2</sub>/Pd

Masui *et al.* (1998)<sup>49</sup>

In this method, stereoselective synthesis of sphinganine by the asymmetric borane reduction of  $\alpha$ -oxoketoxime trityl is described. Condensation of palmityl chloride **98** with malonic acid half ester potassium salt gave  $\beta$ -keto ester **99**. Nitrosation of **99** by butyl nitrite followed by *O*-tritylation afforded the ester **100**. The asymmetric borane reduction of **100** using catalyst **101** gave the amino alcohol **89**. (**Scheme 19**)

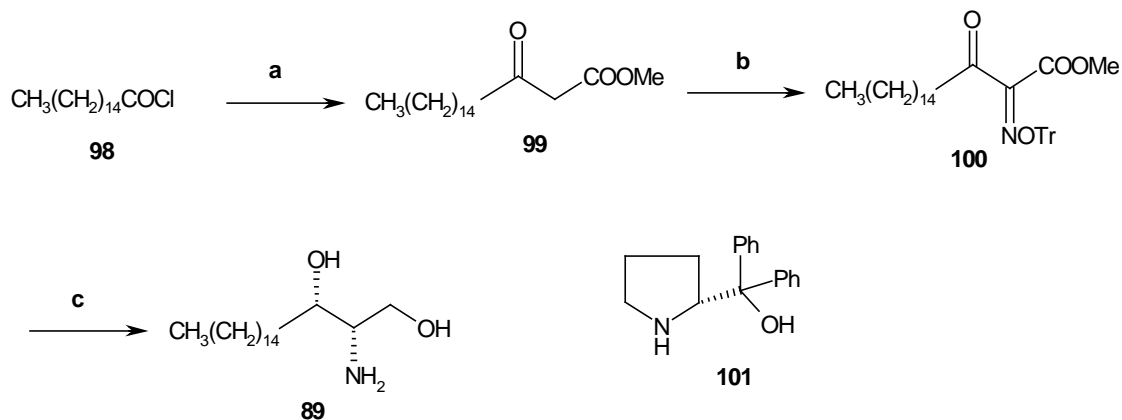

**Scheme 19**

**Scheme 19 : Reaction conditions :** (a) KOCOCH<sub>2</sub>COOMe, MgCl<sub>2</sub>, Et<sub>3</sub>N, CH<sub>3</sub>CN, rt, 18 h, 52% ; (b) (i) BuONO, H<sub>2</sub>SO<sub>4</sub>, Et<sub>2</sub>O, rt, 15 h, 85% ; (ii) TrCl, Et<sub>2</sub>N, CH<sub>2</sub>Cl<sub>2</sub>, rt, 2 h, 99% ; (c) **101**, 89% ee.

Cook *et al.* (2002)<sup>50</sup>

Cook and co-workers reported Pd-catalyzed isomerization of 5-vinyl oxazolines to vicinal amino alcohols. The synthesis of *L-threo*-sphinganine began with the protected *L*-serine derivative **102**. Diisobutyl aluminium hydride reduction of **102** followed by vinyl Grignard afforded the amino alcohol derivative **103** as a mixture of diastereomers. Cyclization of the alcohol **103** onto the Boc group and treatment with a Pd(0) catalyst provided the *trans*-oxazoline **105**. Partial hydrolysis of **105** gave the *N*-benzoyl derivative followed by protection of hydroxyl group with TBSCl. Finally *cis*-oxazoline **106** was formed by activation of the secondary alcohol as the mesylate and S<sub>N</sub>2 displacement by the amide carbonyl. Hydroboration followed by Suzuki coupling gave **107**. Hydrogenation of the olefin **107** and hydrolysis under acidic conditions afforded *L-threo*-sphinganine, which was converted to the known triacetate **108**. (**Scheme 20**)

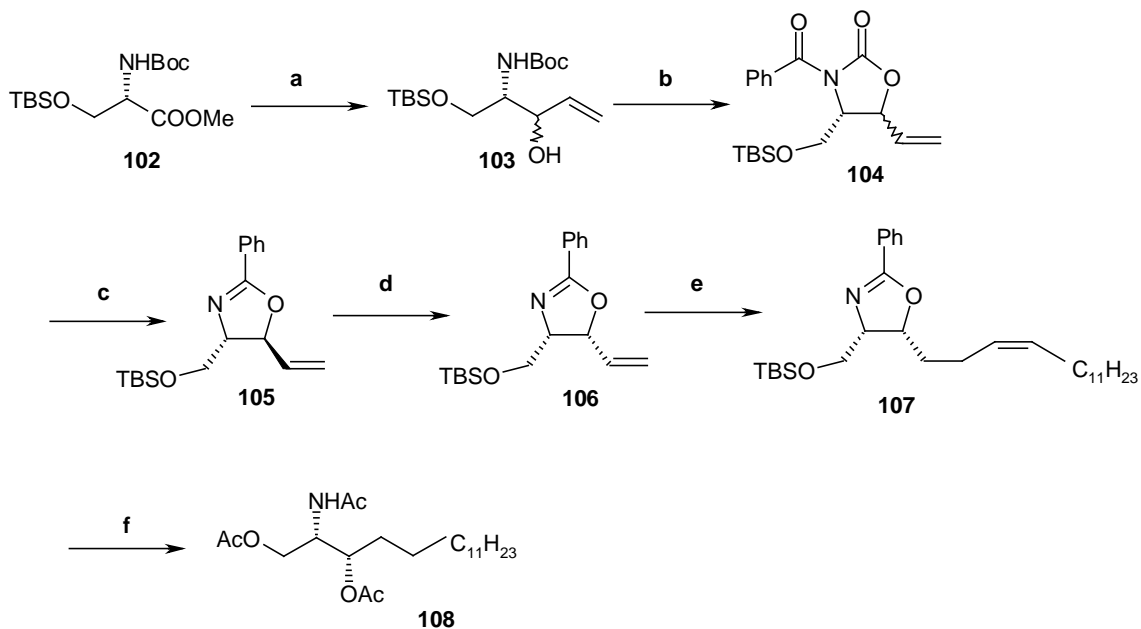

Scheme 20

Scheme 20 : *Reaction conditions* : (a) (i) DIBAL-H, Toluene,  $-78\text{ }^{\circ}\text{C}$ , 82% ; (ii) vinyl magnesium bromide, THF, 59% ; (b) NaH, THF, PhCOCl, 60% ; (c) Pd(PPh<sub>3</sub>)<sub>4</sub>, CH<sub>3</sub>CN, 90% ; (d) (i) 2N HCl, THF, 77% ; (ii) TBSCl, imidazole, 70% ; (iii) CH<sub>3</sub>SO<sub>2</sub>Cl, Et<sub>3</sub>N, 99% ; (e) 9-BBN, THF, Pd(PPh<sub>3</sub>)<sub>4</sub>, Z-1-bromotridecane, NaOH, THF, 52% ; (f) (i) H<sub>2</sub>, Pd/C, EtOAc, 86% ; (ii) 2N HCl, THF, NaOH, 66% ; (iii) Ac<sub>2</sub>O, pyr, 71%.

Ogino *et al.* (2000)<sup>51</sup>

Ogino *et al.* reported stereoselective synthesis for *L-threo*-sphinganine starting from *L*-serine. Garner's protected serine aldehyde **109** gave olefin **110** under Wittig conditions. The epoxidation of olefin **110** gave mixture of **111** and **112**. Reduction of epoxide **112** gave *L-threo*-sphinganine which was converted to known triacetate **108**. (Scheme 21)

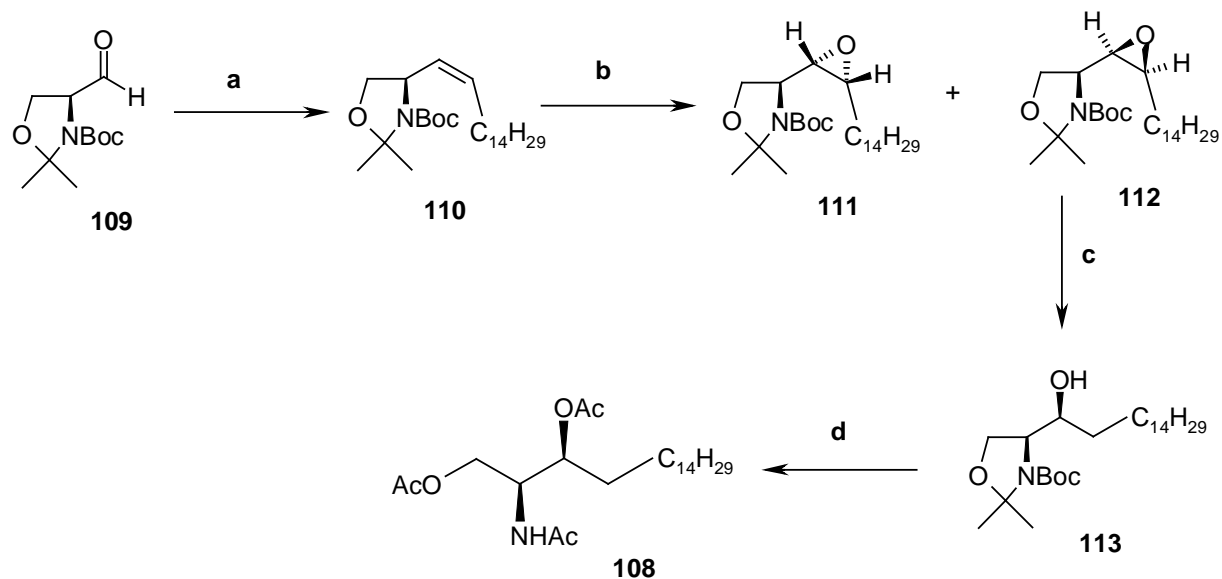

**Scheme 21**

**Scheme 21 : Reaction conditions :** (a) C<sub>15</sub>H<sub>31</sub>PPh<sub>3</sub>Br, LiHMDS, -78 °C ; (b) *m*CPBA, rt ;  
 LiAlH<sub>4</sub>, 0 °C ; (d) CF<sub>3</sub>COOH, rt, then Ac<sub>2</sub>O, DMAP, rt.

### 4.3.3 Present work

#### Objective

Although several syntheses of target compound have already been reported, each method suffers either from multisteps, low yielding steps or from poor stereo or regioselectivity. Therefore a practical, concise, expeditious and high-yielding synthesis of the target molecule is still desirable. The Sharpless asymmetric aminohydroxylation provides versatile and expeditious procedure for the synthesis of amino alcohol functionality in single step. We have utilized Panek<sup>55</sup> and Timothy<sup>56</sup> modifications for the asymmetric aminohydroxylation to synthesize the target molecule.

### 4.3.4 Results and Discussion

**Scheme 22** summarizes our synthesis of *L-threo*-sphinganine. The synthesis of *L-threo*-sphinganine commences from readily available 1-hexadecanol. Alcohol **114** was oxidized using pivaloyl chloride, DMSO, Et<sub>3</sub>N at -78 °C (our own protocol)<sup>57</sup> to hexadecanaldehyde which was used as such in the next Wittig olefination. Olefin **115** was prepared using panek protocol.<sup>55</sup> Accordingly 1-hexadecanal **93** was subjected to Horner-Emmons olefination with diethyl-(*p*-bromophenyl)-phosphonate using NaH as base to give the requisite olefin **115** in 79% yield. The IR spectrum of **115** showed presence of olefin and carbonyl stretching at 1651 and 1725 cm<sup>-1</sup> respectively and in the <sup>1</sup>H NMR spectrum olefin peaks appeared at δ 6.0 as doublet with coupling constant 15.7 Hz and 7.12-7.16 as multiplet. The <sup>13</sup>C NMR spectrum of **115** showed, olefin peaks at δ 123.3, 132.3 and phenyl peaks at δ 118.6-149.7. The Sharpless asymmetric aminohydroxylation of olefin **115** using potassium osmate, freshly prepared *t*-butyl hypochlorite,<sup>58</sup> chiral ligand (DHQ)<sub>2</sub>AQN and benzyl carbamate as nitrogen source in *n*-propanol:water (1:1) solvent gave **116** and with good levels of enantioselection (84%). The enantiomeric purity of amino alcohol **116** was estimated by chiral HPLC analysis using Chiralcel OD (4.6 mm IDx25 cm) HPLC-Cartridge (R.R.-Whelk-01), 5% *i*-PrOH in hexane, 1 mL/min. The IR spectrum of **116** showed absence of olefin peaks and presence of hydroxyl and amine stretching at 3435, 3020 cm<sup>-1</sup> respectively. The <sup>1</sup>H NMR spectrum of **116** indicated absence of olefin peaks and presence of δ 4.23-4.38 as broad multiplet for -CH-OH proton and δ 5.06 as doublet for -CH(NHCbz) proton confirming the formation of product. The ratio of regioisomers was found to be 6:1 using <sup>1</sup>H NMR analysis and it was expected that the initial ee of **116** could be enhanced at later stage by recrystallization of the known triacetate **108**. In the next step, ester group of **119** was



reduced to the corresponding alcohol using LiAlH<sub>4</sub> in dry THF, which led to the concomitant deprotection of benzyloxy carbonyl group as observed by <sup>1</sup>H NMR. The compound thus obtained was subsequently converted to the known triacetate **108** using acetic anhydride, pyridine and DMAP (cat.) for the ease of purification and characterization. Compound **108** was recrystallised twice from ethyl acetate and petroleum ether to improve the chiral purity. M.p. 45 °C [lit.<sup>51</sup> mp 43-44 °C]; [α]<sub>D</sub><sup>25</sup> : –6.42 (c 1.0, CHCl<sub>3</sub>). [lit.<sup>51</sup> [α]<sub>D</sub><sup>25</sup> : –6.67 (c 0.82, CHCl<sub>3</sub>)]. The physical and spectroscopic data of triacetate **108** were in full agreement with known literature data.<sup>51</sup>

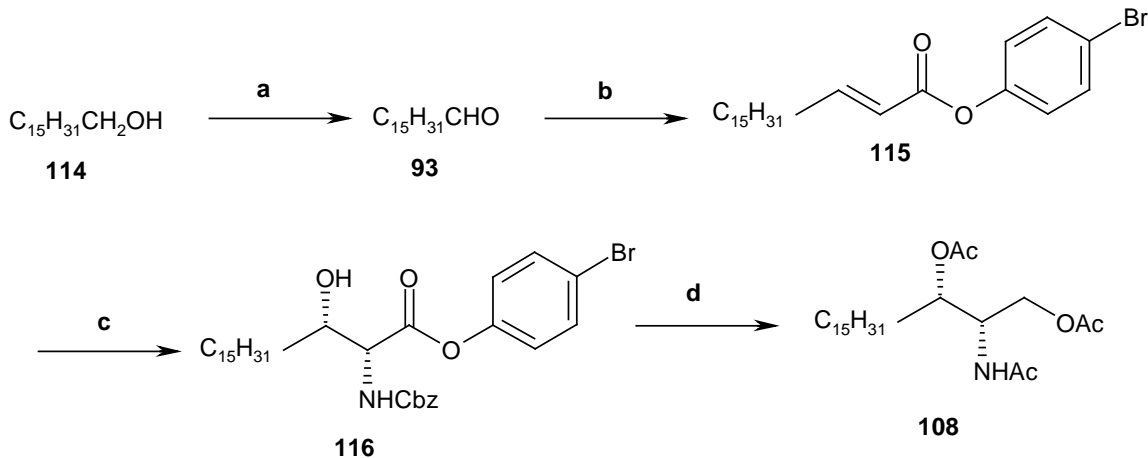

Scheme 22

**Scheme 22: Reaction conditions** : (a) (i) Piv-Cl, DMSO, Et<sub>3</sub>N, dry CH<sub>2</sub>Cl<sub>2</sub>, -78 °C, 3 h ; (ii) diethyl-(*p*-bromophenyl)phosphonate, NaH, dry THF, 0 °C-rt, 4 h, 79%; (b) *t*-BuOCl, NaOH, Benzyl carbamate, (DHQ)<sub>2</sub>AQN, *n*-PrOH:H<sub>2</sub>O, 5 h, 66% ; (c) (i) LiAlH<sub>4</sub>, dry THF, 0 °C-rt, 24 h (ii) Ac<sub>2</sub>O, pyridine, DMAP (cat), overnight, 84%.

An alternative synthetic sequence for the synthesis of *L*-threo-sphinganine employing tethered aminohydroxylation is shown in **Scheme 23**. Cetyl alcohol **114** was oxidized under DMSO-pivaloyl chloride conditions to afford the corresponding aldehyde which was treated with vinylmagnesium bromide in dry THF at -78 °C to furnish the racemic

alcohol **117** in 83% yield. The IR spectrum of **117** showed the presence of olefin and hydroxyl stretching at 1611, 3499  $\text{cm}^{-1}$  respectively. In the  $^1\text{H}$  NMR spectrum olefin peaks appeared at  $\delta$  5.08-5.26 (m) for terminal protons and  $\delta$  5.78-5.95 (m) for internal proton. In the  $^{13}\text{C}$  NMR spectrum of **117** olefin peaks appeared at  $\delta$  114.2, 141.3. The secondary racemic alcohol **117** was subjected to Sharpless kinetic resolution conditions using  $\text{Ti}(\text{O}^i\text{Pr})_4$ , (-)-DIPT as chiral auxiliary and TBHP as oxidant in dry DCM at  $-20^\circ\text{C}$  for 6 h to give the chiral hydroxy olefin **118** and chiral epoxy alcohol **119** in excellent yield. Both compounds **118** and **119** were thoroughly characterized using IR,  $^1\text{H}$  NMR and  $^{13}\text{C}$  NMR spectra. In the IR spectrum of **118**, olefin and hydroxyl stretching appeared at 1609 and 3511  $\text{cm}^{-1}$  respectively. The  $^1\text{H}$  and  $^{13}\text{C}$  NMR spectra of **118** showed the presence of olefin peaks at  $\delta$  5.07-5.27 (m), 5.79-5.96 (m, 1H) and 114.2, 141.3 respectively. Having obtained the chiral allylic alcohol **118** in substantial amount and a suitable for tethered aminohydroxylation we then proceeded with the synthesis of target compound sphinganine. Accordingly the allylic alcohol **118** was treated with trichloroacetyl isocyanate using DCM: $\text{CH}_3\text{OH}$  (1.7:2.2) and  $\text{K}_2\text{CO}_3$  as a base to give the required carbamate **120** in excellent yield. The  $^1\text{H}$  NMR spectrum of **120** clearly indicated broad singlet for  $-\text{NH}_2$  at  $\delta$  4.68 and in the  $^{13}\text{C}$  NMR spectrum amide carbonyl peak appeared at  $\delta$  156.6. Carbamate **120** was then subjected to the tethered aminohydroxylation<sup>56</sup> using potassium osmate as oxidant in *n*-propanol : water solvent system (1:1) in the presence of diisopropyl ethyl amine to furnish the oxazolidinone **121** in 62% yield. Compound **121** was fully characterized using IR,  $^1\text{H}$  NMR and  $^{13}\text{C}$  NMR spectra. In the IR spectrum hydroxyl and amine stretching appeared at 3506, 3362  $\text{cm}^{-1}$ . The  $^1\text{H}$  NMR and  $^{13}\text{C}$  NMR spectra of **121** showed disappearance of olefin peaks and

appearance of  $-CH(OH)$ ,  $-CH(NH)$  protons and carbon peaks at  $\delta$  3.88-4.03 (m), 4.99-5.14 (m) and  $\delta$  71.4, 80.3 respectively. Our next objective was conversion of **121** into the known triacetate **108** which was easily achieved by treatment of **121** with potassium carbonate in methanol to give the aminodiol which on subsequent acylation furnished the target molecule to furnish **108** in 82% yield ;  $[[\alpha]_D^{25} : -9.67 (c 0.4, CHCl_3)]$ . The physical and spectroscopic data of **108** were in full agreement with those reported.<sup>51</sup>

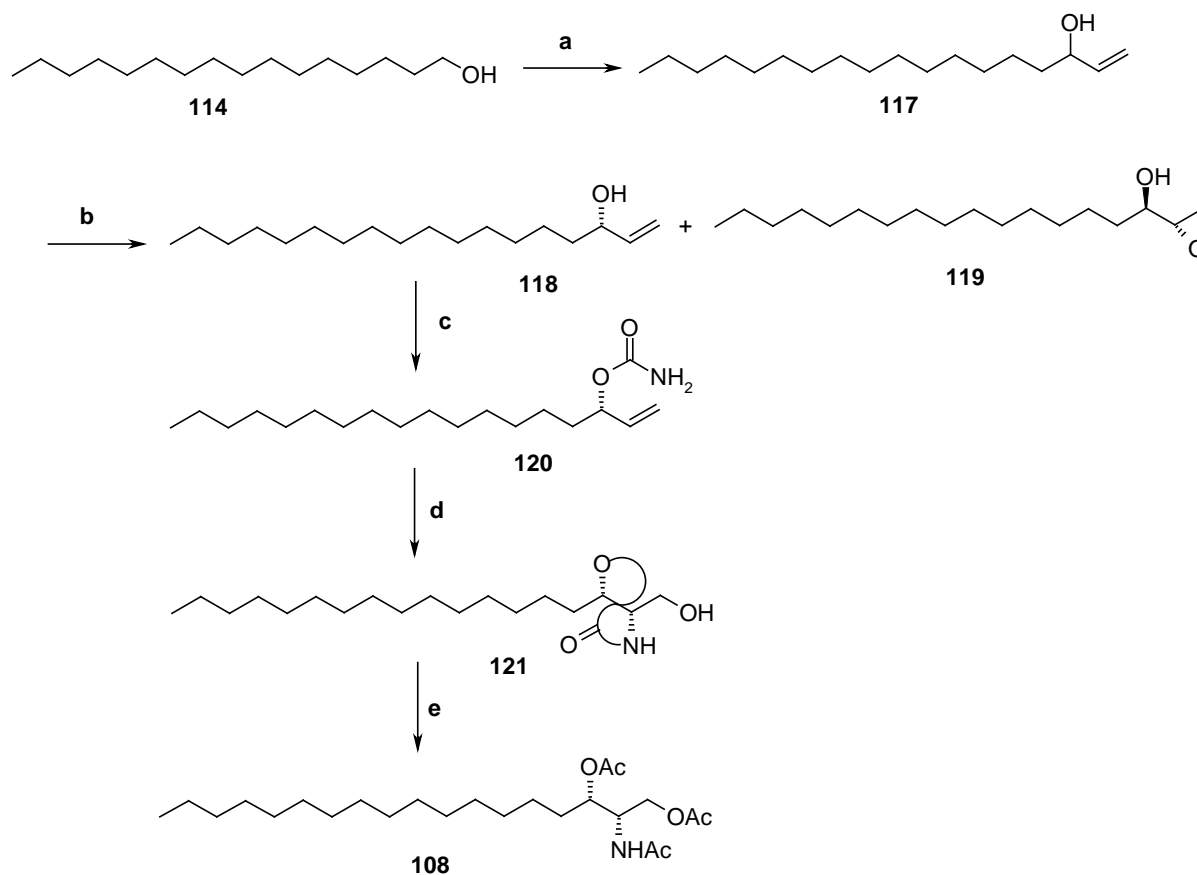

**Scheme 23**

**Scheme 23: Reaction conditions :** (a) (i) Piv-Cl, DMSO, Et<sub>3</sub>N, dry CH<sub>2</sub>Cl<sub>2</sub>, -78° C, 2 h ; (ii) vinyl bromide, dry THF, Mg, -78° C, 2 h, 83% ; (b) (-)-DIPT, Ti(O-<sup>i</sup>Pr)<sub>4</sub>, TBHP, dry DCM, molecular sieves, 3°A, -20° C, 6 h, ; (c) CCl<sub>3</sub>CNO, K<sub>2</sub>CO<sub>3</sub>, DCM : CH<sub>3</sub>OH (1.5:1), 4 h, 97% ; (d) NaOH, *t*-BuOCl, <sup>i</sup>PrEt<sub>2</sub>N, potassium osmate, 2.5 h, 62% ; (e) (i) K<sub>2</sub>CO<sub>3</sub>, methanol, rt, 6 h ; (ii) Ac<sub>2</sub>O, pyridine, DMAP (cat), overnight, 82%.

### 4.3.5 Conclusion

We have accomplished the enantioselective synthesis of L-threo-sphinganine employing the Sharpless asymmetric aminohydroxylation as the key step in a highly concise manner. The problem of regioselectivity was overcome in the synthesis by tethered aminohydroxylation. A short reaction sequence and high-yielding steps renders our strategy a good alternative to the known methods.

### 4.3.6 Experimental section

Solvents were purified and dried by standard procedures before use. Petroleum ether of boiling range 60-80 °C was used. Melting points are uncorrected. Optical rotations were measured using the sodium D line of a JASCO-181 digital polarimeter. Infrared spectra were recorded with an ATI MATSION RS-1 FT-IR spectrometer. <sup>1</sup>H NMR and <sup>13</sup>C NMR spectra were recorded with a Bruker AC-200 spectrometer. Elemental analyses were carried out with a Carlo Erba CHNS-O analyzer.

#### Preparation of 1-Hexadecanal

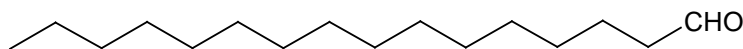

**93**

To a stirred solution of DMSO (1.17 mL, 16.49 mmol) in dry dichloromethane (20 mL) was added pivaloyl chloride (1 mL, 8.24 mmol) in dry DCM (3 mL) and solution was cooled to -78 °C. The reaction mixture was stirred for 15 min. Alcohol **114** (1 g, 4.12 mmol) in dry DCM (5 mL) was added dropwise to the above reaction mixture. After consumption of the starting material (nearly, 1 h), Et<sub>3</sub>N (2.87 mL, 20.62 mmol) was added and mixture stirred at -78 °C for further 30 min. The reaction mixture was brought to rt slowly and stirred for 30 min. The reaction mixture was quenched with saturated NH<sub>4</sub>Cl, water and organic layer separated. The aqueous layer was extracted with dichloromethane and combined organic layers were washed with brine solution, dried

over Na<sub>2</sub>SO<sub>4</sub> and concentrated to near dryness. The crude aldehyde **93** was used as such in the next reaction.

### Preparation of *p*-(Bromophenyl)-2-decaoctenoate

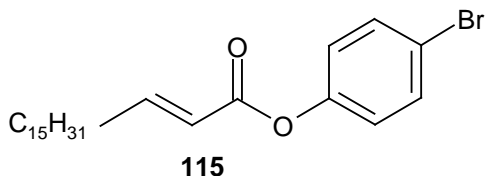

To a suspension of NaH (0.18 g, 4.57 mmol) in dry THF (15 mL) at 0 °C was added dropwise a solution of *p*-(bromophenyl)-diethylphosphonoacetate (1.6 g, 4.57 mmol) in dry THF (5 mL). The mixture was stirred for 10 minutes at 0 °C, then warmed to ambient temperature for 10 minutes. To this solution was added 1-hexadecanal **93** (1.0 g, 4.15 mmol) and the solution stirred for 4 h at ambient temperature. The reaction mixture was subsequently diluted with saturated NH<sub>4</sub>Cl (10 mL), extracted with ethyl acetate (3x20 mL), dried over Na<sub>2</sub>SO<sub>4</sub> and concentrated to near dryness. The crude product was purified on silica gel column chromatography using EtOAc:pet ether (1:9) to give **115** (1.42 g) as a white solid.

**Yield:** 79%

**M.p.** 32 °C

**IR (CHCl<sub>3</sub>, cm<sup>-1</sup>):**  $\gamma_{\max}$  1725, 1651, 1466, 1215, 1069, 928, 669, 623, 533, 502

**<sup>1</sup>H NMR (200MHz, CDCl<sub>3</sub>):**  $\delta$  0.88 (t, *J* = 5.87 Hz, 3H), 1.27 (m, 26H), 2.29 (q, *J* = 6.66 Hz, 2H), 6.0 (d, *J* = 15.66 Hz, 1H), 7.02 (d, *J* = 8.61 Hz, 2H), 7.12-7.16 (m, 1H), 7.5 (d, *J* = 9.0 Hz, 2H)

**<sup>13</sup>C NMR (CDCl<sub>3</sub>, 50MHz):**  $\delta$  14.0, 22.6, 27.8, 29.3, 29.6, 31.9, 118.6, 120.0, 123.3, 132.3, 149.7, 152.4, 164.5

**Analysis:** C<sub>24</sub>H<sub>37</sub>BrO<sub>2</sub> (437.46) requires. C, 65.89 ; H, 8.52 ; Found. C, 65.79 ; H, 8.46.

**Preparation of (2*R*,3*S*)-(para-Bromophenyl)-2-benzyloxycarbonylamino-3-hydroxy-Octadecanoate**

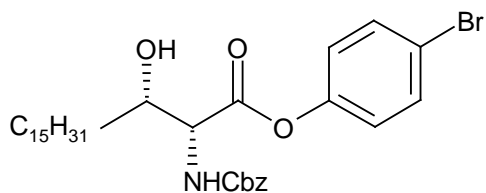

**116**

A solution of 0.4 N sodium hydroxide (8.5 mL, 3.48 mmol) was stirred in a water bath in a dimly lit hood. A small amount of this solution was used to dissolve potassium osmate dihydrate (17 mg, 4 mol%) in a separate vial. To this remaining sodium hydroxide solution was added *n*-propanol (5.2 mL) followed by benzyl carbamate (0.53 g, 3.54 mmol). To this reaction mixture was added freshly prepared *t*-butyl hypochlorite (0.38 mL, 3.48 mmol) and stirred for 5 minutes. To this homogeneous solution was added a solution of (DHQ)<sub>2</sub>AQN (49 mg, 5 mol%) in *n*-propanol (3.9 mL) followed by *p*-bromophenyl-2-(*E*)-heptenoate **115** (0.5 g, 1.14 mmol) in *n*-propanol (3 mL) and finally added the potassium osmate dihydrate solution. The reaction mixture was stirred until completion of the starting material and then quenched with sodium sulfite (200 mg) and subsequently diluted with ethyl acetate. The reaction mixture was extracted with ethyl acetate (3x10 mL), dried over Na<sub>2</sub>SO<sub>4</sub> and concentrated to near dryness. The crude product was purified by flash silica gel column chromatography using EtOAc:pet. ether (3:7) as eluent to give **116** (0.45 g) as a solid material.

**Yield:** 66%

**M.p.** : 56-57 °C

$[\alpha]_D^{25}$  : -7.28 [*c* 0.12, CHCl<sub>3</sub>]

**IR (CHCl<sub>3</sub>, cm<sup>-1</sup>)** :  $\gamma_{\max}$  3435, 3020, 2927, 2855, 1723, 1511, 1400, 1215, 1083, 788, 669, 534

**<sup>1</sup>H NMR (500MHz, CDCl<sub>3</sub>)**:  $\delta$  0.84 (t, *J* = 6.42 Hz, 3H), 1.16-1.26 (m, 26H), 1.55 (dq, *J* = 14.20 Hz, 2H), 3.04 (brs, 1H, OH), 4.23-4.38 (brm, 1H), 4.59 (s, 2H), 5.06 (d, *J* = 8.71 Hz, 1H), 5.14 (d, *J* = 9.17 Hz, 1H), 7.19 (d, *J* = 8.70 Hz, 2H), 7.26-7.28 (m, 5H), 7.37 (d, *J* = 8.71 Hz, 2H)

**<sup>13</sup>C NMR (125MHz, CDCl<sub>3</sub>)** :  $\delta$  13.9, 22.5, 25.5, 29.2, 29.3, 29.5, 29.6, 29.9, 31.7, 64.9, 66.7, 123.1, 126.8, 127.3, 127.6, 127.8, 127.9, 128.0, 128.2, 128.3, 128.4, 132.3, 136.1, 157.0, 169.9

**Analysis** : C<sub>32</sub>H<sub>46</sub>BrNO<sub>5</sub> (604.62) requires. C, 63.56 ; H, 7.66 ; N, 2.31 ; Found. C, 63.42 ; H, 7.59 ; N, 2.30.

### Preparation of (2*S*,3*S*)-2-Acetamido-1, 3-dihydroxyoctadecane

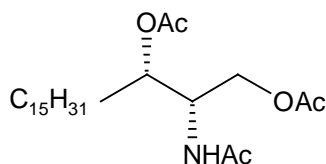

**108**

To a suspension of LiAlH<sub>4</sub> (22 mg, 0.57 mmol) in dry THF (10 mL) at 0 °C was added a solution of **116** (0.23 g, 0.38 mmol) in dry THF (3 mL). The reaction mixture was allowed to warm to room temperature and stirred for 24 h. After consumption of the starting material, the reaction mixture was quenched with 5% aq. NaOH until effervescence ceased. The white precipitate was filtered and washed with ethyl acetate (3x5 mL). The combined organic layers were dried over Na<sub>2</sub>SO<sub>4</sub> and concentrated to near

dryness, which was subsequently acetylated with acetic anhydride (77 mg, 0.76 mmol), pyridine (64 mg, 0.80 mmol) and DMAP (cat). After overnight stirring the solvent was evaporated and the residue was purified on silica gel column using EtOAc:pet. ether (1:9) as eluent to afford **108** (0.143 g) as a white solid. It was further recrystallized twice from hexane/EtOAc. Spectroscopic data of triacetate **108** were in full agreement with those reported.<sup>51</sup>

**Yield:** 84%

**M.p. :** 44 °C [lit.<sup>51</sup> mp 43-44 °C]

$[\alpha]_D^{25}$  : -6.67 (*c* 0.68, CHCl<sub>3</sub>) [lit.<sup>51</sup>  $[\alpha]_D^{25}$  : -6.86 (*c*, 2.0, CHCl<sub>3</sub>)]

**<sup>1</sup>H NMR (500MHz, CDCl<sub>3</sub>):** δ 0.89 (t, *J* = 6.2 Hz, 3H), 1.25-1.28 (m, 26H), 1.50-1.57 (m, 2H), 2.05 (s, 3H), 2.06 (s, 3H), 2.08 (s, 3H), 4.0-4.05 (m, 2H), 4.30 (dd, *J* = 9.3, 6.4 Hz, 1H), 5.13-5.16 (m, 1H), 5.63 (d, *J* = 9.2 Hz, 1H).

**<sup>13</sup>C NMR (125MHz, CDCl<sub>3</sub>) :** δ 14.0, 20.2, 22.6, 24.3, 25.4, 29.3, 29.6, 31.8, 32.2, 49.9, 62.8, 72.0, 170.0, 170.2, 170.8,

Preparation of Octadec-1-en-3-ol

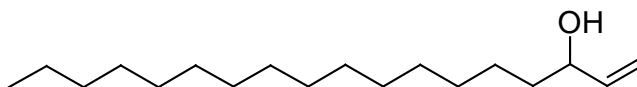

**117**

To a stirred solution of Mg (0.69 g, 29.11 mmol), in dry THF (20 mL) vinyl bromide solution (8.31 mL, 2.0 M solution in dry THF, 16.63 mmol) was added dropwise and the Grignard reagent thus formed was cooled to -78 °C. Aldehyde **93** (2 g, 8.31 mmol) in dry THF (5 mL) was added dropwise to the above reaction mixture. After 2 h stirring at -78 °C the reaction mixture was quenched with saturated NH<sub>4</sub>Cl solution (10 mL), and the aqueous layer was extracted with ethyl acetate (4x20 mL) and the combined organic layers were washed with brine and dried over Na<sub>2</sub>SO<sub>4</sub>. The extracts were concentrated to near



dryness and purified by silica gel column chromatography using EtOAc:pet. ether (1:9) as eluent to give **117** as a pale yellow solid (1.84 g).

**Yield :** 83%

**M.p. :** 42 °C

**IR (CHCl<sub>3</sub>, cm<sup>-1</sup>) :**  $\gamma_{\max}$  3499, 1611

**<sup>1</sup>H NMR (CDCl<sub>3</sub>, 200 MHz) :**  $\delta$  0.89 (t,  $J = 6.06$  Hz, 3H), 1.26 (m, 26H), 1.54 (q,  $J = 3.41$  Hz, 2H), 1.69 (brs, 1H), 4.11 (q,  $J = 12.51$  Hz, 1H), 5.08-5.26 (m, 2H), 5.78-5.95 (m, 1H)

**<sup>13</sup>C NMR (CDCl<sub>3</sub>, 50 MHz) :**  $\delta$  14.0, 22.6, 25.3, 25.7, 29.3, 29.6, 31.8, 32.6, 36.9, 62.6, 73.0, 114.2, 141.3

**Analysis:** C<sub>18</sub>H<sub>36</sub>O (268.48) requires. C, 80.53 ; H, 13.52 ; Found. C, 80.51 ; H, 13.49.

**Preparation of 3(S)-Octadec-1-ene-3-ol**

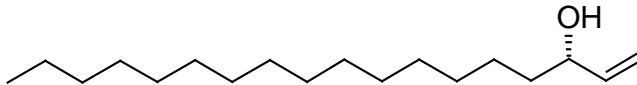

**118**

To a mixture of 3 Å molecular sieves (225 mg) and Ti(<sup>i</sup>-PrO)<sub>4</sub> (1.34 mL, 4.50 mmol) in dry CH<sub>2</sub>Cl<sub>2</sub> (40 mL) (-)-DIPT (1.2 mL, 5.73 mmol) was added dropwise at -20 °C. The mixture was stirred for 20 min. at -20 °C, and a solution of enantiomeric mixture of **117** (1.1 g, 4.1 mmol) in dry CH<sub>2</sub>Cl<sub>2</sub> (5 mL) was added slowly. The reaction mixture was stirred for additional 30 min. at -20 °C and TBHP (3.4 mL, 3 M solution in toluene, 10.24 mmol) was added dropwise. The reaction mixture was stirred at -20 °C by constant temperature bath and after 6 h the reaction was first quenched with water followed by base work up. The crude product was then purified by flash chromatography on silica gel using EtOAc:pet. ether (1:9) as eluent to give chiral hydroxy olefin **118** as white solid. Further elution with EtOAc:pet. ether (2:8) gave enantiopure epoxide **119** (0.45 g) as a white solid.

**Yield:** 74%

**M.p. :** 42-43 °C

$[\alpha]_D^{25}$  : + 8.28 (*c* 0.32, CHCl<sub>3</sub>)

**IR (CHCl<sub>3</sub>, cm<sup>-1</sup>) :**  $\gamma_{\max}$  3511, 1609

**<sup>1</sup>H NMR (CDCl<sub>3</sub>, 200 MHz) :**  $\delta$  0.89 (t, *J* = 6.18 Hz, 3H), 1.26 (m, 26H), 1.52-1.55 (m, 2H), 1.57 (brs, 1H), 4.12 (q, *J* = 12.51 Hz, 1H), 5.07-5.27 (m, 2H), 5.79-5.96 (m, 1H)

**<sup>13</sup>C NMR (CDCl<sub>3</sub>, 50 MHz) :**  $\delta$  14.0, 22.6, 25.3, 29.4, 29.6, 31.8, 36.9, 62.6, 73.2, 114.4, 141.3

**Analysis :** C<sub>18</sub>H<sub>36</sub>O (268.48) requires. C, 80.53 ; H, 13.52 ; Found. C, 80.51 ; H, 13.49.

#### Preparation of 1-Oxiranyl-hexadecan-1-ol

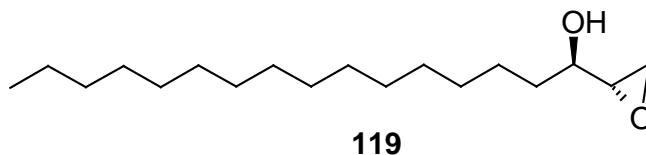

**Yield :** 72%

**M.p. :** 53 °C

$[\alpha]_D^{25}$  : -6.32 (*c* 1.32, CHCl<sub>3</sub>)

**IR (CHCl<sub>3</sub>, cm<sup>-1</sup>) :**  $\gamma_{\max}$  3482, 2854, 1736

**<sup>1</sup>H NMR (CDCl<sub>3</sub>, 200 MHz) :**  $\delta$  0.89 (t, *J* = 6.06 Hz, 3H), 1.26 (m, 26H), 1.49-1.59 (m, 2H), 2.71-2.84 (m, 2H), 3.04 (q, *J* = 5.03 Hz, 1H), 3.86 (qn, *J* = 3.63 Hz, 1H), 4.48 (brs, 1H)

**<sup>13</sup>C NMR (CDCl<sub>3</sub>, 50 MHz) :**  $\delta$  13.9, 21.6, 22.5, 25.2, 29.2, 31.8, 33.4, 43.4, 54.6, 68.4, 70.1, 72.1

**Analysis :** C<sub>18</sub>H<sub>36</sub>O<sub>2</sub> (284.48) requires. C, 76.00 ; H, 12.76 ; Found. C, 75.98 ; H, 12.74.

#### Preparation of 3(S)-Carbamic acid-1-pentadecyl-allyl ester

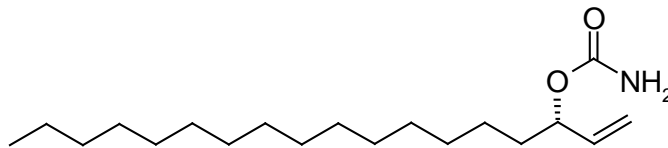

**120**

Trichloroacetyl isocyanate (0.16 mL, 1.34 mmol) was added dropwise to a solution of the alcohol **118** (0.3 g, 1.11 mmol) in dry dichloromethane (1.7 mL) at 0 °C. After stirring for 2 h, or until TLC showed absence of starting material the mixture was concentrated under reduced pressure. The residue was dissolved in methanol (2.2 mL), cooled to 0 °C and aqueous potassium carbonate solution (0.46 g, 3.4 mL, 3.35 mmol) was added. The cooling bath was removed and the mixture was allowed to stir for 4 h, by which time TLC showed complete conversion. The methanol was evaporated under reduced pressure and the aqueous residue was extracted with dichloromethane (4x5 mL). The combined organics were washed with brine, dried over sodium sulfate and concentrated under reduced pressure to yield the crude carbamate, which was purified by flash silica gel column chromatography using EtOAc:pet. ether (3:6) as eluent to give **120** (0.32 g) as a white crystalline solid.

**Yield:** 97%

**M.p. :** 44 °C

$[\alpha]_D^{25}$  : -10.36 (*c* 0.62, CHCl<sub>3</sub>)

**IR (CHCl<sub>3</sub>, cm<sup>-1</sup>) :**  $\gamma_{\max}$  3430, 2917, 2849, 1693, 1665

**<sup>1</sup>H NMR (CDCl<sub>3</sub>, 200 MHz) :**  $\delta$  0.88 (t, *J* = 6.19 Hz, 3H), 1.26 (m, 26H), 1.58-1.74 ( m, 2H), 4.68 (brs, 2H), 5.09-5.14 (m, 1H), 5.18-5.30 (m, 2H), 5.71-5.88 (m, 1H)

**<sup>13</sup>C NMR (CDCl<sub>3</sub>, 50 MHz) :**  $\delta$  14.0, 22.6, 25.0, 29.3, 29.3, 29.4, 29.6, 31.8, 75.5, 116.1, 136.9, 156.6

**Analysis :** C<sub>19</sub>H<sub>37</sub>NO<sub>2</sub> (311.50) requires. C, 73.26 ; H, 11.97 ; N, 4.50 ; Found. C, 73.22 ; H, 11.96 ; N, 4.48.

**Preparation of 4-Hydroxymethyl-5-pentadecyl-[1,3]dioxolan-2-one**

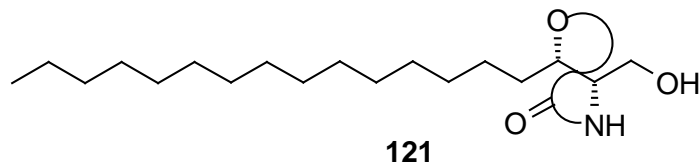

A fresh aqueous solution of sodium hydroxide (34 mg, 12 mL, 0.87 mmol) was prepared. All but a few drops of this was added in one portion to a stirred solution of the allylic carbamate **120** (0.3 g, 0.96 mmol) in propan-1-ol (12 mL). The solution was allowed to stir for 5 mins, before freshly prepared *tert*-butyl hypochlorite (0.1 g, 0.96 mmol) was added. The mixture was again allowed to stir for 5 mins. To this was added diisopropyl ethyl amine ( $8.3 \times 10^{-3}$  mL, 5 mol%) in one portion. The mixture was allowed to stir for a further 5 mins before the final addition of a solution of potassium osmate (14 mg, 4 mol%) in the remainder of the sodium hydroxide solution earlier. The reaction was monitored by TLC and halted when no further change was detected. The reaction was quenched by the addition of sodium sulfite (500 mg), and allowed to stir for 30 mins. The mixture was extracted with ethyl acetate (5x10 mL). The combined organics were washed with brine, dried over sodium sulfate and concentrated under reduced pressure. The crude material was purified by flash column chromatography on silica gel using EtOAc:pet. ether (6:4) as eluent to provide **121** (0.21 g) as a pale yellow solid.

**Yield:** 62%

**M.p. :** 48 °C

$[\alpha]_D^{25}$  : -6.77 (*c* 0.44, CHCl<sub>3</sub>)

**IR (CHCl<sub>3</sub>, cm<sup>-1</sup>) :**  $\gamma_{\max}$  3506, 3362

**<sup>1</sup>H NMR (CDCl<sub>3</sub>, 200 MHz) :**  $\delta$  0.89 (t, *J* = 6.06 Hz, 3H), 1.26-1.28 (m, 26H), 1.59-1.69 (m, 2H), 3.65 (m, 2H), 3.88-4.03 (m, 1H), 4.99-5.14 (m, 1H), 5.41 (brs, 1H)

**<sup>13</sup>C NMR (CDCl<sub>3</sub>, 50 MHz) :**  $\delta$  14.0, 22.6, 24.3, 25.3, 29.3, 31.8, 34.9, 62.8, 71.4, 80.3, 158.9

**Analysis :** C<sub>19</sub>H<sub>36</sub>NO<sub>3</sub> (343.54) requires. C, 69.92 ; H, 12.03 ; N, 4.08 ; Found. C, 69.90 ; H, 12.00 ; N, 4.02.

**Preparation of (2*S*,3*S*)-2-Acetamido-1, 3-dihydroxyoctadecane**

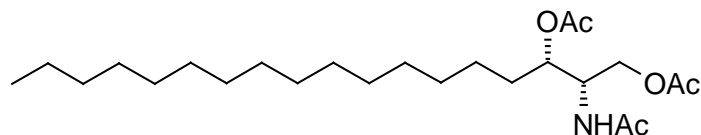

**108**

To a stirred solution of TA product **121** (90 mg, 0.26 mmol) in methanol (3 mL) was added potassium carbonate (72 mg, 0.39 mmol) and the reaction mixture was stirred until disappearance of the starting material and methanol was removed in vacuo. Water was added to the crude product and mixture extracted with ethyl acetate (3x 3 mL) and dried over sodium sulphate and concentrated to near dryness and which was subsequently acetylated with acetic anhydride (0.053 g, 0.52 mmol), pyridine (0.043 g, 0.54 mmol) and DMAP (cat). After overnight stirring the solvent was evaporated and the residue was purified on silica gel column, using petroleum ether:ethyl acetate (9:1) as eluent to give triacetate **108** (0.082 g, 74%) as a white solid. It was further recrystallized from hexane/EtOAc; mp 44 °C [lit.<sup>51</sup> mp 43-44 °C];  $[\alpha]_D^{20} : -9.67$  (*c*.0.4, CHCl<sub>3</sub>). {lit.<sup>51</sup>  $[\alpha]_D^{20} : -6.86$  (*c* 2.0, CHCl<sub>3</sub>)} Spectroscopic data of triacetate **108** were in full agreement with those reported.<sup>51</sup>

### 4.3.7 Spectra

1. <sup>1</sup>H & <sup>13</sup>C NMR spectra of **115**
2. <sup>1</sup>H & <sup>13</sup>C NMR spectra of **116**
3. <sup>1</sup>H NMR Mosher spectrum of **118**
4. <sup>1</sup>H & <sup>13</sup>C NMR spectra of **118**
5. <sup>1</sup>H & <sup>13</sup>C NMR spectra of **120**
6. <sup>1</sup>H & <sup>13</sup>C NMR spectra of **121**
7. <sup>1</sup>H & <sup>13</sup>C NMR spectra of **108**

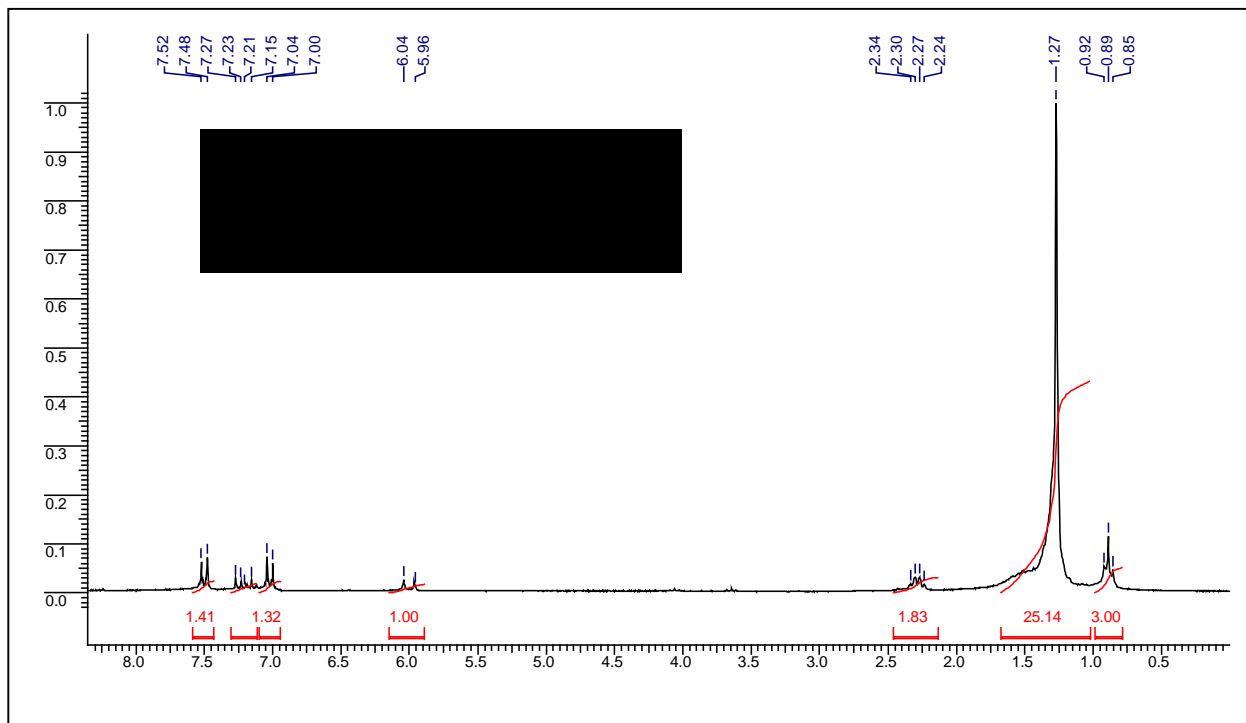

$^1\text{H}$  NMR spectrum of compound 115 in  $\text{CDCl}_3$

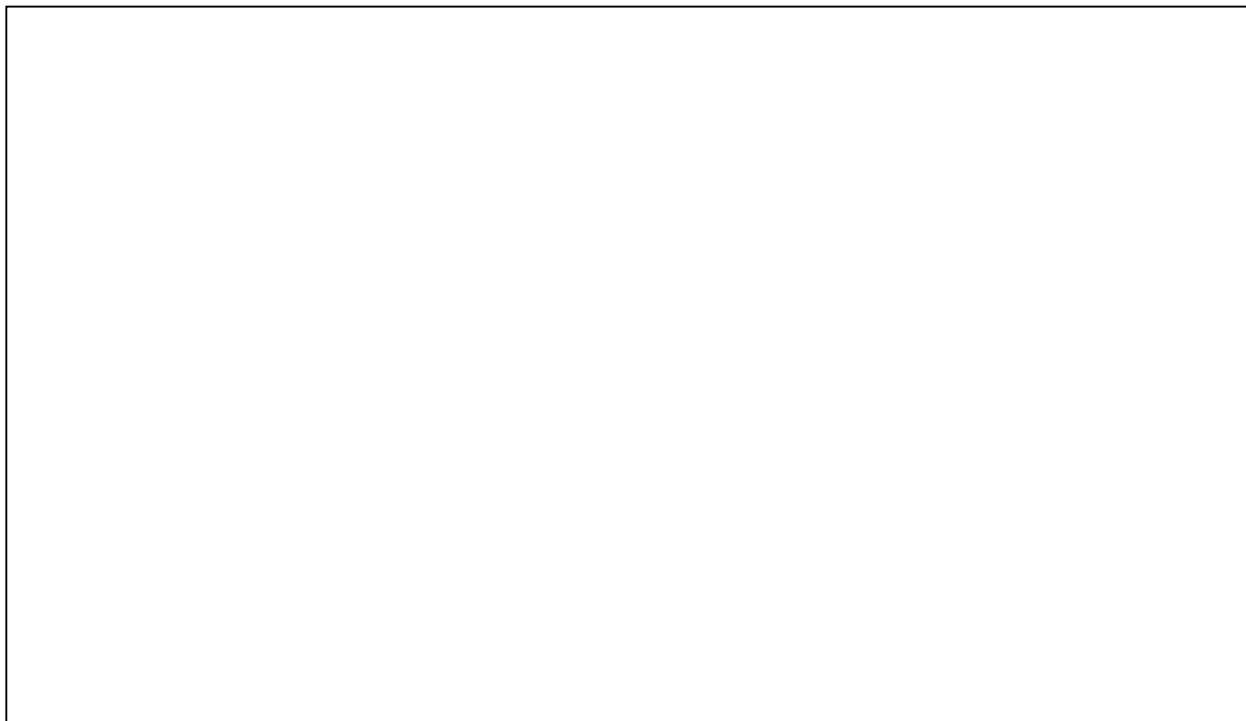

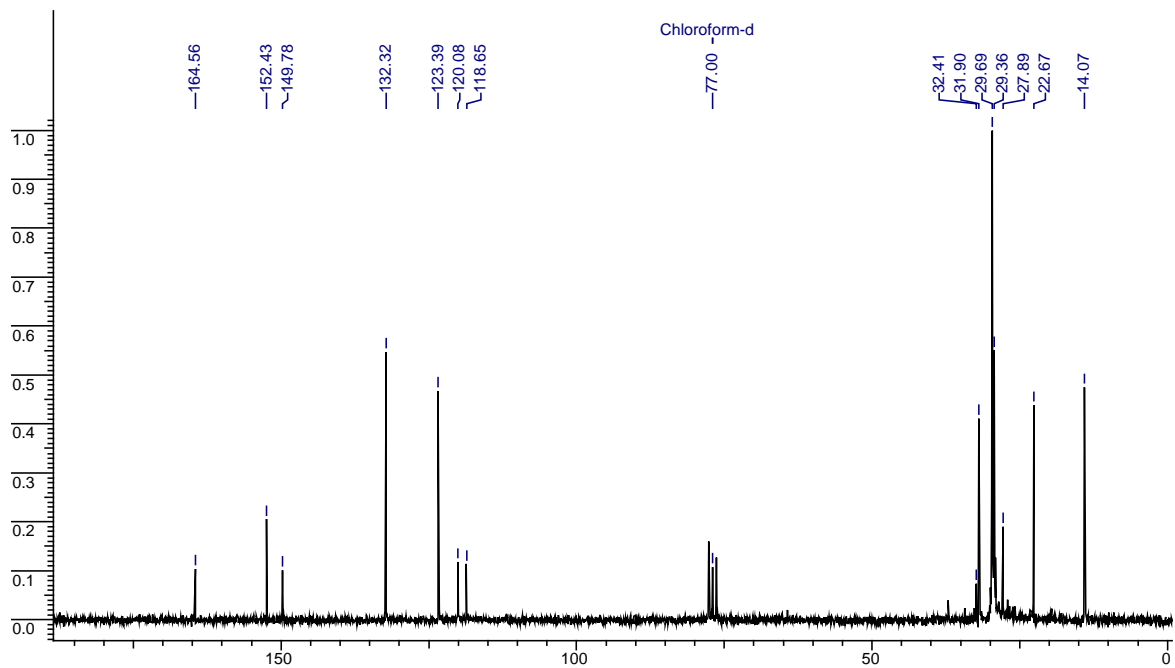

$^{13}\text{C}$  NMR spectrum of compound 115 in  $\text{CDCl}_3$

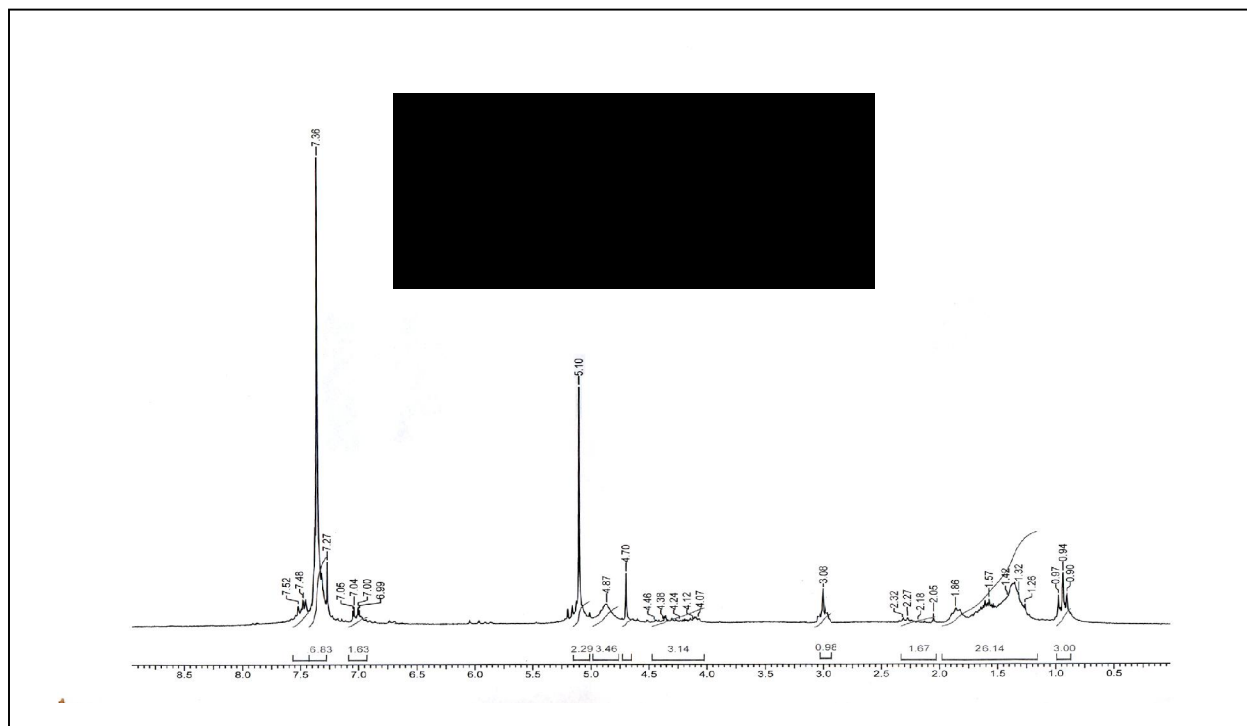

$^1\text{H}$  NMR spectrum of compound 116 in  $\text{CDCl}_3$

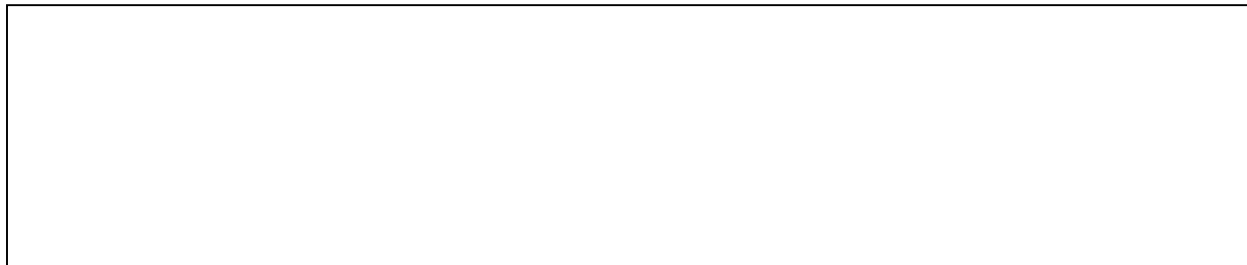

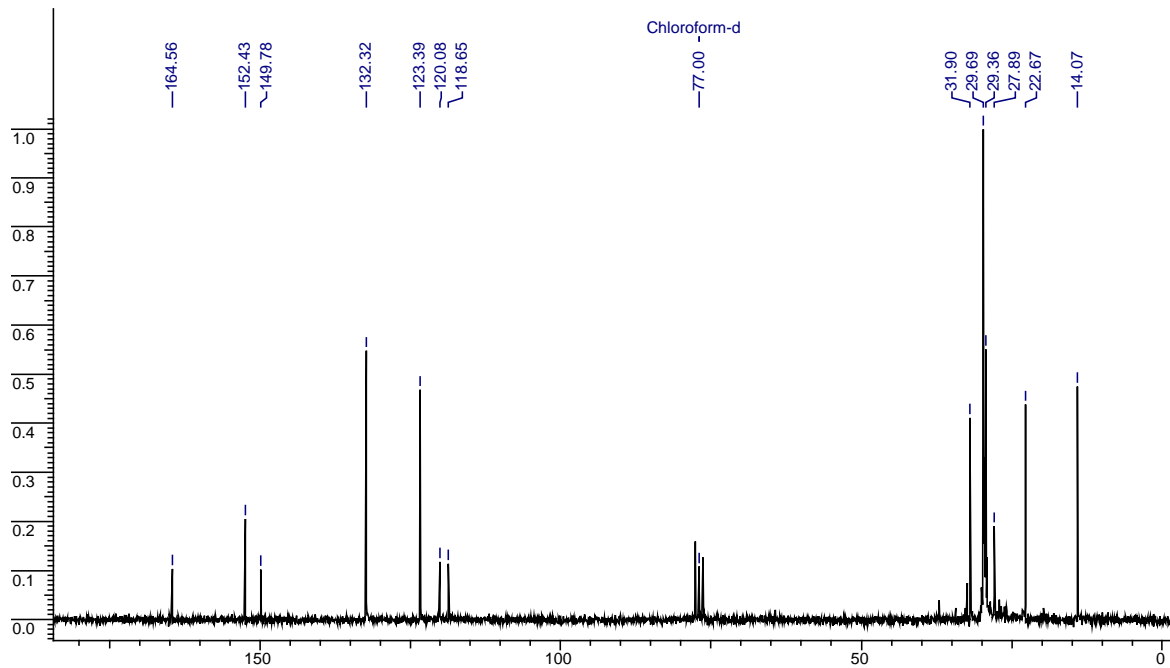

$^{13}\text{C}$  NMR spectrum of compound 116 in  $\text{CDCl}_3$





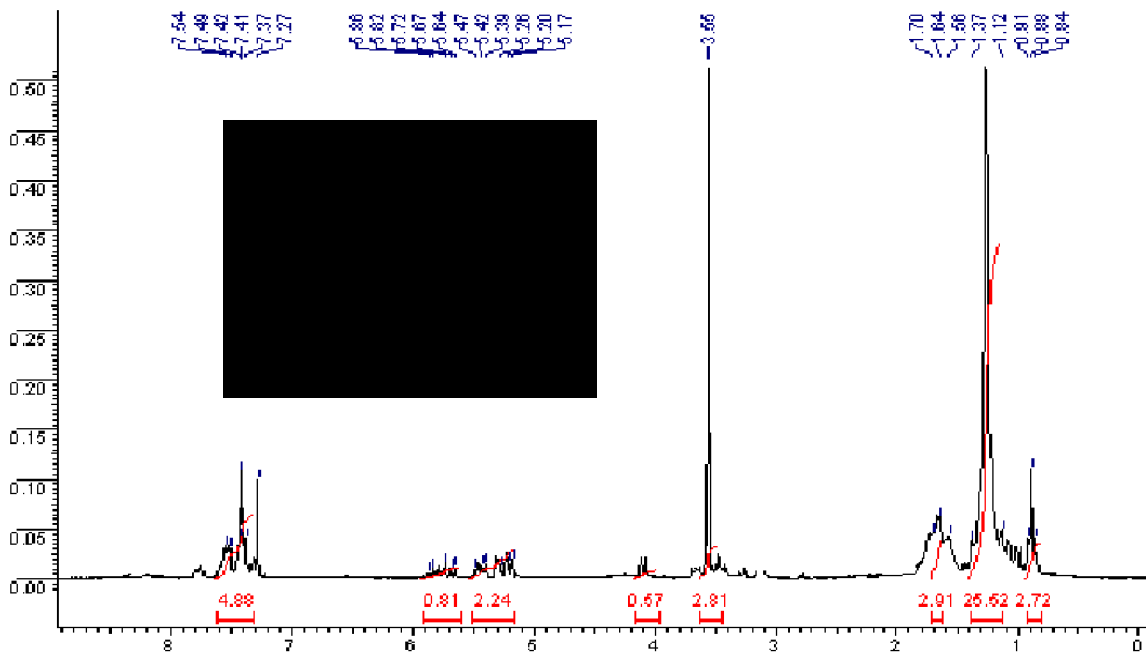

**$^1\text{H}$  NMR Mosher spectrum of compound 118 in  $\text{CDCl}_3$**

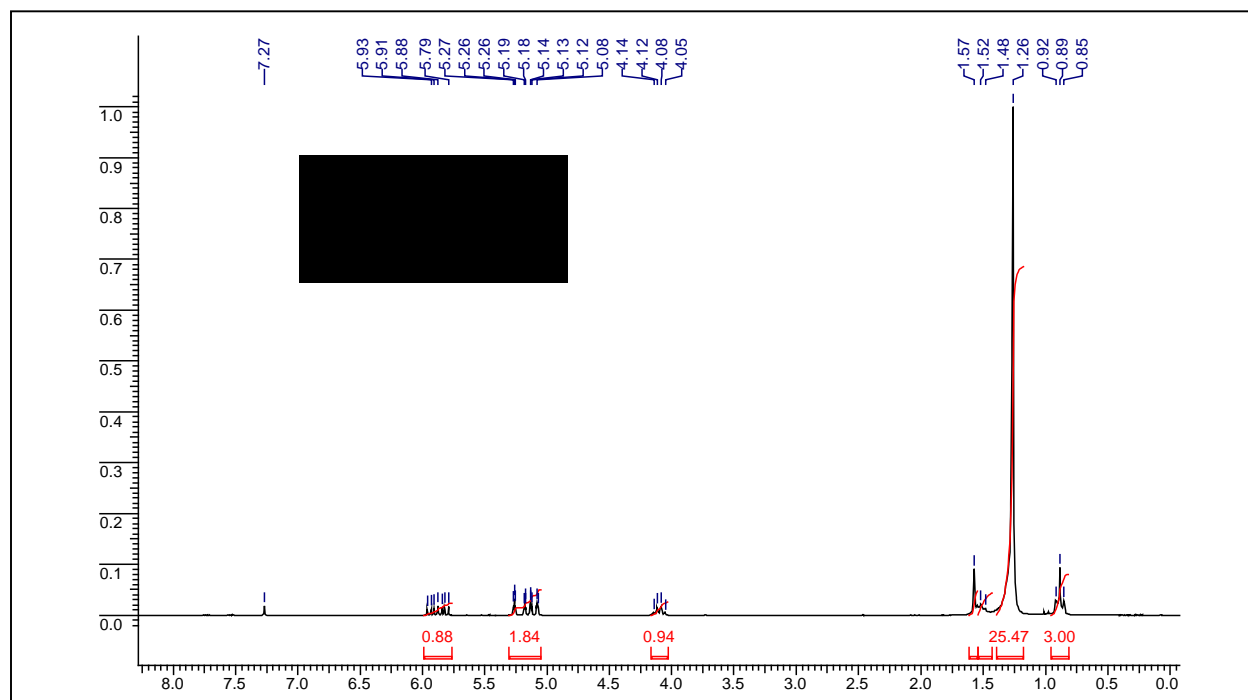

$^1\text{H}$  NMR spectrum of compound 118 in  $\text{CDCl}_3$

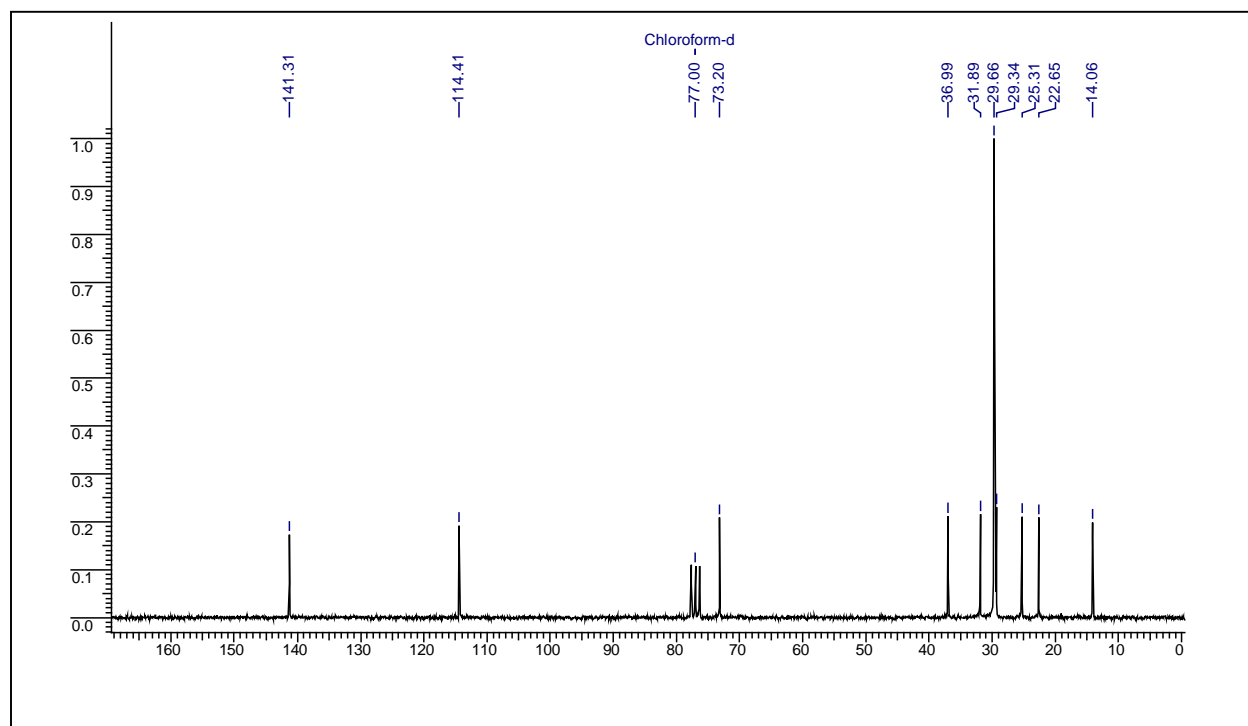

$^{13}\text{C}$  NMR spectrum of compound 118 in  $\text{CDCl}_3$

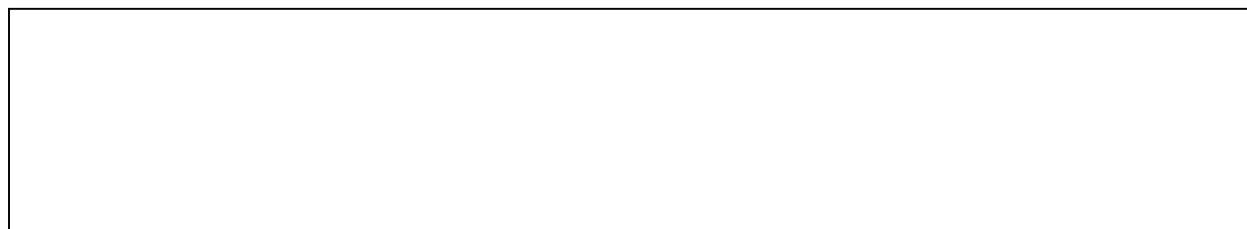

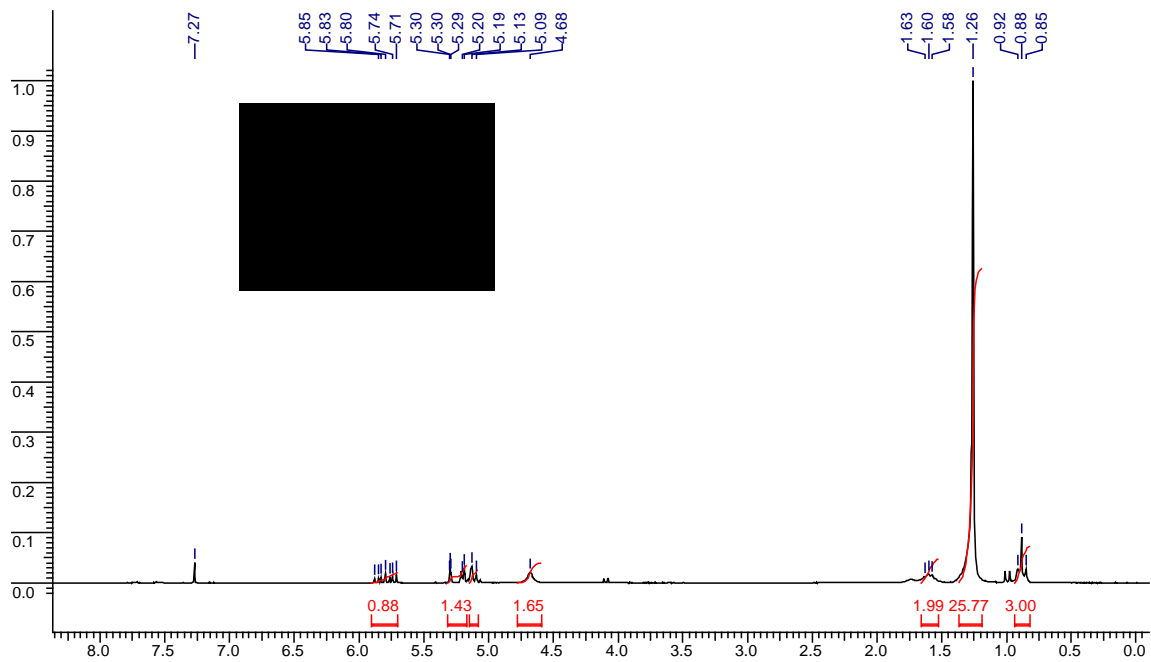

<sup>1</sup>H NMR spectrum of compound 120 in CDCl<sub>3</sub>

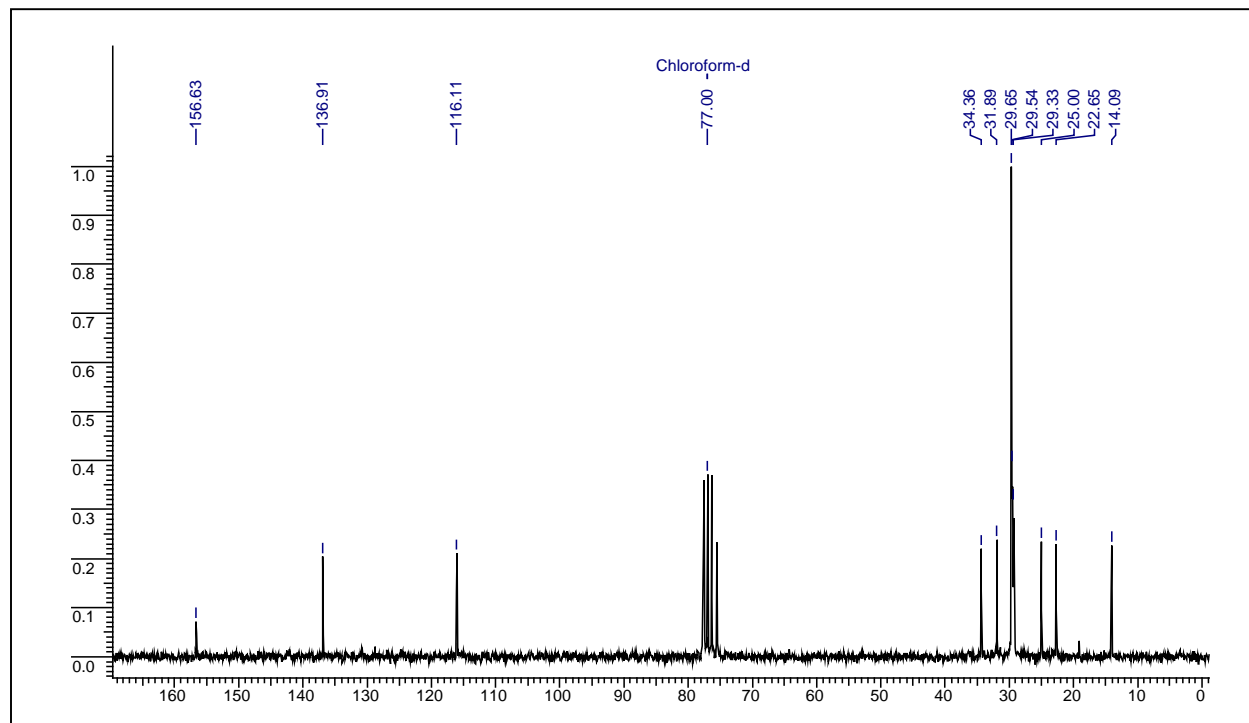

<sup>13</sup>C NMR spectrum of compound 120 in CDCl<sub>3</sub>

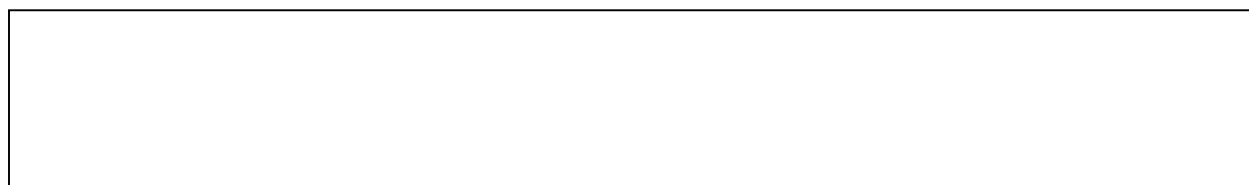

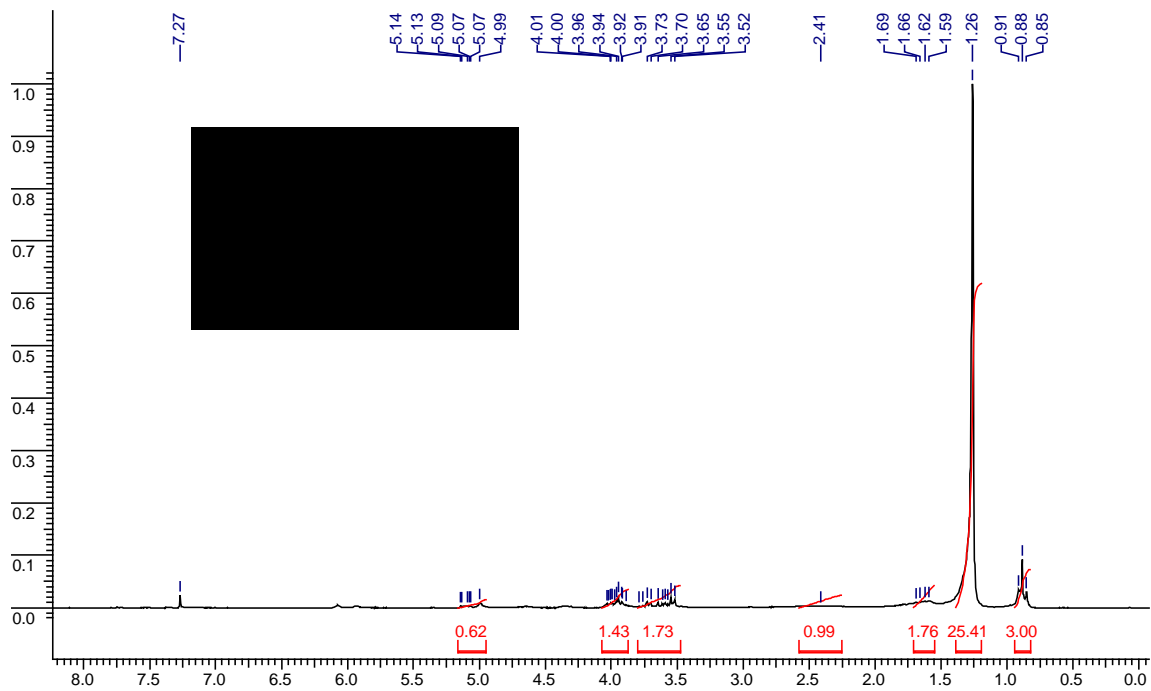

<sup>1</sup>H NMR spectrum of compound 121 in CDCl<sub>3</sub>

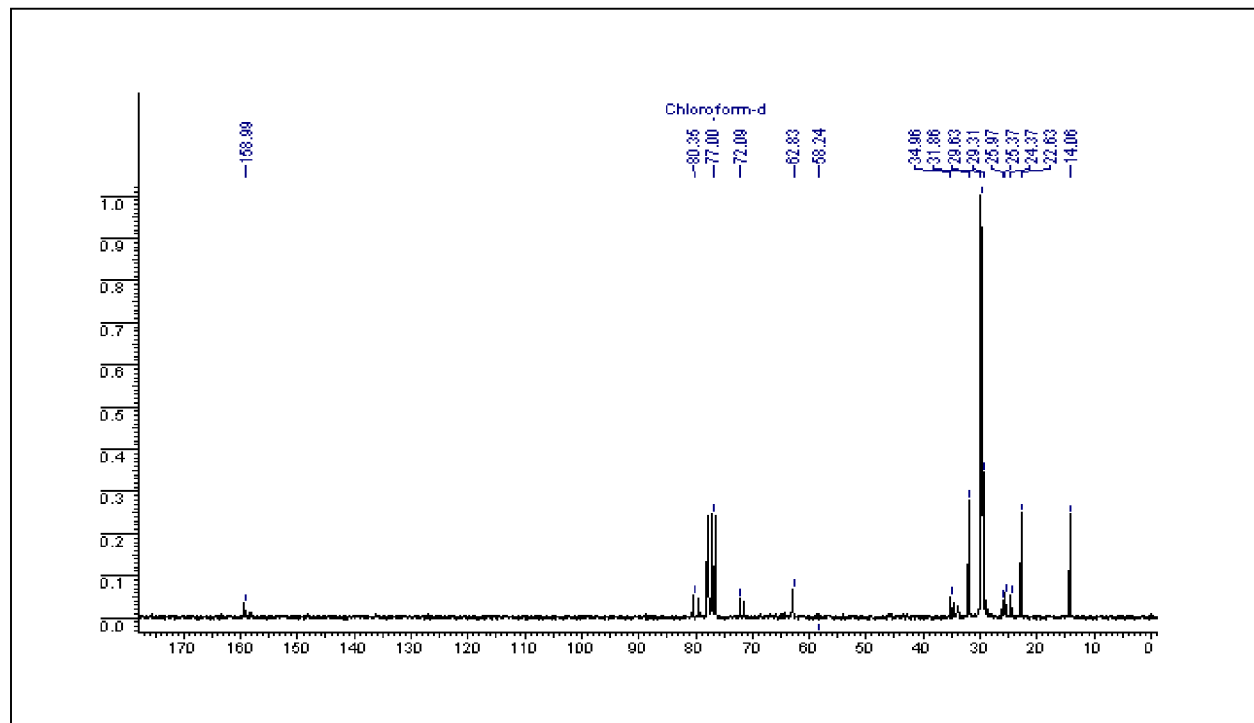

<sup>13</sup>C NMR spectrum of compound 121 in CDCl<sub>3</sub>



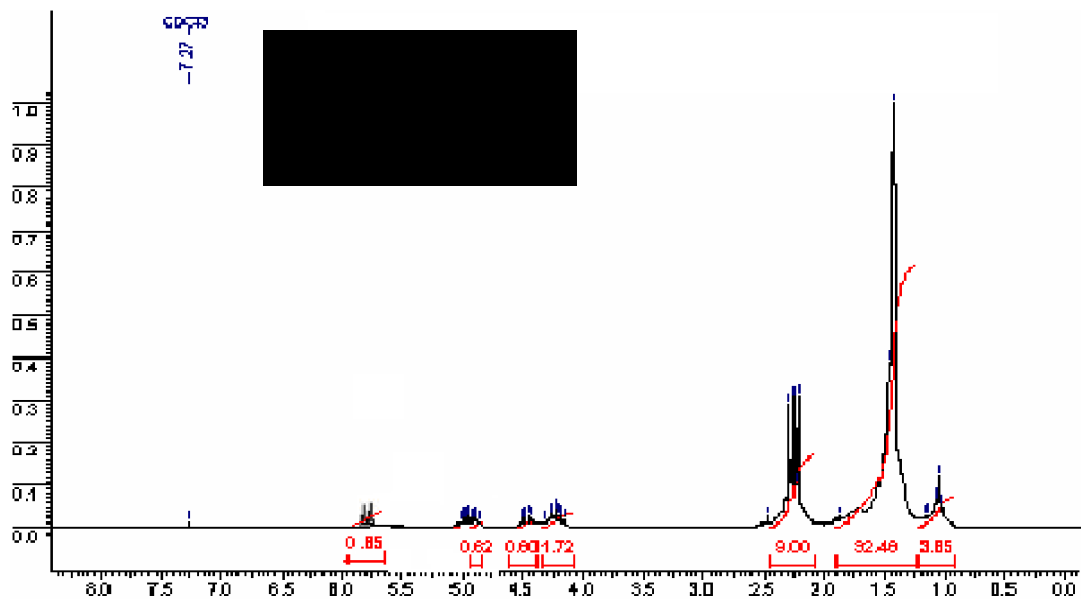

<sup>1</sup>H NMR spectrum of compound 108 in CDCl<sub>3</sub>

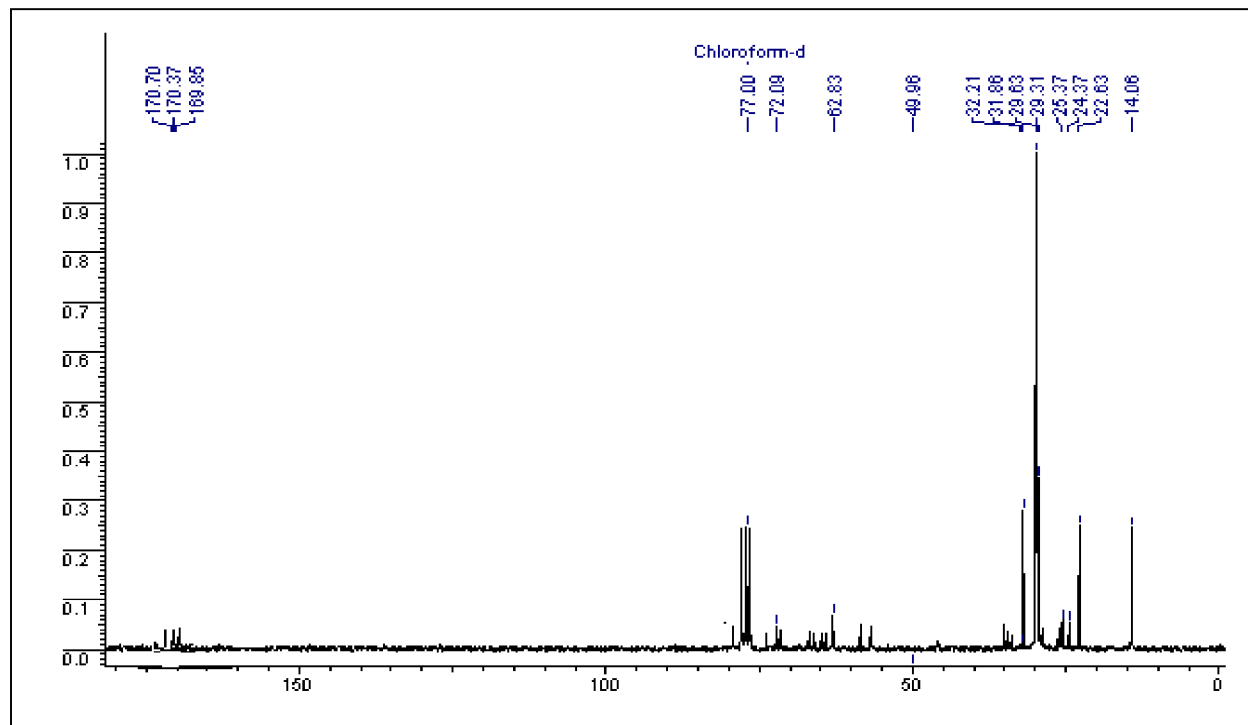

<sup>13</sup>C NMR spectrum of compound 108 in CDCl<sub>3</sub>

#### 4.4 SECTION C: TOTAL SYNTHESIS OF (-)-DEOXOCASSINE

---

---

### 4.4.1 Introduction

Naturally occurring 2,6-(*cis* or *trans*)-disubstituted 3-piperidinols, such as prosopis and cassia alkaloids,<sup>59</sup> have received much attention owing to a variety of their biological activities. Some cassia species (Leguminosae) like cassia excelsa and carnalis contain piperidinol alkaloids (cassine, carnaline, prosopinone).<sup>60</sup> Several papers have been published on the stereochemistry and synthesis of these alkaloids and their derivatives.<sup>61</sup> Many of these compounds possess pharmacological properties.<sup>62</sup>

All *cis*-2,6-disubstituted 3-piperidinols such as cassine or its analogues (**Fig. 9**) display interesting naturally occurring structures with three centers of asymmetry in the piperidine ring.<sup>63</sup> After discovery and structure elucidation of different 3-piperidinol alkaloids, much effort has been directed towards efficient, stereoselective syntheses of this class of compounds owing to the variety of their biological activities and the difficulty in isolating these compounds in pure form from natural sources.<sup>64</sup>

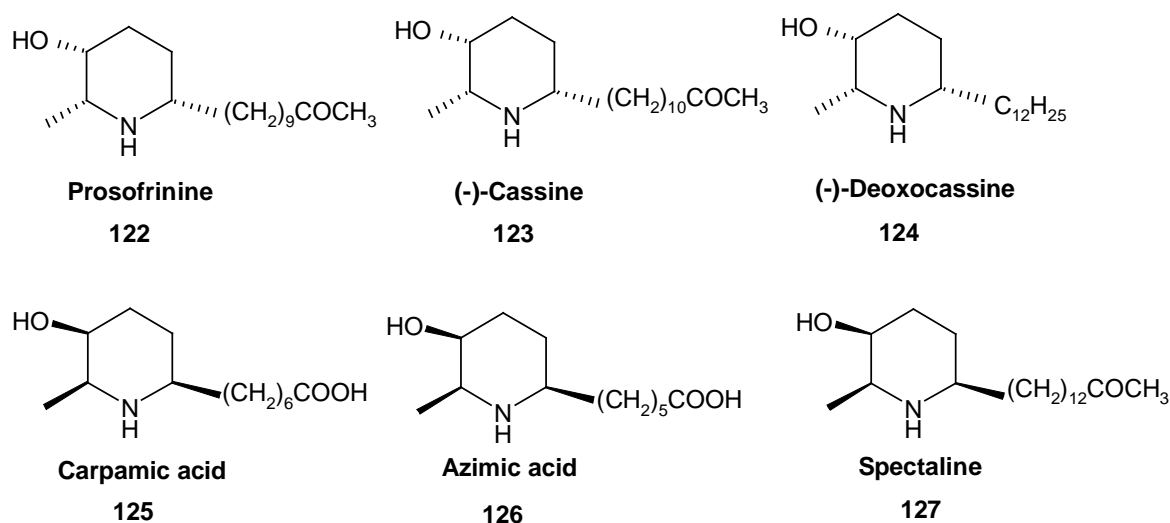

Fig. 9

### 4.4.2 Review of Literature

A number of synthetic routes have been reported in the literature for *cis*-2,3,6-trisubstituted piperidinols.

Very recent and interesting methods of (-)-deoxocassine **124** are discussed below.

**Albert Padwa (2004)**<sup>65</sup>

Albert Padwa and group (**Scheme 24**) developed a general strategy for the synthesis of *cis*-2,3,6-trisubstituted piperidinols utilizing aza-Achmatowicz oxidation as the key step. Commercially available furyl sulfonamide **128** was subjected to an oxidation ring expansion to furnish **129**.

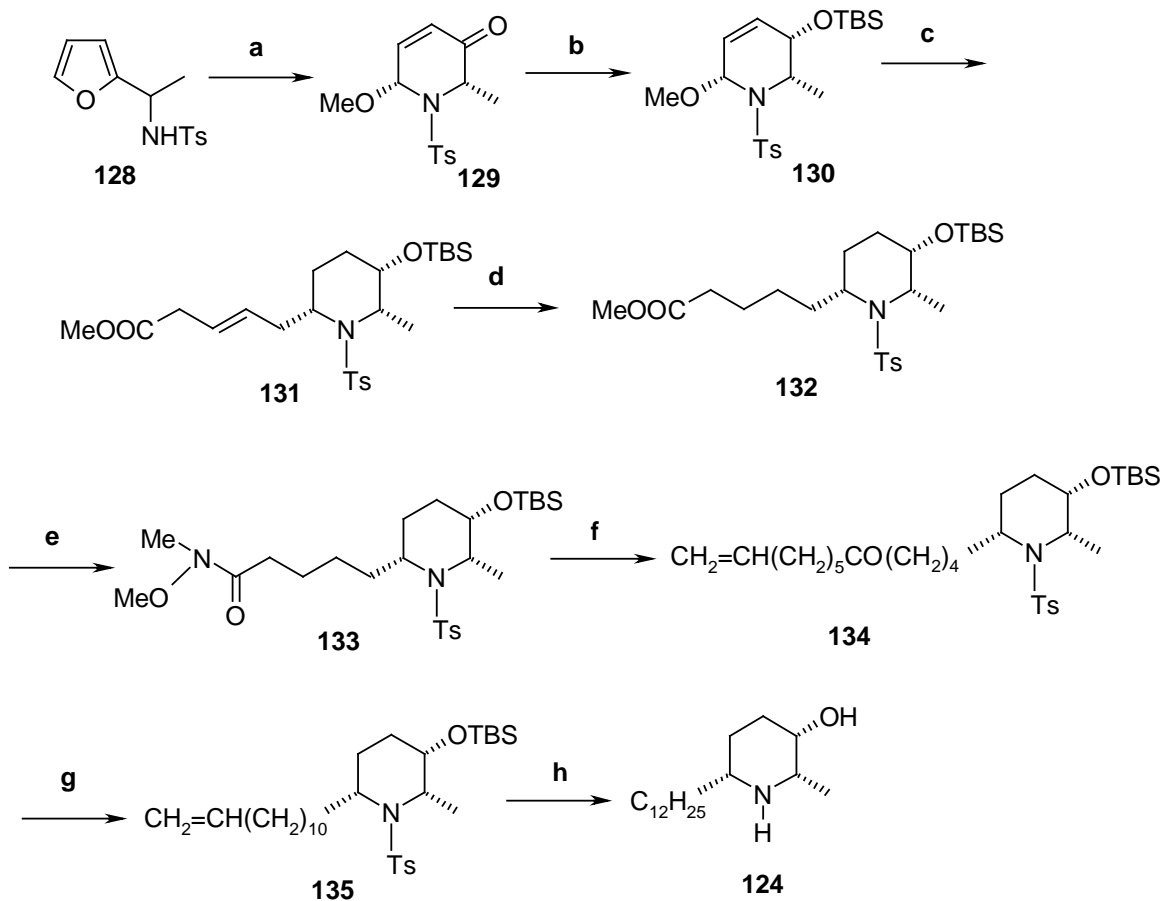

**Scheme 24**

**Scheme 24 : Reaction conditions :** (a) *m*CPBA, HCOO(OMe)<sub>3</sub>, BF<sub>3</sub>·OEt<sub>2</sub>, 85% ; (b) (i) NaBH<sub>4</sub>, CeCl<sub>3</sub>, MeOH, -40 °C ; (ii) TBSCl, DMAP, CH<sub>2</sub>Cl<sub>2</sub>, 25 °C ; (c) methyl-3-(trimethylsilyl)-4-pentenoate, BF<sub>3</sub>·OEt<sub>2</sub>, CH<sub>2</sub>Cl<sub>2</sub>, -78 °C ; (d) H<sub>2</sub>, PtO<sub>2</sub>, MeOH ; (e) (MeNHCOMe).HCl, <sup>i</sup>-PrMgCl, THF, -20 °C ; (f) CH<sub>2</sub>=CH(CH<sub>2</sub>)<sub>5</sub>I, *t*-BuLi, heptane, -78 °C ; (g) (i) TsNHNH<sub>2</sub>, EtOH, 25 °C ; (ii) DIBAL-H, NaOH, CH<sub>2</sub>Cl<sub>2</sub>, 0 °C ; (h) Li, NH<sub>3</sub>, THF, -78 °C.

Reduction of **129** with NaBH<sub>4</sub> in the presence of CeCl<sub>3</sub>·7H<sub>2</sub>O stereoselectively produced alcohol which was protected as the TBS ether followed by reaction with methyl-3-(trimethylsilyl)-4-pentanoate in the presence of BF<sub>3</sub>·OEt<sub>2</sub> to give the somewhat labile allylic ester **131**, which was immediately hydrogenated to give the key intermediate **132**. The ester functionality present in piperidine **132** was converted into the

corresponding Weinreb amide. Subsequent treatment of **133** with 6-heptenyllithium provided **134**. Ketone **134** was converted to the corresponding tosyl hydrazone and then treated with DIBAL-H/NaOH to afford **135**. Finally, reduction of double bond and deprotection of tosyl in **135** provided **124**.

**Huang *et al.* (2004)<sup>66a</sup>**

The approach explains general strategy to (5*S*,6*R*)-6-alkyl-5-benzyloxy-2-piperidinones based on the regio- and diastereoselective reductive alkylation of (*S*)-3-benzyloxyglutarimide **136**. Addition of methylmagnesium iodide to **136** yielded **137**. Subsequently, the diastereomers of **137** were reduced with an excess of triethyl silane to provide **138**. Reduction of **138** followed by one-pot carbamation-debenzylation of **138** and the free hydroxyl group protection as silyl ether furnished **140**. To introduce the C-6 side chain of (-)-deoxocassine, Beak's reaction was performed on **140** to give **141** which on isomerisation led to **142**. Compound **142** was treated with corresponding Wittig reagent to give olefin **144**. Hydrogenation of **144** followed by deprotection and inversion of the configuration at C-3 by Swern oxidation followed by L-selectride reduction provided **145** as the only diastereomer. Finally, deprotection of **145** under acidic conditions afforded the desired (-)-deoxocassine **124**.



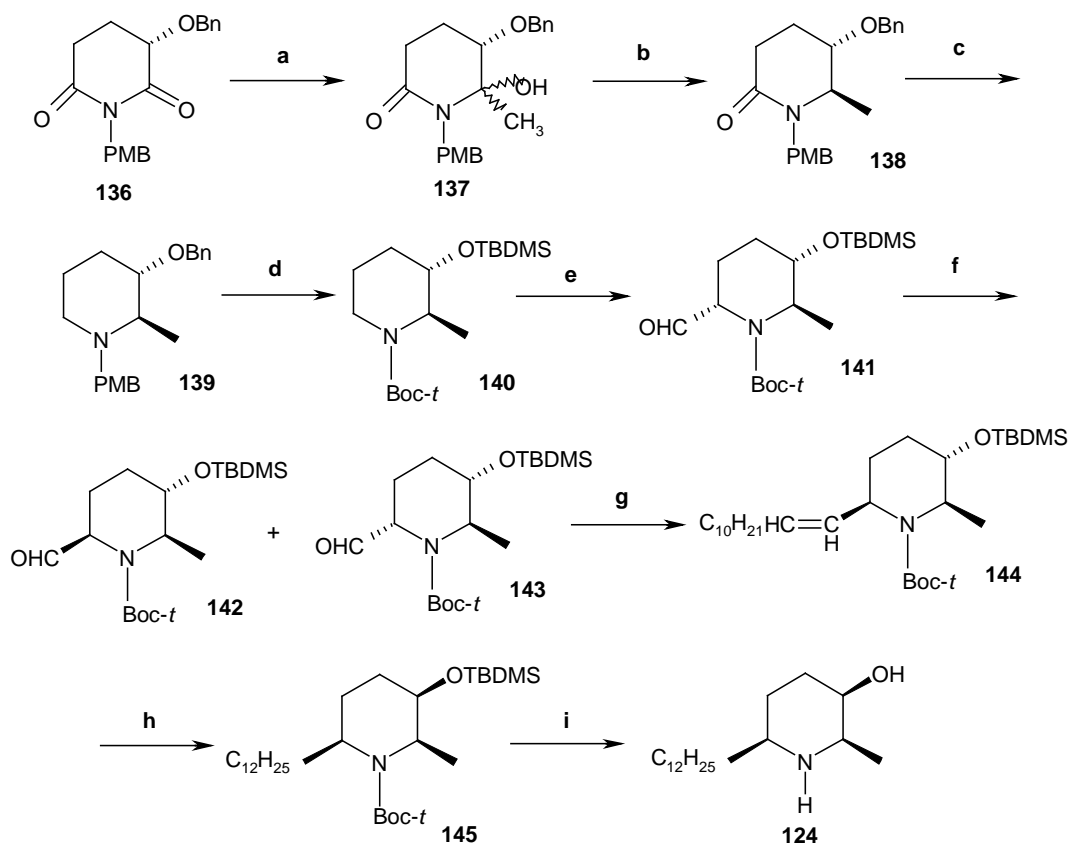

**Scheme 25 : Reaction conditions :** (a)  $\text{CH}_3\text{MgI}$ , THF,  $-78^\circ\text{C}$ , 95% ; (b)  $\text{Et}_3\text{SiH}$ ,  $\text{BF}_3\cdot\text{OEt}_2$ ,  $\text{CH}_2\text{Cl}_2$ ,  $-78^\circ\text{C}$ , 95% ; (c) LAH, rt, 3 h,  $45^\circ\text{C}$ , 1 h, 84% ; (d) (i)  $\text{H}_2$ ,  $\text{Pd}(\text{OH})_2/\text{C}$ ,  $(\text{Boc})_2\text{O}$ , 72 h ; 10%  $\text{Pd}(\text{OH})_2$ , 10 h, 79% ; (ii) TBSCl, DMF, imidazole, 98% ; (e) *s*-BuLi,  $\text{Et}_2\text{O}$ , TMEDA, DMF,  $-78^\circ\text{C}$ , 72% ; (f)  $\text{SiO}_2$ ,  $\text{Et}_3\text{N}$ , rt, 72 h, 76% ; (g)  $\text{C}_{11}\text{H}_{23}\text{P}^+\text{Ph}_3\text{Br}^-$ , *n*-BuLi, 75% ; (h) (i)  $\text{H}_2$ , Pd/C ; (ii) TBAF, THF, 100% ; (ii) DMSO,  $(\text{COCl})_2$ ,  $\text{Pr}_2\text{NEt}$ ,  $\text{CH}_2\text{Cl}_2$ ,  $-78^\circ\text{C}$ - $10^\circ\text{C}$ , 63% ; (iii) L-selectride, THF,  $-78^\circ\text{C}$ , 100% ; (i) HCl, MeOH, rt, 15 h, 96%.

**Nan Ma et al. (2003)<sup>66b</sup>**

Nan Ma and his group described the total synthesis of (-)-deoxocassine using chiral auxiliary based approach. Enantiopure  $\beta$ -amino ester **147** was prepared from 2-tetradecanoic acid methyl ester according to the known procedure.<sup>67</sup> Reduction of the enantiopure  $\beta$ -amino ester **147** provided  $\gamma$ -amino alcohol **148** which was condensed with 2, 4-pentadione to afford **149**. Stepwise cyclization of **149** produced the cyclic enamine **150** which was hydrogenated to deliver all *cis*-2,3,6-trisubstituted piperidine **151**. Subsequent Bayer-Villiger oxidation of **151** gave the corresponding ester, which was hydrolyzed under acidic conditions to deliver **124**.

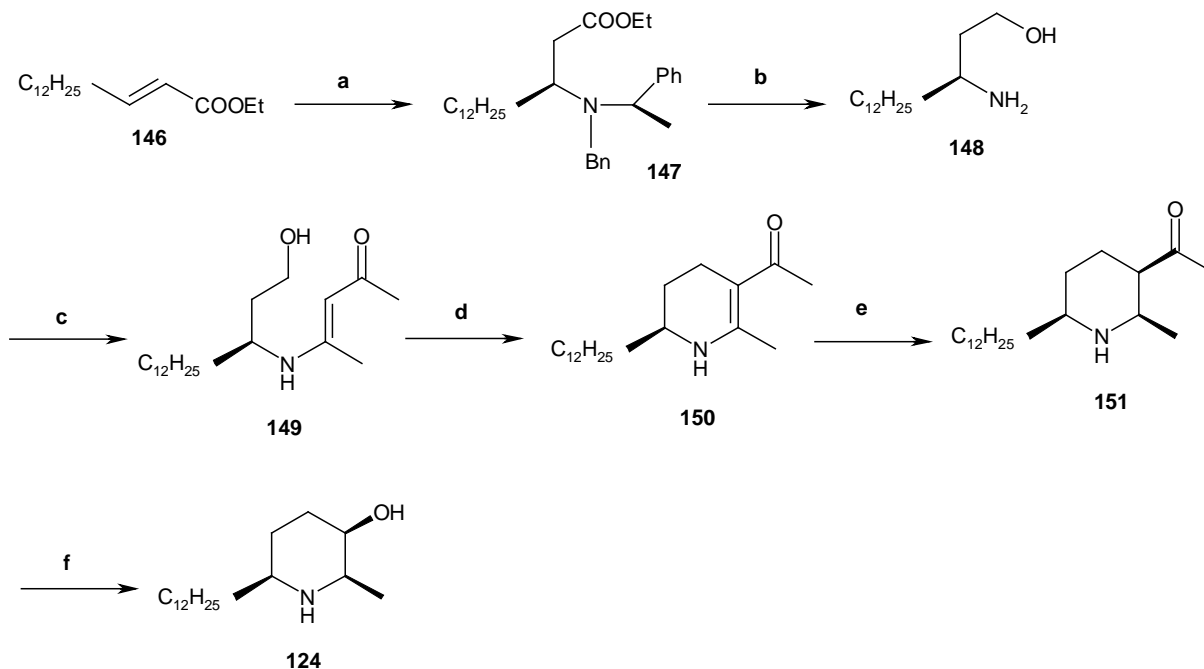

**Scheme 26**

**Scheme 26 : Reaction conditions :** (a) PhCH(CH<sub>3</sub>)NHBn, *n*-BuLi, THF, 88% ; (b) (i) LAH, THF, 0 °C-rt ; (ii) Pd(OH)<sub>2</sub>/H<sub>2</sub>, MeOH, 60 atm, 60 °C ; (c) 2,4-pentadione, toluene, reflux, 74% ; (d) CBr<sub>4</sub>, PPh<sub>3</sub>, Et<sub>3</sub>N, CH<sub>2</sub>Cl<sub>2</sub>, 0 °C-rt then 1.1 equivi. Et<sub>3</sub>N, CH<sub>3</sub>CN, 80-85 °C ; (e) (i) PtO<sub>2</sub>/H<sub>2</sub>, AcOH ; (ii) (CF<sub>3</sub>CO)<sub>2</sub>O, Et<sub>3</sub>N, DMAP, 71% ; (f) (i) 95% H<sub>2</sub>O<sub>2</sub>, (CF<sub>3</sub>CO)<sub>2</sub>O, Na<sub>2</sub>HPO<sub>4</sub>, CH<sub>2</sub>Cl<sub>2</sub> ; (ii) HCl/MeOH, 45%.

### 4.4.3 Present work

#### Objective

Many research groups have developed various general strategies for the synthesis of 2,6-(*cis* or *trans*)-disubstituted 3-piperidinols. Many of them involves multisteps or chirality has been derived either from amino alcohol or sugar moiety. Due to the variety of biological activities of these alkaloids, a straightforward asymmetric synthesis is still desirable. We have demonstrated general strategy for the synthesis of all *cis*-2,6-disubstituted-3-hydroxy piperidinols utilizing Sharpless asymmetric aminohydroxylation as the source of chirality. Retrosynthetic analysis of (-)-deoxocassine **124** is shown in **Scheme 27**.

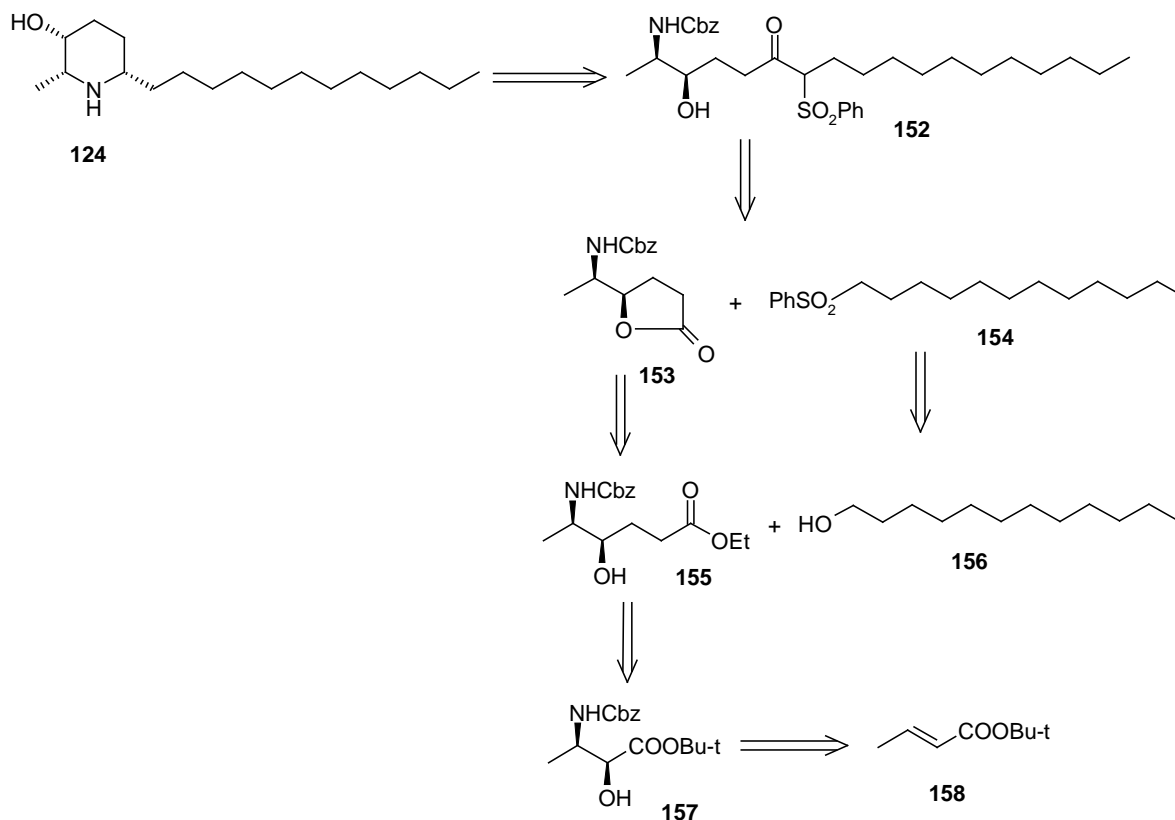

**Scheme 27 : Retrosynthetic analysis of (-)-deoxocassine**

The basic skeleton of **124** could be derived from **152** which in turn would be obtained from fragments **153** and **154**. Lactone **153** could be derived from amino hydroxy ester **155** which in turn would be obtained from the Sharpless asymmetric aminohydroxylation of *t*-butyl crotonate **158**. Sulfone fragment **154** could be derived from the commercially available alcohol **156**.

#### 4.4.4 Results and Discussion

The synthesis of (-)-deoxocassine **124** started from commercially available *t*-butyl crotonate. As shown in **Scheme 28** *t*-butyl crotonate **158** was subjected to Sharpless asymmetric aminohydroxylation<sup>68</sup> using benzyl carbamate as nitrogen source, potassium osmate as oxidant and (DHQD)<sub>2</sub>PHAL as chiral ligand in *n*-propanol:water (1:1) as solvent system to give the amino alcohol **157** in good yield. Compound **157** was fully characterized using spectroscopic methods. The IR spectrum of **157** showed hydroxyl, amine and carbonyl stretching at 3504, 3326 and 1722 cm<sup>-1</sup> respectively. In the <sup>1</sup>H and <sup>13</sup>C NMR spectrum, olefin

peaks disappeared and  $-\text{CH}(\text{OH})$  and  $-\text{CH}(\text{NHCbz})$  proton and carbon peaks appeared at  $\delta$  4.0 (d), 4.23-4.31 (m) and 66.4, 73.2 respectively. Subsequently, the free hydroxyl group of **157** was protected as silyl ether using TBSCl, imidazole and catalytic amount of DMAP in dry DCM to give **159**. The IR spectrum of **159** showed absence of hydroxyl absorption and in the  $^1\text{H}$  NMR spectrum TBS peaks appeared at  $\delta$  0.12 (s), 0.13 (s) and 0.96 (s). Our next aim was to synthesize the key intermediate **160**. Thus, the ester group of **159** was reduced to the corresponding aldehyde using one equivalent of DIBAL-H at  $-78^\circ\text{C}$  in dry DCM followed by Wittig olefination to give the  $\alpha, \beta$ -unsaturated ester **160** in good yield. Compound **160** was thoroughly characterized using normal spectroscopic methods. The  $^1\text{H}$  NMR spectrum of **160** gave olefinic peaks at  $\delta$  6.10 (dd) and 6.94 (dd).

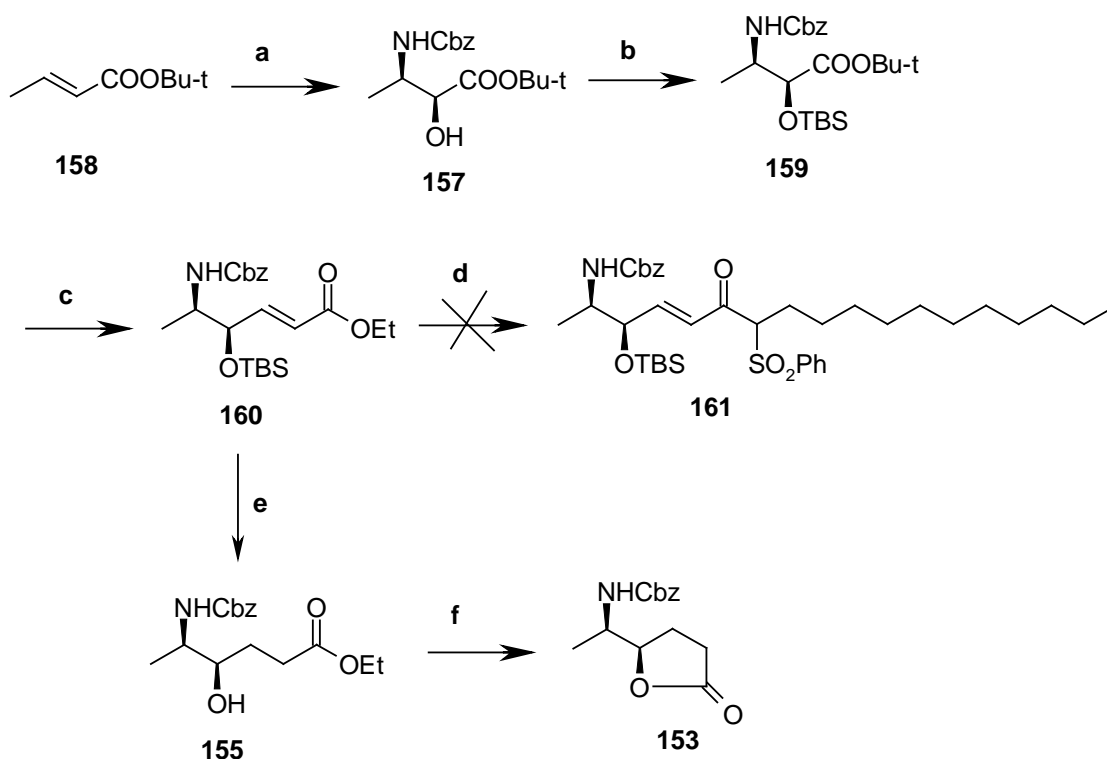

**Scheme 28**

**Scheme 28 : Reaction conditions :** (a) *t*-BuOCl, NaOH, Benzyl carbamate, (DHQD)<sub>2</sub>PHAL, *n*-PrOH:H<sub>2</sub>O, 5 h, 67% ; (b) TBSCl, imidazole, DMAP (cat), dry DCM, 67% ; (c) (i) DIBAL-H, dry DCM,  $-78^\circ\text{C}$ , 1 h ; (ii)  $\text{Ph}_3\text{P}=\text{CHCOOEt}$ , dry THF, rt, 24 h, 73%; (d) **154**, *n*-BuLi, dry THF,  $-78^\circ\text{C}$  ; (e) (i) 10% Pd/C, MeOH, 6 h, ; (ii) CbzCl, Et<sub>3</sub>N, dry DCM, 12 h, 78%; (f) *p*-TSA, MeOH, 30 min.76%.

To introduce the C12-long chain at C-6 position of (-)-deoxocassine **124** we have synthesized sulfone moiety **154** as shown in **Scheme 29**. Dodecane-1-ol **156** was treated with CBr<sub>4</sub> and TPP in dry DCM to give bromo compound **162** which was treated with PhSO<sub>2</sub>Na in dry DMF to furnish **154** in excellent yield.

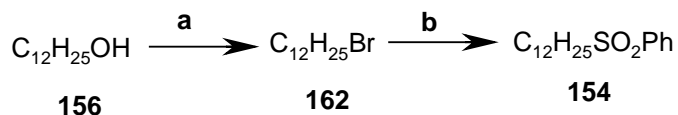

**Scheme 29**

**Scheme 29 : Reaction conditions :** (a) CBr<sub>4</sub>, TPP, dry DCM, 2 h, 85% ; (b) PhSO<sub>2</sub>Na, dry DMF, 6 h, 97%.

To arrive at the target molecule **124** we then coupled the ester **160** and sulfone **154** using different types of bases like *n*-BuLi, NaH and LDA in dry THF but we met with failures. We then thought of employing a more reactive electrophile such as **153** as a coupling substrate in place of  $\alpha$ ,  $\beta$ -unsaturated ester **160**. The lactone **153** can be prepared from **160** simply by double bond reduction and subsequent cyclization. Accordingly the double bond of **160** was reduced using 10% Pd/C in methanol under hydrogen atmosphere which led to an intermediate resulting through concomitant deprotection of TBS and Cbz group. The free amine was again protected as –NHCbz using benzyloxy carbonyl amine and triethyl amine as a base in dry DCM to give the saturated ester **155**. The IR and <sup>1</sup>H NMR spectra of **155** showed absence of olefin peaks. Compound **155** was treated with 10 mol% *p*-TSA in methanol to afford the lactone **153** in good yield. The <sup>1</sup>H and <sup>13</sup>C NMR spectra of **153** clearly indicated the absence of ethyl ester peaks.

Alternatively, lactone **153** could be prepared starting from easily available starting material sorbate **162** and following a sequence of reaction as illustrated in **Scheme 30**. Thus, monodihydroxylation<sup>69</sup> of **162** using osmium tetroxide as oxidant and (DHQD)<sub>2</sub>PHAL as chiral ligand gave diol **163** in good yield as well as in excellent enantioselectivity. The <sup>1</sup>H and <sup>13</sup>C NMR spectra of **163** showed absence of one olefin system and two chiral protons and carbons appeared at 3.63-3.76 (m), 4.03 (ddd) and 70.0, 75.3 respectively. Subsequently the olefinic double bond **163** was reduced to the corresponding saturated system **164** using 10% Pd/C in methanol under hydrogen atmosphere. The IR, <sup>1</sup>H and <sup>13</sup>C NMR spectra of **164** clearly indicated the disappearance of olefin. Compound **164** was treated with 10 mol% *p*-TSA in methanol to give lactone **165** in good yield. The <sup>1</sup>H and <sup>13</sup>C NMR spectra of **165** showed the absence of ethyl peaks and lactone –CH(O) proton shift to downfield 4.27-4.37 (m) compared to –CH(OH) proton of **164**. The aim

was to achieve the *syn* azido lactone **167** which was proved to be good electrophile in the synthesis. Towards this, lactone **165** was treated with methanesulfonyl chloride, triethyl amine and catalytic amount of DMAP in dry DCM to give –OMs product which was treated with NaI in acetone under reflux conditions to give iodolactone **166** in moderate yield. Subsequently iodolactone **166** was treated with NaN<sub>3</sub> in dry DMF at 70 °C to give azide **167** which was treated with TPP in THF:H<sub>2</sub>O to afford free amine which was protected as –NHCbz using benzyloxycarbonyl chloride and triethyl amine to furnish **153**. Compound **153** prepared through both dihydroxylation and aminohydroxylation approach (**Scheme 28**) have shown similar physical and chemical properties.

To achieve the synthesis of target molecule **124**, opening of the lactone **153** was carried out with **154** using *n*-BuLi as base in dry THF at -78 °C as shown in **Scheme 31**. Compound **152** was treated with 6% Na/Hg in dry methanol at -20 °C to give desulfurization product **168**. The <sup>1</sup>H NMR spectrum of **168** showed absence of –SO<sub>2</sub>Ph peaks. Finally, compound **168** was cyclized to the target compound (-)-deoxocassine **124** using 20% Pd(OH)<sub>2</sub> under hydrogenation conditions. (-)-Deoxocassine was fully characterized by IR, <sup>1</sup>H NMR, <sup>13</sup>C NMR and elemental analysis. The physical and spectroscopic data were in accord with those described in literature.<sup>66b</sup>

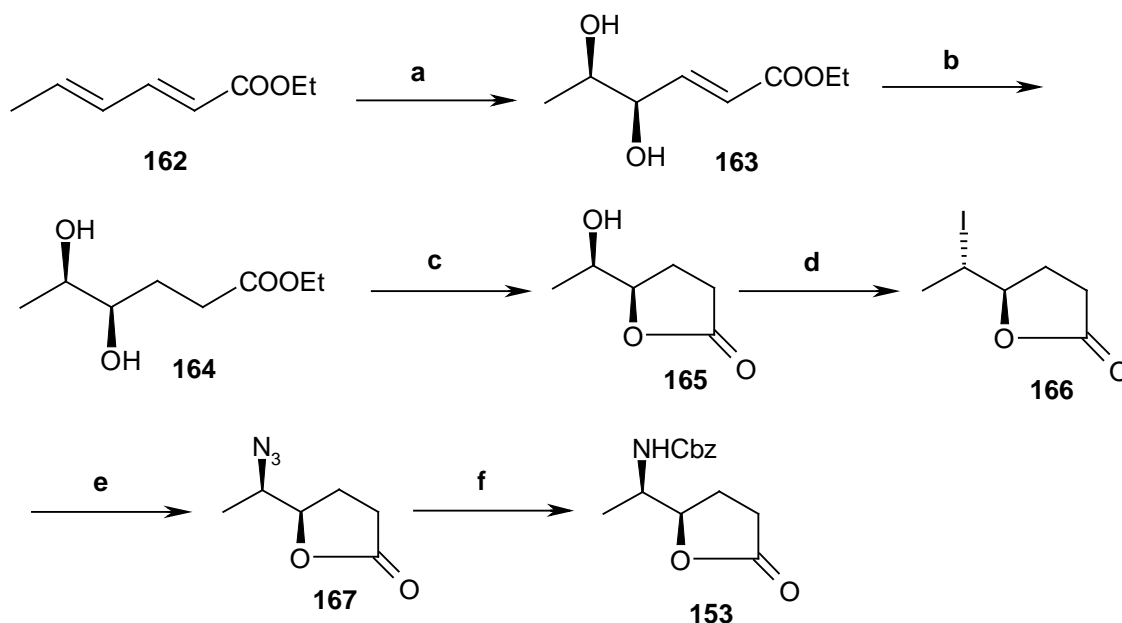

**Scheme 30**

**Scheme 30 : Reaction conditions :** (a) (DHQD)<sub>2</sub>PHAL, OsO<sub>4</sub>, CH<sub>3</sub>SO<sub>2</sub>NH<sub>2</sub>, K<sub>3</sub>Fe(CN)<sub>6</sub>, K<sub>2</sub>CO<sub>3</sub>, *t*-BuOH:H<sub>2</sub>O (1:1), 24 h, 0 °C, 84%; (b) 10% Pd/C, MeOH, 1 h, 99%; (c) 10% *p*-TSA, MeOH, 30 min, rt,

83%; (d) (i)  $\text{CH}_3\text{SO}_2\text{Cl}$ ,  $\text{Et}_3\text{N}$ , DMAP, dry DCM, rt, 30 min; (ii)  $\text{NaI}$ , acetone, reflux, 24 h, 60%; (e)  $\text{NaN}_3$ , dry DMF, 70 °C, 74%; (f) (i) TPP,  $\text{THF}:\text{H}_2\text{O}$ , 24 h, ; (ii)  $\text{CbzCl}$ ,  $\text{Et}_3\text{N}$ , dry DCM, 12 h, 73%.

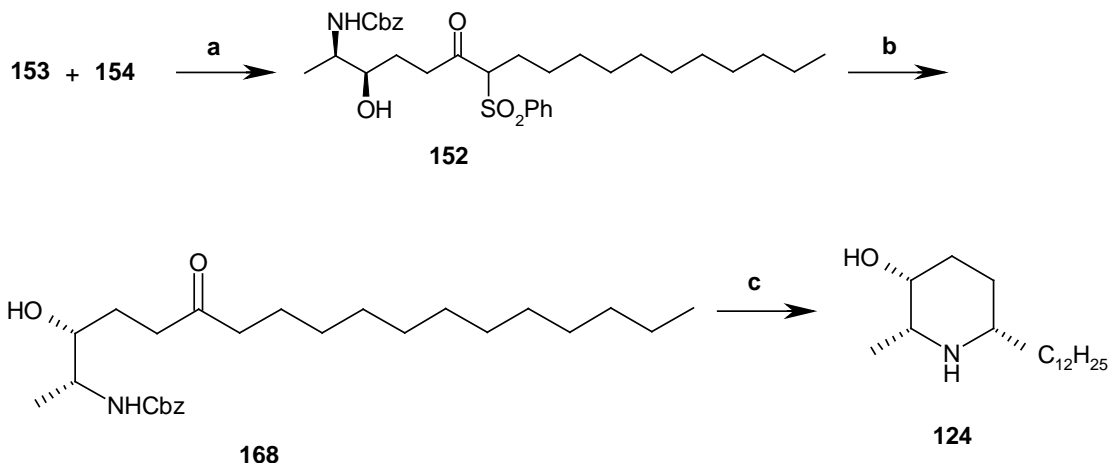

**Scheme 31 : Reaction conditions :** (a)  $n\text{-BuLi}$ , dry THF,  $-78\text{ }^\circ\text{C}$ , 1 h, 80% ; (b) 6%  $\text{Na-Hg}$ , dry MeOH,  $-20\text{ }^\circ\text{C}$ , 3 h, 72% ; (c) 20%  $\text{Pd}(\text{OH})_2$ , dry MeOH, 24 h, 100%.

#### 4.4.5 Conclusion

In conclusion, enantioselective synthesis of (-)-deoxocassine was accomplished using Sharpless asymmetric aminohydroxylation as the key step.

#### 4.4.6 Experimental section

##### General information

Solvents were purified and dried by standard procedures before use. Petroleum ether of boiling range  $60\text{-}80^\circ\text{C}$  was used. Melting points are uncorrected. Optical rotations were measured using the sodium D line of a JASCO-181 digital polarimeter. Infrared spectra were recorded with an ATI MATSISON RS-1 FT-IR spectrometer.  $^1\text{H}$  NMR and  $^{13}\text{C}$  NMR spectra were recorded with a Bruker AC-200 spectrometer. Elemental analyses were carried out with a Carlo Erba CHNS-O analyzer.

##### Preparation of (2*R*,3*S*)-*tert*-Butyl-2-Hydroxy-3-(*N*-benzyloxycarbonyl)-aminobutanoate

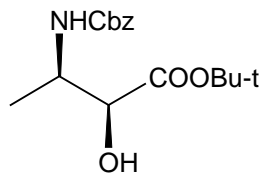

**157**

Benzyl carbamate (6.6 g, 43.60 mmol) was dissolved in 56 mL of *n*-propyl alcohol in a single-necked round bottom flask (250 mL) equipped with a magnetic stir bar. To this stirred solution was added a freshly prepared solution of NaOH (1.71 g, 42.89 mmol) in 105 mL of water, followed by freshly prepared *tert*-butyl hypochlorite (4.7 mL, 42.89 mmol). Next, a solution of the ligand (DHQD)<sub>2</sub>PHAL (0.54 g, 5 mol%) in 49 mL of *n*-propyl alcohol was added. The reaction mixture was homogeneous at this point. The vial was then immersed in a room temperature water bath and stirred for 3 min, and the *tert*-butyl crotonate **158** (2.0 g, 14.06 mmol) was added followed by the osmium catalyst (K<sub>2</sub>O<sub>8</sub>O<sub>2</sub>(OH)<sub>4</sub>) (0.20 g, 4 mol%). The reaction mixture was stirred until consumption of the starting material and when the light green color turned to light yellow. After completion of reaction, 30 mL of ethyl acetate was added and the phases were separated. The lower aqueous phase was extracted with ethyl acetate (4x60 mL). The combined organic layers were washed with brine, dried (Na<sub>2</sub>SO<sub>4</sub>) and concentrated to near dryness to afford the crude product which was contaminated with excess of benzyl carbamate. Purification by flash chromatography using ethyl acetate:petroleum ether (4:6) as eluent provided **157** (2.92 g) as a white solid.

**Yield :** 67%

**M.p :** 82-85 °C

$[\alpha]_D^{25}$  : -9.7 (*c* 0.34, CHCl<sub>3</sub>)

**IR (CHCl<sub>3</sub>, cm<sup>-1</sup>) :**  $\nu_{\max}$  3522, 3311, 1721, 1692

**<sup>1</sup>H NMR (200 MHz, CDCl<sub>3</sub>) :**  $\delta$  1.26 (d, *J* = 6.6 Hz, 3H), 1.45 (s, 9H), 3.20 (brs, 1H, OH), 3.92-4.01 (m, 1H), 4.23-4.31 (m, 1H), 4.70 (s, 2H), 5.20 (brs, 1H, NH), 7.33-7.39 (m, 5H)

**<sup>13</sup>C NMR (50 MHz, CDCl<sub>3</sub>) :**  $\delta$  18.1, 27.6, 48.9, 64.9, 66.4, 73.2, 83.3, 126.8, 127.4, 127.9, 128.3, 136.3, 155.5, 172.2

**Analysis:** C<sub>16</sub>H<sub>23</sub>NO<sub>5</sub> (309.36) requires. C, 62.12 ; H, 7.49 ; N, 4.53 ; Found. C, 62.10 ; H, 7.46 ; N, 4.50.



Preparation of (2*R*,3*S*)-*tert*-Butyl-2-(*tert*-butyldimethylsilyloxy)-3-(*N*-benzyloxycarbonyl)-aminobutanoate

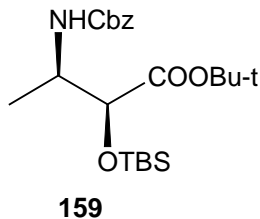

To a stirred solution of alcohol **157** (0.5 g, 1.61 mmol) in dry DCM (10 mL), imidazole (0.11g, 1.61 mmol), TBSCl (0.36 g, 2.42 mmol) and catalytic amount of DMAP were added sequentially. The reaction mixture was stirred at ambient temperature. After TLC diagnosis, water was added to the reaction mixture and aqueous layer was extracted with dichloromethane (3x10 mL) and combined organic layers were washed with brine solution and dried over Na<sub>2</sub>SO<sub>4</sub>. The crude product was purified on silica gel column chromatography using petroleum ether : ethyl acetate (9:1) as eluent to give **159** (0.42 g) as a colorless liquid.

**Yield :** 67%

$[\alpha]_D^{25}$  : -4.6 (*c* 0.56, CHCl<sub>3</sub>)

**IR (CHCl<sub>3</sub>, cm<sup>-1</sup>) :**  $\nu_{\max}$  3392, 1702, 1682

**<sup>1</sup>H NMR (200 MHz, CDCl<sub>3</sub>) :**  $\delta$  0.12 (s, 3H), 0.13 (s, 3H), 0.89 (d, *J* = 5.4 Hz, 3H), 0.96 (s, 9H), 1.46 (s, 9H), 4.13 (t, *J* = 6.6 Hz, 1H), 4.76 (s, 2H), 4.83-4.89 (m, 1H), 5.17 (s, 1H), 7.33-7.38 (m, 5H)

**<sup>13</sup>C NMR (50 MHz, CDCl<sub>3</sub>) :**  $\delta$  -5.4, -5.3, 10.1, 25.3, 25.5, 25.7, 25.9, 64.9, 69.3, 69.6, 125.9, 126.8, 127.5, 128.1, 128.2, 128.3, 128.5, 158.0, 170.2

**Analysis:** C<sub>22</sub>H<sub>37</sub>NO<sub>5</sub>Si (423.62) requires. C, 62.38 ; H, 8.80 ; N, 3.31 ; Found. C, 62.35 ; H, 8.76 ; N, 3.29.

**Preparation of 5-Benzyloxycarbonylamino-4-(*tert*-butyldimethylsilyloxy)-hex-2-enoic acid ethyl ester**

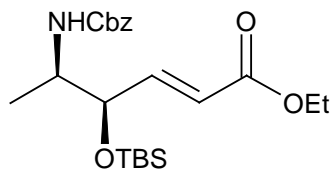

**160**

To a stirred solution of **159** (1.0 g, 2.36 mmol) in dry DCM (10 mL) was added DIBAL-H (2.36 mL, 1M solution in toluene, 2.36 mmol) at  $-78\text{ }^{\circ}\text{C}$  and mixture stirred for 1 h at the same temperature. After completion of the reaction, the reaction mixture was quenched with saturated sodium potassium tartrate (5 mL) and filtered through celite pad and dried over  $\text{Na}_2\text{SO}_4$  and concentrated to near dryness. The crude product was used as such in the next Wittig olefination.

To a stirred solution of (ethoxycarbonylmethylene)triphenyl phosphorane (0.98 g, 2.83 mmol) in dry THF (10 mL) was added the crude aldehyde in dry THF (3 mL) and the reaction mixture stirred for 24 h at room temperature and concentrated to near dryness. The crude product was purified on silica gel column chromatography using ethyl acetate : petroleum ether (2 : 8) as eluent to give **160** (0.62 g) as a light yellow liquid.

**Yield** : 73%

$[\alpha]_{\text{D}}^{25}$  :  $-12.4$  ( $c$  1.0,  $\text{CHCl}_3$ )

**IR** ( $\text{CHCl}_3$ ,  $\text{cm}^{-1}$ ) :  $\nu_{\text{max}}$  3369, 1723, 1682, 1603

**$^1\text{H}$  NMR** (200 MHz,  $\text{CDCl}_3$ ) :  $\delta$  0.06 (s, 3H), 0.08 (s, 3H), 1.12 (s, 9H), 1.23 (t,  $J = 6.4$  Hz, 3H), 1.30 (d,  $J = 7.1$  Hz, 3H), 3.70 (qn,  $J = 6.2$  Hz, 1H), 4.03-4.05 (m, 1H), 4.20 (q,  $J = 7.2$  Hz, 2H), 6.10 (dd,  $J = 15.7$ , 1.6 Hz, 1H), 6.94 (dd,  $J = 15.8$ , 5.2 Hz, 1H), 4.72 (s, 2H), 4.98 (s, 1H), 7.28-7.31 (m, 5H)

**$^{13}\text{C}$  NMR** (50 MHz,  $\text{CDCl}_3$ ) :  $\delta$  -4.3, -3.4, 13.9, 18.7, 20.7, 52.3, 60.5, 70.0, 75.3, 122.0, 126.5, 127.3, 127.9, 140.9, 146.8, 157.2, 166.6

**Analysis**:  $\text{C}_{22}\text{H}_{35}\text{NO}_5\text{Si}$  (421.60) requires. C, 62.67 ; H, 8.37 ; N, 3.32 ; Found. C, 62.63 ;

H, 8.31 ; N, 3.30.

#### Preparation of 5-Benzyloxycarbonylamino-4-hydroxy-hexanoic acid ethyl ester

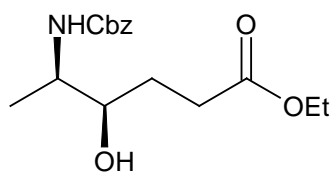

**155**

To a stirred solution of **160** (0.5 g, 1.18 mmol) in dry methanol (10 mL) was added 10% Pd/C (50 mg) and the reaction mixture stirred under hydrogen atmosphere for 24 h. The reaction mixture was filtered through

celite pad and concentrated to near dryness. The crude product thus was obtained dissolved in dry DCM (10 mL). Et<sub>3</sub>N (0.25 mL, 1.78 mmol) and benzyloxycarbonyl chloride (0.22 mL, 1.54 mmol) were added at 0 °C. After consumption of the starting material, the reaction mixture was quenched with water (5 mL) and organic layer was extracted with dichloromethane (3x10 mL) and dried over Na<sub>2</sub>SO<sub>4</sub> and concentrated to near dryness. The crude product was purified on silica gel column chromatography using ethyl acetate : petroleum ether (6 :4) as eluent to give **155** (0.28 g) as a viscous liquid.

**Yield** : 78%

$[\alpha]_D^{25}$  : -32.4 (*c* 0.76, CHCl<sub>3</sub>)

**IR (CHCl<sub>3</sub>, cm<sup>-1</sup>)** :  $\nu_{\max}$  3522, 3306, 1712, 1682

**<sup>1</sup>H NMR (200 MHz, CDCl<sub>3</sub>)** :  $\delta$  1.18 (t, *J* = 6.9 Hz, 3H), 1.20 (d, *J* = 6.4 Hz, 3H), 1.99-2.23 (m, 2H), 2.47-2.58 (m, 2H), 2.99 (brs, 1H), 3.69 (q, *J* = 7.1 Hz, 1H), 3.70-3.76 (m, 1H), 4.29 (q, *J* = 7.3 Hz, 2H), 4.76 (s, 2H), 4.88 (s, 1H), 7.22-7.29 (m, 5H)

**<sup>13</sup>C NMR (50 MHz, CDCl<sub>3</sub>)** :  $\delta$  13.7, 18.7, 27.8, 28.3, 52.5, 57.3, 70.1, 74.6, 127.3, 127.8, 128.8, 140.4, 155.2, 173.8

**Analysis**: C<sub>16</sub>H<sub>23</sub>NO<sub>5</sub> (309.36) requires. C, 62.12 ; H, 7.49 ; N, 4.53 ; Found. C, 62.08 ; H, 7.43 ; N, 4.51.

#### Preparation of [1-(5-Oxo-tetrahydro-furan-2-yl)-ethyl]-carbamic acid benzyl ester

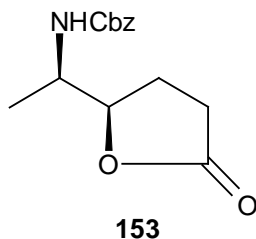

Compound **155** (0.5 g, 1.62 mmol) was dissolved in bottle grade methanol (10 mL) and catalytic amount of *p*-TSA was added to this. The reaction mixture was stirred till completion of the reaction. Saturated sodium bicarbonate solution (3 mL) was added to the reaction mixture and stirred for 5 min. Methanol was removed in vacuo and the aqueous layer was extracted with dichloromethane (3x10 mL), washed with brine solution and dried over Na<sub>2</sub>SO<sub>4</sub> and concentrated to near dryness. The crude product was purified on

silica gel column chromatography using petroleum ether:ethyl acetate (1:1) as eluent to give the lactone **153** (0.32 g) as a light yellow solid.

**Yield :** 76%

**M.p. :** 122-124 °C

$[\alpha]_D^{25}$  : -28.61 (*c* 0.92, CHCl<sub>3</sub>)

**IR (CHCl<sub>3</sub>, cm<sup>-1</sup>) :**  $\nu_{\max}$  3323, 1721, 1696, 1321, 1225, 1032

**<sup>1</sup>H NMR (200 MHz, CDCl<sub>3</sub>) :**  $\delta$  1.20 (d, *J* = 6.8 Hz, 3H), 1.92-2.11 (m, 2H), 2.55 (t, *J* = 8.5 Hz, 2H), 3.84-3.98 (m, 1H), 4.50 (q, *J* = 7.1 Hz, 1H), 5.10 (s, 2H), 5.03 (brs, 1H), 7.31-7.40 (m, 5H)

**<sup>13</sup>C NMR (50 MHz, CDCl<sub>3</sub>) :**  $\delta$  15.3, 23.9, 28.0, 49.4, 66.5, 82.3, 127.7, 128.2, 131.7, 155.7, 176.7

**Analysis:** C<sub>14</sub>H<sub>17</sub>NO<sub>4</sub> (263.29) requires. C, 63.87 ; H, 6.51 ; N, 5.32 ; Found. C, 63.84 ; H, 6.50 ; N, 5.29.

### Preparation of (5*R*,6*R*)-5,6-dihydroxy-2-oxo-hept-3-enoic acid ethyl ester

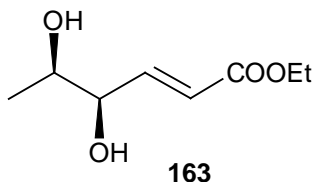

To a mixture of K<sub>3</sub>Fe(CN)<sub>6</sub> (35.20 g, 0.1 mol), K<sub>2</sub>CO<sub>3</sub> (14.76 g, 0.1 mol) and (DHQD)<sub>2</sub>PHAL (278 mg, 1 mol%) in *t*-BuOH-H<sub>2</sub>O (1:1) cooled at 0 °C was added osmium tetroxide (1.43 mL, 0.1 M solution in toluene, 0.4 M mol%) followed by methanesulfonamide (3.38 g, 35.66 mmol). After stirring for 5 min. at 0 °C, olefin **162** (5 g, 35.66 mmol) was added in one portion. The reaction mixture was stirred at 0 °C for 12 h and then quenched with solid sodium sulfite (5 g). The stirring was continued for an additional 45 min. and then the solution was extracted with ethyl acetate (5x100 mL). The combined organic phases were washed with 10% aq. KOH, brine, dried (Na<sub>2</sub>SO<sub>4</sub>) and concentrated. Silica gel column chromatography of the crude product using pet. ether:EtOAc (7:3) as eluent gave the diol **163** (5.2 g) as a light yellow oil.

**Yield :** 84%

$[\alpha]_D^{25}$  : +15.87 (*c* 1.1, CHCl<sub>3</sub>)

**IR (CHCl<sub>3</sub>, cm<sup>-1</sup>) :**  $\nu_{\max}$  3544, 3469, 1720, 1619

$^1\text{H NMR}$  (200 MHz,  $\text{CDCl}_3$ ) :  $\delta$  1.2 (d,  $J = 6.5$  Hz, 3H), 1.27 (t,  $J = 7.1$  Hz, 3H), 3.25 (brs, 2H), 3.63-3.76 (m, 1H), 4.03 (ddd,  $J = 11.4, 6.3, 1.6$  Hz, 1H), 4.20 (q,  $J = 7.20$  Hz, 2H), 6.06-6.15 (dd,  $J = 15.6, 1.64$  Hz, 1H), 6.92 (dd,  $J = 15.7, 5.2$  Hz, 1H)

$^{13}\text{C NMR}$  (50 MHz,  $\text{CDCl}_3$ ) :  $\delta$  13.9, 18.7, 60.5, 70.1, 75.3, 122.0, 146.8, 166.6

**Analysis:**  $\text{C}_9\text{H}_{14}\text{O}_5$  (174.19) calcd. C, 55.16 ; H, 8.10. Found C, 55.14 ; H, 8.18.

### Preparation of (5*R*,6*R*)-5,6-dihydroxy-2-oxo-heptanoic acid ethyl ester

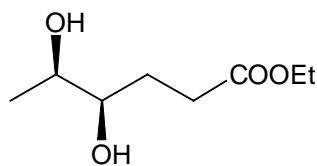

**164**

To a stirred solution of **163** (2.5 g, 14.35 mmol) in dry methanol (20 mL) was added 10% Pd/C (150 mg) and the reaction mixture stirred under hydrogen atmosphere for 1 h. The reaction mixture was filtered through celite pad and concentrated to near dryness. Silica gel column chromatography of the crude product using pet. ether:EtOAc (7:3) as eluent gave the diol **164** (2.51 g) as a colorless oil.

**Yield :** 99%

$[\alpha]_D^{25}$  : +8.56 ( $c$  1.1,  $\text{CHCl}_3$ )

**IR** ( $\text{CHCl}_3$ ,  $\text{cm}^{-1}$ ) :  $\nu_{\text{max}}$  3533, 1719

$^1\text{H NMR}$  (200 MHz,  $\text{CDCl}_3$ ) :  $\delta$  1.15 (t,  $J = 6.9$  Hz, 3H), 1.20 (d,  $J = 6.4$  Hz, 3H), 1.99-2.23 (m, 2H), 2.47-2.58 (m, 2H), 2.99 (brs, 2H), 3.60 (q,  $J = 7.1$  Hz, 2H), 3.69-3.76 (m, 1H), 4.30 (q,  $J = 7.3$  Hz, 1H)

$^{13}\text{C NMR}$  (50 MHz,  $\text{CDCl}_3$ ) :  $\delta$  13.7, 18.7, 27.8, 30.2, 60.1, 70.1, 74.6, 173.8

**Analysis:**  $\text{C}_9\text{H}_{16}\text{O}_5$  (176.21) requires. C, 54.53 ; H, 9.15 ; Found. C, 54.50 ; H, 9.13.

### Preparation of 5-(1-Hydroxy-ethyl)-dihydro-furan-2-one

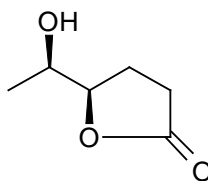

**165**

Compound **164** (2.0 g, 11.35 mmol) was dissolved in bottle grade methanol (20 mL) and catalytic amount of *p*-TSA was added to this. The reaction mixture was stirred till completion of the reaction. Saturated sodium bicarbonate solution (10 mL) was added to the reaction mixture and stirred for 5 min. Methanol was removed in vacuo and the aqueous layer was extracted with dichloromethane (3x10 mL), washed with brine solution and dried over Na<sub>2</sub>SO<sub>4</sub> and concentrated to near dryness. The crude product was purified on silica gel column chromatography using petroleum ether:ethyl acetate (1:1) as eluent to give the lactone **165** (1.22 g) as a light yellow solid.

**Yield** : 83%

**M.p.** : 92 °C

$[\alpha]_D^{25}$  : -52.8 (*c* 1.1, CHCl<sub>3</sub>)

**IR** (CHCl<sub>3</sub>, cm<sup>-1</sup>) :  $\nu_{\max}$  3463, 1699

**<sup>1</sup>H NMR** (200 MHz, CDCl<sub>3</sub>) :  $\delta$  1.20 (d, *J* = 6.6 Hz, 3H), 1.97-2.29 (m, 2H), 2.47-2.57 (m, 2H), 3.03 (brs, 1H), 3.71-3.83 (m, 1H), 4.29-4.38 (m, 1H)

**<sup>13</sup>C NMR** (50 MHz, CDCl<sub>3</sub>) :  $\delta$  18.0, 23.5, 28.2, 68.9, 83.9, 177.6

**Analysis**: C<sub>6</sub>H<sub>10</sub>O<sub>3</sub> (130.14) requires. C, 55.37 ; H, 7.74 ; Found. C, 55.34 ; H, 7.72.

#### Preparation of 5-(1-Iodo-ethyl)-dihydro-furan-2-one

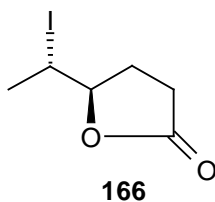

To a solution of **165** (2 g, 15.36 mmol) in dry CH<sub>2</sub>Cl<sub>2</sub> (20 mL) at 0 °C was added methanesulfonyl chloride (1.43 mL, 18.44 mmol), Et<sub>3</sub>N (3.2 mL, 23.0 mmol) and DMAP (cat). The reaction mixture was stirred at room temperature for 6 h and then poured into Et<sub>2</sub>O-H<sub>2</sub>O mixture. The organic phase was separated and the aqueous phase extracted with Et<sub>2</sub>O. The combined organic phases were washed with water, brine, dried (Na<sub>2</sub>SO<sub>4</sub>) and concentrated to a white solid which was dissolved in dry acetone (20 mL). Sodium iodide (21.6 g, 0.14 mol) was added and the reaction mixture was refluxed for 24 h. It was then cooled and poured

into water and extracted with ethyl acetate. The organic extracts were washed with water, brine and dried ( $\text{Na}_2\text{SO}_4$ ) and concentrated. Column chromatography on silica gel using EtOAc/pet ether (0.7:9.3) as eluent gave **166** (2.2 g) as a light yellow liquid.

**Yield :** 60%

$[\alpha]_D^{25}$  : -28.36 (*c* 0.98,  $\text{CHCl}_3$ )

**IR** ( $\text{CHCl}_3$ ,  $\text{cm}^{-1}$ ) :  $\nu_{\text{max}}$  1722, 1519

**$^1\text{H}$  NMR** (200 MHz,  $\text{CDCl}_3$ ) :  $\delta$  1.98 (d,  $J = 7.1$  Hz, 3H), 2.02-2.06 (m, 2H), 2.28-2.31 (m, 1H), 4.19 (qn,  $J = 6.6$  Hz, 1H), 4.33 (q,  $J = 7.2$  Hz, 1H).

**$^{13}\text{C}$  NMR** (50 MHz,  $\text{CDCl}_3$ ) :  $\delta$  17.8, 20.8, 26.1, 34.9, 91.5, 172.0

**Analysis:**  $\text{C}_6\text{H}_9\text{IO}_2$  (240.04) requires. C, 30.02 ; H, 3.78 ; I, 52.87 ; Found. C, 30.01 ; H, 3.76 ; I, 52.85.

#### Preparation of 5-(1-Azido-ethyl)-dihydro-furan-2-one

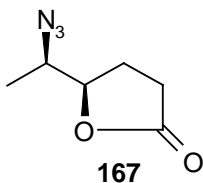

Compound **166** (1.0 g, 4.16 mmol) was dissolved in dry DMF (10 mL). Sodium azide (1.62 g, 25 mmol) was added to the above solution and stirred at 80 °C for 24 h. It was then cooled and poured into water and extracted with ethyl acetate. The organic extracts were washed with water, brine and dried ( $\text{Na}_2\text{SO}_4$ ) and concentrated. Column chromatography on silica gel using EtOAc/pet ether (1:9) as eluent gave **167** (0.48 g) as a colorless liquid.

**Yield :** 74%

$[\alpha]_D^{25}$  : -32.3 (*c* 1.1,  $\text{CHCl}_3$ )

**IR** ( $\text{CHCl}_3$ ,  $\text{cm}^{-1}$ ) :  $\nu_{\text{max}}$  2122, 1738

**$^1\text{H}$  NMR** (200 MHz,  $\text{CDCl}_3$ ) :  $\delta$  1.30 (d,  $J = 6.7$  Hz, 3H), 2.12-2.35 (m, 2H), 2.51-2.62 (m, 2H), 3.76-3.84 (m, 2H), 4.34-4.43 (m, 2H)

**$^{13}\text{C}$  NMR** (50 MHz,  $\text{CDCl}_3$ ) :  $\delta$  14.9, 22.3, 27.8, 59.2, 81.3, 176.3

**Analysis:** C<sub>6</sub>H<sub>9</sub>N<sub>3</sub>O<sub>2</sub> (155.15) requires. C, 46.45 ; H, 5.85 ; N, 27.08 ; Found. C, 46.41 ; H, 5.83 ; N, 27.05.

**Preparation of [1-(5-Oxo-tetrahydro-furan-2-yl)-ethyl]-carbamic acid benzyl ester**

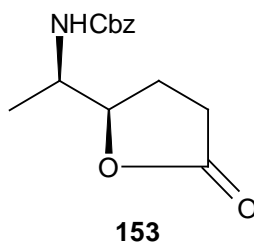

To a stirred solution of **152** (0.5 g, 3.2 mmol) in THF:H<sub>2</sub>O (5:2) was added TPP (0.76 g, 2.9 mmol). The reaction mixture stirred at ambient temperature for 24 h. The reaction mixture was concentrated to near dryness. The crude product thus was obtained dissolved in dry DCM (10 mL). Et<sub>3</sub>N (0.65 mL, 4.64 mmol) and benzyloxycarbonyl chloride (0.60 mL, 4.02 mmol) were added at 0 °C. After consumption of the starting material, the reaction mixture was quenched with water (5 mL) and organic layer was extracted with dichloromethane (3x10 mL) and dried over Na<sub>2</sub>SO<sub>4</sub> and concentrated to near dryness. The crude product was purified on silica gel column chromatography using ethyl acetate: petroleum ether (6 :4) as eluent to give **153** (0.62 g, 73%) as a viscous liquid.

**Preparation of 12-bromo-dodecane**

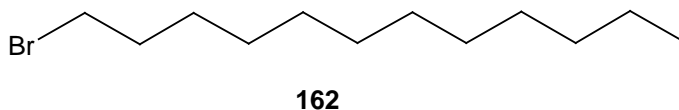

To a solution of alcohol **156** (5.5 g, 29.51 mmol) in dry DCM (50 mL) was added TPP (15.48 g, 59.03 mmol) and CBr<sub>4</sub> (14.68 g, 44.27 mmol) sequentially at 0 °C. The reaction mixture was stirred until disappearance of the starting material. Then, water was added to the reaction mixture and the aqueous layer was extracted with dichloromethane. The combined organic layers were dried over Na<sub>2</sub>SO<sub>4</sub> and concentrated to near dryness. The crude product was purified on silica gel column chromatography using 1% ethyl acetate in petroleum ether as eluent to give **162** (6.24 g) as a colorless oil.

**Yield :** 85%

**<sup>1</sup>H NMR (CDCl<sub>3</sub>, 200 MHz) :** 0.89 (t, *J* = 6.3 Hz, 3H), 1.17-1.43 (m, 20H), 3.90 (t, *J* = 6.6 Hz, 2H)

**<sup>13</sup>C NMR (CDCl<sub>3</sub>, 50 MHz) :** 14.0, 22.6, 26.9, 28.1, 28.7, 29.3, 29.4, 29.5, 29.6, 31.9, 32.8, 33.8



### Preparation of (Dodecane-1-sulfonyl)-benzene

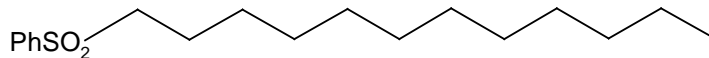

**154**

To a stirred solution of **162** (1 g, 4 mmol) in dry DMF (10 mL) was added PhSO<sub>2</sub>Na (0.98 g, 6 mmol) and then the reaction mixture was stirred for 8 h at ambient temperature. To the reaction mixture was added water (10 mL) and ethyl acetate (10 mL) and organic layer was separated. The aqueous layer was extracted with ethyl acetate (3x10 mL) and combined organic layers were washed thoroughly with water and dried over Na<sub>2</sub>SO<sub>4</sub>. The crude product was purified on silica gel column chromatography using 5% ethyl acetate in petroleum ether to give **154** (1.21 g) as a light yellow solid.

**Yield** : 98%

**M.p.** : 62 °C

**<sup>1</sup>H NMR (CDCl<sub>3</sub>, 200 MHz)** : 0.87 (t, *J* = 5.9 Hz, 3H), 1.12-1.33 (m, 20H), 3.04-3.12 (m, 2H), 7.53-7.68 (m, 3H), 7.91 (d, *J* = 6.6 Hz, 2H)

**<sup>13</sup>C NMR (CDCl<sub>3</sub>, 50 MHz)** : 13.8, 22.4, 28.0, 28.7, 28.9, 29.1, 29.2, 29.3, 31.6, 56.0, 127.8, 129.0, 133.4, 139.0

### Preparation of (6-benzenesulfonyl-2-hydroxy-1-methyl-5-oxo-heptadecyl)-carbamic acid benzyl ester

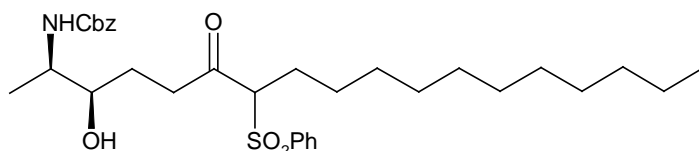

**152**

To a stirred solution of sulfone **154** (0.7 g, 2.28 mmol) in dry THF (10 mL) was added *n*-BuLi (1.4 mL, 2.28 mmol, 1.6 M solution in hexane) at -78 °C and stirring was continued for 20 min. Then the lactone **153** (0.3 g, 1.14 mmol) in dry THF (3 mL) was added dropwise at the same temperature and stirring was continued for further 30 min. After TLC diagnosis, the reaction mixture was quenched with saturated NH<sub>4</sub>Cl (5 mL) and aqueous layer extracted with ethyl acetate (3x20 mL) and washed with brine solution, dried over Na<sub>2</sub>SO<sub>4</sub> and concentrated to near dryness. The crude product was purified on silica gel column chromatography using ethyl acetate : petroleum ether (4:6) as eluent to give **152** (0.52 g) as a light yellow solid.

**Yield :** 80%

**M.p. :** 165 °C

$[\alpha]_D^{25}$  : -6.3 (*c* 0.7, CHCl<sub>3</sub>)

**IR (CHCl<sub>3</sub>, cm<sup>-1</sup>) :**  $\nu_{\max}$  3492, 3352, 1734, 1432

**<sup>1</sup>H NMR (200 MHz, CDCl<sub>3</sub>) :**  $\delta$  0.89 (t, *J* = 4.3 Hz, 3H), 1.22 (d, *J* = 6.6 Hz, 3H), 1.13-1.26 (m, 20H), 1.76-1.88 (m, 2H), 2.02 (s, 1H), 2.24 (t, *J* = 10.5 Hz, 2H), 3.06 (t, *J* = 9.1 Hz, 1H), 3.81-3.95 (m, 1H), 4.35 (q, *J* = 6.6 Hz, 1H), 4.79 (d, *J* = 7.9 Hz, 1H), 5.11 (s, 2H), 7.36-7.38 (m, 5H), 7.49-7.60 (m, 3H), 7.85 (dd, *J* = 7.7, 1.4 Hz, 2H)

**<sup>13</sup>C NMR (50 MHz, CDCl<sub>3</sub>) :**  $\delta$  14.0, 22.5, 26.3, 26.7, 27.1, 28.5, 29.1, 29.4, 29.9, 31.7, 49.3, 66.8, 85.8, 111.3, 126.7, 127.9, 128.9, 128.4, 129.2, 132.3, 134.2, 136.3, 142.6, 155.6, 167.8

**Analysis:** C<sub>32</sub>H<sub>47</sub>NO<sub>6</sub>S (573.78) requires. C, 66.98 ; H, 8.26 ; N, 2.44 ; Found. C, 66.96 ; H, 8.23 ; N, 2.42.

#### Preparation of (2-Hydroxy-1-methyl-5-oxo-heptadecyl)-carbamic acid benzyl ester

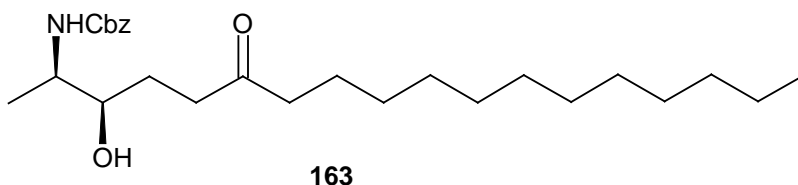

To a stirred solution of **152** (0.25 g, 0.43 mmol) in dry methanol (5 mL) was added 6% Na-Hg (1.3 g) and Na<sub>2</sub>HPO<sub>4</sub> (0.12 g, 0.87 mmol) at -10 °C and stirring was continued at the same temperature for further 4 h. After disappearance of the starting material the reaction mixture was quenched with water and methanol was removed in vacuo, water layer was extracted with ethyl acetate (3x5 mL) and washed with brine solution, dried over Na<sub>2</sub>SO<sub>4</sub> and concentrated to near dryness. The crude product was purified on silica gel column chromatography using ethyl acetate : petroleum ether (3:7) as eluent to afford **163** (0.13) as a white solid.

**Yield :** 68%

**M.p. :** 141 °C

$[\alpha]_D^{25}$  : -28.6 (*c* 0.92, CHCl<sub>3</sub>)

**IR (CHCl<sub>3</sub>, cm<sup>-1</sup>) :**  $\nu_{\max}$  3499, 3296, 1696

$^1\text{H NMR}$  (200 MHz,  $\text{CDCl}_3$ ) :  $\delta$  0.88 (t,  $J = 6.6$  Hz, 3H), 1.12 (d,  $J = 6.6$  Hz, 3H), 1.18-1.34 (m, 20H), 1.56-1.59 (m, 2H), 1.66-1.71 (m, 2H), 2.42 (t,  $J = 7.3$  Hz, 2H), 2.5 (brs, 1H), 3.56-3.73 (m, 1H), 4.08-4.10 (m, 1H), 4.71 (brs, 1H), 5.10 (s, 2H), 7.35-7.52 (m, 5H).

$^{13}\text{C NMR}$  (50 MHz,  $\text{CDCl}_3$ ) :  $\delta$  13.9, 15.5, 22.4, 23.8, 24.1, 24.5, 29.0, 29.1, 29.3, 29.4, 31.5, 33.3, 44.9, 53.6, 69.5, 71.9, 126.6, 127.8, 128.8, 128.9, 142.4, 155.7, 210.8

**Analysis** :  $\text{C}_{26}\text{H}_{43}\text{NO}_4$  (433.62) requires. C, 72.02 ; H, 10.00 ; N, 3.23 ; Found. C, 72.0 ; H, 9.96 ; N, 3.20.

#### Synthesis of (-)-deoxocassine

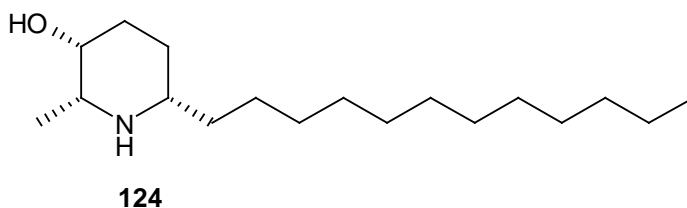

In a single neck round bottom flask, placed **163** (0.1 g, 0.23 mmol) and added 20%  $\text{Pd}(\text{OH})_2$  (20 mg) and the reaction mixture was stirred under hydrogen atmosphere for 24 h and filtered through celite pad, and concentrated to near dryness. The crude product was purified on silica gel column chromatography using ethyl acetate:petroleum ether (4:7) as eluent to give **124** (65 mg). The physical and spectroscopic data of **124** were in full agreement with those reported.<sup>66b</sup>

**Yield** : 100%

$[\alpha]_{\text{D}}^{25}$  : -12.2 ( $c$  0.68,  $\text{CH}_3\text{OH}$ ) [ $[\alpha]_{\text{D}}^{25}$  : -12.3 ( $c$  0.19,  $\text{CHCl}_3$ )]

$^1\text{H NMR}$  (200 MHz,  $\text{CDCl}_3$ ) :  $\delta$  0.75 (t,  $J = 6.8$  Hz, 3H), 1.0 (d,  $J = 6.5$  Hz, 3H), 1.12-1.17 (m, 22H), 1.34-1.42 (m, 2H), 1.83-1.95 (m, 2H), 2.44-2.55 (m, 2H), 2.72-2.74 (m, 1H), 3.90 (d,  $J = 6.5$  Hz, 1H)

$^{13}\text{C NMR}$  (50 MHz,  $\text{CDCl}_3$ ) :  $\delta$  14.3, 16.3, 23.5, 26.2, 27.9, 30.2, 30.4, 30.5, 39.2, 56.5, 58.0, 58.2, 68.3

#### 4.4.7 Spectra

1.  $^1\text{H}$  &  $^{13}\text{C}$  NMR spectra of 157
2.  $^1\text{H}$  &  $^{13}\text{C}$  NMR spectra of 160
3.  $^1\text{H}$  &  $^{13}\text{C}$  NMR spectra of 153
4.  $^1\text{H}$  &  $^{13}\text{C}$  NMR spectra of 154
5.  $^1\text{H}$  &  $^{13}\text{C}$  NMR spectra of 163
6.  $^1\text{H}$  &  $^{13}\text{C}$  NMR spectra of 164
7.  $^1\text{H}$  &  $^{13}\text{C}$  NMR spectra of 165
8.  $^1\text{H}$  &  $^{13}\text{C}$  NMR spectra of 167
9.  $^1\text{H}$  &  $^{13}\text{C}$  NMR spectra of 152
10.  $^1\text{H}$  &  $^{13}\text{C}$  NMR spectra of 168
11.  $^1\text{H}$  &  $^{13}\text{C}$  NMR spectra of 124

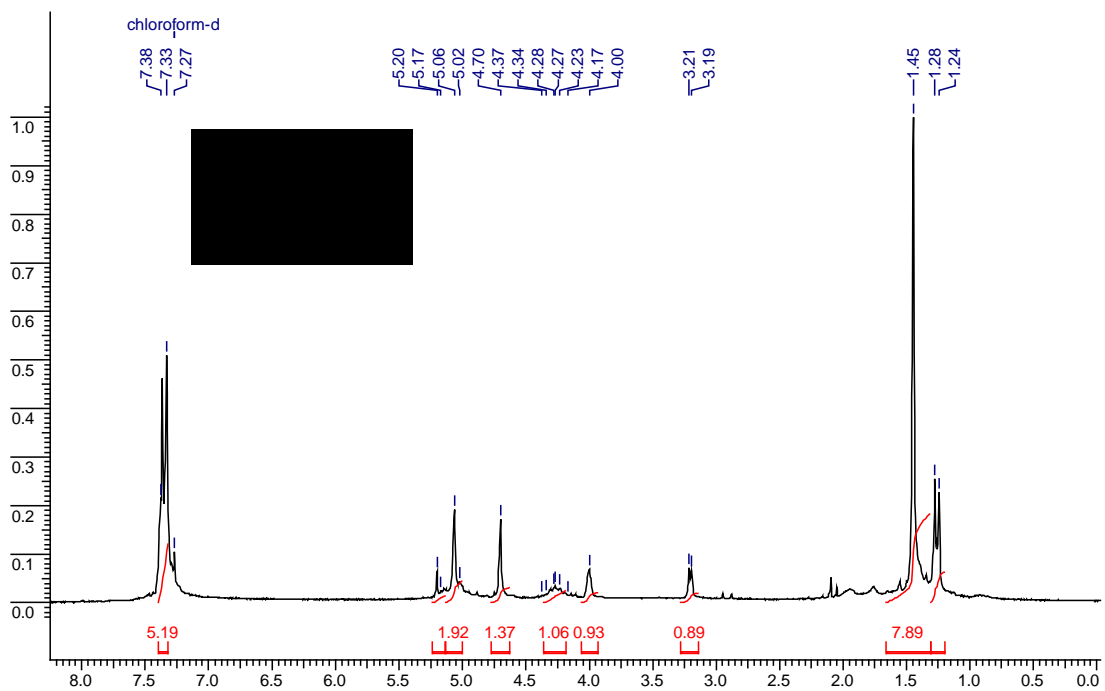

<sup>1</sup>H NMR Spectrum of compound 157 in CDCl<sub>3</sub>

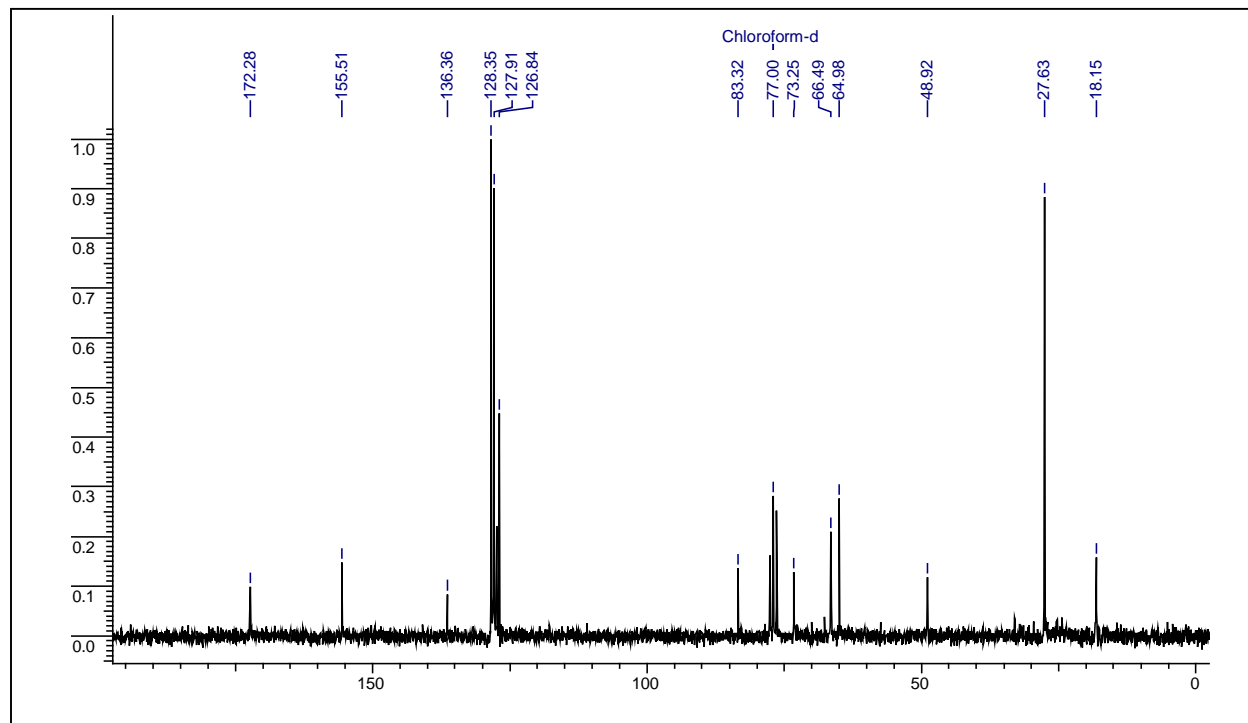

<sup>13</sup>C NMR Spectrum of compound 157 in CDCl<sub>3</sub>



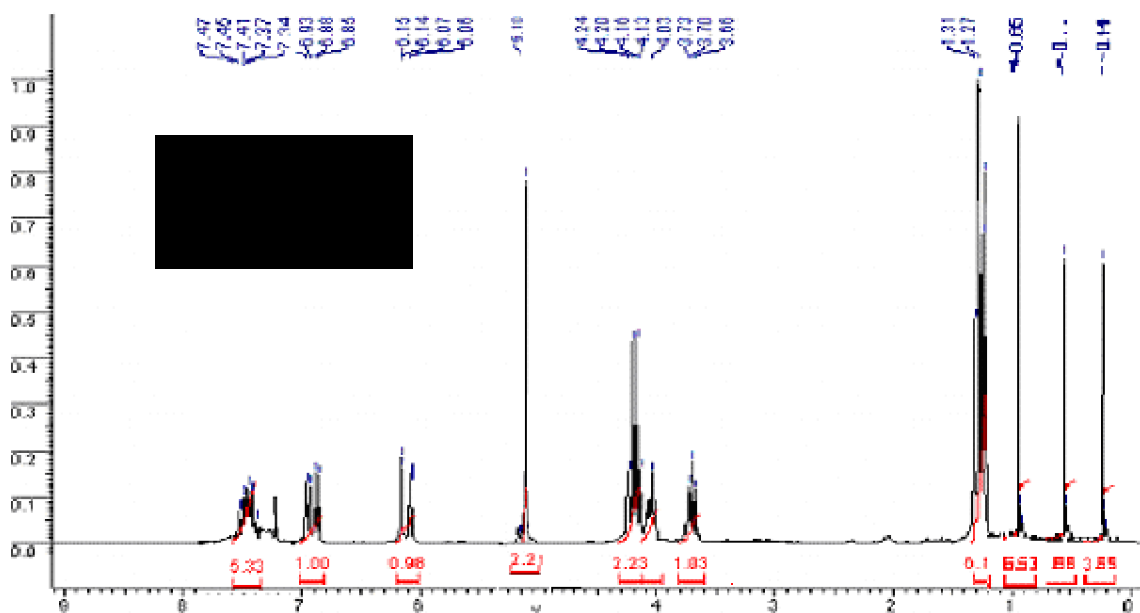

<sup>1</sup>H NMR Spectrum of compound 160 in CDCl<sub>3</sub>

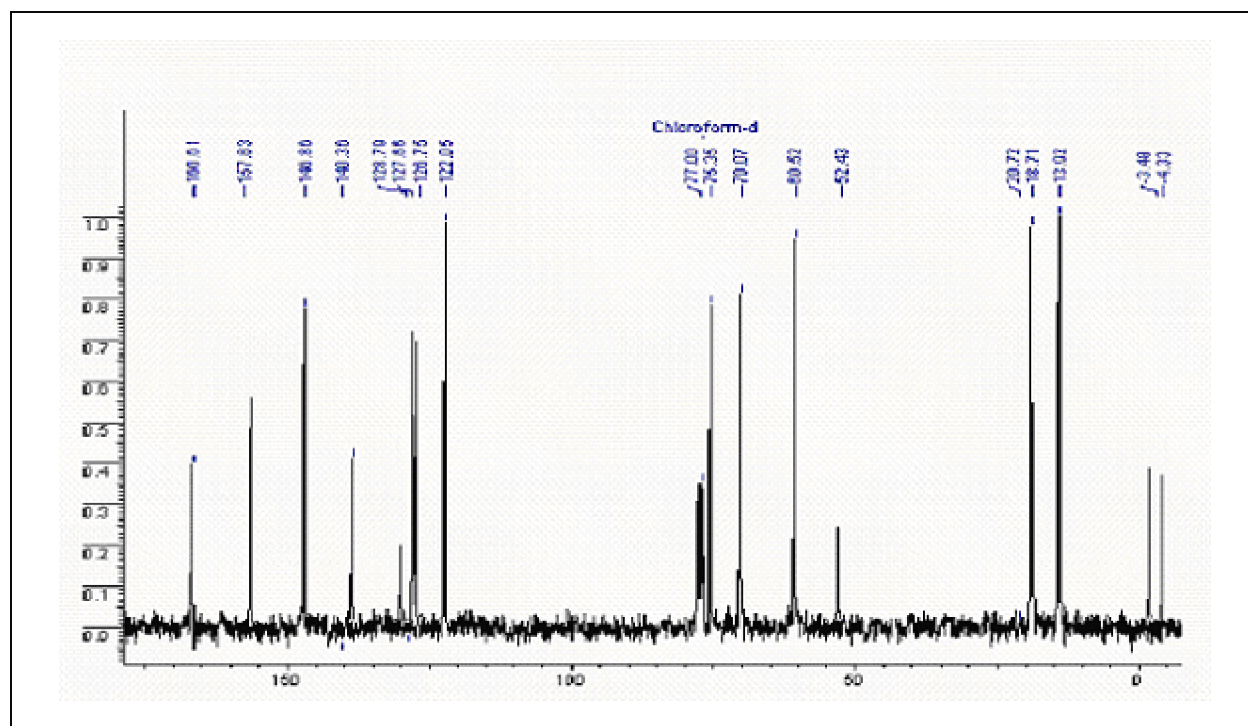

<sup>13</sup>C NMR Spectrum of compound 160 in CDCl<sub>3</sub>



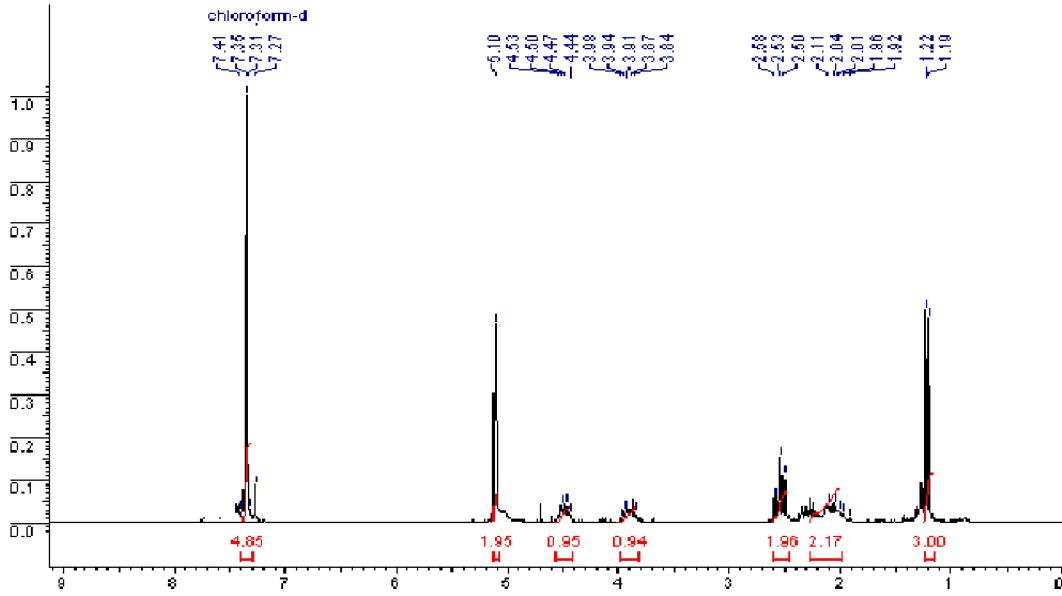

**$^1\text{H}$  NMR Spectrum of compound 153 in  $\text{CDCl}_3$**

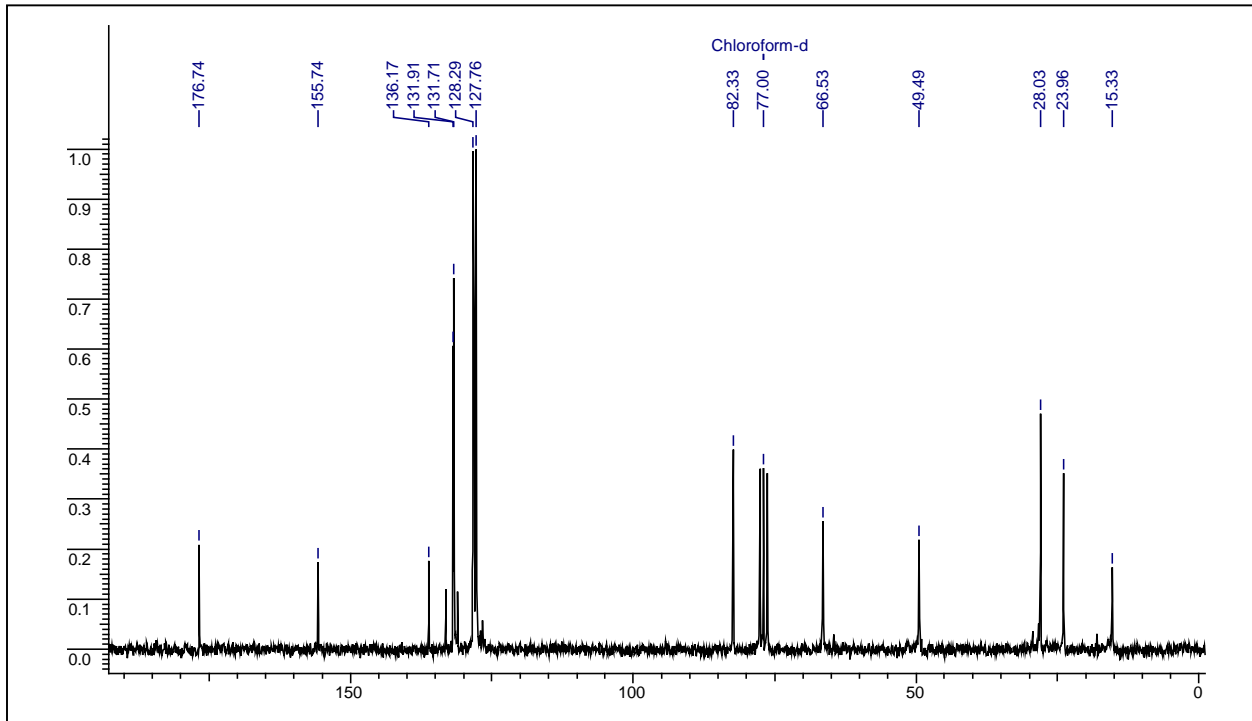

**$^{13}\text{C}$  NMR Spectrum of compound 153 in  $\text{CDCl}_3$**

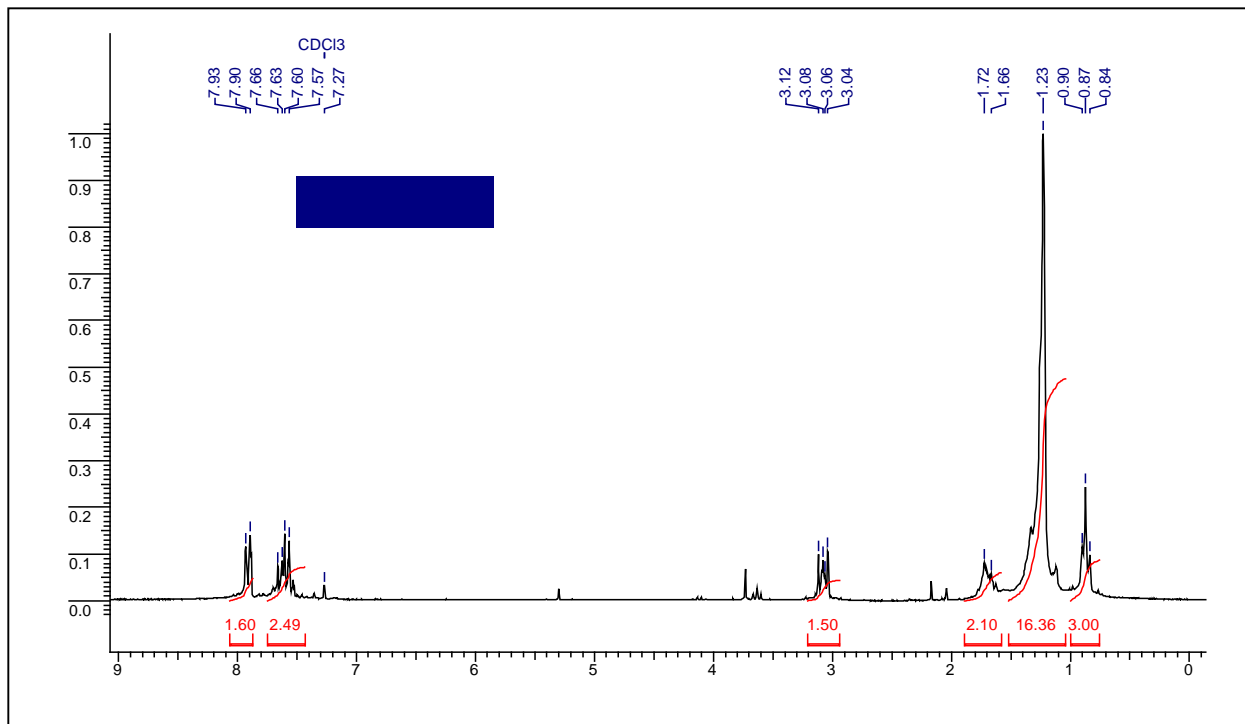

<sup>1</sup>H NMR Spectrum of compound 154 in CDCl<sub>3</sub>

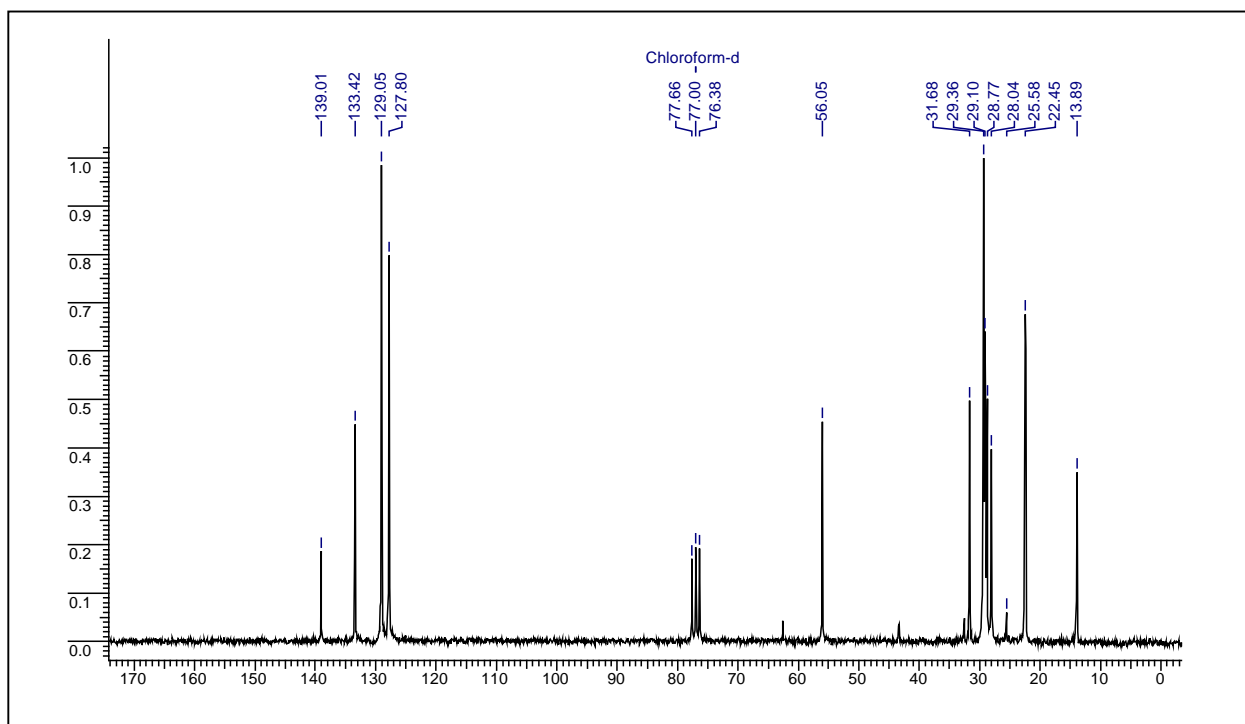

<sup>13</sup>C NMR Spectrum of compound 154 in CDCl<sub>3</sub>



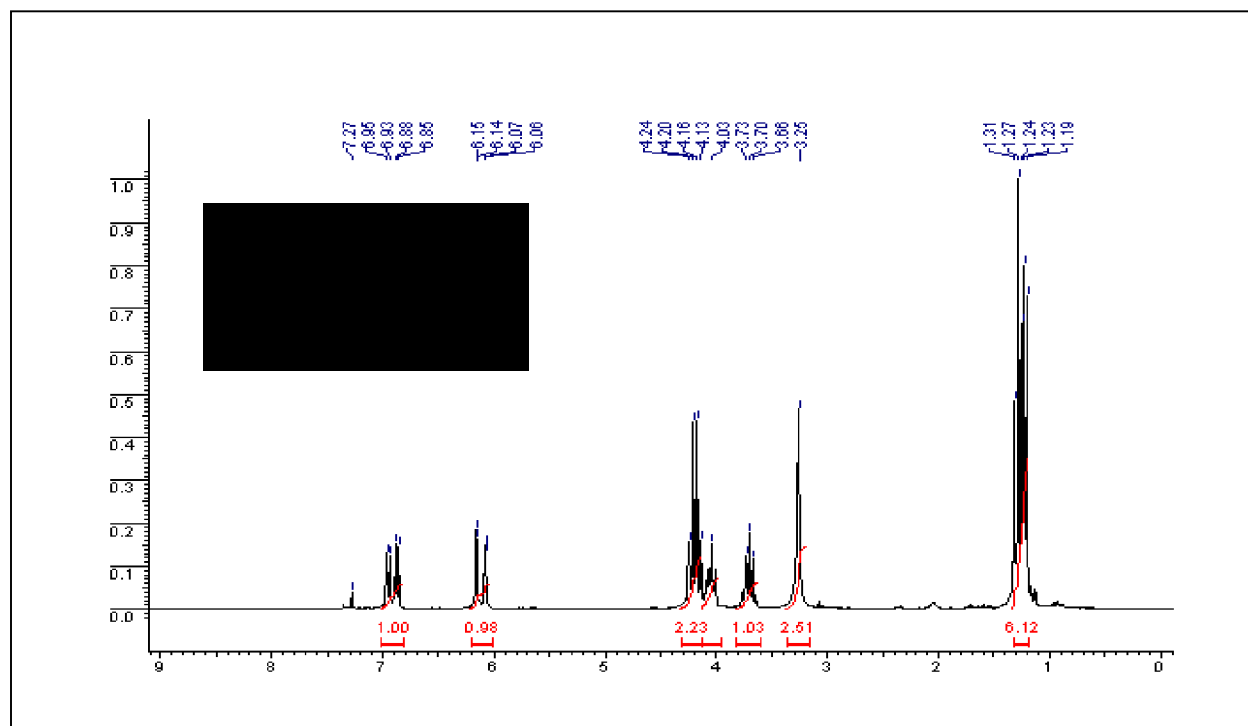

<sup>1</sup>H NMR Spectrum of compound 163 in CDCl<sub>3</sub>

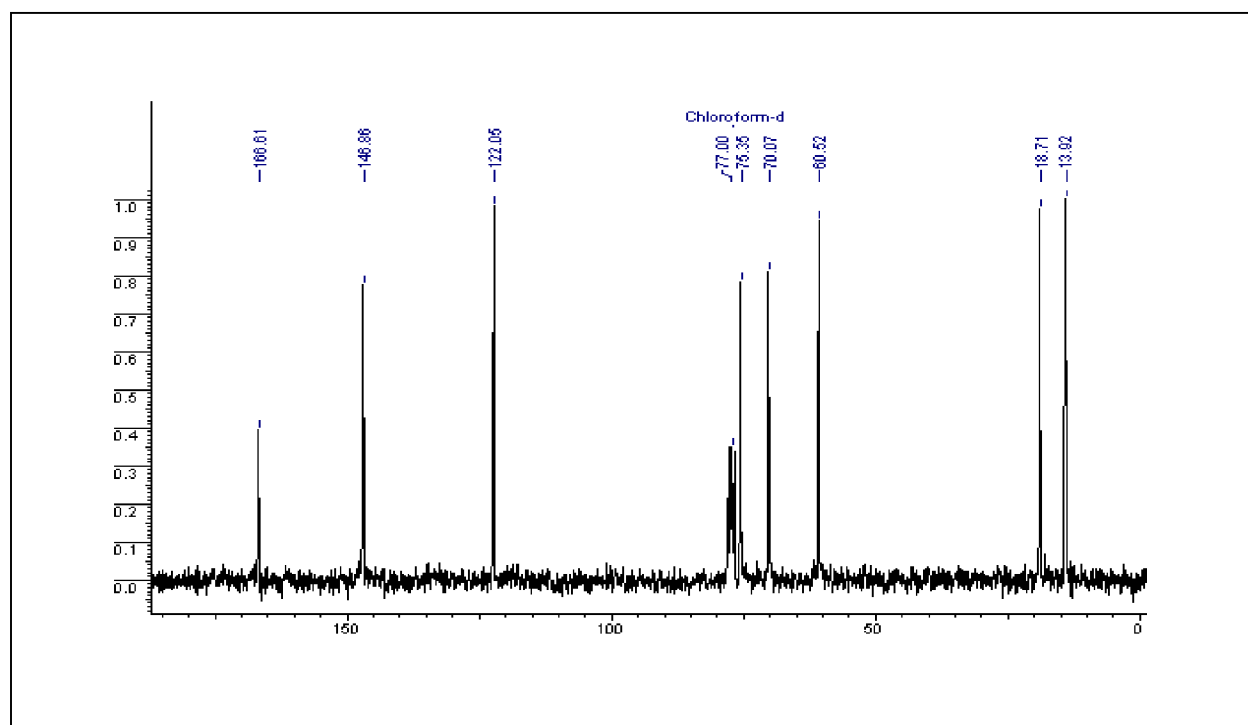

<sup>13</sup>C NMR Spectrum of compound 163 in CDCl<sub>3</sub>

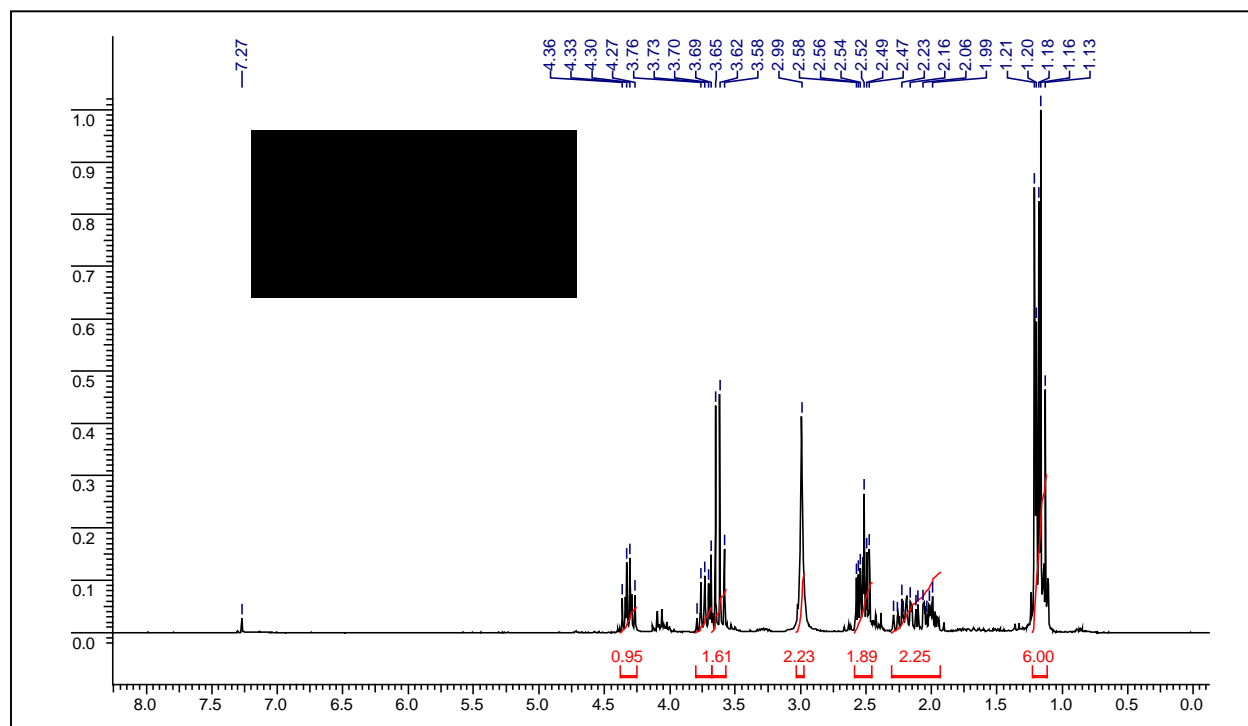

<sup>1</sup>H NMR Spectrum of compound 164 in CDCl<sub>3</sub>

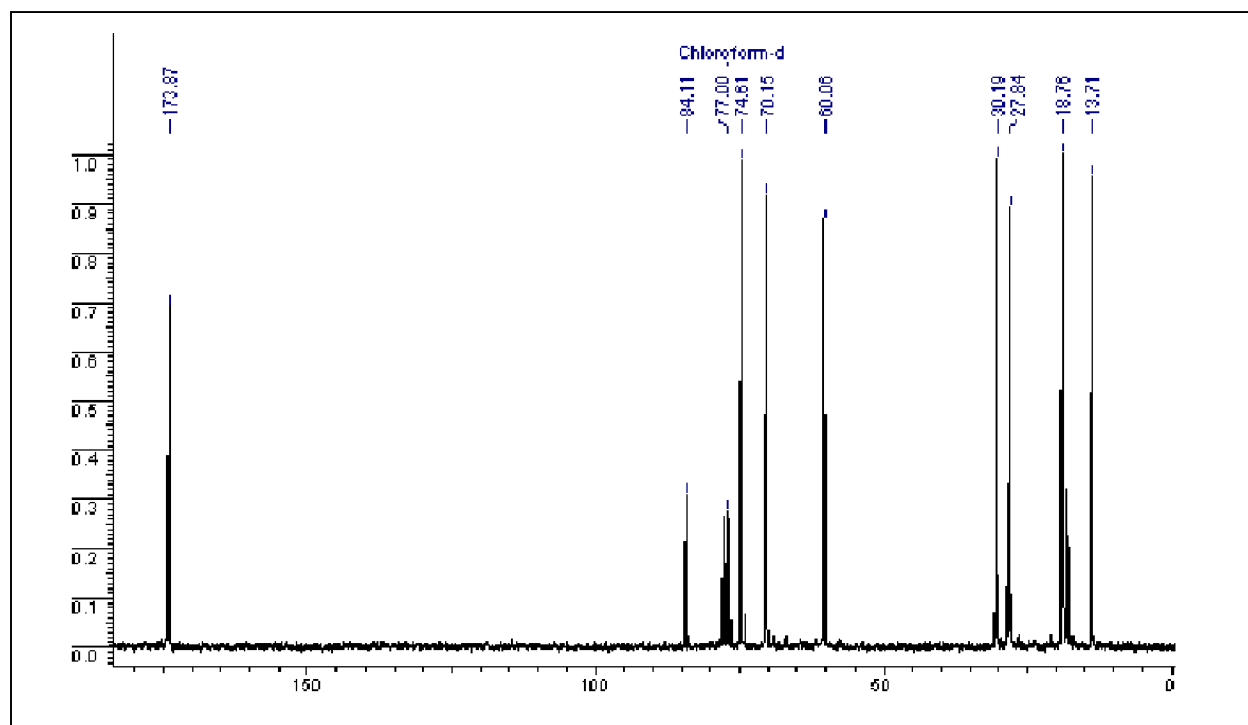

<sup>13</sup>C NMR Spectrum of compound 164 in CDCl<sub>3</sub>

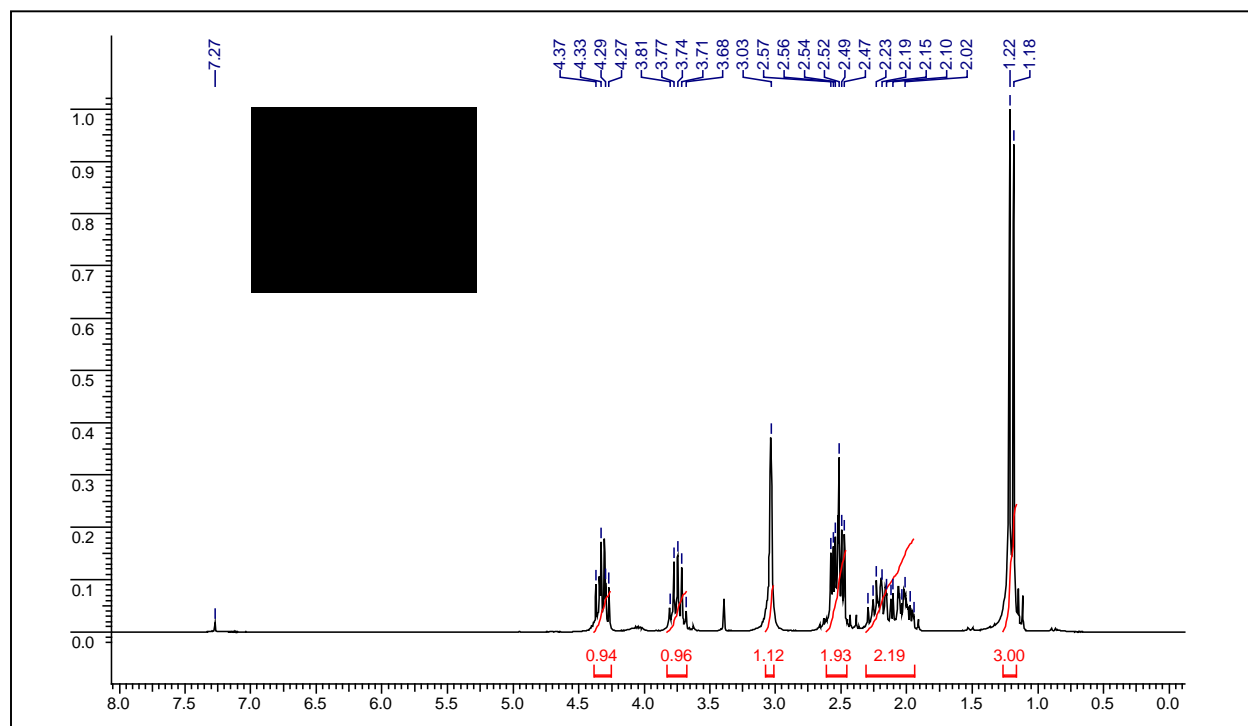

<sup>1</sup>H NMR Spectrum of compound 165 in CDCl<sub>3</sub>

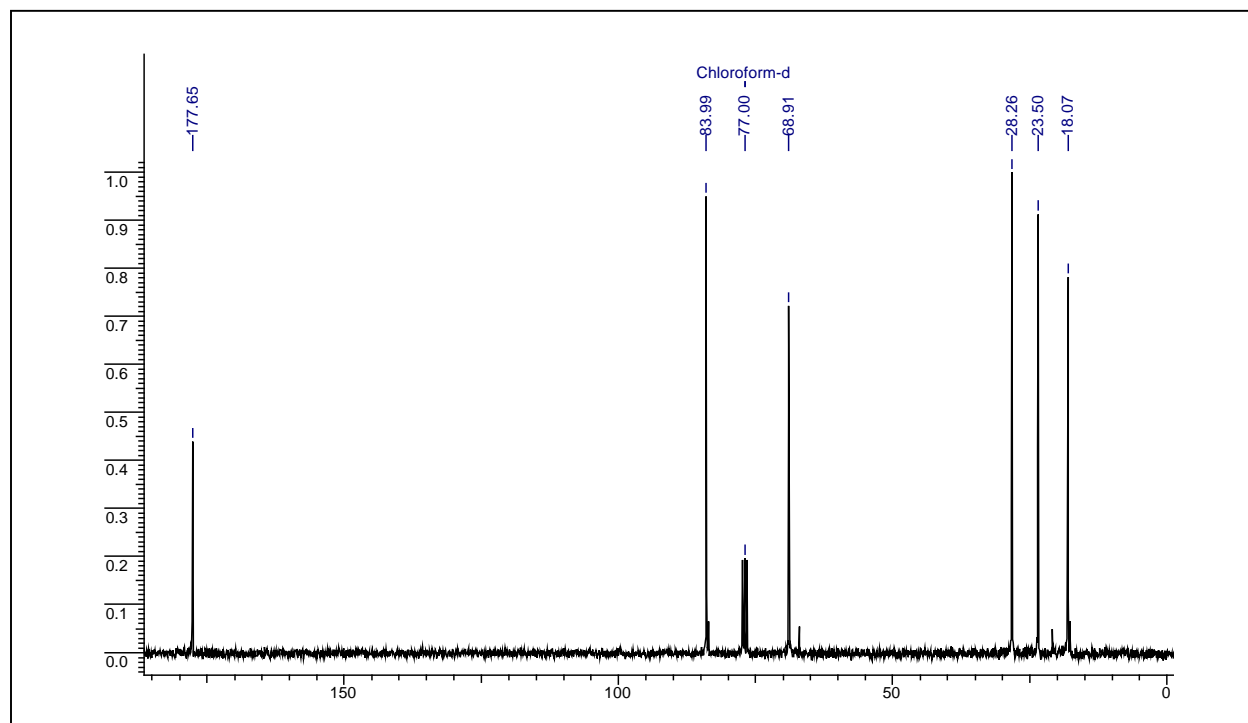

<sup>13</sup>C NMR Spectrum of compound 165 in CDCl<sub>3</sub>

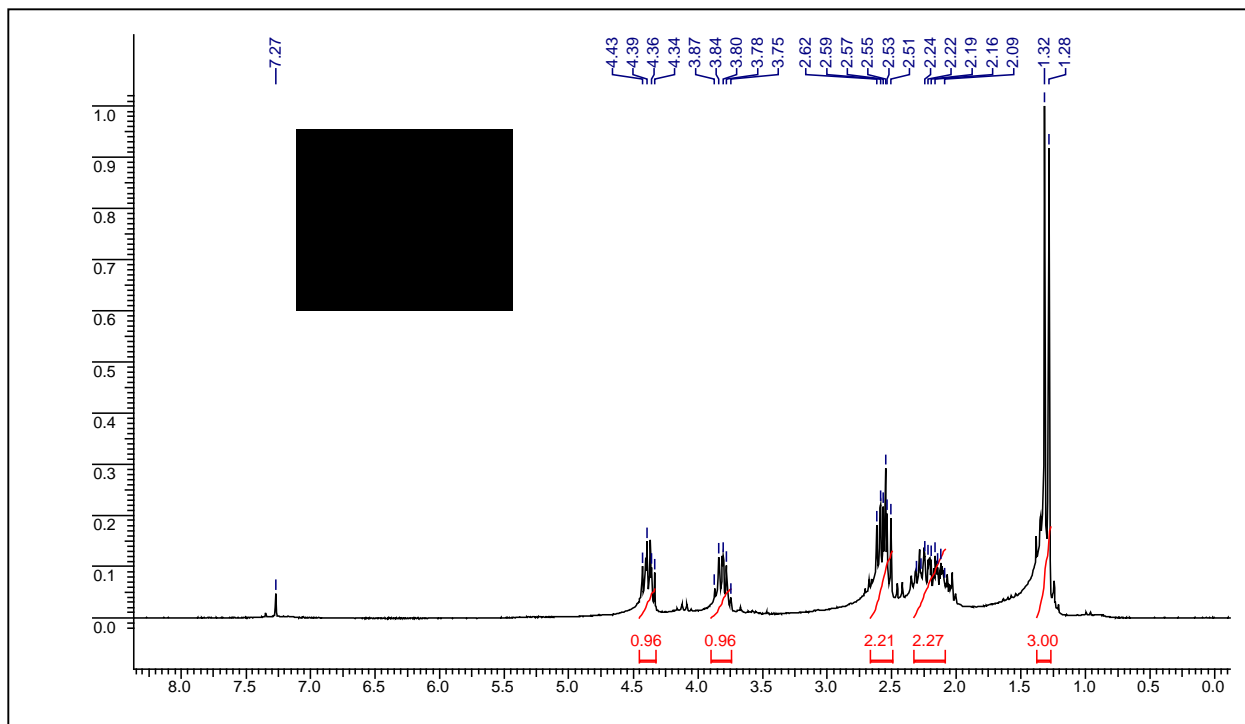

<sup>1</sup>H NMR Spectrum of compound 167 in CDCl<sub>3</sub>

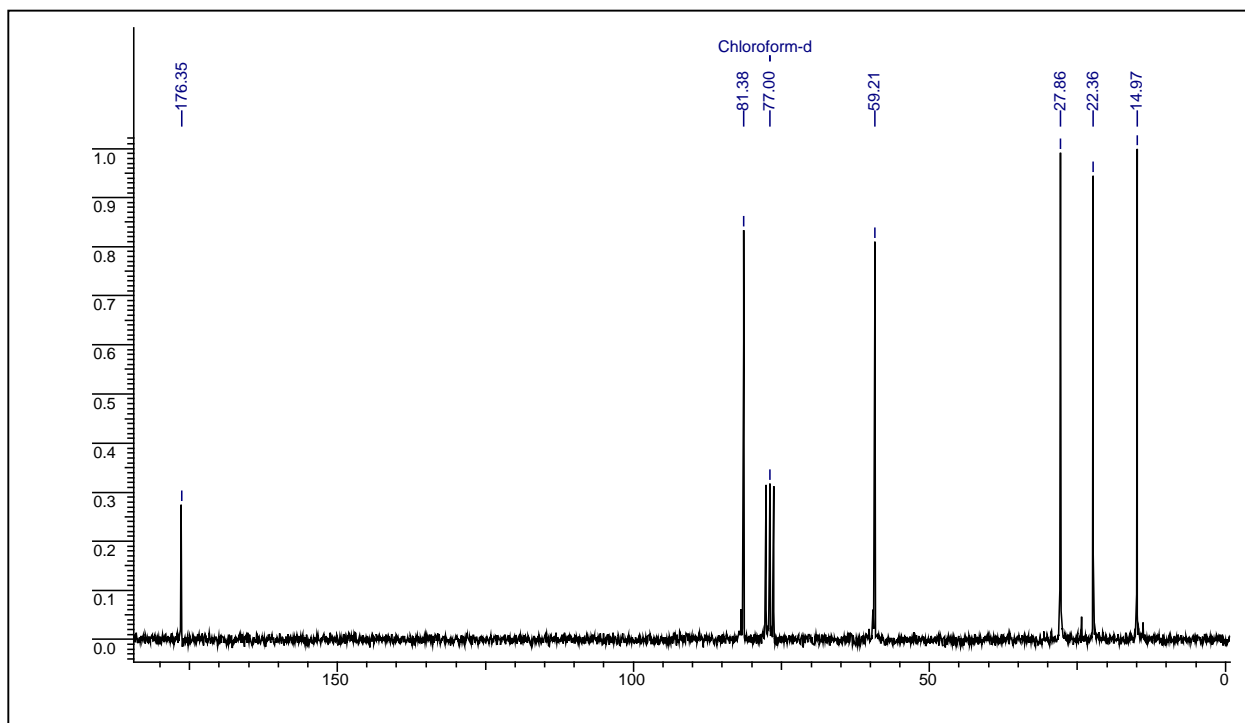

<sup>13</sup>C NMR Spectrum of compound 167 in CDCl<sub>3</sub>

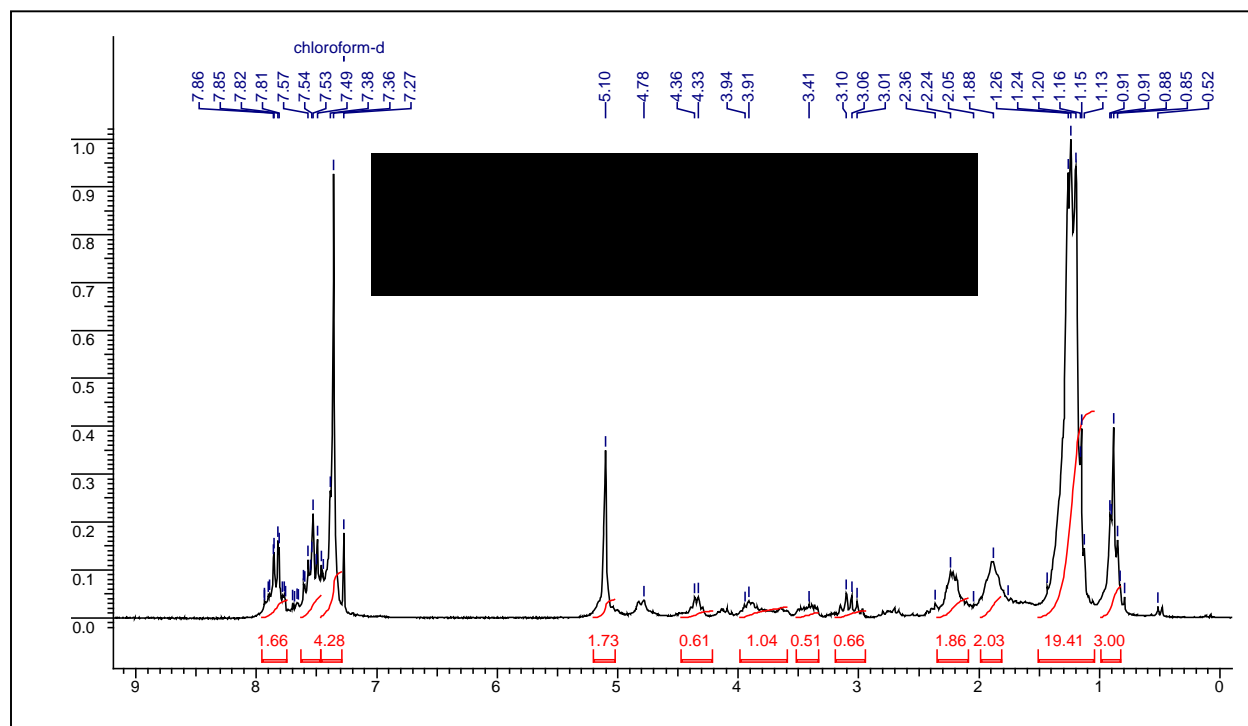

**<sup>1</sup>H NMR Spectrum of compound 152 in CDCl<sub>3</sub>**

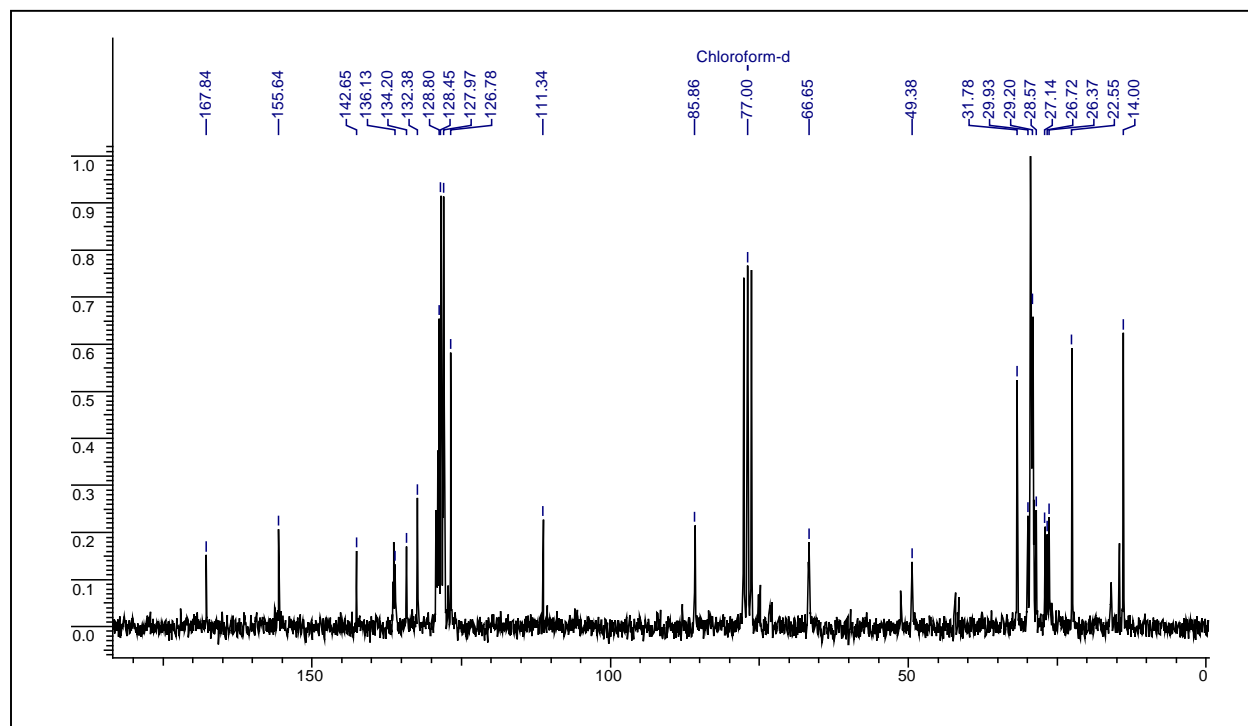

**<sup>13</sup>C NMR Spectrum of compound 152 in CDCl<sub>3</sub>**

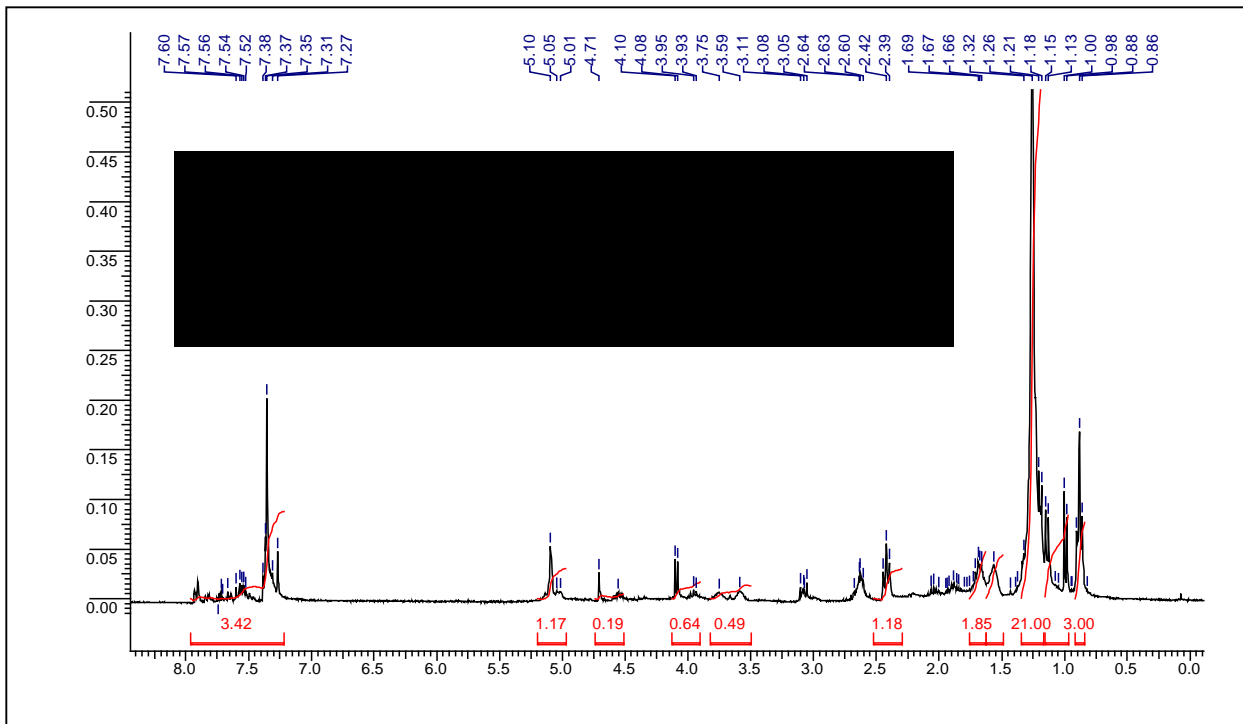

<sup>1</sup>H NMR Spectrum of compound 168 in CDCl<sub>3</sub>

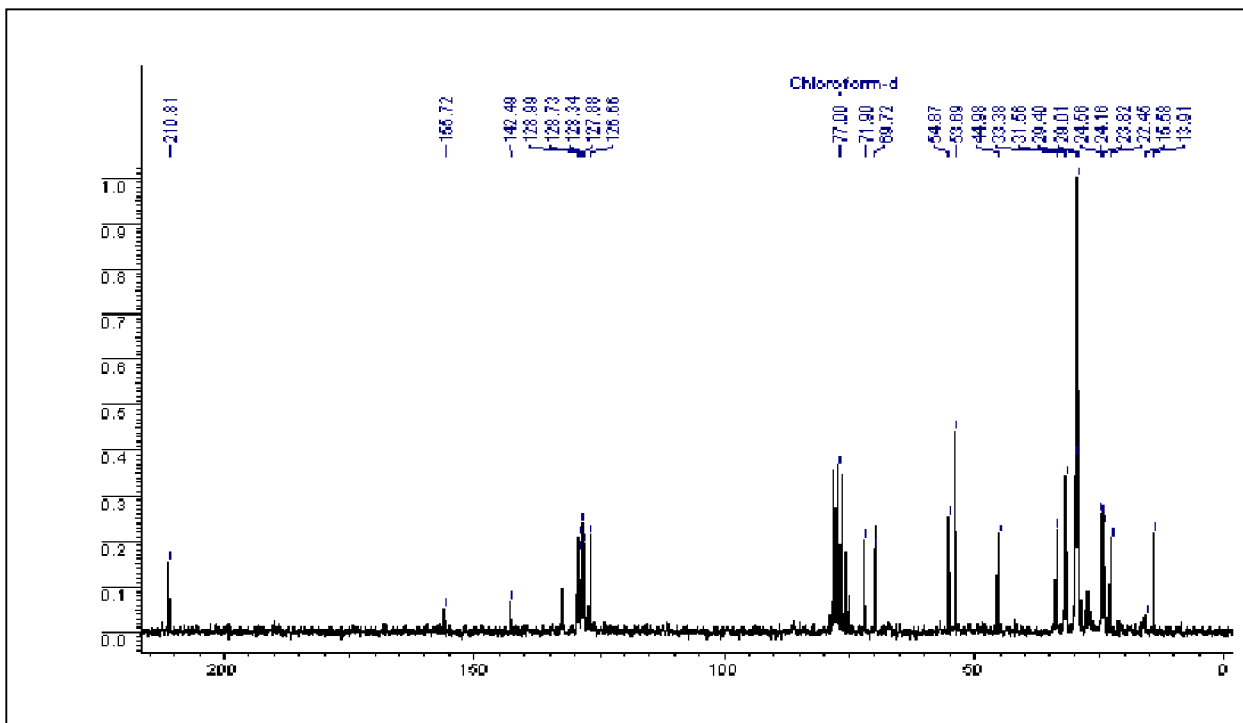

<sup>13</sup>C NMR Spectrum of compound 168 in CDCl<sub>3</sub>



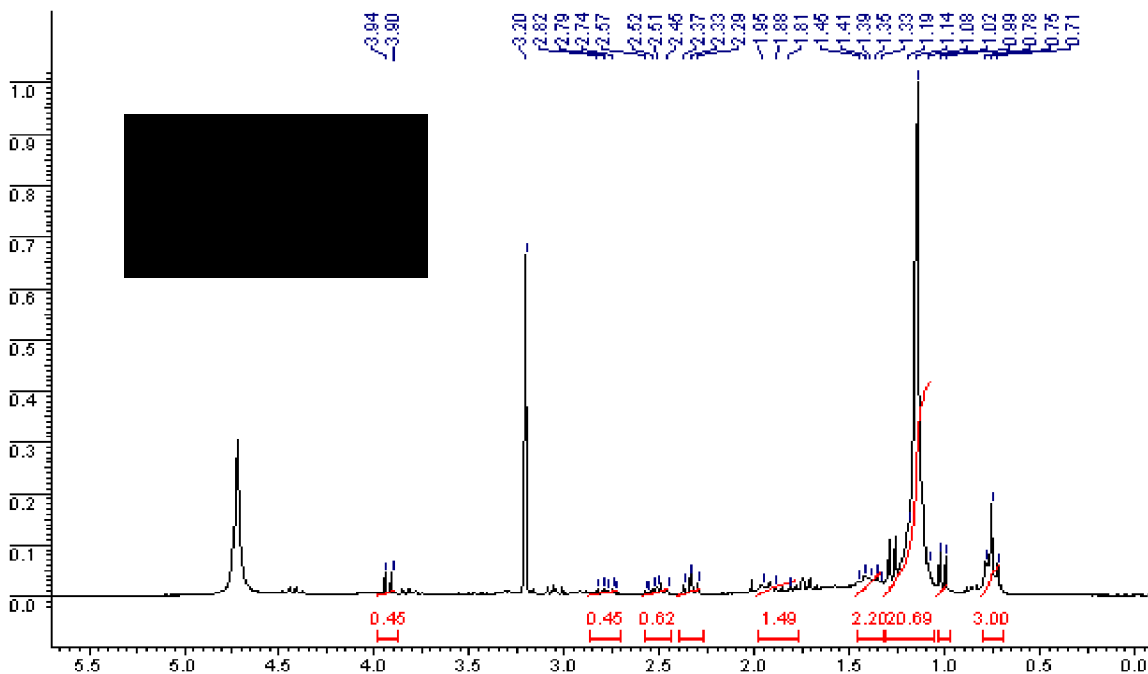

<sup>1</sup>H NMR Spectrum of compound 124 in Methanol-D<sub>4</sub>

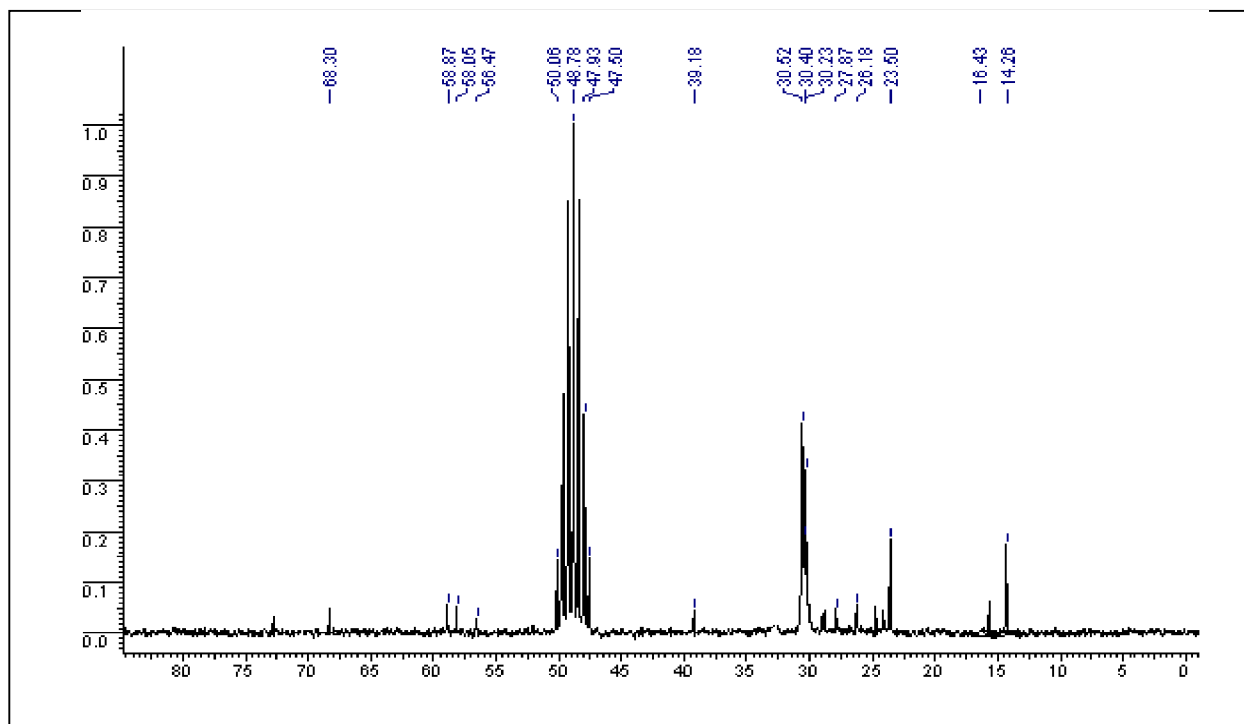

<sup>13</sup>C NMR Spectrum of compound 124 in Methanol-D<sub>4</sub>

4.5 References

1. Coppola, G. M.; Schuster, H. F. Asymmetric synthesis. Construction of Chiral Molecules Using Amino Acids, Wiley: New York, **1987**.
2. Bergmeier, S. C.; Stanchina, D. M. *J. Org. Chem.* **1999**, *64*, 2852.
3. Stratmann, K.; Burgoyne, D. L.; Moore, R. E.; Patterson, G. M. L.; Smith, C. D. *J. Org. Chem.* **1994**, *59*, 7219.
4. Koskinen, P. M.; Koskinen, A. M. P. *Synthesis* **1998**, 1075.
5. Hannun, Y. A.; Linaudic, C. M. *Biochem. Biophys. Acta* **1993**, *1154*, 223.
6. Kamiyama, T.; Umino, T.; Itezuno, Y.; Nakamura, Y.; Satoh, T. *J. Antibiot.* **1995**, *48*, 929.
7. Kobayashi, J.; Cheng, J-F.; Ishibashi, M.; Walchii, M. R.; Yamamura, S. *J. Chem. Soc., Perkin Trans. I* **1991**, 1135.
8. Ohta, Y.; Shinkai, I. *Bioorg. Med. Chem.* **1997**, *5*, 465.
9. Tok, J. B.-H.; Rando, R. R. *J. Am. Chem. Soc.* **1998**, *120*, 8279.
10. Hallinan, E. A.; Tsymbalov, S.; Finnegan, P. M.; Moore, W. M.; Jerome, G. M.; Currie, M. G.; Pitzele, B. S. *J. Med. Chem.* **1998**, *41*, 775.
11. (a) Ager, D. J.; Prakash, I.; Schaad, D. R. *Chem. Rev.* **1996**, *96*, 835 ; (b) Studer, A. *Synthesis* **1996**, 793.
12. Ager, D. J.; Prakash, I.; Schaad, D. R. *Aldrichim. Acta* **1997**, *30*, 3.
13. Parker, K. A.; Ledebor, M. W. *J. Org. Chem.* **1996**, *61*, 3214.
14. Fehr, H.; Galindo, J. *Angew. Chem., Int. Ed. Engl.* **1994**, *33*, 1888.
15. Veeresh, G.; Datta, A. *Tetrahedron Lett.* **1997**, *38*, 5223.
16. Schwardt, O.; Veith, U.; Gaspand, C.; Jager, V. *Synthesis* **1999**, 1473.
17. (a) Castejon, P.; Moyano, A.; Pericas, M. A.; Riera, A. *Tetrahedron* **1996**, *52*, 7063 ; (b) Chng, B. L.; Ganesan, A. *Bioorg. Med. Chem. Lett.* **1997**, *7*, 1511 ; (c) Pasto, M.; Moyano, A.; Pericas, M. A.; Riera, A. *Tetrahedron : Asymmetry* **1995**, *36*, 1649.
18. Scriven, E.; Turnbull, K. *Chem. Rev.* **1998**, *88*, 297.
19. Pasto, M.; Castejon, P.; Moyano, A.; Pericas, M. A.; Riera, A. *J. Org. Chem.* **1996**, *61*, 6033.



20. (a) Kang, S.-K.; Baik, T.-G.; Hur, Y. *Tetrahedron* **1999**, *55*, 6863 ; (b) Kimura, M.; Tanaka, S.; Tamaru, Y. *J. Org. Chem.* **1995**, *60*, 3764 ; (c) Knapp, S. *Chem. Soc. Rev.* **1999**, *28*, 61.
21. Van Benthem, R. A. T. M.; Hiemstra, H.; Speckamp, W. N. *J. Org. Chem.* **1992**, *57*, 6083.
22. Adam, W.; Bruenker, H.-G. *Synthesis* **1995**, 1066.
23. (a) Rassa, G.; Auzzas, L.; Pinna, L.; Zanardi, F.; Battistini, L.; Casiraghi, G. *Org. Lett.* **1999**, *1*, 1213 ; (b) Ferey, V.; Legall, T.; Mioskowski, C. *J. Chem Soc., Chem. Commun.* **1995**, 487.
24. Miyabe, H.; de Gracia, I. S.; Chiara, J. L. *Synlett* **1999**, 1551.
25. (a) Li, G.; Chang, H. T.; Sharpless, K. B. *Angew. Chem. Int. Ed. Engl.* **1996**, *35*, 451 ; (b) For a review on the Sharpless asymmetric aminohydroxylation, see Bodkin, J. A. ; McLeod, M. D. *J. Chem. Soc. Perkin Trans 1* **2002**, 2733.
26. (a) von Euler, U.; S.; Gaddum, J.; H. *J. Physiol.* **1931**, *72*, 74 ; (b) Guard, S.; Watson, S. P. *Neurochem. Int.* **1991**, *18*, 149.
27. Lotz, M.; Vaughan, J. H.; Carson, D. A. *Science* **1988**, *241*, 1218.
28. Perianin, A.; Snyderman, R.; Malfroy, B. *Biochem. Biophys. Res. Commun.* **1989**, *161*, 520.
29. Baruch, P.; Artaud, F.; Godeheu, G.; Barbeito, L.; Glowinski, J.; Cheramy, A. *Neuroscience* **1988**, *25*, 889.
30. Lotz, M.; Vaughan, J. H.; Carson, D. A. *Science* **1988**, *241*, 1218.
31. Perianan, A.; Snyderman, R.; Malfroy, B. *Biochem. Biophys. Res. Commun.* **1989**, *161*, 520.
32. Lotz, M.; Carson, D. A.; Vaughan, J. H. *Science* **1987**, *235*, 893.
33. Mantyh, C. R.; Gates, T. S.; Zimmerman, R. P.; Welton, M. L.; Passaro, E. P.; Vigna, S. R.; Maggio, J. E.; Kruger, L.; Mantyh, P. W. *Proc. Natl. Acad. Sci. U.S.A.* **1988**, *85*, 3235.
34. Goadsby, P. J.; Edvinsson, L.; Ekman, R. *Ann. Neurol.* **1988**, *23*, 193.

35. Stadler, H.; Bos, M. *Heterocycles* **1999**, *51*, 1067.
36. Lee J.; Hoang, J.; Lewis, S.; Weissman, S. A.; Askin, D.; Volante, R. P.; Reider, P. J. *Tetrahedron Lett.* **2001**, *42*, 6223.
37. Tomooka, K.; Nakazaki, A.; Nakai, T. *J. Am. Chem.Soc.* **2000**, *122*, 408.
38. (a) Bhaskar, G.; Rao, B. V. *Tetrahedron Lett.* **2003**, *44*, 915-917 ; (b) Huang, P. Q.; Liu, L. X.; Wei, B. G.; Ruan, Y. P. *Org. Lett.* **2003**, *5*, 1927-1929 ; (c) Yoon, Y. J.; Joo, J. E.; Lee, K. Y.; Kim, Y. H.; Oh, C. Y.; Ham, W. H. *Tetrahedron Lett.* **2005**, *46*, 739.
39. (a) Lee, K. Y.; Kim, Y. H.; Park, M. S.; Ham, W. H. *Tetrahedron Lett.* **1998**, *39*, 8129 ; (b) Lee, K. Y.; Kim, Y. H.; Park, M. S.; Oh, C. Y.; Ham, W. H. *J. Org. Chem.* **1999**, *64*, 9450 ; (c) Lemine, A.; Grenon, M.; Pourashraf, C.; Charette, A. B. *Org. Lett.* **2004**, *6*, 3517.
40. (a) Bodas, M. S.; Upadhyay, P. K.; Kumar, P. *Tetrahedron Lett.* **2004**, *45*, 987.
41. (a) Lee, K. Y.; Kim, Y. H.; Park, M. S.; Ham, W. H. *Tetrahedron Lett.* **1998**, *39*, 8129.
42. (a) Oliveto, E. P.; Gerold, C. *Organic Synthesis Collective volume IV. 104*, **1963** ; (b) Lee, S. H.; Yoon, J.; Chung, S. H.; Lee, Y. S. *Tetrahedron* **2001**, *57*, 2139.
43. Hakomori, S. *Sphingolipid Biochemistry. In Hand Book of Lipid Research* ; Kanfer, J. N.; Hakomori, S., Eds.; Plenum: New York **1983**, *3*, 1.
44. Hannun, Y. A. ; Bell, R. M. *Science* **1989**, *243*, 500.
45. Schwartz, G. K.; Jiang, J.; Kelson, D.; Albino, A. P. *J. Nat. Cancer Inst.* **1993**, *85*, 402.
46. Nicolaou, K. C. *Chemtracts-Org. Chem* **1991**, *4*, 181.
47. Schmidt, R. R. *Pure Appl. Chem.* **1989**, *61*, 1257.
48. Harouse, J. M.; Bhat, S.; Spitalnik, S. L.; Laughlin, M.; Stefano, K.; Silberberg, D. H.; Gonzalez-Scarano, F. *Science* **1989**, *243*, 500.
49. Masui, M.; Shioiri, T. *Tetrahedron Lett.* **1998**, *39*, 5199.
50. Cook, G. R.; Pararajasingham, P. *Tetrahedron Lett.* **2002**, *43*, 9027.

51. Azuma, H.; Tamagaki, S.; Ogino, K. *J. Org. Chem.* **2000**, *65*, 3538.
52. (a) Reist, E. J.; Christie, P. H. *J. Org. Chem.* **1970**, *35*, 3521 ; (b) Wild, R.; Schimdt, R.  
R. *Liebigs, Ann. Chem.* **1995**, 755.
53. Villard, R.; Fitiadu, F.; Buono, G. *Tetrahedron: Asymmetry* **1998**, *9*, 607.
54. Grob, C. A.; Jenny, E. F.; Utzinger, H. *Helv. Chim. Acta* **1951**, *34*, 2249.
55. Morgan, A. J.; Masse, C. E.; Panek, J. S. *Org. Lett.* **1999**, *1*, 1949.
56. Donohoe, T. J.; Johnson, P. D.; Pye, R. J.; Keenan, M. *Org. Lett.* **2004**, *6*, 2583.
57. Subba Rao, K. V.; Abhishek, D.; Kumar, P. Unpublished results.
58. M. J. Mintz, C. Walling, *Org. Synth.* **1973**, Col. Vol. 5, 184.
59. Harborne, J. B.; Boulter, D.; Turner, B. L. *Chemotaxonomy of the Leguminosae*,  
*Academic press*, New York **1971**.
60. Lythgoe, D.; Busch, A.; Schrazberg, N.; Vernengo, M. *Chem. Abstr.* **1972**, *77*,  
16490K.
61. (a) Highet, R. *J. Org. Chem.* **1964**, *29*, 471 ; (b) Lythgoe, D.; Vernengo, M.  
*Tetrahedron Lett.* **1967**, *12*, 1133.
62. Brown, E.; Dhal, R. *Bull. Soc. Chim. Fr.* **1972**, *11*, 4292.
63. Rice jr., W. Y.; Coke, J. L. *J. Org. Chem.* **1966**, *31*, 1010.
64. Strunz, G. M.; Findlay, J. A.; *In The Alkaloids*; Brossi, A., E; Academic Press: New  
York **1985**, *26*, 89.
65. Cassidy, M. P.; Padwa, A. *Org. Lett.* **2004**, *6*, 4029.
66. (a) Liu, L. X.; Ruan, Y. R.; Guo, Z. Q.; Huang, P. Q. *J. Org. Chem.* **2004**, *69*, 6001 ;  
(b) Ma, D.; Ma, N. *Tetrahedron Lett.* **2003**, *44*, 3963.
67. (a) Davies, S. G.; Ichihara, O. *Tetrahedron : Asymmetry* **1991**, *2*, 183; (b) Davies, S.  
G.; Ichihara, O.; Walters, I. A. S. *J. Chem. Soc., Perkin Trans I* **1994**, 1141.
68. (a) Han, H.; Yoon, J.; Janda, K. D. *J. Org. Chem.* **1998**, *63*, 2045 ; (b) Hennings, D.  
D.; Williams, R. M. *Synthesis* **2000**, 1310.
69. Xu, D.; Crispino, G. A.; Sharpless, K. B. *J. Am. Chem. Soc.* **1992**, *114*, 7570.

## 5. STEREOSELECTIVE SYNTHESIS OF C<sub>1</sub>-C<sub>6</sub> FRAGMENT OF FUMONISIN B

### 5.1 Introduction

---

The natural toxins have drawn the attention of scientific community due to their involvement in human intoxication and the socio-economic impacts brought by these incidents. The studies on the natural products show that the structural properties of a compound in question are inherent to the specific stereochemical arrangements of substituents on its carbon backbone and are independent from the rest of the molecules. The natural toxins bearing small substituents on their structural motifs, carrying specific information serve as functional materials. In this context, structural elucidation of toxins by chemical synthesis is imperative not only for understanding the molecular basis of the mechanism of action but also for designing proper counter measures (such as detection, determination and exact therapeutic methods). Thus, chemical modifications followed by structure activity relationship studies are attractive for the synthetic organic chemists. Fumonisin B is the most abundant member of the fumonisin family mycotoxins<sup>1</sup> observed and usually accounts for about 70% of the total fumonisins found both in cultures and in naturally contaminated food products.

Fumonisin B (**Fig. 1**) is potent toxic material isolated from *Fusarium moniliforme* which is one of the most prevalent molds on corn, sorghum, and other grains throughout the world. *F. Moniliforme* has been shown to be toxic and carcinogenic for humans and animals both as grain and as a culture isolate. The recent observation that cultures of *Fusarium moniliforme* exhibit cancer promoting activity in animals in a short-term bioassay resulted in the isolation and characterization of a fumonisin B (FB) mycotoxins<sup>2</sup>

(Fig. 1). Only fumonisin B<sub>1</sub> (FB<sub>1</sub>) and fumonisin B<sub>2</sub> (FB<sub>2</sub>) appear to be of any toxicological significance as fumonisin B<sub>3</sub> (FB<sub>3</sub>) and fumonisin B<sub>4</sub> (FB<sub>4</sub>) as well as the two fumonisin A toxins fumonisin A<sub>1</sub> (FA<sub>1</sub>) and fumonisin A<sub>2</sub> (FA<sub>2</sub>), occur at extremely low concentrations where FB<sub>1</sub> and FB<sub>2</sub> were active.<sup>3</sup> However there was a report about natural occurrence of FA<sub>1</sub> and FA<sub>2</sub> that these are not natural metabolites but are artifacts produced during the original isolation of fumonisins due to use of acetic acid in the silica chromatography step.<sup>4</sup>

Pure FB<sub>1</sub> has since been shown to cause leukoencephalomalacia in horses pulmonary edema in swine and to be hepatotoxic and hepatocarcinogenic in rats. The future risk assessment studies on exposure of animals to the fumonisins should consider FB<sub>2</sub>, in addition to FB<sub>1</sub>, as FB<sub>2</sub> most probably exhibits toxic and carcinogenic properties similar to FB<sub>1</sub> and occurs at significant levels in cereals under natural conditions. Both FB<sub>1</sub> and FB<sub>2</sub> also pose a potential risk to humans as they occur in human food and have been shown to be statically correlated with the prevalence of human esophageal cancer.

The mechanism of cancer induction and specifically cancer initiation is of particular interest as the fumonisins lack mutagenicity in the *salmonella* mutagenicity assay and lack genotoxicity in both the *in vitro* and *in vivo* repair DNA assays in primary rat hepatocytes. The mechanism of cancer induction of these apparently non-genotoxic mycotoxins is presently under investigation.

#### **In vitro toxicology of fumonisins**

The fumonisins bear a remarkable structural similarity to sphinganine **7** and sphingosine **8** (Sphingoid base) (Fig. 2). This similarity led to the hypothesis that fumonisins might interfere with sphingosine metabolism or function.<sup>5</sup> Sphingosine is the chemical backbone of all sphingolipids, including sphingomyelin, ceramides and gangliosides. Sphingolipids are believed to play a critical role in a number of cellular functions, including cell-cell

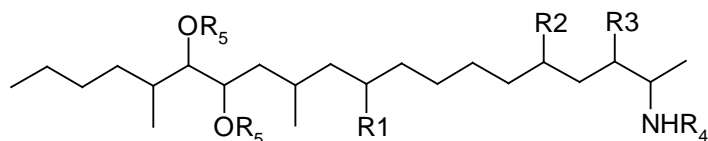

	R <sub>1</sub>	R <sub>2</sub>	R <sub>3</sub>	R <sub>4</sub>
FB <sub>1</sub> 1	OH	OH	OH	H
FB <sub>2</sub> 2	H	OH	OH	H
FB <sub>3</sub> 3	OH	H	OH	H
FB <sub>4</sub> 4	H	H	OH	H
FA <sub>1</sub> 5	OH	OH	OH	CH <sub>3</sub> CO
FA <sub>2</sub> 6	H	OH	OH	CH <sub>3</sub> CO

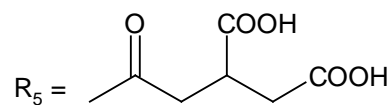

### Structures of Fumonisin (FB, FA)

Fig. 1

communication, the regulation of the properties of cell surface receptors, cell growth, cell differentiation and cell transformation. Disruption of sphingolipid biosynthesis could thus have severe consequence for an organism's health. The effects of fumonisins B<sub>1</sub> and B<sub>2</sub> on sphingolipid biosynthesis were studied in both primary rat hepatocytes and pig kidney epithelial cells (LLC-PK<sub>1</sub>).

Fumonisin were potent inhibitors of sphingolipid biosynthesis in hepatocytes (IC<sub>50</sub> of FB<sub>1</sub>= 0.1 μM), but over toxicity was not observed. In renal cells, fumonisins also inhibited sphingosine biosynthesis (IC<sub>50</sub> of FB<sub>1</sub> = 35μM), and caused decreased cell proliferation as well. Higher doses (> 70 μM) killed renal cells after exposure for 3 days. The reason for this is unknown, but may be related to the fact that hepatocytes undergo essentially no cell division during culture, whereas LLC-PK<sub>1</sub> renal cell divides rapidly. Alternatively long-term exposure to higher concentration of fumonisins could initiate toxic events

unrelated to cellular sphingolipids or fumonisins could initiate toxic event in LLC-PK1 cells as they are in primary rat hepatocytes.

There are several potential sites at which fumonisins might block the incorporation of serine into sphingosine. The pathway of sphingolipid biosynthesis begins with palmitoyl-CoA and serine. Under usual conditions, little 3-ketosphinganine accumulates, where there is a somewhat slower conversion of dihydroceramides to ceramides. Fumonisin inhibit sphinganine (dihydrosphingosine) *N*-acyltransferase (also called ceramide synthase), which results in an accumulation of sphinganine and reduced synthesis of more complex sphingolipids.

The inhibition of *de novo* sphingolipid was specific, appeared to be at the site of ceramide synthase and also fumonisins did not inhibit the incorporation of amino acids into lipids, phospholipids and fatty acids. The potent action of fumonisins on sphingolipid biosynthesis may be the mechanism of the known or suspected toxic effects of fumonisins that have been observed. Brain tissue is rich in sphingolipids, and the necrotic lesions observed in the brains of horses administered with fumonisins could be the end result of inhibition of sphingolipid biosynthesis. The tumor promoting activity of FB<sub>1</sub> might also be due to altered sphingolipids. Sphingosine is a potent inhibitor of protein kinase C. Because phorbol esters, and possibly other tumor promoters, are believed to exert their effect through stimulation of protein kinase C, sphingosine may act as an endogenous antitumour

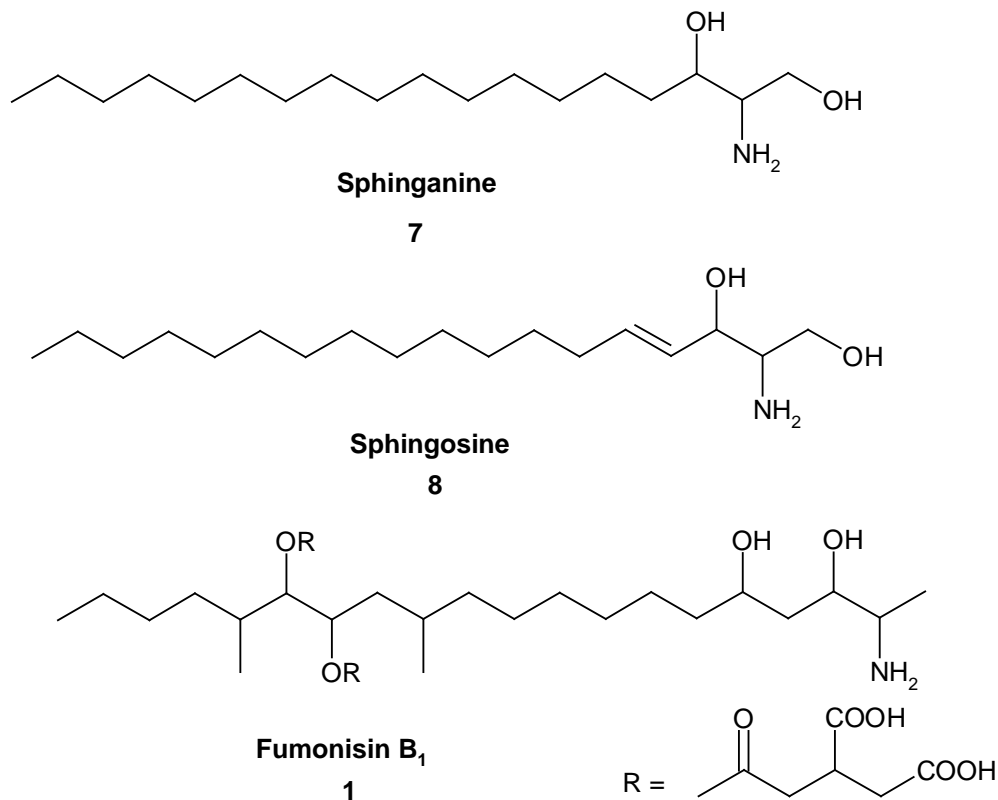
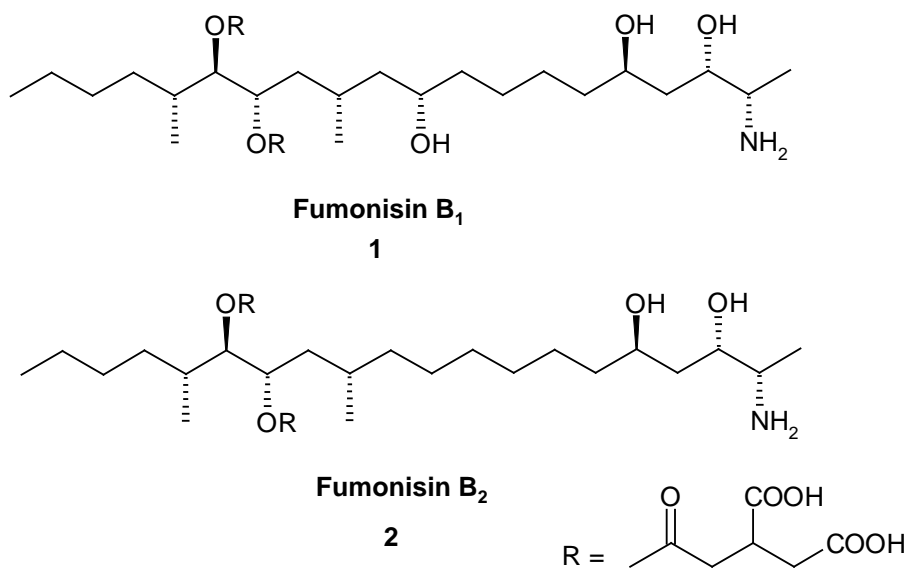

**Fig 2. Structural similarity of Fumonisin B<sub>1</sub> and sphingoid bases**

agent. Thus, the fumonisin induced inhibition of *de novo* sphingosine biosynthesis may lead to deregulation of protein kinase C which in turn alters the biochemical events that lead to proliferation of initiated cells.<sup>6</sup> Finally, the fumonisins are the first compounds that have potent, apparently specific, inhibitory effects on sphingosine biosynthesis. As such, they will be valuable in studies of complex biochemical events involved in sphingolipid metabolism and function. Furthermore, fumonisin may serve as a template for development of therapeutic agents for treatment of disease related to sphingolipid turnover, such as Forbers's disease.<sup>7</sup> Coupled with detection of fumonisins in commercially based food products in worldwide, the biological activity has drawn considerable attention to the fumonisin family of mycotoxin. Considerable efforts for elucidating relative and absolute configuration of both fumonisin B<sub>1</sub> **1** and fumonisin B<sub>2</sub> **2** have allowed to establish their structures as shown in **Fig 3**. The 2D structure of fumonisin B<sub>1</sub> was reported by Bezuidenhout *et al.*<sup>2</sup> by the combination of mass and NMR spectra analysis. The complete relative and absolute stereochemistry of the ten chiral centers present in fumonisin B<sub>1</sub> was reported by Hoye's group by the series of derivatization and degradation studies.<sup>8</sup> Kishi *et al.* have recently reported complete



stereochemistry of FB<sub>2</sub> and its first total synthesis.<sup>9</sup> Gurjar *et al.*<sup>10</sup> have reported hydrolyzed product fumonisin B<sub>1</sub>-AP utilizing carbohydrates as chiral raw materials. The biological activity of fumonisin B<sub>1</sub> and its complex structure attracted us to attempt its synthesis.



**Fig. 3**

## 5.2 Review of Literature

**Kishi *et al.* (1997)<sup>9c</sup>**

The first total synthesis of fumonisin B<sub>2</sub> was achieved by Kishi and co-workers by adopting convergent approach. Fumonisin B<sub>2</sub> was divided into three fragments. The synthesis of fragment **14** began with coupling of the chiral alkyne **9** with the triflate **10** to give the alkyne **11**. The alkyne **11** was converted to *trans*-alkene acid **12** using standard organic transformation as shown in **Scheme 1**. The vicinal hydroxyl groups at C<sub>14</sub> and C<sub>15</sub> were stereoselectively introduced on the backbone of **12** in three steps by iodolactonisation of **12** under equilibrium conditions to the iodo lactone **13** and ring opening of the lactone to yield C<sub>14</sub> and C<sub>15</sub> epoxide benzyl ester, with concomitant epoxide ring opening, to furnish the lactone alcohol with the desired stereochemistry at both C<sub>14</sub> and C<sub>15</sub>. The lactone alcohol was reduced to a triol, the

two vicinal hydroxyl groups were protected as an acetonide, and Swern oxidation of the resultant primary alcohol furnished the left segment **14**.

The synthesis of other fragment **19** is outlined in **Scheme 2**. Alkylation of  $\alpha$ -amino aldehyde **15** with Brown's chiral (-)-B-allyldiisopinocampheyl borane gave *syn*-amino alcohol **16** which was protected as an acetonide. Ozonolysis of alkene provided aldehyde, which was then reacted with (+)-B-allyldiisopinocampheyl borane to give the *anti*-alcohol **17**. Acetonide deprotection followed by benzyl group protection provided an alkene, which was transformed into an aldehyde by ozonolysis and subsequent two carbon chain elongation followed by hydrogenation to afford **18**. The ester group of **18** was reduced and converted to the phosphonium salt using standard organic transformation to furnish **19**.

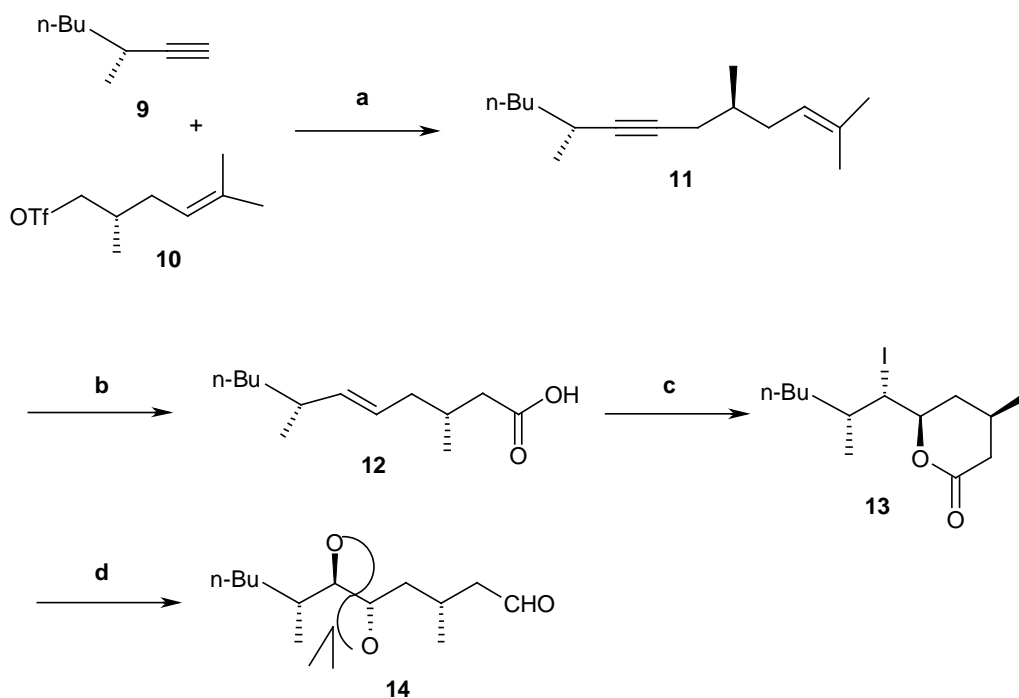

**Scheme 1**

**Scheme 1 : Reaction conditions :** (a) *n*-BuLi, then **10**, 70% ; (b) (i) K<sub>2</sub>OsO<sub>4</sub>·2H<sub>2</sub>O (cat) ; (ii) Pb(OAc)<sub>4</sub> ; (iii) NaBH<sub>4</sub> ; (iv) Na/liq. NH<sub>3</sub> ; (v) (COCl)<sub>2</sub>, DMSO, Et<sub>3</sub>N ; (vi) NaClO<sub>2</sub> , 77% ; (c) I<sub>2</sub>, CH<sub>3</sub>CN, -30 °C, 84% ; (d) (i) BnONa, (ii) H<sub>2</sub>/Pd on C, *p*-TSOH (cat.) ; (iii) LiAlH<sub>4</sub> ; (iv) *p*-TsOH (cat.)/acetone ; (v)(COCl)<sub>2</sub>,DMSO, Et<sub>3</sub>N, -78 °C, 79%.

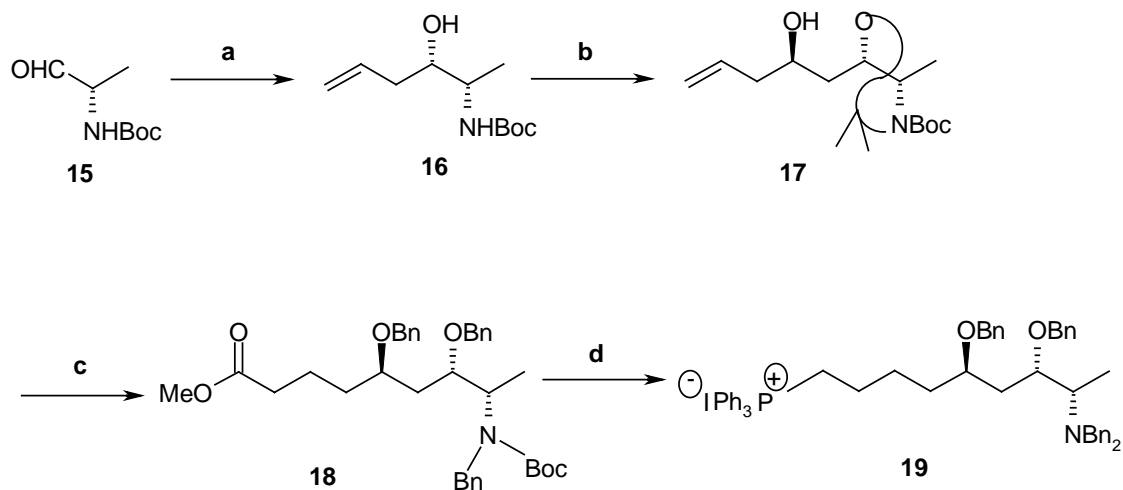

**Scheme 2**

**Scheme 2 : Reaction conditions :** (a) (-)-Ipc<sub>2</sub>B-allyl, 75% ; (b) (i) *p*-TsOH(cat.)/acetone ; (ii) O<sub>3</sub>, then Me<sub>2</sub>S ; (iii) (+)-Ipc<sub>2</sub>B-allyl, 65% ; (c) (i) *p*-TsOH (cat.)/MeOH ; (ii) NaH, BnBr, TBAI ; (iii) O<sub>3</sub>, then Me<sub>2</sub>S ; (iv) (OMe)<sub>2</sub>POCH<sub>2</sub>COOMe/NaH ; (v) H<sub>2</sub>/Lindlar cat., 70% ; (d) (i) TFA/CH<sub>2</sub>Cl<sub>2</sub> ; (ii) BnBr, K<sub>2</sub>CO<sub>3</sub> ; (iii) DIBAL-H, 75% ; (iv) I<sub>2</sub>, PPh<sub>3</sub>, imidazole ; (v) PPh<sub>3</sub>/CH<sub>3</sub>CN, reflux, 75%.

As shown in **Scheme 3** the coupling between **14** and **19** in the presence of *n*-BuLi through Wittig olefination gave **20**. At this stage the benzyl protected TCA segment was installed. Subsequent hydrogenation gave fumonisins B<sub>2</sub>.

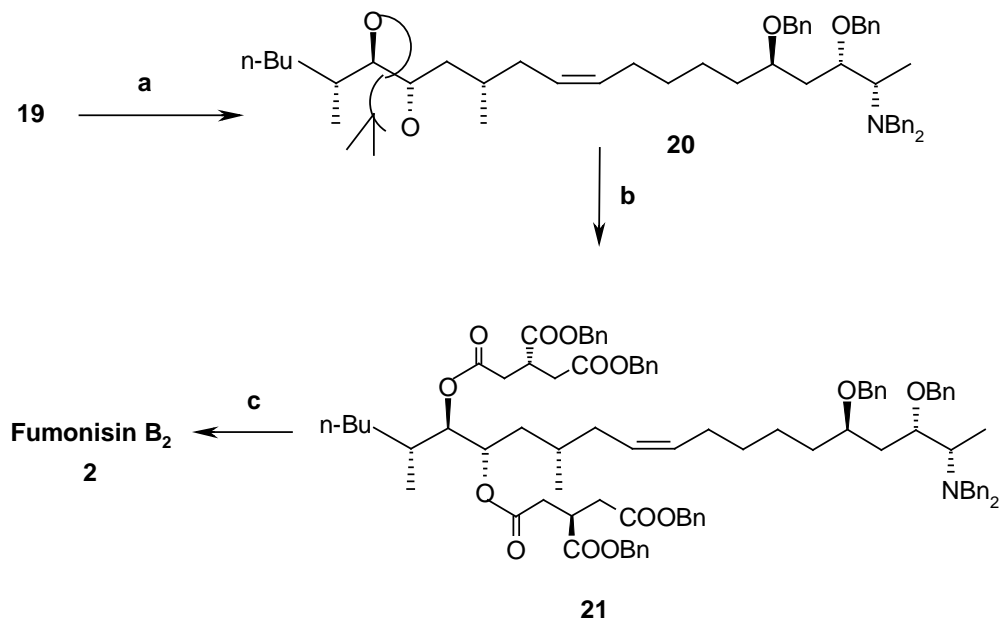

**Scheme 3**

**Scheme 3 : Reaction conditions :** (a) *n*-BuLi, then **14**, 80% ; (b) (i) TFA-H<sub>2</sub>O ; (ii) benzyl protected TCA, EDCI, DMAP ; (c) H<sub>2</sub>, Pd(OH)<sub>2</sub> on carbon, H<sup>+</sup>, *t*-BuOH-THF, 60%.

### Gurjar *et al.* (1998)<sup>10</sup>

Gurjar *et al.* have accomplished total synthesis of fumonisin B<sub>1</sub>-AP as its hexa acetate derivative **42** starting from carbohydrate as raw materials. A convergent approach was adopted to synthesize fumonisin B<sub>1</sub>-AP **42** with the molecule being divided into two fragments **32** and **39**. Both fragments were synthesized starting from D-Glucose and D-glucosamine respectively. D-glucose **22** was converted into the 5-ulose derivative **23**<sup>12</sup> which was subsequently converted into olefin by reacting with ylide Ph<sub>3</sub>P=CH-C<sub>3</sub>H<sub>7</sub>. This olefin then underwent palladium catalyzed reduction to give mixture of diastereomers which were easily separated by column chromatography to give compound **24** as single diastereomer. The inversion of configuration at C-3 in **24** was effected in four steps involving oxidation-reduction protocol to give **25**. Under acidic conditions, compound **25** underwent isopropylidene cleavage to give diol which was cleaved by NaIO<sub>4</sub> to give the aldehyde and its Wittig-Horner olefination followed by lactonisation gave **27**. In order to induce maximum

stereoselectivity during hydrogenation of the olefin, lactone **27** was converted to lactol **28**. Treatment with isopropanol and CSA, followed by reduction with Rh-Al<sub>2</sub>O<sub>3</sub> gave the exclusive product **29**. Hydrolysis of the O-glycoside bond and one carbon Wittig olefination gave olefin **30**. Its benzyl derivative was then subjected to hydroboration-oxidation and Swern oxidation to provide the aldehyde **31**. Addition of propargyl bromide to **31** followed by stereochemical identification of the required diastereomer as confirmed by modified Mosher ester method gave alkyne **32** (Scheme 4).

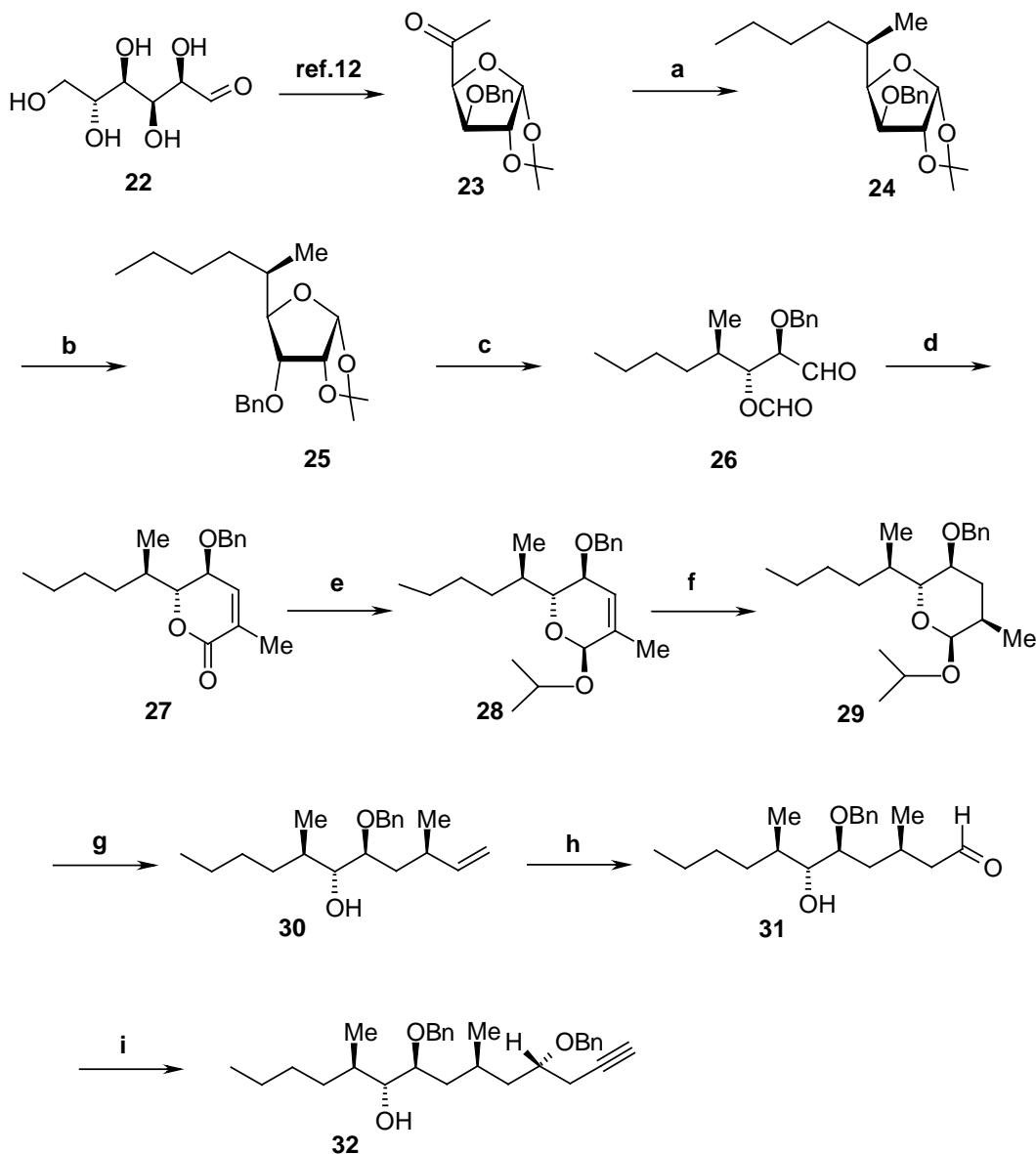

Scheme 4

**Scheme 4 : Reaction conditions** : (a) (i)  $C_4H_9P^+Ph_3Br^-$ , *n*-BuLi, THF,  $-78-0^\circ C$ , 3 h, 86% ; (ii) Pd/C,  $H_2$ , EtOAc, 7 h, 50% ; (b) (i) Ca/liq. $NH_3$ ,  $Et_2O$ , 1 h ; (ii) IBX, DMSO, rt, 20 h ; (iii)  $NaBH_4$ , MeOH,  $0^\circ C$ , 3 h ; (iv) BnBr, NaH, THF, rt, 72% ; (c) (i) 70% aq.  $CH_3COOH$ ,  $H_2SO_4$  (cat), rt, 12 h ; (ii)  $NaIO_4$ , MeOH: $H_2O$  (8:2), rt, 3 h, 77% ; (d) (i)  $(MeO)_2P(O)CH(CH_3)COOEt$ , NaH, THF,  $-78^\circ C$ , 5 h ; (ii)  $K_2CO_3$ , MeOH, rt, 1 h, 88% ; (e) (i) DIBAL-H, PhMe,  $-78^\circ C$ , 30 min ; (ii)  $iPrOH$ , CSA,  $0^\circ C$ , 2 h, 98% ; (f) Rh- $Al_2O_3$ ,  $H_2$ , 1 atm,  $Et_2O$ ,  $0-5^\circ C$ , 10 min, 98% ; (g) (i) 70% aq.  $CH_3COOH$ , (cat.),  $H_2SO_4$ , rt, 10 h ; (ii)  $CH_3P^+Ph_3I^-$ , *n*-BuLi, THF,  $-78^\circ C-0^\circ C$ , 2 h, 78% ; (iii) BnBr, NaH, THF, rt, 3 h ; (h) (i) 9-BBN, THF, NaOH,  $H_2O_2$ , rt, 5 h ; (ii)  $(COCl)_2$ , DMSO,  $Et_3N$ ,  $CH_2Cl_2$ ,  $-78^\circ C$ , 45 min, 82% ; (i) (a)  $C_3H_3Br$ , Zn dust, aq.  $NH_4Cl$ , THF, rt, 12 h, 70% ; (b) NaH, BnBr, rt, 85%.

Synthesis of  $C_1-C_6$  segment **39** was investigated from D-glucosamine hydrochloride **33**. It was converted into the *N*-phthalimido methyl glycoside **34**.<sup>13</sup> Subsequent cleavage of benzylidene group and selective protection of O-6 with TBS-Cl gave **35**. The deoxygenation at C-4 of **35** was accomplished by Barton radical deoxygenation leading to the 4-deoxy product **36**. Opening of glucose ring, desulfurisation and subsequent protection gave **38**. Transformation of **38** into the epoxide derivative **39** was achieved in four steps as shown in **Scheme 5**.

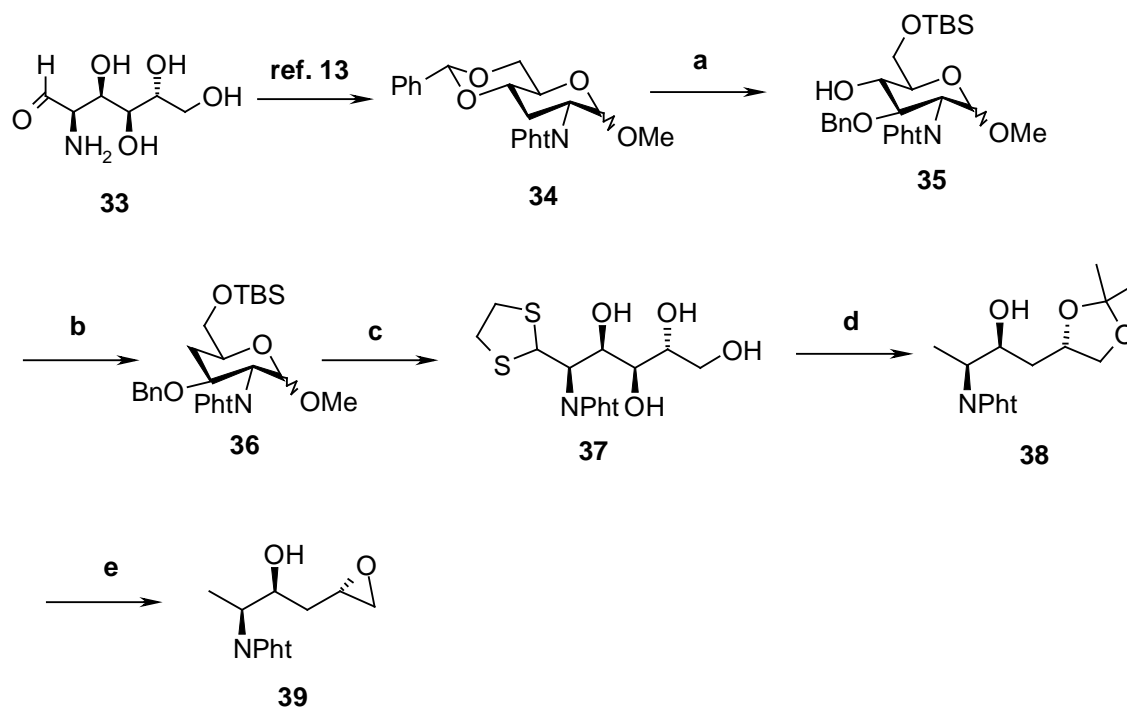

**Scheme 5**

**Scheme 5 : Reaction conditions :** (i) 60% aq. CH<sub>3</sub>COOH, 50 °C, 5 h ; (ii) TBS-Cl, imidazole, CH<sub>2</sub>Cl<sub>2</sub>, rt, 3 h, 81% ; (b) (i) NaH, CS<sub>2</sub>, MeI, THF, rt, 2 h ; (ii) Bu<sub>3</sub>SnH, AIBN (cat.), PhMe, reflux, 2 h, 80% ; (c) (i) MeOH, *p*-TSA, rt, 1 h ; (ii) BF<sub>3</sub>.Et<sub>2</sub>O, HSCH<sub>2</sub>CH<sub>2</sub>SH, CH<sub>2</sub>Cl<sub>2</sub>, rt, 1 h, 92% ; (d) (i) Ra-Ni, EtOH, rt, 3 h, 85% ; (ii) (CH<sub>3</sub>CH<sub>2</sub>)<sub>2</sub>CO, CSA, CH<sub>2</sub>Cl<sub>2</sub>, rt, 1 h, 92% ; (e) (i) NaH, BnBr, THF, rt, 3 h ; (ii) MeOH, *p*-TSA, rt, 2 h ; (iii) TsCl, Py, CH<sub>2</sub>Cl<sub>2</sub>, 0 °C, 12 h ; (iv) NaH, THF, 0 °C, 30 min, 52%.

The C-C bond coupling<sup>14</sup> between **32** and **39** was performed with *n*-BuLi-BF<sub>3</sub>.Et<sub>2</sub>O as a mediator to give **40**. The removal of phthalimido group, followed by acetylation afforded **41** which was exhaustively hydrogenolysed over Pd(OH)<sub>2</sub> to afford fumonisin B<sub>1</sub>-AP derivative **42**. (**Scheme 6**)

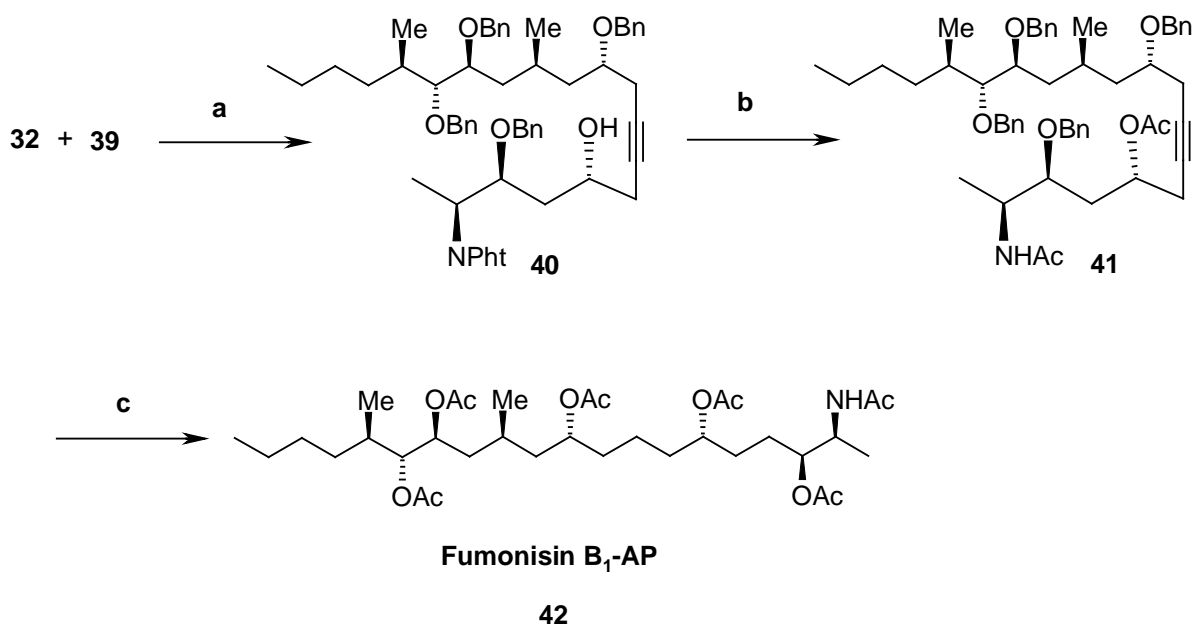

**Scheme 6**

**Scheme 6 : Reaction conditions :** (a) *n*-BuLi, BF<sub>3</sub>.Et<sub>2</sub>O, THF, -78 °C, 40 min, 73% ; (b) (i) MeNH<sub>2</sub>-MeOH, reflux, 2.5 h ; (ii) Ac<sub>2</sub>O, Et<sub>3</sub>N, CH<sub>2</sub>Cl<sub>2</sub>, rt, 1 h, 85% ; (c) (i) Pd(OH)<sub>2</sub>, H<sub>2</sub>, MeOH, 12 h ; (ii) Ac<sub>2</sub>O, Et<sub>3</sub>N, CH<sub>2</sub>Cl<sub>2</sub>, 1 h, 95%.

### 5.3 Present work

## **Objective**

The challenging structure, biological importance, and only one total synthesis of fumonisin B<sub>2</sub><sup>9c</sup> and fumonisin B<sub>1</sub>-AP<sup>10</sup> attracted us to develop a flexible strategy for its synthesis. A modern synthetic design demands high efficiency reaction sequences with minimal synthetic steps coupled with mild reaction conditions, maximum stereoselectivity, good yields and readily available raw materials. Keeping these features in mind, we have accomplished C<sub>1</sub>-C<sub>6</sub> fragment of fumonisin B<sub>2</sub> (right hand fragment) starting from chiral pool material (*S*)-malic acid.

## **Retrosynthetic analysis and strategy**

Fumonisin B<sub>2</sub> has a striking molecular assembly comprising of twenty two carbons, forty seven hydrogens, five oxygens and one nitrogen. The most interesting structural feature of FB<sub>2</sub> is the presence of a linear twenty carbon chain possessing eight distinct chiral centers and four methylene units. Retrosynthetic analysis of right hand fragment **45** of fumonisin B<sub>2</sub> is shown in **Scheme 7**. We envisioned that compound **46**, an ultimate precursor for **45** could be derived from Sharpless asymmetric aminohydroxylation of **47** which in turn would be obtained from chiral pool material (*S*)-malic acid. In an alternative strategy compound **50** could be visualized an immediate precursor for **45** which would be obtained from **51**. Compound **51** in turn could be prepared from Sharpless kinetic resolution of a secondary alcohol **52** which would be derived from (*S*)-malic acid **49**.



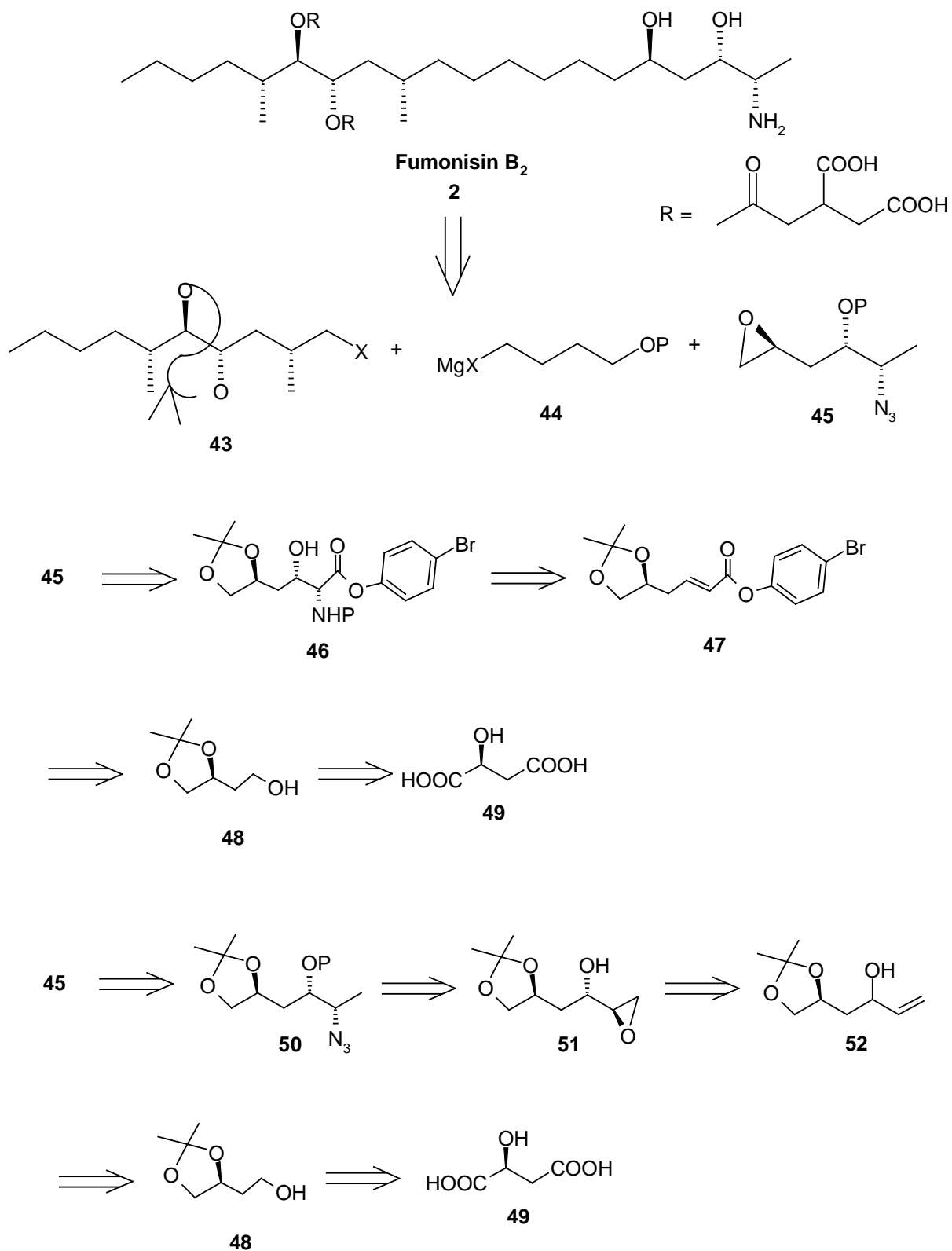

**Scheme 7 : Retrosynthetic analysis of right hand side fragment 45**

## 5.4 Results and Discussion

The detailed synthetic route which involves Sharpless asymmetric aminohydroxylation is shown in **Scheme 8**. (*S*)-Malic acid was esterified with 5% HCl in MeOH at room temperature to furnish the diester **53** in 75% yield as a colorless liquid. The  $^1\text{H}$  NMR spectrum of **53** showed two singlets for the two methoxy groups at  $\delta$  3.66 and 3.76 indicating formation of diester. The selective reduction of diester **53** using borane dimethyl sulphide in the presence of catalytic amount of  $\text{NaBH}_4$  gave the diol **54** as a syrupy liquid in 82% yield. The protection of diol **54** with 2,2-dimethoxypropane gave the acetonide **55** in 91% yield as a colorless oil. The  $^1\text{H}$  NMR spectrum of **55** showed acetonide methyls at  $\delta$  1.32 and 1.37 as singlets. In the  $^{13}\text{C}$  NMR spectrum, acetonide carbons appeared at  $\delta$  24.91, 26.09 (for two methyls) and  $\delta$  107.84 for *tertiary* carbon. The reduction of acetonide ester **55** using  $\text{LiAlH}_4$  gave the alcohol **48** in good yield. Oxidation of primary hydroxyl group in **48** under Swern oxidation conditions gave the corresponding aldehyde ( $\delta$  9.78, singlet in  $^1\text{H}$  NMR spectrum), which on subsequent Wittig-Horner reaction with diethyl-(*p*-bromophenyl)-phosphonate afforded the requisite olefin **47**. Following the Panek protocol<sup>15</sup> which describes the preparation of  $\alpha$ -amino- $\beta$ -hydroxy systems by using aryl esters instead of aliphatic esters, the olefin **47** was subjected to asymmetric aminohydroxylation using chloramine-T as nitrogen source, potassium osmate as oxidant and  $(\text{DHQ})_2\text{AQN}$  as chiral ligand to give the desired amino alcohol **46**. The  $^1\text{H}$  NMR and  $^{13}\text{C}$  NMR spectrum showed the formation of product, but isolated yield of aminohydroxy product **46** was only 27% along with by-product *p*-toluenesulfonamide. To improve the yield, we attempted at this reaction using several

nitrogen sources such as chloramine-M, *N*-bromoacetamide and benzyl carbamate but in all these cases the isolated yield was very poor.

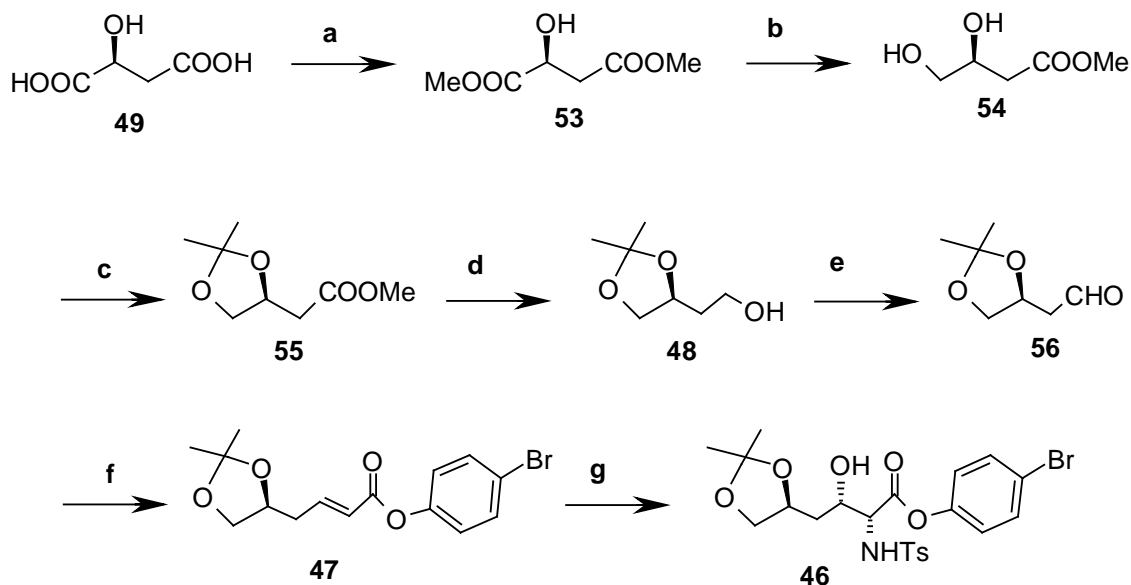

**Scheme 8**

**Scheme 8 : Reaction conditions :** (a) HCl, MeOH, rt, overnight, 75% ; (b)  $\text{BH}_3 \cdot \text{Me}_2\text{S}$ ,  $\text{NaBH}_4$  (cat), dry THF, 3 h, 82% ; (c) 2,2-DMP, dry DCM, *p*-TSA (cat), overnight, 91% ; (d)  $\text{LiAlH}_4$ , dry THF, 0 °C-rt, 24 h, 91% ; (e)  $(\text{COCl})_2$ , dry DMSO,  $\text{Et}_3\text{N}$ , -78 °C ; (f) *p*-(bromophenyl)-diethylphosphonoacetate, NaH, 0 °C-rt, 4 h, 70% ; (g) chloramine-T,  $(\text{DHQ})_2\text{AQN}$ , potassium osmate, *t*-BuOH:H<sub>2</sub>O (1:1), 3 h, 27%

Therefore, in order to arrive at the target molecule in reasonably good yield and to fix the amino alcohol functionality, we designed an alternative synthetic route starting from the same starting material which involved Sharpless kinetic resolution as the key step. Accordingly, the aldehyde **56** was treated with vinylmagnesium bromide (which we prepared from vinyl bromide and Mg) at -78 °C to furnish the alcohol in 72% yield. The IR spectrum showed the presence of hydroxyl and olefin stretching at 3442 and 1602  $\text{cm}^{-1}$

<sup>1</sup> respectively and in the <sup>1</sup>H NMR spectrum olefin peaks appeared at  $\delta$  5.12 as dd for two protons and 5.83-5.96 as multiplet for one proton. In the <sup>13</sup>C NMR spectrum olefin peaks appeared at  $\delta$  113.7 and 114.3. The diastereomeric ratio observed was 60:40. The secondary allylic alcohol **52** was subjected to Sharpless kinetic resolution using (+)-DET, titanium tetrakisopropoxide and *t*-butylhydrogen peroxide at  $-20$  °C for 2.5 days to give chiral hydroxy olefin **57** and epoxy alcohol **51** in good yield based on conversion (55:45). The required chiral epoxy alcohol **51** was characterized using spectroscopic methods. The IR spectrum of **51** showed hydroxyl absorption stretching at  $3489$   $\text{cm}^{-1}$ . In the <sup>1</sup>H NMR spectrum olefin peaks disappeared and epoxide  $-\text{CH}_2-$  appeared at  $\delta$  3.55-3.69 as multiplet. The diastereomeric excess was measured using <sup>13</sup>C NMR spectrum and found to be 93%.

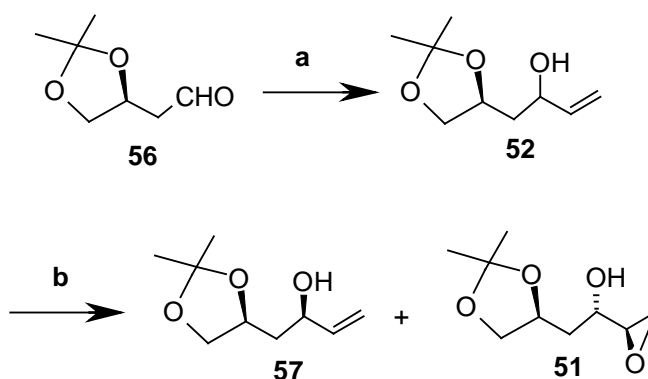

**Scheme 9**

**Scheme 9 : Reaction conditions :** (a) vinylmagnesium bromide, dry THF,  $-78$  °C, 72% ; (b) (+)-DET,  $\text{Ti}(\text{O}^i\text{Pr})_4$ , TBHP, dry DCM, molecular sieves 3 °A,  $-20$  °C, 2.5 days, 72%.

With substantial amount of **51** in hand, we then proceeded to install the amino alcohol functionality with desired stereochemistry which is present in fumonisins right hand side fragment. Towards this end, the chiral epoxy alcohol **51** obtained from Sharpless kinetic

resolution, was subjected to series of standard organic transformation (**Scheme 10**). Thus, the protection of free hydroxyl group in **51** as benzyl ether was achieved using NaH and benzyl bromide. The IR spectrum of **58** showed absence of hydroxyl stretching and in the  $^1\text{H}$  NMR and  $^{13}\text{C}$  NMR spectra phenyl group and benzylic  $-\text{CH}_2-$  appeared at  $\delta$  7.32-7.44 (m), 4.52 (s) and 127-133, 103.8 respectively. Regioselective opening of epoxide **58** was achieved using  $\text{LiAlH}_4$  in dry THF. The IR spectrum of **58** showed strong hydroxyl absorption at  $3422\text{ cm}^{-1}$ . In the  $^1\text{H}$  NMR spectrum, methyl peak appeared at  $\delta$  1.21 as doublet. To get the 'syn' amino alcohol functionality, the free hydroxy of **59** was converted to azido compound **61** in  $\text{S}_{\text{N}}2$  manner. Towards this aim, compound **59** was treated with *p*-toluenesulfonyl chloride and pyridine as base in dry DCM to give **60** in excellent yield. In the  $^1\text{H}$  NMR spectrum methyl peak corresponding to tosyl group appeared at  $\delta$  2.21 (s) and related aromatic peaks appeared at  $\delta$  7.77 (d) and 7.82 (d). Compound **60** was treated with  $\text{NaN}_3$  in dry DMF to furnish **61** in good yield. The IR spectrum of **61** showed the presence of azide functionality at  $2122\text{ cm}^{-1}$ . Subsequent deprotection of acetonide group of **61** using *p*-toluenesulfonic acid in methanol afforded diol which was treated with *p*-toluenesulfonyl chloride, triethyl amine and catalytic amount of dibutyltin oxide to give **62** which was confirmed by spectroscopic methods. Finally, compound **62** was treated with  $\text{K}_2\text{CO}_3$  in methanol, to furnish epoxide **45** in good yield. The  $^1\text{H}$  NMR and  $^{13}\text{C}$  NMR spectrum of **45** showed absence of tosyl peaks and epoxide  $-\text{CH}_2$  peaks appeared at  $\delta$  2.16 (d) and  $\delta$  47.6 respectively.

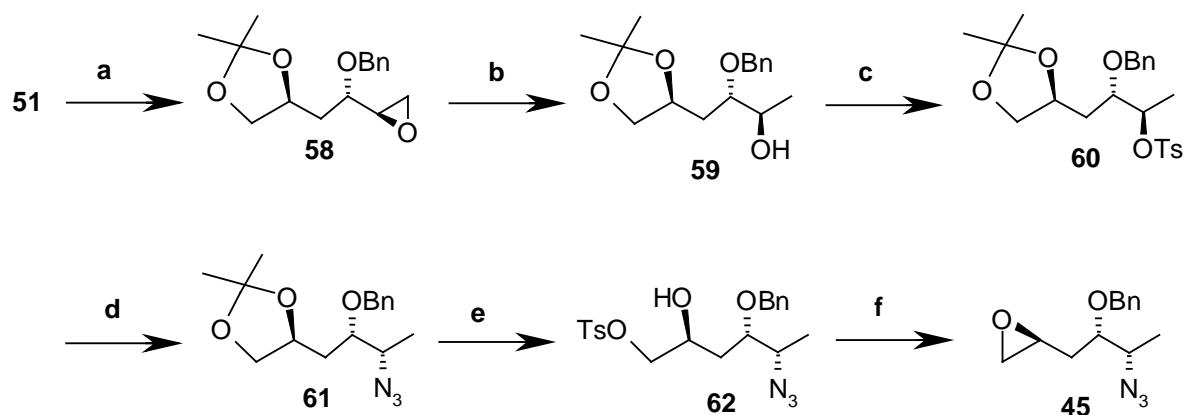

**Scheme 10**

**Scheme 10 : Reaction conditions :** (a) BnBr, NaH, dry THF, 83% ; (b) LiAlH<sub>4</sub>, dry THF, 24 h, rt, 84% ; (c) *p*-TsCl, pyridine, 0 °C-rt, 84% ; (d) NaN<sub>3</sub>, dry DMF, 70 °C, 76% ; (e) (i) 10% aq. HCl, THF, 40 °C ; (ii) *p*- TsCl, Bu<sub>2</sub>SnO, triethyl amine, dry CH<sub>2</sub>Cl<sub>2</sub>, 0 °C , 1 h, 67% ; (f) K<sub>2</sub>CO<sub>3</sub>, MeOH, 0 °C, 2 h, 73%.

## 5.5 Conclusion

In summary, we have accomplished an efficient synthesis of right hand side fragment of fumonisin B<sub>2</sub> starting from commercially available (*S*)-malic acid. As the asymmetric aminohydroxylation was not very efficient to install the amino alcohol functionality in the synthesis, the Sharpless kinetic resolution method was successfully employed to synthesize the amino alcohol fragment in overall good yield.

## 5.6 Experimental section

### General Information

Solvents were purified and dried by standard procedures before use. Petroleum ether of boiling range 60-80 °C was used. Optical rotations were measured using sodium D line on JASCO-181 digital polarimeter. Infrared spectra were recorded on a Perkin-Elmer model 683 grating Infrared spectrometer. <sup>1</sup>H NMR (200 MHz) and <sup>13</sup>C (50 MHz) NMR spectra were recorded in CDCl<sub>3</sub> solution with residual CHCl<sub>3</sub> ( = 7.27 ppm) as internal standard. Elemental analyses were carried out on a Carlo Erba CHNS-O analyzer. Diastereomeric excess was determined using <sup>13</sup>C NMR spectroscopy. Column chromatography was performed on silica gel (60-120 mesh) using a mixture of petroleum ether and ethyl acetate as eluent.

### Preparation of (S)-Dimethyl malate

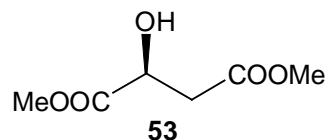

(S)-Malic acid **49** (5 g, 37.28 mmol) was placed in 250 mL single neck round bottom flask. To this methanol (30 mL) and catalytic amount of HCl was added. The reaction mixture was stirred overnight and neutralized with solid sodium bicarbonate and filtered off. The residue was distilled under vacuum to give dimethyl malate **53** as a colorless oil (bath temperature 140-145 °C/10 mm). The residual material in the distillation flask was dissolved in 5% HCl in MeOH and stirred overnight and the remaining process repeated as above to give 4.52 g of **53**.

**Yield :** 75%

$[\alpha]_D^{25}$  : -6.5 (c 1, EtOH) [lit.<sup>16</sup>  $[\alpha]_D^{25}$  : -6.9 (neat)]

**IR(neat, cm<sup>-1</sup>) :**  $\nu_{\max}$  3452, 3014, 2950, 1734, 1438

**<sup>1</sup>H NMR (200 MHz, CDCl<sub>3</sub>) :**  $\delta$  2.78 (t, *J* = 4 Hz, 2H), 3.20 (brs, 1H, OH), 3.66 (s, 3H), 3.76 (s, 3H), 4.45-4.50 (m, 1H)

**<sup>13</sup>C NMR (50 MHz, CDCl<sub>3</sub>) :**  $\delta$  38.0, 51.4, 52.1, 66.7, 170.6, 173.3

### Preparation of (3S)-3,4-Dihydroxy-butyrac acid methyl ester

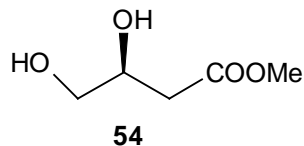

To a solution of dimethyl malate **53** (10 g, 61.7 mmol) in 100 mL of anhydrous THF was added dropwise over 15 min. 5.85 mL (61.7 mmol) of boranedimethyl sulphide. After stirring for 30 min NaBH<sub>4</sub> (0.12 g, 3.08 mmol) was added and mixture stirred for 1 h. 50 mL of methanol was added and after stirring for 2.5 h, solvents were removed in vacuo. The residue was purified by flash chromatography using pet. ether:ethyl acetate (6:4) to give 6.82 g of diol **54** as a syrupy liquid.

**Yield :** 82%

$[\alpha]_D^{25}$  : -52.3 (*c* 1, CHCl<sub>3</sub>) [lit.<sup>17</sup>  $[\alpha]_D^{25}$  : -6.9 (neat)]

IR (CHCl<sub>3</sub>, cm<sup>-1</sup>) :  $\nu_{\max}$  3420-3321, 1722, 2849, 1422

<sup>1</sup>H NMR (200 MHz, CDCl<sub>3</sub>) :  $\delta$  2.46 (dd, *J* = 16.2, 4.6 Hz, 1H), 2.54 (dd, *J* = 16.2, 8.0 Hz, 1H), 2.90 (t, *J* = 6.0 Hz, 1H), 3.43-3.53 (m, 1H), 3.61-3.64 (m, 2H), 3.69 (s, 3H), 4.05-4.15 (m, 1H)

<sup>13</sup>C NMR (50 MHz, CDCl<sub>3</sub>) :  $\delta$  37.4, 51.9, 65.7, 68.4, 173.0

**Preparation of 2-[4(S)-(2, 2-Dimethyl-1, 3)-dioxolan-4-yl]-acetic acid methyl ester**

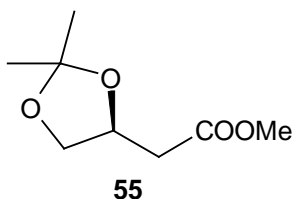

To a solution of diol ester **54** (6 g, 44.77 mmol) in dry CH<sub>2</sub>Cl<sub>2</sub> (40 mL) was added 2,2-dimethoxypropane (13.5 mL, 0.11 mol) and catalytic amount of *p*-TSA. The reaction mixture was stirred 12 h at room temperature. To this, solid sodium bicarbonate was added and filtered off. The residue was purified by column chromatography using petroleum ether:ethyl acetate (8:2) to give acetonide ester **55** as a colorless oil (7.08 g).

**Yield** : 91%

$[\alpha]_D^{25}$  : -5.3 (*c* =1, CHCl<sub>3</sub>)

IR(neat, cm<sup>-1</sup>) :  $\nu_{\max}$  1712, 1346, 1210, 1163, 1148, 844.

<sup>1</sup>H NMR (200 MHz, CDCl<sub>3</sub>) :  $\delta$  1.32 (s, 3H), 1.37 (s, 3H), 2.6 (dd, *J* = 16, 8 Hz, 2H), 3.57-3.65 (m, 1H), 3.66 (s, 3H), 4.08-4.15 (m, 1H), 4.43 (q, *J* = 16 Hz, 1H)

<sup>13</sup>C NMR (50 MHz, CDCl<sub>3</sub>) :  $\delta$  25.0, 26.3, 38.2, 51.2, 68.6, 71.6, 108.7, 170.59

**Analysis** : C<sub>8</sub>H<sub>14</sub>O<sub>4</sub> (174.19) requires C, 55.16 ; H, 8.10 ; Found. C, 55.13 ; H, 8.08

**Preparation of 2-[(4S)-2,2-Dimethyl-1,3-dioxolan-4-yl] ethanol**

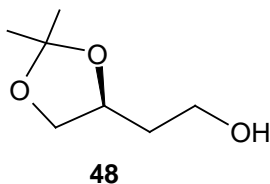



In a two neck 500 mL round bottom flask was placed LAH (1.09 g, 28.73 mmol) and to this was added 200 mL of dry THF followed by dropwise addition of acetonide ester **55** (5 g, 28.73 mmol) at 0 °C and stirring was continued for 24 h at ambient temperature. The reaction mixture was quenched with water and ethyl acetate and filtered off. The residue was distilled under vacuum to give the acetonide alcohol **48** (3.83 g) as a colorless oil.

**Yield :** 91%

$[\alpha]_D^{20}$  : -3.89 ( $c = 1$ , MeOH) [lit.<sup>18</sup>  $[\alpha]_D^{25} = -2.23$  ( $c = 9.8$ , MeOH)]

**IR (neat,  $\text{cm}^{-1}$ ) :**  $\nu_{\text{max}}$  3395, 2972, 2930, 2873, 1387, 1212, 1148, 1048, 844.

**$^1\text{H NMR}$  : (200 MHz,  $\text{CDCl}_3$ ) :**  $\delta$  1.28 (s, 3H), 1.33 (s, 3H), 1.80 (q,  $J = 6$  Hz, 2H), 3.07 (s, 1H), 3.57 (t,  $J = 8$  Hz, 1H), 3.77 (t,  $J = 6$  Hz, 2H), 4.07 (dd,  $J = 2, 6$  Hz, 1H), 4.13-4.22 (m, 1H).

**$^{13}\text{C NMR}$  (50 MHz,  $\text{CDCl}_3$ ) :**  $\delta$  24.9, 26.0, 35.5, 58.3, 68.6, 73.1, 107.8

**Preparation of (2,2-Dimethyl-[1,3]-dioxolan-4-yl)-acetaldehyde**

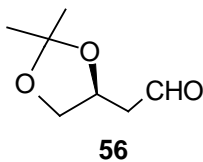

To a solution of oxalyl chloride (4.48 mL, 51.36 mmol) in dry  $\text{CH}_2\text{Cl}_2$  (80 mL) at  $-78$  °C was added dropwise dry DMSO (7.1 mL, 0.1 mol) in dry  $\text{CH}_2\text{Cl}_2$  (10 mL). After 20 min of stirring, alcohol **48** (5 g, 34.24 mmol) in dry  $\text{CH}_2\text{Cl}_2$  (10 mL) was added dropwise over 30 min giving a copious white ppt. After stirring for 1 h at  $-60$  °C, triethyl amine (20.9 mL, 0.15 mol) was added and stirred for 1 h allowing the reaction mixture to warm to room temperature. The reaction mixture was quenched with water and organic layer was separated. The aqueous layer was extracted with dichloromethane (3x100 mL). The combined organic layers were washed with saturated aq. sodium bicarbonate (100 mL), brine (100 mL) and dried over  $\text{Na}_2\text{SO}_4$  and passed through a short pad of silica gel. The filtrate was concentrated to give the aldehyde **56** as a pale yellow oil. This was used for the next step without further purification.

### Preparation of *p*-(bromophenyl)-diethylphosphonoacetate

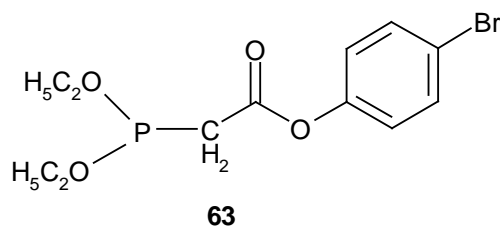

To a stirred solution of diethylphosphonoacetic acid (3 g, 15.29 mmol) in dry DCM (30 mL) was added *p*-bromo phenol (2.64 g, 15.29 mmol), DCC ( 3.47 g, 16.82 mmol) and DMAP (0.18 g, 1.52 mmol) sequentially at 0 °C. After consumption of the starting material the reaction mixture was filtered through celite pad and concentrated to near dryness. The crude product was used as such in the next reaction.

<sup>1</sup>H NMR (200 MHz, CDCl<sub>3</sub>) : δ 1.38 (t, *J* = 8 Hz, 6H), 3.14 (s, 2H), 4.15-4.30 (m, 4H), 7.0 (d, *J* = 10 Hz, 2H), 7.5 (d, *J* = 10 Hz, 2H).

### Preparation of 4-(2,2-Dimethyl-[1,3]dioxolan-4-yl)-but-2-enoic acid-4-bromo-phenyl ester

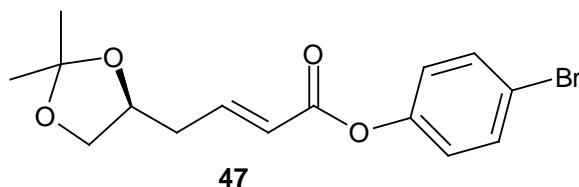

To a suspension of NaH (0.24 g, 6.11 mmol, 60% dispersion in oil) in dry THF (24 mL) at 0 °C was added a solution of *p*-(bromophenyl)-diethylphosphonoacetate **63** (2.14 g, 6.11 mmol) in dry THF (6 mL). The mixture was stirred for 10 min at 0 °C, then warmed to ambient temperature for 10 min. To this solution was added aldehyde **48** (0.8 g, 5.55 mmol) and the solution stirred for 4 h at ambient temperature. The reaction mixture was subsequently diluted with saturated NH<sub>4</sub>Cl (20 mL), extracted with ethyl acetate (3x30 mL), dried over Na<sub>2</sub>SO<sub>4</sub> and concentrated to near dryness. The crude product was then purified on silica gel column chromatography using 1% ethyl acetate in petroleum ether to give olefin **47** (1.32 g) as a yellow oil.

**Yield** : 70%

[α]<sub>D</sub><sup>25</sup> : -6.3 (*c* 0.74, CHCl<sub>3</sub>)

<sup>1</sup>H NMR (200 MHz, CDCl<sub>3</sub>) : δ 1.38 (s, 3H), 1.46 (s, 3H), 2.52-2.59 (m, 2H), 3.60-3.67 (m, 1H), 4.26 (d, *J* = 6 Hz, 2H), 6.1 (d, *J* = 16 Hz, 1H), 6.96 (d, *J* = 10 Hz, 2H), 7.16-7.20 (m, 1H), 7.49 (d, *J* = 10 Hz, 2H)

$^{13}\text{C}$  NMR (50 MHz,  $\text{CDCl}_3$ ) :  $\delta$  13.8, 20.8, 36.3, 60.6, 68.4, 117.0, 123.0, 132.0, 146.9, 147.6, 155.2, 170.0

**Preparation of 4-(2,2-Dimethyl-[1,3]dioxolan-4-yl)-3-hydroxy-2-(toluene-4-sulfonylamino)-butyric acid -4-bromo-phenyl ester**

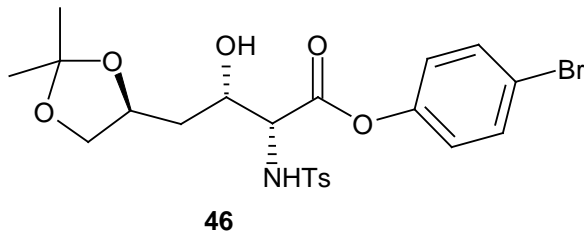

To a stirred solution of  $(\text{DHQ})_2\text{AQN}$  (50 mg, 0.058 mmol, 5 mol%) in *t*-BuOH (5 mL) and water (5 mL) in 100 mL round bottom flask were added in order, olefin **47** (0.4 g, 1.17 mmol), chloramine-T trihydrate (0.98 g, 3.5 mmol) and  $\text{K}_2\text{Os}_2(\text{OH})_4$  (17 mg, 0.046 mmol, 4 mol%). The reaction flask immersed in a room temperature water bath and the slurry stirred for 1 h. Over the course of the reaction, the color changed from brown to deep green and then to yellow. After addition of aqueous sodium sulfite (500 mg in 7 mL of water), the phases were separated and the aqueous phase was extracted with ethyl acetate (3x20 mL). The combined organic extracts were washed with brine, dried over  $\text{Na}_2\text{SO}_4$  and concentrated to near dryness to give the crude product, which also contains the *p*-toluenesulfonamide by-product produced upon the reduction of excess chloramine-T. Flash chromatography (ethyl acetate/petroleum ether : 7:3) of this material provided **46** (0.17 g) as a colorless oil.

**Yield :** 27%

$[\alpha]_{\text{D}}^{25}$  : + 16.8 (*c* 1.32,  $\text{CHCl}_3$ )

**IR** (neat,  $\text{cm}^{-1}$ ) :  $\nu_{\text{max}}$  3367, 3267, 1750, 1412, 1323, 1222, 1056, 996

$^1\text{H}$  NMR (200 MHz,  $\text{CDCl}_3$ ) :  $\delta$  1.34 (s, 3H), 1.39 (s, 3H), 1.62-1.92 (m, 2H), 2.05 (s, 3H), 2.39 (s, 1H), 3.52 (t, *J* = 10 Hz, 1H), 3.55-3.59 (m, 1H), 4.12-4.35 (m, 3H), 5.52 (brs, 1H), 7.29 (d, *J* = 8 Hz, 2H), 7.79 (d, *J* = 8 Hz, 2H)

$^{13}\text{C}$  NMR (50 MHz,  $\text{CDCl}_3$ ) :  $\delta$  28.5, 33.0, 61.2, 69.1, 73.1, 76.3, 108.8, 117.2, 124.1, 126.2, 126.9, 129.1, 129.5, 129.7, 132.1, 139.3, 143.2, 155.0, 170.9

**Preparation of 1-(2,2-Dimethyl-[1,3]-dioxolan-4-yl)but-3-ene-2-ol**

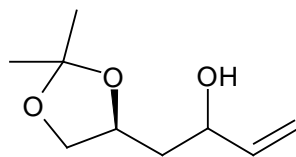

**52**

To a stirred solution of Mg (2.33 g, 97.22 mmol) in dry THF (50 mL) was added vinyl bromide solution (14.2 mL, 3.9 M solution in dry THF, 55.55 mmol) dropwise and solution was cooled to  $-78\text{ }^{\circ}\text{C}$  and to this the aldehyde **48** (4 g, 27.77 mmol) in dry THF (10 mL) was added dropwise. After 2 h stirring at  $-78\text{ }^{\circ}\text{C}$  the reaction mixture was quenched with saturated  $\text{NH}_4\text{Cl}$  solution (20 mL), and the aqueous layer was extracted with ethyl acetate (4x50 mL) and the combined organic layers were washed with brine and dried over  $\text{Na}_2\text{SO}_4$ . The extracts were concentrated to near dryness and purified on silica gel column chromatography using petroleum ether:ethyl acetate (8:2) as eluent to give **52** (3.44 g) as a colorless compound.

**Yield** : 72%

$[\alpha]_{\text{D}}^{20}$  : -11.3 (*c* 0.62,  $\text{CHCl}_3$ )

**IR** (neat,  $\text{cm}^{-1}$ ) :  $\nu_{\text{max}}$  3422, 1621

**$^1\text{H}$  NMR** : (200 MHz,  $\text{CDCl}_3$ ) :  $\delta$  1.36 (s, 3H), 1.43 (s, 3H), 1.70-1.89 (m, 2H), 2.78 (brs, -OH, 1H), 3.54-3.61 (m, 2H), 4.09 (q, *J* = 4 Hz, 1H), 4.26-4.36 (m, 1H), 5.12 (dd, *J* = 10, 5 Hz, 2H), 5.83-5.96 (m, 1H).

**$^{13}\text{C}$  NMR** (50 MHz,  $\text{CDCl}_3$ ) :  $\delta$  13.7, 20.5, 25.3, 26.4, 30.3, 40.1, 59.9, 66.3, 69.2, 70.7, 71.7, 73.0, 74.0, 108.6, 113.6, 114.3, 140.7, 140.1.

**Analysis** :  $\text{C}_9\text{H}_{16}\text{O}_3$  (172.22) requires C, 62.77 ; H, 9.36 ; Found. C, 62.75 ; H, 9.34

### Preparation of 2-(2,2-Dimethyl-[1, 3]dioxolan-4-yl)-1-oxiranyl-ethanol

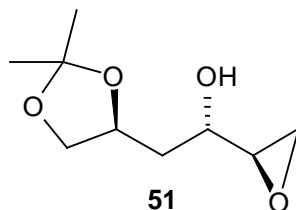

**51**

To a mixture of 3 Å molecular sieves (125 mg) and  $\text{Ti}(\text{}^i\text{-PrO})_4$  (82.6 mg, 3.19 mmol) in dry  $\text{CH}_2\text{Cl}_2$  (5 mL) was added (+)-DET (0.83 g, 4.06 mmol) dropwise at  $-20\text{ }^{\circ}\text{C}$ . The mixture was stirred for 20 min. at  $-20\text{ }^{\circ}\text{C}$ ,

and a solution of diastereomeric mixture of **52** (0.5 g, 2.9 mmol) in dry CH<sub>2</sub>Cl<sub>2</sub> (3 mL) was added slowly. The reaction mixture was stirred for additional 30 min. at -20 °C and to this was added TBHP (0.8 mL, 5.5 M solution in nonane, 4.35 mmol) dropwise. The reaction mixture was stirred at -20 °C by constant temperature bath and after 2.5 days the reaction mixture was quenched with saturated tartaric acid solution (5 mL). The crude product was then purified by flash chromatography on silica gel using 20% ethyl acetate:petroleum ether to give initially chiral hydroxy olefin **57**. Elution with 70% ethyl acetate:petroleum ether gave the required epoxy alcohol **51** as a colorless compound.

**Yield :** 72%

$[\alpha]_D^{20}$  : + 18.42 (*c* 0.3, CHCl<sub>3</sub>)

**IR** (neat, cm<sup>-1</sup>) :  $\nu_{\max}$  3521, 1368, 1196, 985

**<sup>1</sup>HNMR** : (200 MHz, CDCl<sub>3</sub>) :  $\delta$  1.37 (s, 3H), 1.42 (s, 3H), 1.58-1.66 (m, 2H), 2.01 (s, 1H), 2.95-3.13 (m, 1H), 3.55-3.69 (m, 2H), 3.91 (dd, *J* = 12.8, 3.8 Hz, 1H), 4.11 (dd, *J* = 7.8, 5.4 Hz, 2H), 4.23-4.33 (m, 1H).

**<sup>13</sup>CNMR** (50 MHz, CDCl<sub>3</sub>) :  $\delta$  25.5, 26.8, 36.1, 52.9, 58.7, 61.4, 69.1, 73.8, 108.9.

**Analysis** : C<sub>9</sub>H<sub>16</sub>O<sub>4</sub> (188.22) requires C, 57.43 ; H, 8.57 ; Found. C, 57.41 ; H, 8.55

**Preparation of 4-(2-Benzyloxy-2-oxiranylethyl)-2,2-dimethyl-[1, 3]-dioxolane**

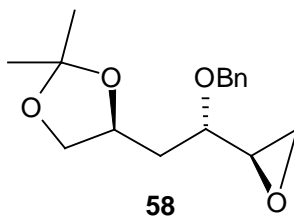

To an ice-cooled solution of NaH ( 0.14 g, 60% dispersion in oil, 3.5 mmol) in dry THF (3 mL) was added compound **51** (0.6 g, 3.2 mmol) in dry THF (5 mL) dropwise and mixture stirred for 30 min at the same temperature. To this reaction mixture benzyl bromide ( 0.38 mL, 3.2 mmol) was added dropwise followed by tetrabutyl ammonium iodide in catalytic amount. After TLC diagnosis, the reaction mixture was quenched with ice-cooled water and extracted with ethyl acetate. The combined organic layers were washed with brine solution and dried (Na<sub>2</sub>SO<sub>4</sub>). The crude reaction mixture was purified on silica gel column chromatography using ethyl acetate:petroleum ether (1:9) to give **58** (0.74 g) as a colorless compound.

**Yield :** 83%

$[\alpha]_D^{25}$  : + 12.3 (*c* 0.83, CHCl<sub>3</sub>)

IR (neat, cm<sup>-1</sup>) :  $\nu_{\max}$  1220, 1036, 956, 845

<sup>1</sup>H NMR (200 MHz, CDCl<sub>3</sub>) :  $\delta$  1.28 (s, 3H), 1.33 (s, 3H), 1.58-1.62 (m, 2H), 2.52 (dd, *J* = 13.3, 6.6 Hz, 2H), 2.85 (q, *J* = 7 Hz, 1H), 3.23-3.34 (m, 1H), 3.72-3.81 (m, 2H), 3.84-3.89 (m, 1H), 4.56 (s, 2H), 7.23-7.34 (m, 5H)

<sup>13</sup>C NMR (50 MHz, CDCl<sub>3</sub>) :  $\delta$  29.6, 33.3, 42.2, 46.0, 70.7, 72.9, 73.1, 75.7, 108.8, 127.6, 128.3, 133.2

Analysis : C<sub>16</sub>H<sub>22</sub>O<sub>4</sub> (278.34) requires C, 69.04 ; H, 7.97; Found. C, 69.01; H, 7.95

#### Preparation of 3-Benzyloxy-4-(2,2-dimethyl-[1, 3] dioxolan-4-yl)-butan-2-ol

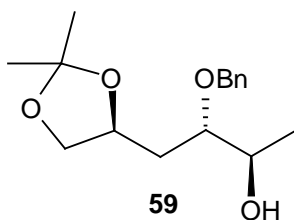

To a stirred suspension of LAH (0.13 g, 3.59 mmol) in dry THF (10 mL) was added epoxide **58** (0.5 g, 1.79 mmol) in dry THF (5 mL) dropwise and stirred for 24 h at room temperature. The reaction was quenched with water, extracted several times with ethyl acetate and dried over Na<sub>2</sub>SO<sub>4</sub>, filtered and concentrated to near dryness. Purification on silica gel column chromatography using ethyl acetate:petroleum ether (9 : 1) as eluent gave **59** (0.42 g) as a slightly viscous liquid.

**Yield :** 84%

$[\alpha]_D^{25}$  : + 31.2 (*c* 1.0, CHCl<sub>3</sub>)

IR (neat, cm<sup>-1</sup>) :  $\nu_{\max}$  3489, 1232, 1136, 998, 887

<sup>1</sup>H NMR (200 MHz, CDCl<sub>3</sub>) :  $\delta$  1.21 (d, *J* = 6.2 Hz, 3H), 1.37 (s, 3H), 1.42 (s, 3H), 1.62-1.86 (m, 2H), 2.94 (brs, 1H), 3.52-3.63 (m, 2H), 4.05-4.12 (m, 1H), 4.22-4.35 (qn, 1H), 4.45 (dd, *J* = 11.6, 3.2 Hz, 1H), 4.65 (s, 2H), 7.33-7.34 (m, 5H)

<sup>13</sup>C NMR (50 MHz, CDCl<sub>3</sub>) :  $\delta$  15.2, 28.3, 31.2, 70.1, 71.1, 73.0, 75.7, 76.3, 108.2, 127.5, 128.2, 138.1

Analysis : C<sub>16</sub>H<sub>24</sub>O<sub>4</sub> (280.34) requires C, 68.54; H, 8.63 ; Found. C, 68.51 ; H, 8.62

Preparation of Toluene-4-sulfonic acid 2-benzyloxy-3-(2,2-dimethyl-[1, 3]-dioxolan-4-yl)-1-methyl-propyl ester

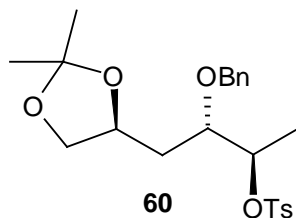

To an ice-cooled solution of **59** (0.4 g, 1.42 mmol) in dry DCM (10 mL) was added Et<sub>3</sub>N (0.22 mL, 1.57 mmol) and *p*-toluenesulfonyl chloride (0.27 g, 1.42 mmol) sequentially. After being stirred for 1 h in an ice-bath and then for 48 h at room temperature, the mixture was diluted with ether and washed with water, saturated NH<sub>4</sub>Cl, and brine. The organic layer was dried over Na<sub>2</sub>SO<sub>4</sub> and concentrated. Purification by silica gel column chromatography using ethyl acetate:petroleum ether (0.5:9.5) as eluent gave **60** (0.52 g) as a light yellow oil.

**Yield :** 84%

$[\alpha]_D^{25}$  : + 18.4 (*c* 0.34, CHCl<sub>3</sub>)

**IR (neat, cm<sup>-1</sup>) :**  $\nu_{\max}$  1465, 1225, 1103, 935, 723

**<sup>1</sup>H NMR (200 MHz, CDCl<sub>3</sub>) :**  $\delta$  1.28 (d, *J* = 6.2 Hz, 3H), 1.24 (s, 3H), 1.25 (s, 3H), 1.77-1.92 (m, 2H), 2.21 (s, 3H), 3.12 (q, *J* = 5.6 Hz, 1H), 3.75-3.99 (m, 3H), 4.54 (s, 2H), 4.91-4.96 (m, 1H), 7.30-7.45 (m, 5H), 7.77 (d, *J* = 3.4 Hz, 2H), 7.82 (d, *J* = 3.3 Hz, 2H)

**<sup>13</sup>C NMR (50 MHz, CDCl<sub>3</sub>) :**  $\delta$  14.3, 28.6, 30.7, 66.4, 73.7, 74.2, 76.3, 77.6, 108.6, 127.5, 128.1, 129.6, 137.6

**Analysis :** C<sub>23</sub>H<sub>30</sub>O<sub>6</sub>S (434.55) requires C, 63.57 ; H, 6.96 ; Found. C, 63.54 ; H, 6.95

#### Preparation of 4-(3-Azido-2-benzyloxybutyl)-2,2-dimethyl-[1,3]-dioxolane

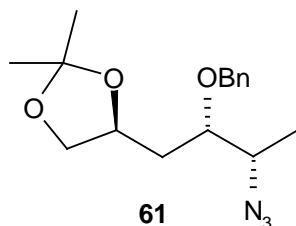

To a solution of **60** (0.3 g, 0.69 mmol) in dry DMF (5 mL) was added NaN<sub>3</sub> (0.22 g, 3.45 mmol). After being stirred for 12 h at 70 °C the mixture was diluted with water and extracted with ether (3x10 mL). The organic layer was washed with water, brine, and dried over Na<sub>2</sub>SO<sub>4</sub>. Concentration and purification by

silica gel column chromatography using 5% ethyl acetate in petroleum ether as eluent gave **61** (0.16 g) as a colorless liquid.

**Yield :** 76%

$[\alpha]_D^{25}$  : + 32.4 (*c* 1.0, CHCl<sub>3</sub>)

**IR (neat, cm<sup>-1</sup>) :**  $\nu_{\max}$  2116, 1296, 1163, 1042, 932, 755

**<sup>1</sup>H NMR (200 MHz, CDCl<sub>3</sub>) :**  $\delta$  1.24 (d, *J* = 6.2 Hz, 3H), 1.38 (s, 3H), 1.42 (s, 3H), 1.42-1.57 (m, 2H), 2.12-2.22 (m, 1H), 3.52-3.59 (m, 1H), 3.62-3.80 (m, 2H), 4.06 (q, *J* = 6.0 Hz, 1H), 4.60 (s, 2H), 7.29-7.38 (m, 5H)

**<sup>13</sup>C NMR (50 MHz, CDCl<sub>3</sub>) :**  $\delta$  14.7, 26.7, 34.1, 62.3, 69.1, 70.5, 72.7, 76.1, 108.6, 126.7, 128.5, 137.8

**Analysis :** C<sub>16</sub>H<sub>23</sub> N<sub>3</sub>O<sub>3</sub> (305.37) requires C, 62.93 ; H, 7.59 ; N, 13.76 ; Found. C, 62.91 ; H, 7.56 ; N, 13.75

#### Preparation of Toluene-4-sulfonic acid 5(*S*)-azido-4(*S*)-benzyloxy-2(*S*)-hydroxy-hexyl ester

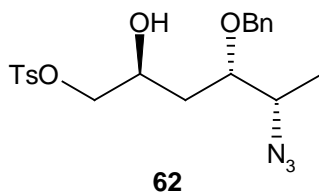

To a stirred solution of **61** (0.4 g, 1 mmol) in methanol (10 mL) was added catalytic amount of *p*-TSA and mixture stirred at room temperature for 6 h. After completion of the starting material, the reaction mixture was neutralized with solid NaHCO<sub>3</sub> and filtered off. The crude diol was concentrated to near dryness and dissolved in dry DCM (5 mL). To this, Et<sub>3</sub>N (0.1 mL, 0.83 mmol), *p*-TsCl (157 mg, 0.83 mmol) and catalytic amount of dibutyltin oxide were added sequentially at 0 °C. The reaction mixture was stirred till completion of the starting material and water was added to the reaction mixture and extracted with dichloromethane (3x5 mL). The combined organic layers were washed with brine solution and dried over Na<sub>2</sub>SO<sub>4</sub> and concentrated to near dryness. The crude product was purified on silica gel column chromatography using ethyl acetate:pet. ether (1:9) as eluent to give **62** as a syrupy liquid.

**Yield :** 67%

$[\alpha]_D^{25}$  : + 19.6 (*c* 0.76, CHCl<sub>3</sub>)

**IR (neat, cm<sup>-1</sup>) :**  $\nu_{\max}$  3462, 2133, 1322, 1256, 1052



**<sup>1</sup>H NMR (200 MHz, CDCl<sub>3</sub>)** : δ 0.96 (d, *J* = 6.0 Hz, 3H), 1.63-1.82 (m, 2H), 2.22-2.36 (m, 1H), 2.46 (s, 3H), 2.50 (s, 1H), 3.11 (q, *J* = 4.3 Hz, 1H), 3.67-3.82 (m, 1H), 4.03 (d, *J* = 8.7 Hz, 2H), 4.59 (s, 2H), 7.34-7.44 (m, 5H), 7.55 (d, *J* = 7.4 Hz, 2H), 7.92 (*J* = 7.5 Hz, 2H)

**<sup>13</sup>C NMR (50 MHz, CDCl<sub>3</sub>)** : δ 13.3, 21.7, 32.7, 61.5, 66.2, 70.7, 73.8, 74.6, 126.9, 127.2, 127.8, 128.3, 129.6, 130.1, 137.9, 145.1

**Analysis** : C<sub>20</sub>H<sub>25</sub>N<sub>3</sub>O<sub>5</sub>S (419.50) requires C, 57.26 ; H, 6.01 ; N, 10.02 ; Found. C, 57.23 ; H, 5.98 ; N, 10.01.

**Preparation of 2-(3(S)-Azido-2 (S)-benzyloxybutyl)-oxirane**

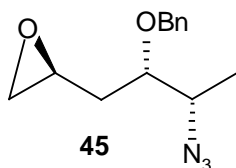

To a solution of **62** (0.2 g, 0.47 mmol) in methanol (5 mL) was added K<sub>2</sub>CO<sub>3</sub> (65 mg, 0.47 mmol) and mixture stirred for 1 h. After TLC diagnosis, water was added to the reaction mixture and extracted with dichloromethane (3x5 mL). The combined organic layers were washed with brine solution and dried over Na<sub>2</sub>SO<sub>4</sub> and concentrated to near dryness. The crude product was purified on silica gel column chromatography using ethyl acetate : petroleum ether (0.5 : 9.5) as eluent to give epoxide **45** (88 mg) as a colorless oil.

**Yield** : 73%

[α]<sub>D</sub><sup>25</sup> : + 24.4 (*c* 1.0, CHCl<sub>3</sub>)

**IR (neat, cm<sup>-1</sup>)** : ν<sub>max</sub> 2108, 1322, 1216, 1092, 895

**<sup>1</sup>H NMR (200 MHz, CDCl<sub>3</sub>)** : δ 0.90 (d, *J* = 6.7 Hz, 3H), 1.48-1.63 (m, 2H), 2.02-2.28 (m, 1H), 2.42-2.46 (m, 1H), 3.25 (d, *J* = 10.9, 6.3 Hz, 2H), 3.47-3.67 (m, 1H), 4.59 (s, 2H), 7.31-7.36 (m, 5H)

**<sup>13</sup>C NMR (50 MHz, CDCl<sub>3</sub>)** : δ 14.0, 29.6, 41.9, 47.7, 58.9, 74.9, 75.7, 127.4, 127.8, 128.3, 129.9, 138.1

**Analysis** : C<sub>13</sub>H<sub>17</sub>N<sub>3</sub>O<sub>2</sub> (247.29) requires C, 63.14 ; H, 6.93 ; N, 16.99 ; Found. C, 63.12 ; H, 6.91 ; N, 16.96

## 5.7 Spectra

1.  $^1\text{H}$  &  $^{13}\text{C}$  NMR Spectra of 55
2.  $^1\text{H}$  &  $^{13}\text{C}$  NMR Spectra of 48
3.  $^1\text{H}$  &  $^{13}\text{C}$  NMR Spectra of 52
4.  $^1\text{H}$  &  $^{13}\text{C}$  NMR Spectra of 51
5.  $^1\text{H}$  &  $^{13}\text{C}$  NMR Spectra of 59
6.  $^1\text{H}$  &  $^{13}\text{C}$  NMR Spectra of 61
7.  $^1\text{H}$  &  $^{13}\text{C}$  NMR Spectra of 62
8.  $^1\text{H}$  &  $^{13}\text{C}$  NMR Spectra of 45

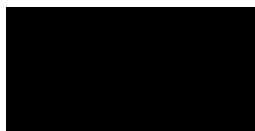

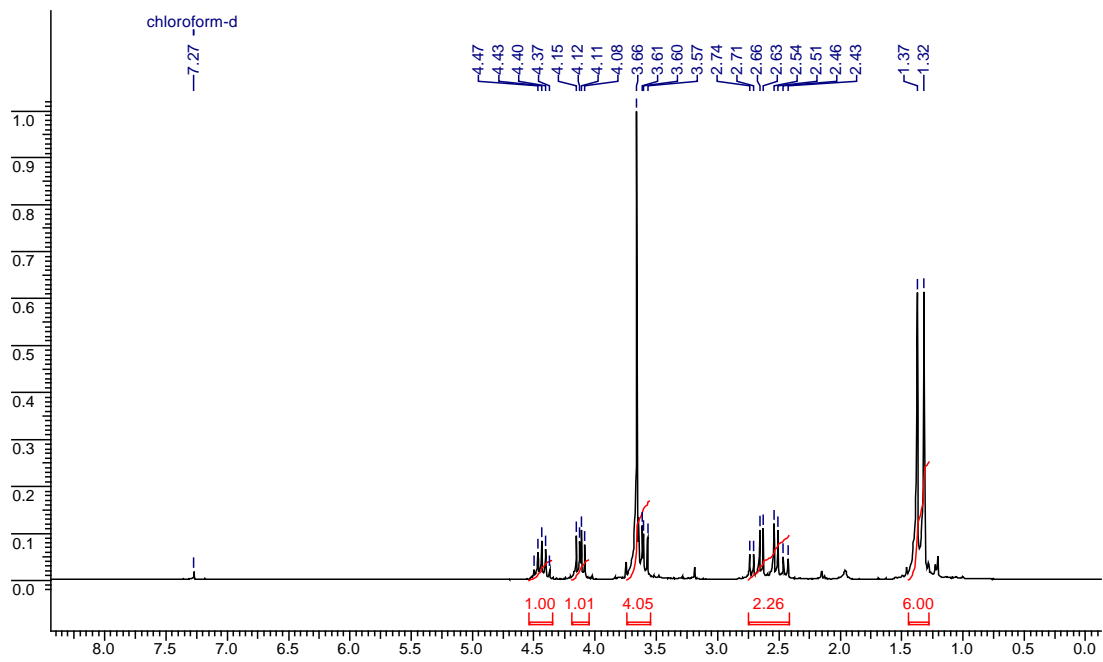

<sup>1</sup>H NMR Spectrum of compound 55 in CDCl<sub>3</sub>

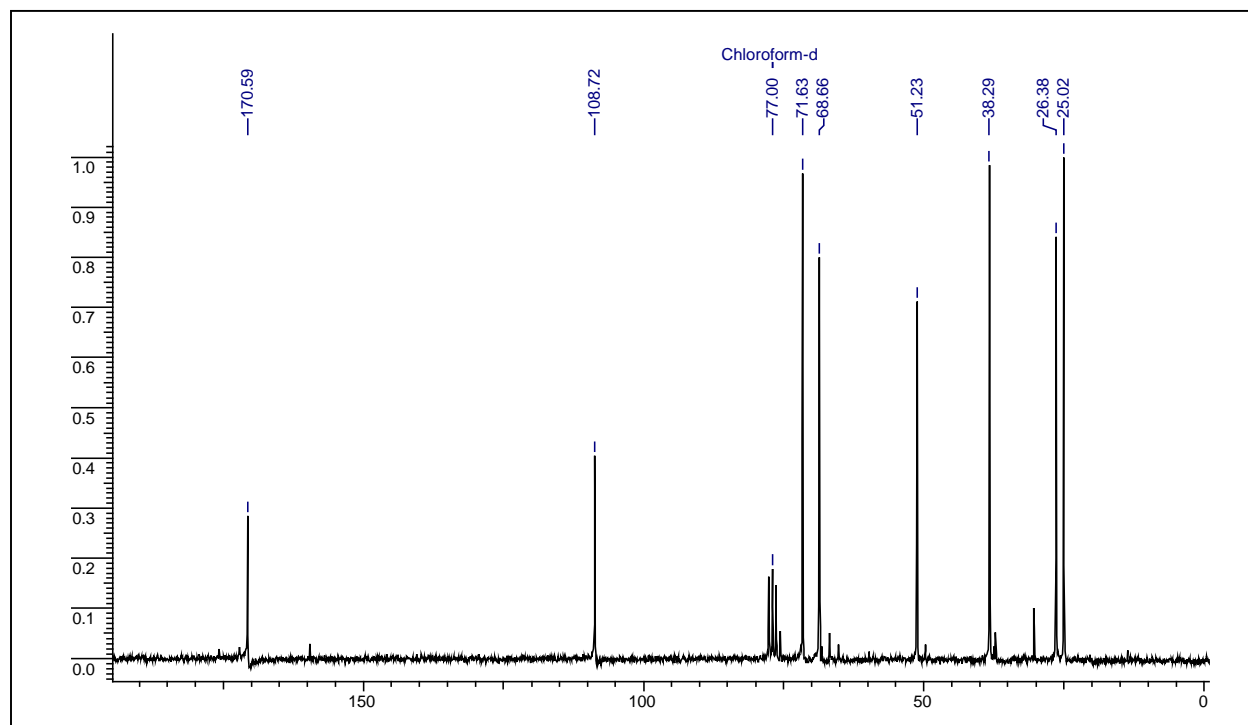

<sup>13</sup>C NMR Spectrum of compound 55 in CDCl<sub>3</sub>

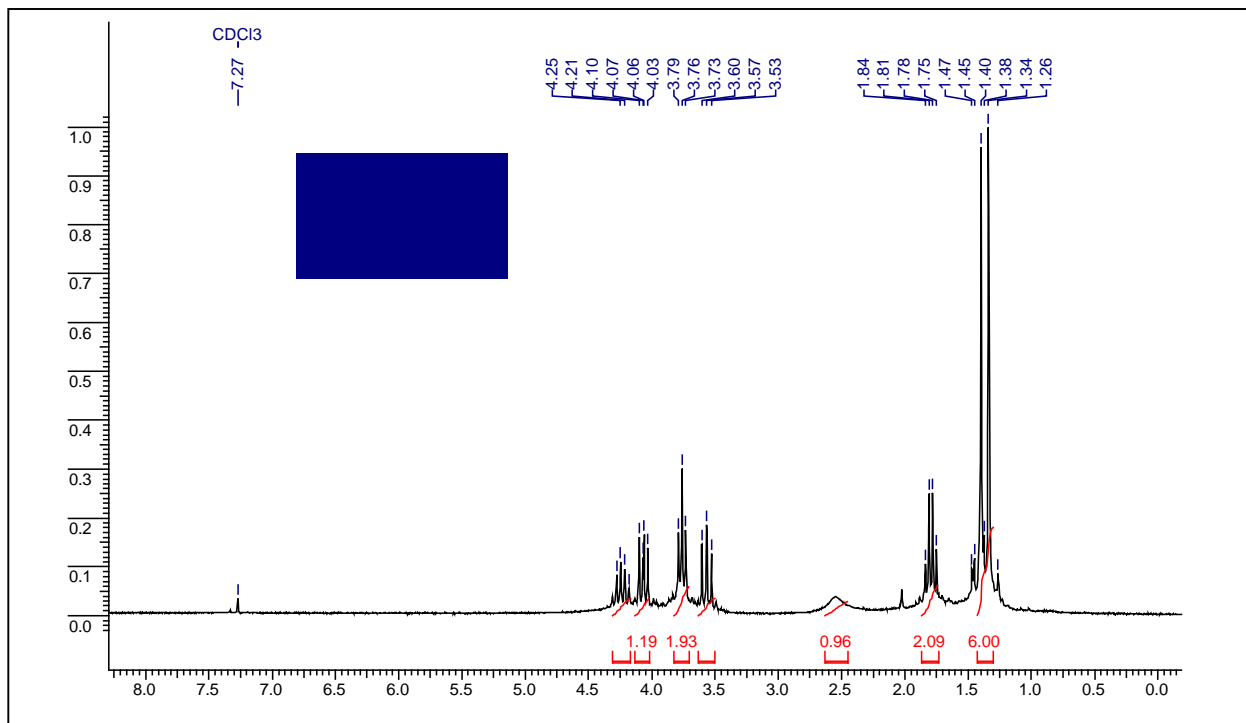

<sup>1</sup>H NMR Spectrum of compound 48 in CDCl<sub>3</sub>

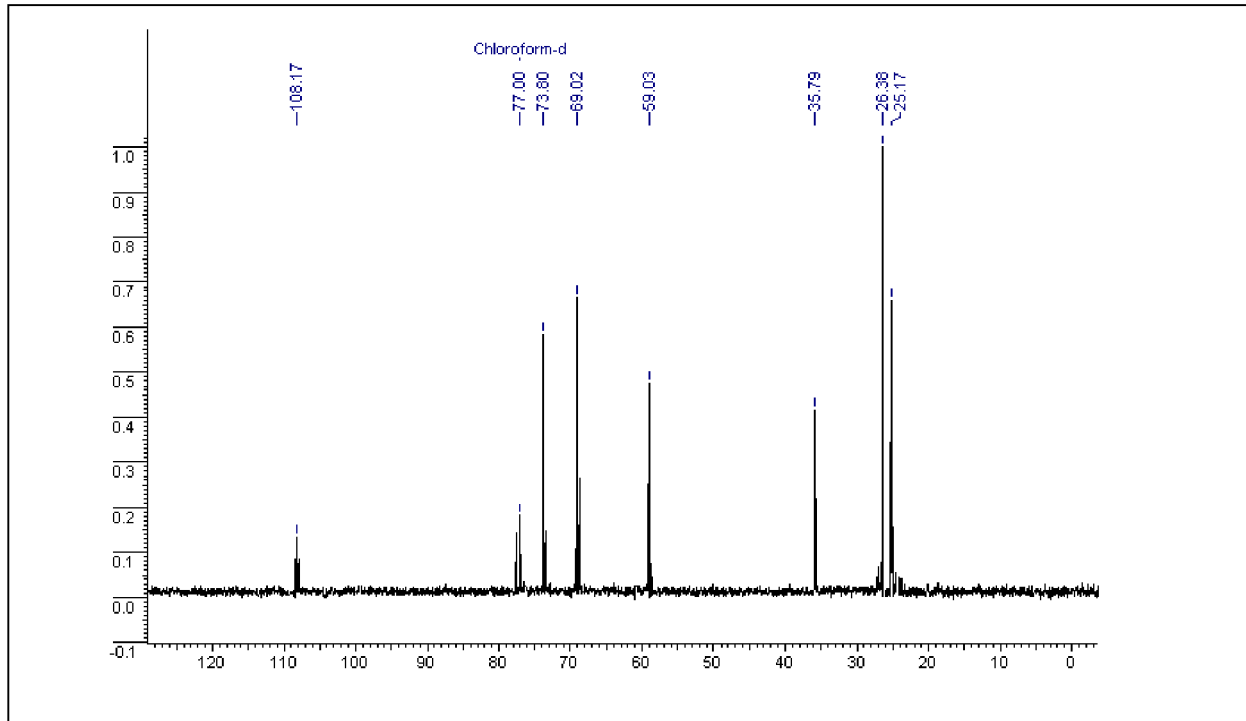

<sup>13</sup>C NMR Spectrum of compound 48 in CDCl<sub>3</sub>

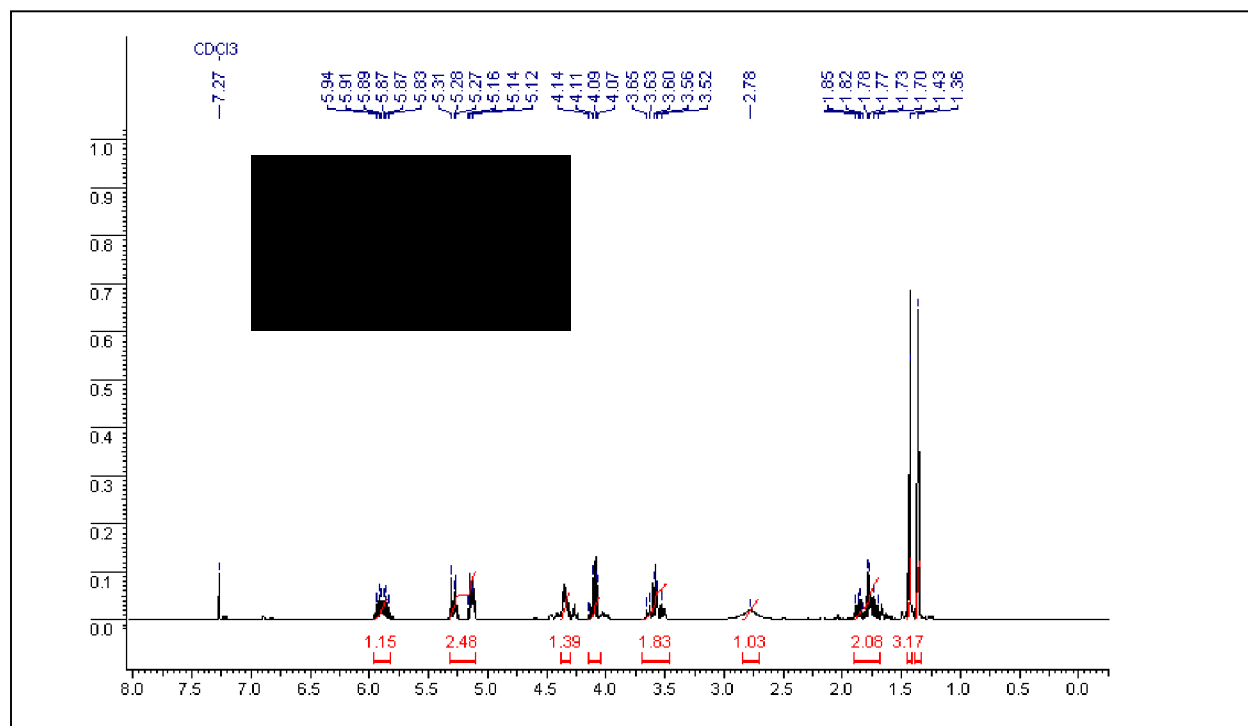

<sup>1</sup>H NMR Spectrum of compound 52 in CDCl<sub>3</sub>

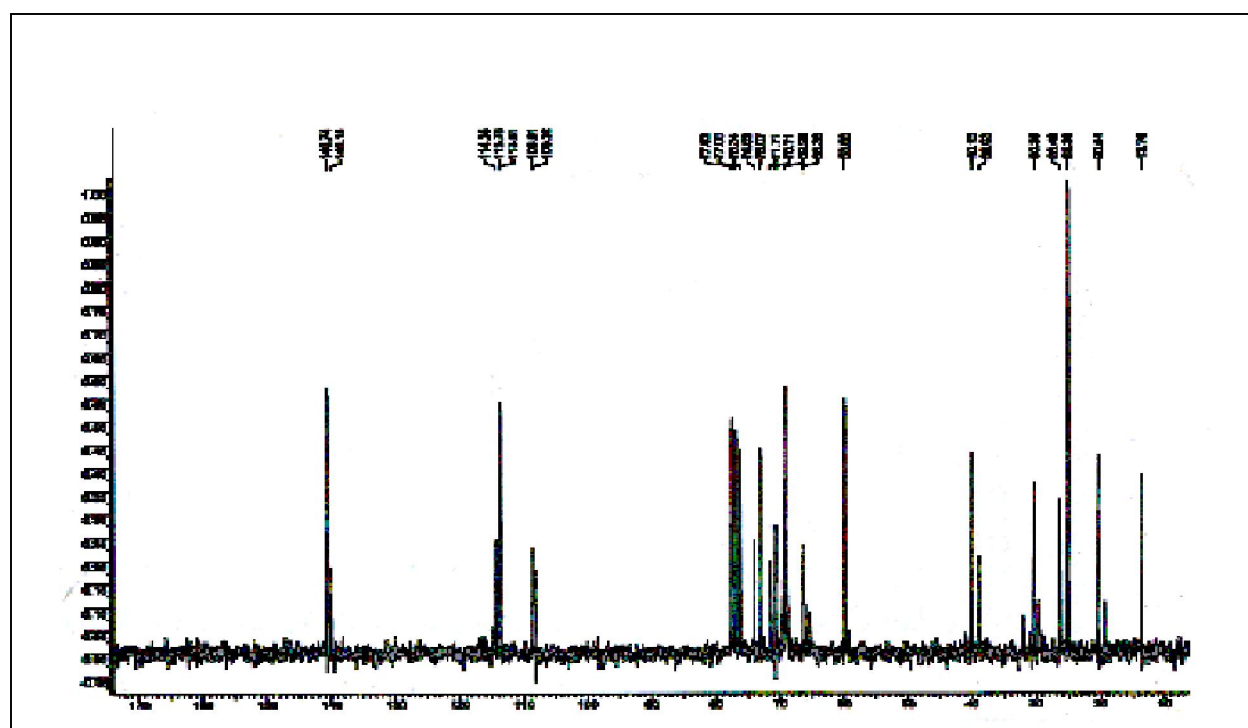

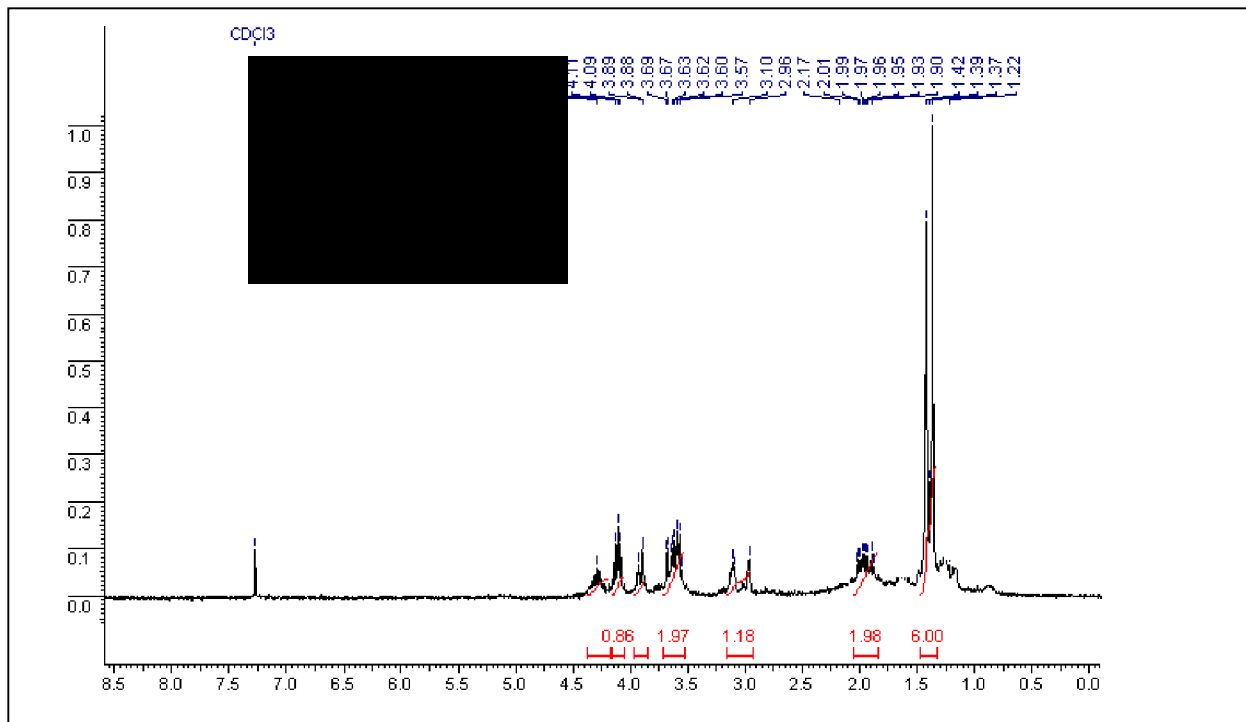

<sup>1</sup>H NMR Spectrum of compound 51 in CDCl<sub>3</sub>

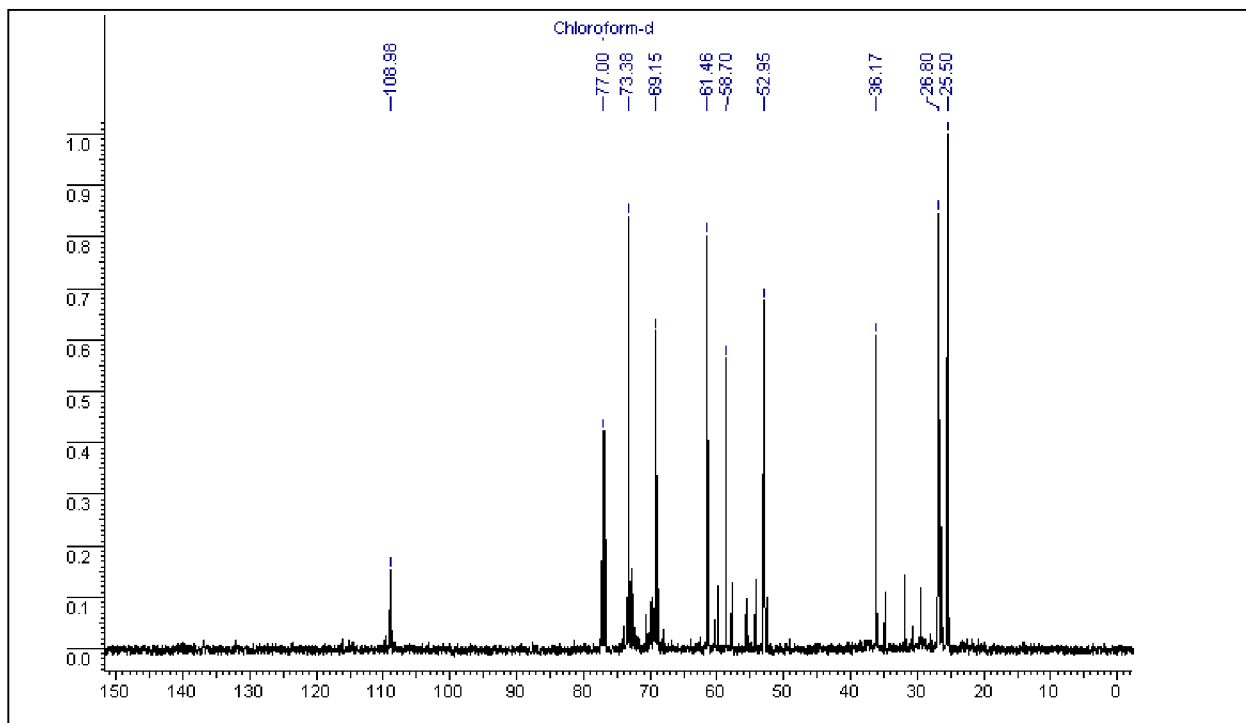

<sup>13</sup>C NMR Spectrum of compound 51 in CDCl<sub>3</sub>

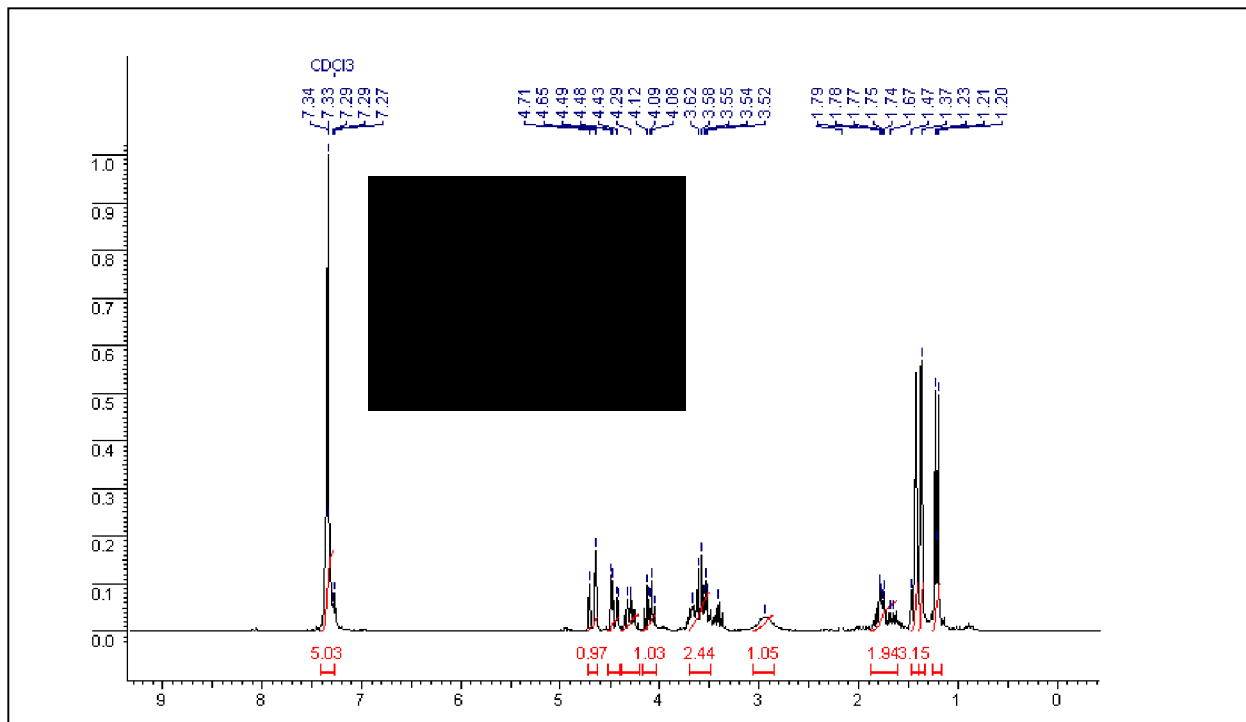

<sup>1</sup>H NMR Spectrum of compound 59 in CDCl<sub>3</sub>

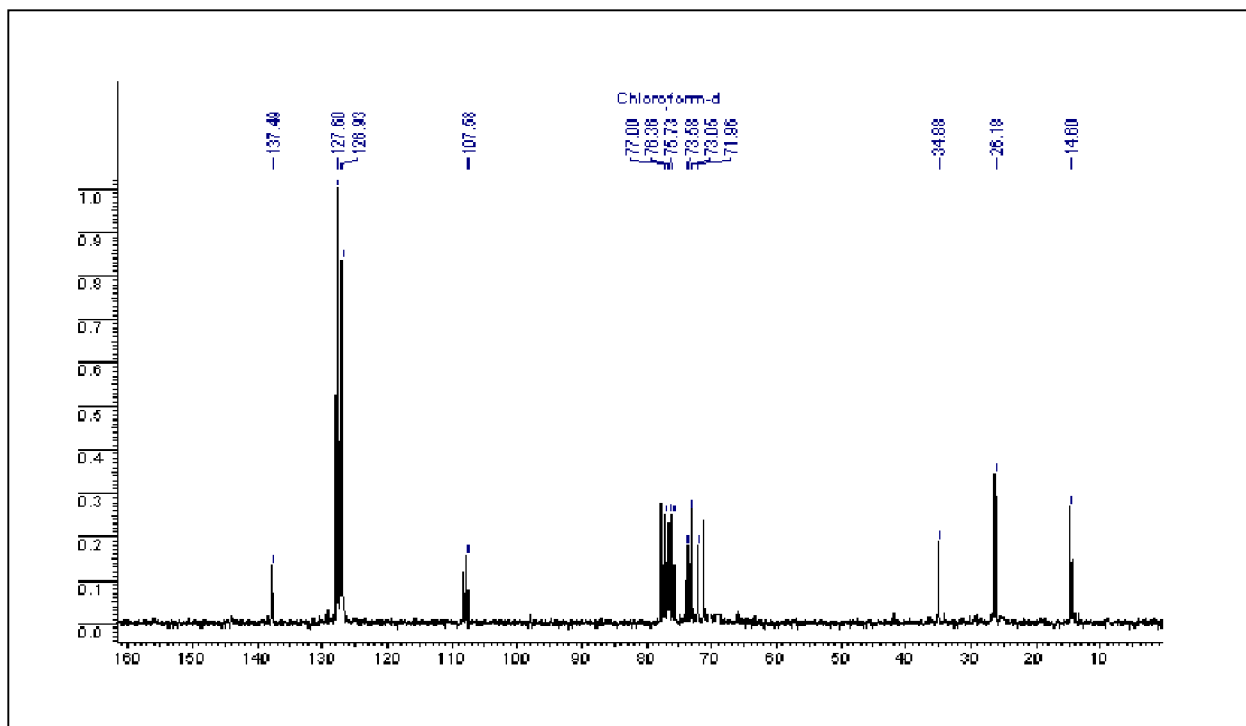

<sup>13</sup>C NMR Spectrum of compound 59 in CDCl<sub>3</sub>

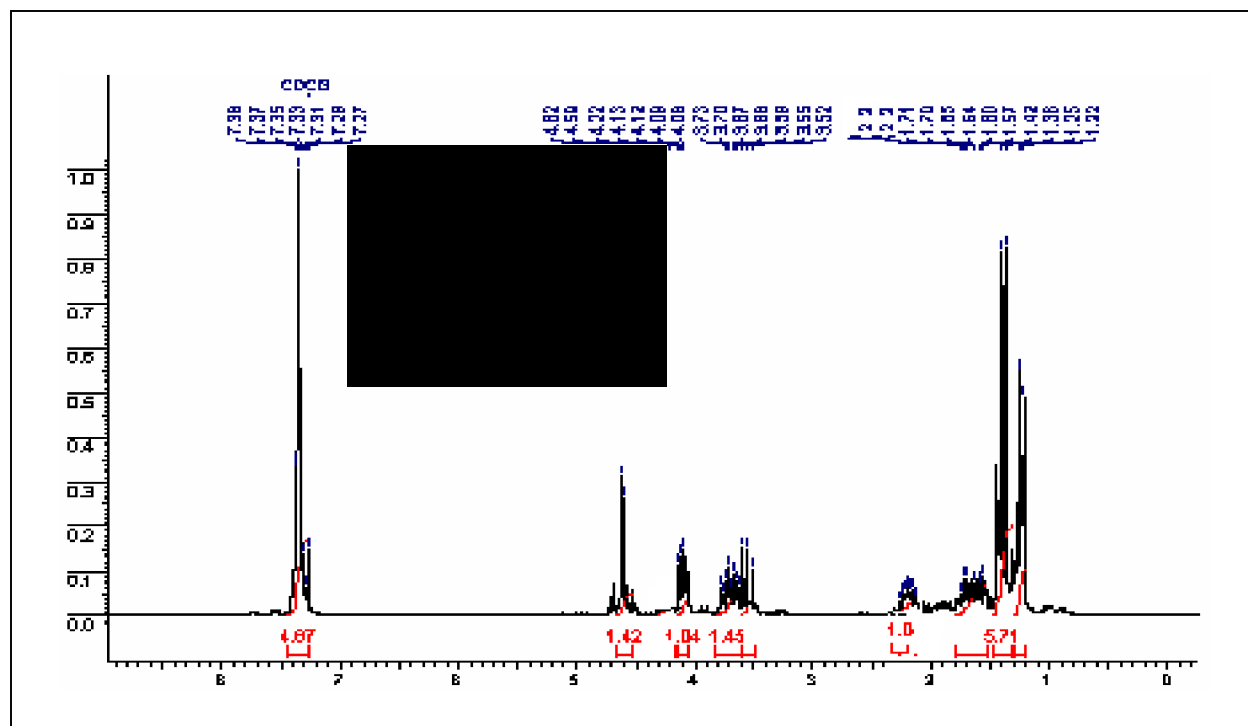

<sup>1</sup>H NMR Spectrum of compound 61 in CDCl<sub>3</sub>

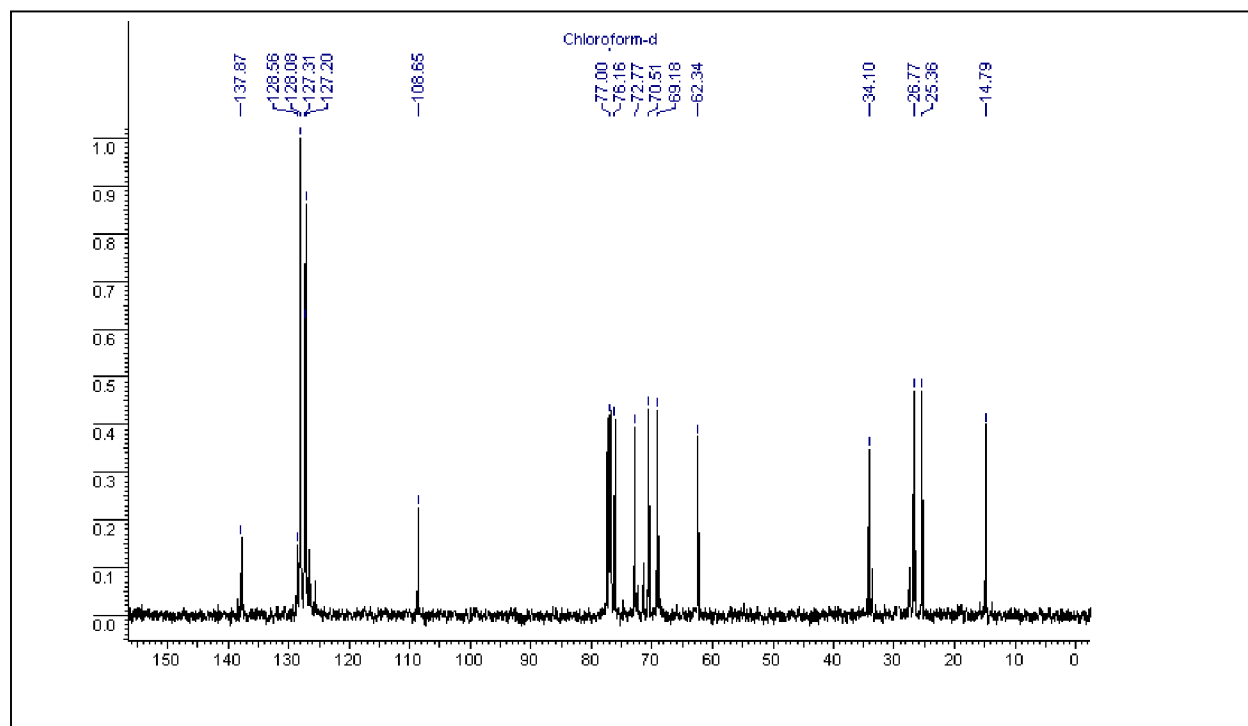

<sup>13</sup>C NMR Spectrum of compound 61 in CDCl<sub>3</sub>



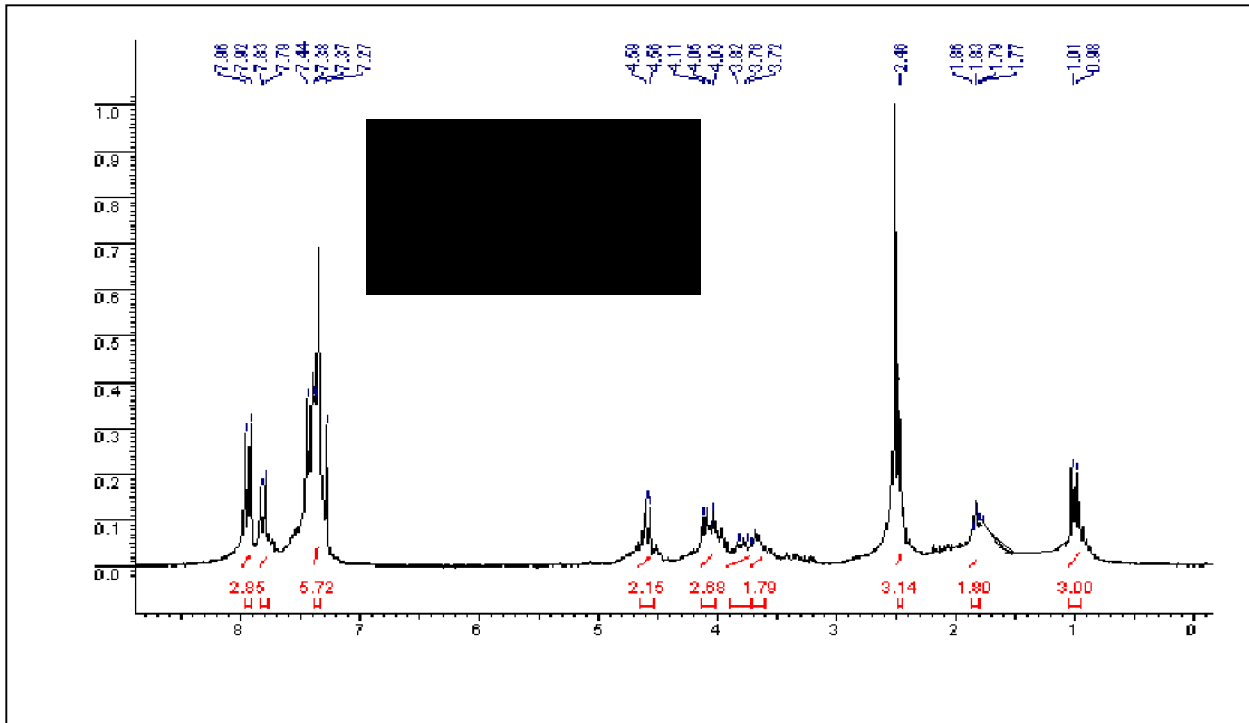

<sup>1</sup>H NMR Spectrum of compound 62 in CDCl<sub>3</sub>

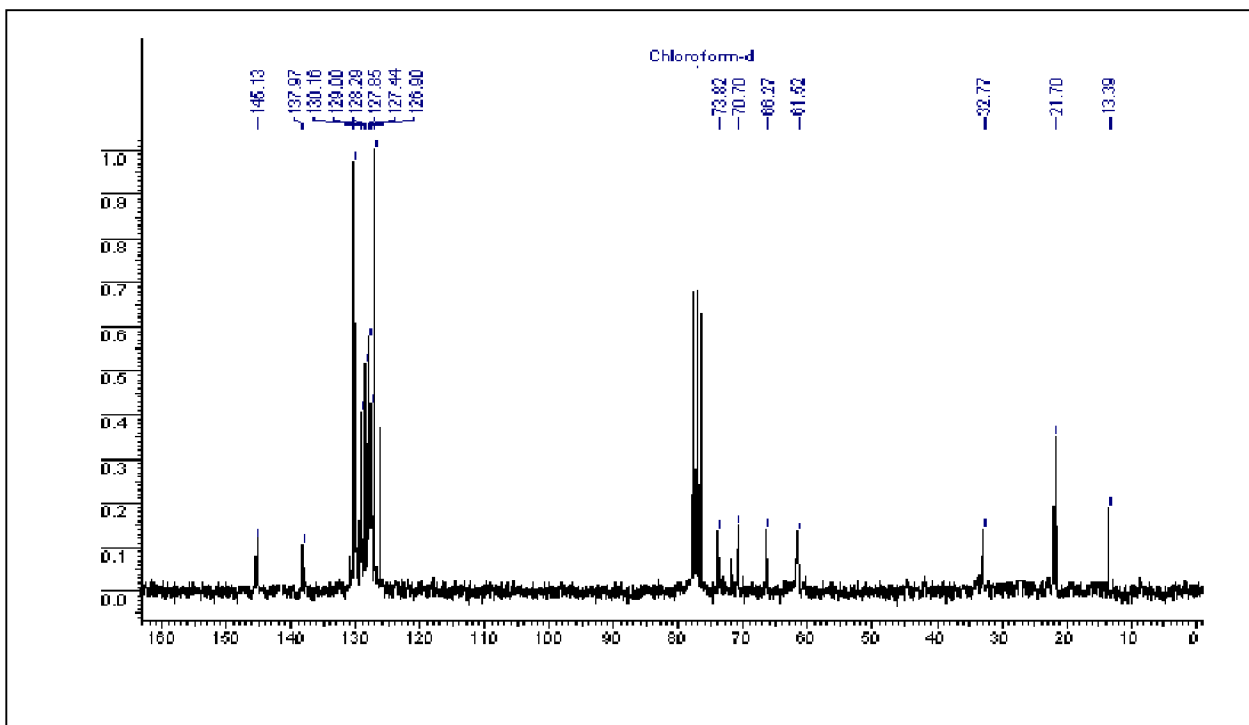

<sup>13</sup>C NMR Spectrum of compound 62 in CDCl<sub>3</sub>

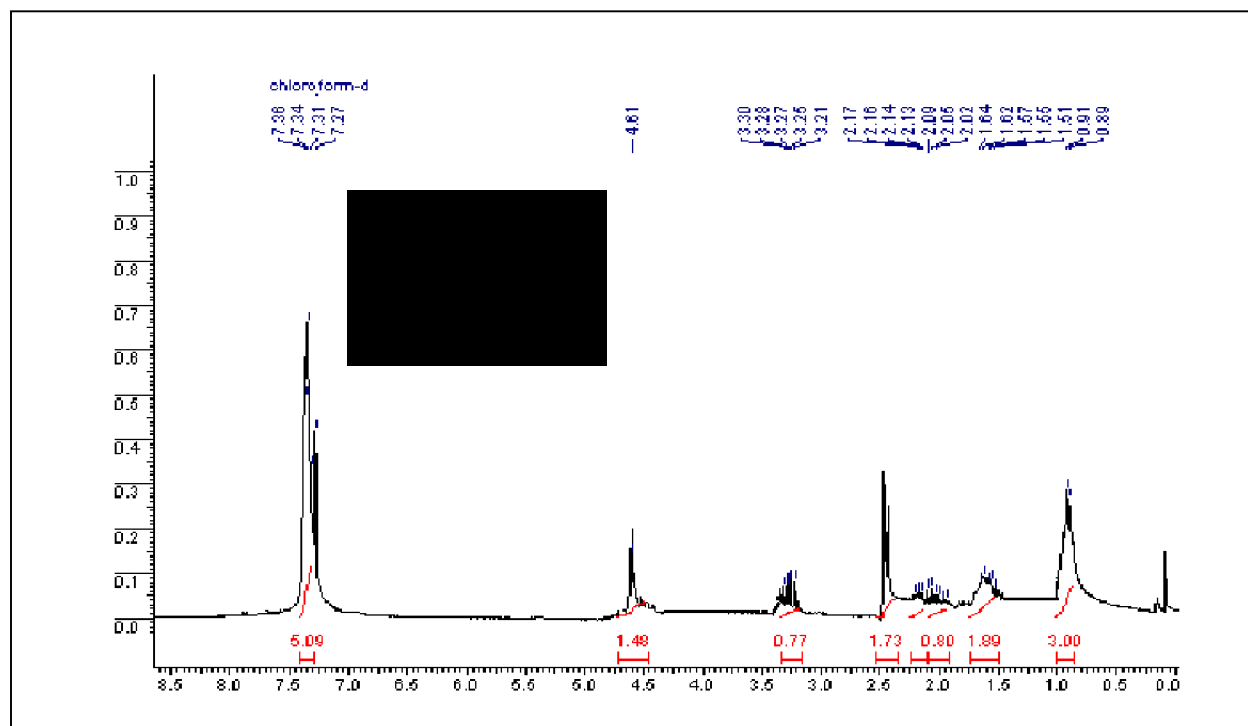

**$^1\text{H}$  NMR Spectrum of compound 45 in  $\text{CDCl}_3$**

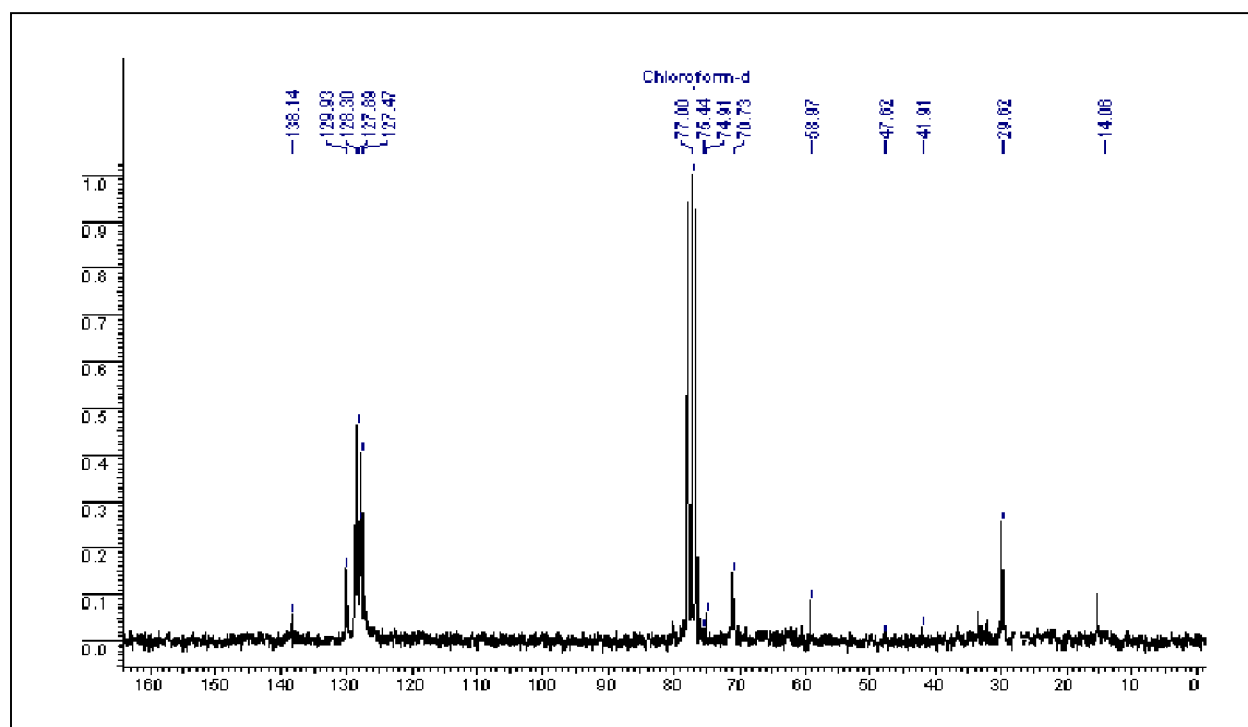

**$^{13}\text{C}$  NMR Spectrum of compound 45 in  $\text{CDCl}_3$**

## 5.8 References

1. (a) Zheng, W.; Demattei, J. A.; Wu, J.-P.; Duan, J.J.-W.; Cook, L. R.; Oinuma, H.; Kishi, Y. *J. Am. Chem. Soc.* **1996**, *118*, 7946 ; (b) Nonomura, T.; Sasaki, M.; Matsumori, N.; Murata, M.; Tachimana, K.; Yasumoto, T. *Angew. Chem. Int. Ed. Engl.* **1996**, *35*, 1675 and references cited therein.
2. Bezuidenhout, S. C.; Gelderblom, W. C. A.; Gorst-Alloman, C. P.; Horax.; Marasas, W. F. O.; Spiteller, G.; Vleggar, R. *J. Chem. Soc., Chem. Commun.* **1988**, 743.
3. Gelderblom, W. C. A.; Marasas, W. F. O.; Vlegaar, R.; Thiel, P. G.; Cawood, M. *E. Mycopathologia* **1992**, *117*, 11.
4. Plattner, R. D.; Weisleder, D.; Shackelford, D. D.; Peterson, R.; Powell, R. G. *Mycopathologia* **1992**, *117*, 23.
5. Merrill, A. H.; Wang, E.; Gilchrist, D. G.; Riley, R. T. *Adv. Lipid. Res.* **1993**, *26*, 215.
6. Nishizuka, Y. *Carcinogenesis* **1989**, *63*, 1892.
7. Yan, S.; Peng, L. F.; Kishi, Y. *J. Org. Chem.* **1997**, *62*, 5666.
8. (a) Hoye, T. R.; Jimenez, J. I.; Shier, W. T. *J. Am. Chem. Soc.* **1994**, *116*, 9409 ; (b) Shier, W. T.; Abbas, H. K.; Badria, F. A. *Tetrahedron Lett.* **1995**, *36*, 157 and references cited therein.
9. (a) Norred, W. P.; Wang, E.; Yoo, H.; Riley, R. T.; Merrill Jr, A. H. *Mycopathologia* **1992**, *117*, 73 ; (b) Blockwell, B. A.; Edwards, O. E.; Fruchier, A.; Apsimon, J. W.; Miller, J. D. "Fumonisin in food" Jackson, L. et al. Eds.

- Phenum Press. New York, **1996**, 75 ; (c) Shi, Y.; Peng, L. F.; Kishi, Y. *J. Org. Chem.* **1997**, 62, 5666.
10. Gurjar, M. K.; Rajendran, V.; Rao, B. V. *Tetrahedron Lett.* **1998**, 39, 3803.
  11. Mayers, A. G.; yang, B. H.; Chen, H.; Gleason, J. L. *J. Am. Chem. Soc.* **1994**, 116, 9361.
  12. Araki, Y.; Arai, Y.; Endo, T.; Ishido, Y. *Chem. Lett.* **1989**, 1.
  13. Shigehiro, H.; *Carbohydr. Res.* **1971**, 6, 229.
  14. Yamaguchi, M.; Hirao, I. *Tetrahedron Lett.* **1983**, 24, 39.
  15. Morgan, A. J.; Masse, C. E.; Panek, J. S. *Org. Lett.* **1999**, 1, 1949.
  16. Hungerbuhler, E.; Seebach, D.; Wasmuth, D. *Helv. Chim. Acta.* **1981**, 64, 1467.
  17. Hoffmann, R. W.; Schlapbach, A. *Tetrahedron* **1992**, 48, 1959.
  18. Meyers, A. I.; Lawson, J. P. *Tetrahedron Lett.* **1982**, 23, 4883.