

**ASYMMETRIC DESYMMETRIZATION APPROACH FOR THE  
CONSTRUCTION OF ENANTIOPURE (+)-N-BOC-7-  
AZABICYCLO[2.2.1]HEPT-2-ONE : APPLICATION IN THE  
SYNTHESIS OF BIOLOGICALLY ACTIVE ALKALOIDS**

**THESIS**

*Submitted To The*

**UNIVERSITY OF PUNE**

*For The Degree Of*

**DOCTOR OF PHILOSOPHY**

*In*

**CHEMISTRY**

*By*

**KESHRI NATH TIWARI**

**Research Supervisor**

**Dr. GANESH PANDEY**

DIVISION OF ORGANIC CHEMISTRY  
NATIONAL CHEMICAL LABORATORY  
PUNE – 411008

*Dedicated  
To My  
Parents*



## *National Chemical Laboratory*

Division of Organic Chemistry  
Pune – 411 008, INDIA

*Dr. Ganesh Pandey*  
FNA, FNASc, FASc

---

### **CERTIFICATE**

This is to certify that the work incorporated in the thesis entitled **“Asymmetric Desymmetrization Approach for the Construction of Enantiopure (+)-N-Boc-7-Azabicyclo[2.2.1]hept-2-one: Application in the Synthesis of Biologically Active Alkaloids”** which is being submitted to the **University of Pune** for the award of **Doctor of Philosophy in Chemistry** by **Mr. Keshri Nath Tiwari** was carried out by him under my supervision at the **National Chemical Laboratory, Pune**. A material that has been obtained from other sources has been duly acknowledged in the thesis.

Date:

**Dr. Ganesh Pandey**  
**(Research Guide)**

## DECLARATION

I hereby declare that the work presented in the thesis entitled **“Asymmetric Desymmetrization Approach for the Construction of Enantiopure (+)-N-Boc-7-Azabicyclo[2.2.1]hept-2-one: Application in the Synthesis of Biologically Active Alkaloids”** submitted for Ph. D. Degree to the **University of Pune**, has been carried out by me at the **National Chemical Laboratory, Pune**, under the supervision of **Dr. Ganesh Pandey**. The work is original and has not been submitted in part or full by me for any degree or diploma to this or any other University/Institute.

Date:

(Keshri Nath Tiwari)

Division of Organic Chemistry

National Chemical Laboratory

Pune – 411008.

## *Acknowledgement*

*The completion of this work would not have been possible without the generous help and encouragement of a number of people. I would like to thank every one of them for the support they have rendered for the accomplishment of the work presented in this dissertation.*

*First of all, I would like to present my feelings of gratitude to my research guide, Dr. Ganesh Pandey, for accepting me as a Ph.D. student and for his invaluable guidance, endless patience and everything he taught me throughout this study. I sincerely thank him for teaching me finest skills of synthetic organic chemistry.*

*I am thankful to Dr. (Mrs.) S. R. Gadre and my senior colleagues Dr. Manmohan Kapur, Dr. Shashikant, Dr. R. S. Singh, Dr. Prabal Banerjee, Dr. Sanjay Raikar, Dr. S. G. Dumbre for their sincere advice and guidance during the course of study. I thank my lab mates Bala, Kishore, Shrikant, Swaroop, Gaikwad, Debasish G, Ravinder, Rajender, Prasanna, Nishant, Sujit, Debasis D, Deepak, Dharmendra, Priyanka, Vinay, Tukaram and Nitesh for maintaining a warm and very cheerful atmosphere in the lab and always helping me with valuable scientific suggestions. Special thanks to Rajesh for his help during the writing of this thesis.*

*Help from the Spectroscopy and CMC group is gratefully acknowledged. Special thanks are due to Dr. P. R. Rajmohanan, and Mrs. V. G. Puranik, who went out of their way in helping me out whenever I needed an urgent analysis.*

*I would like to extend my thanks to my friends Dr. Indresh, Alok, Murali, Puspesh, Abhisek, Nagendra, and Anuj for their constant help and encouragement. Special thanks to Satyendra and Rachna for their support and encouragement.*

*Whatever I am and whatever I intend to be in future is because of goodwill, unstinted support and constant love that I have received during my study and doctoral thesis from my parents, sisters, brother-in-law, mother-in-law, my uncle Surendra Tiwari and relatives. I have no words to thank my wife Anita for her permanent help, love and understanding. I am also thankful to my daughter Ananya for making me happy during the period of stress.*

*Finally I thank UGC, New Delhi, for the award of Research Fellowship and Director, N. C. L., for the infra-structural facilities.*

*Keshri Nath Tiwari*

# CONTENTS

Abbreviations		i
General Remarks		ii
Thesis Abstract		iii-xiv
<b>Chapter-1</b>	<b><i>Conduramines in Alkaloid Synthesis</i></b>	<b>1-26</b>
1.1	Introduction	1
1.2	Synthetic applications of conduramines	3
1.2.1	Synthetic intermediates for narcissus alkaloids	3
1.2.2	Synthetic precursor for azasugars	7
1.2.3	Synthetic precursor for sphingosine intermediates	9
1.3	Biological significance of conduramines	10
1.4	Synthetic approaches towards the optically active conduramines	11
1.5	Conduramines related to aminocyclitols : aminocarbasugars	14
1.6	Synthetic approaches for aminocarbasugars	17
1.6.1	Approaches for the synthesis of valienamine	17
1.6.2	Approaches for the synthesis of validamine	20
1.7	Aim of the dissertation	22
1.8	References	24
<b>Chapter-2</b>	<b><i>Enantioselective synthesis of 3-(phenylsulfonyl)-7-azabicyclo[2.2.1]hept-2-one</i></b>	<b>27-42</b>
<b>Section A</b>		
2.1	Importance of 7-azabicyclo[2.2.1]heptane framework	27
2.2.1	Preparation of <i>tert</i> -butyl 2-(phenylsulfonyl)-7-azabicyclo[2.2.1]hepta-2,5-diene-7- carboxylate	31
2.2.2	Preparation of <i>meso-tert</i> -butyl 2,3-bis(phenylsulfonyl)-7-azabicyclo[2.2.1]hept-2-ene-7-carboxylate	32
2.2.3	Preparation of (1 <i>S</i> ,3 <i>R</i> ,4 <i>R</i> ,4' <i>S</i> ,5' <i>S</i> )- <i>tert</i> -butyl- 4',5'-diphenyl-3-(phenylsulfonyl)-7-azaspiro {bicyclo[2.2.1]heptane-2,2' -[1,3]dioxalane }-7-carboxylate	34

2.2.4	Preparation of (1 <i>S</i> ,3 <i>R</i> ,4 <i>R</i> )- <i>tert</i> -butyl-2-oxo-3-(phenylsulfonyl)-7-azabicyclo[2.2.1]heptane-7-carboxylate	37
2.3	References	41
<b>Section B</b>	<b><i>“Anionic fragmentation of 7-Azabicyclo[2.2.1]heptan-2-ol :Enantioselective synthesis of 2-aminocyclohexanols”</i></b>	43-96
2.4	Importance of 2-aminocyclohexanols	43
2.5.1	Retrosynthetic scheme	45
2.5.2	Reduction of (1 <i>S</i> ,3 <i>R</i> ,4 <i>R</i> )- <i>tert</i> -butyl-2-oxo-3-(phenylsulfonyl)-7-azabicyclo[2.2.1]heptane-7-carboxylate	46
2.5.3	Anionic fragmentation	48
2.5.4	Epimerisation studies	50
2.5.5	Synthesis of <i>cis</i> -2-aminocyclohexanol	52
2.6	Experimental section	54
2.7	References	74
2.8	Spectra	75
<b>Chapter-3</b>	<b><i>Enantioselective synthesis of conduramines and aminocarbasugars</i></b>	97-130
3.1	Introduction	97
3.1.1	Conduramines	97
3.1.2	Aminocarbasugars	98
3.2	Work plan and retrosynthetic analysis	101
3.3.1	Synthesis of dihydroconduramine E-1	104
3.3.2	Synthesis of <i>ent</i> -conduramine F-1	105
3.4	Conclusion and future outlook	113
3.5	Experimental section	115
3.6	References	120
3.7	Spectra	121

Publication

Erratum



## Abbreviations

aq.	aqueous	NMR	Nuclear magnetic resonance
bp	boiling point	NOE	Nuclear Overhauser effect/enhancement
Bn	Benzyl	NOESY	Nuclear Overhauser Enhancement Spectroscopy
Boc	<i>t</i> -Butoxycarbonyl	ORTEP	Orthogonal thermal ellipsoid plots
DCM	Dichloromethane	PDC	Pyridinium dichromate
DEPT	Distortionless enhancement by polarization transfer	<i>p</i> -TSA	<i>p</i> -Toluenesulfonic acid
DMF	N, N-dimethyl formamide	py	Pyridine
DMSO	dimethylsulfoxide	rt	Room temperature
COSY	correlated spectroscopy	TBS	<i>t</i> -Butyldimethylsilyl
g	gram	TEA	Triethyl amine
GC	Gas Chromatography	TFA	Trifluoroacetic acid
h	hour	THF	Tetrahydrofuran
Hz	Hertz	TLC	Thin layer chromatography
<i>K<sub>i</sub></i>	Inhibition constant	TMS	Trimethylsilyl
M	Molarity (molar)	$\alpha$ -Glu	$\alpha$ -Glucosidase
Mg	Milligram	$\beta$ -Glu	$\beta$ -Glucosidase
Min	Minute(s)	$\alpha$ -Man	$\alpha$ -Mannosidase
mL	Milliliter	$\beta$ -Man	$\beta$ -Mannosidase
mmol	Millimole		
mp	Melting Point		
N	Normality		
MS	Mass Spectrum		
MsCl	Methanesulfonyl chloride		

## General Remarks

- All the solvents were purified according to literature procedure.<sup>1</sup>
- Petroleum ether used in the experiments was of 60-80 °C boiling range.
- Column chromatographic separations were carried out by gradient elution with suitable combination of two solvents and silica gel (60-120 mesh/ 100-200 mesh/ 230-400 mesh).
- Reaction progress was monitored by TLC or GC. TLC was performed on manually prepared silica gel plates and E-Merck pre-coated 60 F<sub>254</sub> plates and the spots were rendered visible by exposing to UV light, Iodine, phosphomolibdic acid, o-Anisol, KMNO<sub>4</sub>. GC analysis was performed on Perkin Elmer 8700 and Varian CP 3800 GCs using SGE BP1, BP20 and Varian Chromopack CP-Sil-5CB columns.
- IR spectra were recorded on FTIR instrument, for solid either as nujol mull, neat in case of liquid compounds or their solution in chloroform.
- NMR spectra were recorded on Bruker AC 200 (200 MHz <sup>1</sup>H NMR and 50 MHz <sup>13</sup>C NMR), Bruker AV 400 (400 MHz <sup>1</sup>H NMR and 100 MHz <sup>13</sup>C NMR) and Bruker DRX 500 (500 MHz <sup>1</sup>H NMR and 125 MHz <sup>13</sup>C NMR). <sup>13</sup>C peak multiplicity assignments were made based on DEPT data.
- Mass spectra were recorded on PE SCIEX API QSTAR pulser (LC-MS) and Shimadzu QP 5000 GC/MS coupled to Shimadzu 17A GC using a DBI column.
- Microanalysis data were obtained using a Carlo-Erba CHNS-O EA 1108 Elemental Analyser. Elemental analyses observed for all the newly synthesized compounds were within the limit of accuracy ( $\pm 0.4$  %).
- All the melting points recorded are uncorrected and were recorded using electrothermal melting point apparatus.
- Starting materials were obtained from commercial sources.
- **Numbering of compounds, schemes, tables, referencing and figures for each chapter and in abstract are independent.**

---

1) Perrin, D. D.; Armarego, W. L. F. Purification of Laboratory Chemicals, 4<sup>th</sup> ed., Butterworth Heinemann, 1999

Research student	Keshri Nath Tiwari
Research Guide	Dr. Ganesh Pandey
Title of Thesis	Asymmetric Desymmetrization Approach for the Construction of Enantiopure (+)-N-Boc-7- Azabicyclo [2.2.1]hept-2-one : Application in the Synthesis of Biologically Active Alkaloids
Registration no.	E1/04/Ph.D/2004 September 07, 2004
Date of Registration	03.03.2004
Place of work	Division of Organic Chemistry, National Chemical Laboratory, Pune-411008, INDIA.

## **Thesis Abstract**

The present dissertation is divided into three chapters.

### **Chapter 1: Conduramines in alkaloid synthesis**

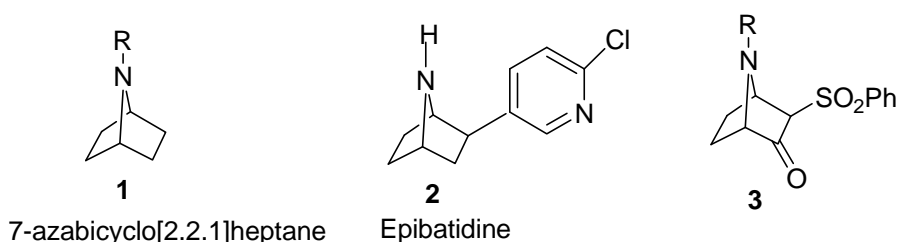
Conduramines are purely synthetic aminocyclohexenetriols formally derived from conduritols in which one of the OH group is exchanged by an amino group. During the last decade, chemists as well as biochemists, are captivated by the structural features, their synthetic diversity and biological activities of the conduramines. Some conduramines have shown significant glycosidase inhibitory activities towards certain glycosidases, but they are of much greater importance as synthetic precursors of amino and diaminocyclitols, many of which constitute an important part of therapeutically useful aminoglycoside antibiotics. In addition, conduramines have been used as intermediates for the preparation of some alkaloids, azasugars and aminosugars. This chapter gives an overview of conduramines, their application in alkaloid synthesis, biological significance and synthetic approaches for optically active conduramines. Aminocyclitols related to conduramines have also been described.

## Chapter 2

This chapter is divided into two sections.

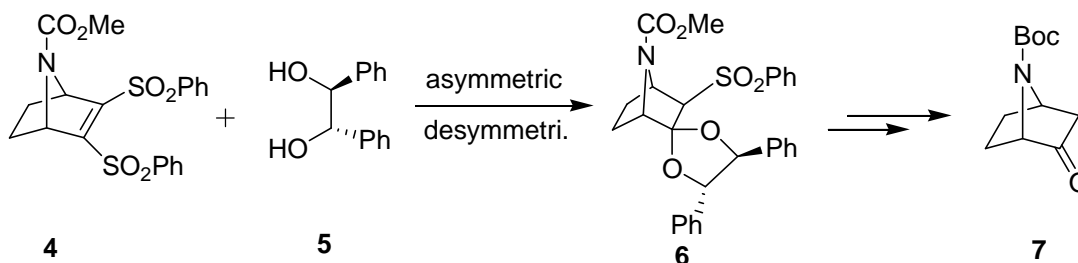
### Section A : Enantioselective synthesis of 3-(phenylsulfonyl)-7-azabicyclo[2.2.1]hept-2-one

The synthesis of the 7-azabicyclo[2.2.1]heptane system **1** has been the subject of numerous synthetic studies which have resulted in the development of several methods for the construction of these novel structures but mostly the chemistry and biology of these ring systems have been revolving around the epibatidine **2**. However, apart from used as a precursor in the synthesis of epibatidine and its analogues, 7-azabicyclo[2.2.1]heptane system has also been explored as a valuable precursor for the synthesis of substituted cyclohexene derivatives but this area is very less explored. Considering the unexplored synthetic potential of **3**, we planned to develop a strategy for the synthesis of substituted cyclohexene derivatives in optically pure form for the synthesis of scores of aminocyclitols.



**Figure 1.**

We had already developed a short and efficient route for the synthesis of (+)-*N*-Boc-7-azabicyclo[2.2.1]hept-2-one **7**, a versatile precursor for the synthesis of epibatidine by asymmetric desymmetrization approach (Scheme 1).

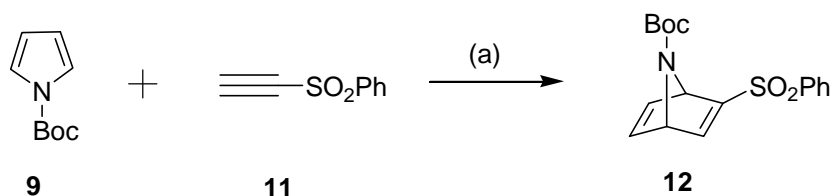


**Scheme 1.**

However during the optimization of reaction conditions it was observed that the protection of *N*-pyrrole as *t*-butyl carbamate was found to be better than the methyl

carbamate. Therefore we revised the starting precursor by changing the protective group.

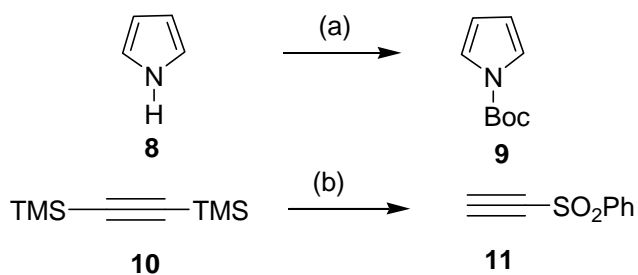
As per our synthetic design, cycloadduct **12** was prepared in 70% yield as a crystalline solid by heating (90 °C) a mixture of ethynyl phenyl sulfone **11** as a dienophile and *N*-*tert*-butoxy pyrrole carbamate **9** as a diene without any solvent (Scheme 2).



**Scheme 2.**

*Reagents and Conditions* : (a) neat, 90 °C, 30 h, 70%

The dienophile **11** was prepared in one step (65% yield) from bis(trimethylsilyl)acetylene **10** by reacting with benzene sulfonyl chloride in the presence of anhydrous aluminium chloride. Since *N*-pyrrole **8** is always considered as a poor diene for Diels-Alder cycloaddition reaction, therefore, it was activated by protection with alkoxy carbonyl group by reacting pyrrole **8** with (Boc)<sub>2</sub>O in the presence of catalytic DMAP in acetonitrile which yielded *N*-*t*-butoxy pyrrole carbamate **9** in quantitative yield (Scheme 3).

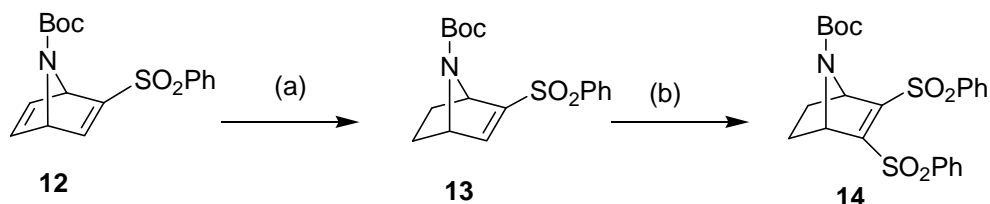


**Scheme 3.**

*Reagents and Conditions* : (a) (Boc)<sub>2</sub>, DMAP, CH<sub>3</sub>CN, 98% (b) AlCl<sub>3</sub>, PhSO<sub>2</sub>Cl, DCM, 24 h, 65%

The *meso*-precursor **14** required for desymmetrization was prepared in two steps. The chemoselective reduction of electron rich olefin of **12** was achieved by using slow stirring of a dilute solution (1.0 g, 25 mL CH<sub>3</sub>CN) under atmospheric pressure of

hydrogen in the presence of 10 mol% Pd/C giving rise to single product **13** in 98 % yield. In order to convert **13** into **14**, the solution of **13** in anhydrous THF at  $-78\text{ }^{\circ}\text{C}$  was treated with *n*-BuLi followed by addition of PhSO<sub>2</sub>F at the same temperature which after quenching afforded **14** in 80% yield (Scheme 4).

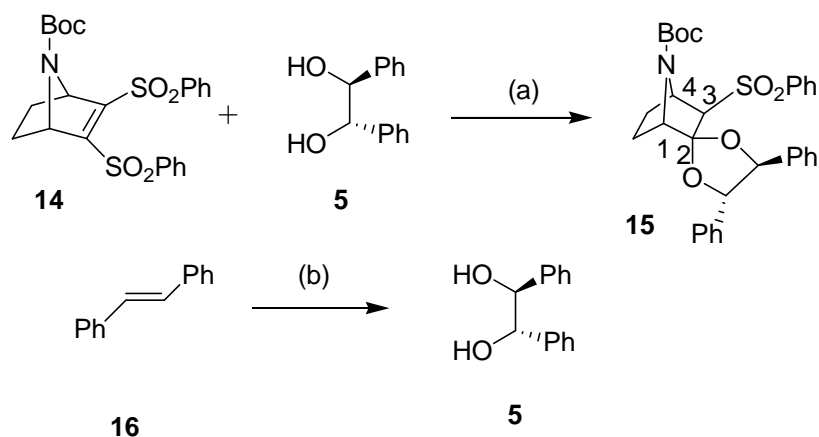


**Scheme 4.**

*Reagents and Conditions* : (a) H<sub>2</sub> (1 atm.), Pd/C (10 %), CH<sub>3</sub>CN, 6 h, 98%

(b) *n*-BuLi, THF, PhSO<sub>2</sub>F,  $-78\text{ }^{\circ}\text{C}$  to rt, 80%

The asymmetric desymmetrization of **14** was carried out by stirring with an equivalent amount of the disodium salt of (-)-**5** in anhydrous THF at  $0\text{ }^{\circ}\text{C}$  for about 2.5 h (Scheme 5). Usual work up and silica gel column chromatographic purification of the reaction mixture provided desymmetrized product **15** as a white floppy solid in 82 % yield. Compound **5** was synthesized by asymmetric dihydroxylation of *trans*-stilbene **16** (Scheme 5).



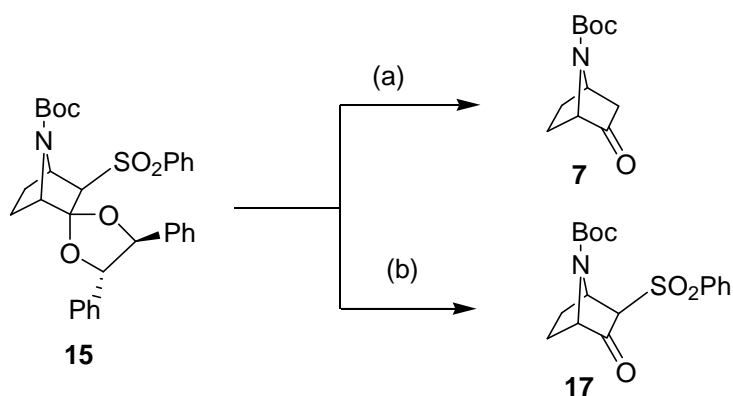
**Scheme 5.**

*Reagents and Conditions* : (a) NaH, THF,  $0\text{ }^{\circ}\text{C}$ , 3 h, 82% (b) AD Mix.- $\alpha$ , *t*-BuOH: H<sub>2</sub>O (1:1), 24 h,  $0\text{ }^{\circ}\text{C}$ , 80%.

The crude <sup>1</sup>H NMR spectrum of **15** displayed one singlet for H-3 proton at  $\delta$  3.65 indicating it to be a single diastereomer, which was further confirmed by HPLC

analysis [ Merck Purospher (250x 4.6 mm) CH<sub>3</sub>CN:H<sub>2</sub>O (60:40) isocratic, flow rate 1.2 mL/min, retention time 27.85 min].

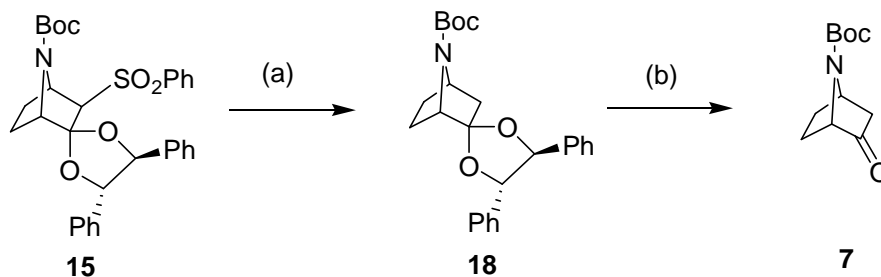
In order to get ketone moiety, the dioxalanic deprotection of **15** was necessary, but this reaction proved to be a problematic reaction as all the standard methods of acetal and ketal deprotection failed to give the required product **17**. When **15** was subjected for Birch reduction, it produced the bicyclic ketone **7** with the elimination of phenylsulfonyl group. Since phenylsulfonyl group was essential for further synthetic elaborations, we looked for alternative approach. Gratifyingly, treatment of **15** under hydrogenation condition at 60 psi using acetic acid as solvent, the dioxalanic group was cleaved to provide **17** (Scheme 6).



*Scheme 6.*

*Reagents and Conditions :* (a) Na, Liq. NH<sub>3</sub>, THF, 70% (b) H<sub>2</sub>, Pd/C, AcOH, 60 psi, 24 h, 70%, recovered 30% **15**

Although **17** was obtained by hydrogenation, this reaction was found to be very slow probably because of sulfone group which poisons the catalyst. In order to confirm this observation, phenyl sulfonyl group was removed by reductive desulfonylation of **15** with 6% sodium amalgam which produced desulfonylated product **18**. When **18** was subjected for usual hydrogenation at atmospheric pressure, it furnished **7** with the complete consumption of starting material (Scheme 7).



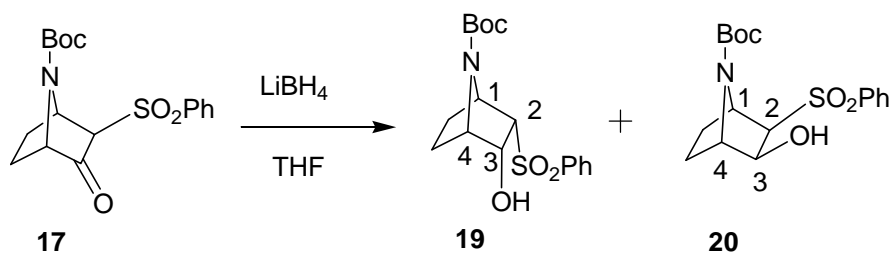
**Scheme 7.**

*Reagents and Conditions* : (a) Na-Hg, NaH<sub>2</sub>PO<sub>4</sub>, MeOH, 0 °C, 3 h, 70% (b) H<sub>2</sub>, Pd/C, MeOH, 12 h, 90%

**Section B : “Anionic fragmentation of 7-azabicyclo[2.2.1]heptan-2-ol : Enantioselective synthesis of 2-aminocyclohexanols ”**

This section provides the detailed study about anionic fragmentation and the synthesis of 2-aminocyclohexanols.

After having **17** in hand, our next aim was to apply anionic fragmentation and therefore it was decided to install hydroxyl functionality. In this context, reduction of **17** with lithium borohydride was attempted. Considering the rigid bicyclic structure of **17**, we hoped that reduction with lithium borohydride would furnish only alcohol **20**, owing to the *endo*-attack of the hydride on carbonyl group. However, reduction at room temperature unexpectedly, gave diastereomeric mixture of alcohols **19** and **20** (Scheme 8). Fortunately, both diastereomers could be easily separated by silica gel column chromatography.



**Scheme 8.**

Since reduction of **17** at room temperature produced diastereomeric mixtures of corresponding alcohols (**19** and **20**), it became obvious to us that there was an epimerization of H-2 during reduction.. Therefore, it occurred to us to investigate the

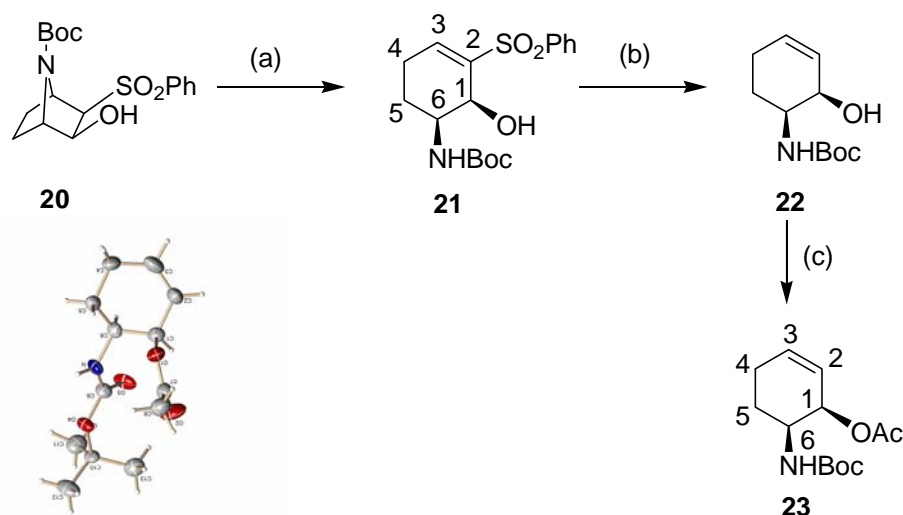


reduction at lower temperature and the ratio of **19** and **20** with respect to temperature is shown in Table 1.

**Table-1.** Yields and ratio of **19** and **20** during reduction of ketone.

Entry	Temperature (°C)	Ratio (19/ 20)	Time	Yield(%) (combined)
1	-78	7:3	30 min.	75
2	-90	7.5:2.5	45 min.	70
3	25	1:9	12 h	78

Since **20** is an admirably suitable substrate for exploring base mediated anionic rearrangement, it was succeeded by the addition of excess of methyl magnesium bromide in a THF solution at room temperature producing **21** in 80% yield as a crystalline solid  $\{[\alpha]_D^{25} -69.0 (c 1.00, \text{CHCl}_3), \text{mp } 131 \text{ }^\circ\text{C} \}$ .

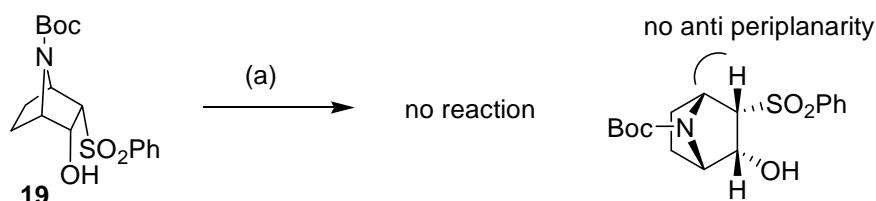


**Figure 2.** ORTEP diagram of **23** **Scheme 9.**

**Reagents and Conditions :** (a) MeMgBr, THF, rt, 3 h, 80% (b) Na-Hg (6%), Na<sub>2</sub>HPO<sub>4</sub>, THF:MeOH (1:1), -6 °C, 2 h, 80% (c) AcCl, Et<sub>3</sub>N, DCM, rt, 12 h, 80%

Owing to undefined couplings between the two stereochemical protons (H-1 and H-6) in the <sup>1</sup>HNMR of **21**, it was difficult to assign the relative configuration satisfactorily. The removal of the phenylsulfonyl group, using 6% sodium amalgam in a buffered methanol, followed by the acetate protection of the free hydroxyl group of the resultant molecule **22** gave **23** which was a good crystalline solid (mp 66 °C) and produced X-ray structure (Figure 2) confirming *cis*-1, 6-amino alcohol configuration in **21** (Scheme 9).

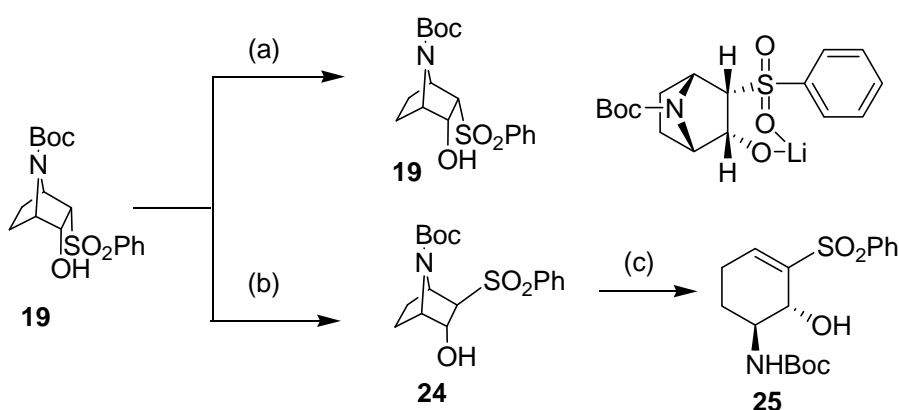
Highly encouraged with the success of the ring opening of **20**, we considered that **19** could also be equally well accessible substrate for rearrangement, however, reaction



**Scheme 10.**

*Reagents and Conditions* : (a) MeMgBr, THF, rt, 3 h, 80%

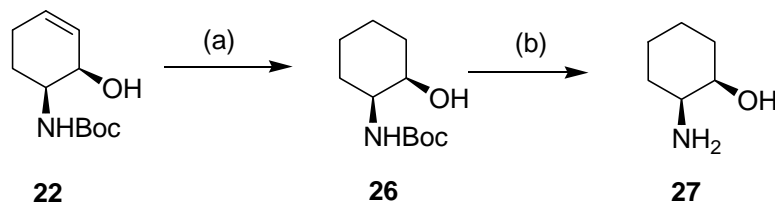
of **19** with methyl magnesium bromide under similar reaction conditions failed to give any product (Scheme 10). A close look at the structure of **19** indicated that in this molecule, the orientation of sulfone moiety is *endo* which possibly did not allow the fragmentation due to the lack of antiperiplanarity between the bonds to be cleaved. Therefore we planned to epimerise the *endo* sulfone group of **19** to *exo* sulfone and in this context, initially the epimerization using LiHMDS was tried but it failed to give the expected **24** probably because of the chelation of lithium between hydroxyl oxygen and sulfonyl oxygen. Therefore, the reaction with KHMDS was evaluated and to our pleasure it gave **24** in 70% yield. Subjecting **24** for the ring opening reaction using the same experimental protocol as described above for **20**, yielded product **25** in 70% yield as a crystalline solid {mp 125 °C  $[\alpha]_D^{25} +14.6$  (*c* 0.40, CHCl<sub>3</sub>) }(Scheme 11).



**Scheme 11.**

*Reagents and Conditions* : (a) LiHMDS, THF, -78 °C, 3 h to rt (b) KHMDS, THF, -78 °C, 4 h to rt, 70% (c) MeMgBr, THF, rt, 70%

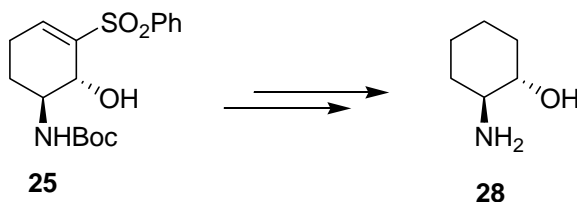
Towards the exploration of synthetic utility of **22**, the olefin was reduced by palladium catalysed hydrogenation to obtain **26** which on carbamate deprotection with TFA yielded *cis*-2-aminocyclohexanol **27** as a crystalline solid (Scheme 12).



**Scheme 12.**

*Reagents and Conditions* : (a) H<sub>2</sub>, Pd/C, MeOH, 5 h, 95% (b) TFA, DCM, 5 h, 90%

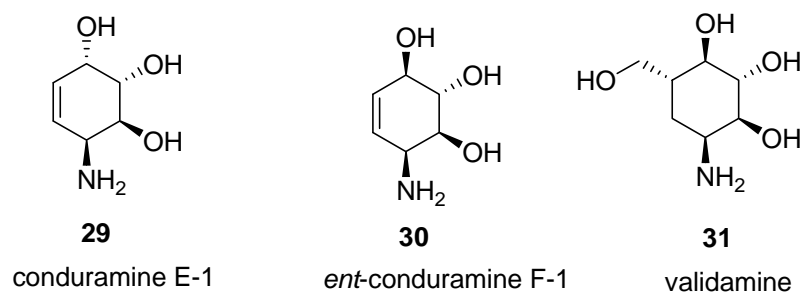
Similarly, *trans*-2-aminocyclohexanol **28** is also obtained from **25** by performing the similar set of experiments (Scheme 13).



**Scheme 13.**

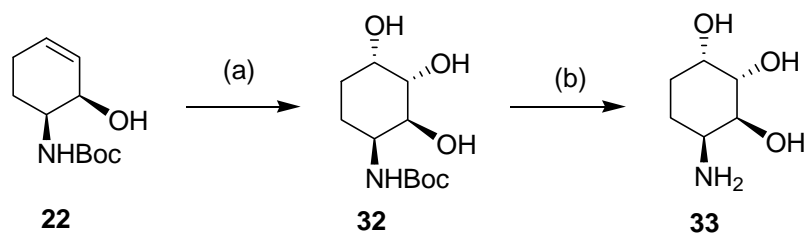
### Chapter 3 : “Enantioselective syntheses of conduramines and aminocarbasugars”

Conduramines as well as aminocarbasugars (Figure 3), due to their structural similarity with sugars, are a family of carbohydrate mimic which have attracted a great deal of attention among organic and medicinal chemists due to their profound biological activities towards glycosidases. These compounds possess arrays of hydroxyl and amino groups and are potentially interesting systems, as they can target pivotal RNA sites, and are thus candidates for drug discovery. Especially, conduramines have been used as intermediates for the preparation of some alkaloids, azasugars and aminosugars.



**Figure 3.**

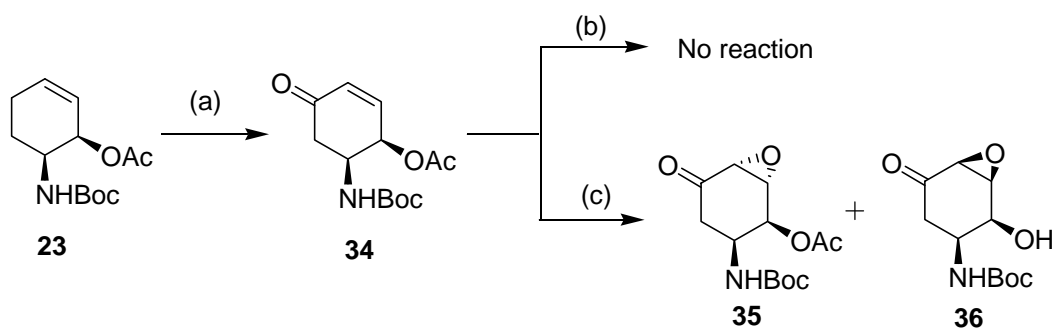
Although, unknown in all respect, dihydroconduramine E-1 **33** can be tested as inhibitors towards some of the glycosidases. To synthesize **33**, OsO<sub>4</sub> catalysed dihydroxylation was performed on **22** to give expected triol **32** which on carbamate deprotection gave **33** in 75% yield as a single diastereomer (Scheme 14).



**Scheme 14.**

*Reagents and Conditions* : (a) OsO<sub>4</sub>, NMO, NaHCO<sub>3</sub>, *t*-BuOH: H<sub>2</sub>O (1:1), 12 h, rt, 75% (b) 3*N* HCl, 1,4-dioxane, 6 h, 100 °C, 90%

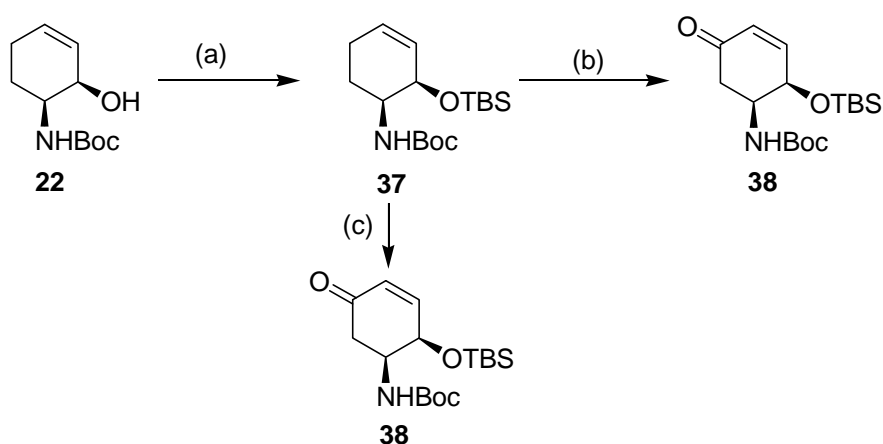
Towards the synthesis of *ent*-conduramine F-1 **30**, the allylic oxidation of **23** was attempted with freshly prepared PDC using *t*-BuOOH which produced the required enone **34** in 70% yield. However, attempts to cause epoxidation of **34** nucleophilically via sodium bicarbonate and hydrogen peroxide was found unsuccessful, a mixture of isomers **35** and **36** were obtained with *t*-BuOOH and DBU in THF (Scheme 15).



**Scheme 15.**

*Reagents and Conditions:* (a) PDC, *t*-BuOOH, DCM, rt, 24 h, 70% (b) NaHCO<sub>3</sub>, H<sub>2</sub>O<sub>2</sub>, THF, 0 °C to rt, 4 h (c) *t*-BuOOH, DBU, THF, rt, 6 h, 65%

Having encountered difficulty in epoxidation, it was decided to protect hydroxyl group with TBSCl as it exerts steric bulk during the epoxidation. In this regard, **22** was protected as TBS ether with standard conditions to furnish **37** in 80% yield.

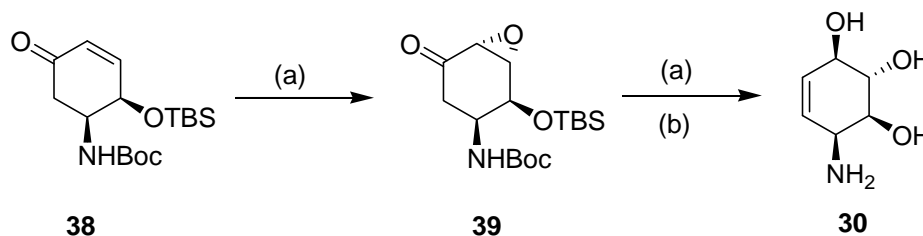


**Scheme 16.**

*Reagents and Conditions :* (a) TBSCl, Im, DMAP, DCM, 18 h, 80% (b) PDC, *t*-BuOOH, DCM, 24 h, 40% (d) Pd/C, K<sub>2</sub>CO<sub>3</sub>, *t*-BuOOH, DCM, 0 °C, 24 h, 75%

When **37** was subjected for allylic oxidation using similar kind of reaction conditions described earlier, it produced enone **38** in low yield (40%). However, a protocol given by Corey et al. which involves palladium charcoal and *t*-BuOOH worked well for **37** and produced the expected enone **39** in 75% yield (Scheme 16). When enone **38** was exposed to *t*-BuOOH and a catalytic amount of Triton B in anhydrous THF, it afforded exclusively the epoxy ketone **39** in 85% yield as a single

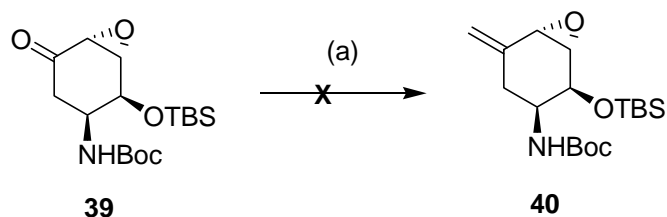
diastereomer (Scheme 17). Compound **39** was enolised by use of KHMDS at  $-78^{\circ}\text{C}$  and subsequently trapped by Comins reagent which produced corresponding enol triflate which on reductive elimination produced double bond. Finally the epoxide opening was done with  $0.2\text{ N H}_2\text{SO}_4$  in dioxane and the resulting compound was refluxed with  $12\text{ N HCl}$  to yield *ent*-conduramine F-1 **30** (Scheme 17).



**Scheme 17.**

*Reagents and Conditions* : (a) *t*-BuOOH, Triton B, THF,  $0^{\circ}\text{C}$ , 3 h, 85% (b) KHMDS, Comins reagent,  $\text{Pd}(\text{PPh}_3)_4$ ,  $\text{Et}_3\text{SiH}$ , THF (b)  $0.2\text{ N H}_2\text{SO}_4$ , 1,4-dioxane,  $12\text{ N HCl}$ , reflux

For the synthesis of validamine, exocyclic double bond was necessary and therefore, **39** was treated with Wittig salt generated by  $\text{PPh}_3$  and  $\text{CH}_3\text{I}$  in THF at  $0^{\circ}\text{C}$  by slow addition of *n*-BuLi and was stirred for 10 h at room temperature. To our disappointment, it produced a complex reaction mixture (Scheme 18). Even screening of many bases also did not help to get the required product **40**.



**Scheme 18.**

*Reagents and Conditions* : (a)  $\text{PPh}_3$ ,  $\text{CH}_3\text{I}$ , *n*-BuLi,  $0^{\circ}\text{C}$  to rt, 10 h



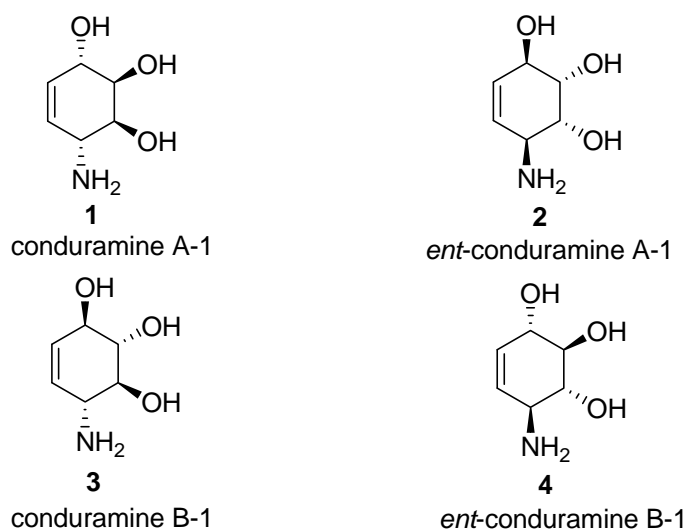
*Chapter-1*

*Conduramines in Alkaloid Synthesis*

## 1.1 Introduction

Conduramines are purely synthetic aminocyclohexenetriols<sup>1</sup> formally derived from conduritols in which one of the OH group is exchanged by an amino group. During the last decade, chemists as well as biochemists are captivated by the structural features, their synthetic diversity and biological activities of the conduramines. Some conduramines have shown significant glycosidase inhibitory activities towards certain glycosidases, but they are of much greater importance as synthetic precursors of amino and diaminocyclitols, many of which constitute an important part of therapeutically useful aminoglycoside antibiotics. In addition, conduramines have been used as intermediates for the preparation of some alkaloids, azasugars and aminosugars. Similar to conduritols, theoretically ten stereoisomers are possible for the conduramines and in order to avoid ambiguity, the six diastereomers are designated by suffixing capital A to F.

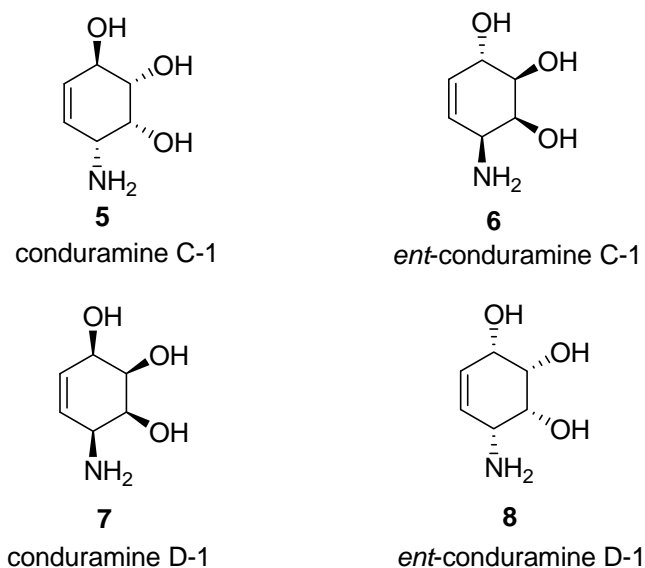
There are two types of conduramine A and B i.e. conduramine A-1 **1**, its enantiomer **2**, conduramine B-1 **3** and its enantiomer **4** (Figure 1). A number of *Amaryllidaceae* alkaloids<sup>2</sup> contain the conduramine A-1 **1** structure and show interesting inhibitory activities towards glycosidases. Although, conduramine B-1 **3** does not exhibit any inhibitory activity, its *N*-benzyl derivatives<sup>3</sup>, have been found as good inhibitors to  $\beta$ -glucosidases and  $\beta$ -xylosidases.



**Figure 1.** Conduramine A and B

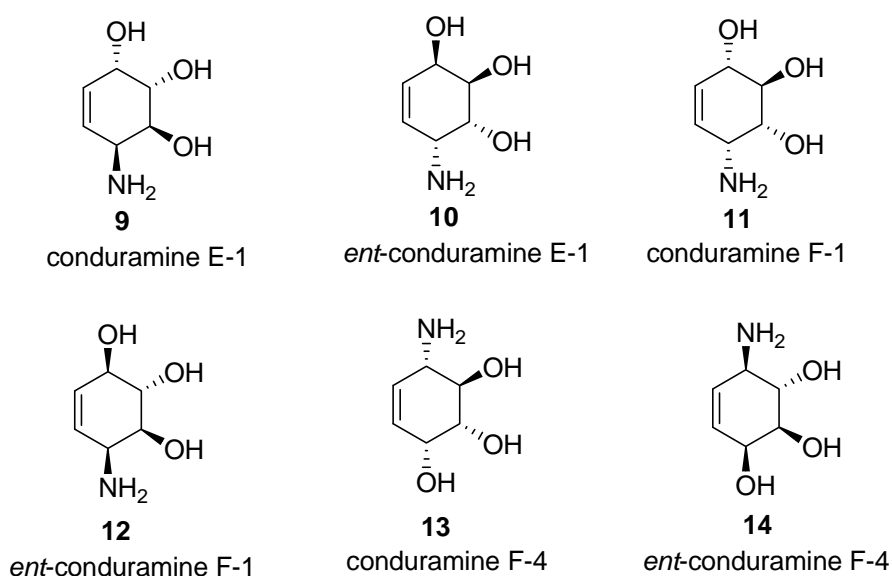


Similarly, conduramine C and D are also classified further as C-1 **5**, its enantiomer **6**, D-1 **7** and its enantiomer **8** (Figure 2).



**Figure 2.** Conduramine C and D

Conduramine E has two types, conduramine E-1 **9** and its enantiomer **10** whereas conduramine F has four types, conduramine F-1 **11**, *ent*-conduramine F-1 **12**, conduramine F-4 **13** and its enantiomer **14** (Figure 3). Although, conduramine E is unknown in all respect, conduramine F and its enantiomer have been synthesized and their biological activities evaluated along with their epoxides<sup>4</sup>.



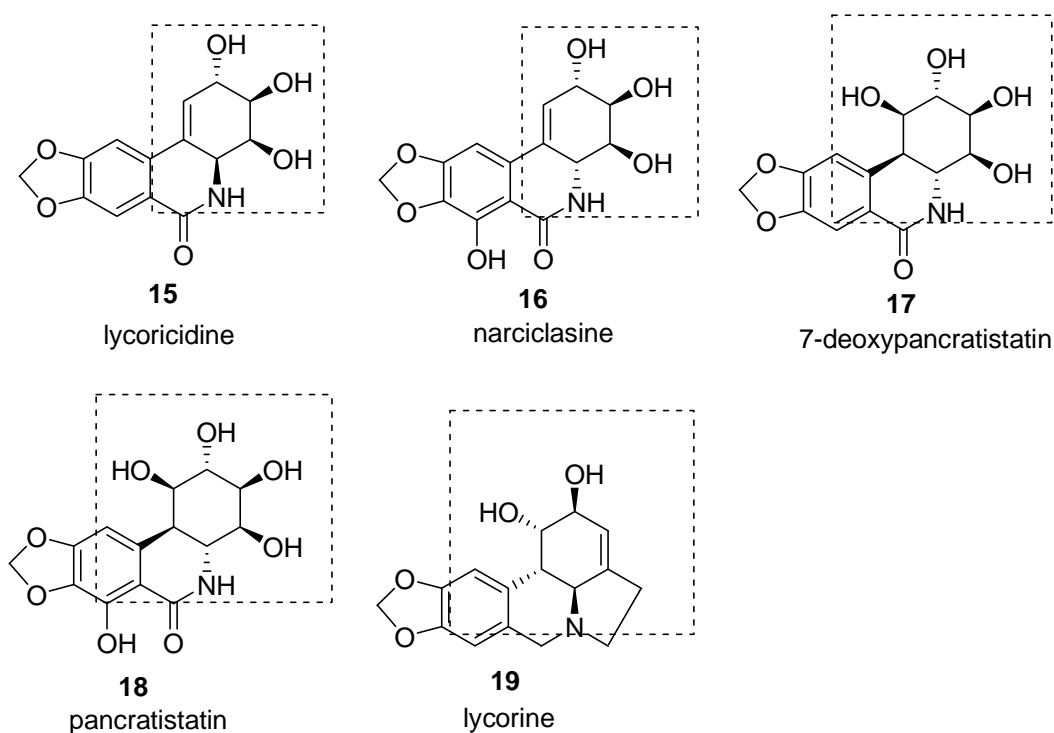
**Figure 3.** Conduramine E and F

## 1.2 Synthetic applications of conduramines

Because conduramines contain an alkene moiety, they have been utilized as synthetic intermediates for the synthesis of complicated and more functional compounds of biological interest. Some of them are summarised as follows:

### 1.2.1 Synthetic intermediates for narcissus alkaloids

Pancratistatin class of alkaloids are produced by *Amaryllidaceae* family which show wide range of interesting physiological effects including antitumor, antiviral, acetylcholinesterase inhibitory, immunostimulatory and antimalarial activities. These alkaloids are of particular interest because of their potential use in clinical therapy. Among these classes of alkaloids, lycoricidine (**15**), narciclasine (**16**), and 7-deoxypancrastatin (**17**), pancratistatin (**18**) and lycorine (**19**) (Figure 4) are isolated<sup>5</sup>, screened for antitumor activity<sup>6</sup> and synthesized by a number of research groups. Some of these alkaloids also display antiglycosidic activity because of the similarity of their oxygenation pattern to that of natural sugars<sup>7</sup>.

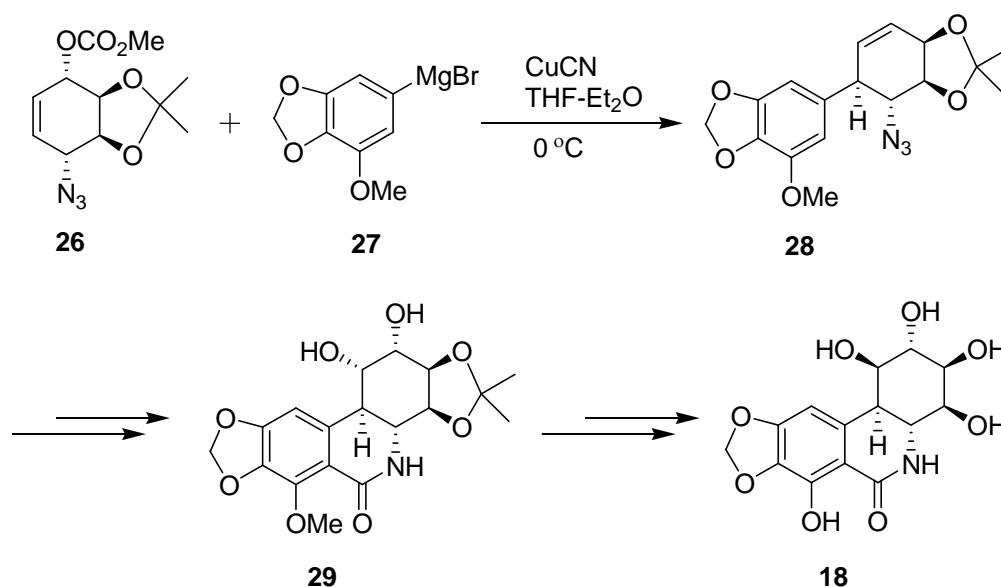


**Figure 4.** Narcissus class of alkaloids having aminocyclitol



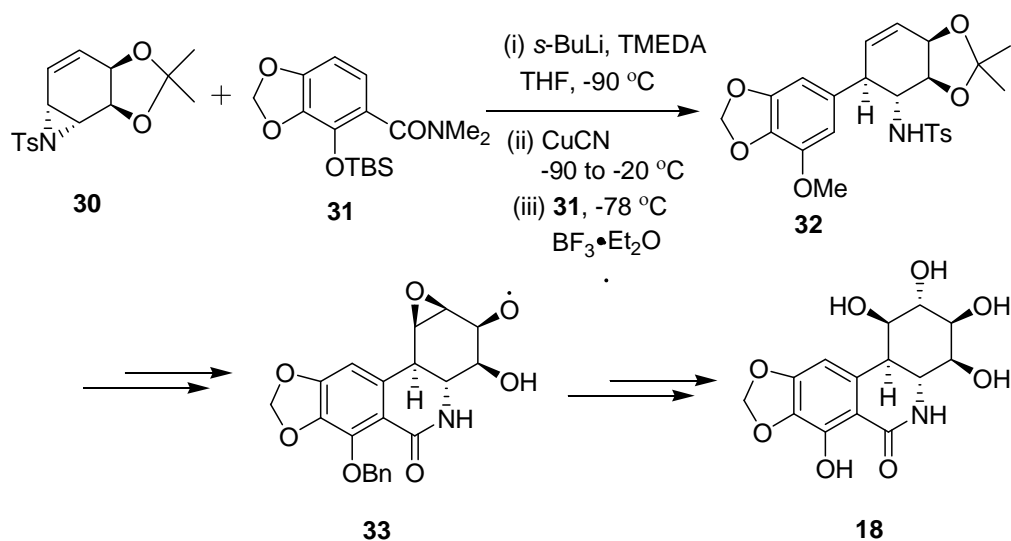
Since these alkaloids are available only in minute quantities from natural sources and their future as therapeutic agents depends on their availability, there is a strong demand for the development of syntheses or semisyntheses of these alkaloids and their derivatives as a potential prodrugs<sup>8</sup> because isolation in larger quantity is not practical. Relying on this strategy, conduramine A-1 and their derivatives have been successfully utilized in the synthesis of narcissus alkaloids by various research groups. It would be quite logical to discuss some of these kinds of approaches.

Trost and Pulley have described<sup>9</sup> a synthetic strategy for (+)-pancratistatin where they have used conduramine A-1 analogue **26** and Grignard reagent **27** for the coupling reaction as a key step (Scheme 2).



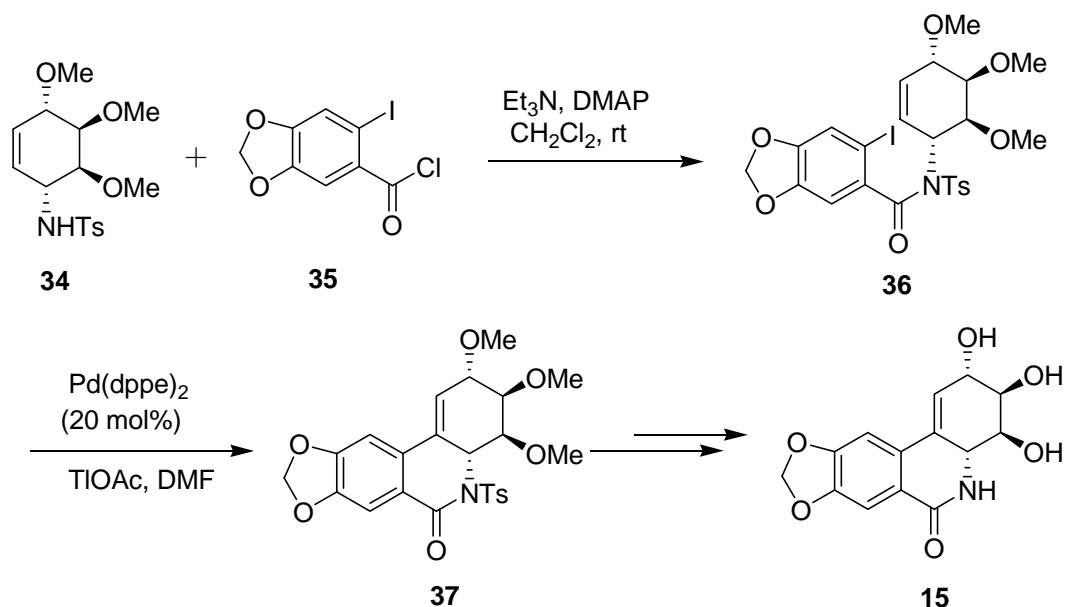
*Scheme 2.*

Hudlicy and coworkers<sup>10</sup> have developed an alternative strategy for the enantioselective total synthesis of (+)-pancratistatin where the key step is the coupling reaction of tosylazairidine **30** with amide **31** via *ortho*-metalation (Scheme 3).



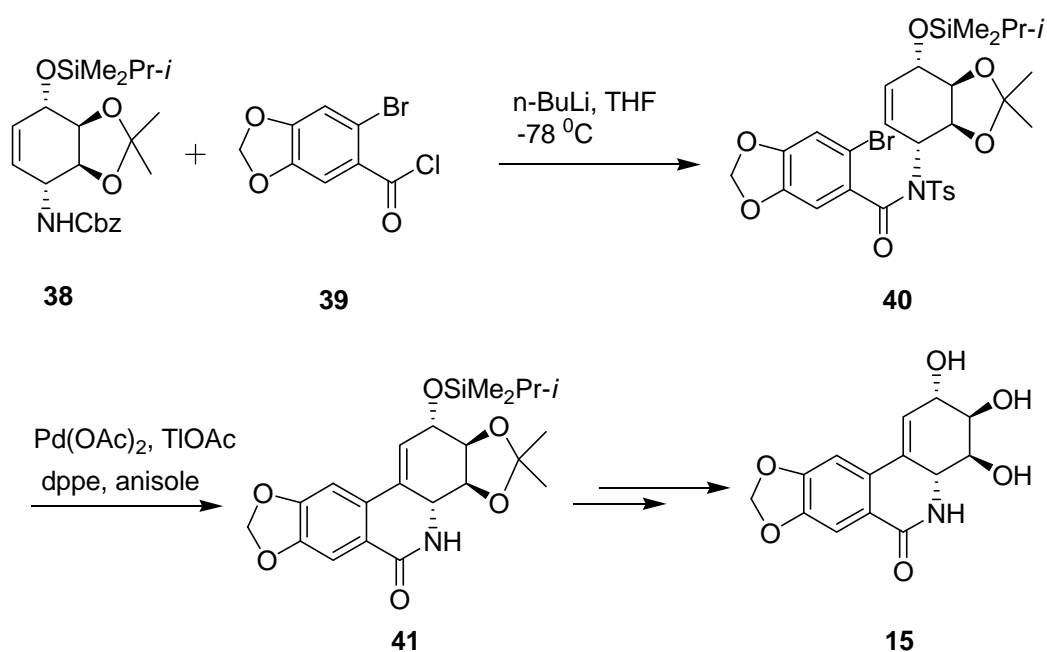
Scheme 3.

A convergent synthesis of a protected version of (+)-lycoridine has been accomplished by McIntosh and Weinreb<sup>2</sup>. The key step involved was palladium catalysed cyclisation of olefinic part of **34** with internal tethered iodo substrate **36** utilizing modified Ogawa procedure<sup>11</sup> (Scheme 4).



Scheme 4.

Similar kind of synthetic scheme has also been used by Hudlicky and Olivo<sup>12</sup> in their total synthesis of (+)-lycoridine (Scheme 5).



Scheme 5.

### 1.2.2 Synthetic precursor for azasugars

Azasugars are now a days emerging as an important class of compounds with interesting biological properties<sup>13</sup>. Many azasugars (Figure 5) bind to the active site of glycosidases stronger than the saccharides they mimic, resulting in the inhibition of enzymes. These interferences have led to use them in therapeutic applications in viral infections, metabolic diseases and cancer. Conduramines have also been used as chiral precursor for the synthesis of various azasugars.

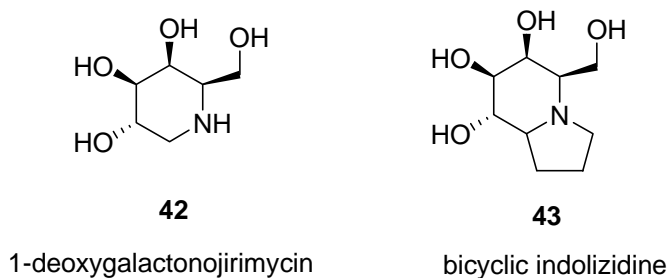
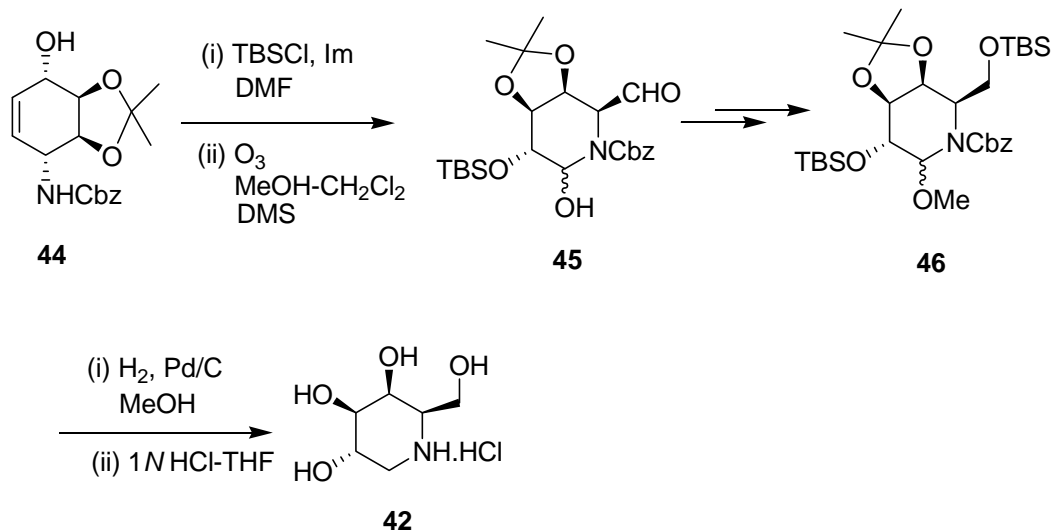
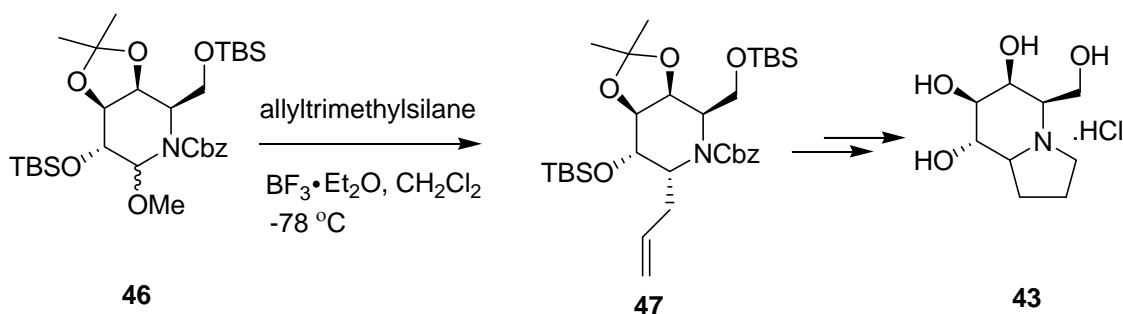


Figure 5.

Johnson group has reported<sup>14</sup> the synthesis of 1-deoxygalactonojirimycin **42** as well as synthesis of bicyclic indolizidine **43** starting from enantiopure conduramine derivative **44** by simple synthetic manipulations (Scheme 6 and 7).

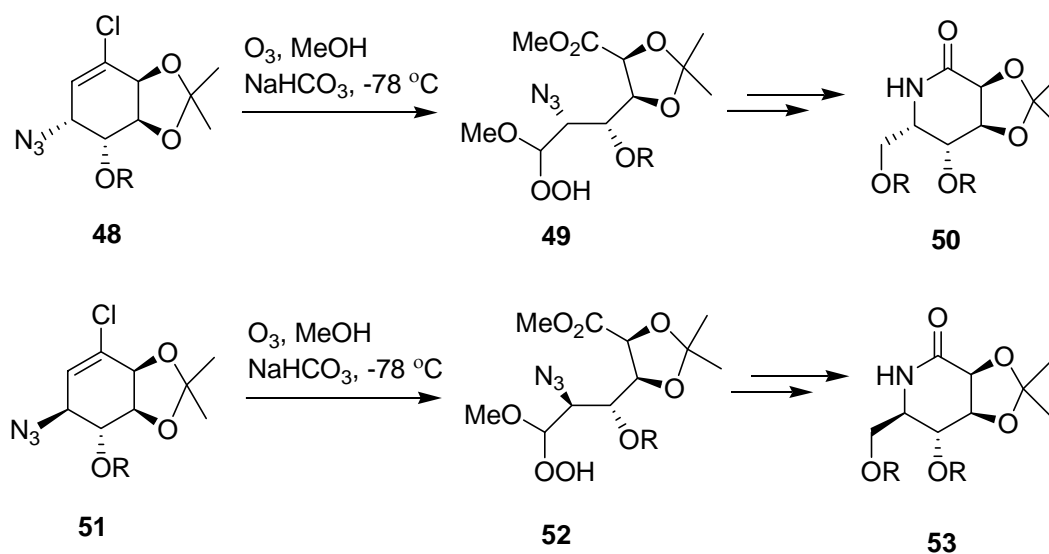


Scheme 6.



Scheme 7.

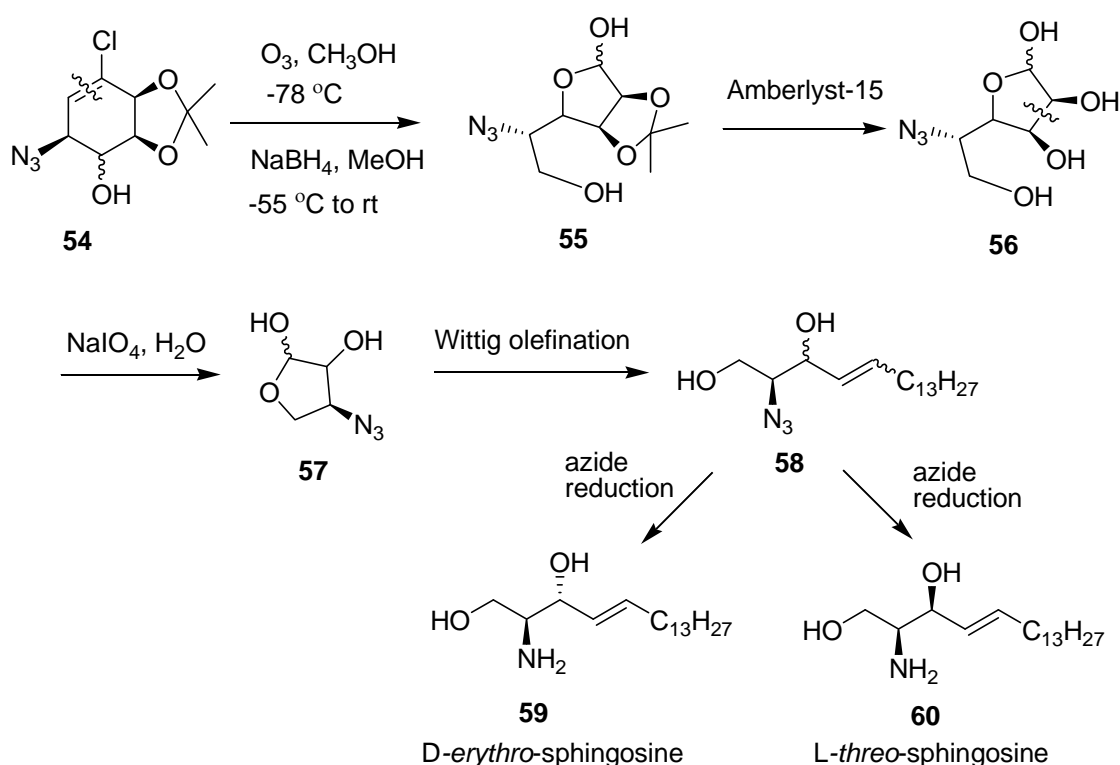
Hudlicky's group has utilised<sup>15</sup> olefinic moiety of conduramine to develop an efficient approach for the synthesis of mannojirymicin **50** and its C-5 epimer **53** via oxidative cleavage of olefin (Scheme 8).



Scheme 8.

### 1.2.3 Synthesis of sphingosine intermediates

Sphingosines constitute a group of related long-chain aliphatic 2-amino-D-*erythro*-4(*E*)-octa-decene-1,3-diol which occurs most frequently in animal glycosphingolipids, the glycosides of N-acylsphingosines or ceramides. The structural variation inherent in fatty acids, sphingosines and carbohydrates results in a great number of chemically distinct glycosphingolipids<sup>16</sup> which are of intense interest because of their diverse biological roles. Most of the syntheses of optically pure sphingosines have relied on the use of L-serine as a chiral building block. However, conduramines have been considered as a synthetic precursor for the synthesis of both *erythro* as well as *threo* sphingosines. For example, ozonolysis of azido alcohol **54** followed by NaBH<sub>4</sub> reduction produced azido-D-gulose **55**. The acetal deprotection followed by NaIO<sub>4</sub> cleavage gave azidolactol **57** with concomitant loss of glyoxalate. The Wittig olefination of lactol followed by selective azide reduction yielded **59** and **60** (Scheme 9)<sup>17</sup>.



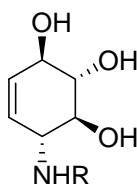
Scheme 9.



### 1.3 Biological significance of conduramines

The fact that conduramines display array of amine and polyol functionalities can mimic the oligosaccharide which makes them as a candidate for glycosidase inhibitors. In fact some of the conduramines have been synthesized and tested towards various glycosidases.

Although, (-)-conduramine B-1 has been synthesized and its inhibitory activity has been tested<sup>3</sup>, it does not inhibit to any glycosidases, however on *N*-benzylation it has been found as a moderate inhibitors to  $\beta$ -glucosidases and  $\alpha$ -mannosidases from almonds as shown in the Figure 7. Since *N*-benzyl derivative of conduramine B-1 are expected to be more hydrophobic in nature than the corresponding valienamine derivatives and thus they have a better chance to become orally active drugs in the treatment of Gaucher's disease.



*N*-derivative of conduramine B-1

#### $\beta$ -Glucosidase inhibitors

R = Bn  $IC_{50}$  = 32;  $K_i$  = 10 (almonds)  
 R =  $CH_2C_6H_4OH-p$   $IC_{50}$  = 72 (almonds)  
 R =  $CH_2C_6H_4Cl-p$   $IC_{50}$  = 35 (almonds)

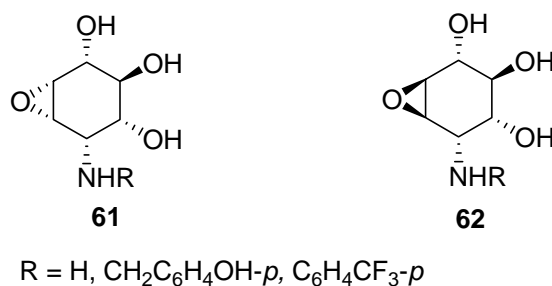
#### $\alpha$ -Mannosidase inhibitors

R = Bn  $IC_{50}$  = 225 (almonds)  
 R =  $CH_2C_6H_4OH-p$   $IC_{50}$  = 183 (almonds)  
 R =  $CH_2C_6H_4Cl-p$   $IC_{50}$  = 77 (almonds)

**Figure 7.**

*ent*-Conduramine F-1 **12**, which is also called as norvalienamine (one hydroxymethyl group less than valienamine) is a highly selective but moderate inhibitor of maltase ( $\alpha$ -glucosidase) from yeast ( $IC_{50}$  = 250  $\mu$ M,  $K_i$  = 42  $\mu$ M, competitive). It has been shown<sup>18</sup> that *N*-benzylation increases its inhibitory activity toward amylase from yeast. Similarly, racemic conduramine F-1 epoxides **61** and **62** (Figure 8) have also been synthesized and tested<sup>4</sup> against various glycosidases. These epoxides have been found as poor inhibitors of  $\alpha$ -glucosidase and  $\beta$ -xylosidase from yeast. The inhibitory

activity toward  $\beta$ -xylosidase is probably due to the position it occupies in enzyme active site. Interestingly, their *N*-substituted derivatives have shown improved inhibitory activity toward  $\alpha$ -glucosidase than  $\beta$ -xylosidase.

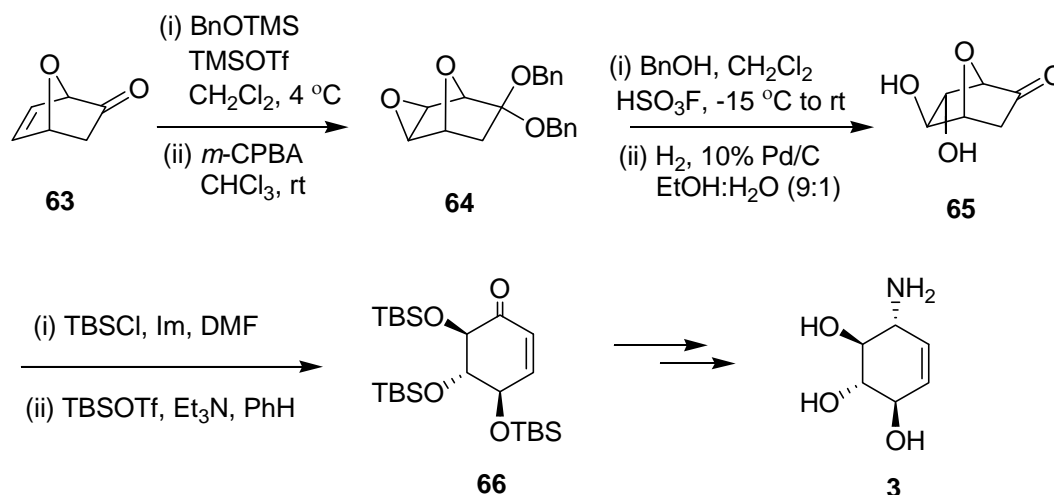


*Figure 8.*

#### *1.4 Synthetic approaches towards the optically active conduramines*

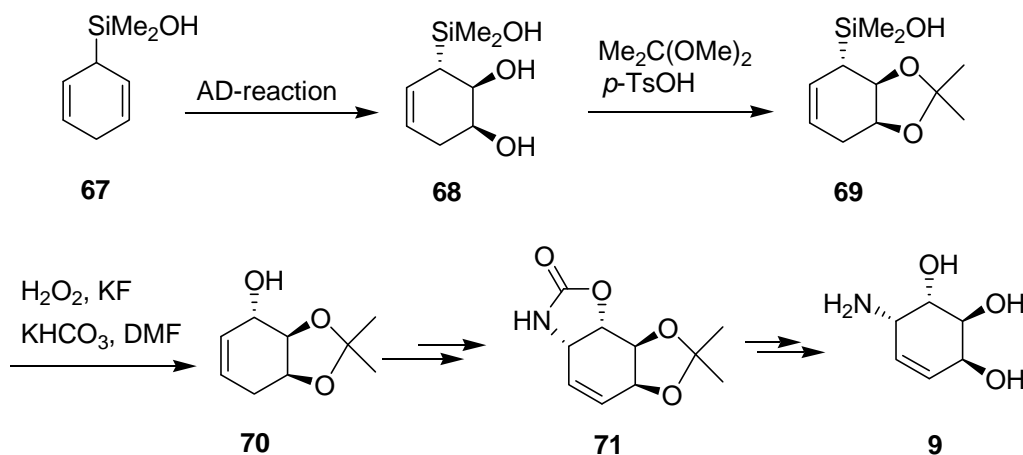
Considering the importance of conduramines and their derivatives as synthetic intermediates for various classes of biologically activities including significant glycosidase inhibitory activities, a variety of approaches have been developed, in both racemic and chiral domains. The synthetic strategies have exploited either cycloaddition route or by elaboration of proper carbohydrates and carbocycles. Although, it is beyond the scope of this dissertation to discuss all the reported protocols for the syntheses of conduramines, it would be imperative to discuss some of the strategies reported in the literature.

Recently, (-)-conduramine B-1 was prepared by Vogel and coworkers<sup>19</sup> applying ‘naked sugar methodology’ starting from (+)-7-oxabicyclo[2.2.1]hept-5-en-2-one **63**. The dibenzyl acetal obtained from bicyclic ketone **63** on treatment with strong acid led to the formation of *trans*-diol **65** which on ring opening produced **66**. Reduction of ketone moiety of **66** and introduction of amine functionality through phthalimide followed by deprotection yielded (-)-conduramine B-1 **3** (Scheme 10).



Scheme 10.

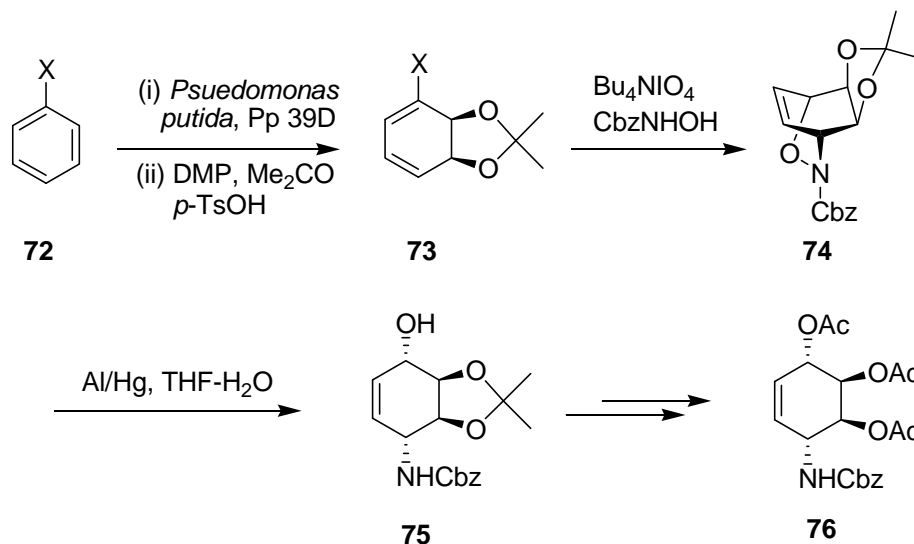
A conceptually attractive approach was designed by Landais<sup>20</sup> group for the synthesis of **9** by the desymmetrization of cyclohexadienylsilanes, available from Birch reduction of the corresponding arylsilanes, and carrying out asymmetric dihydroxylation and aminohydroxylation sequentially which underwent with complete diastereocontrol. The enantiopure diol **68** was elaborated straightforward to the synthesis of conduramine E-1 **9** (Scheme 11).



Scheme 11.

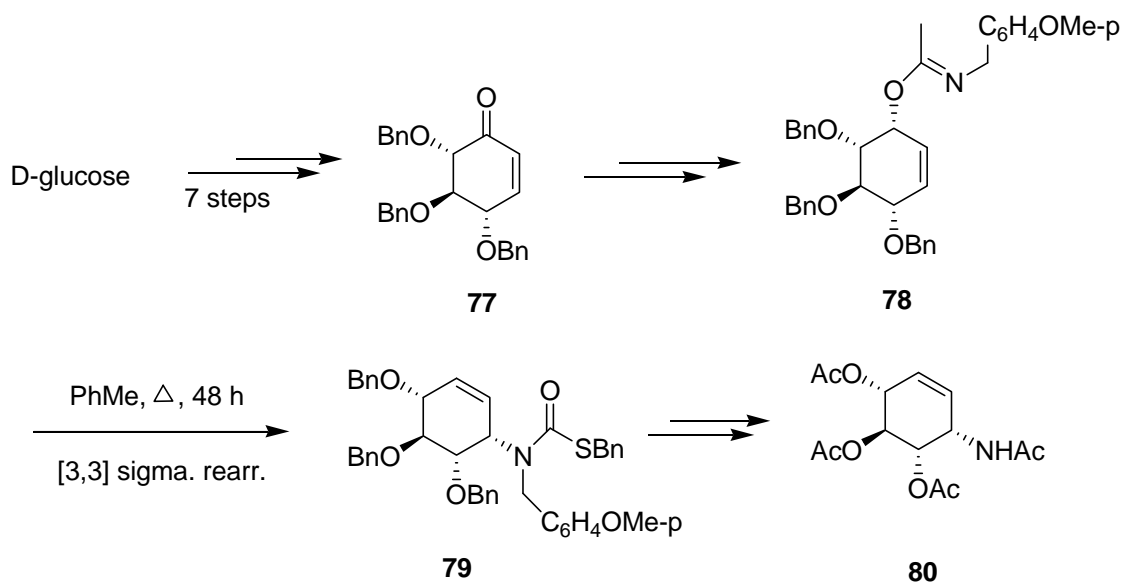
Hudlicky and co-workers<sup>21</sup> devised a very effective synthetic strategy to produce either (+) or (-)-conduramine A-1 derivatives from a single optically pure, chloro or 1-bromodiol **73** which was obtained from the corresponding inexpensive halobenzenes by fermentation using *Pseudomonas putida* strain. Protection of diol and subsequent

hetero-Diels-Alder addition with CbzN=O produced corresponding oxazolidines **74** which upon simple synthetic manipulations provided fully protected conduramine A-1 derivative **76** (Scheme 12).



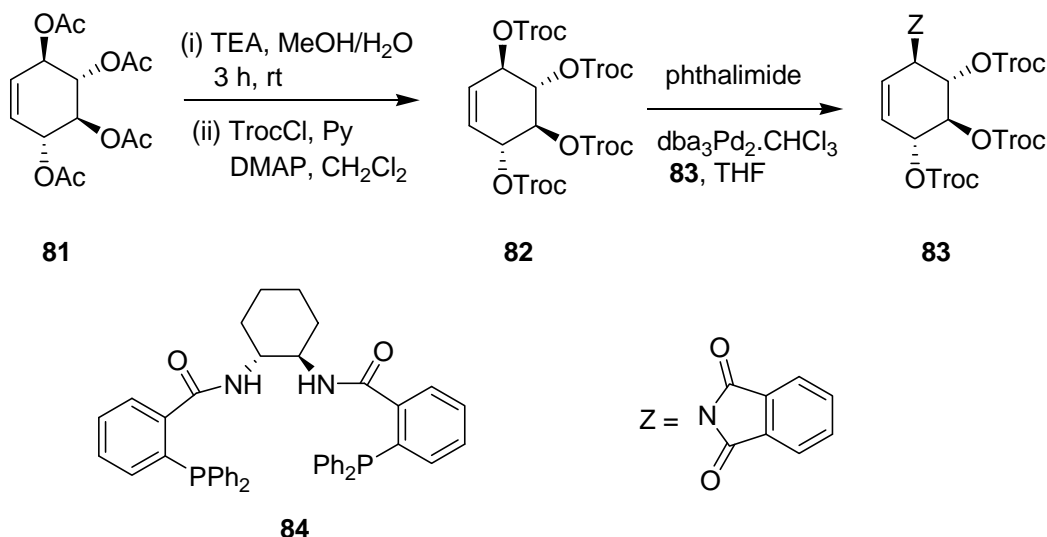
Scheme 12.

A new route to optically active protected conduramine F-1 **80** was developed by Knapp and coworkers<sup>22</sup> starting from D-glucose. The key step in this synthesis involved [3,3]-sigmatropic rearrangement of carbonimidothioate **78** derived from **77** in many steps (Scheme 13).



Scheme 13.

A protected form of enantiomerically pure (-)-conduramine B-1 was obtained through dynamic kinetic asymmetric transformation (DYKAT) of fully protected ( $\pm$ )-conduritol B by Trost and coworkers<sup>23</sup>. The racemic conduritol derivative **81** was prepared in three steps from benzoquinone. The key step involved phthalimidation in the presence of 2.5 mol % of palladium catalyst and chiral ligand **84** to give protected conduramine B-1 derivative **83** in 97% *ee* (Scheme 14).



*Scheme 14.*

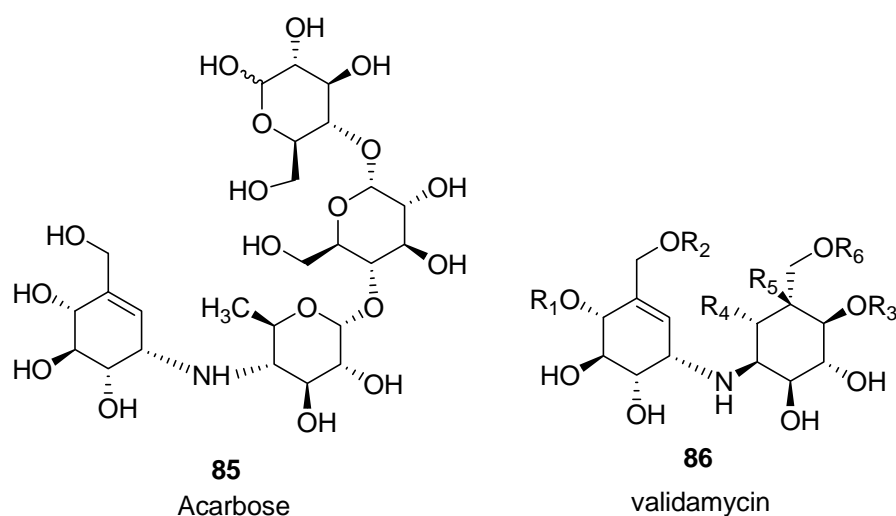
### 1.5 Conduramines related to aminocyclitols : Aminocarbasugars

Recently, a great deal of attention has been focused towards the development of glycosidase inhibitors under the premise that glycoconjugates such as oligosaccharides, glycolipids, and glycoproteins play pivotal roles in living systems. Glycosidase inhibitors possess interesting enzyme specific inhibitory activities, therefore, they are expected not only to be tools to elucidate the mechanisms of a living systems, manipulated by the glycoconjugates but also potential clinical drugs for obesity, diabetics, fungal, and viral diseases including human immunodeficiency viruses (HIV). Most of the glycosidase inhibitors are isolated from natural sources and they possess interesting structures. Some of them possess highly functionalized and oxygenated cyclohexane or cyclopentane moieties. Aminocyclitols are a group of natural products of significant relevance in medicinal chemistry as they are the structural component of a variety of

antibiotics<sup>24</sup>, glycosidase inhibitors<sup>25</sup> and other families of biologically active compounds<sup>26</sup>. From a structural point of view, aminocyclitols are cycloalkanes containing at least one free or substituted amino group and three additional hydroxyl groups on the ring. Because of their close structural relationship with sugars, aminocyclitols are also regarded as aminocarbasugars<sup>27</sup>.

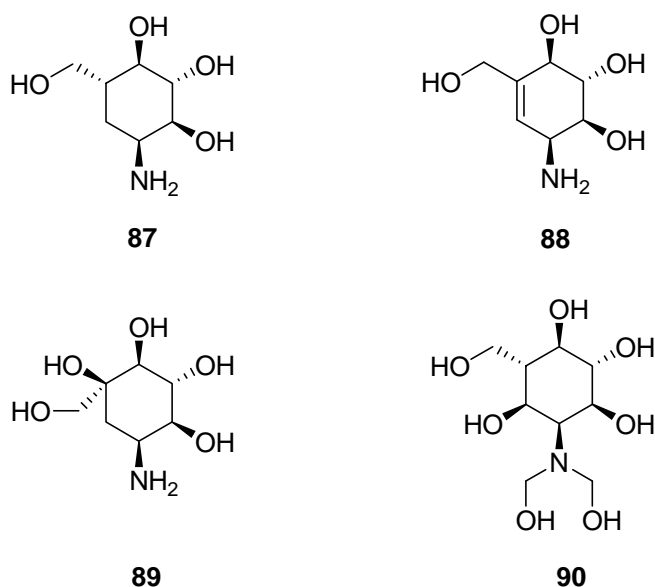
Biochemically, carbasugars and cyclitols themselves are recognized as the pseudo-sugars in a living system, and they show interesting biological activities based on the structural similarity to sugars. The most interesting and significant points for the synthesis of glycosidase inhibitors possessing cyclitols are how one can form the frameworks of the cyclitols and how can the functional groups essential to generate their specific and interesting biological activities be introduced.

Natural aminocyclitols are secondary metabolites found as structural subunits in some complex natural products, such as validamycins, a family of antibiotics isolated from the fermentation culture of *Streptomyces hygroscopicus*<sup>28</sup>. A validamycin **86** is composed of one valienamine unit, together with an additional unit of validamine, valioline or hydroxyvalidamine. The  $\alpha$ -amylase inhibitor acarbose **85** is another complex natural product containing an aminocyclitol unit valienamine linked with a trisaccharide (Figure 9).



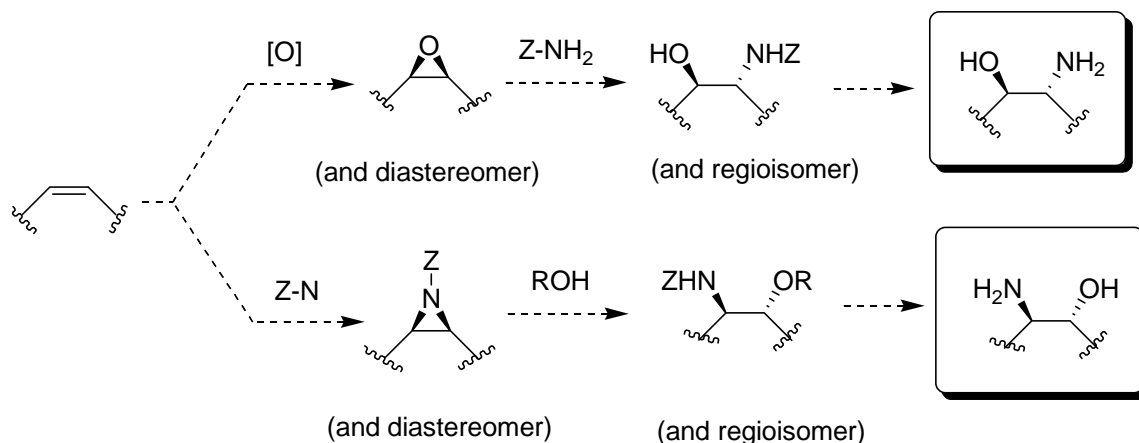
**Figure 9.** Acarbose and validamycin

The C<sub>7</sub>N aminocyclitol units<sup>29</sup> which mainly consist of validamine **87**, valienamine **88** and valioline **89**, also called as aminocarbasugars (Figure 10), has been tested as inhibitors of glycosidases enzymes besides being used as biosynthetic building blocks in many antibiotics. Owing to the protonation of their amino group at physiological pH, these aminocyclitols are believed to mimic the transition state in the enzymatic glycoside hydrolysis. In parallel, hundreds of analogs have been synthesized and their biological activities evaluated, resulting in the discovery of a number of pharmaceutical leads, including a current clinically used potent anti-diabetic drug, voglibose (AO-128)<sup>30</sup> **90**.



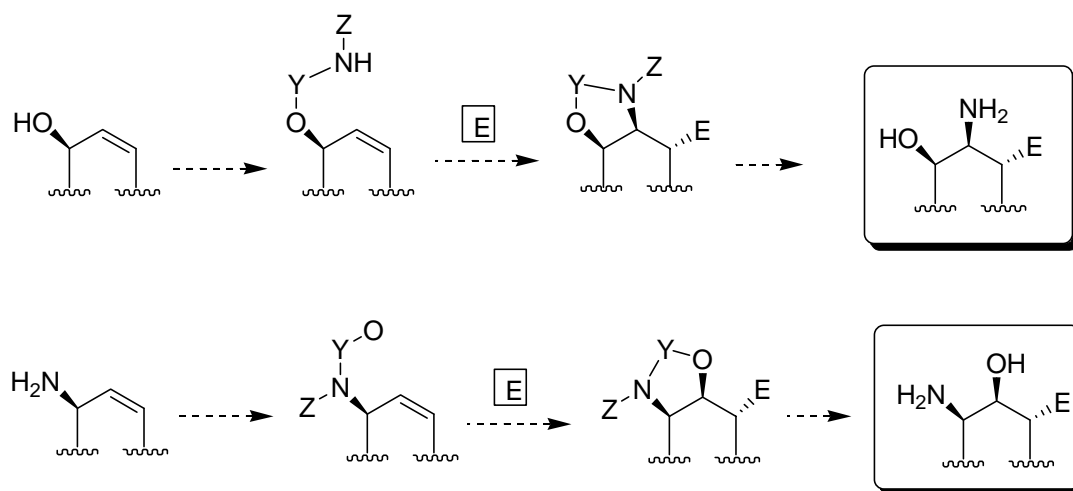
*Figure 10.*

A characteristic functionality identified in these aminocyclitols is the vicinal amino alcohol moiety. Introduction of *trans*-vicinal amino alcohol functionality is relatively straightforward which requires ring opening of epoxide by a nitrogen nucleophile or ring opening of an aziridine by an oxygen nucleophile as shown in Scheme 15.



**Scheme 15.** Synthesis of *trans* vicinal amino alcohol by attack of external nucleophile

However, introduction of *cis* functionality is considered to be more complicated. Two possibilities in this context employed are- displacement of *trans*-difunctional precursor or *syn*-addition of nitrogen and oxygen atoms, however, site and face differentiation remains the matter of concern in this approach as shown in Scheme 16.



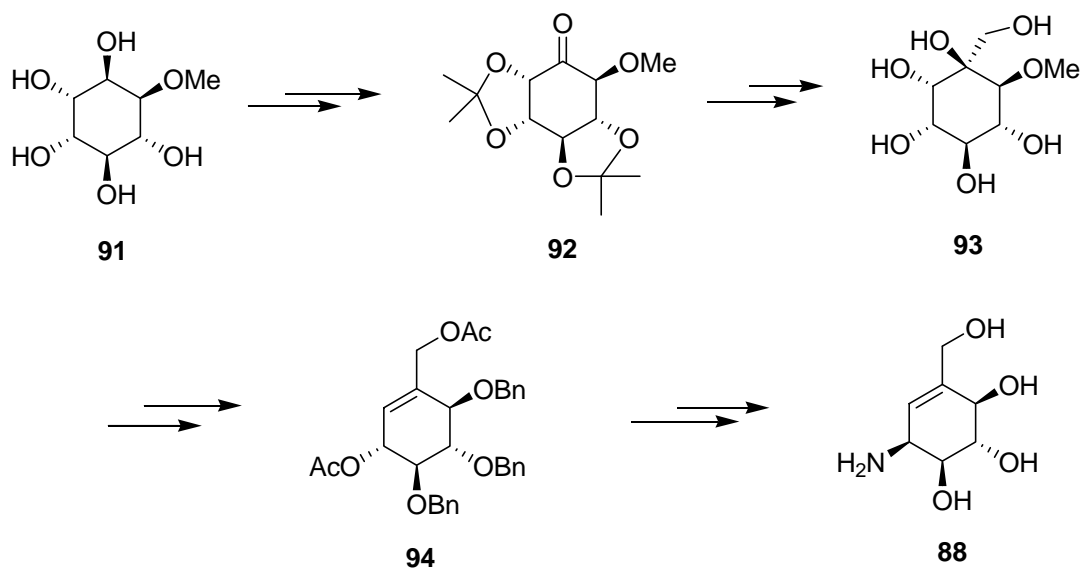
**Scheme 16.** Synthesis of *cis* vicinal amino alcohols by a tethered internal nucleophile

## 1.6 Synthetic approaches for aminocarbasugars

### 1.6.1 Approaches for valienamine.

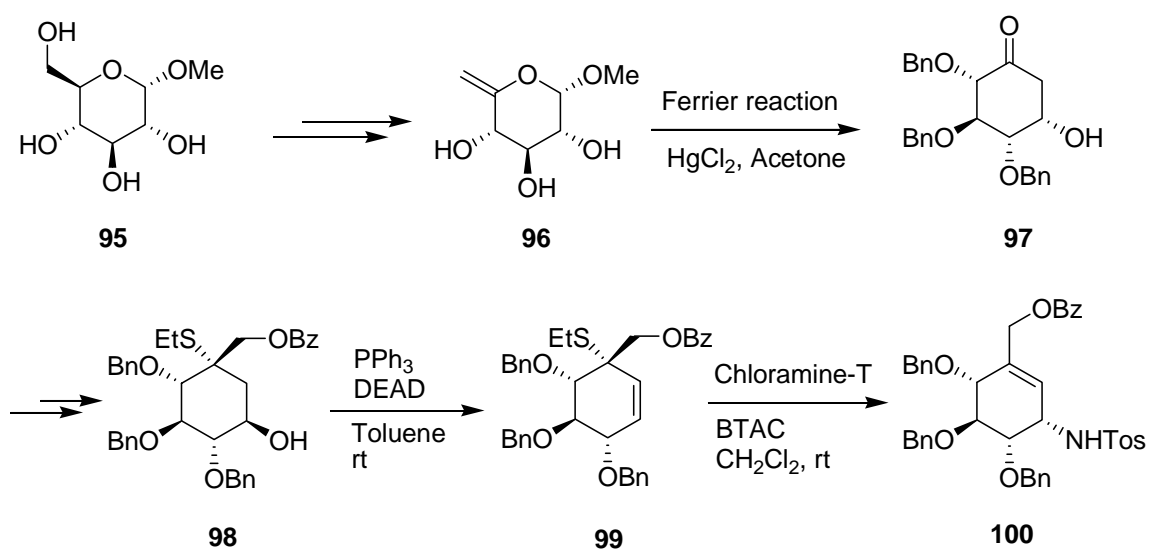
The first enantiospecific synthesis of **88** was reported<sup>31</sup> by Paulsen and Heiker in 1980, using quebrachitol (2-O-methyl-L-chiroinositol) **91** as the chiral starting material (Scheme 17).





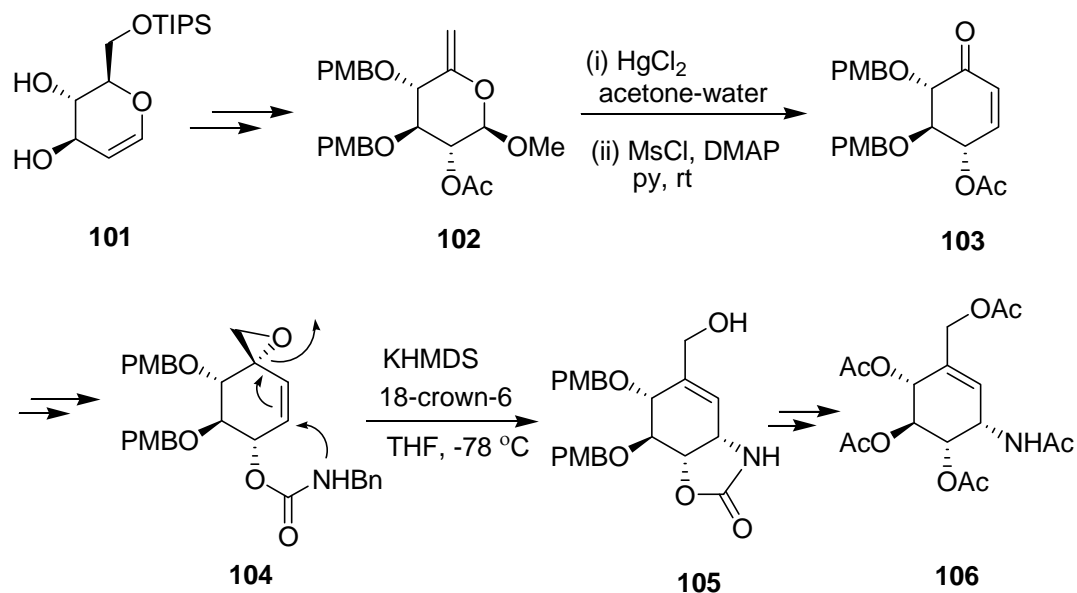
Scheme 17.

Schmidt and Kohn first reported<sup>32</sup> the synthesis of valienamine, starting from methyl- $\alpha$ -D-glucopyranoside **95** which was transformed to **96** by mesylation of primary alcohol followed by elimination. The Ferrier reaction proceeded smoothly with benzylated sugar **96** to give cyclohexane derivative **97**. The key step in this synthesis was diastereospecific allylic amination of an alkoxy substituted cyclohexene **99** via [2,3]-sigmatropic shift of sulfimide group which produced valienamine derivative **100** in good yield (Scheme 18).



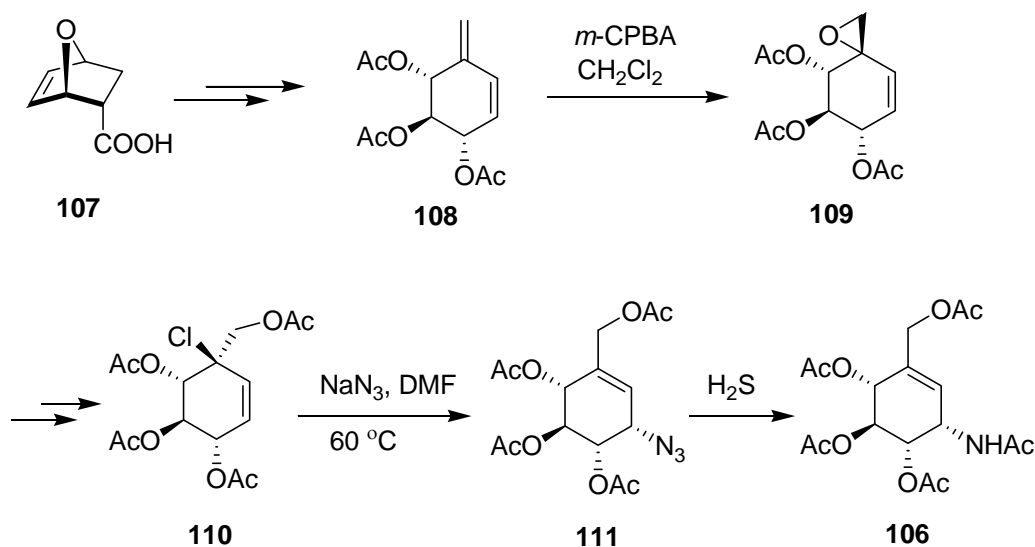
Scheme 18.

Danishefsky and Park<sup>33</sup> elegantly applied an intramolecular allylic displacement of the spiro-epoxide **104**, derived from a Ferrier rearrangement product **103** of readily available TIPS-glucal **101** to generate protected (+)-valienamine **106** (Scheme 19).



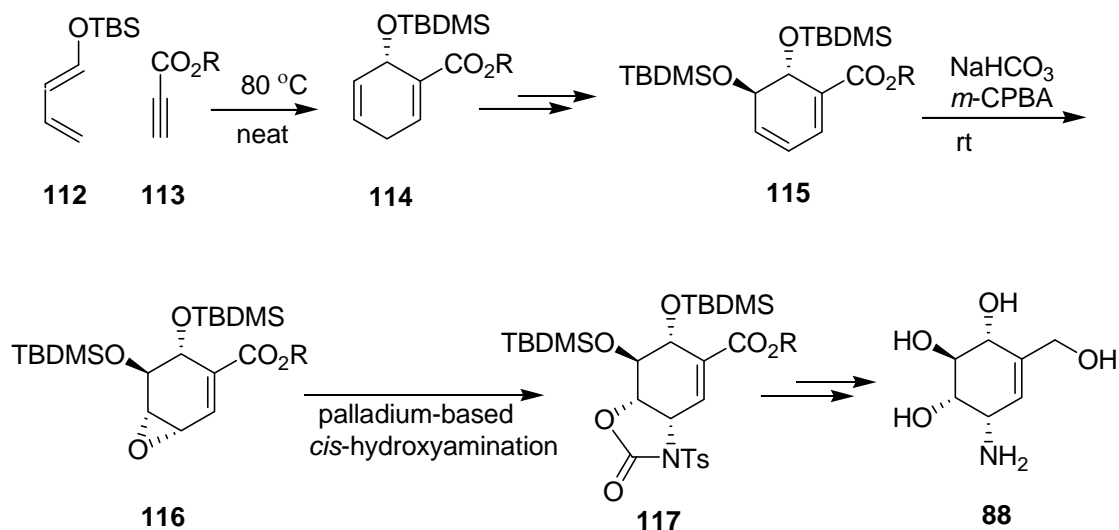
Scheme 19.

Ogawa et al.<sup>34</sup> used optically active cyclohexadiene **108**, derived from the Diels-Alder adduct **107** of furan with acrylic acid to synthesize (+)-valienamine, which was isolated as its pentaacetyl derivative **106**. This approach was also applied earlier in various syntheses of racemic valienamine and its analogues (Scheme 20).



Scheme 20.

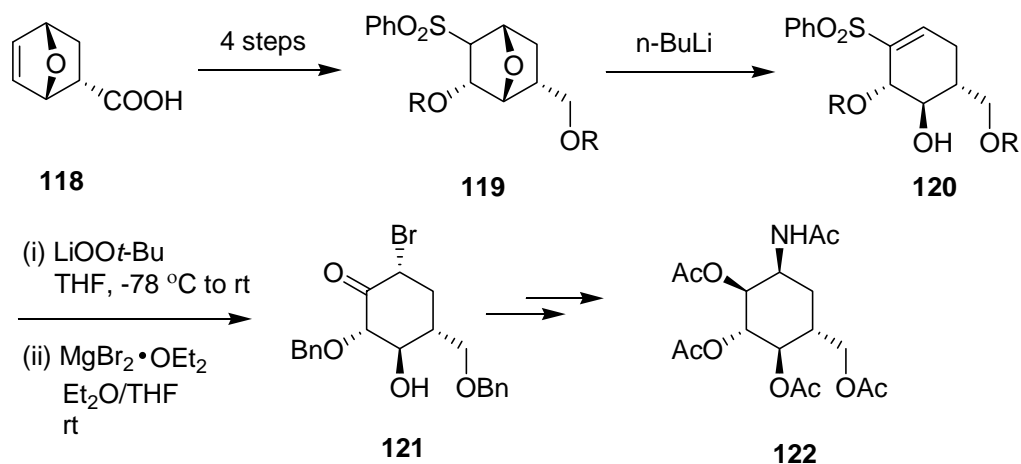
Trost and coworkers<sup>35</sup> introduced a new protocol for the synthesis of racemic valienamine **88** using palladium-based *cis*-hydroxyamination of epoxide **116**. Although, the racemic **88** was obtained in 7 steps, the asymmetric version employing chiral auxiliary required 14 steps with only 1-2% overall yield (Scheme 21).



Scheme 21.

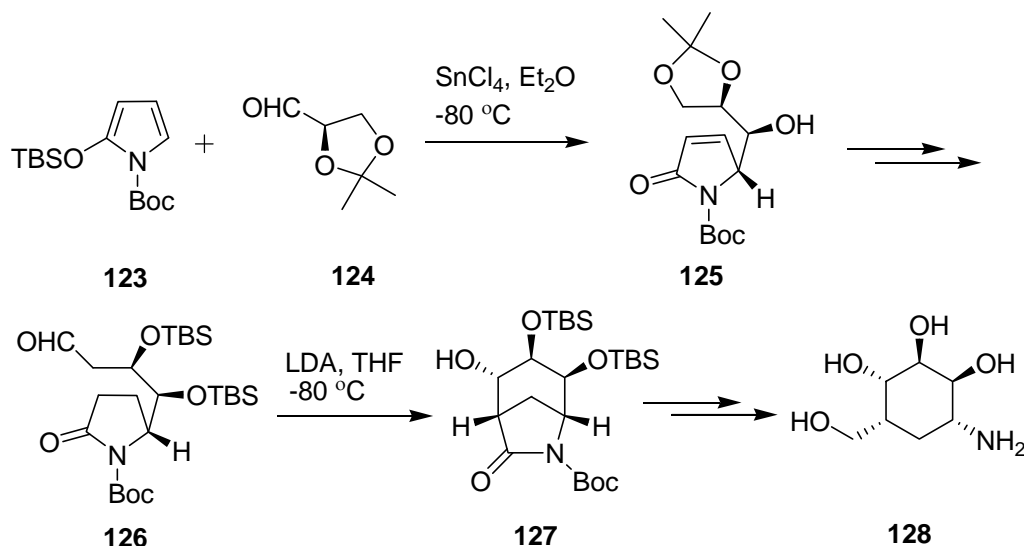
### 1.6.2 Approaches for the synthesis of validamine

The total synthesis of validamine and its three diastereomers have been accomplished as their racemic penta-O-acetates via stereocontrolled nucleophilic epoxidation of polyhydroxylated cyclohexenyl sulfone **120** obtained from (phenylsulfonyl)-7-oxabicyclo[2.2.1]heptane **119** by Acena and coworkers<sup>36</sup> (Scheme 22).



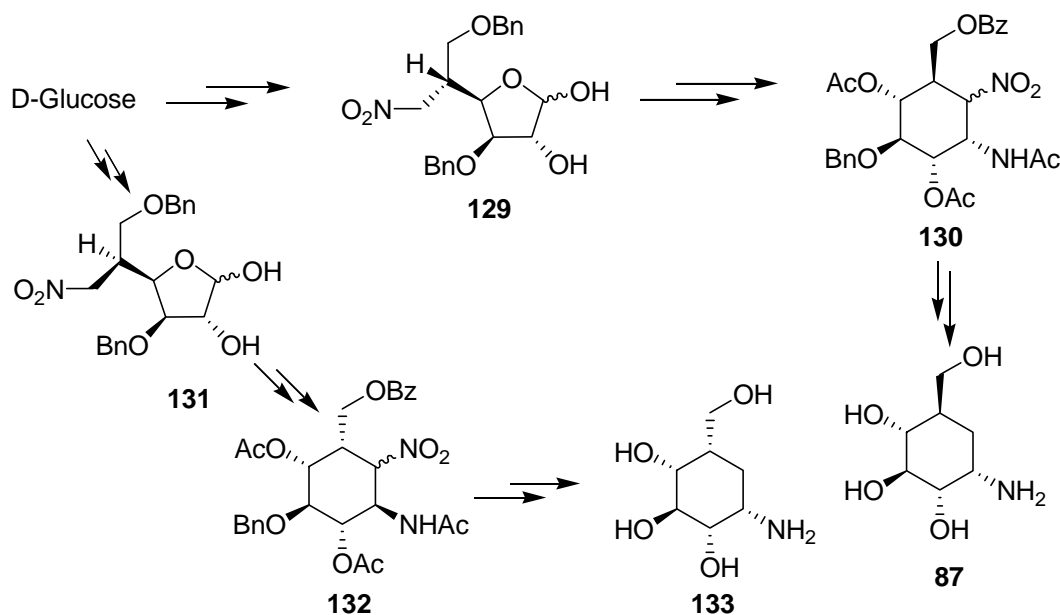
Scheme 22.

A diastereoselective synthesis of ( $\pm$ )-1-*epi*-3-*epi*-4-*epi*-validamine **128** was reported by Rassu's group<sup>37</sup> from *N*-*tert*-butoxy-carbonyl-2-[(*tert*-butyldimethylsilyl)oxyl]pyrrole **123** and 2,3-O-isopropylidene-D-glyceraldehyde **124** via a short [3+3] cycloaddition reaction involving sequential vinylogous cross aldolization-intramolecular aldolization sequence (Scheme 23).



Scheme 23.

Kitagawa et al.<sup>38</sup> employed D-glucose derived nitrofuranose derivatives **129** and **131** which were prepared via a Michael-type addition reaction, to synthesize optically active validamine **87** and 5-*epi*-validamine **133** (Scheme 24).

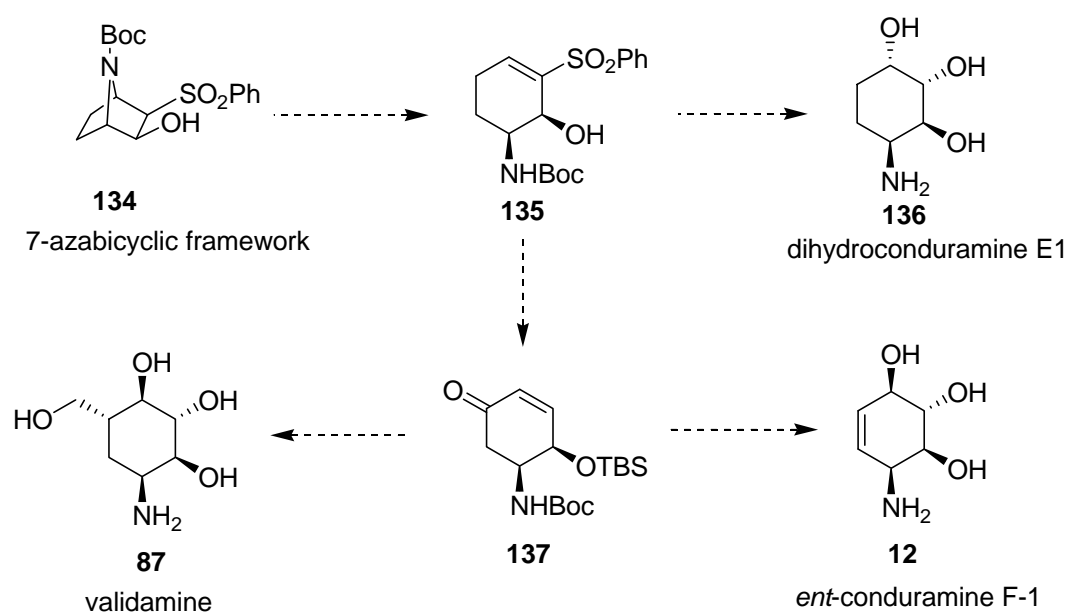


Scheme 24.

### 1.7 Aim of the dissertation

Aminocyclitols concerns with a large group of natural products which are of great importance due to their known and potential biological activities as well as their synthetic usefulness in the synthesis of natural and synthetic compounds. Therefore, to develop new and efficient protocols leading to aminocyclitols and their derivatives is a growing field of interest. As evident from the literature, a significant drawback of many of the known approaches for the synthesis of aminocyclitols arises from lengthy protecting group manipulation. Furthermore, the stereoselective installation of chiral functionality around the periphery of cyclohexane ring also offers opportunity for synthetic chemist to design and develop conceptually new and efficient approach for their syntheses.

While working on the enantiopure 7-azabicyclic systems *en route* to synthesize epibatidine<sup>39</sup>, we visualized that these structures could be utilized as valuable precursors for the synthesis of aminocyclitols (Scheme 25) because there would be predictable control over the functional group transformation due to rigid bicyclic structure.



Scheme 25.

We took up this synthetic challenge considering the unexplored synthetic utility of 7-azabicyclic frameworks for the synthesis of aminocyclitols. The following research accomplishments during this endeavor have been discussed in detail in the forthcoming chapters.

- Enantioselective synthesis of 3-phenylsulfonyl-7-azabicyclo[2.2.1]hept-2-one
- Anionic rearrangement of 7-azabicyclo[2.2.1]heptan-2-ol leading to the generation of enantiopure substituted cyclohexene derivatives
- Enantioselective synthesis of 2-aminocyclohexanols
- Enantioselective synthesis of dihydroconduramine E-1
- Enantioselective synthesis of conduramines and carbasugars

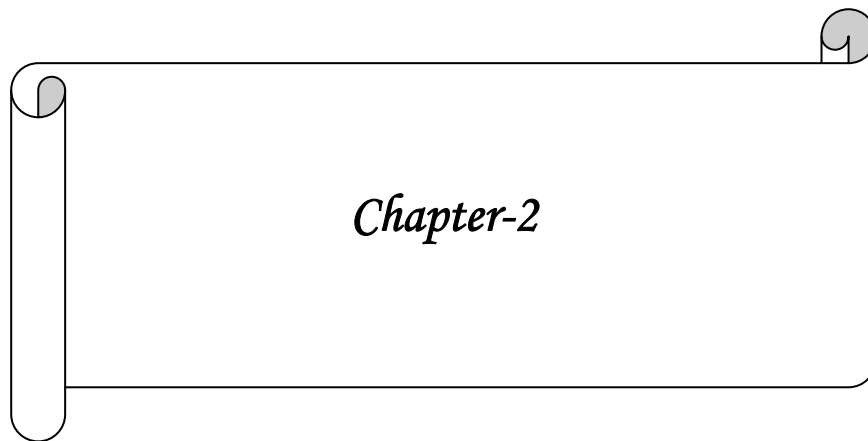
### 1.8 References

1. (a) Posternack, T. *The Cyclitols*, Holden-Day Inc: San Fransisco, **1965**; pp 211- 212. (b) Balci, M.; Sutbeyaz, Y.; Sacen, H. *Tetrahedron* **1990**, *46*, 3715.
2. McIntosh, M. C.; Weinreb, S. M. *J. Org. Chem.* **1993**, *58*, 4823 and references cited therein.
3. Lysek, R.; Schutz, C.; Vogel, P. *Bioorg. Med. Chem. Lett.* **2005**, *15*, 3071.
4. Lysek, R.; Favre, S.; Vogel, P. *Tetrahedron* **2007**, *63*, 6558.
5. (a) Gorter, K. *Bull. Jard. Bot.* **1920**, *1*, 352 (CAN: 14: 3699).  
(b) Gorter, K. *Chem. Zent.* **1920**, 846.
6. Fitzgerald, R.; Hartwell, J. L.; Leiter, J. J. *Nat. Cancer Inst.* **1958**, *20*, 763.
7. Pettit, G. R.; Freeman, S.; Simpson, M. J.; Thompson, M. A.; Boyd, M. R.; Williams, M. D.; Pettit, G. R., III; Doubek, D. L. *Anti-Cancer Drug Des.* **1999**, *40*, 3081.
8. Gabrielsen, B.; Monath, T. P.; Huggins, J. W.; Kefauver, D. F.; Pettit, G. R.; Groszek, G.; Holingshead, M.; Kirsi, J. J.; Shanon, W. M.; Schubert, E. M.; Dare, J.; Ugarkar, B.; Ussery, M. A.; Phelan, M. J. *J. Nat. Prod.* **1992**, *55*, 1569.
9. Trost, B. M.; Pulley, S. R. *J. Am. Chem. Soc.* **1995**, *117*, 10143.
10. Tian, X.; Hudlicky, T.; Konigsberger, K. J. *J. Am. Chem. Soc.* **1995**, *117*, 3643.
11. Chida, N.; Ohtsuka, M.; Ogawa, S. *Tetrahedron Lett.* **1991**, *32*, 4525.
12. Hudlicky, T.; Olivo, H. F. *J. Am. Chem. Soc.* **1992**, *114*, 9694.
13. (a) Look, G. C.; Fotsch, C. H.; Wong, C.-H. *Acc. Chem. Res.* **1993**, *26*, 182.  
(b) Nishimura, Y. "Glycosidase and Glycotransferase Inhibitors" in studies in Natural Products Chemistry, Atta-ur-Rahman, Ed.; Elsevier: Amsterdam **1992**, vol. 10, p. 495; (c) Winchester, B.; Fleet, G. W. J. *Glycobiology* **1992**, *48*, 199.
14. Johnson, C. R.; Golebiowski, A.; Sundram, H.; Miller, M. W.; Dwaihy, R. L. *Tetrahedron Lett.* **1995**, *36*, 653.

15. Hudlicky, T.; Rouden, J.; Luna, H. *J. Org. Chem.* **1993**, *58*, 985.
16. Hokomori, S.; *Handbook of lipid research*, Vol. 3, *Sphingolipid Biochemistry*; Kanfer, J. N., Hakamori, S., Eds; Plenum Press: New York, 1983; p. 1.
17. Hudlicky, T.; Nugent, T.; Griffith, W. *J. Org. Chem.* **1994**, *59*, 7944.
18. Lysek, R.; Schutz, C.; Favre, S.; O'Sullivan, A. C.; Pillonel, C.; Krulle, T.; Jung, P. M. J.; Clotet-Codina, I.; Este, J. A.; Vogel, P. *Bioorg. Chem. Med.* **2006**, *14*, 6255.
19. Lysek, R.; Schutz, C.; Vogel, P. *Helv. Chim. Acta.* **2005**, *88*, 2788.
20. Angelaud, R.; Babot, O.; Charvat, T.; Landais, Y. *J. Org. Chem.* **1999**, *64*, 9613.
21. Hudlicky, T.; Akgun, H. *Tetrahedron Lett.* **1999**, *40*, 3081.
22. Knapp, S.; Naughton, A. B. J.; Murali Dhar, T. G. *Tetrahedron Lett.* **1992**, *33*, 1025.
23. Trost, B. M.; Patterson, D. E.; Hembre, E. J. *J. Am. Chem. Soc.* **1999**, *121*, 10834.
24. Ferrier, R. J.; Blattner, R.; Clinch, K.; Furneaux, R. H.; Gardiner, J. M.; Tyler, P. C.; Wightman, R. H.; Williams, N. R. *Carbohydr. Chem.* **1996**, *28*, 251.
25. el Ashry, E. S.; Rashed, N.; Shobier, A. H. *Pharmazie* **2000**, *55*, 403.
26. Chapleur, Y. *Carbohydrate Mimics – Concepts and Methods*, Wiley-VCH, Weinheim, **1998**.
27. Arjona, O.; Gomez, A. M.; Lopez, J. C.; Plummet, J. *Chem. Rev.* **2007**, *107*, 1919.
28. Chen, X.; Fan, Y.; Zheng, Y.; Shen, Y. *Chem. Rev.* **2003**, *103*, 1955.
29. Mahmud, T. *Nat. Pro. Rep.* **2003**, *20*, 137.
30. Fukase, H. *Yuki Gosei Kagaku Kyokaishi*, **1997**, *55*, 920.
31. Paulsen, H.; Heiker, H. R. *Angew. Chem. Int. Ed.*, **1980**, *19*, 904.
32. Schmidt, R. R.; Kohn, A. *Angew. Chem. Int. Ed.*, **1987**, *26*, 482.
33. Park, T. K.; Danishefski, S. J. *Tetrahedron Lett.* **1994**, *35*, 2667.
34. Ogawa, S.; Shibata, Y.; Nose, T.; Suami, T. *Bull. Chem. Soc. Jpn.* **1985**, *58*,



- 3387.
35. Trost, B. M.; Chupak, L. S.; Lubbers, T. *J. Am. Chem. Soc.* **1998**, *120*, 1732.
36. Acena, J. L.; Arjona, O.; de la Pradilla, R. F.; Plumet, J.; Viso, A. *J. Org. Chem.* **1994**, *59*, 6419.
37. Rassa, G.; Auzzas, L.; Pinna, L.; Zanardi, F.; Battistini, L.; Casiraghi, G. *Org. Lett.* **1999**, *1*, 1213.
38. Yoshikawa, M.; Cha, B. C.; Okaichi, Y.; Takinami, Y.; Yokokawa, Y.; Kitagawa, I. *Chem. Pharm. Bull.*, **1988**, *36*, 4236.
39. Spand, T. F.; Garraffo, H. M.; Edwards, M. W.; Daly, J. W. *J. Am. Chem. Soc.* **1992**, *114*, 3475.



*Chapter-2*

## Section A

**“Enantioselective synthesis of 3-(phenylsulfonyl)-7-azabicyclo[2.2.1]hept-2-one”****2.1 Importance of 7-azabicyclo[2.2.1]heptane framework**

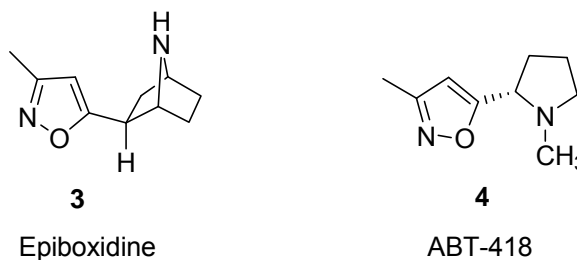
The synthesis of the 7-azabicyclo[2.2.1]heptane system (**1**) has been the subject of numerous synthetic studies which have resulted in the development of several methods for the construction of these novel structures. For sometimes, the interest in the synthesis of these systems were only a matter of academic interest since no naturally occurring compound was known at that time to contain these ring systems. However, in 1992 Daly et al.<sup>1</sup> reported the discovery and structural elucidation of (-)-epibatidine (**2**), a new alkaloid isolated from Ecuadorian poison frog, *Epipedobates tricolor*. Subsequent studies showed that this structurally unique natural product features the 7-azabicyclo[2.2.1]heptane ring system with an *exo* oriented 5-(2-chloropyridyl) substituent (Figure 1). Due to the novel biological activity associated with epibatidine and its paucity in nature (1 mg isolated from 750 frogs), the total synthesis of compound had aroused the interest of organic chemist around the world.

**Figure 1.**

The extraordinary pharmacology<sup>2</sup> of epibatidine had indicated the potential for nicotinic acetylcholine receptor (nAChR) ligands to serve as a new therapeutic class of host of CNS disorders. Many of such ligands are natural products, or analogues thereof, which represent a significant challenge to the synthetic chemist.

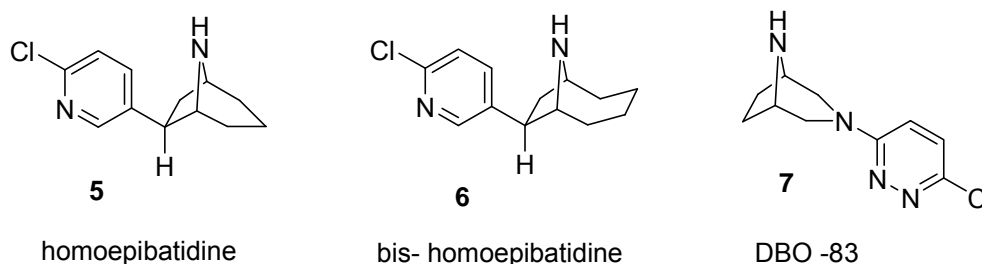
The chance of epibatidine ever being used as a medicinal agent became quite low because of its high toxicity. However, in order to cope up with toxicity, several analogues of epibatidine have been designed and synthesized by altering the side

chain as well as bicyclic skeleton. One of the interesting analogue is epiboxidine<sup>3</sup> (**3**), a hybrid of epibatidine and ABT-418 (**4**) which is an isosteric analogue of nicotine, where chloropyridine ring has been replaced by methylisoxazole (Figure 2). Although not as potent as epibatidine, epiboxidine (**3**) has higher affinity than nicotine and has been found 20 fold less toxic than epibatidine.



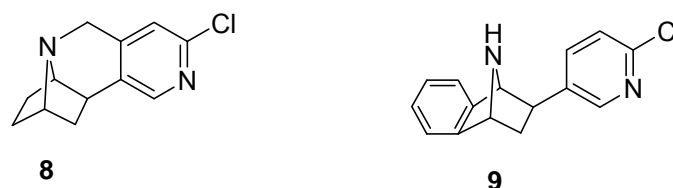
*Figure 2.*

One class of the epibatidine analogue in which the the azabicycloheptane ring is altered, has been synthesized and tested, includes homoepibatidine (**5**), *bis* homoepibatidine<sup>4</sup> (**6**) and diazabicyclopyrazine DBO-83<sup>5</sup> (**7**) (Figure 3).



*Figure 3.*

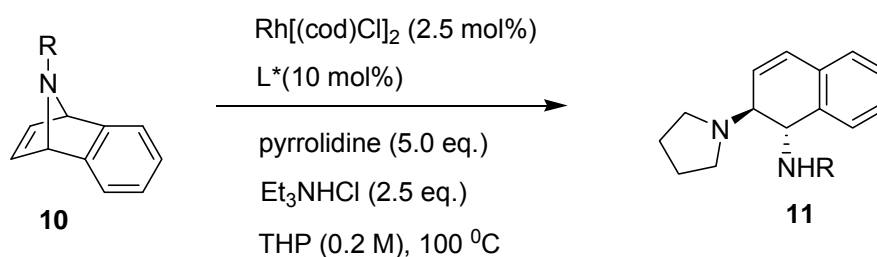
In search for better selectivity, conformationally restricted analogue (**8**) as well as fused analogue (**9**) has also been synthesized<sup>6</sup> and screened (Figure 4). Although, these analogues show low affinity and do not encompass the ideal conformation for the high affinity, they provide valuable information concerning the pharmacophore studies.



*Figure 4.*

Despite significant progress in the research dealing with the chemistry of 7-azabicyclo[2.2.1]heptane ring system, most of these novel structures have been used in synthesis of epibatidine and its analogues.

Considering azabicyclic systems as a valuable precursor for substituted cyclohexene derivatives, Lauten's<sup>7</sup> group has discovered rhodium catalysed asymmetric ring opening of azabicyclic alkene (**10**) to have efficient access of cyclohexyl 1,2-diamine (**11**) (Scheme 1). Treatment of 7-azabenzonorbornadiene with an amine as a nucleophile in the presence of rhodium catalyst having chiral ferrocenyl phosphine ligand (**12**), gave 1,2-diamino compound **11** in high yield and excellent selectivity (Table 1).

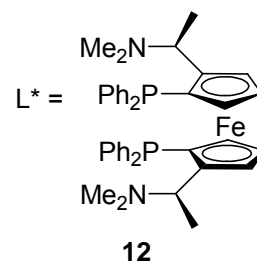


**Scheme 1.**

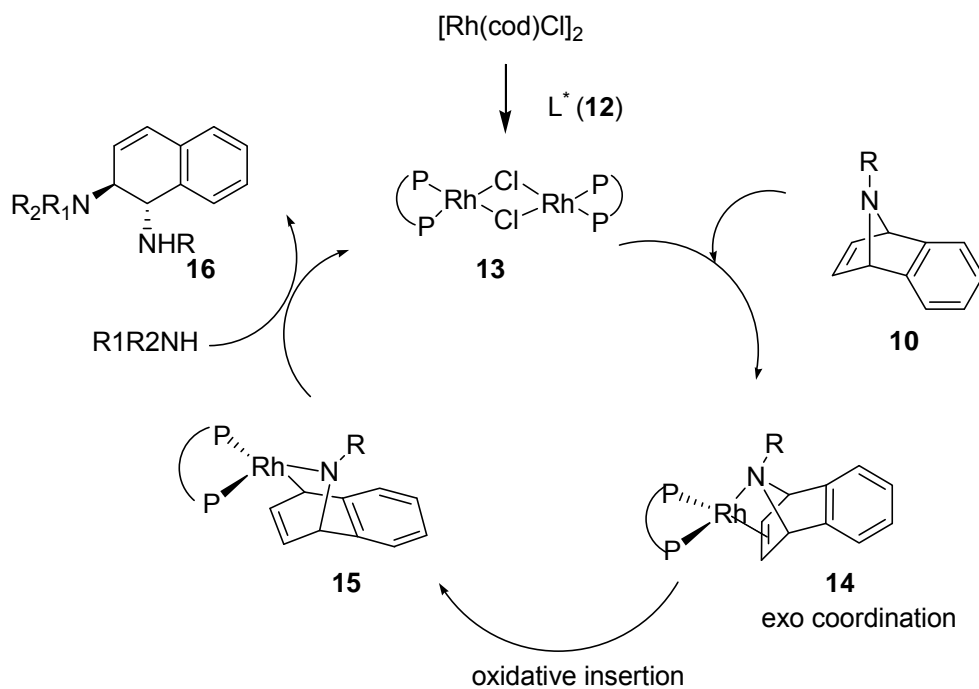
The proposed catalytic pathway begins with the generation of chiral Rhodium complex (**13**), its *exo*- binding between nitrogen and the olefin of azanorbornadiene to give the intermediate **14**. The oxidative insertion of Rh-catalyst to C-N bond followed by  $\text{S}_{\text{N}}2'$  displacement of rhodium catalyst by an amine nucleophile produced **16** and regenerated the catalyst back (Scheme 2).

**Table 1.**

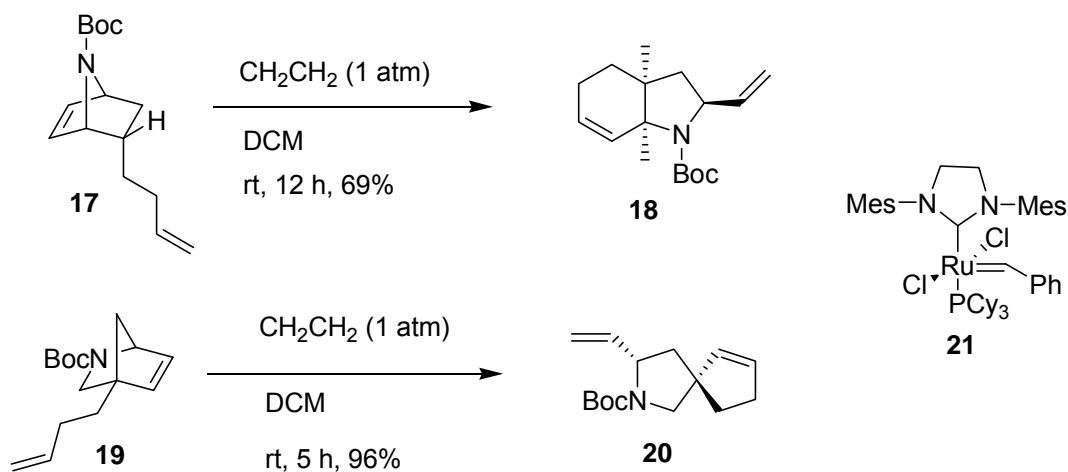
entry	azabicyclic (R)	time (h)	yield (%)	ee(%)
1	$\text{CO}_2\text{t-Bu}$	24	77	86
2	$\text{CO}_2\text{Me}$	24	65	63
3	$\text{CO}_2\text{CH}_2\text{Ph}$	24	73	68
4	$\text{C}(\text{O})\text{Ph}$	24	71	96



(S,S)-(R,R)-C<sub>2</sub>-Ferriphos

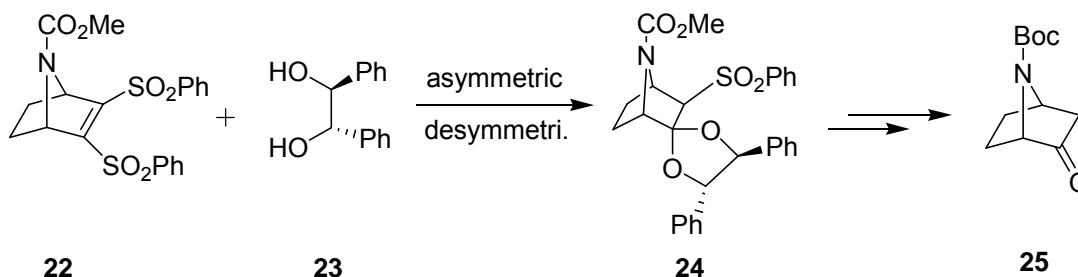


Similarly, Ranier's<sup>8</sup> group has demonstrated that 7-azanorbornene can be used as an effective substrate for the ring opening cross metathesis (ROCM) with olefins to yield perhydroindolines. For example, the ROCM reaction of 7-azanorbornene (**17**) and 2-azanorbornene (**19**) using Grubb's second generation catalyst (**21**) at room temperature under an ethylene atmosphere, produced indolines (**18**) and *spiro*-fused pyrrolidines (**20**) respectively, in good yields (Scheme 3).



Visualising the importance of 7-azabicyclo[2.2.1]heptane skeleton, a large number of synthetic approaches<sup>9</sup> have been described for these kind of frameworks. Due to our

continuous research efforts directed towards the development of novel methodologies<sup>10</sup> for the construction of enantiopure 7-azabicyclo[2.2.1]heptane skeleton, we had developed a short and efficient route for the synthesis of (+)-*N*-Boc-7-azabicyclo[2.2.1]hept-2-one **25**, a versatile precursor for the epibatidine by asymmetric desymmetrization approach<sup>11</sup> (Scheme 4).



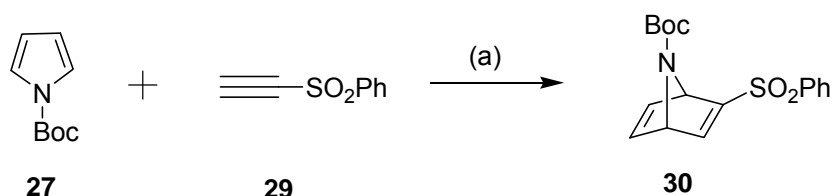
Scheme 4.

However, during the optimization of reaction conditions, we observed that the protection of *N*-pyrrole as *t*-butyl carbamate was found to be better than the methyl carbamate. Therefore, we revised the starting precursor by changing the protective group of pyrrole.

## 2.2 Results and Discussion

### 2.2.1 Preparation of *tert*-butyl 2-(phenylsulfonyl)-7-azabicyclo[2.2.1]hepta-2,5-diene-7-carboxylate (**30**)

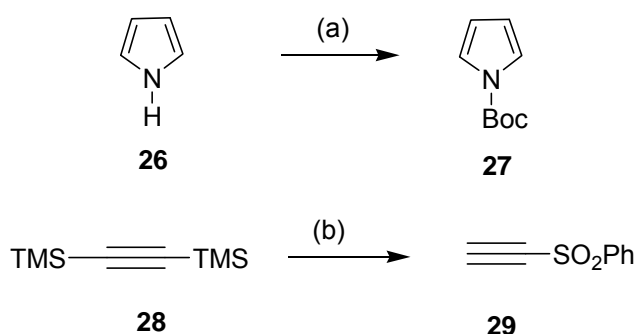
Towards the synthetic goal, cycloadduct **30** was prepared in 73% yield as a crystalline solid by heating (90 °C) a mixture of ethynyl phenyl sulfone **29** as a dienophile and *N*-*tert*-butoxy pyrrole carbamate **27** as a diene without any solvent (Scheme 5).



Scheme 5.

Reagent and Condition : (a) neat, 90 °C, 30 h, 70%

The dienophile **29** was prepared in one step (65% yield) from bis(trimethylsilyl)acetylene<sup>12</sup> **28** by reacting with benzene sulfonyl chloride in the presence of anhydrous aluminium chloride in anhydrous dichloromethane (Scheme 6). Since *N*-pyrrole **26** is always considered as a poor diene for Diels-Alder cycloaddition reaction, therefore, it was activated by protection with alkoxy carbonyl group by reacting pyrrole **26** with (Boc)<sub>2</sub>O in the presence of catalytic DMAP in acetonitrile which yielded *N*-*t*-butoxy pyrrole carbamate **27** in quantitative yield (Scheme 6).



**Scheme 6.**

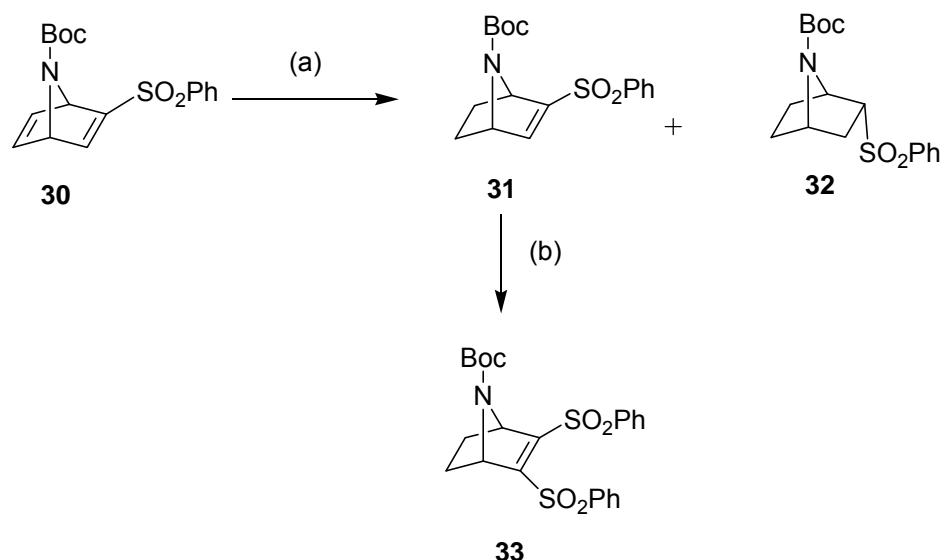
*Reagents and Conditions* : (a) (Boc)<sub>2</sub>, DMAP, CH<sub>3</sub>CN, 98% (b) AlCl<sub>3</sub>, PhSO<sub>2</sub>Cl, DCM, 24 h, 65%

The <sup>1</sup>H NMR spectrum of **30** displayed a multiplet between δ 7.89-7.85 integrating for two aromatic protons and a multiplet between δ 7.69- 7.52, for the remaining three aromatic protons and one olefinic proton. A multiplet between δ 6.94-6.86 integrating for two protons was assigned for the remaining two olefinic protons. A broad singlet at δ 5.38, integrating for one proton, was attributed to the bridgehead proton. The other bridgehead proton appeared at δ 5.17 as a singlet. The molecular ion peak was found at 334 (M<sup>+</sup>+H) in the mass spectrum of **30**.

### 2.2.2 Preparation of *meso*-*tert*-butyl 2,3-bis(phenylsulfonyl)-7-azabicyclo[2.2.1]hept-2-ene-7-carboxylate (**33**)

The *meso*-precursor **33** required for desymmetrization was prepared in two steps by chemoselective hydrogenation of electron rich olefin of **30**, followed by the introduction of the second –SO<sub>2</sub>Ph group onto **31** via β-metallation (Scheme 7).





**Scheme 7.**

*Reagents and Conditions* : (a) H<sub>2</sub> (1 atm.), Pd/C (10 %), CH<sub>3</sub>CN, 6 h, 98% (b) *n*-BuLi, THF, PhSO<sub>2</sub>F, -78 °C to rt, 80%

Our initial attempts of catalytic hydrogenation of **30**, using 10 mol% Pd/C as a catalyst provided an inseparable mixture of **31** and **32** within 1 h of hydrogenation. Even the use of 5 mol% of Pd/C also did not help to solve this problem. Later, our statistical study gave an unexpected observation that the slow stirring rate was helpful to control the rate of reduction of the olefinic moiety of **30**. Thus, the chemoselective reduction of electron rich olefin of **30** was achieved by using slow stirring of a dilute solution (1.0 g, 25 mL CH<sub>3</sub>CN) under atmospheric pressure of hydrogen in the presence of 10 mol% Pd/C. The reaction was completed in 6 h giving rise to single product **31** in 98 % yield (Scheme 7).

In the <sup>1</sup>H NMR spectrum of compound **31**, two aromatic protons appeared as a multiplet between δ 7.94-7.90 and the remaining three appeared between δ 7.65- 7.52 as a multiplet. A doublet at δ 7.10 (d, *J* = 2.1 Hz), integrating for one proton, was assigned to the olefinic proton. The bridgehead proton appeared as a broad singlet at δ 4.83 while the other bridgehead proton appeared as a doublet at δ 4.76 (d, *J* = 3.4 Hz, 1H). A multiplet appearing between δ 2.10-1.92 was assigned as two methylene

protons. Another multiplet at  $\delta$  1.47-1.26, also integrating for two protons, was assignable to another methylene protons. The mass spectrum of compound **31** showed molecular ion peak at 336 ( $M^+H$ ).

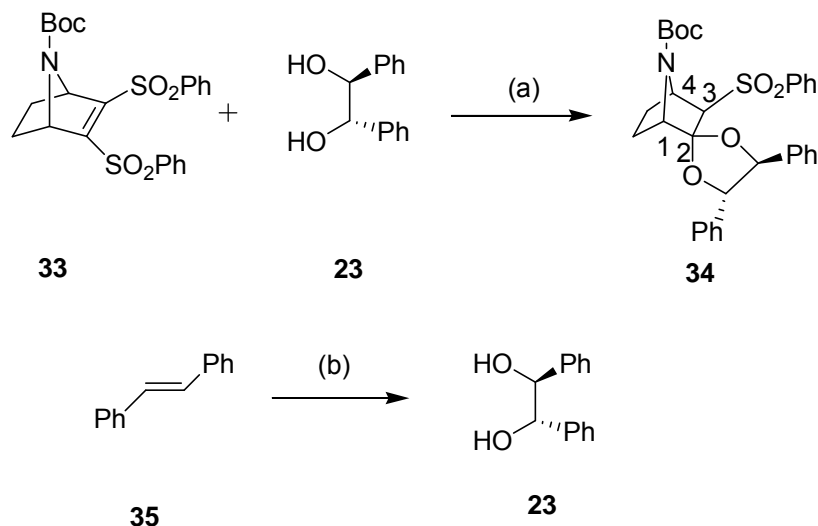
In order to convert **31** into **33** via  $\beta$ -metallation, the solution of **31** in anhydrous THF at  $-78$  °C was treated with *n*-BuLi followed by addition of PhSO<sub>2</sub>F at the same temperature. After warming the reaction mixture to room temperature and quenching with saturated NH<sub>4</sub>Cl solution followed by usual work-up and purification afforded **33** in 80% yield (Scheme 7).

In the <sup>1</sup>H NMR spectrum of **33** in DMSO-d<sub>6</sub>, four aromatic protons appeared as a multiplet between  $\delta$  7.91-7.82 and the other six aromatic protons appeared between  $\delta$  7.80-7.55. The two bridgehead protons appeared as a singlet at  $\delta$  4.96 because of symmetrical nature. A doublet at  $\delta$  2.12 (d,  $J = 9.5$  Hz) integrating for two protons, was assigned to two *exo* protons and another doublet appearing at  $\delta$  1.24 (d,  $J = 8.0$  Hz), for two protons was assigned to *endo* protons. Mass spectrum of **33** showed molecular ion peak at 476 ( $M^+H$ ).

### 2.2.3 Preparation of (1*S*,3*R*,4*R*,4'*S*,5'*S*)-*tert*-butyl- 4',5'-diphenyl-3-(phenylsulfonyl)-7-azaspiro[bicyclo[2.2.1]heptane-2,2'-[1,3]dioxalane]-7-carboxylate (**34**)

The asymmetric desymmetrization of **33** was carried out by stirring with an equivalent amount of the disodium salt of (-)-**23** in anhydrous THF at 0 °C for about 2.5 h (Scheme 8). The disodium salt was prepared by treating diol **23** with 60 % NaH in anhydrous THF. After allowing the reaction mixture to warm to room temperature, it was quenched by the slow addition of methanol. Usual work up and silica gel column chromatographic purification of the reaction mixture provided desymmetrized product **34** as a white floppy solid in 80 % yield. The crude <sup>1</sup>H NMR spectrum of **34** displayed one singlet for H-3 proton at  $\delta$  3.65 indicating it to be a single diastereomer,

which was further confirmed by HPLC analysis [ Merck Purospher (250x 4.6 mm) CH<sub>3</sub>CN:H<sub>2</sub>O (60:40) isocratic, flow rate 1.2 mL/min, retention time 27.85 min].

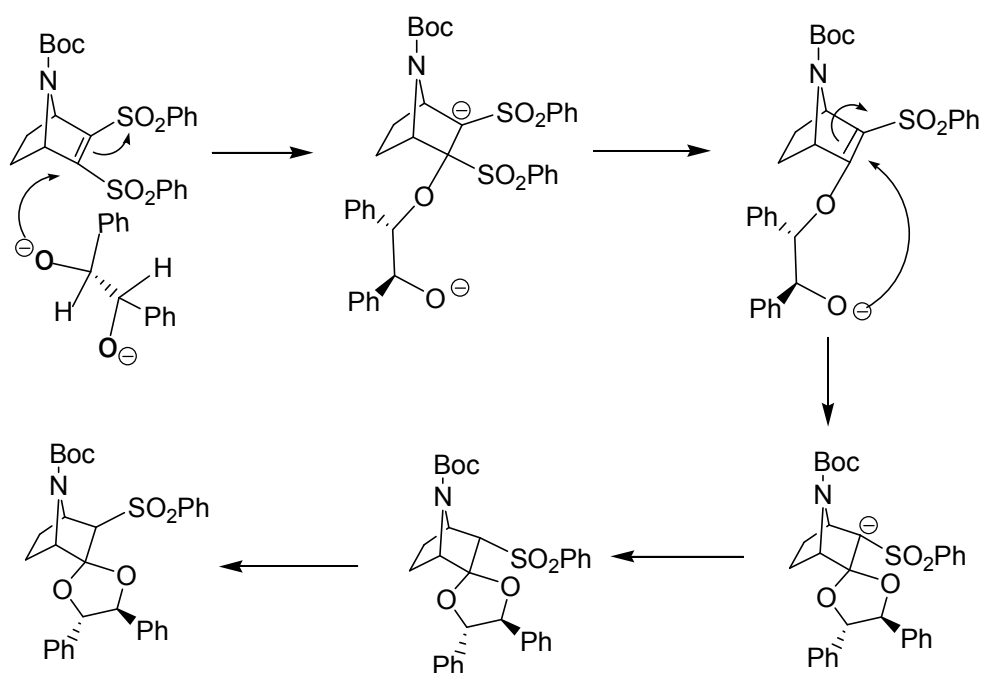


**Scheme 8.**

**Reagents and Conditions :** (a) NaH, THF, 0 °C, 3 h, 82% (b) AD Mix.- $\alpha$ , *t*-BuOH:H<sub>2</sub>O (1:1), 24 h, 0 °C, 80%.

The (-)-hydrobenzoin **23** was synthesized from *trans*-stilbene **35** in 80 % yield by following the reported procedure<sup>13</sup> as outlined in Scheme 8.

Mechanistically, the formation of product requires nucleophilic attack of alcoholate anion onto the vinylic carbon atom. The least encumbered trajectory is the one where phenyl group point upwards and alkyl to the side. The elimination of phenyl sulfinate anion generates unsaturation which is again being attacked by the second alcoholate anion to generate carbanion and finally protonation occurs according to *exo*-rule to give *endo* sulfone. However, this product seems to be a kinetic product as under basic condition it undergoes epimerization to give exclusively *exo* sulfone as a single diastereomer (Figure 5 ).

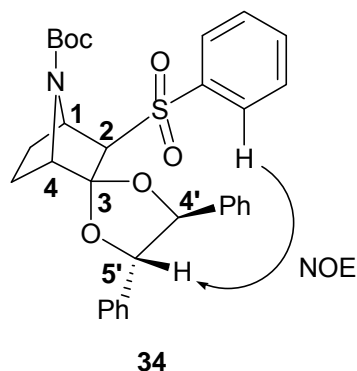


**Figure 5.**

<sup>1</sup>H NMR spectrum of **34** displayed a multiplet between  $\delta$  8.00-7.96, attributable to the two aromatic ortho protons of the phenylsulfonyl group. The multiplets appearing between  $\delta$  7.59-7.11, integrating for thirteen protons, were assigned for the remaining aromatic protons. A doublet at  $\delta$  5.28 (d,  $J = 8.8$  Hz) integrating for one proton, may be assigned to either one of the benzylic protons. The singlet observed at  $\delta$  4.69, integrating for one proton, was assignable to bridgehead proton. Another doublet appearing at  $\delta$  4.54 (d,  $J = 8.9$  Hz), integrating for one proton, may be attributed to other benzylic proton. The broad singlet at  $\delta$  4.18, equivalent to one proton, is assignable to bridgehead proton. Two multiplets appearing between  $\delta$  2.08- 1.95 integrating for one proton and  $\delta$  1.85-1.61, integrating for three protons, were assigned for four methylene protons.

Based on the above <sup>1</sup>H NMR spectral analysis, the stereochemistry of proton at  $\delta$  3.62 in **34** was assigned as *endo* because there was no coupling observed with the adjacent bridgehead proton. It is known that no coupling is seen between bridgehead

hydrogen and *endo* hydrogen in the 7-azabicyclo[2.2.1]alkane skeleton due to the dihedral angle being 90° between them.

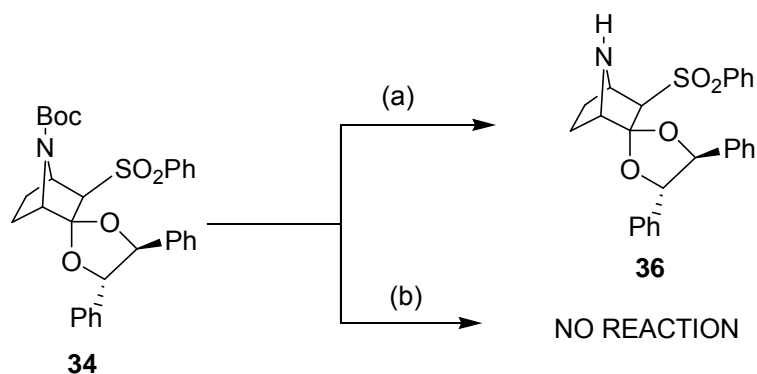


**Figure 6.**

The stereochemistry of **34** was further re-established<sup>14</sup> by extensive spectroscopic analysis including NOESY experiments. The NOE map showed a number of characteristic interactions, for instance, the aromatic proton at the position *ortho* to sulfonyl group presents intense NOE with one of the dioxalanic proton. Since proton is attached with configurationally known dioxalanic carbon which is oriented towards the *exo* face of azanorbomane skeleton, this interaction can only be justified when the phenyl sulfonyl group is oriented towards the *exo* face (Figure 6).

#### 2.2.4 Preparation of (1*S*,3*R*,4*R*)-*tert*-butyl-2-oxo-3-(phenylsulfonyl)-7-azabicyclo[2.2.1]heptane-7-carboxylate (**37**)

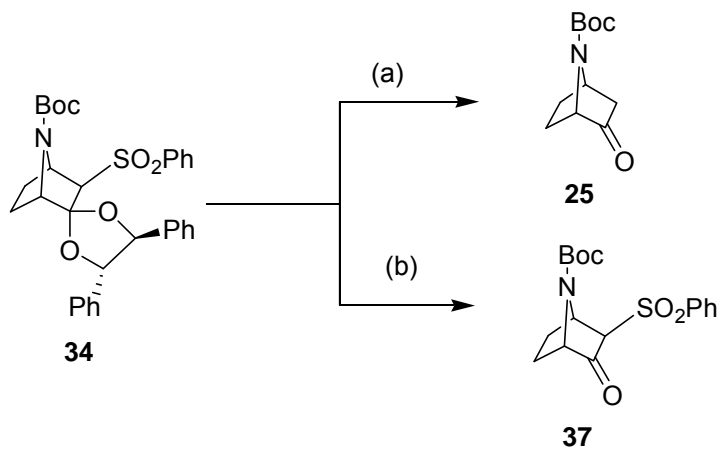
According to our designed strategy, ketone functionality was necessary in order to carry out further synthetic transformations. Therefore, it became necessary to remove the dioxalanic group of **34** to unmask the ketone functionality. Despite numerous literature reports for dioxalanic deprotection, this reaction proved to be a problematic as all the standard protocols of acetal and ketal deprotection failed to give the required product. The use of TiCl<sub>4</sub> and lithium iodide<sup>15</sup> gave only the cleavage of *N*-carbamate group to give **36**. The use of acetone and iodine<sup>16</sup> reagent which is mild method for ketal deprotection had no effect on the substrate (Scheme 9).



Scheme 9.

Reagents and Conditions : (a)  $\text{TiCl}_4$ , LiI, THF, 75% (b)  $\text{I}_2$ , Acetone, rt, 12 h

Next, we planned to apply Birch reduction with the hope that ketal deprotection will be achieved with the survival of phenylsulfonyl group but when **34** was subjected to Birch reduction, ketal group was cleaved alongwith phenylsulfonyl group elimination. Since phenylsulfonyl group is essentially needed for further synthetic elaborations, we had to look for alternative approach. Gratifyingly, treatment of **34** under hydrogenation condition at 60 psi using acetic acid as solvent, the dioxolanic group cleaved to provide the required keto compound **37** (Scheme 10).

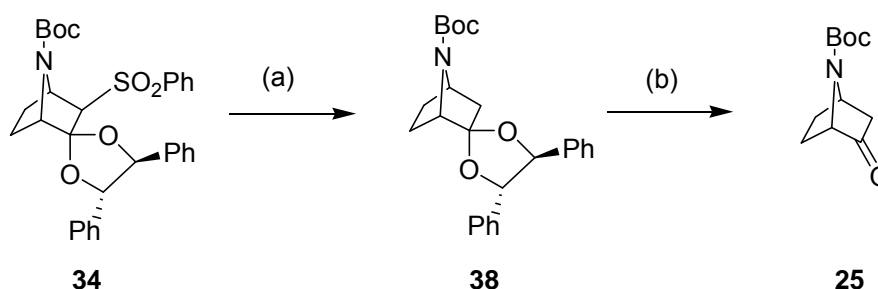


Scheme 10.

Reagents and Conditions : (a) Na, Liq.  $\text{NH}_3$ , THF, 70% (b)  $\text{H}_2$ , Pd/C, AcOH, 60 psi, 24 h, 70%, recovered 30% **34**

The IR spectrum of **37** showed strong absorption band at  $1708\text{ cm}^{-1}$ , a characteristic peak of a carbonyl group.  $^1\text{H}$  NMR spectrum of **37** displayed a multiplet between  $\delta$  8.01-7.86, attributable to the two *ortho* aromatic protons of the phenylsulfonyl group. The multiplets appearing between  $\delta$  7.68- 7.48, integrating for three protons was assigned for the remaining aromatic protons. The three protons appearing at  $\delta$  4.96,  $\delta$  4.25 and  $\delta$  3.57 were assigned as two bridgehead proton and one proton adjacent to sulfonyl group. The splitting pattern in the  $^1\text{H}$  NMR was due to the restricted rotation about NCO bond (rotamers)<sup>17</sup>. Two sets of multiplets at  $\delta$  2.08-1.84 and  $\delta$  1.74-1.57 were assigned as two *endo* and two *exo* protons. Mass spectrum of **37** showed molecular ion peak at 352 ( $\text{M}^+\text{H}$ ).

Although, the required keto compound **37** was obtained by carrying out hydrogenation at high pressure, this rate of reaction was found to be slow and there was no complete consumption of substrate even after a longer period of time. The probable reason could be either poisoning of catalyst by sulfone group or by the steric hinderance posed by phenyl sulfonyl group around the dioxalanic moiety. In order to confirm this observation, phenyl sulfonyl group was removed by reductive desulfonylation of **34** with 6% sodium amalgam prior to hydrogenation which produced desulfonylated product **38**. When **38** was subjected for hydrogenation it furnished ketone<sup>18</sup> **25** with the complete consumption of starting material (Scheme 11).



**Scheme 11.**

*Reagents and Conditions* : (a) Na-Hg, NaH<sub>2</sub>PO<sub>4</sub>, MeOH, 0 °C, 3 h, 70% (b) H<sub>2</sub>, Pd/C, MeOH, 12 h, 90%

The IR spectrum of **25** showed strong characteristic absorption band at 1764 and 1699  $\text{cm}^{-1}$ , indicating the presence of a ketone. The  $^1\text{H}$  NMR spectrum of **25** displayed a triplet at  $\delta$  4.55 (t,  $J = 4.4$  Hz) and a doublet at  $\delta$  4.23 (d,  $J = 4.6$  Hz), integrating for one proton each, assignable to bridgehead protons, respectively. A dd at  $\delta$  2.46 (dd,  $J = 17.5, 5.5$  Hz), integrating for one proton, was assignable to exo proton. A set of two multiplets at  $\delta$  2.05-1.94 assigning for three protons and  $\delta$  1.63-1.56 for two protons, were assigned for the five methylene protons. Mass spectrum of **25** showed molecular ion peak at 212 ( $\text{M}^+\text{H}$ ).



### 2.3 References

1. Spand, T. F.; Garraffo, H. M.; Edwards, M. W.; Daly, J. W. *J. Am. Chem. Soc.* **1992**, *114*, 3475.
2. (a) Badio, B.; Daly, J. W. *Mol. Pharmacol.* **1994**, *45*, 563. (b) Qian, C.; Li, T.; Shen, T. Y. *Eur. J. Pharm.* **1993**, *250*, R13-R14. (c) Li, T.; Eckman, J.; Huang, D. F.; Shen, T. Y. *Bio-Org. Med. Chem. Lett.* **1993**, *3*, 2759.
3. Badio, B.; Garraffo, H. M.; Plummer, C. V.; Padgett, W. L.; Daly, J. W. *Eur. J. Pharm.* **1997**, *321*, 189.
4. (a) Xu, R.; Bai, D.; Chu, G.; Tao, J.; Zhu, X. *Bioorg. Med. Chem. Lett.* **1996**, *6*, 279. (b) Xu, R.; Chu, G.; Zhu, X. *J. Org. Chem.* **1996**, *61*, 4600. (c) Malpass, J. R.; Hemmings, D. A.; Wallis, A.L. *Tetrahedron Lett.* **1996**, *37*, 3911. (d) Zhang, C.; Gyermek, L.; Trudell, M. L. *Tetrahedron Lett.* **1997**, *38*, 5619.
5. (a) Barlocco, D.; Cignarella, G.; Tondi, D.; Vianello, P.; Villa, S.; Bartolini, A.; Ghelardini, C.; Galeotti, N.; Anderson, J.; Kuntzweiler, T. A.; Colombo, D.; Toma, L. *J. Med. Chem.* **1998**, *41*, 674. (b) Ghelardini, C.; Galeotti, N.; Barlocco, D.; Bartolini, A. *Drug. Dev. Res.* **1997**, *40*, 251.
6. Brieady, L. E.; Mascarella, S. W.; Navarro, H. A.; Atkinson, R. N.; Damaj, M. I.; Martin, B. R.; Carroll, F. I. *Tetrahedron Lett.* **2001**, *42*, 3795.
7. (a) Lautens, M.; Dockendorff, C. *Org. Lett.* **2003**, *5*, 369. (b) Lautens, M.; Hiebert, S. *J. Am. Chem. Soc.* **2004**, *126*, 1437. (c) Leong, P.; Lautens, M. *J. Org. Chem.* **2004**, *69*, 2194. (d) Cho, Y-H.; Zunic, V.; Senboku, H.; Olsen, M.; Lautens, M. *J. Am. Chem. Soc.* **2006**, *128*, 6837.
8. (a) Liu, Z.; Rainier, J. D. *Org. Lett.* **2006**, *8*, 459. (b) Liu, Z.; Rainier, J. D. *Org. Lett.* **2005**, *7*, 131.
9. (a) Hernandez, A.; Marcos, M.; Rapoport, H. *J. Org. Chem.* **1995**, *60*, 2683. (b) Clive, D. L. J.; Yeh, V.S.C. *Tetrahedron Lett.* **1998**, *39*, 4789. (c) Karstens, W. F. J.; Moolenaar, M. J.; Rutjes, F. P. J. T.; Grabowska, U.; Speckamp, W. N.; Hiemstra, H. *Tetrahedron Lett.* **1999**, *40*, 8629.

- (d) Node, M.; Nishide, K.; Fujiwara, T.; Ichihashi, S. *Chem. Commun.* **1998**, 2363. (e) Albertini, E.; Barco, A.; Benetti, S.; Risi, C. D.; Pollini, G. P.; Zanirato, V. *Tetrahedron* **1997**, 53, 17177.
10. (a) Pandey, G.; Lakshmaiah, G.; Ghatak, A. *Tetrahedron Lett.* **1993**, 34, 7301. (b) Pandey, G.; Laha, J. K.; Mohanakrishnan, A. K. *Tetrahedron Lett.* **1999**, 40, 6065. (c) Pandey, G.; Bagul, T. D.; Lakshmaiah, G. *Tetrahedron Lett.* **1994**, 35, 7439. (d) Pandey, G.; Bagul, T. D.; Sahoo, A. K. *J. Org. Chem.* **1998**, 63, 760. (e) Pandey, G.; Sahoo, A. K.; Gadre, S. R.; Bagul, T. D.; Phalgune, U. D. *J. Org. Chem.* **1999**, 64, 4990.
11. Pandey, G.; Tiwari, S. K.; Singh, R. S.; Mali, R. S. *Tetrahedron Lett.* **2001**, 42, 3947.
12. Chen, Z.; Trudell, M. L. *Synth. Commun.* **1994**, 24, 3149.
13. Sharpless, K. B.; Amberg, W.; Bennani, Y. L.; Crispino, G. A.; Hartung, J.; Jeong, K.-S.; Kwong, H.-L.; Morikawa, K.; Wang, Z.-M.; Xu, D.; Zhang, X.-L. *J. Org. Chem.* **1992**, 57, 2768.
14. Cossu, S.; Peluso, P. *Tetrahedron Lett.* **2006**, 47, 4015.
15. Balme, G.; Gore, J. *J. Org. Chem.* **1983**, 48, 3336.
16. Sun, J.; Dong, Y.; Cao, L.; Wang, X.; Wang, S.; Hu, Y. *J. Org. Chem.* **2004**, 69, 8932.
17. Pavri, N. P.; Trudell, M. L. *Tetrahedron Lett.* **1997**, 38, 7993.
18. Shasikant; *Ph. D. Thesis*, University of Pune, **2002**.

## Section B

### “Anionic fragmentation of 7-azabicyclo[2.2.1]heptan-2-ol : Enantioselective synthesis of 2-aminocyclohexanols ”

#### 2.4 Importance of 2-aminocyclohexanols

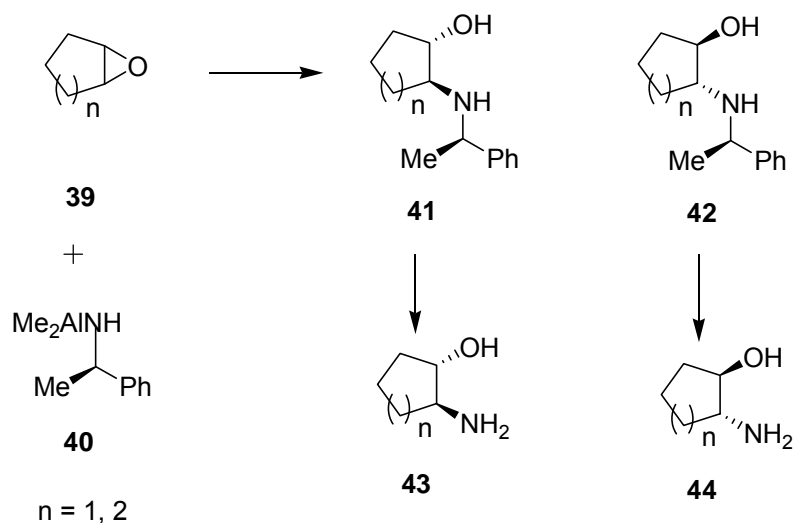
The importance of enantiopure 1,2-amino alcohols in asymmetric synthesis is evident from their successful application as stereochemical control elements<sup>1</sup>. Chiral  $\beta$ -amino alcohols are also versatile synthons in the preparation of wide range of biologically active natural and synthetic products such as unnatural amino acids<sup>2</sup>. Enantiopure 2-aminocyclohexanol derivatives<sup>3</sup> have been used to define the stereochemical preferences of synthetic agonists and perform docking studies to understand the microenvironment of the binding site in *P. aeruginosa* QS regulators. Quorum sensing (QS) regulates the production of virulence factors and the maturation of biofilms in many bacteria. The QS cascade is activated by the interaction of bacterial signaling molecules, called autoinducers (AIs), with their corresponding regulatory proteins.

For the preparation of optically active 2-aminocyclohexanols, there are three general approaches:

- (1) ring opening reaction of cyclohexene oxide by a chiral amine resulting in separable diastereomers,
- (2) enantioselective opening of the *meso* epoxide by an appropriate nucleophile in the presence of a chiral catalyst.
- (3) resolution of racemic compounds or related precursors.

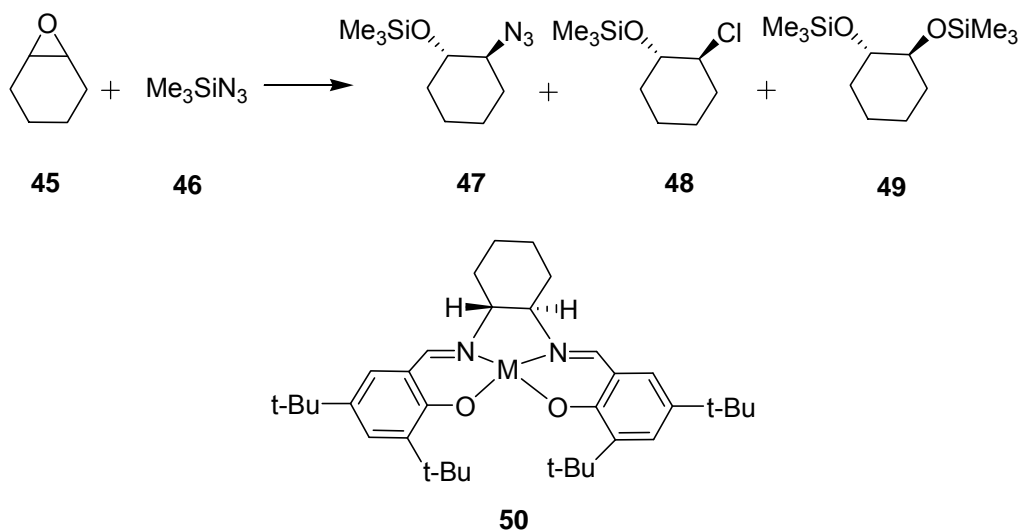
Sugai reported<sup>4</sup> the aminolysis of cyclopentene oxide and cyclohexene oxide **39** with chiral aluminium amide **40** which gave nearly quantitative yield of corresponding amino alcohol derivatives at room temperature (Scheme 12). Although, this reaction

occurred with no diastereoselectivity, the amino alcohols **43** and **44** were easily separated in high yield.



**Scheme 12.**

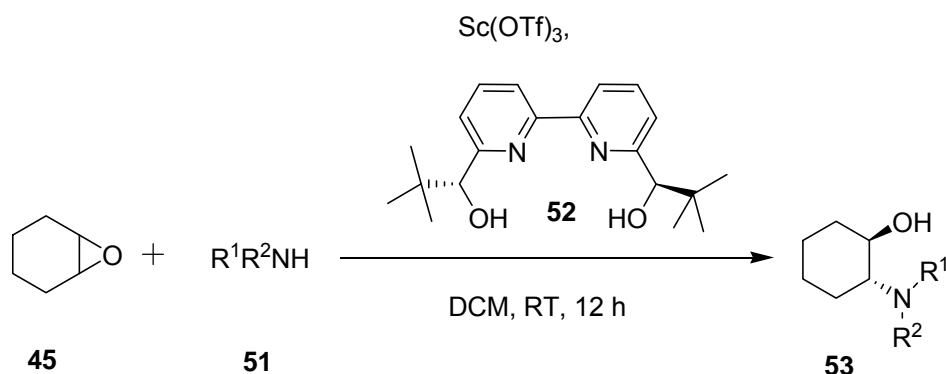
Jacobsen<sup>5</sup> utilized the Cr metal complexes of the readily available chiral salen ligand as catalyst **50** for the *meso*-epoxide **45** ring opening reactions (Scheme 13). The element of stereochemical communication between substrate and ligand is achieved by the activation of epoxide with metal complex which gives 80% yield with 88% *ee*.



**Scheme 13.**

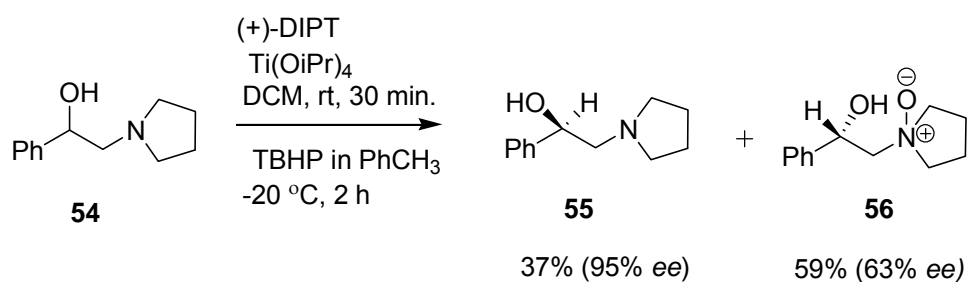
The epoxides fused with five membered rings undergoes ring opening with very high level of enantioselectivity, while six membered and acyclic substrates were slightly less effective.

Very recently Schneider et al.<sup>6</sup> have reported the alcoholysis and aminolysis of *meso*-epoxide using  $\text{Sc}(\text{OTf})_3$  and 2,2'-bipyridine **52** as a chiral catalyst. The reaction of cyclohexene oxide **45** with aromatic amine nucleophile **51** in the presence of 10 mol% each of  $\text{Sc}(\text{OTf})_2$  and the chiral bipyridine **52** yielded 1,2-aminoalcohol **53** in 90% yield and 54% *ee* (Scheme 14). Aliphatic amines did not yield the desired products presumably because they coordinate irreversibly to the Lewis acid.



Scheme 14.

For *cis*-2-aminocyclohexanols the only available method for their synthesis is resolution. Sharpless group<sup>7</sup> has shown that enantiopure *cis*-aminoalcohols can be prepared by kinetic resolution of racemic  $\beta$ -hydroxy amines **54** by enantioselective *N*-oxide formation (Scheme 15). The limitation of this method is that only tertiary amines can be resolved with this approach.



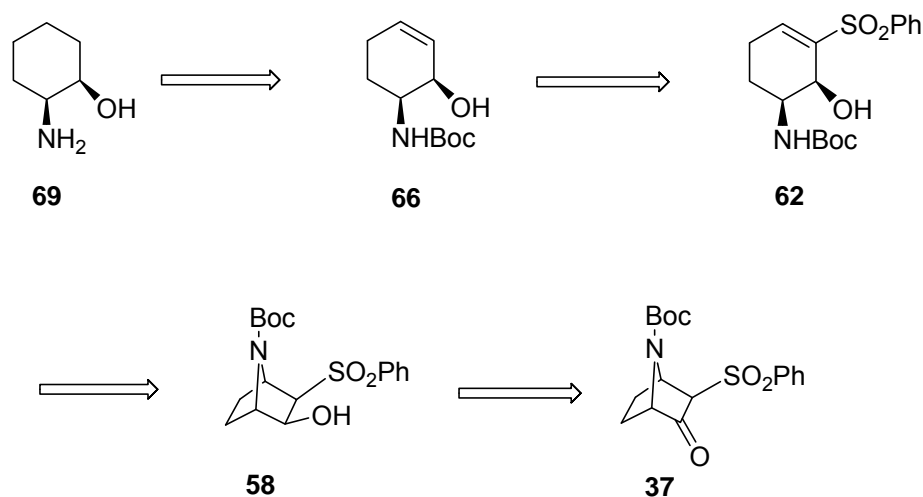
Scheme 15.

## 2.5 Results and discussion

### 2.5.1 Retrosynthetic scheme

As shown in the retrosynthetic analysis (Scheme 16), we visualized that base triggered anionic fragmentation of the 7-azabicyclo[2.2.1]heptan-2-ol **58** could provide substituted cyclohexene derivative **62** which on reductive desulfonylation,

olefin reduction followed by carbamate deprotection would yield *cis*-2-aminocyclohexanol **69** in enantiomerically pure form.

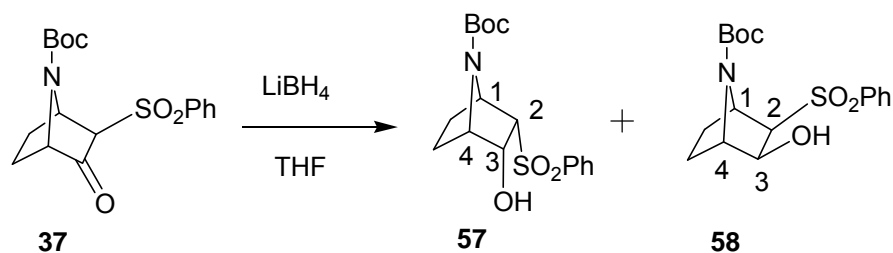


Scheme 16.

Towards fulfilling above hypothesis, we embarked upon the synthesis of *cis*-1,2-aminocyclohexanol and our endeavor and success is delineated in this section as follows:

### 2.5.2 Reduction of (1*S*,3*R*,4*R*)-*tert*-butyl-2-oxo-3-(phenylsulfonyl)-7-azabicyclo[2.2.1]heptane-7-carboxylate (**37**)

After having the required **37** in hand, our next target was to install the hydroxy functionality selectively and in this regard, reduction with lithium borohydride was attempted. Considering the rigid bicyclic structure of **37**, we hoped that reduction with lithium borohydride would furnish only alcohol **58**, owing to the *endo*-attack of the hydride on carbonyl group. However, reduction at room temperature unexpectedly, gave diastereomeric mixture of alcohols **57** and **58** (Scheme 17). Fortunately, both diastereomers could be easily separated by silica gel column chromatography.



Scheme 17.

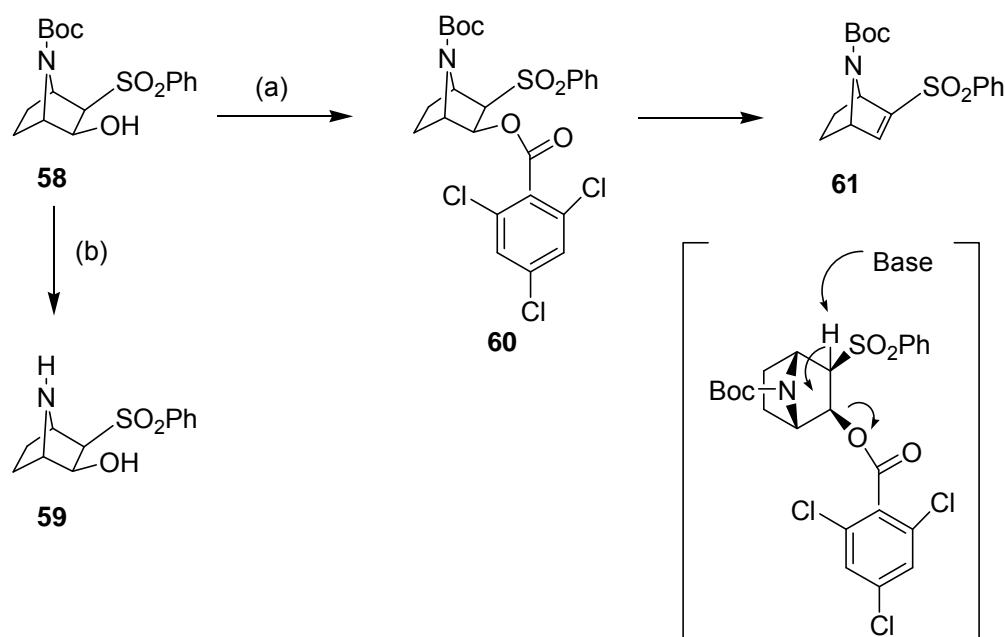
The relative configurations of both the alcohols were unambiguously deduced from their  $^1\text{H}$  NMR spectrum. For illustration, the H-2 proton in **57**, appeared as doublet of doublet ( $J = 9.3, 4.4$  Hz) coupling with bridgehead H-1 and H-3 whereas H-3 appeared as ddd ( $J = 9.6, 9.3, 4.6$  Hz) coupling with H-2, bridgehead H-4 and O-H proton. The coupling with  $-\text{OH}$  (d,  $J = 9.6$  Hz) was confirmed by  $\text{D}_2\text{O}$  exchange which simplified the coupling to dd ( $J = 9.3, 4.6$  Hz). Similarly, in the case of **58**, the H-2 showed doublet ( $J = 6.5$  Hz) coupling only with H-3 whereas H-3 appeared as dd ( $J = 9.7, 6.5$  Hz) coupling with H-2 as well as O-H indicating the *endo*-orientation of protons. This result is in complete agreement with the observation reported previously by our group<sup>8</sup> and others<sup>9</sup> where no coupling is reported between bridgehead and the *endo*-hydrogen in 7-azabicyclo[2.2.1]heptane system.

Since reduction of **37** at room temperature produced diastereomeric mixtures of corresponding alcohols (**57** and **58**), it became obvious to us that there was epimerization of H-2 during reduction. Therefore, it occurred to us to investigate the reduction at lower temperature with the hope that it might offer diastereoselectivity. However, the results showed complete reversal in the diastereoselectivity and the ratio of **57** and **58** with respect to temperature is shown in Table 2.

**Table 2.** Yields and ratio of **57** and **58** during reduction of ketone.

Entry	Temperature (°C)	Ratio ( <b>57/58</b> )	Time	Yield(%) (combined)
1	-78	7:3	30 min.	75
2	-90	7.5:2.5	45 min.	70
3	25	1:9	12 h	78

In order to prove the correct stereochemistry of the phenylsulfonyl and hydroxyl group in **58**, the Boc group was deprotected with the hope that it would provide crystalline compound for X-ray structure. The deprotection was achieved with TFA in anhydrous DCM which produced **59** as a crystalline solid which unfortunately did not diffract for the X-ray structure analysis. Therefore, we derivatised the free hydroxyl group with benzoate ester for better crystallinity and in this regard **58** was treated with trichlorobenzoyl chloride in anhydrous DCM in the presence of Et<sub>3</sub>N as a base. Unfortunately, after the reaction, the product obtained was an eliminated product **61**. After careful analysis it was concluded that this elimination happened probably because after hydroxyl protection the base picks proton which is  $\alpha$ - to sulfonyl group and thereby forcing benzoate ester to eliminate out (Scheme 18).



*Scheme 18.*

*Reagents and Conditions* : (a) Trichlorobenzoyl chloride, TEA, DCM, 0 °C, 10 h, 75% of **61** (b) TFA, DCM, 0 °C, 5 h, 85%

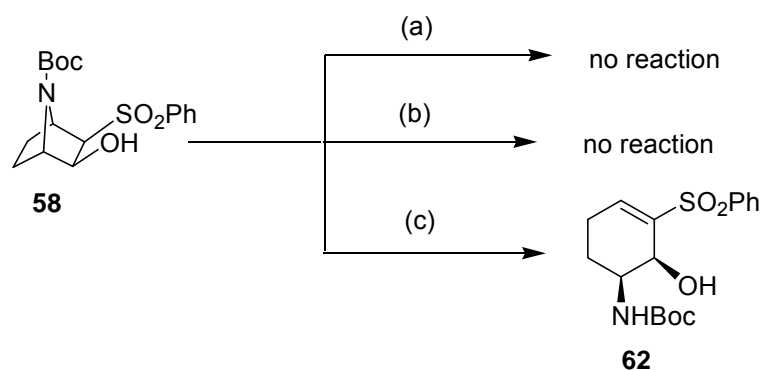
### 2.5.3 Anionic fragmentation

Since **58** is an admirably suitable substrate for exploring base mediated anionic rearrangement, we attempted at first using bases such as LiHMDS and *n*-BuLi,



however, they failed to give any product. Finally, the ring opening of **58** succeeded by the addition of excess of methyl magnesium bromide<sup>10</sup> in a THF solution at room temperature producing **62** in 80% yield as a crystalline solid  $\{[\alpha]_D^{25} -69.0 (c 1.00, CHCl_3), mp 131\text{ }^\circ C\}$  (Scheme 19).

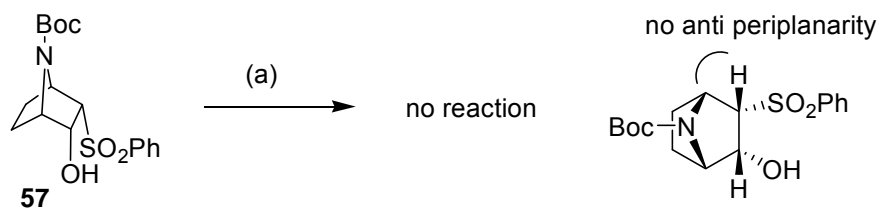
In the <sup>1</sup>H NMR of **62**, the proton signal appearing at  $\delta$  7.19 (dd,  $J = 4.9, 2.5$  Hz, 1H) was assigned as characteristic olefinic proton. The mass spectrum of **62** showed molecular ion peak at 354 ( $M^+ + H$ ).



**Scheme 19.**

*Reagents and Conditions* : (a) *n*-BuLi, THF,  $-78\text{ }^\circ C$  to rt (b) LiHMDS, THF,  $0\text{ }^\circ C$  to rt (c) MeMgBr, THF, rt, 3 h, 80%

Highly encouraged with the success of the ring opening of **58**, we considered that **57** could also be equally well accessible substrate for rearrangement, however, reaction of **57** with methyl magnesium bromide under similar reaction conditions was not equally rewarding as it failed to give any product (Scheme 20). A close look at the structure of **57** indicated that in this molecule, the orientation of sulfone moiety is *endo* which possibly did not allow the fragmentation due to the lack of antiperiplanarity between the bonds to be cleaved.

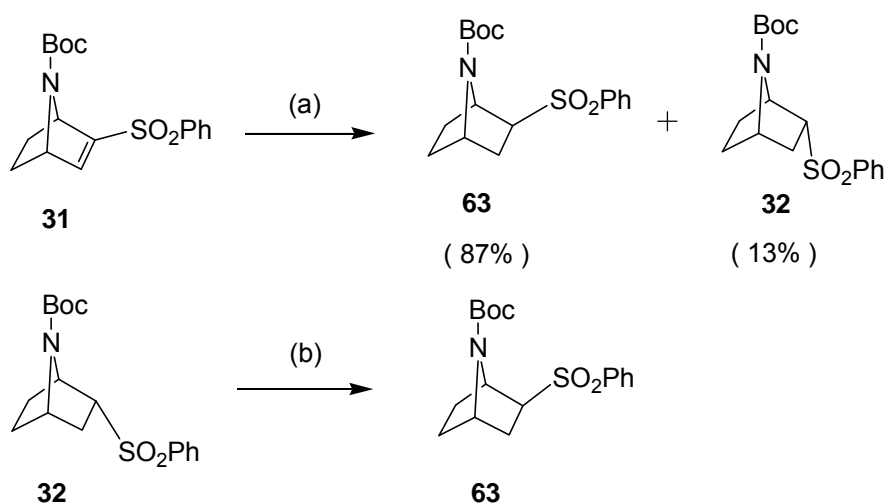


**Scheme 20.**

*Reagents and Conditions* : (a) MeMgBr, THF, rt, 3 h, 80%

### 2.5.4 Epimerisation studies

Although, it is known that in norbornenyl system *exo* phenylsulfone moiety is thermodynamically more stable and to prove this analogy in 7-azabicyclic system following set of experiments were carried out. The compound **31** was treated with sodium borohydride in methanol at 0 °C which yielded *exo* sulfone **63** in 87% yield and *endo* sulfone **32** in 13%. The formation of *exo* sulfone as major amount clearly shows that *exo* sulfone **63** would be thermodynamically stable product. Furthermore, when **32** was treated with lithium bis(trimethylsilyl)amide at -78 °C followed by warming to room temperature and quenching with ammonium chloride, it produced exclusively **63** (Scheme 21).

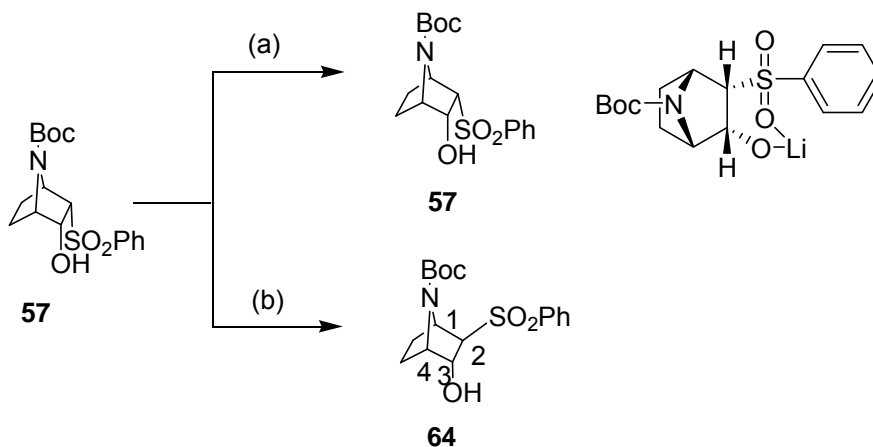


**Scheme 21.**

*Reagents and Conditions* : (a) NaBH<sub>4</sub>, MeOH, 0 °C, 3 h, 90% (b) LiHMDS, THF, -78 °C to rt, 1 h, 80%

In order to support our observation, we planned to epimerise the *endo* sulfone group of **57** to *exo* sulfone and in this context, initially the epimerization using LiHMDS was tried but it failed to give the expected **64** probably because of the chelation of lithium between hydroxyl oxygen and sulfonyl oxygen. Therefore, the reaction with KHMDS was evaluated and to our pleasure it gave **64** in 70% yield (Scheme 22). The structure of **64** was confirmed on the basis of <sup>1</sup>H NMR analysis as H-2 proton

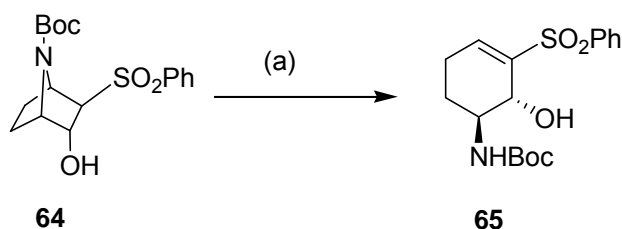
displayed a doublet (d,  $J = 3.6$  Hz) which is possible only when sulfone is oriented to *exo* side.



**Scheme 22.**

**Reagents and Conditions :** (a) LiHMDS, THF,  $-78$  °C, 3 h to rt (b) KHMDS, THF,  $-78$  °C, 4 h to rt, 70%

Subjecting **64** for the ring opening reaction using the same experimental protocol as described above for **58**, yielded product **65** (Scheme 23) in 70% yield as a crystalline solid { mp  $125$  °C [ $\alpha$ ] $^{25}_D$   $+14.6$  ( $c$  0.40,  $\text{CHCl}_3$ ) }



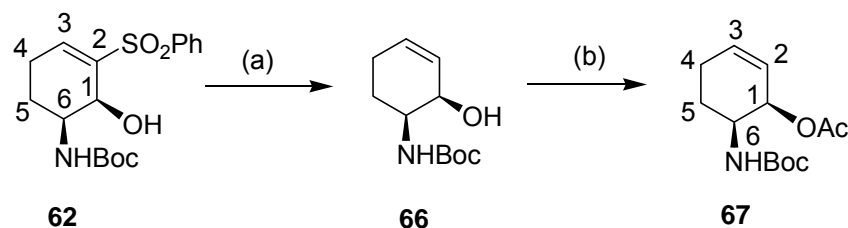
**Scheme 23.**

**Reagents and Conditions :** (a) MeMgBr, THF, rt, 70%

In the  $^1\text{H}$  NMR of **65**, the proton signal appearing at  $\delta$  7.19 (dd,  $J = 4.9, 2.5$  Hz, 1H) was assigned as characteristic proton for olefine. The mass spectrum of **65** showed molecular ion peak at 354 ( $\text{M}^+\text{+H}$ ).

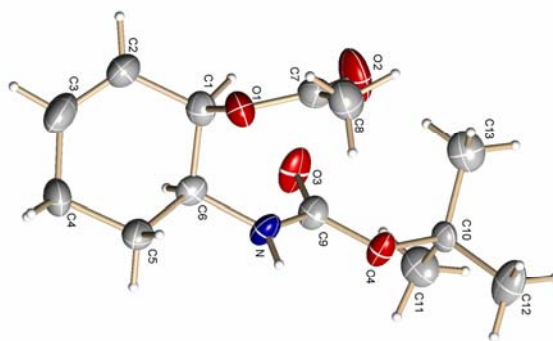
Owing to undefined couplings between the two stereochemical protons (H-1 and H-6) in the  $^1\text{H}$ NMR of **62**, it was difficult to assign the relative configuration

satisfactorily. Although, **62** was a good crystalline compound, it did not diffract properly for X-ray analysis. Luckily, removal of the phenylsulfonyl group, using 6% sodium amalgam in a buffered methanol, followed by the acetate protection of the free hydroxyl group of the resultant molecule **66** gave **67** which was a good crystalline solid (mp 66 °C) and produced X-ray structure (Figure 2) confirming *cis*-1, 6-amino alcohol configuration in **62** (Scheme 24).



**Scheme 24.**

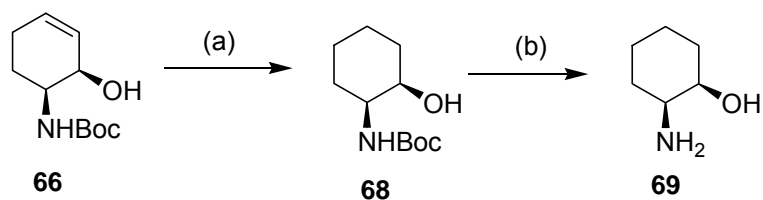
*Reagents and Conditions* : (a) Na-Hg (6%), Na<sub>2</sub>HPO<sub>4</sub>, THF:MeOH (1:1), -6 °C, 2 h, 80% (b) AcCl, Et<sub>3</sub>N, DCM, rt, 12 h, 80%



**Figure 7.** ORTEP diagram of **67**

### 2.5.5 Synthesis of *cis*-2-aminocyclohexanol

Towards the exploration of synthetic utility of **66**, the olefin was reduced by palladium catalysed hydrogenation to obtain **68** which on carbamate deprotection with TFA yielded *cis*-2-aminocyclohexanol **69** as a crystalline solid (Scheme 25).

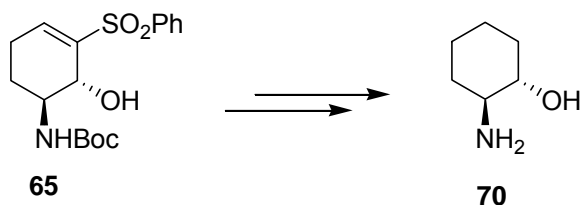


*Scheme 25.*

*Reagents and Conditions* : (a) H<sub>2</sub>, Pd/C, MeOH, 5 h, 95% (b) TFA, DCM, 5 h, 90%

In the <sup>1</sup>H NMR of **69**, two set of multiplets appearing at  $\delta$  3.98 and  $\delta$  3.25 each integrating for one proton, were assigned as protons attached with hydroxyl group and amine group, respectively. A multiplet between  $\delta$  1.72-1.28 integrated for eight protons were assigned to methylene protons. The mass spectrum of **69** showed molecular ion peak at 116 (M<sup>+</sup>+H).

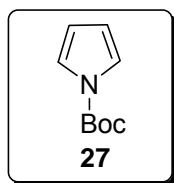
Similarly, *trans*-2-aminocyclohexanol **70** is also obtained from **65** by performing the similar set of experiments (Scheme 26).



*Scheme 26.*

## 2.6 Experimental Section

### 1. Preparation of *tert*-butyl pyrrole-1-carboxylate (**27**)

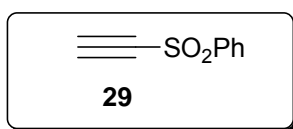


To a stirred solution of freshly distilled pyrrole **26** (6.76 g, 0.1 mol) in dry acetonitrile (100 mL) was added DMAP (1.2 g, 0.01 mol) and Boc<sub>2</sub>O (26 g, 0.12 mol) at room temperature. Evolution of gas commenced and after 0.5 h, a clear dark red coloured solution was obtained. The whole reaction mixture was stirred at room temperature for 48 h to ensure the complete reaction. The solvent was carefully removed under reduced pressure and distillation of residual mixture under reduced pressure gave the **27** as a yellow oil (16.0 g, 99%).

<sup>1</sup>H NMR (200 MHz, CDCl<sub>3</sub>) δ : 7.20 (t, 2H, *J* = 2.34 Hz) 6.26 (t, 2H, *J* = 2.46 Hz) 1.64 (s, 9H)

<sup>13</sup>C NMR (50 MHz, CDCl<sub>3</sub>) δ : 27.9, 83.5, 111.8, 119.9, 148.9

### 2. Preparation of phenyl ethynyl sulfone (**29**)



To a stirring suspension of powdered aluminium chloride (9.389 g, 0.070 mol) in anhydrous CH<sub>2</sub>Cl<sub>2</sub> (40 mL) at room temperature under argon atmosphere was introduced benzene sulfonyl chloride (12.437 g, 0.070 mol) dropwise. The resulting pale yellow solution was maintained at the same temperature for 40 min. This solution was slowly transferred by cannula (30 min.) under argon atmosphere to an ice-cold solution of bis(trimethylsilyl)acetylene **28** (10 g, 0.059 mol) in anhydrous CH<sub>2</sub>Cl<sub>2</sub> (50

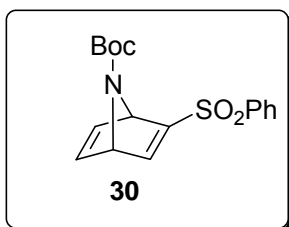
mL). It was observed that the color of solution changed from colourless to red and finally to the dark red. The reaction mixture was further allowed to stir for 24 h at the room temperature. Afterwards, the whole content was poured into a beaker containing 1N HCL (30 mL) and crushed ice. CH<sub>2</sub>Cl<sub>2</sub> (30 mL) was added into the beaker and the organic layer was separated, washed twice with water, brine and dried over anhydrous Na<sub>2</sub>SO<sub>4</sub>. The solvent was removed under reduced pressure to furnish dark brown liquid. Purification on silica gel column using EtOAc: pet. ether (1:9) as eluent, afforded **29** (6.308 g, 65%) as a yellowish liquid.

IR  $\nu_{\max}$  cm<sup>-1</sup> in CHCl<sub>3</sub> : 1167, 1342, 2071, 3281

<sup>1</sup>H NMR (200 MHz, CDCl<sub>3</sub>)  $\delta$  : 8.03-7.98 (m, 2H) 7.75-7.56 (m, 3H) 3.49 (s, 1H)

<sup>13</sup>C NMR (50 MHz, CDCl<sub>3</sub>)  $\delta$  : 140.3, 134.6, 129.3, 127.3, 82.1, 79.7

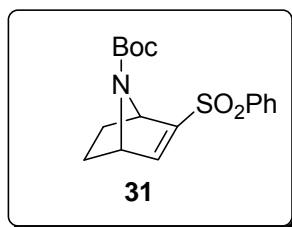
### 3. Preparation of *tert*-butyl 2-(phenylsulfonyl)-7-azabicyclo[2.2.1]hepta-2,5-diene-7-carboxylate (**30**)



A mixture of phenyl ethynyl sulfone **29** (3.979 g, 0.024 mol) and *tert*-butyl pyrrole-1-carboxylate **27** (8.02 g, 0.048 mol) was heated in an inert atmosphere to 85-90 °C for 26 h. The resultant brownish oil was separated into its components by column chromatography. Elution with pet. ether-ethyl acetate (95:5) gave **29** in small amount (7%) along with recovered **27**. Further elution with pet. ether-ethyl acetate (8:2) gave **30** as a brown solid which on further recrystallization from pet. ether-ethyl acetate gave **30** (5.53g, 70%) as a white solid.

mp	:	113-115 °C
IR $\nu_{\max}$ $\text{cm}^{-1}$ in $\text{CHCl}_3$	:	1693, 1465, 1458, 1153
$^1\text{H}$ NMR (200 MHz, $\text{CDCl}_3$ ) $\delta$	:	7.89-7.85 (m, 2H) 7.69 (m, 4H) 6.94-6.86 (m, 2H) 5.38 (s, 1H) 5.17 (s, 1H) 1.25 (s, 9H)
$^{13}\text{C}$ NMR (50 MHz, $\text{CDCl}_3$ ) $\delta$	:	153.6, 142.8, 141.4, 138.4, 133.7, 129.2, 127.8, 81.2, 67.6, 66.6, 27.7
Mass (ESI): $m/z$	:	334 ( $\text{M}^+\text{+H}$ ), 351 ( $\text{M}^+\text{+NH}_4^+$ ), 356 ( $\text{M}^+\text{+Na}$ )

#### 4. Preparation of *tert*-butyl 2-(phenylsulfonyl)-7-azabicyclo[2.2.1]hept-2-ene-7-carboxylate (**31**)



A slow stirring suspension of **30** (2.5 g, 0.0074 mol) over Pd/C (250 mg, 10% Pd on activated charcoal) in acetonitrile (30 mL) was hydrogenated at 1 atmospheric pressure for 6 h. The progress of the reaction was monitored by TLC. After the reaction was over, the reaction mixture was filtered through Whatman filter paper. The filtrate was concentrated under reduced pressure and the residue was column chromatographed over silica gel eluting with ethyl acetate-pet. ether (1.5:8.5) to obtain **31** (2.47 g, 98%) as a white crystalline solid.

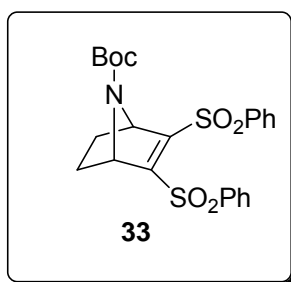
mp	:	101-103 °C
IR $\nu_{\max}$ $\text{cm}^{-1}$ in $\text{CHCl}_3$	:	1712, 1695, 1585, 1155
$^1\text{H}$ NMR (200 MHz, $\text{CDCl}_3$ ) $\delta$	:	7.94-7.90 (m, 2H) 7.65-7.52 (m, 3H) 7.10 (d, $J = 2.1$ Hz, 1H) 4.83 (bs, 1H) 4.76 (d, $J = 3.4$ Hz, 1H) 2.10- 1.92 (m, 2H) 1.47-1.26 (m, 2H) 1.18 (s, 9H)
$^{13}\text{C}$ NMR (50 MHz, $\text{CDCl}_3$ ), $\delta$	:	154.7, 148.5, 144.2, 139.7, 133.7, 129.4,



127.8, 80.7, 61.8, 60.8, 27.8, 25.0, 24.1

Mass (ESI):  $m/z$  : 336 ( $M^+ + H$ ), 353 ( $M^+ + NH_4^+$ ), 358 ( $M^+ + Na$ )

### 5. Preparation of *meso*-*tert*-butyl 2,3-bis(phenylsulfonyl)-7-azabicyclo[2.2.1]hept-2-ene-7-carboxylate (**33**)



A solution of **31** (1.0 g, 2.98 mmol) in anhydrous THF (12 mL) was charged into a 50 mL two neck RB flask, equipped with a magnetic stirring bar under argon atmosphere. The flask was cooled to  $-78$  °C and while stirring, *n*-BuLi (1.75 M solution in hexane, 1.70 mL, 2.98 mmol) was introduced dropwise over a period of 5 min. The reaction mixture was further allowed to stir for 10 min. at the same temperature and benzene sulfonyl fluoride (0.47 g, 3.57 mmol) solution in anhydrous THF (0.5 mL) was added dropwise into the flask. The reaction mixture was allowed to warm to room temperature and was quenched with saturated aqueous  $NH_4Cl$  solution (2 mL). The reaction mixture was extracted with ethyl acetate (3 x 5 mL). The combined organic extracts were washed with brine, dried over anhydrous  $Na_2SO_4$  and concentrated under reduced pressure. The residue was purified over silica gel by column chromatography using ethyl acetate-pet. ether (2:8 to 2.5:7.5) as eluent to afford **33** which was further purified by recrystallization with ethyl acetate- pet. ether to give **33** (1.13 g, 80%) as a white crystalline solid.

mp : 130-132 °C

IR (neat)  $\nu_{max}$   $cm^{-1}$  : 1714, 1338, 1265, 1087 $^1H$  NMR (400 MHz,  $DMSO-d_6$ )  $\delta$  : 7.91-7.82 (m, 6H) 7.72-7.68 (m, 4H) 4.96 (s, 2H) 2.11 (d,  $J = 9.5$  Hz, 2H) 1.24 (d,  $J =$

8.0 Hz, 2H) 1.06 (s, 9H)

$^{13}\text{C}$  NMR (100 MHz, DMSO- $d_6$ )  $\delta$  : 154.2, 138.9, 135.3, 129.9, 128.4, 81.3, 65.9,  
27.3, 24.9

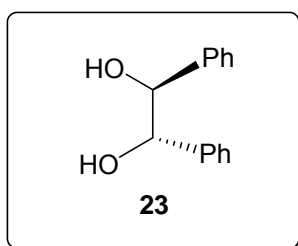
Mass (ESI):  $m/z$  : 476 ( $\text{M}^+\text{+H}$ ), 498 ( $\text{M}^+\text{+Na}$ )

## 6. Preparation of benzene sulfonyl fluoride



The heterogeneous mixture of  $\text{KF-CaF}_2$  in 1:2 ratio (20 g, containing 344 mmol of  $\text{KF}$ ) was grinded to fine powder and was dried at  $150\text{ }^\circ\text{C}$  under vacuum for several hours. Benzene sulfonyl chloride (30.2 g, 172 mmol) was added to the heterogeneous mixture followed by addition of anhydrous acetonitrile (20 mL) in order to make the solution stir. The reaction proceeded smoothly to afford the corresponding fluoride in 6 hours as determined by g.l.c. analysis. After reaction was over, the solid materials were filtered off and washed with diethyl ether. The solvent was evaporated and benzene sulfonyl fluoride (21.9 g) was distilled off under reduced pressure to give 80% yield as a colourless liquid.

## 7. Preparation of (1*S*,2*S*)-1,2-diphenylethane-1,2-diol (**23**)

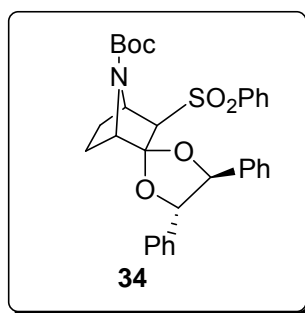


In a 250 mL RB flask equipped with a magnetic stirrer was charged with 27.2 mL  $\text{H}_2\text{O}$ , 27.2 ml  $t\text{-BuOH}$ ,  $\text{K}_2\text{CO}_3$  (2.271 g),  $\text{K}_3\text{Fe}(\text{CN})_6$  (5.42 g) and stirred for 10 min. to get red coloured clear solution. To this red coloured solution, methane sulfonamide (0.527 g),  $(\text{DHQ})_2\text{PHAL}$  (0.043 g) and  $\text{OsO}_4$  (0.40 mL, solution in  $t\text{-BuOH}$ ) was

added sequentially. This reaction mixture was cooled to 0 °C and **35** (1.0 g, 5.55 mmol) was added. The reaction mixture was stirred for 24 h at the same temperature and afterwards, solid NaHSO<sub>3</sub> (2.0 g) was added to quench the reaction mixture and stirred 45 min. at 0 °C. After warming to the room temperature, the reaction mixture was extracted several times with EtOAc. The combined organic layer was dried over Na<sub>2</sub>SO<sub>4</sub>, concentrated in vacuo and purified by crystallization in MeOH provided **23** (0.940 g, 80%) as a white crystalline solid.

mp : 148-150 °C  
[α]<sub>D</sub><sup>27</sup> : -94.6 (c 1.0, CHCl<sub>3</sub>) lit. -94.0 (c 2.5 EtOH)  
<sup>1</sup>H NMR (200 MHz, CDCl<sub>3</sub>) δ : 7.15-7.09 (m, 6H) 7.05-6.98 (m, 4H) 4.59 (s, 2H) 2.80 (m, 2H)  
<sup>13</sup>C NMR (50 MHz, CDCl<sub>3</sub>) δ : 140.6, 127.8, 127.5, 127.1, 79.09

**8. Preparation of (1*S*,3*R*,4*R*,4'*S*,5'*S*)-tert-butyl- 4',5'-diphenyl-3-(phenylsulfonyl)-7-azaspiro{bicyclo[2.2.1]heptane-2,2'-[1,3]dioxalane}-7-carboxylate (**34**)**

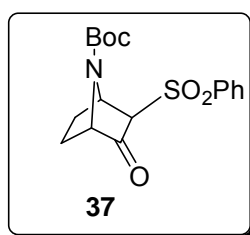


To an ice-cooled suspension of NaH (0.184 g, 4.62 mmol, 60% suspension in mineral oil) in anhydrous THF (3 mL) was added a solution of (-)-**23** (0.449 g, 2.10 mmol) in anhydrous THF (6 mL) dropwise. After complete addition, the reaction mixture was allowed to stir at room temperature for one hour. A solution of **33** (1.0 g, 2.10 mmol) dissolved in anhydrous THF (5 mL) was added dropwise into the flask while stirring at 0 °C. The reaction mixture was further allowed to stir at the same

temperature for additional 2 h and then warmed to room temperature. Completion of the reaction was monitored by silica gel TLC and after the complete disappearance of **33**, the reaction mixture was quenched with dropwise addition of methanol (2 mL). Usual work-up followed by silica gel column chromatography provided desymmetrized product **34** which on crystallization with ethyl acetate : pet-ether gave **34** as white solid (0.943 g, 82%). The diastereomeric purity was confirmed by HPLC analysis [Merck Purospher (250x 4.6 mm) CH<sub>3</sub>CN:H<sub>2</sub>O (60:40) isocratic, flow rate 1.2 mL/min, retention time 27.85 min].

mp	: 171-173 °C
$[\alpha]_D^{25}$	: -96.8 (c 1.0 CHCl <sub>3</sub> )
IR $\nu_{\max}$ cm <sup>-1</sup> in CHCl <sub>3</sub>	: 1706, 1446, 1307, 1159
<sup>1</sup> H NMR (200 MHz, CDCl <sub>3</sub> ) $\delta$	: 8.00-7.96 (m, 2H) 7.59-7.25 (m, 11H) 7.16-7.11 (m, 2H) 5.28 (d, <i>J</i> = 8.8 Hz, 1H) 4.69 (bs, 1H) 4.54 (d, <i>J</i> = 8.9 Hz, 1H) 4.18 (bs, 1H) 3.62 (s, 1H) 2.08-1.95 (m, 1H) 1.85-1.61 (m, 3H) 1.37 (s, 9H)
<sup>13</sup> C NMR (100 MHz, DMSO-d <sub>6</sub> ) $\delta$	: 153.5, 139.6, 135.9, 135.0, 133.9, 129.1, 128.7, 127.5, 127.1, 113.4, 86.2, 84.3, 79.7, 75.4, 63.6, 58.3, 55.6, 28.3, 28.1, 21.9
Mass (ESI): <i>m/z</i>	: 548 (M <sup>+</sup> +H), 565 (M <sup>+</sup> +NH <sub>4</sub> <sup>+</sup> ), 570 (M <sup>+</sup> +Na)

### 9. Preparation of (1*S*,3*R*,4*R*)-tert-butyl-2-oxo-3-(phenylsulfonyl)-7-azabicyclo[2.2.1]heptane-7-carboxylate (**37**)

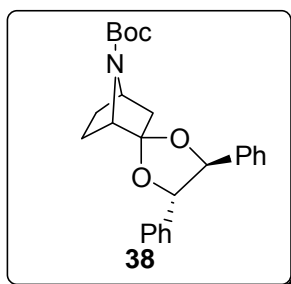


To a solution of **34** (2 g, 3.65 mmol) in AcOH (15 mL) was added Pd/C (0.400 g, 10 mol% Pd on activated charcoal) and hydrogenated over Parr shaker at 60 Psi for 24 h.

The reaction mixture was filtered by a whatmann filter paper and washed with excess of aqueous solution of NaHCO<sub>3</sub> in order to remove the acetic acid. The reaction mixture was extracted several times with the EtOAc and the combined organic layer was dried over Na<sub>2</sub>SO<sub>4</sub>. The product was isolated by column chromatography to give **37** as a floppy solid (0.87 g, 70%) along with **34** (0.6 g, 30%).

m.p.	:	127-128 °C
$[\alpha]_D^{27}$	:	+57.9 ( <i>c</i> 1.0, CHCl <sub>3</sub> )
IR $\nu_{\max}$ cm <sup>-1</sup> in CHCl <sub>3</sub>	:	1774, 1708, 1448, 1265, 1153
<sup>1</sup> H NMR (200 MHz, CDCl <sub>3</sub> ) $\delta$	:	8.01-7.86 (m, 2H) 7.48-7.68 (m, 3H) 4.98 (s, 0.7H) 4.88 (t, <i>J</i> = 4.2 Hz, 0.3 H) 4.32 (d, <i>J</i> = 6 Hz, 0.3H) 4.25 (s, 0.7H) 4.05 (d, <i>J</i> = 5.1 Hz, 0.3Hz) 3.57 (s, 0.7H) 2.08-1.84 (m, 2H) 1.74-1.57 (m, 2H) 1.40 (s, 9H)
<sup>13</sup> C NMR (50 MHz, CDCl <sub>3</sub> ) $\delta$	:	197.4, 196.8, 153.9, 153.1, 139.5, 138.4, 134.2, 129.3, 128.7, 82.0, 81.3, 74.5, 72.7, 64.9, 63.0, 58.4, 28.1, 26.91, 24.7, 24.5
Mass (ESI): <i>m/z</i>	:	352 (M <sup>+</sup> +H), 374 (M <sup>+</sup> +Na)

#### 10. Preparation of (1*S*,3*R*,4*R*,4'*S*,5'*S*)-*tert*-butyl-4',5'-diphenyl-7-azaspiro{bicyclo[2.2.1]heptane-2,2'-[1,3]dioxalane}-7-carboxylate (**38**)

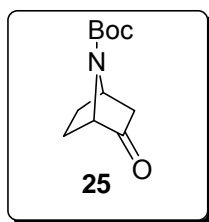


To a stirring solution of NaH<sub>2</sub>PO<sub>4</sub> (0.6589 g, 5.44 mmol) in anhydrous methanol (10 mL), **34** (0.550 g, 1.08 mmol) dissolved in methanol (5 mL) was added. The reaction mixture was cooled to 0 °C and sodium amalgam (2.0 g, 6%) was added portionwise

(30 min.) while stirring at the same temperature. The reaction mixture was allowed to stir for an additional 3 h at 0 °C. The progress of reaction was monitored by TLC and after the completion of the reaction water (1 mL) was added dropwise. The solution was warmed to room temperature and was extracted with ethyl acetate several times. The combined organic layer was washed with brine and dried over Na<sub>2</sub>SO<sub>4</sub>. Removal of the solvent and silica gel column chromatography purification of the obtained residue using ethyl acetate : pet. ether as eluent afforded **38** (0.347 g, 85%) as a white solid.

mp	:	112-114 °C
[α] <sup>25</sup> <sub>D</sub>	:	+35.5 (c 1.0, CHCl <sub>3</sub> )
<sup>1</sup> H NMR (200 MHz, CDCl <sub>3</sub> ) δ	:	7.41-7.27 (m, 10H) 4.86 (d, <i>J</i> = 8.4 Hz, 1H) 4.67 (d, <i>J</i> = 4.8 Hz, 1H) 4.39 (bs, 2H) 2.45 (dd, <i>J</i> = 12.2, 4.8 Hz, 1H) 2.09-1.77 (m, 5H) 1.51 (s, 9H)
<sup>13</sup> C NMR (50 MHz, CDCl <sub>3</sub> ) δ	:	155.4, 136.3, 134.6, 128.6, 128.1, 127.0, 126.3, 86.2, 85.2, 79.7, 63.0, 59.6, 29.7, 28.3, 23.8, 22.7
Mass (ESI): <i>m/z</i>	:	408 (M <sup>+</sup> +H), 430 (M <sup>+</sup> +Na)

### 11. Preparation of (1*S*,4*R*)-tert-butyl 2-oxo-7-azabicyclo[2.2.1]heptane-7-carboxylate (**25**)



A solution of **38** (0.050 g, 0.122 mmol) in methanol (3 mL) with Pd/C (0.006 g, 10% Pd on activated charcoal) was hydrogenated at 1 atm pressure of hydrogen for 20 h. After the completion of the reaction, the reaction mixture was filtered off and

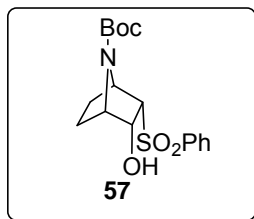
solvent was removed under reduced pressure. The residue was column chromatographed over silica gel eluting with ethyl acetate : pet. ether to afford **25** (0.023 g, 90%) as a colourless liquid.

$[\alpha]_D^{29}$	:	+77.3 (c 1.0, CHCl <sub>3</sub> )
IR $\nu_{\max}$ cm <sup>-1</sup> in CHCl <sub>3</sub>	:	1764, 1699
<sup>1</sup> H NMR (400 MHz, CDCl <sub>3</sub> ) $\delta$	:	4.55 (t, <i>J</i> = 4.64 Hz, 1H) 4.23 (d, <i>J</i> = 4.68 Hz, 1H) 2.46 (dd, <i>J</i> = 17.56, 5.50 Hz, 1H) 2.05-1.94 (m, 3H) 1.63-1.57 (m, 2H) 1.44 (s, 9H)
<sup>13</sup> C NMR (100 MHz, CDCl <sub>3</sub> ) $\delta$	:	209.5, 155.0, 80.7, 63.8, 56.0, 45.1, 28.1, 27.5, 24.3
Mass (ESI): <i>m/z</i> (%)	:	212 (M <sup>+</sup> +H), 234 (M <sup>+</sup> +Na)

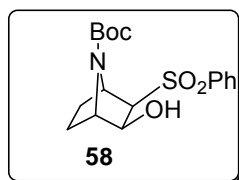
### General procedure for reduction of **37**

To a solution of compound (1.0 g, 2.84 mmol) in anhydrous THF (15 mL) was added a solution of LiBH<sub>4</sub> (1.42 mL, 2.84 mmol, 2.0 M) at the temperature mentioned in the Table 1. After stirring the mixture for a given period mentioned in Table 1, saturated aqueous solution of NH<sub>4</sub>Cl was added and allowed to warm to room temperature while stirring. The solution was diluted with AcOEt, washed with water and brine and concentrated. The resultant residue was purified by column chromatography to give **57** and **58** as a white solid.

Entry	Temperature (°C)	Ratio ( <b>57/58</b> )	Time	Yield(%) (combined)
1	-78	7:3	30 min.	75
2	-90	7.5:2.5	45 min.	70
3	25	1:9	12 h	78

**12. Preparation of (1S,3S,4R)-tert-butyl 2-hydroxy-3-(phenylsulfonyl)-7-azabicyclo[2.2.1]heptane-7-carboxylate (57)**

mp	:	108 °C
$[\alpha]_D^{28}$	:	+6.2 ( <i>c</i> 0.9, CHCl <sub>3</sub> )
IR $\nu_{\max}$ cm <sup>-1</sup> in CHCl <sub>3</sub>	:	3492, 2978, 1711, 1150
<sup>1</sup> H NMR (500 MHz, CDCl <sub>3</sub> ) $\delta$	:	7.94 (d, <i>J</i> = 7.7 Hz, 2H) 7.65 (t, <i>J</i> = 7.4 Hz, 1H) 7.56 (t, <i>J</i> = 7.9 Hz, 2H) 4.41 (m, 1H) 4.35 (ddd, <i>J</i> = 9.6, 9.3, 4.6 Hz, 1H) 4.27 (bs, 1H) 3.95 (d, <i>J</i> = 9.6, 1H) 3.57 (dd, <i>J</i> = 9.3, 4.4 Hz, 1H) 2.58 (t, <i>J</i> = 9.3 Hz, 1H) 2.16 (m, 1H) 1.82-1.79 (m, 2H) 1.39 (s, 9H)
<sup>13</sup> C NMR (125 MHz, CDCl <sub>3</sub> ) $\delta$	:	154.2, 140.0, 133.8, 129.2, 127.7, 80.6, 69.7, 64.0, 61.0, 58.7, 27.9, 24.4, 20.1
Mass (ESI): <i>m/z</i>	:	354 (M <sup>+</sup> +H), 376 (M <sup>+</sup> +Na), 392 (M <sup>+</sup> +K)

**13. Preparation of (1S,2S,3R,4R)-tert-butyl-2-hydroxy-3-(phenylsulfonyl)-7-azabicyclo[2.2.1]heptane-7-carboxylate (58)**

mp	:	111- 112 °C
$[\alpha]_D^{22}$	:	+18.5 ( <i>c</i> 1.0, CHCl <sub>3</sub> )



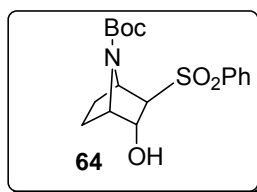
IR  $\nu_{\max}$   $\text{cm}^{-1}$  in  $\text{CHCl}_3$  : 3442, 2970, 1686, 1145

$^1\text{H}$  NMR (400 MHz,  $\text{CDCl}_3$ )  $\delta$  : 8.02-7.97 (m, 2H) 7.68-7.51 (m, 3H) 4.68 (d,  $J$  = 3.0 Hz, 1H) 4.20 (d,  $J$  = 3.4 Hz, 1H) 4.10 (dd,  $J$  = 9.8, 6.5 Hz, 1H) 3.49 (d,  $J$  = 10.1 Hz, 1H) 3.26 (d,  $J$  = 6.5 Hz, 1H) 1.83-1.71 (m, 2H) 1.43 (s, 9H) 1.32- 1.24 (m, 2H)

$^{13}\text{C}$  NMR (100 MHz,  $\text{CDCl}_3$ )  $\delta$  : 154.9, 139.3, 133.8, 129.2, 128.9, 80.8, 74.7, 71.2, 63.4, 56.7, 29.0, 27.9, 23.6

Mass (ESI):  $m/z$  : 354 ( $\text{M}^+\text{+H}$ ), 392( $\text{M}^+\text{+K}$ )

#### 14. Preparation of (1*S*,3*R*,4*R*)-*tert*-butyl 2-hydroxy-3-(phenylsulfonyl)-7-azabicyclo[2.2.1]heptane-7-carboxylate (**64**)



To a solution of **57** (0.100 g, 0.283 mmol) in anhydrous THF (2 mL) was added KHMDS (1.41 mL, 0.707 mmol) at  $-78$  °C. The reaction mixture was stirred at same temperature for 1h, warmed slowly to room temperature and stirred 45 min. The reaction mixture was quenched by adding dil HCl. The usual work-up followed by column chromatography yielded **64** (0.070 g, 70%) as a white solid.

mp : 105 °C

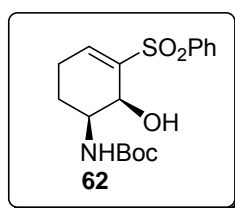
$[\alpha]_{\text{D}}^{29}$  : -8.6 ( $c$  0.5,  $\text{CHCl}_3$ )

IR  $\nu_{\max}$   $\text{cm}^{-1}$  in  $\text{CHCl}_3$  : 3465, 1690, 1150

$^1\text{H}$  NMR (400 MHz,  $\text{CDCl}_3$ )  $\delta$  : 7.93 (d,  $J$  = 7.5 Hz, 2H) 7.66-7.54 (m, 3H) 4.64 (bs, 1H) 4.42 (bs, 1H) 4.23 (m, 1H) 3.11(s, 1H) 2.90 (d,  $J$  = 3.5 Hz, 1H) 2.11

	(m, 2H) 1.80 (m, 1H) 1.69-1.48 (m, 2H)
	1.39 (s, 9H)
$^{13}\text{C}$ NMR (100 MHz, $\text{CDCl}_3$ ) $\delta$	: 153.8, 137.4, 133.9, 129.0, 80.4, 76.6, 74.4, 71.9, 57.9, 30.3, 28.2, 20.2
Mass (ESI): $m/z$	: 376 ( $\text{M}^+\text{Na}$ ) 354 ( $\text{M}^+\text{H}$ )

### 15. Preparation of *tert*-butyl (1*S*,2*S*)-2-hydroxy-3-(phenylsulfonyl)cyclohex-3-enyl carbamate (**62**)

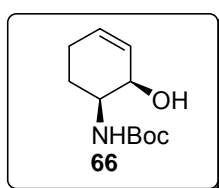


The solution of **58** (0.500 g, 1.41 mmol) in anhydrous THF (25 mL) was degassed by passing a slow stream of argon for 5-10 min. A THF-Toluene solution of methyl magnesium bromide (5.05 mL, 7.08 mmol) was added slowly to a stirred solution of compound portionwise at room temperature. The reaction mixture was then stirred for an additional 1.5 h and quenched with dilute HCl solution. After the usual workup with EtOAc the crude product was purified by column chromatography. Elution with hexane-ethyl acetate (7:3) gave **62** (0.400 g, 80%) as a crystalline solid and further elution with 1:1 hexane-ethyl acetate gave small amount of **58** (0.050 g).

mp	: 131-133 °C
$[\alpha]_D^{27}$	: -69.0 ( $c$ 1.0, $\text{CHCl}_3$ )
IR $\nu_{\text{max}}$ $\text{cm}^{-1}$ in $\text{CHCl}_3$	: 3441, 3372, 1713, 1676, 1150
$^1\text{H}$ NMR (400 MHz, $\text{CDCl}_3$ ) $\delta$	: 7.87-7.83 (m, 2H) 7.68-7.50 (m, 3H) 7.19 (dd, $J = 4.9, 2.5$ Hz) 5.20 (d, $J = 8.7$ Hz, 1H) 4.18 (m, 1H) 3.50 (m, 1H) 3.17 (s, 1H) 2.59-2.25 (m, 2H) 1.82-1.70 (m, 2H) 1.40 (s, 9H)

$^{13}\text{C}$ NMR (100 MHz, $\text{CDCl}_3$ ) $\delta$	:	155.2, 142.6, 140.6, 138.7, 133.7, 129.4, 127.9, 79.6, 62.71, 49.42, 28.36, 25.7, 22.1
Mass (ESI): $m/z$	:	354 ( $\text{M}^++\text{H}$ ), 369 ( $\text{NH}_4^++\text{M}$ )
Elemental Analysis	:	Anal. Calcd for $\text{C}_{17}\text{H}_{23}\text{NO}_5\text{S}$ : C, 57.77; H, 6.56; N, 3.96; S, 9.07 found : C, 57.46, H, 6.85; N, 3.72; S, 9.25

### 16. Preparation of (1*S*,2*R*)-2-hydroxycyclohex-3-enylcarbamate (**66**)

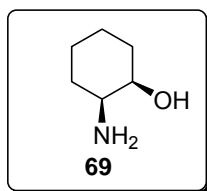


Sodium amalgam (6%, 4.00g) was added in portions over a period of 30 min. to a stirred and cooled solution of **62** (0.500 g, 1.41 mmol) in a 1:1 THF-MeOH mixture (15 mL) containing disodium hydrogen phosphate (5.70 g, 40.46 mmol) as a buffer. The reaction mixture was stirred at  $-6\text{ }^\circ\text{C}$  for 2 h and then quenched with dilute aqueous HCl. After being partitioned with ethyl acetate, the organic phase was worked up in the usual manner and the crude product was purified by column chromatography using pet ether-ethyl acetate (8:2) to elute **66** (0.241 g, 80%) as a colourless oil.

$[\alpha]_D^{31}$	:	-77.0 ( $c$ 1.0, $\text{CHCl}_3$ )
IR (neat) $\nu_{\text{max}}$ $\text{cm}^{-1}$	:	3405, 3301, 1708, 1682, 1150
$^1\text{H}$ NMR (200 MHz, $\text{CDCl}_3$ ) $\delta$	:	5.90-5.86 (m, 1H) 5.82-5.78 (m, 1H) 5.06 (s, 1H) 4.11 (m, 1H) 3.71 (m, 1H) 2.14 (m, 2H) 1.66-1.58 (m, 2H) 1.44 (s, 9H)
$^{13}\text{C}$ NMR (50 MHz, $\text{CDCl}_3$ ) $\delta$	:	155.6, 131.6, 127.3, 79.3, 65.3, 50.0, 28.4, 24.7, 23.56

Mass (ESI):  $m/z$  : 214 ( $M^+ + H$ ), 236 ( $M^+ + Na$ ), 252 ( $M^+ + K$ )

### 17. Preparation of (1*R*,2*S*)-2-aminocyclohexanol (**69**)



To a solution of **66** (0.050 g, 0.234 mmol) in methanol (2 mL) 10 mol% Pd/C (0.005 g) was added and stirred for 6 h at room temperature. After complete disappearance of starting, the content was filtered through whatmann filter paper. The removal of solvent under reduced pressure yielded the residue (0.047 g, 95%) which was treated with trifluoroacetic acid (0.048 mL, 6.55 mmol) in  $CH_2Cl_2$  (2 mL). After stirring the reaction mixture for 5 h, the solvent was completely evaporated which gave **69** (0.022 g, 90%) as a crystalline solid.

mp : 85 °C

$[\alpha]_D^{23}$  : -23.5 ( $c$  0.50, MeOH)

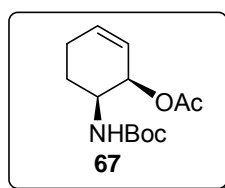
IR  $\nu_{max}$   $cm^{-1}$  in  $CHCl_3$  : 3400, 3300

$^1H$  NMR (400 MHz,  $CDCl_3$ )  $\delta$  : 3.98 (m, 1H) 3.25 (m, 1H) 1.72-1.28 (m, 8H)

$^{13}C$  NMR (100 MHz,  $CDCl_3$ )  $\delta$  : 65.9, 52.5, 30.1, 24.6, 22.1, 18.8

Mass (ESI):  $m/z$  : 116 ( $M^+ + H$ )

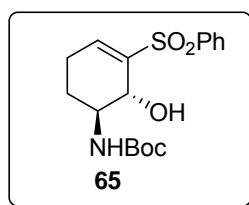
### 18. Preparation of (1*R*,6*S*)-6-(*tert*-butoxycarbonylamino)cyclohex-2-enyl acetate (**67**)



To a stirred and cooled solution of **66** (0.100 g, 0.469 mmol) in CH<sub>2</sub>Cl<sub>2</sub> (3 mL) was added pyridine (0.075 mL, 0.938 mmol) and acetyl chloride (0.066 mL, 0.938 mmol). After stirring the reaction mixture at room temperature for 16 h, it was diluted with CH<sub>2</sub>Cl<sub>2</sub> and washed with saturated sodium carbonate solution. The solvent was removed in vacuo and the residue was purified by column chromatography to give **67** (0.095 g, 80%) as a crystalline solid.

mp	:	66 °C
[α] <sup>25</sup> <sub>D</sub>	:	-132.9 (c 1.0, CHCl <sub>3</sub> )
IR ν <sub>max</sub> cm <sup>-1</sup> in CHCl <sub>3</sub>	:	3440, 1706, 1145
<sup>1</sup> H NMR (200 MHz, CDCl <sub>3</sub> ) δ	:	5.92 (m, 1H) 5.77 (m, 1H) 5.19 (m, 1H) 4.72 (m, 1H) 3.91 (m, 1H) 2.16 (bs, 2H) 1.77-1.71 (m, 2H) 1.43 (s, 9H)
<sup>13</sup> C NMR (125 MHz, CDCl <sub>3</sub> ) δ	:	170.3, 155.2, 132.8, 124.0, 79.5, 68.5, 47.8, 29.6, 28.3, 24.3, 21.1
Mass (ESI): <i>m/z</i>	:	256 (M <sup>+</sup> +H), 278 (M <sup>+</sup> +Na), 294 (M <sup>+</sup> +K)
Elemental Analysis	:	Anal. Calcd for C <sub>13</sub> H <sub>21</sub> NO <sub>4</sub> : C, 61.16; H, 8.29; N, 5.49; found C, 60.79; H, 8.07; N, 5.20;

### 19. Preparation of *tert*-butyl (1*S*,2*R*)-2-hydroxy-3-(phenylsulfonyl)cyclohex-3-enylcarbamate (**65**)

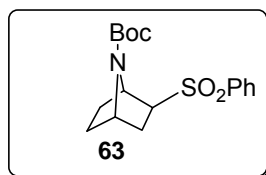


This compound was prepared by the same method described for the synthesis of **62** except that the reaction was stirred for 4 h.

mp	:	125 °C
[α] <sup>22</sup> <sub>D</sub>	:	+14.6 (c 0.4, CHCl <sub>3</sub> )

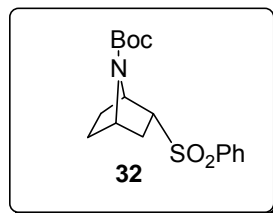
IR $\nu_{\max}$ $\text{cm}^{-1}$ in $\text{CHCl}_3$	:	3440, 1710, 1681, 1140
$^1\text{H}$ NMR (400 MHz, $\text{CDCl}_3$ ) $\delta$	:	7.93-7.88 (m, 2H) 7.61-7.50 (m, 3H) 7.19 (m, 1H) 4.31(bs, 2H) 3.84 (bs, 1H) 3.18 (s, 1H) 2.49-2.27 (m, 2H) 2.06-1.99 (m, 1H) 1.72-1.66 (m, 1H) 1.32 (s, 9H)
$^{13}\text{C}$ NMR (100 MHz, $\text{CDCl}_3$ ) $\delta$	:	155.3, 141.6, 133.4, 129.1, 128.0, 80.0, 65.7, 50.3, 29.6, 28.2, 22.5
Mass (ESI): $m/z$	:	369 ( $\text{M}^+ + \text{NH}_4^+$ ), 354 ( $\text{M}^+ + \text{H}$ )

## 20. Preparation of *tert*-butyl 2-(phenylsulfonyl)-7-azabicyclo[2.2.1]heptane-7-carboxylate (**63**)



A mixture of **31** (1.0 g, 2.98 mmol) and sodium borohydride (0.90 g, 23.8 mmol) in methanol (60 mL) was stirred at 0 °C for 3 h. The reaction mixture was made acidic with dilute HCl solution. The solvent was removed in vacuo and ethyl acetate was added to the residue. After the usual workup, the product mixture was separated into its component by column chromatography, using pet-ether: AcOEt mixtures (4:1 and then 1:1) to elute the less polar *endo*-sulfone **32** (0.11 g, 13%) and then more polar *exo*-sulfone **63** (0.78 g, 87%) both as a white crystalline solid.

mp	:	101-103 °C
$^1\text{H}$ NMR (200 MHz, $\text{CDCl}_3$ ) $\delta$	:	7.87 (d, $J = 7.2$ Hz, 2H) 7.64-7.46 (m, 3H) 4.52 (m, 1H) 4.21 (bs, 1H) 4.21 (bs, 1H) 3.18 (dd, $J = 8.8, 5.4$ Hz, 1H) 2.22-2.15 (m, 1H) 1.81-1.70 (m, 3H) 1.37 (s, 9H)
$^{13}\text{C}$ NMR (50 MHz, $\text{CDCl}_3$ ) $\delta$	:	153.6, 137.6, 133.7, 129.0, 79.9, 67.1, 57.0, 55.2, 32.8, 29.6, 29.0, 28.2

**21. Preparation of *tert*-butyl 2-(phenylsulfonyl)-7-azabicyclo[2.2.1]heptane-7-carboxylate (32)**

To a solution of **63** (0.030 g, 0.10 mmol) in anhydrous THF (3 mL) was added LiHMDS ( ) at  $-78^{\circ}\text{C}$  while stirring the reaction mixture for 1h. The reaction mixture was warmed to rt and stirred for 45 min. The reaction mixture was quenched with adding aqueous  $\text{NH}_4\text{Cl}$  and extracted with AcOEt several times. The combined organic layer was dried over  $\text{Na}_2\text{SO}_4$  and concentrated in vacuo and purified by column chromatography to give **32** (0.024 g, 80%) as a white solid.

mp : 81-83  $^{\circ}\text{C}$

$^1\text{H}$  NMR (400 MHz,  $\text{CDCl}_3$ )  $\delta$  : 7.89 (m, 3H) 7.69-7.51 (m, 3H) 4.35-4.26 (m, 2H) 3.61-3.50 (m, 1H) 2.57-2.44 (m, 1H) 2.04-1.60 (m, 5H) 1.39 (s, 9H)

**X-ray Crystal Data for compound 67**

Single crystals of the compound were grown by slow evaporation of the solution mixture in pet. ether and DCM. Colourless crystal of approximate size 0.21 x 0.19 x 0.01 mm, was used for data collection on *Bruker SMART APEX* CCD diffractometer using Mo K $\alpha$  radiation with fine focus tube with 50kV and 30mA.  $\theta$  range 2.42 to 23.49 °, SADABS correction applied.

**Table 3.** Crystal data and structure refinement for **67**.

Empirical formula	C <sub>13</sub> H <sub>21</sub> N O <sub>4</sub>
Formula weight	255.31
Temperature	295(2) K
Wavelength	0.71073 Å
Crystal system, space group	Orthorhombic, P2 <sub>1</sub> 2 <sub>1</sub> 2
Unit cell dimensions	a = 8.7476(6) Å    alpha = 90 deg. b = 30.920(2) Å    beta = 90 deg. c = 5.2675(4) Å    gamma = 90 deg.
Volume	1424.74(18) Å <sup>3</sup>
Z, Calculated density	4, 1.190 Mg/m <sup>3</sup>
Absorption coefficient	0.088 mm <sup>-1</sup>
F(000)	552
Crystal size	0.21 x 0.19 x 0.01 mm
Theta range for data collection	2.42 to 23.49 deg.
Limiting indices	-9 ≤ h ≤ 9, -34 ≤ k ≤ 29, -5 ≤ l ≤ 5
Reflections collected / unique	9910 / 2107 [R(int) = 0.0614]
Completeness to theta = 23.49	99.8 %
Max. and min. transmission	0.9989 and 0.9817



Refinement method	Full-matrix least-squares on F <sup>2</sup>
Data / restraints / parameters	2107 / 0 / 167
Goodness-of-fit on F <sup>2</sup>	1.328
Final R indices [I > 2σ(I)]	R1 = 0.0888, wR2 = 0.1827
R indices (all data)	R1 = 0.0989, wR2 = 0.1867

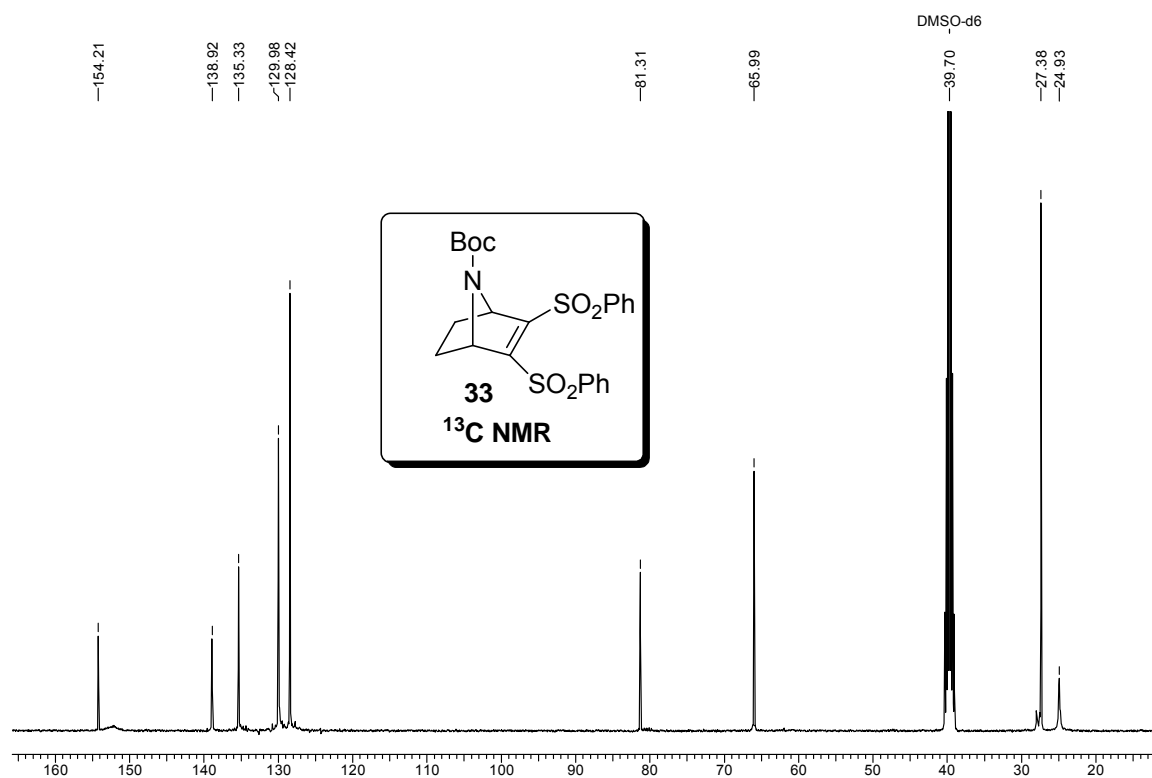
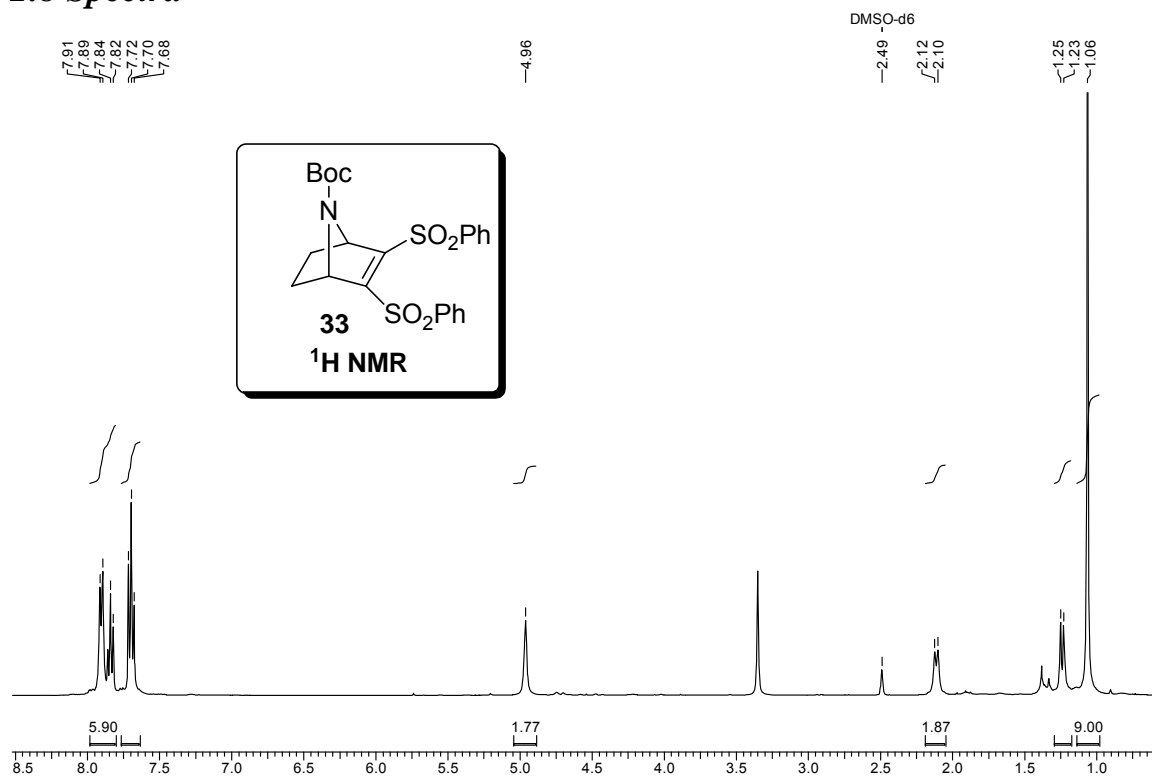
## Reference:

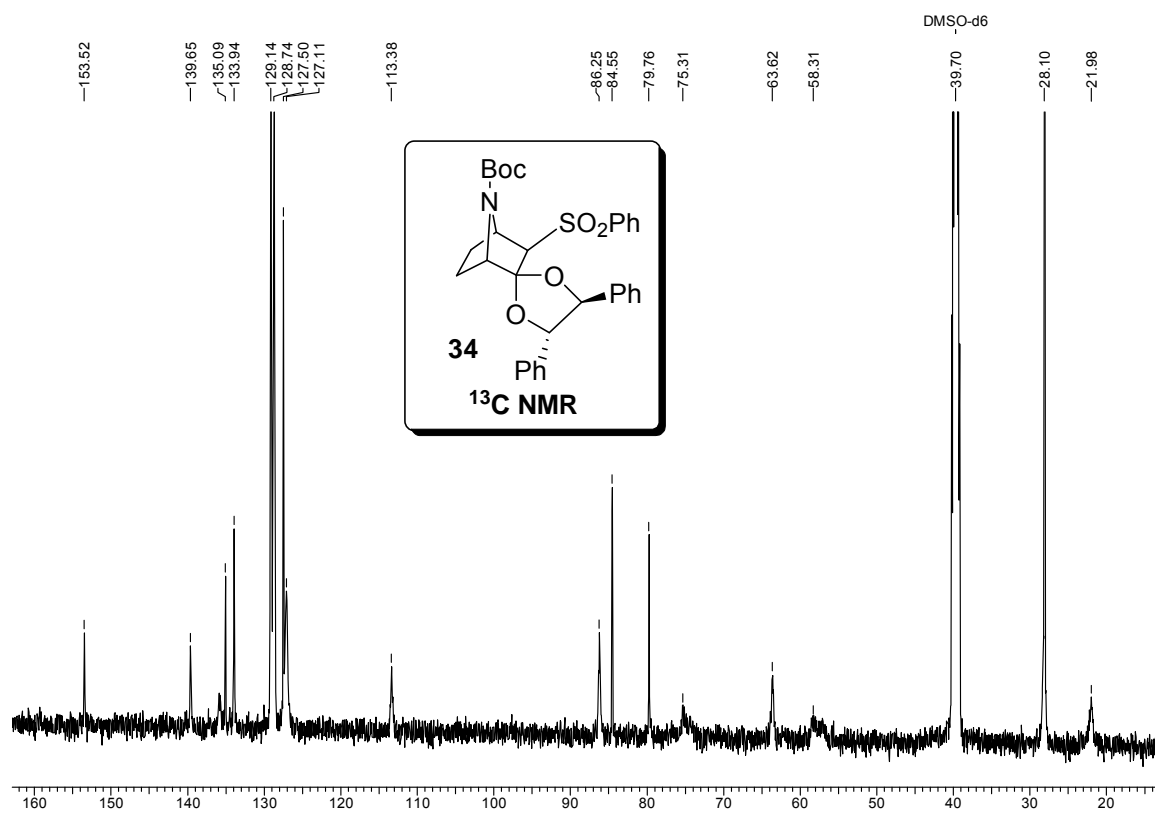
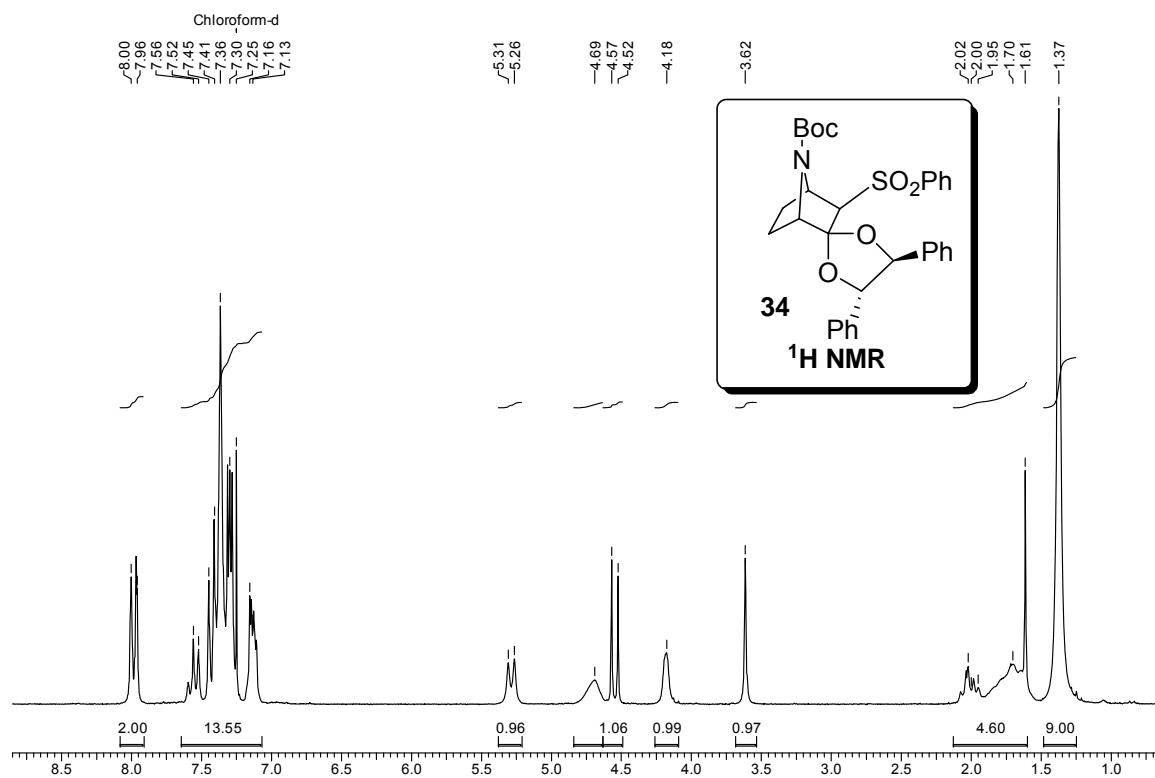
G. M. Sheldrick, SHELX-97 program for crystal structure solution and refinement,  
University of Gottingen, Germany, 19

## 2.7 References

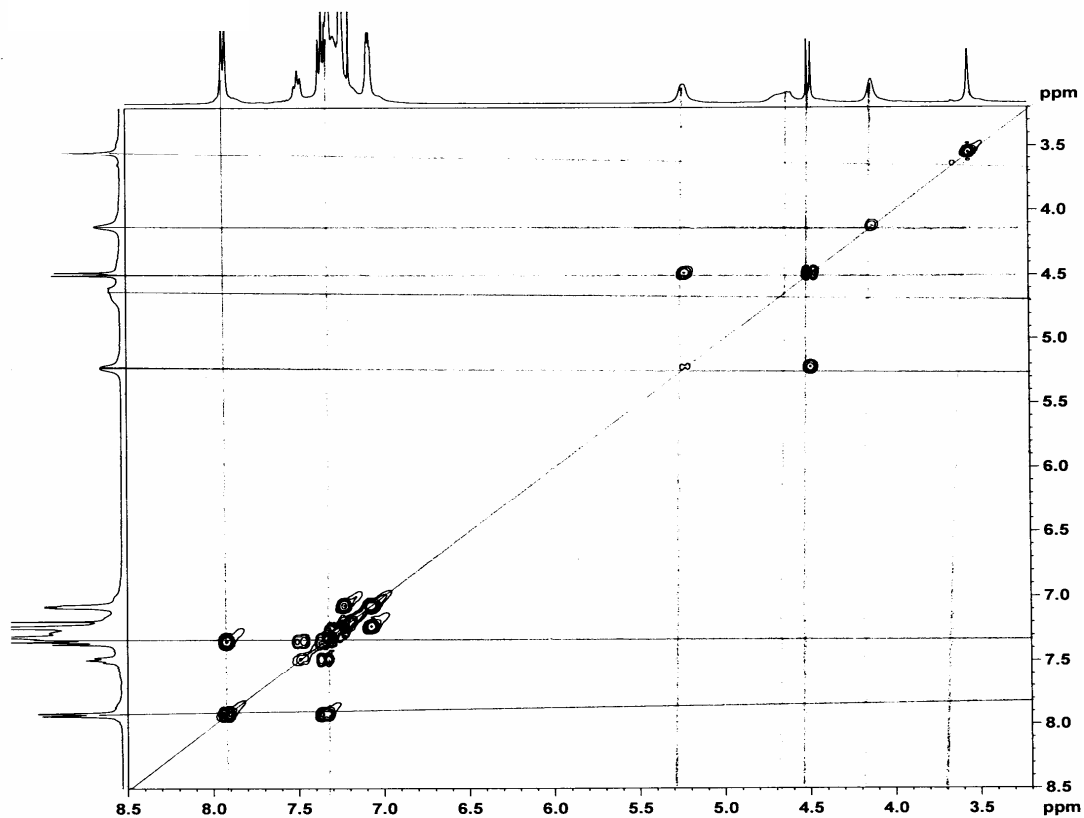
1. (a) Schiffers, I.; Rantanen, T.; Schmidt, F.; Bergmans, W.; Zani, L.; Bolm, C. *J. Org. Chem.* **2006**, *71*, 2320. (b) Parrodi, C. A.; Juaristi, E. *Synlett*, **2006**, 2699.
2. (a) Ager, D.; Prakash, I.; Schaad, D. R. *Chem. Rev.* **1996**, *96*, 8350.  
(b) Bergmeier, S. C. *Tetrahedron* **2000**, *56*, 2561.
3. Jog, G. J.; Igarashi, J.; Suga, H. *Chem. Bio.* **2006**, *13*, 123.
4. (a) Overmann, L. E.; Sugai, S. *J. Org. Chem.* **1985**, *50*, 4154.  
(b) Sosa-Rivadeneira, M.; Munoz-Muniz, O.; Anaya de Parrodi, C.; Quintero, L.; Juaristi, E. *J. Org. Chem.* **2003**, *68*, 2369.
5. Martinez, L. E.; Leighton, J. L.; Carsten, D. H.; Jacobsen, E. N. *J. Am. Chem. Soc.* **1995**, *117*, 5897.
6. Schneider, C.; Sreekanth, A. R.; Mai, E. *Angew. Chem. Int. Ed.* **2004**, *43*, 5691.
7. Miyano, S.; Lu, L. D.-L.; Viti, S. M.; Sharpless, K. B. *J. Org. Chem.* **1985**, *50*, 4350.
8. Pandey, G.; Bagul, T. D.; Sahoo, A. K.; *J. Org. Chem.* **1998**, *63*, 760.
9. Ramey, K.C.; Lini, D. C.; Moriarty, R. M.; Gopal, H.; Welsh, H. G. *J. Am. Chem. Soc.* **1967**, *89*, 2401.
10. Leung-Toung, R.; Liu, Y.; Muchowski, J. M.; Wu, Y-L. *J. Org. Chem.* **1998**, *63*, 3235.

## 2.8 Spectra

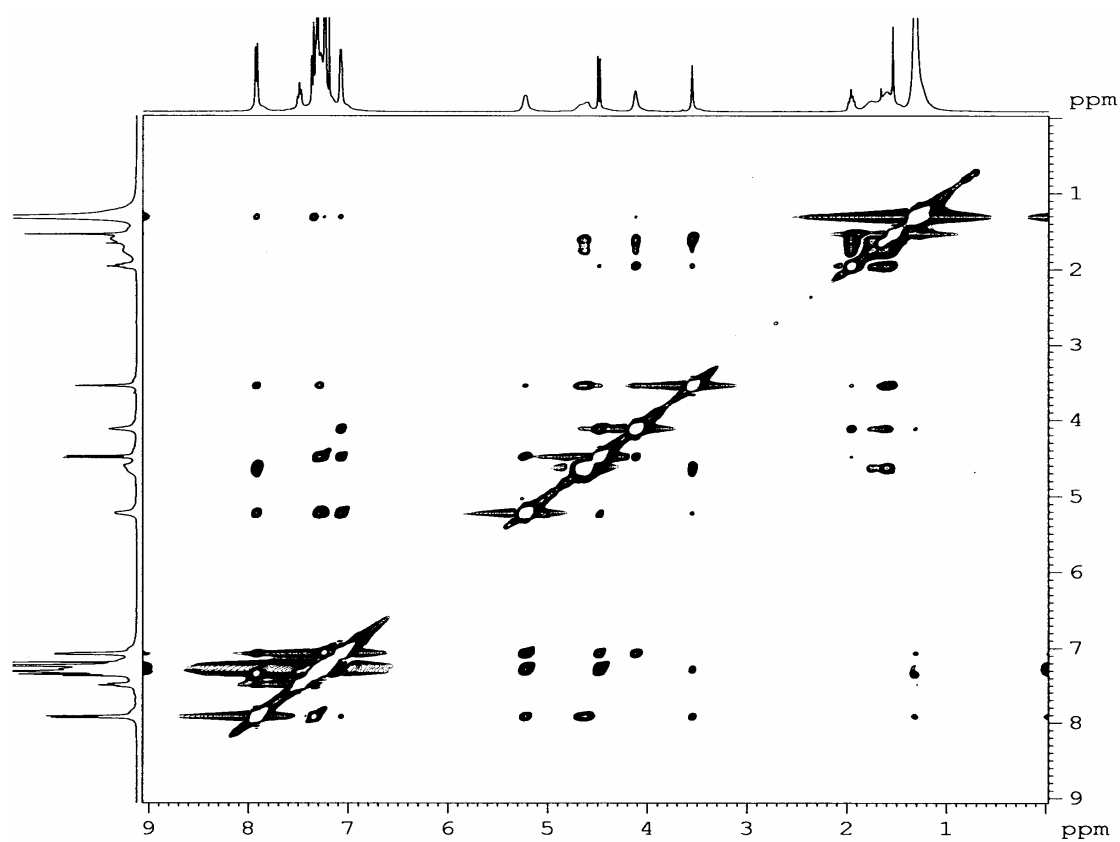


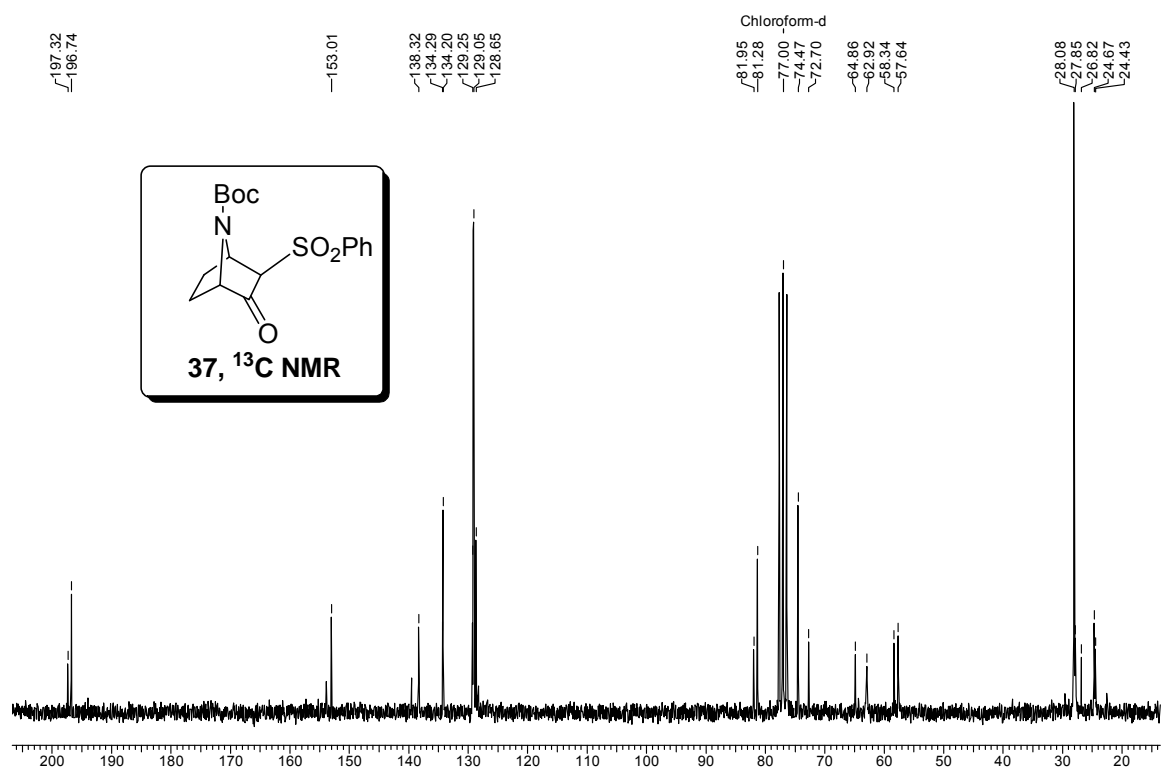
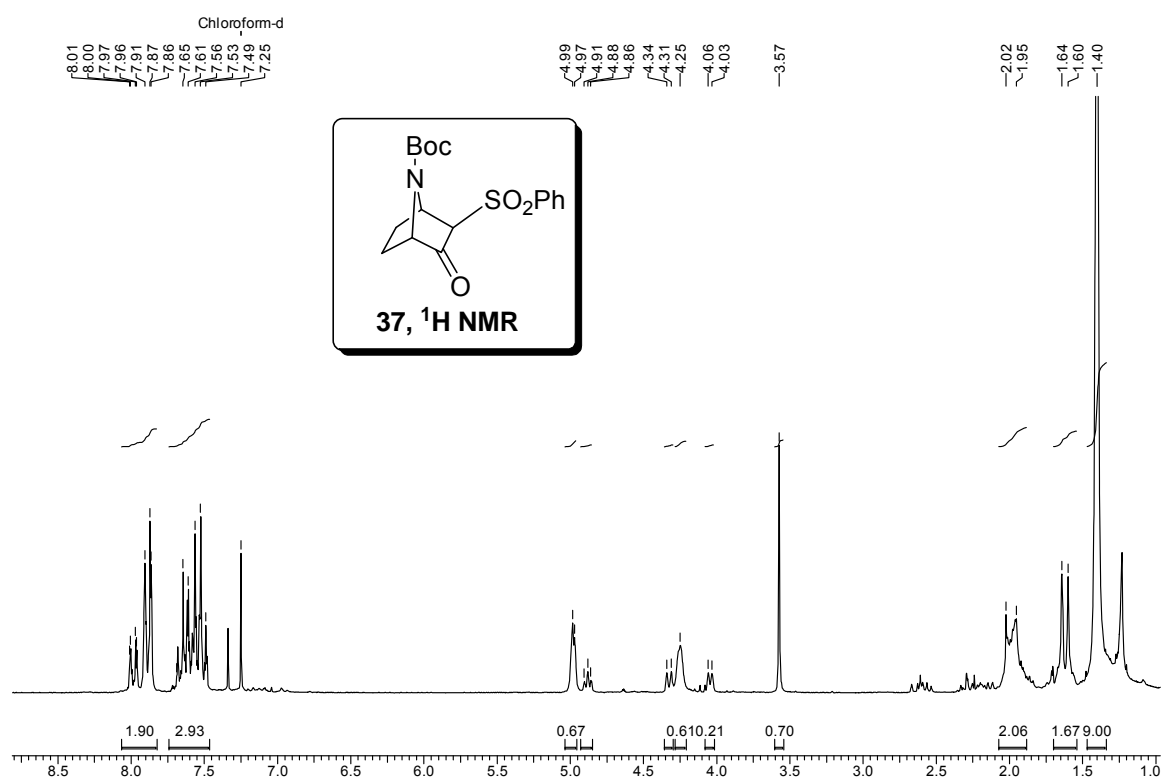


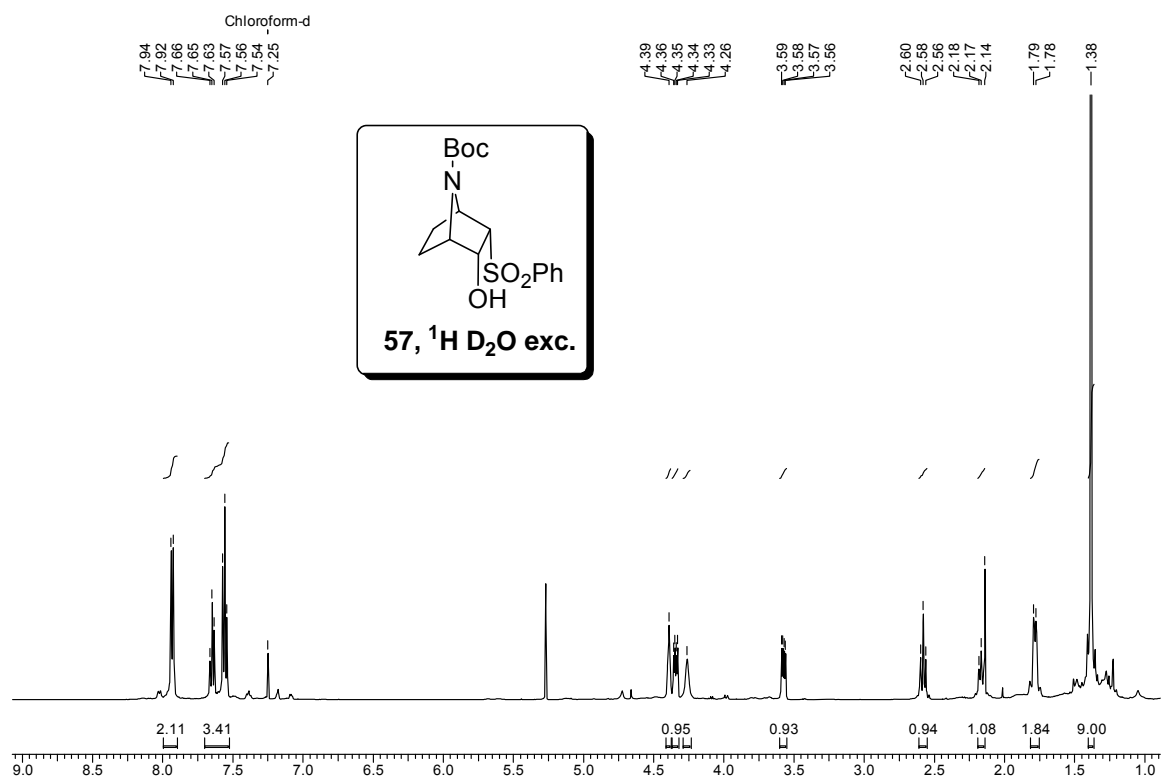
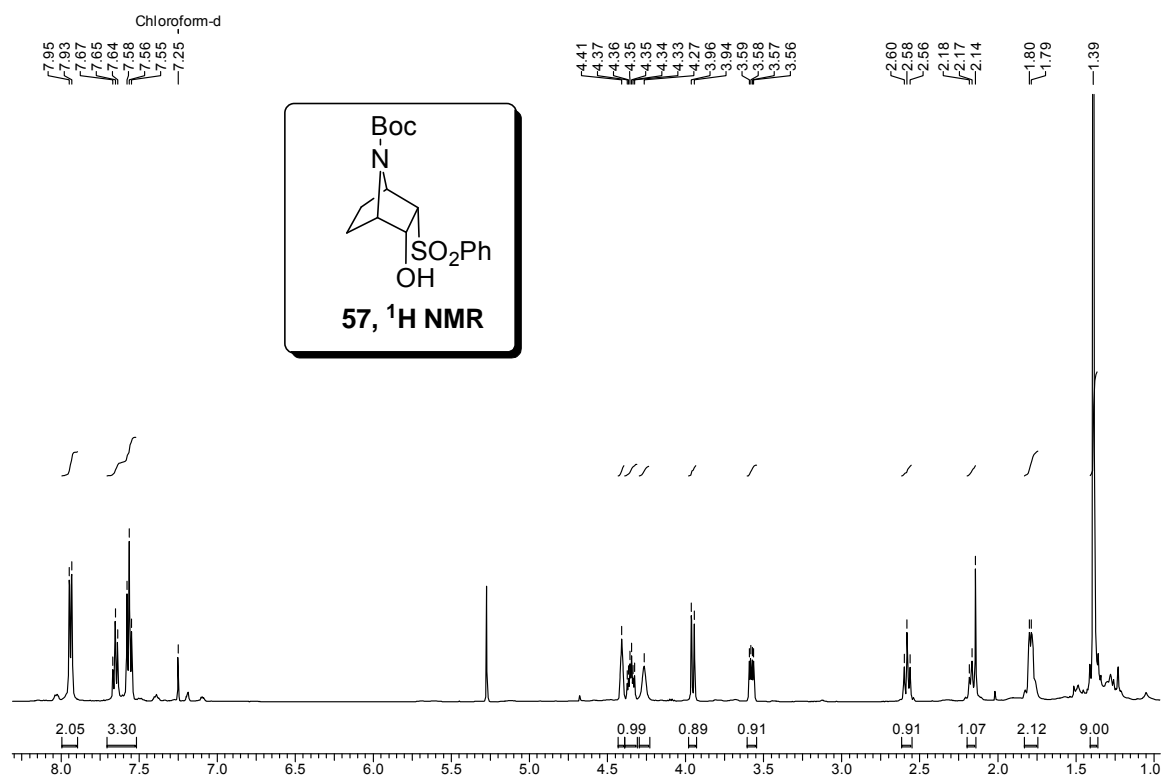
COSY of 34

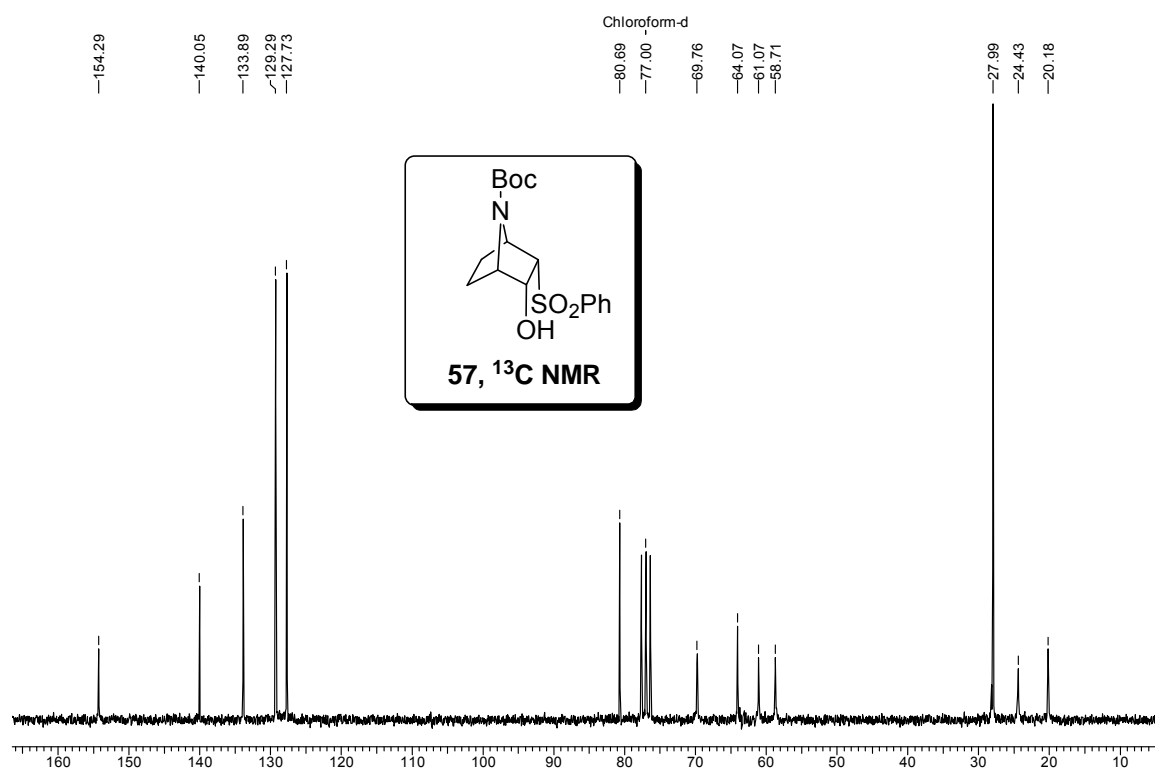


NOESY of 34

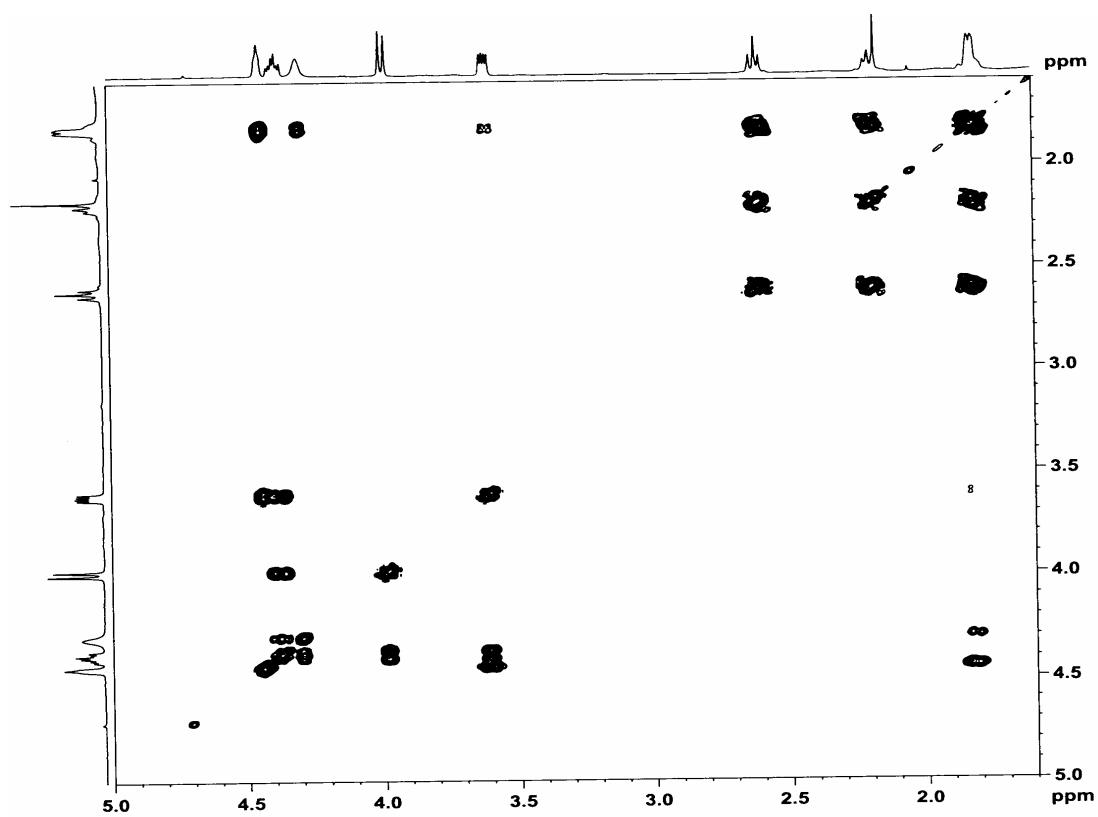






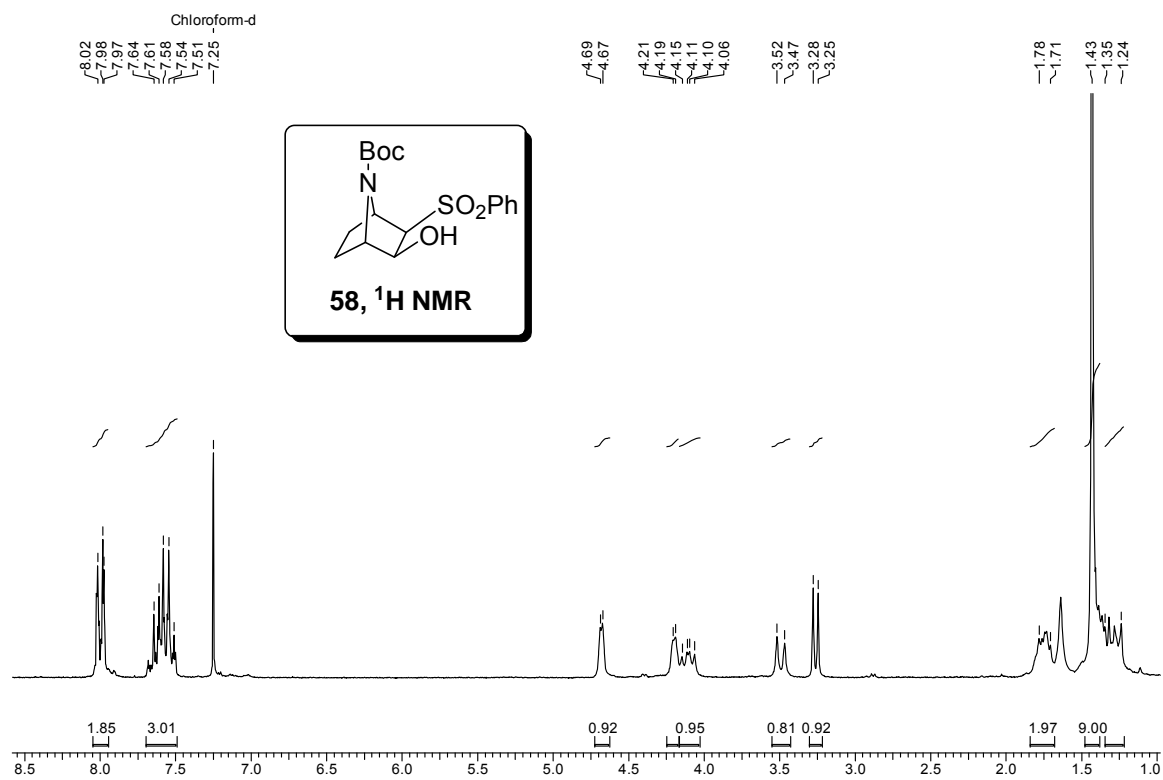
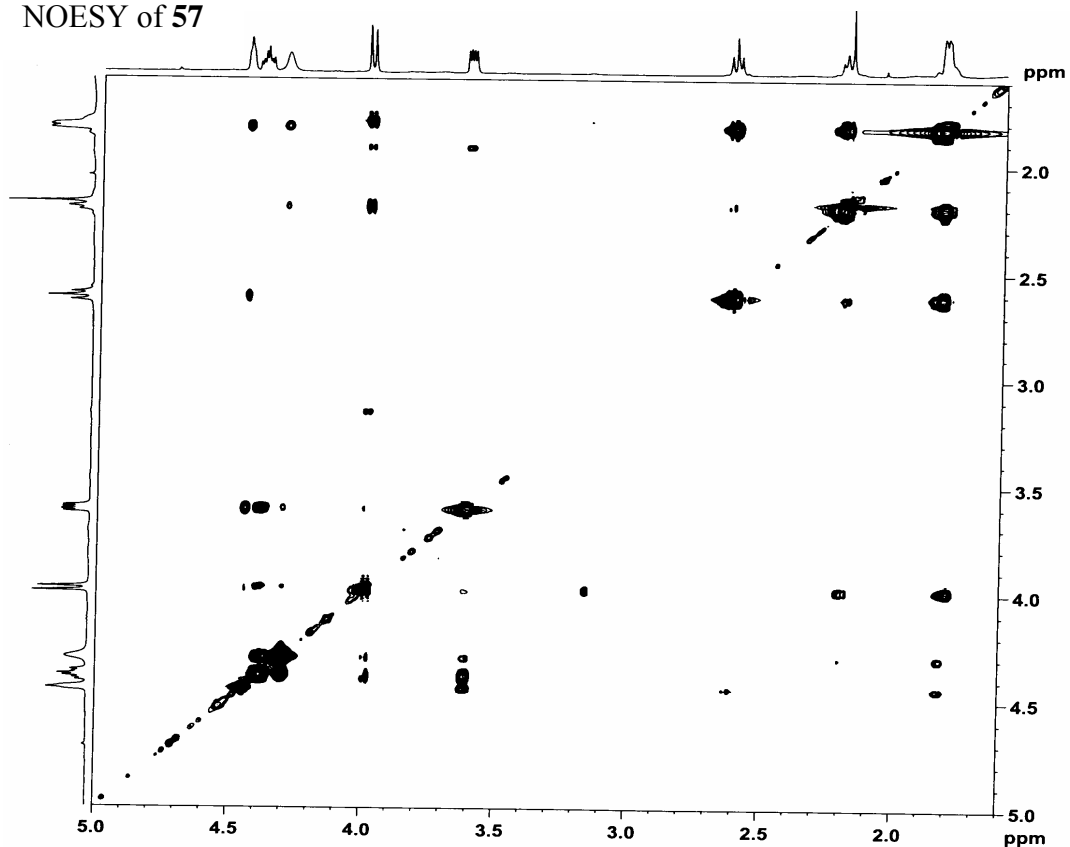


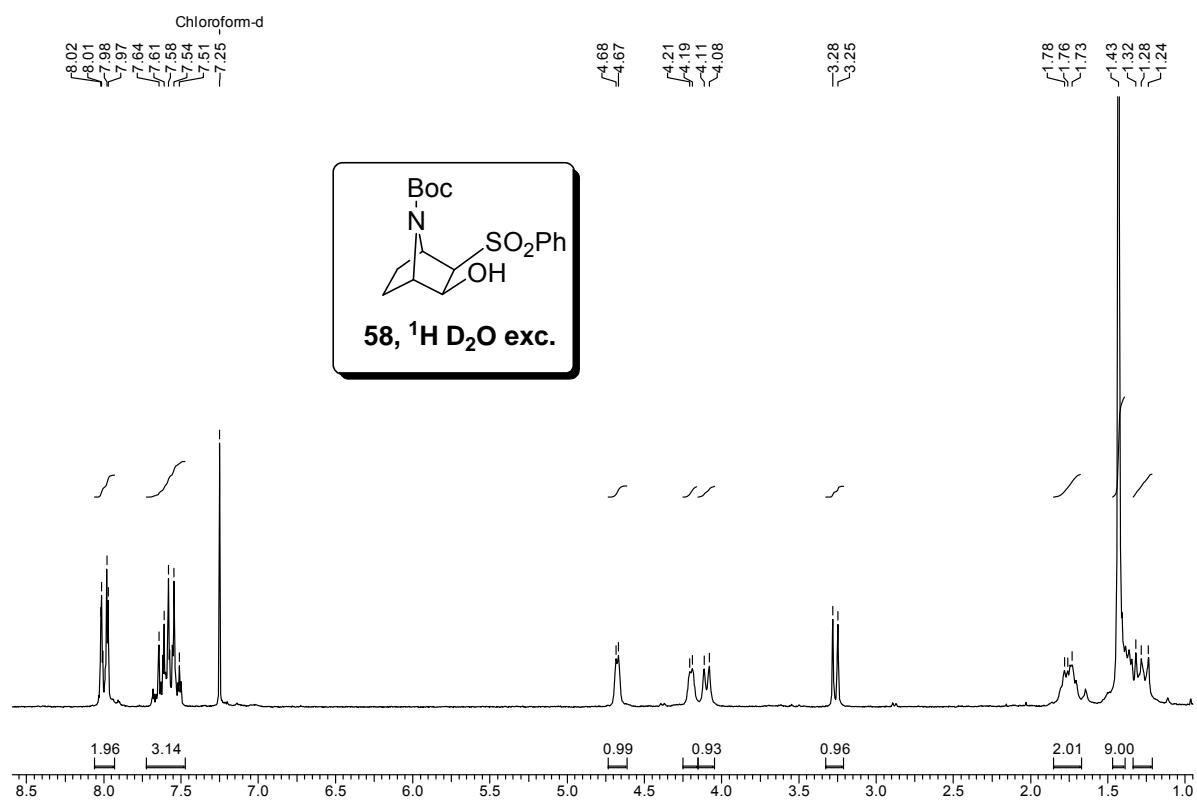
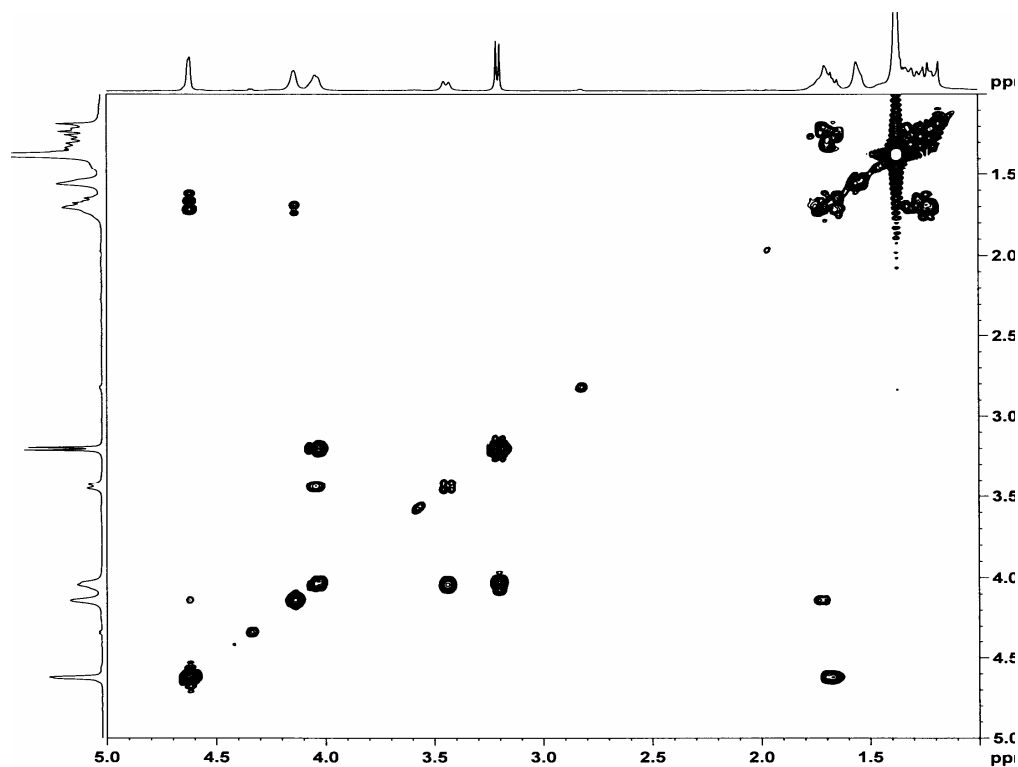
COSY of 57



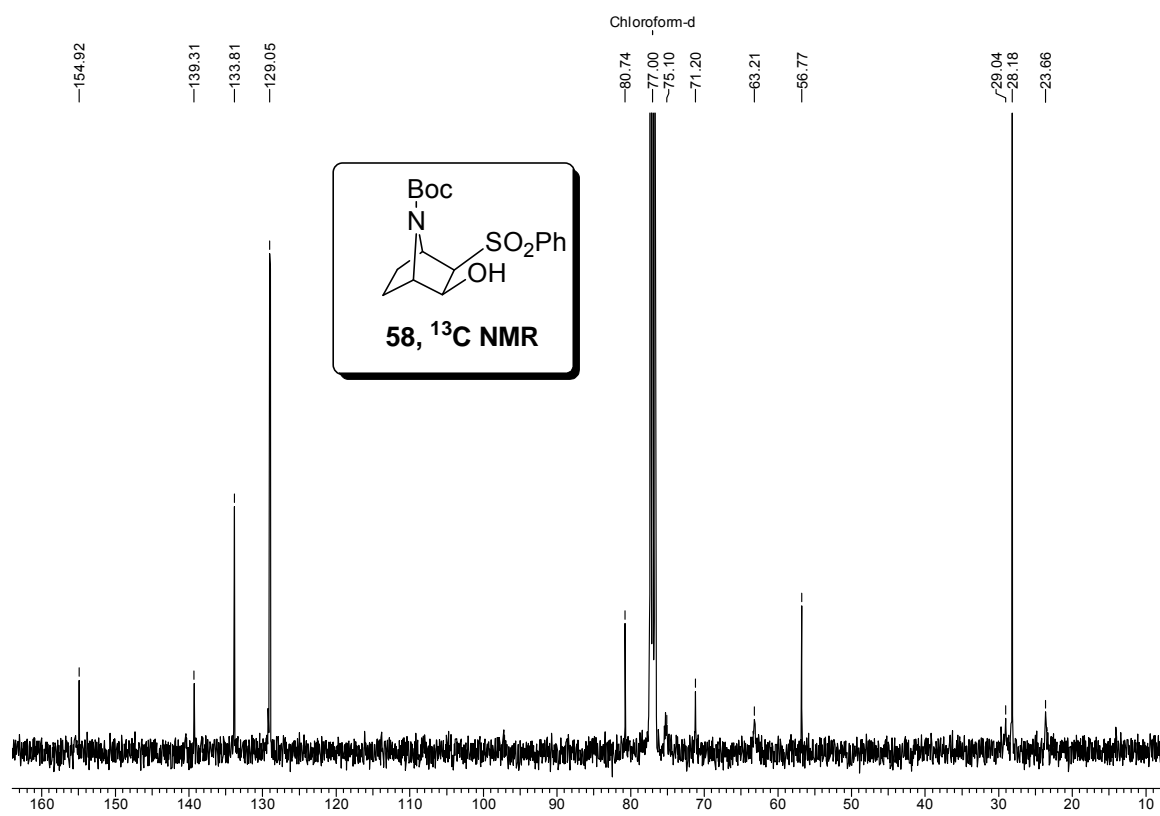
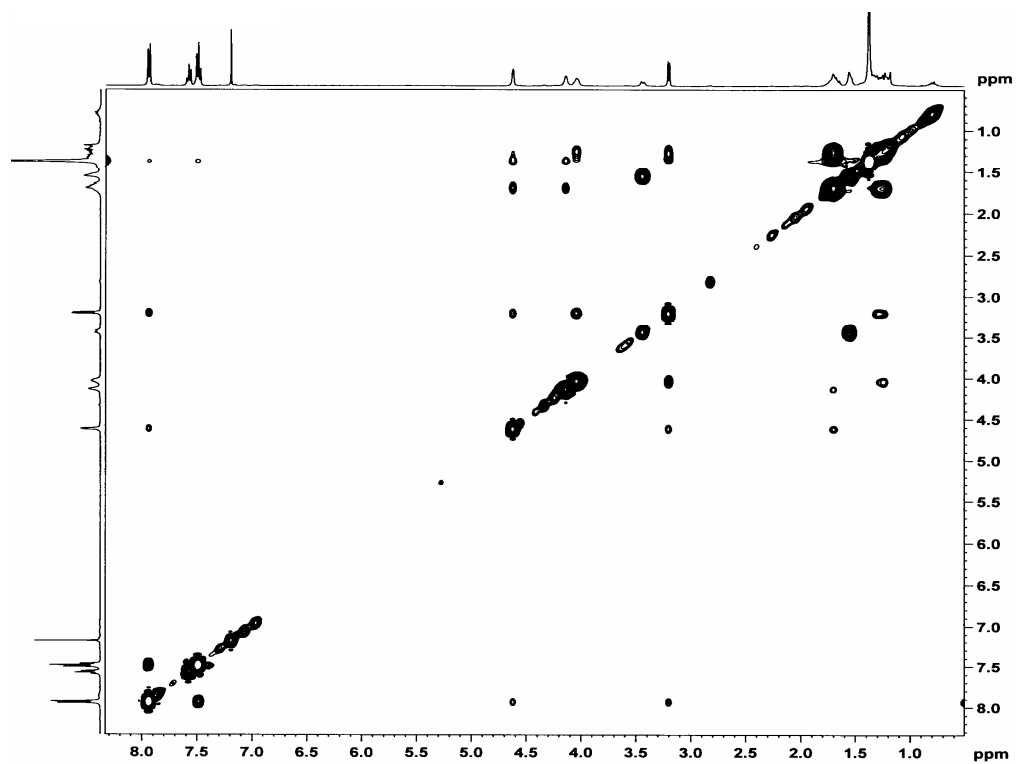


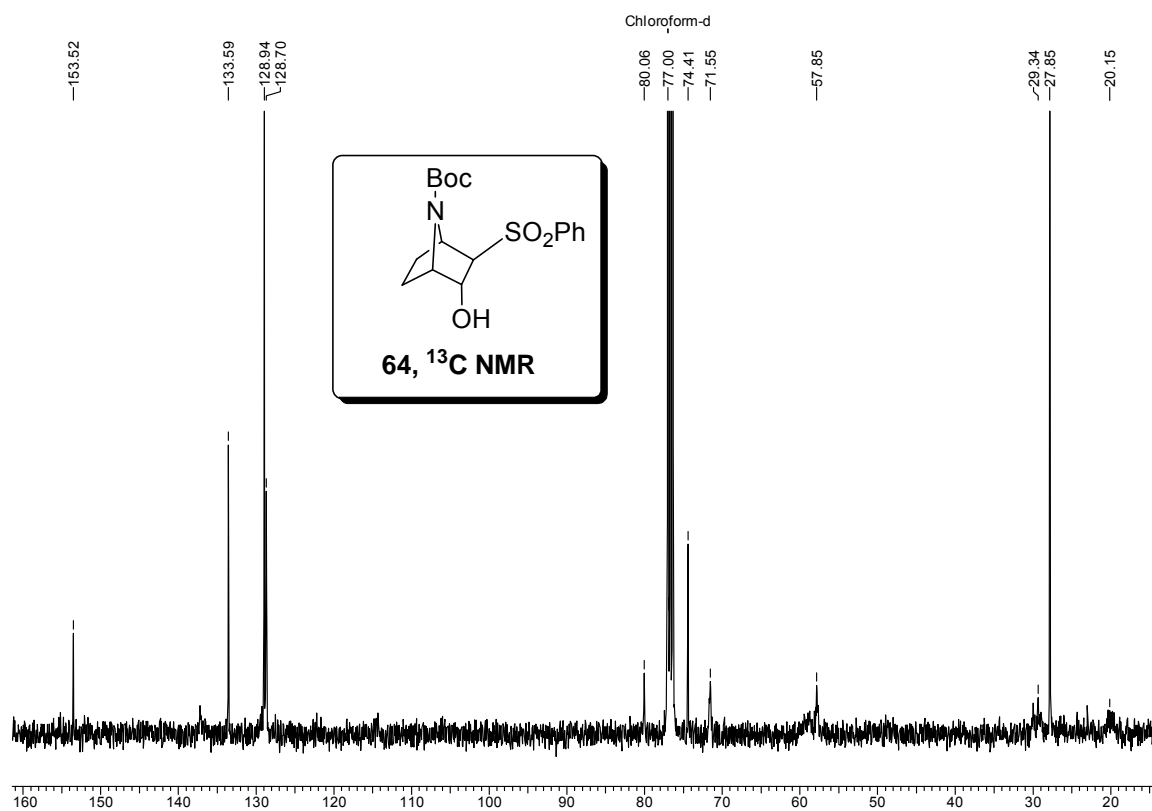
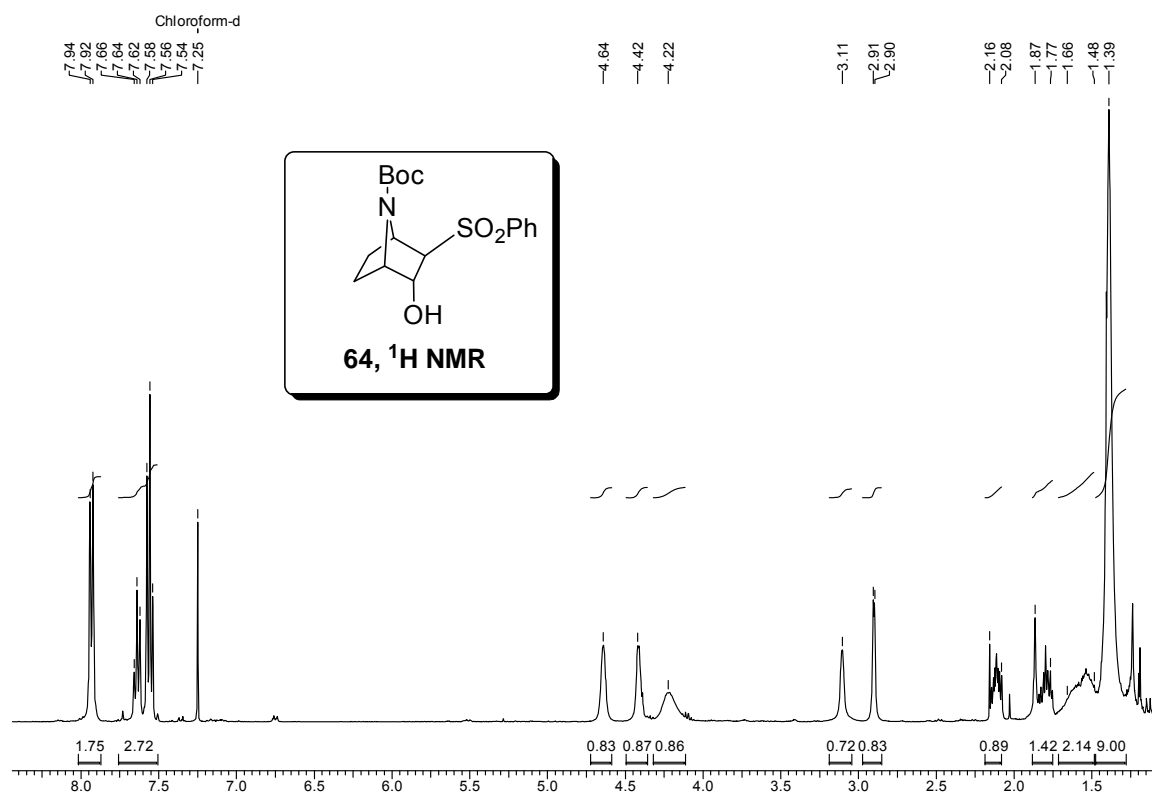
NOESY of 57

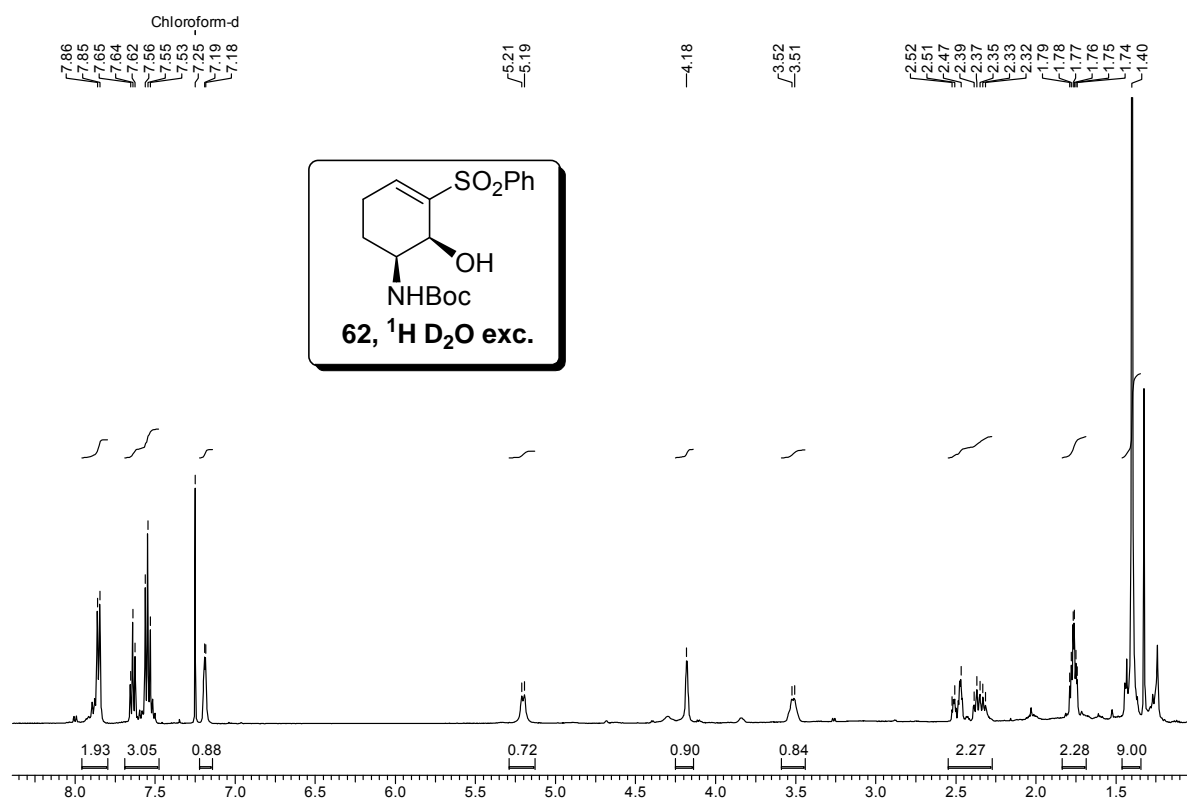
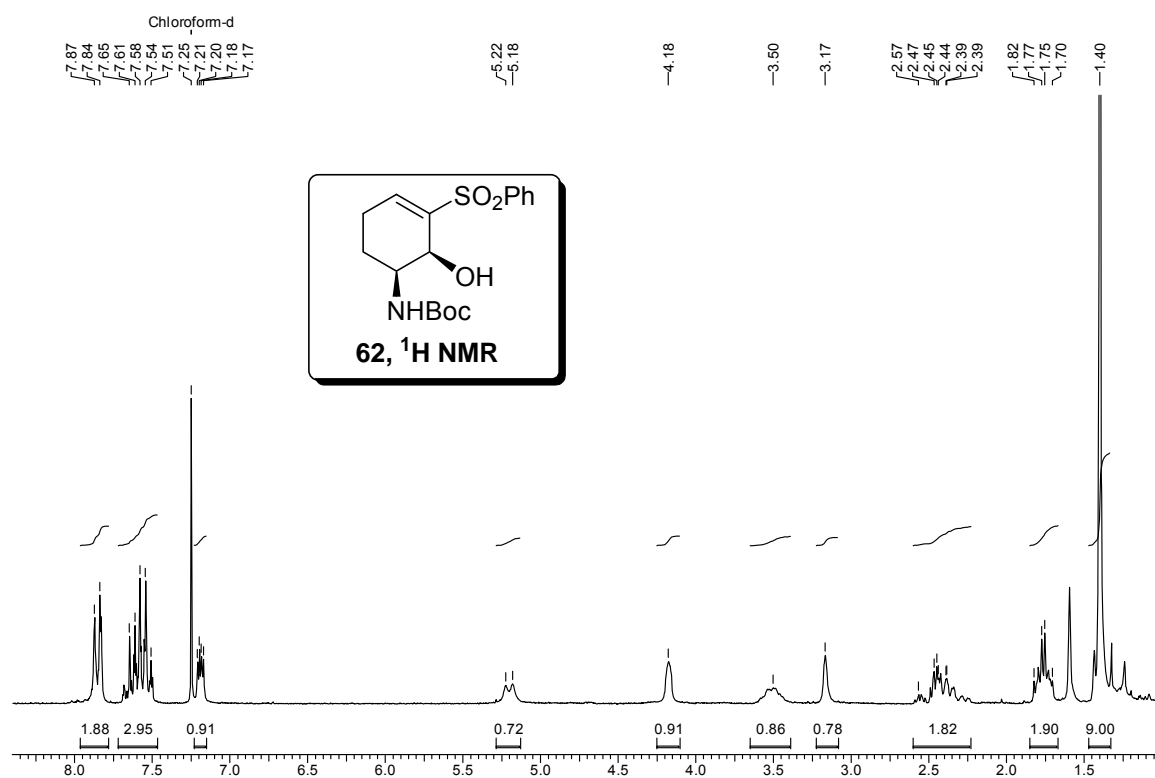


COSY of **58**

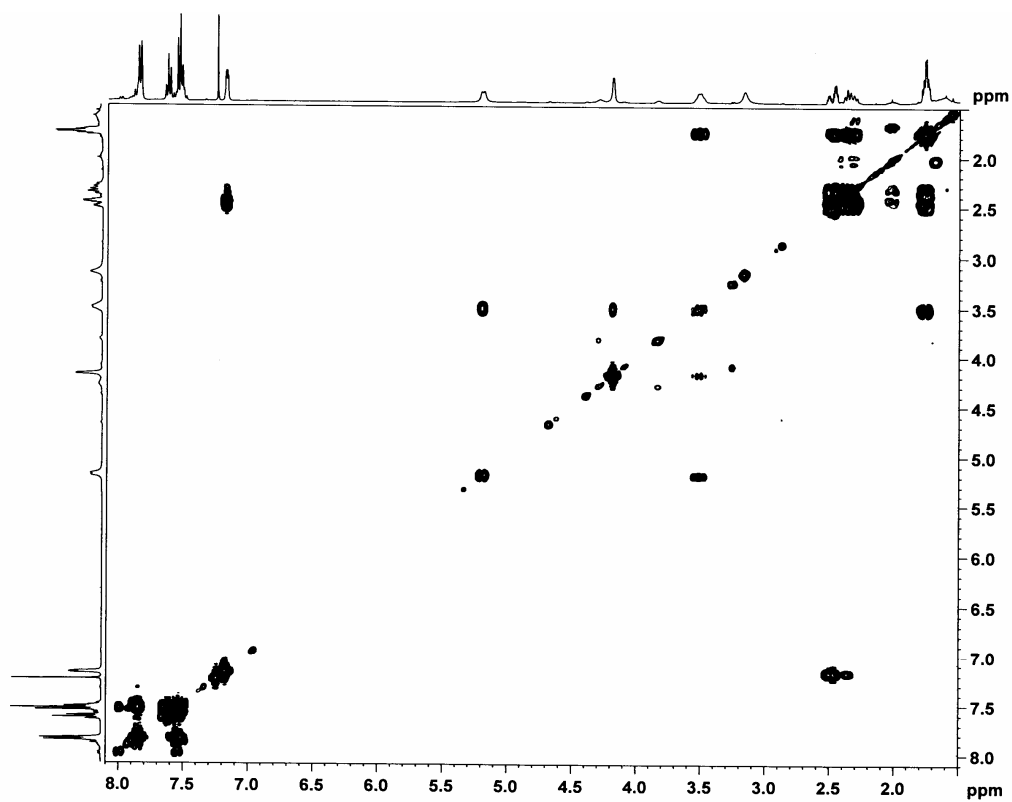
## NOESY of 58



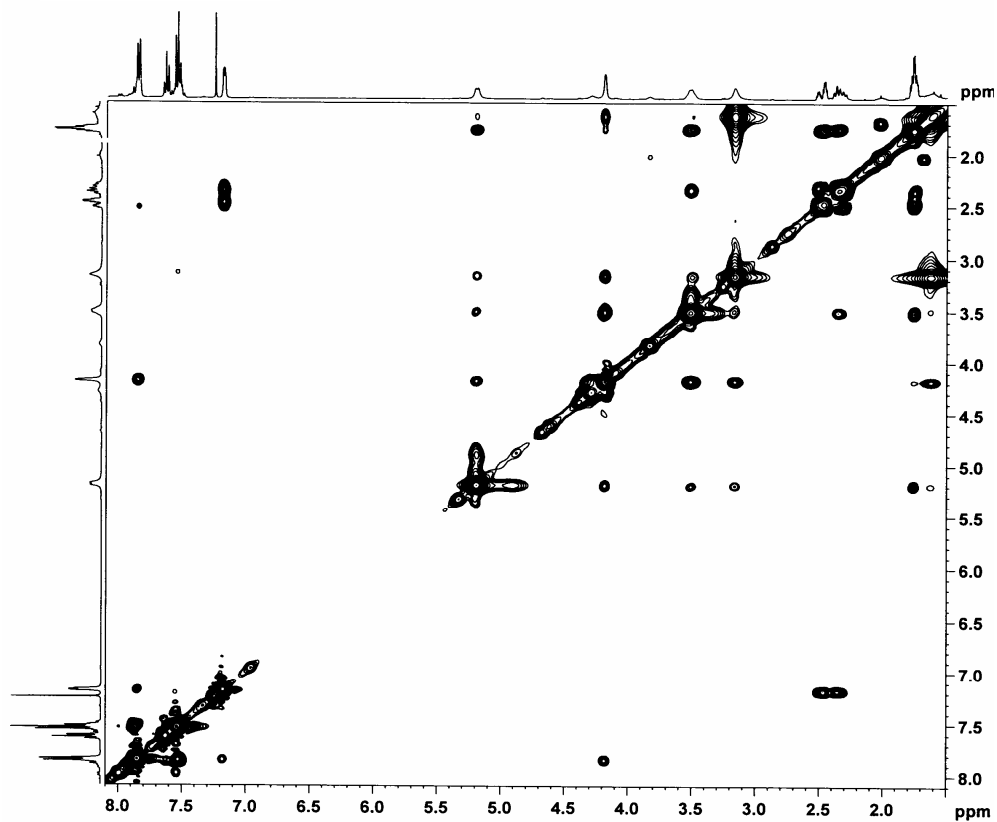


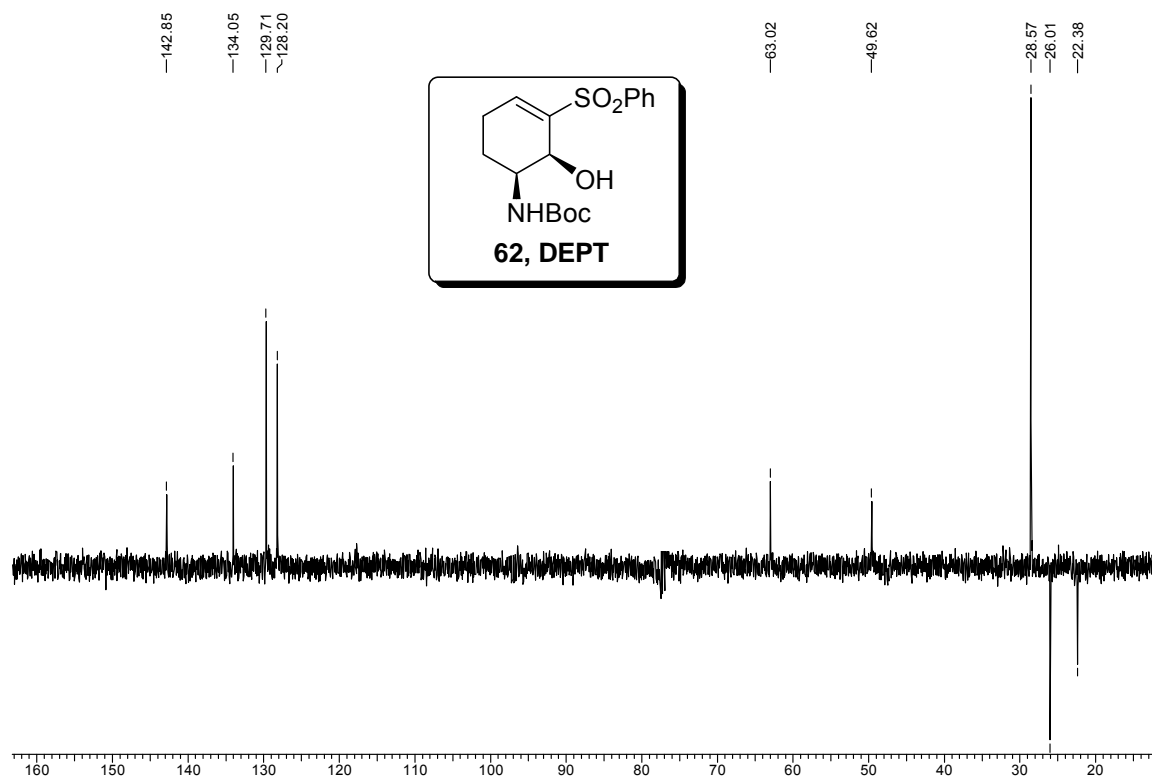
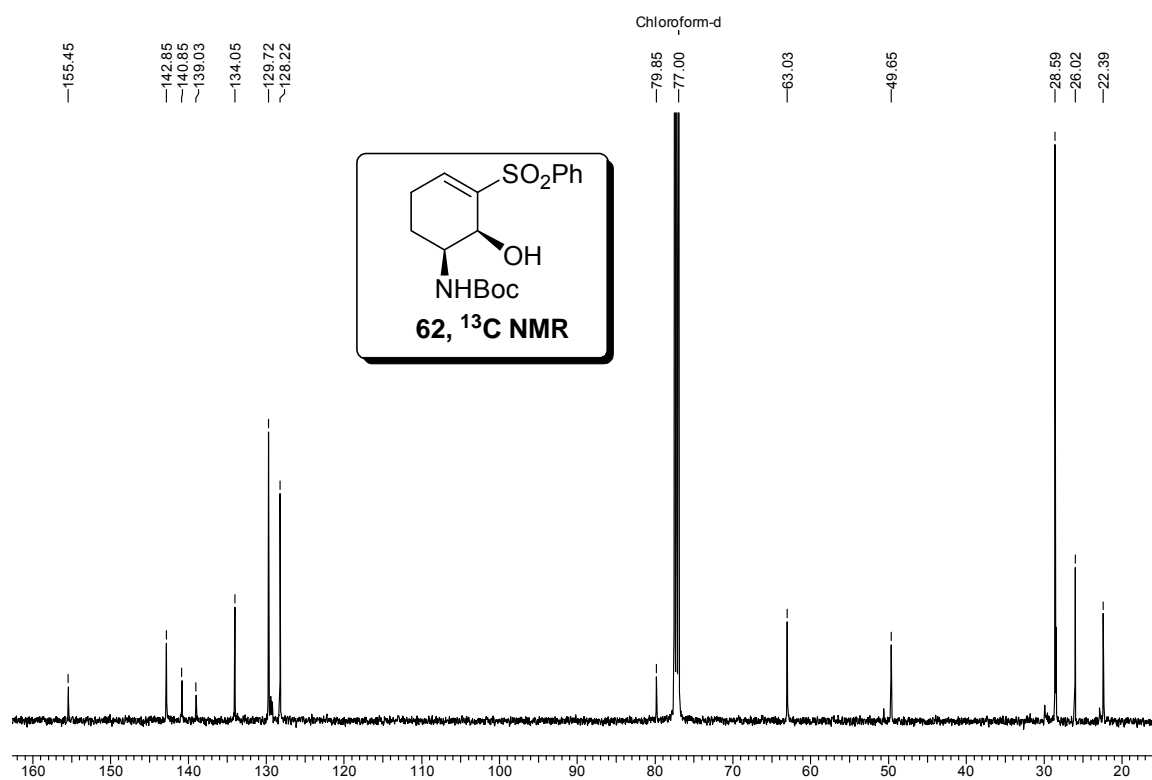


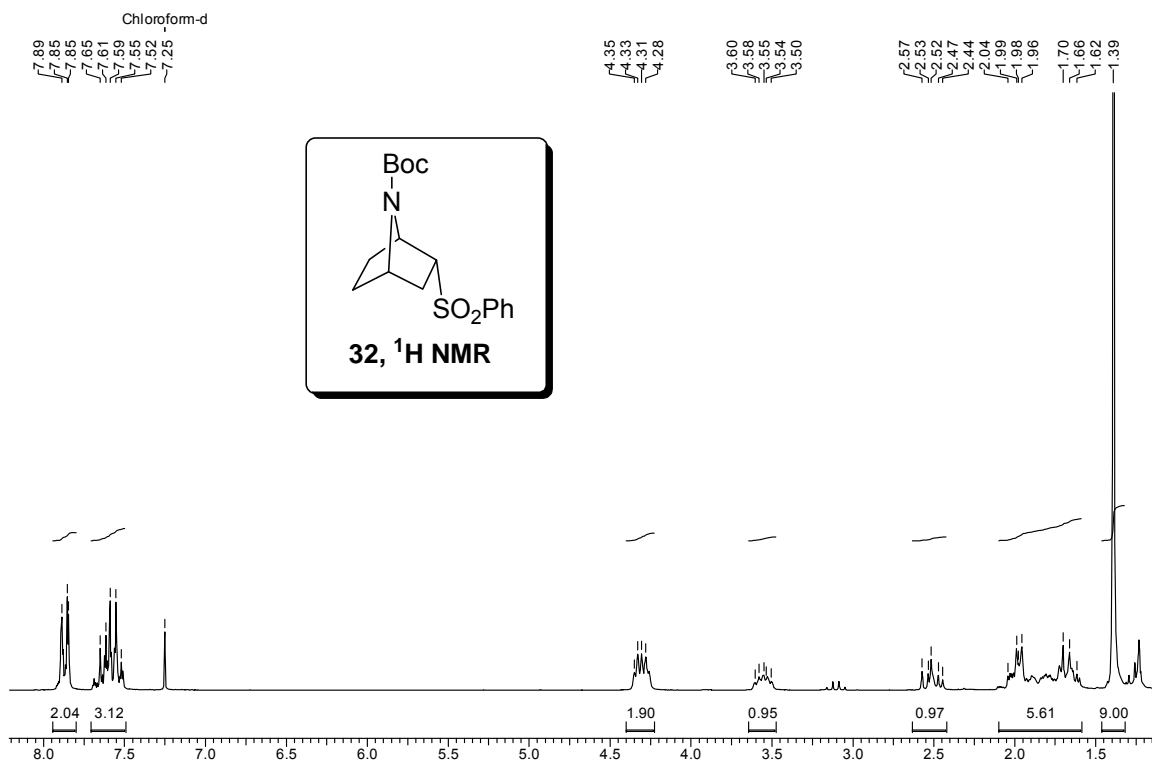
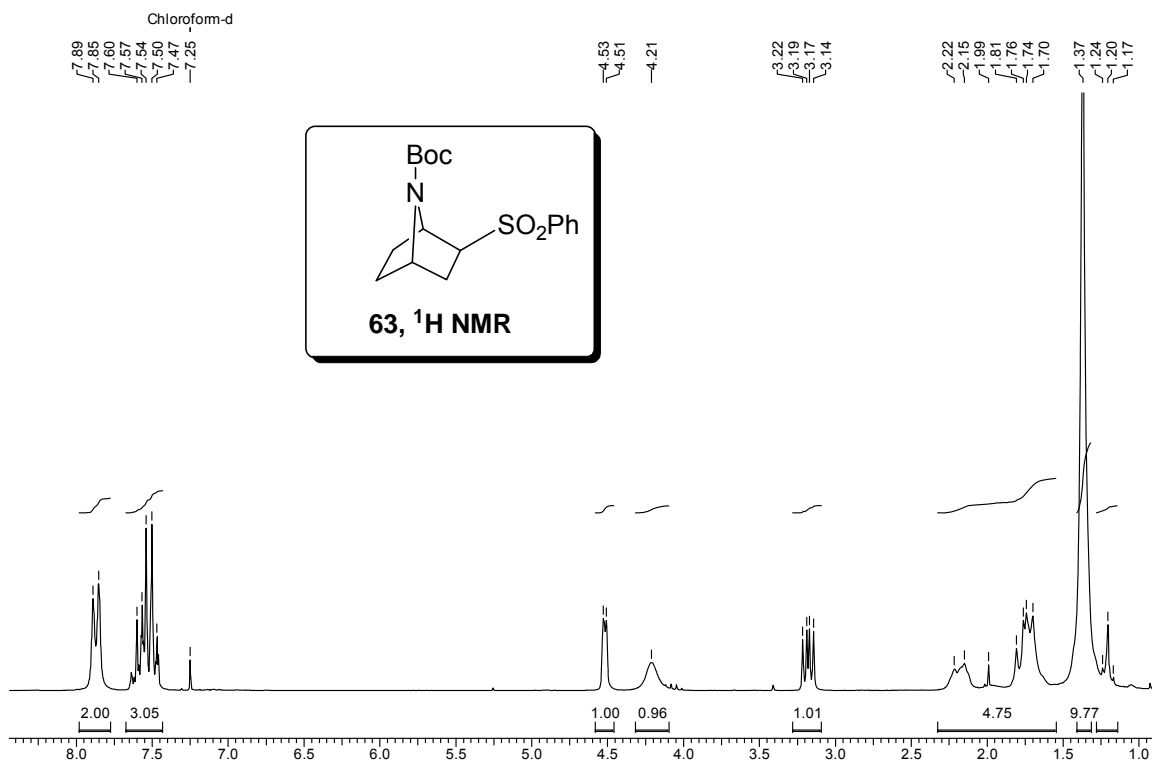
## COSY of 62



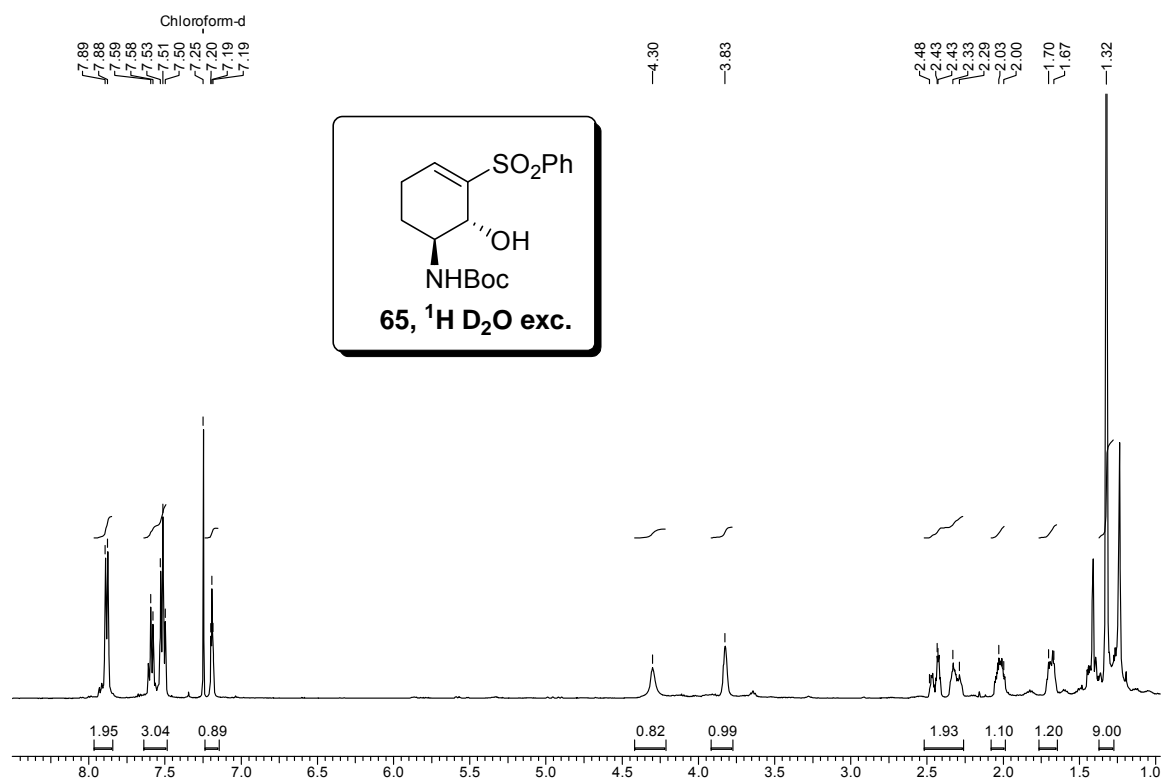
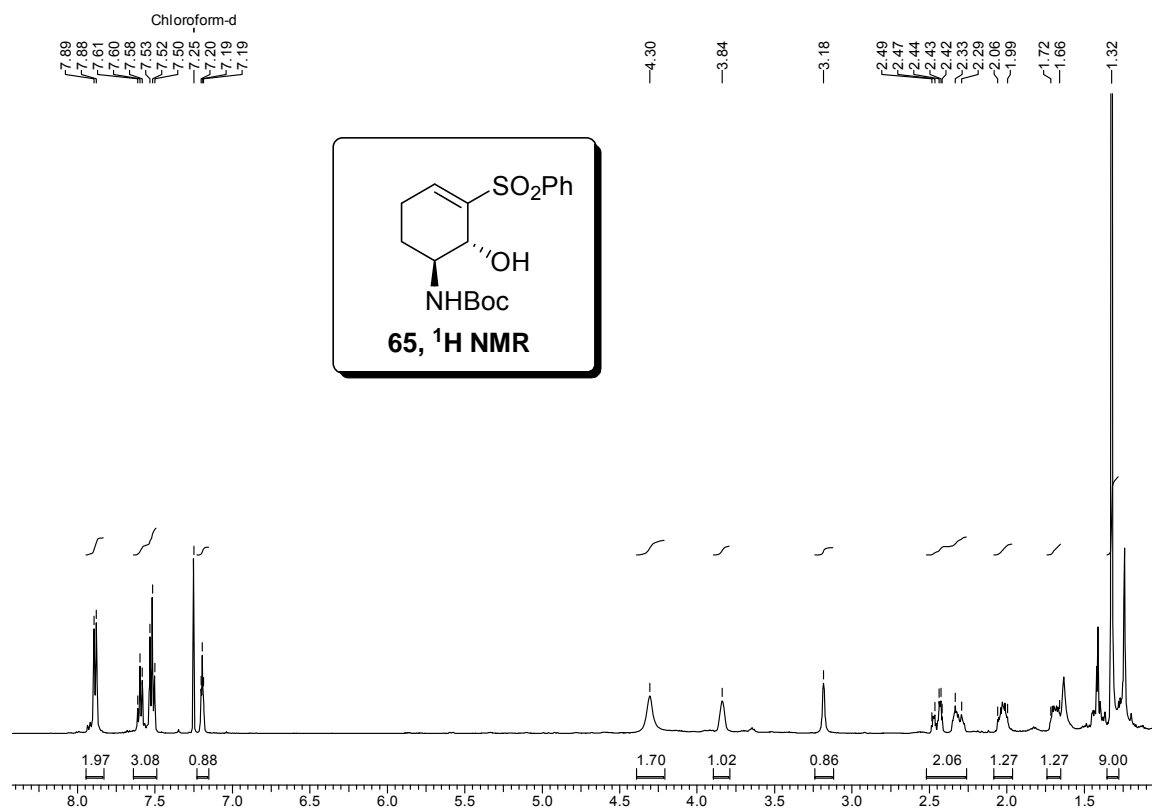
## NOESY of 62



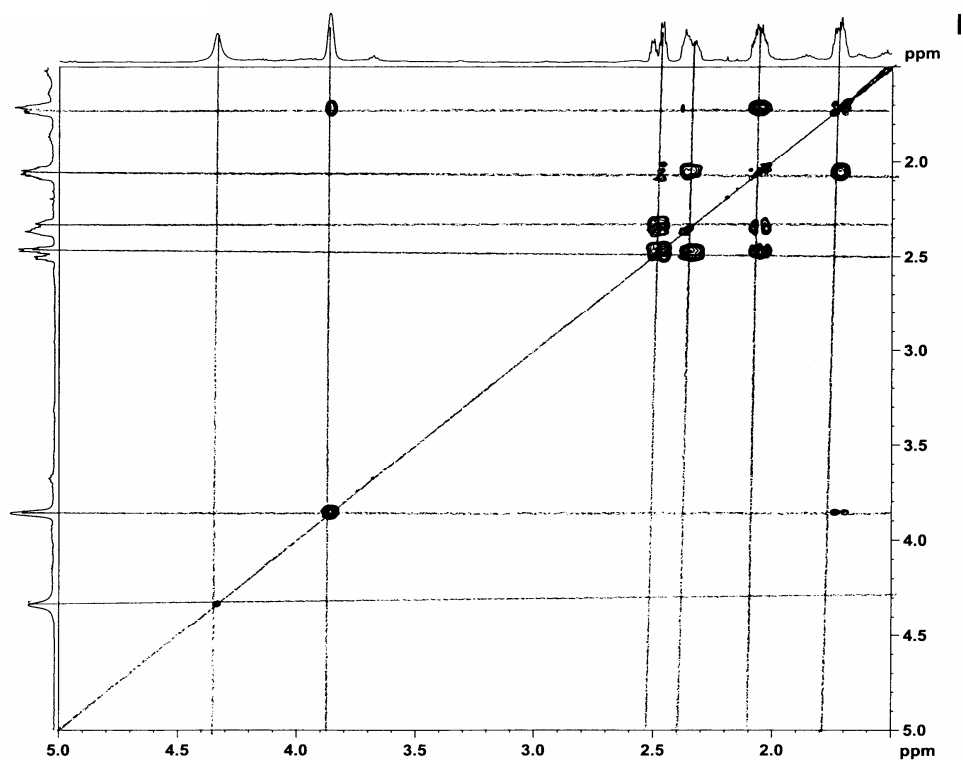




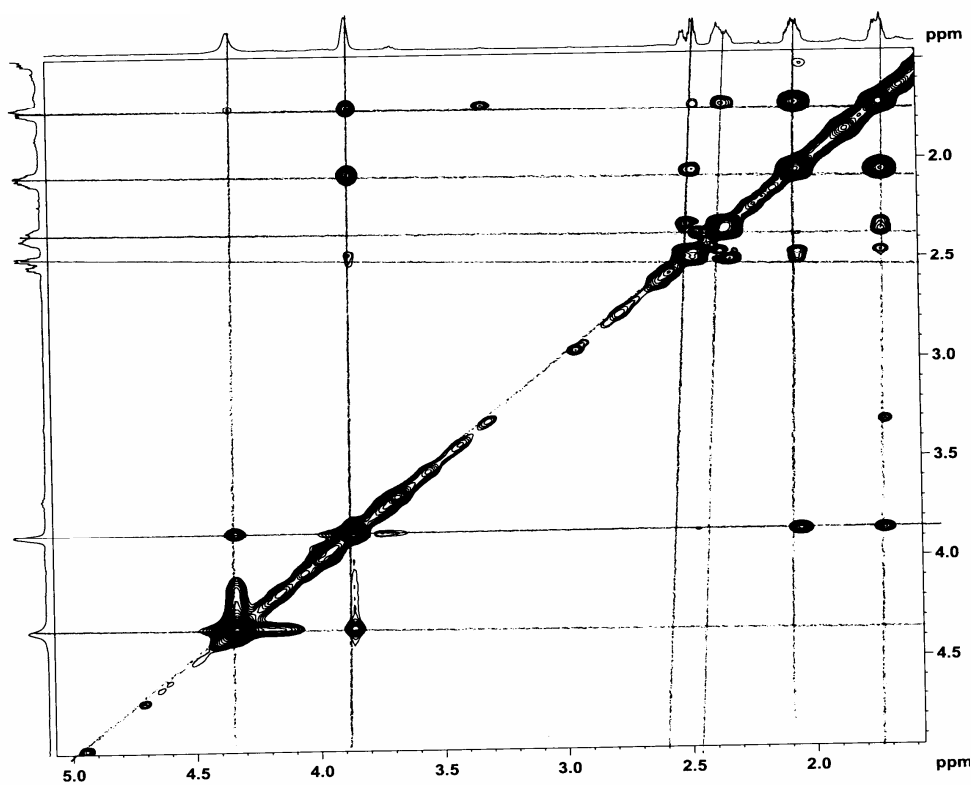


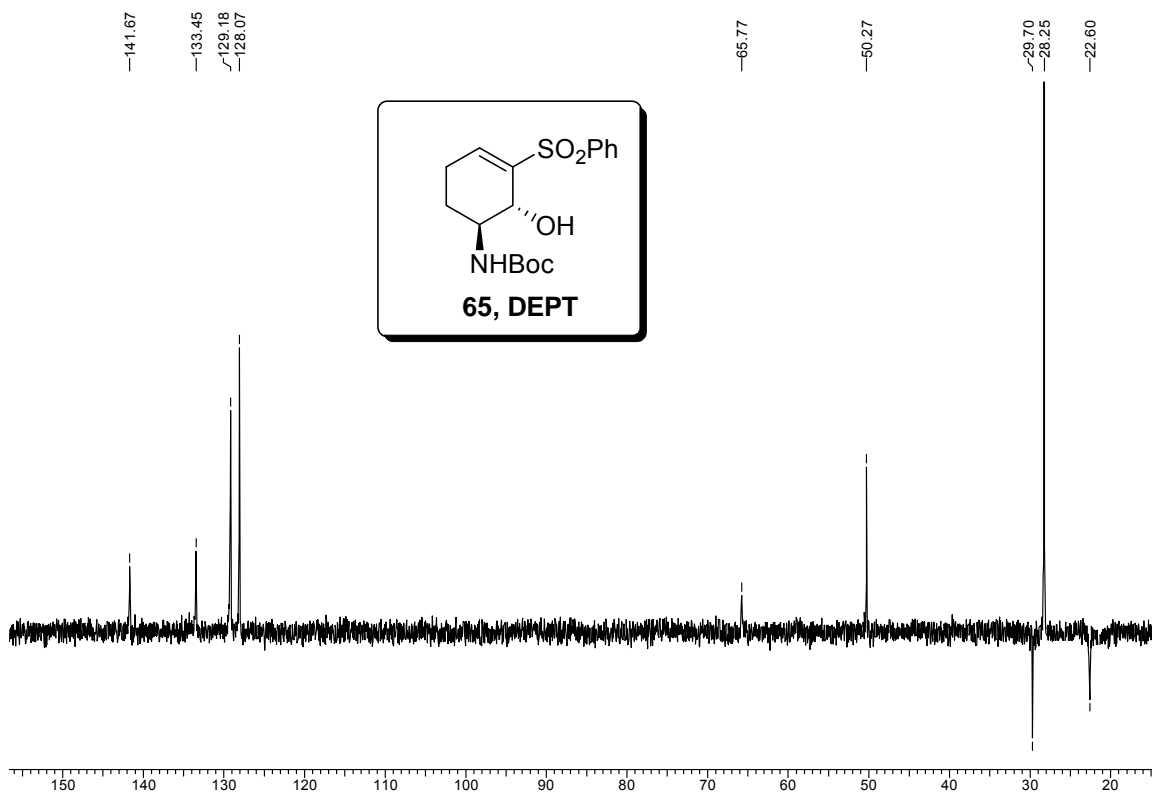
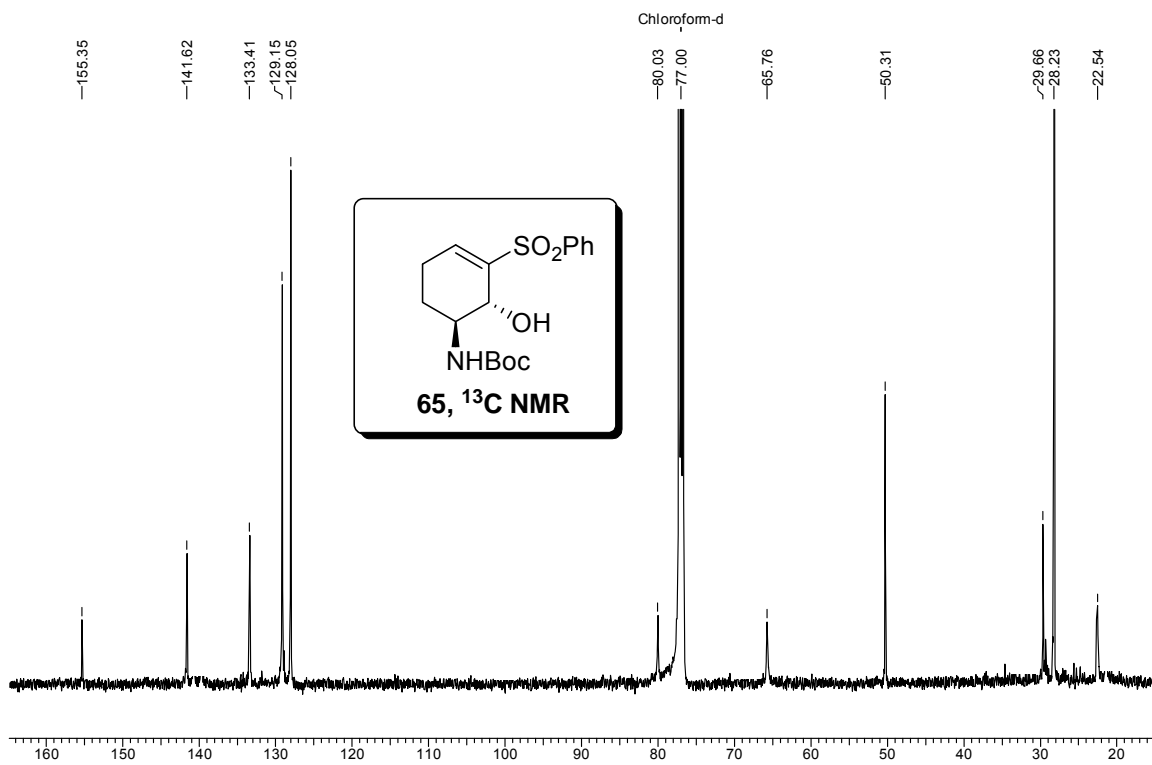


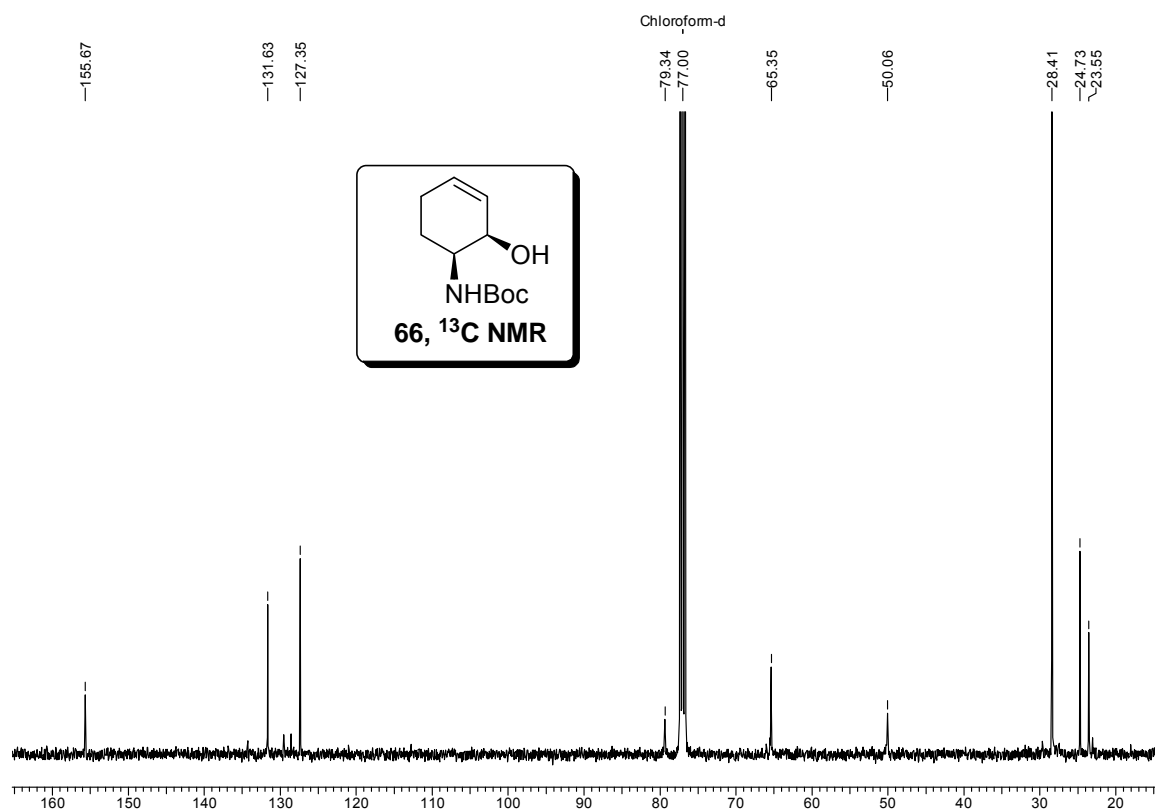
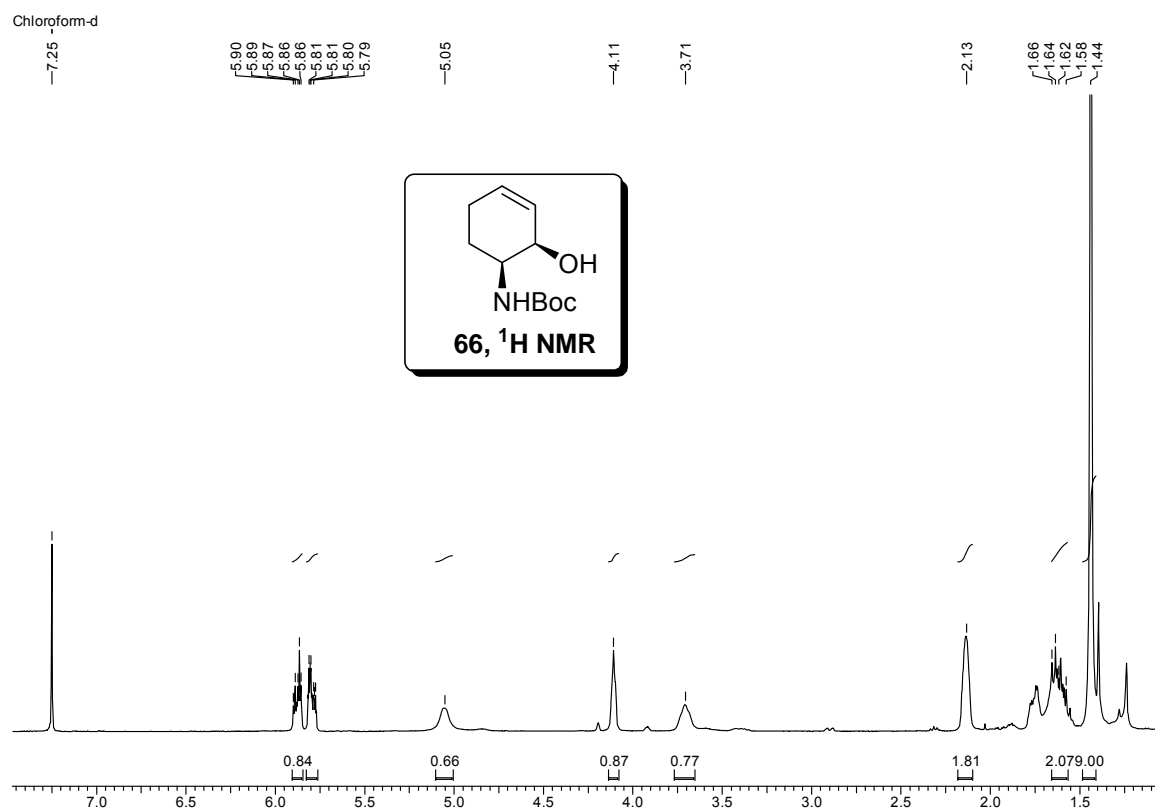
COSY of 65

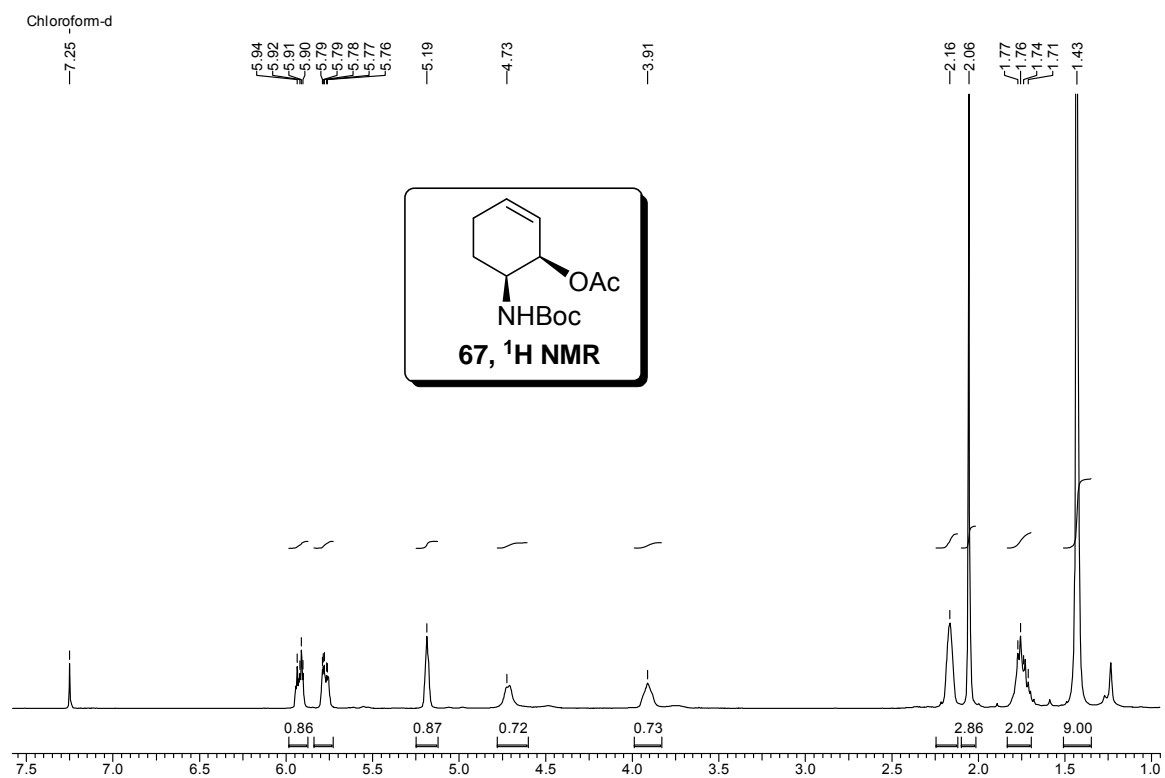
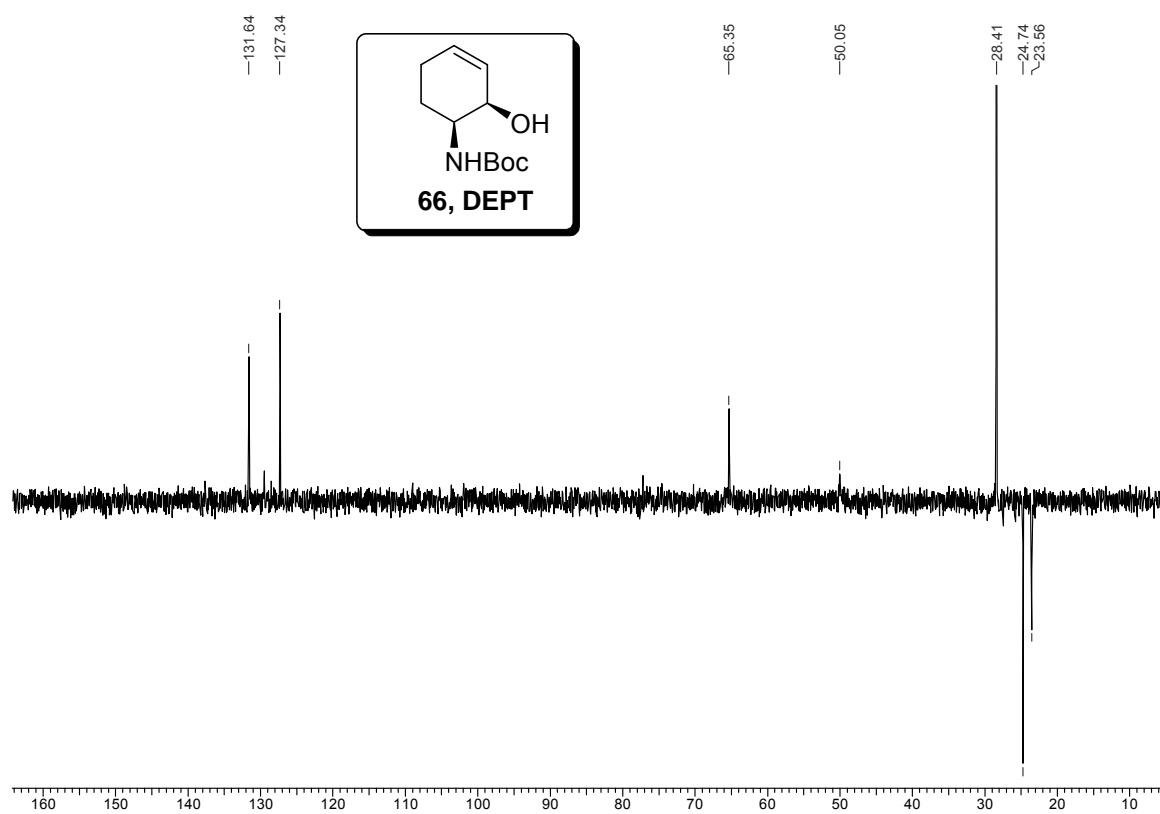


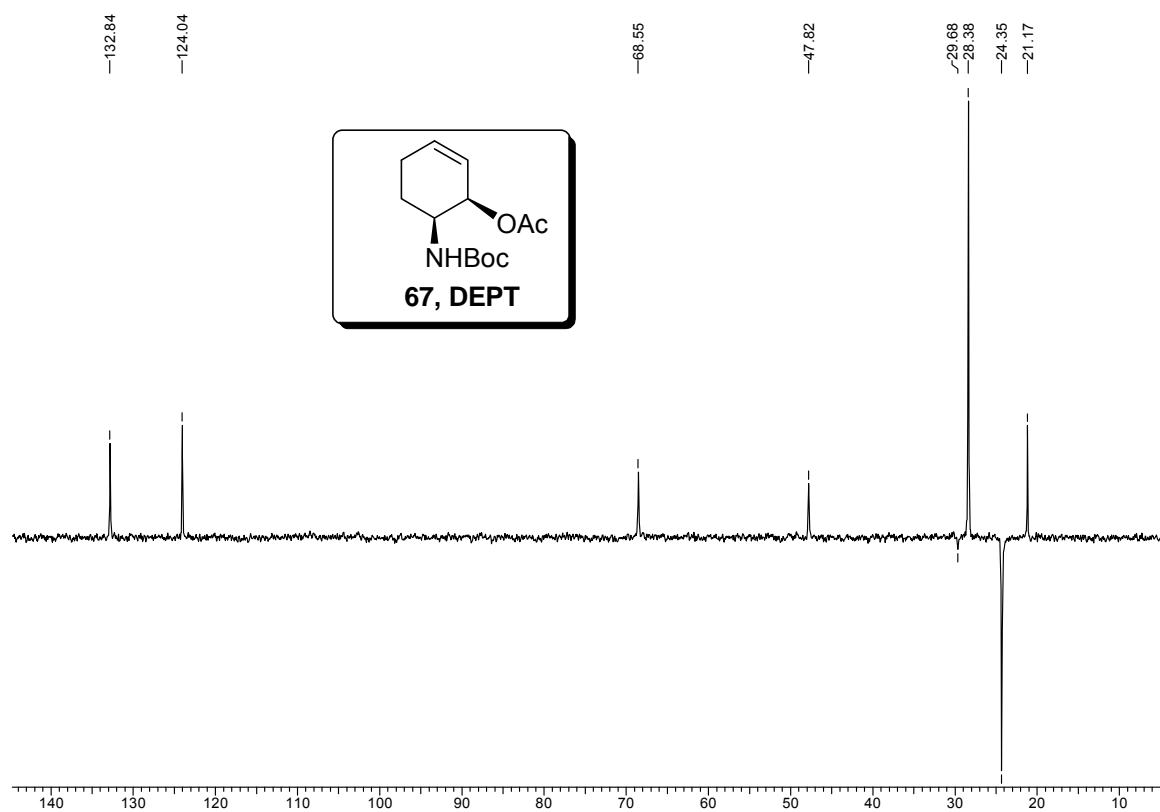
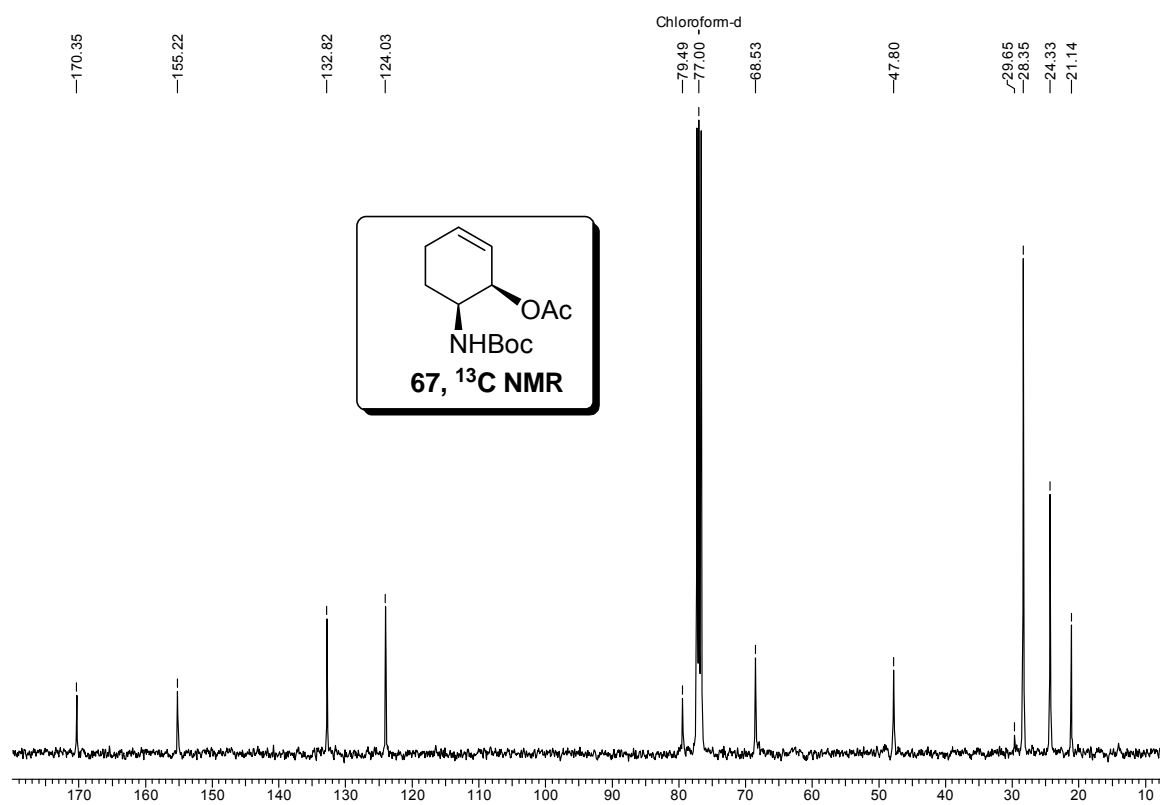
NOESY of 65

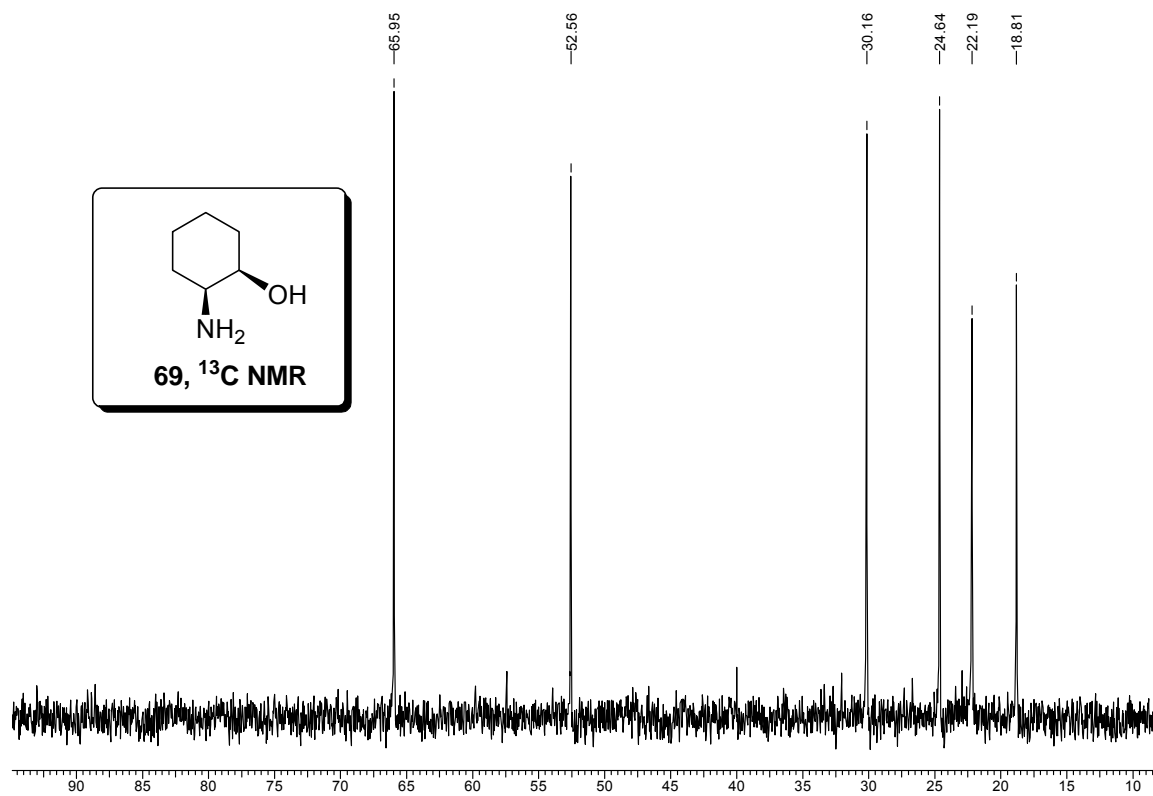
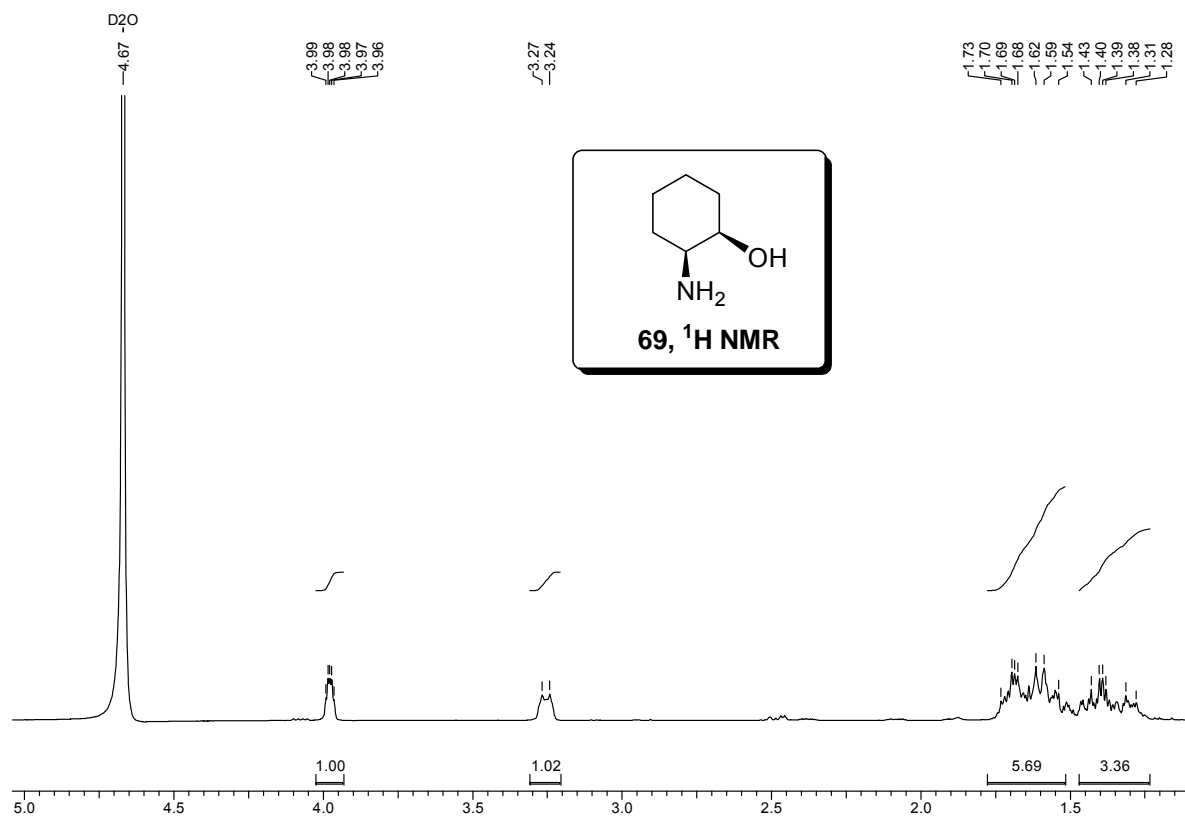


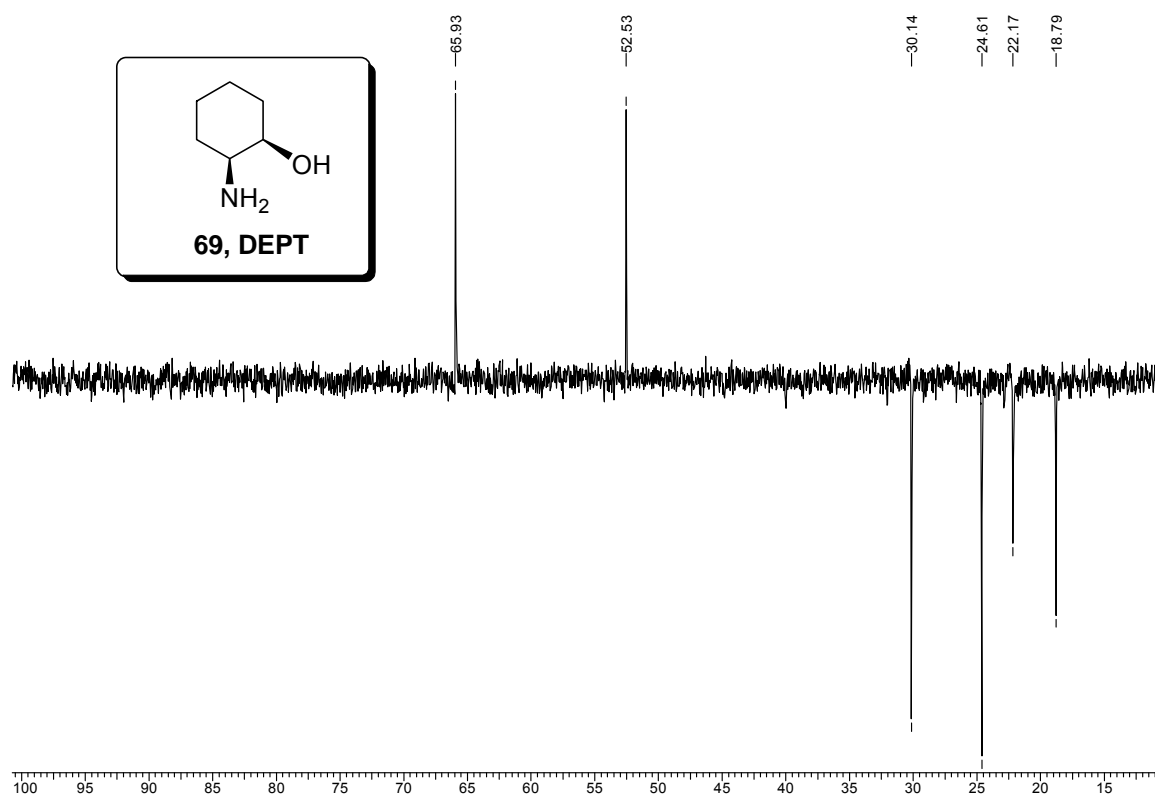




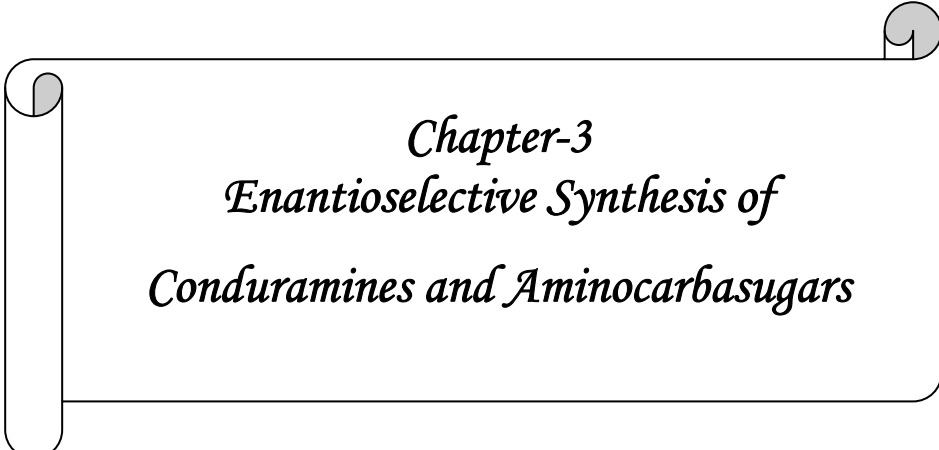












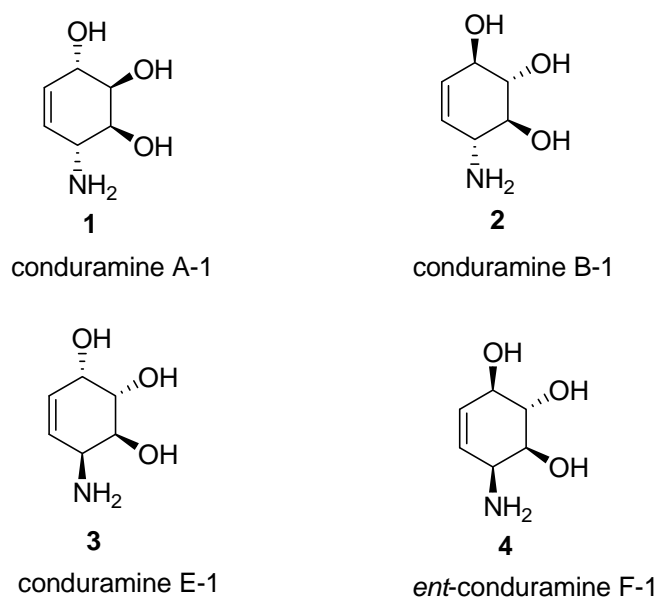
*Chapter-3*  
*Enantioselective Synthesis of*  
*Conduramines and Aminocarb sugars*

### 3.1 Introduction

As briefly described in the introduction, the design and synthesis of glycosidase inhibitors have attracted much interest because of their potential therapeutic applications against viral and bacterial infections. Compounds with obvious structural similarity to a carbohydrate skeleton are a new class of inhibitors and the elucidation of their mechanism of action may add new insights in the search for new therapeutic agents. Conduramines as well as aminocarbasugars, due to their structural similarity, are a family of carbohydrate mimics which have attracted a great deal of attention among organic and medicinal chemists due to their profound biological activities towards glycosidases. The polyhydroxy glycosidase inhibitors are a widely diverse class of compounds often isolated from plants and microorganisms and they have significant therapeutic use or potential. Current interest in these compounds has been extended to a diverse range of diseases including lysosomal storage disorders and cancer, and special attention has been given to those compounds with anti-HIV activity. Isolation of suitable glucosidase inhibitors from natural sources or their chemical synthesis provides biochemical tools for the elucidation of the mechanistic activity of enzyme through the use of kinetic data combined with variations in potential inhibitor structural information. Such knowledge is fundamental to the discovery of lead compounds, because of their promising therapeutic potential.

#### 3.1.1 Conduramines

Conduramines (Figure 1) are purely synthetic molecules which have been formally derived from conduritols. Some conduramines have significant glycosidase inhibitory activities but they are of much greater importance as synthetic precursors in the preparation of pancratistatin alkaloids, azasugars and sphingosines.

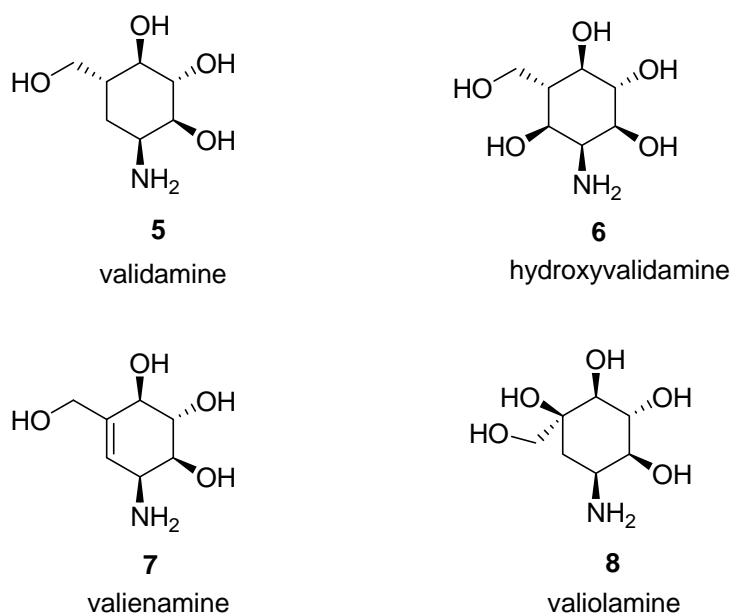


**Figure 1.**

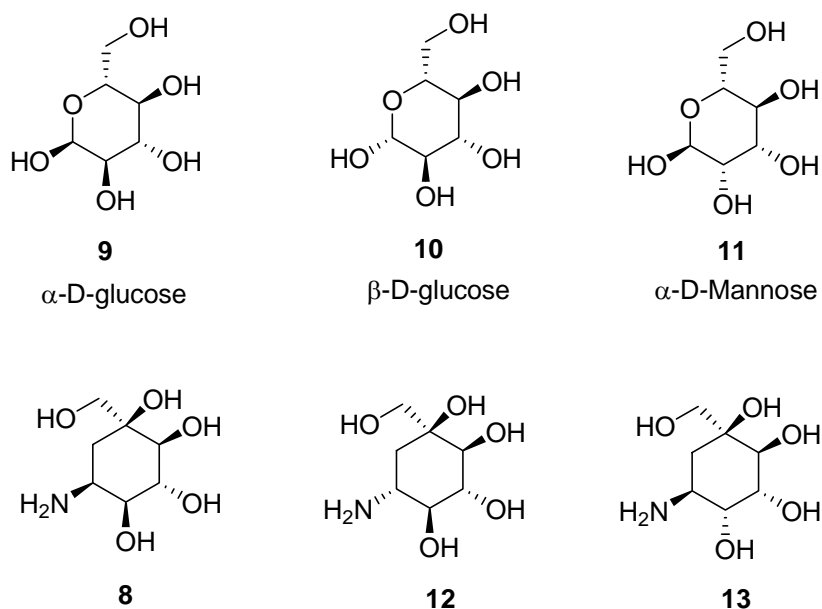
Aminocyclitols and diaminocyclitols, derived from conduramines and their analogues, comprise parts of aminoglycoside antibiotics which are among the oldest known antibiotics. These compounds possess arrays of hydroxyl and amino groups and are potentially interesting systems, as they can target pivotal RNA sites, and are thus candidates for drug discovery<sup>1</sup>. Apart from, due to their glycosidase inhibitory activities, they can act as potential anticancer or antiviral agents<sup>2</sup>. Given the importance of conduramines as synthetic building blocks, it is not surprising that so much effort has been devoted to the development of useful preparative routes to these compounds and their derivatives.

### 3.1.2 Aminocarbasugars

Aminocarbasugars, such as valienamine **7**, validamine **5**, hydroxyvalidamine **6** and valioline **8** (Figure 2), are secondary metabolites which are exclusively produced by microorganisms. These aminocarbasugars appeared to be active against several sugar hydrolases but valioline is found to be a more potent  $\alpha$ -glucosidase inhibitor against porcine intestinal sucrase, maltase, and isomaltase than the rest of the aminocarbasugars.

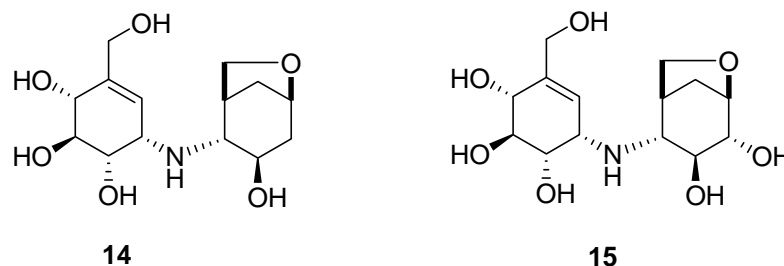
**Figure 2.**

To know the kind of inhibitory activity a molecule can exhibit, it is customarily to understand the structural resemblance with sugar molecule. Fig. 3 shows the structural resemblance of valiolamine with different sugars<sup>3</sup>. Since valiolamine resembles with  $\alpha$ -D-glucose, it is expected to be a potent glucosidase inhibitor.

**Figure 3.**

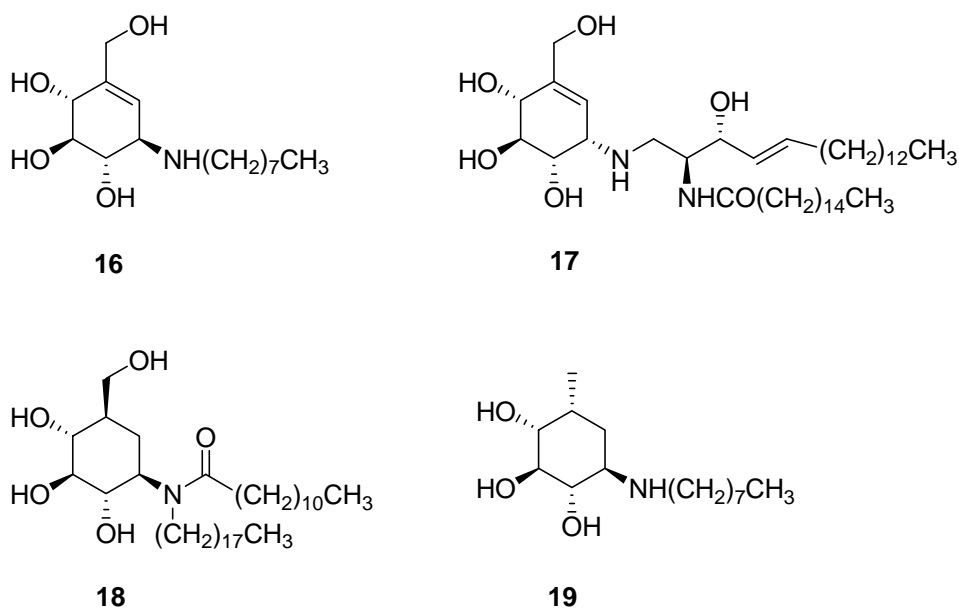
In search for better glycosidase inhibitory activities, several chemically modified analogues of aminocarbascugars like **14** and **15** (Figure 4) have been synthesized

and evaluated<sup>4</sup>. Although, these modifications did not enhance inhibitory activity much against the targeted enzyme, it provided information to understand better structure activity relationship.



**Figure 4.**

More recently, the abilities of some aminocyclitols to interfere with sphingolipid metabolism<sup>5</sup> have paved the way for research into new potential therapeutic applications for this class of compounds. This is the case with *N*-octylvalienamine (NOV) **16**, currently under study for chemical chaperone therapy for the treatment of Gaucher's disease<sup>6</sup>. In addition, several carbocyclic analogues of glycosylceramide such as **17** and **18** have been synthesized by replacing the sugar residue with either saturated or unsaturated aminocarbasugars<sup>7</sup> (Figure 5) and have been found to be very potent and specific inhibitors for gluco- and galactocerebrosidase.

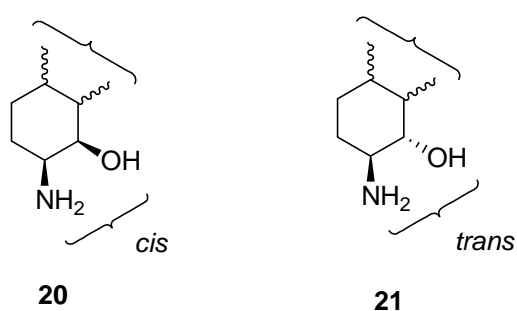


**Figure 5.**

In continuation of the structural modification of aminocarbasugars, molecule like **19** have been prepared by replacing hydroxymethyl group with methyl group and incorporating alkyl side chain into the amino function of aminocyclitol (Fig. 5). These all modifications have led to increase the inhibitory activities more than the parent molecule<sup>8</sup>.

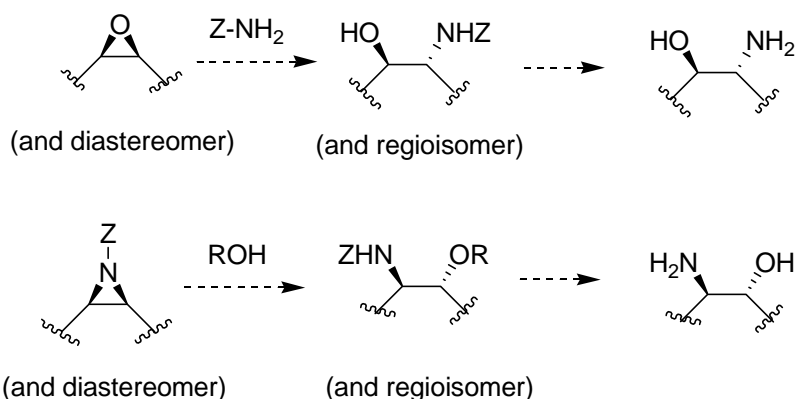
### 3.2 Work plan and retrosynthetic analysis

Despite large numbers of literature precedence, the main synthetic challenge in the synthesis of the optically pure conduramines as well as aminocarbasugars lies in the stereoselective installation of chiral functionalities. Since these densely functionalised small molecules contain amino and hydroxyl groups distributed around a carbocyclic framework, clearly, no synthesis of these molecules should be contemplated without paying attention to the problem of how to introduce amino and hydroxy groups with control of site and stereochemistry. Most of these molecules having vicinal amino alcohols fall under two categories depending on their configuration i.e. either *cis* or *trans* as shown in the Figure 6.

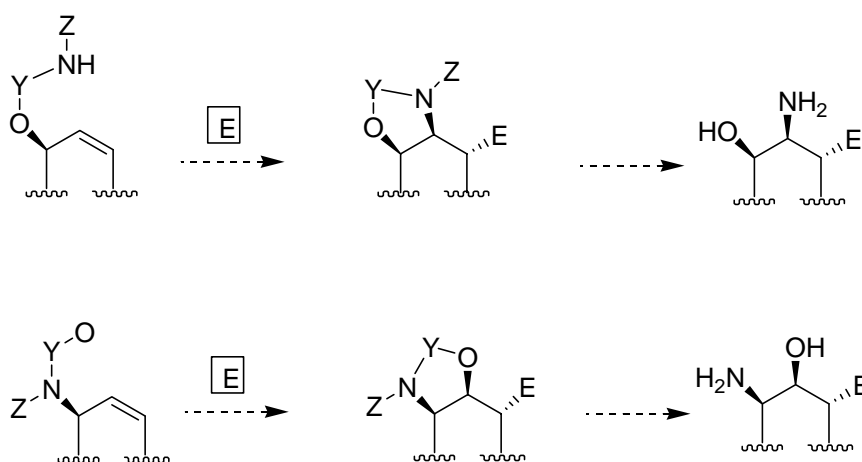


**Figure 6.**

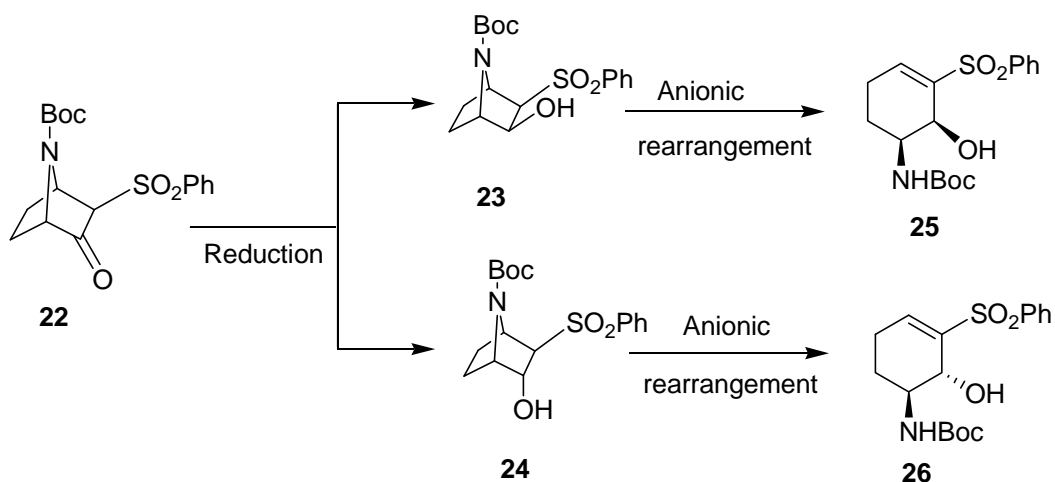
The *trans* introduction of amino and hydroxyl groups can be accomplished in a straightforward manner by ring opening of an epoxide by nitrogen nucleophile or by ring opening of aziridine by oxygen nucleophile, however, the regio- and stereochemistry remains the matter of concern in this approach (Scheme 1).

**Scheme 1.**

Introduction of *cis*-amino alcohol functionality is typically more complicated and is achieved either by displacement of *trans*-difunctional precursor or by *syn*-addition of both the nitrogen and oxygen atoms (Scheme 2).

**Scheme 2.**

Since we have already established that both *cis* and *trans* amino alcohol substituted cyclohexene derivatives **25** and **26** can be easily synthesized by the anionic rearrangement of enantiopure 7-azabicyclo[2.2.1]heptan-2-ol as shown in the Scheme 3, we targeted the synthesis of both kind of aminocyclitols.

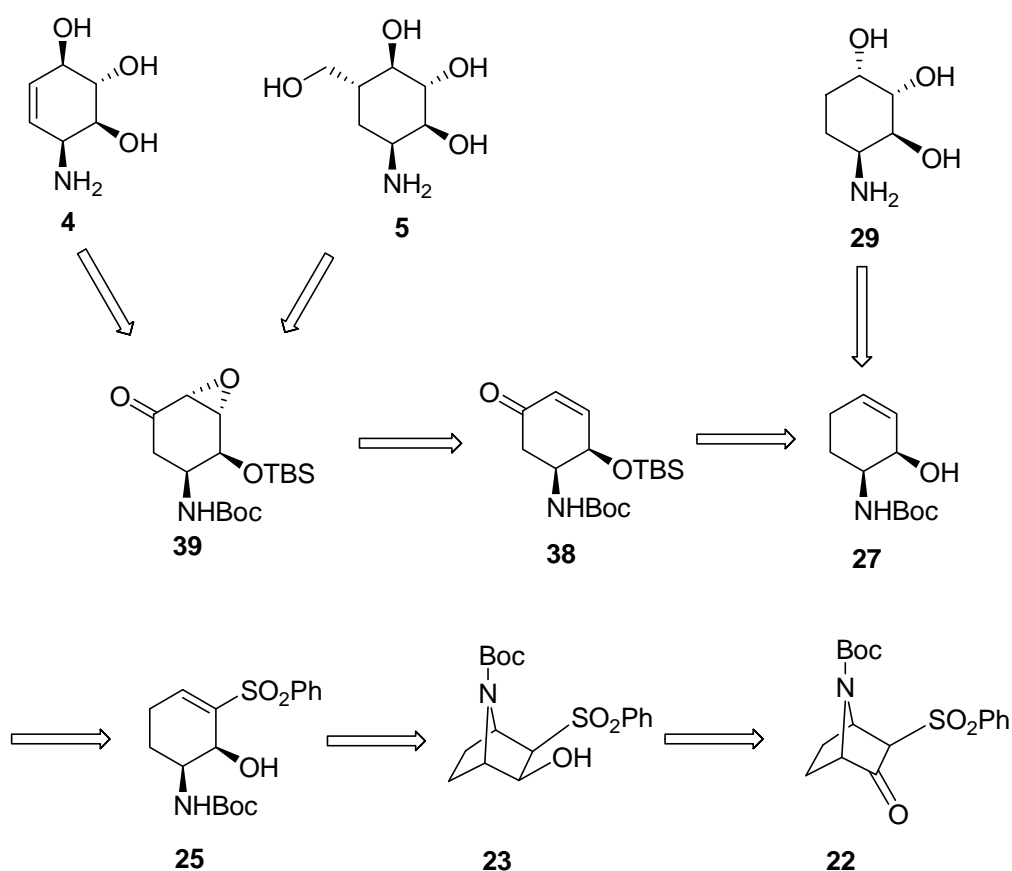


Scheme 3.

### Retrosynthetic analysis

As shown in Scheme 4, a retrosynthetic analysis was worked out for the synthesis of *ent*-conduramine F-1 **4**, validamine **5** and dihydroconduramine E-1 **29** (Scheme 4). We considered that epoxy ketone **40** could act as an advanced intermediate for the synthesis of conduramines. To arrive at epoxy ketone in optically pure form, it would be necessary to synthesize enone **39** which on nucleophilic epoxidation can provide required **40**. The **39** could be obtained by allylic oxidation of cyclohexene derivative which in turn can be obtained by the desulfonylation of **25** which could be obtained by anionic rearrangement of 7-azabicyclo[2.2.1]heptan-2-ol **23**.





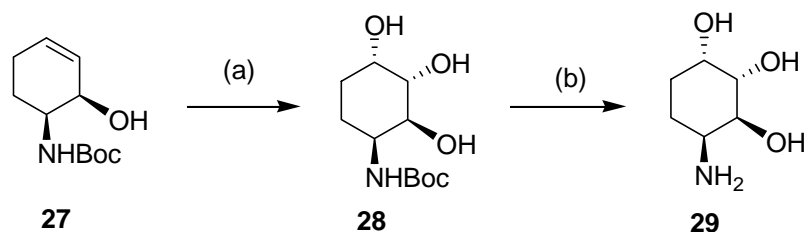
Scheme 4.

### 3.3 Results and Discussion

#### 3.3.1 Synthesis of dihydroconduramine E-1

Considering the glycosidase inhibitory activities of conduramines, we planned to make dihydroconduramine E-1 **29**. Although, unknown in all respect, dihydroconduramine E-1 can be synthesized and tested as inhibitors towards some of the glycosidases. To synthesize **29**, OsO<sub>4</sub> catalysed dihydroxylation was performed on **27**, obtained by the anionic rearrangement and desulfonylation of **23**, which gave expected triol **28** in 75% yield as a single diastereomer. The stereochemistry of **28** was quite predictable as dihydroxylation of free allylic cyclohexenols has been shown to be dependent on the conformation of hydroxyl group and according to Donohae<sup>9</sup>,

diastereoselective attack *anti* to the OH group is usually achieved under standard conditions. The carbamate deprotection with dil. HCl yielded dihydroconduramine E-1 **29** in 90% yield (Scheme 5).



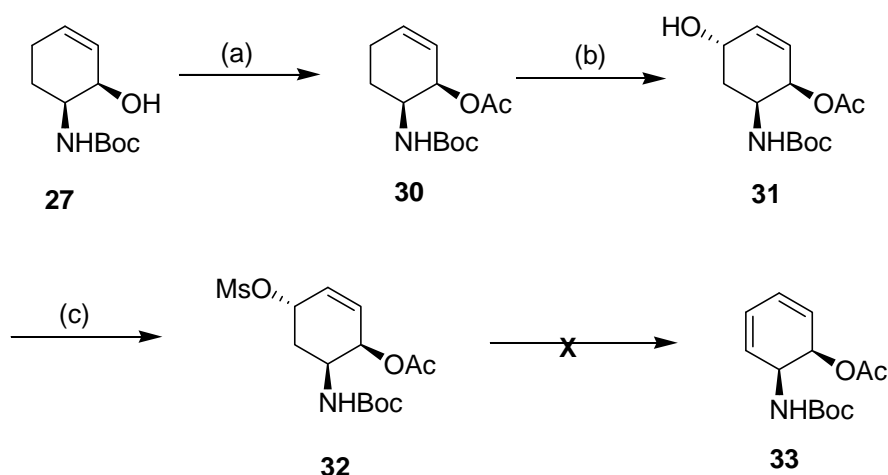
**Scheme 5.**

*Reagents and Conditions* : (a) OsO<sub>4</sub>, NMO, NaHCO<sub>3</sub>, *t*-BuOH: H<sub>2</sub>O (1:1), 12 h, rt, 75% (b) 3N HCl, 1,4-dioxane, 6 h, 100 °C, 90%

<sup>1</sup>H NMR of **29** displayed three sets of multiplets at  $\delta$  3.92,  $\delta$  3.84 and  $\delta$  3.79 each integrating for one proton and were assigned to three protons attached to hydroxyl group. A multiplet at  $\delta$  3.39 integrating for one proton was assigned as proton attached with amine group and a multiplet between  $\delta$  1.74- 1.55 integrating for four protons were assigned as methylene protons. The mass spectrum of **29** showed molecular ion peak at 148 (M<sup>+</sup>+H). The confirmation of stereochemistry was done by carrying out COSY and NOESY experiments.

### 3.3.2 Synthesis of *ent*-conduramine F-1

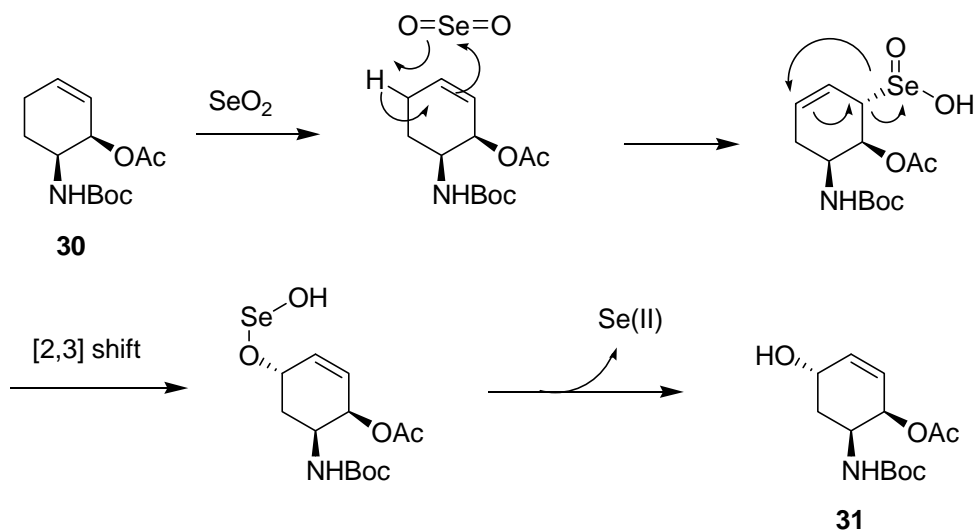
Towards the synthesis of *ent*-conduramine F-1 **4**, initially it was planned to generate olefinic moiety by allylic hydroxylation and base induced elimination. In this context, the free alcohol of **27** was protected as acetate ester using acetyl chloride to give **30** as a crystalline solid. In <sup>1</sup>H NMR, the two olefinic protons appeared as multiplet at  $\delta$  5.92 (m, 1H) and  $\delta$  5.77 (m, 1H). The characteristic peak of acetate methyl appeared at  $\delta$  2.06 (s, 1H) as a singlet. The mass spectrum of **30** showed molecular ion peak at 256 (M<sup>+</sup>+H).



Scheme 6.

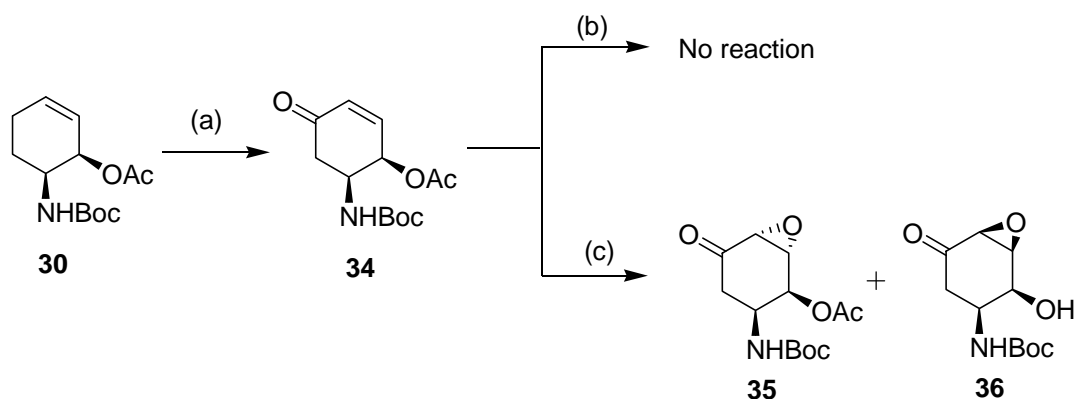
*Reagents and Conditions:* (a)  $\text{CH}_3\text{COCl}$ , Pyridine, DCM, rt, 12 h, 80% (b)  $\text{SeO}_2$ , 1,4-dioxane,  $110^\circ\text{C}$ , 6 h, 60% (c)  $\text{MsCl}$ ,  $\text{Et}_3\text{N}$ , DCM,  $0^\circ\text{C}$ , 1 h, 75%

When **30** was refluxed with  $\text{SeO}_2$  in dioxane 5 h, it produced the allylic hydroxylation product **31** in 60% yield. Since it was planned to eliminate the hydroxy group, the stereochemical consideration for this reaction was inconsequential. The alcohol group of **31** was protected as mesyl derivative **32** using standard conditions of mesylation as it is considered as good leaving group. To our surprise, no mesyloxy elimination was observed with **32** by use of various amines such as DBU and *i*- $\text{Pr}_2\text{NEt}$  (Scheme 6). This conversion was not accomplished probably due to lack of driving force.



Scheme 7.

With this failure, the synthetic strategy was modified according to retrosynthetic design. In order to make enone **34** by allylic oxidation, **30** was treated with freshly prepared PDC using *t*-BuOOH as a cooxidant in dichloromethane which produced the required enone **34** in 70% yield (Scheme 8). IR spectrum showed a strong absorption band at  $1685\text{ cm}^{-1}$  indicating the presence of enone moiety in the product. In  $^1\text{H}$  NMR, the proton appearing as dd at  $\delta$  6.91 (dd,  $J = 10.2, 4.7\text{ Hz}$ , 1H) and a doublet at  $\delta$  6.31 (d,  $J = 10.0\text{ Hz}$ , 1H) was assigned as two olefinic protons. The mass spectrum of **34** showed molecular ion peak at  $270\text{ (M}^+\text{+H)}$ .



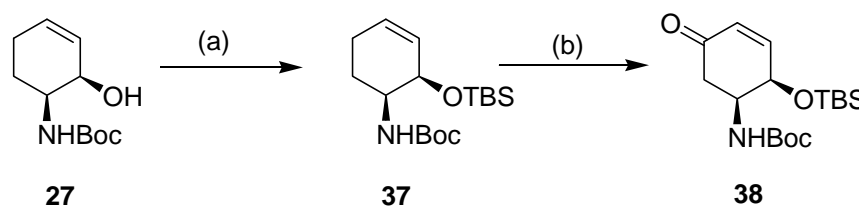
**Scheme 8.**

**Reagents and Conditions:** (a) PDC, *t*-BuOOH, DCM, rt, 24 h, 70% (b)  $\text{NaHCO}_3$ ,  $\text{H}_2\text{O}_2$ , THF,  $0\text{ }^\circ\text{C}$  to rt, 4 h (c) *t*-BuOOH, DBU, THF, rt, 6 h, 65%

After having enone **34** in hands, our next target was to carry out epoxidation. Epoxidation of electron-deficient olefins to the corresponding epoxides is always considered as a challenging reaction in oxidation chemistry because of its low electron density and inactivity for electrophilic oxygen transfer. However, attempts to cause epoxidation of enone **34** both nucleophilically via sodium bicarbonate and hydrogen peroxide as well as electrophilically via *m*-chloroperoxybenzoic acid were found unsuccessful, resulting into total re-isolation of starting material. Although, treatment of enone with *tert*-butylhydroperoxide and Triton B as well as DBU produced a mixture of isomers **35** and **36** as indicated by the  $^1\text{H}$  NMR, the formation

of isomers can be anticipated by the fact that under basic conditions the acetate ester may undergo hydrolysis resulting into the formation of isomers.

The reason for the difficulty encountered during the epoxidation was probably because of base labile nature of acetate group under basic conditions, therefore, it was decided to protect hydroxyl group with such a protecting group which apart from being base tolerant could also provide steric bulk in order to get high diastereoselectivity. Subsequently TBSCl appeared to be a suitable choice as it is already documented<sup>10</sup> to exert steric bulk during the epoxidation. In this regard, **27** was treated with TBSCl in anhydrous dichloromethane in presence of imidazole and catalytic DMAP which furnished **37** in 80% yield as a colourless liquid.



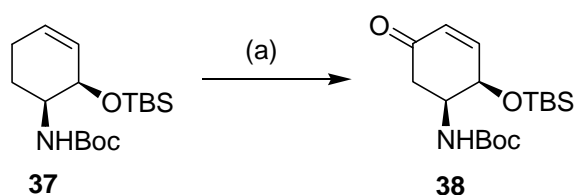
*Scheme 9.*

*Reagents and Conditions* : (a) TBSCl, Im, DMAP, DCM, 18 h, 80% (b) PDC, *t*-BuOOH, DCM, 24 h, 40%

In <sup>1</sup>H NMR, the six protons of methyl and nine protons of butyl of TBS ether appeared at  $\delta$  0.08 (s, 6H) and  $\delta$  0.89 (s, 9H) respectively. The signals appeared at  $\delta$  5.77 (dt,  $J = 7.0, 3.5$  Hz, 1H) and  $\delta$  5.62 (dt,  $J = 4.2, 2.2$  Hz, 1H) were assigned as two olefinic protons.

Moving further towards synthetic elaboration, **37** was subjected for allylic oxidation using similar kind of reaction conditions described earlier which produced enone **38** in low yield (40%). The unexpected low yield of this transformation was probably because of the incompatibility of TBS ether with the PDC. This difficulty prompted us to look for an alternative strategy for allylic oxidation.

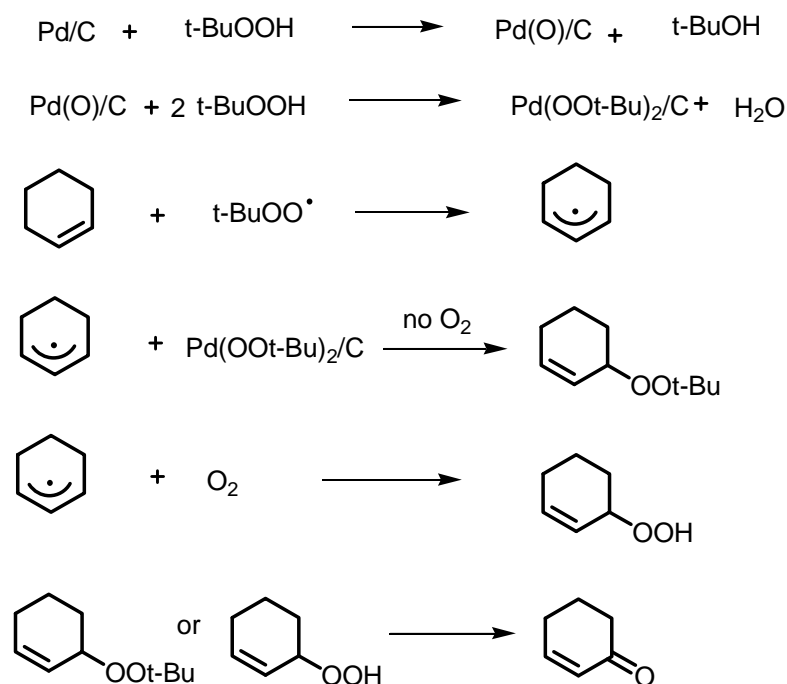
After screening the literature, the protocol discovered by Corey et al.<sup>11</sup> which involves palladium charcoal as a catalyst and *t*-BuOOH as a co-oxidant was attempted. A heterogeneous mixture of **37**, 2.5 mol% Pd on charcoal, 5 eq. of *t*-BuOOH and 25 mol% of K<sub>2</sub>CO<sub>3</sub> was stirred for 24 h at 0 °C which produced the expected enone **38** in 75% yield (Scheme 10).



**Scheme 10.**

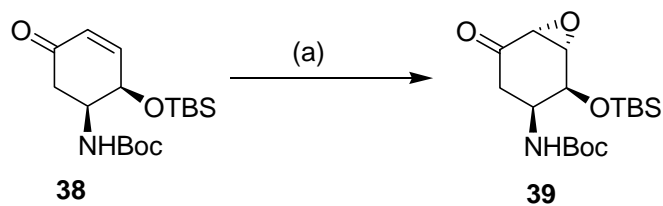
*Reagents and Conditions* : (a) Pd/C, K<sub>2</sub>CO<sub>3</sub>, *t*-BuOOH, DCM, 0 °C, 24 h, 75%

In IR, a strong absorption band at 1693 cm<sup>-1</sup> indicated the presence of enone functionality. In <sup>1</sup>H NMR, the signals appearing at δ 6.79 (dd, *J* = 10.0, 4.5 Hz, 1H) and δ 6.02 (d, *J* = 10.0 Hz, 1H) were assigned as two olefinic protons of enone moiety. Although, the mechanism of this reaction is not yet certain, a hypothetical consideration has been given which seems to be rational. The α,β-enone product is formed by allylic *tert*-butylperoxy ether intermediates (which have been detected by chromatographic analysis, isolated and characterized) generated by a *t*-BuOO<sup>•</sup> initiated reaction sequence. These ethers undergo rapid reaction with *t*-BuOO<sup>•</sup> under the reaction conditions to form the enone product. It has been found that the enone can be formed even without the intermediacy of allylic *tert*-butylperoxy ethers if the reaction is conducted under 1 atm. of oxygen. Under these conditions, the allylic radicals formed from the olefin by *t*-BuOO<sup>•</sup> induced allylic H abstraction is intercepted by oxygen to form an allylic hydroperoxide which is then further oxidised to enone as shown in Scheme 11.



Scheme 11.

When enone **38** was exposed to *t*-butylhydroperoxide and a catalytic amount of Triton B in anhydrous THF, it afforded exclusively the epoxy ketone **39** in 85% isolated yield as a single diastereomer (Scheme 12).



Scheme 12.

*Reagents and Conditions* : (a) *t*-BuOOH, Triton B, THF, 0 °C, 3 h, 85%

The IR spectrum of **39** showed a strong band at 1720  $\text{cm}^{-1}$  indicating the disappearance of olefin moiety. In  $^1\text{H}$  NMR, the signals appearing at  $\delta$  3.27 (d,  $J = 3.7$  Hz, 1H) and  $\delta$  3.50 (dd,  $J = 3.7, 3.5$  Hz, 1H) were characterized as two protons attached with epoxide. The mass spectrum of **39** showed a molecular ion peak.

at 380 ( $M^+Na$ ). The stereochemical outcome of this reaction can be understood by its mechanism. The first step towards epoxidation is 1,4-addition of *t*-butylhydroperoxide anion onto the enone, therefore attack is always preferred anti to the TBS group in order to avoid steric hinderance as shown in Figure 7.

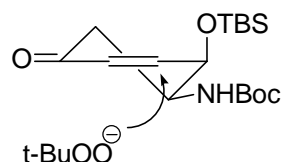
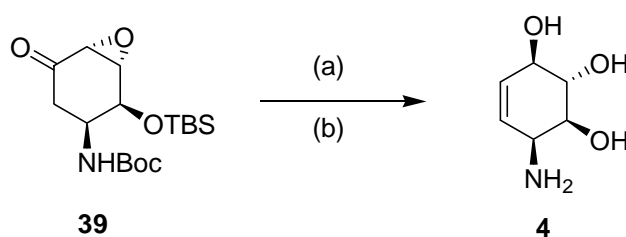


Figure 7.

For the synthesis of *ent*-conduramine F-1 **4**, it was necessary to create the internal olefin from the carbonyl group. In this context, the epoxy ketone **39** was enolised by use of KHMDS at  $-78\text{ }^{\circ}\text{C}$  and subsequently trapped by Comins reagent<sup>12</sup> which produced corresponding enol triflate. The required double bond was created by reductive elimination of enol triflate using palladium catalyst and triethylsilane as a reducing agent in THF. Finally the epoxide opening was done with  $0.2\text{ }N\text{ H}_2\text{SO}_4$  in dioxane and the resulting compound was refluxed with  $12\text{ }N\text{ HCl}$  to yield the **4** (Scheme 13).



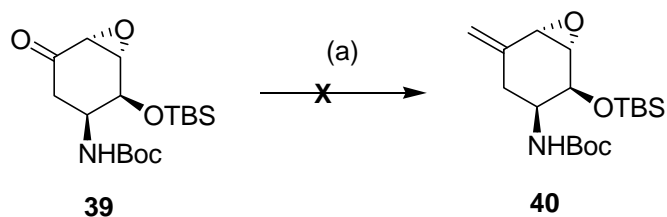
Scheme 13.

*Reagents and Conditions* : (a) KHMDS, Comins reagent,  $\text{Pd}(\text{PPh}_3)_4$ ,  $\text{Et}_3\text{SiH}$ , THF  
(b)  $0.2\text{ }N\text{ H}_2\text{SO}_4$ , 1,4-dioxane,  $12\text{ }N\text{ HCl}$ , reflux

Some of the reaction steps are quite low yielding in this sequence and therefore there is a need of optimization of reaction conditions. Studies along these lines are currently under progress.



In order to apply this epoxy ketone for the synthesis of aminocarbasugars, it was planned to apply one carbon Wittig olefination for exocyclic olefin. The synthesis of aminocarbasugars from the **40** would become much easier as all the stereochemical functionalities are appropriately installed.



*Scheme 14.*

*Reagents and Conditions* : (a)  $\text{PPh}_3$ ,  $\text{CH}_3\text{I}$ ,  $n\text{-BuLi}$ , THF,  $0\text{ }^\circ\text{C}$  to rt, 10 h

In order to get exocyclic double bond, **39** was treated with Wittig salt generated by  $\text{PPh}_3$  and  $\text{CH}_3\text{I}$  in THF at  $0\text{ }^\circ\text{C}$  by slow addition of  $n\text{-BuLi}$  and was stirred for 10 h at room temperature, to our disappointment, it produced complex reaction mixture (Scheme 14). Even screening of many bases also did not help to get the required product **40**. It seems that base sensitive nature of epoxide might be creating trouble and thus leading to formation of unwanted product.

### 3.4 Conclusion and Future Outlook

Aminocyclitols constituting a large group of natural and synthetic products are of great synthetic importance due to their potential biological activities as well as their synthetic usefulness in the synthesis of other natural or pharmaceutical compounds. Hence, to develop new and efficient synthesis leading to these kinds of aminocyclitols and their derivatives is a field of growing interest.

Enantiopure 3-phenylsulfonyl-7-azabicyclo[2.2.1]hept-2-one was synthesized by using asymmetric desymmetrization protocol of a *meso*-precursor. Regarding the epimerization of sulfone during the reduction of 7-azabicyclic ketone an useful insight was presented. Base mediated anionic rearrangement of both isomers of 7-azabicyclo[2.2.1]heptan-2-ol leading to chiral, substituted cyclohexene derivatives were successfully demonstrated which is considered to be difficult otherwise. Using reductive desulfonylation followed by simple chemical transformation both the isomer of 2-aminocyclohexanols were synthesized. Dihydroconduramine E-1 was synthesized by carrying out the dihydroxylation and carbamate deprotection with substituted cyclohexene derivative.

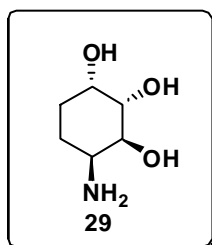
Towards the synthesis of *ent*-conduramine F-1, which is also called as norvalienamine (one hydroxymethyl group less than valienamine) allylic oxidation of cyclohexene by Corey's method was utilized. The nucleophilic epoxidation which is always considered as a challenging reaction in oxidation chemistry because of its low electron density and inactivity for electrophilic oxygen transfer was attempted using various nucleophilic conditions and finally it was successfully completed by changing the protecting group.

The creation of double bond was achieved by accessing enol triflate followed by reductive removal by use of palladium catalyst and triethyl silane. An attempt was made towards the synthesis of aminocarbasugars by the functionalisation of exocyclic olefin using one carbon Wittig olefination. However various conditions of Wittig olefination were unsuccessful as it failed to give the required product.

We believe that the methodological studies leading to synthetically useful molecules shown in the dissertation would provide a significant deal of information in the area of aminocyclitol synthesis.

### 3.5 Experimental Section

#### 1. (1*S*,2*S*,3*S*,4*S*)-4-aminocyclohexane-1,2,3-triol (**29**)

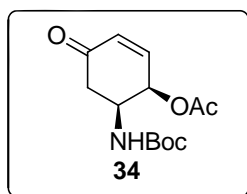


Solutions of **27** (0.050 g, 0.234 mmol) in THF (2 mL), *N*-methylmorpholine-*N*-oxide (0.041 g, 0.352 mmol) and OsO<sub>4</sub> (0.1 mL, 2.5 wt% solution in *tert*-butyl alcohol) was added in succession to a stirred solution of sodium bicarbonate (0.019 g, 0.234 mmol) in *tert*-butyl alcohol (3 mL) and water (0.75 mL). The reaction was stirred at room temperature for 15 h and then excess 10% NaHSO<sub>3</sub> solution was added. The reaction mixture was diluted with EtOAc and worked up in the usual manner. The column chromatography purification provided **28** (0.043 g, 75%) as a crystalline solid.

A solution of **28** (0.043 g, 0.174 mmol) in 1,4-dioxane (2 mL) and 3*N* HCl (0.5 mL) was heated at reflux temperature for 5 h. The solution was evaporated in vacuo to yield **29** (0.023 g, 90%) as a crystalline solid.

mp	:	95-97 °C
$[\alpha]_{\text{D}}^{30}$	:	+55.0 ( <i>c</i> 0.5, H <sub>2</sub> O)
IR $\nu_{\text{max}}$ cm <sup>-1</sup> in CHCl <sub>3</sub>	:	3400, 3300
<sup>1</sup> H NMR (500 MHz, D <sub>2</sub> O) $\delta$	:	3.92 (m, 1H) 3.84 (m, 1H) 3.79 (m, 1H) 3.39 (m, 1H) 1.74 (m, 1H) 1.64-1.55 (m, 3H)
<sup>13</sup> C NMR (125 MHz, D <sub>2</sub> O) $\delta$	:	71.3, 68.9, 66.6, 48.6, 24.6, 21.8
MS (ESI): <i>m/z</i>	:	148 (M <sup>+</sup> +H), 170 (M <sup>+</sup> +Na)

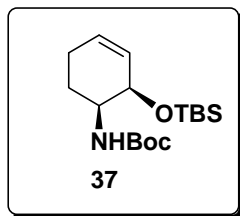
## 2. Preparation of (1*R*,6*S*)-(tert-butoxycarbonylamino)-4-oxocyclohex-2-enyl acetate (**34**)



To a solution of **30** (0.20 g, 0.784 mmol) in CH<sub>2</sub>Cl<sub>2</sub> (10 mL) was added PDC (0.737 g, 1.96 mmol) at 10 °C followed by dropwise addition of 70% aqueous t-BuOOH (0.217 mL, 1.96 mmol). The reaction mixture was warmed to room temperature and stirred for 12 h. Again PDC (0.737 g, 1.96 mmol) and t-BuOOH (0.217 mL, 1.96 mmol) were added and reaction mixture was stirred for additional 12 h at room temperature. The reaction mixture was diluted with CH<sub>2</sub>Cl<sub>2</sub> (10 mL) and filtered through a pad of celite. The filtrate was concentrated in vacuo and purified by column chromatography to yield **34** (0.139 g, 66%) as a colourless liquid.

$[\alpha]_D^{27}$	:	-104 ( <i>c</i> 1.0, CHCl <sub>3</sub> )
IR $\nu_{\max}$ cm <sup>-1</sup> in CHCl <sub>3</sub>	:	1685, 1150
<sup>1</sup> H NMR (400 MHz, CDCl <sub>3</sub> ) $\delta$	:	6.91 (dd, <i>J</i> = 10.2, 4.2 Hz, 1H) 6.13 (d, <i>J</i> = 10.0, Hz, 1H) 5.49 (bs, 1H) 4.80 (m, 1H) 4.45 (m, 1H) 2.68 (d, <i>J</i> = 6.8 Hz, 2H) 2.10 (s, 3H) 1.43 (s, 9H)
<sup>13</sup> C NMR (100 MHz, CDCl <sub>3</sub> ) $\delta$	:	196.0, 169.9, 154.9, 144.0, 132.03, 67.85, 48.2, 40.7, 28.2, 20.7
Mass (ESI): <i>m/z</i>	:	270 (M <sup>+</sup> +H), 292 (M <sup>+</sup> +Na)

### 3. Preparation of *tert*-butyl (1*S*,2*R*)-2-(*tert*-butyldimethylsilyloxy)cyclohex-3-enylcarbamate (**37**)



To a cooled solution (0 °C) of **27** (0.200 g, 0.938 mmol) in CH<sub>2</sub>Cl<sub>2</sub> (5 mL) was added imidazole (0.127 g, 1.87 mmol), dimethylaminopyridine (0.010 g, cat.) and TBSCl (0.282 g, 1.87 mmol). The reaction mixture was stirred for 18 h at room temperature and water (1 mL) was added. The usual work-up followed by column chromatography gave **37** (0.264 g, 86%) as a colourless liquid.

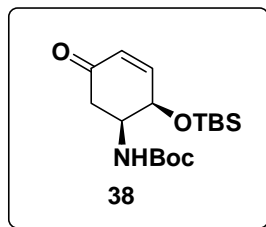
$[\alpha]_D^{22}$  : -79.7 (*c* 1.0, CHCl<sub>3</sub>)

<sup>1</sup>H NMR (400 MHz, CDCl<sub>3</sub>) δ : 5.77 (dt, *J* = 2.2, 4.2 Hz, 1H) 5.62 (m, 1H) 4.85 (d, *J* = 7.5 Hz, 1H) 4.10 (m, 1H) 3.66 (m, 1H) 2.10 (m, 2H) 1.73 (m, 1H) 1.61 (m, 1H) 1.43 (s, 9H) 0.89 (s, 9H) 0.08 (s, 6H)

<sup>13</sup>C NMR (100 MHz, CDCl<sub>3</sub>) δ : 155.5, 130.3, 127.9, 78.9, 65.9, 50.1, 28.4, 25.8, 25.6, 23.7, 18.1, -3.6, -4.8

MS (ESI): *m/z* : 328 (M<sup>+</sup>+H), 350 (M<sup>+</sup>+Na), 366 (M<sup>+</sup>+K)

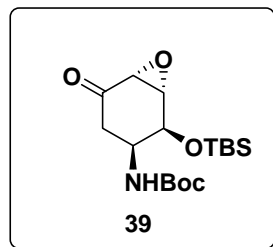
#### 4. Preparation of *tert*-butyl (1*S*,2*R*)-2-(*tert*-butyldimethylsilyloxy)-5-oxocyclohex-3-enylcarbamate (**38**)



Into an oven-dried 25 mL two neck flask equipped with a stir bar was placed 10% Pd/C (0.005 g) CH<sub>2</sub>Cl<sub>2</sub> (4 mL), TBHP (0.304 mL, 1.52 mmol, 5.0-6.0 M in decane), K<sub>2</sub>CO<sub>3</sub> (0.010 g, 0.076 mmol) and **37** (0.100 g, 0.305 mmol) under N<sub>2</sub>. The mixture was stirred at 0 °C and monitored by TLC until starting material was consumed (24 h). The reaction mixture was further stirred for 3 h at 25 °C and filtered through a pad of silica gel washing with CH<sub>2</sub>Cl<sub>2</sub>. After removal of solvent under reduced pressure, the crude was purified by column chromatography using 1:9 pet-ether:EtOAc as the eluent to provide **38** (0.078 g, 75%) as a clear liquid.

$[\alpha]_D^{30}$	:	-34.3 ( <i>c</i> 0.50, CHCl <sub>3</sub> )
IR $\nu_{\max}$ cm <sup>-1</sup> in CHCl <sub>3</sub>	:	3440, 1693, 1150
<sup>1</sup> H NMR (400 MHz, CDCl <sub>3</sub> ) $\delta$	:	6.79 (dd, <i>J</i> = 10.0, 4.5 Hz, 1H) 6.02 (d, <i>J</i> = 10.0 Hz, 1H) 4.80 (m, 1H) 4.42 (m, 1H) 4.11 (m, 1H) 2.72 (dd, <i>J</i> = 16.3, 10.2 Hz, 1H) 2.48 (dd, <i>J</i> = 16.3, 4.0 Hz, 1H) 1.43 (s, 9H) 0.90 (s, 9H) 0.11 (s, 6H)
<sup>13</sup> C NMR (100 MHz, CDCl <sub>3</sub> ) $\delta$	:	197.4, 155.0, 147.4, 130.3, 79.8, 74.6, 65.5, 50.21, 39.9, 28.3, 25.7, 18.1, -4.4, -4.8
MS (ESI): <i>m/z</i>	:	342 (M <sup>+</sup> +H), 364 (M <sup>+</sup> +Na)

### 5. Preparation of *tert*-butyl (1*S*,2*S*,3*S*,6*R*)-2-(*tert*-butyldimethylsilyloxy)-5-oxo-7-oxabicyclo[4.1.0]heptan-3-ylcarbamate (**39**)



To a solution of **38** (0.050 g, 0.146 mmol) in dry THF (2 mL) at 0 °C, was added Triton B (N-benzyltrimethylammonium hydroxide, 40% wt in methanol, 0.011 mL, 0.0293 mmol) and *t*-BuOOH (0.14 mL, 0.733 mmol, 5.0-6.0 M in decane). After 3 h at 0 °C, water and saturated aqueous NH<sub>4</sub>Cl solution were added. The mixture was extracted with EtOAc, dried over Na<sub>2</sub>SO<sub>4</sub> and evaporated to give a colourless residue which was purified by column chromatography. Elution with AcOEt:pet-ether 07:9.3 afforded **39** (0.044 g, 85% ) as a white solid.

mp	:	110-111 °C
[α] <sup>29</sup> <sub>D</sub>	:	-45.0 (c 0.5, CHCl <sub>3</sub> )
<sup>1</sup> H NMR (400 MHz, CDCl <sub>3</sub> ) δ	:	4.48 (m, 1H) 4.29 (m, 1H) 3.50 (dd, <i>J</i> = 3.7, 3.5 Hz, 1H) 3.27 (d, <i>J</i> = 3.7 Hz) 2.58 (dd, <i>J</i> = 18.3, 6.2 Hz, 1H) 2.20 (dd, <i>J</i> = 18.3, 11.0 Hz, 1H) 1.43 (s, 9H) 0.89 (s, 9H) 0.13 (s, 6H)
<sup>13</sup> C NMR (100 MHz, CDCl <sub>3</sub> ) δ	:	202.7, 154.6, 79.7, 67.5, 56.3, 53.7, 45.0, 38.7, 29.6, 28.3, 25.6, 18.0, -4.43
MS (ESI): <i>m/z</i>	:	358 (M <sup>+</sup> +H), 380 (M <sup>+</sup> +Na)

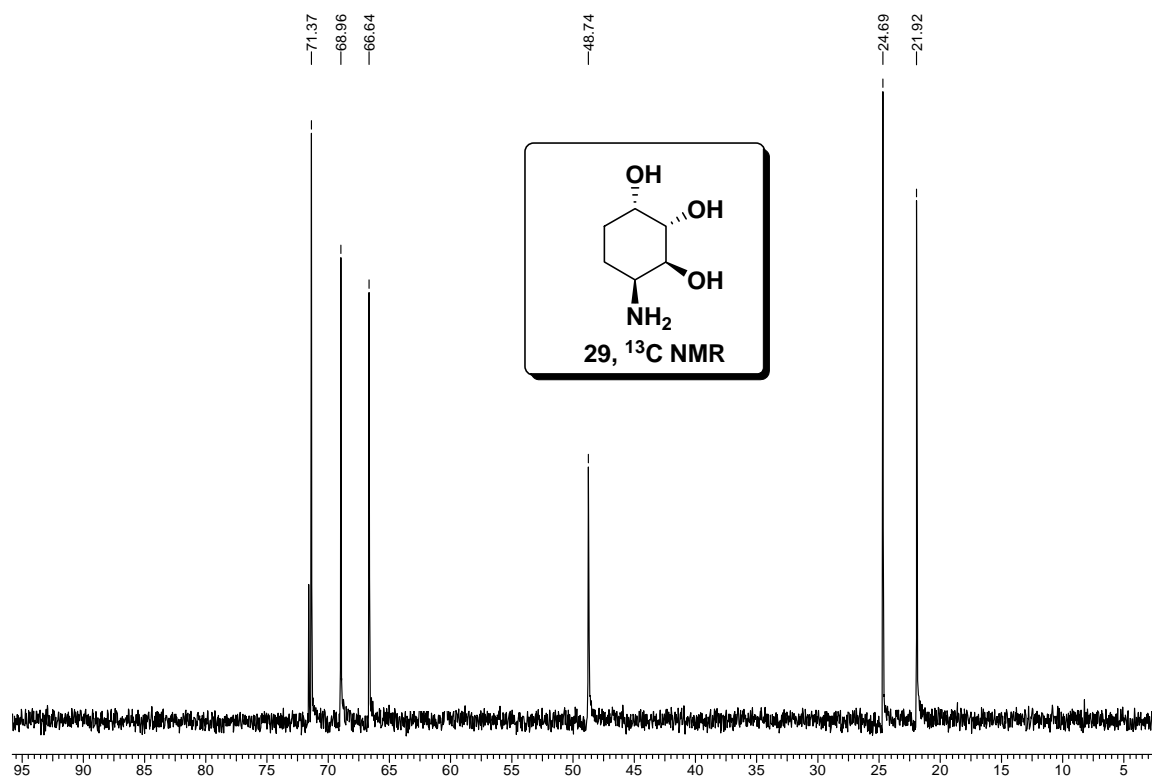
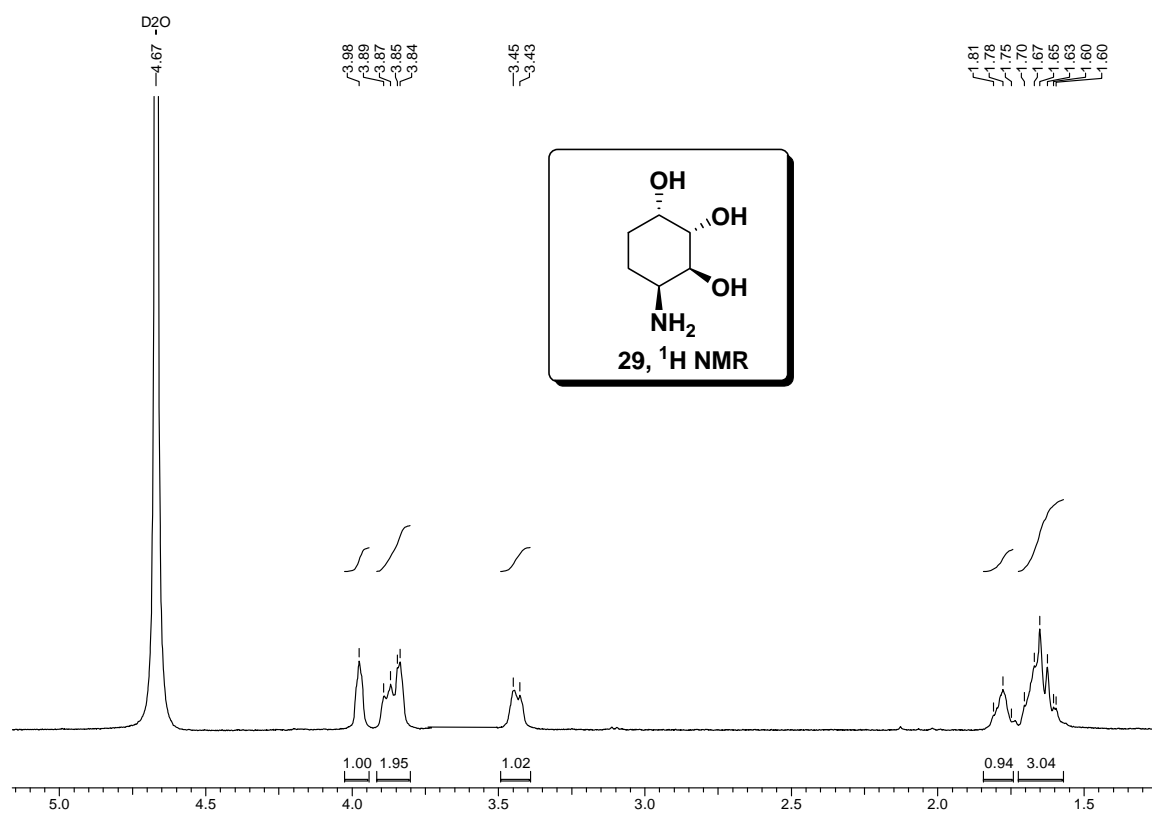


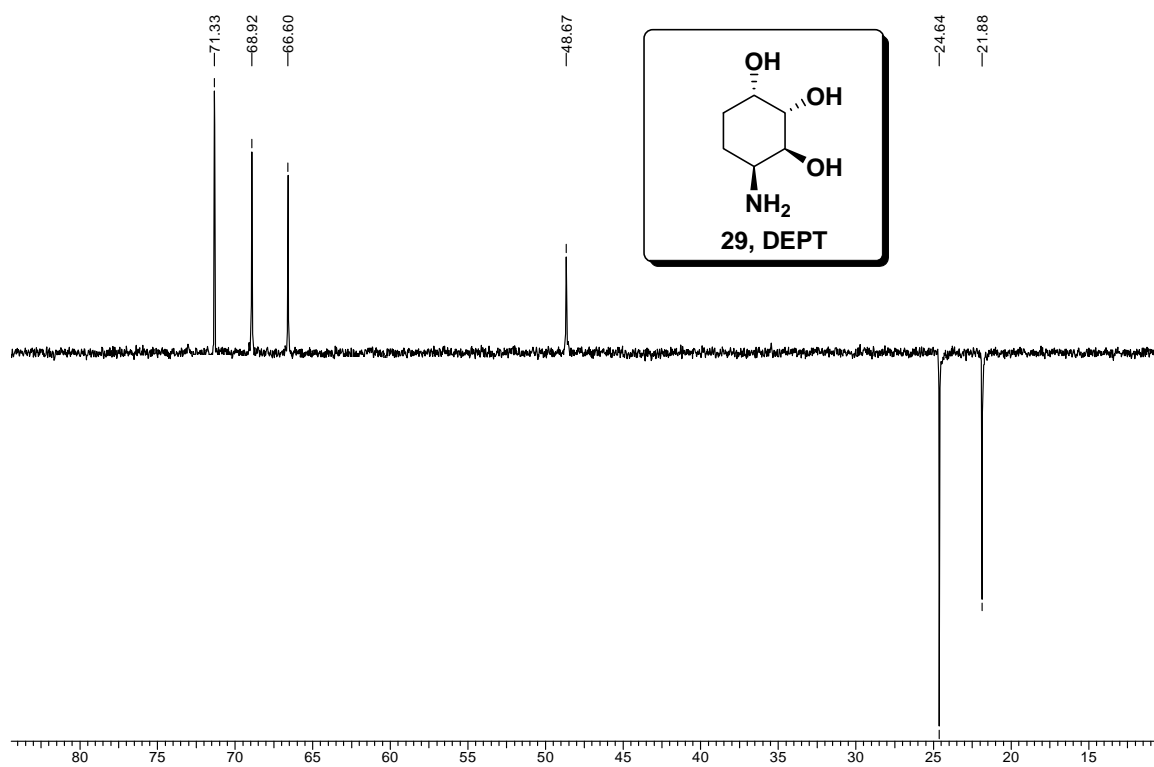
---

### 3.6 References

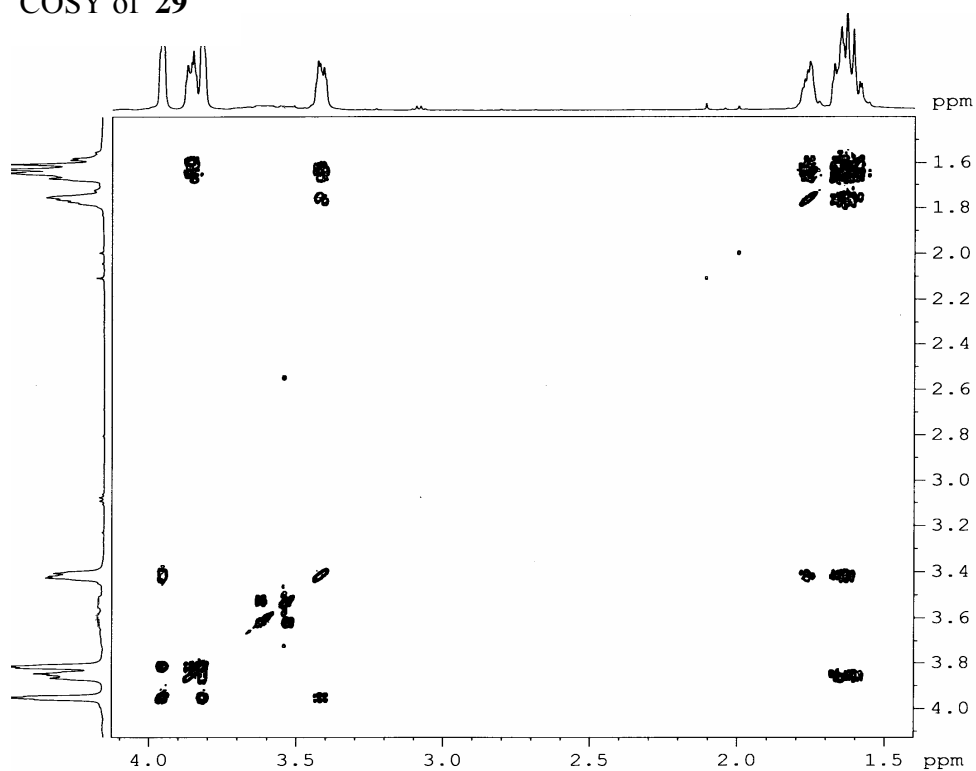
1. Wang, H.; Tor, Y. *Angew. Chem. Int. Ed.*, **1998**, *37*, 109.
2. (a) Vartesy, L.; Fehlhaber, H. W.; Schulz, A. *Angew. Chem. Int. Ed.*, **1994**, *33*, 1844. (b) Ogawa, S.; Ashiura, M.; Uchida, C.; Wantabe, S.; Yamazaki, C.; Yamagishi, K.; Inokuchi, J. *Bioorg. Med. Chem. Lett.* **1996**, *6*, 929. (c) Lew, W.; Williams, M. A.; Mendel, D. B.; Escarpe, P. A.; Kim, C. U. *Bioorg. Med. Chem. Lett.* **1997**, *7*, 1843. (d) Sears, P.; Wong, C. H. *J. Chem. Soc. Chem. Comm.* **1998**, 1161 and references cited therein.
3. Shing, T. K. M.; Wan, L. H. *J. Org. Chem.* **1996**, *61*, 8468.
4. (a) Ogawa, S.; Mori, M.; Takeuchi, G.; Doi, F.; Watanabe, M.; Sakata, Y. *Bioorg. Med. Chem. Lett.* **2002**, *12*, 2811. (b) Ogawa, S.; Fujieda, S.; Sakata, Y.; Ishizaki, M.; Hisamatsu, S.; Okazaki, K. *Bioorg. Med. Chem. Lett.* **2003**, *13*, 3461.
5. Delgado, A.; Casas, J.; Llebaria, A.; Abad, J. L.; Fabrias, J. *ChemMedChem* **2007**, *2*, 580.
6. Yu, Z.; Sawkar, A. R.; Kelley, J. W. *FEBS Lett.* **2007**, *274*, 4944.
7. (a) Tsunoda, H.; Ogawa, S. *Liebigs Ann. Chem.* **1994**, 103. (b) Tsunoda, H.; Ogawa, S. *Liebigs Ann. Chem.* **1995**, 267. (c) Tsunoda, H.; Inokuchi, J.-I.; Yamagishi, K.; Ogawa, S. *Liebigs Ann. Chem.* **1995**, 279.
8. (a) Ogawa, S.; Sekura, R.; Maruyama, A.; Yuasa, H.; Hashimoto, H. *Eur. J. Org. Chem.* **2000**, 2089. (b) Ogawa, S.; Maruyama, A.; Odagiri, T.; Yuasa, H.; Hashimoto, H. *Eur. J. Org. Chem.* **2001**, 967.
9. Donohoe, T. J.; Moore, P. R.; Beddoes, R. L. *J. Chem. Soc. Perkin Trans. 1* **1997**, 43.
10. Shimizu, H.; Okamura, H.; Yamashita, N.; Iwagawa, T.; Nakatani, M. *Tetrahedron Lett.* **2001**, *42*, 8649.
11. Y. J-Q.; Corey, E. J. *Org. Lett.* **2002**, *4*, 2727.
12. Comins, D. L.; Dehghani, A. *Tetrahedron Lett.* **1992**, *33*, 6299.

## 3.7 Spectra

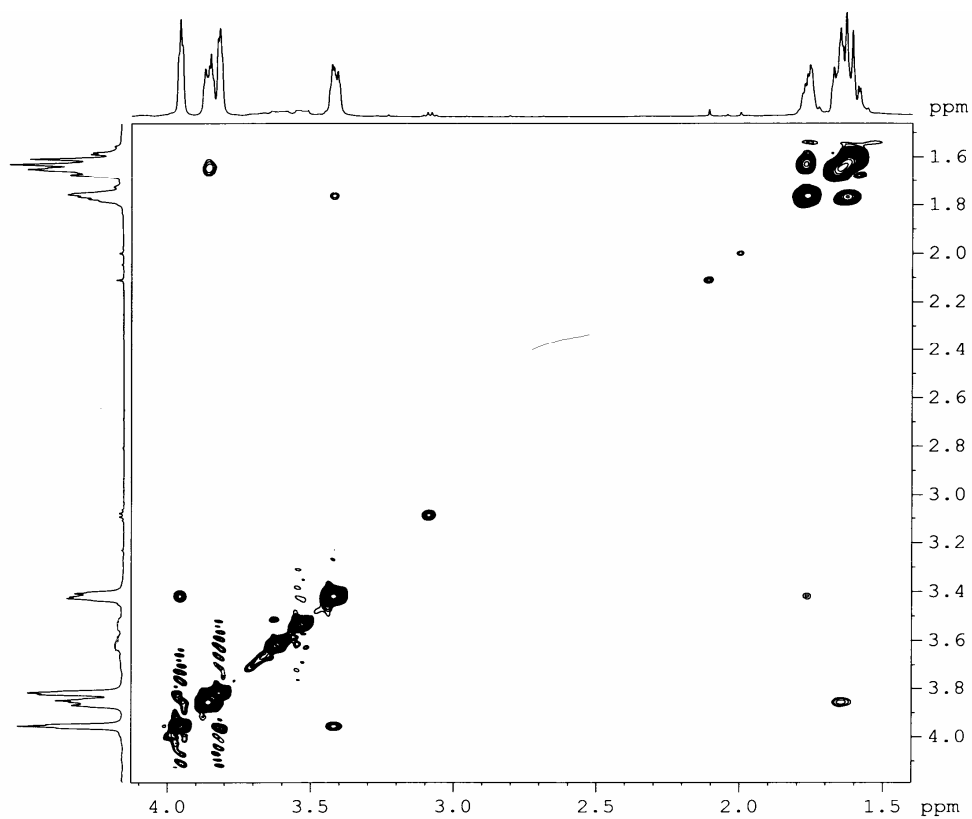




COSY of 29



## NOESY of 29



Chloroform-d

-7.25  
-6.93  
-6.92  
-6.91  
-6.90-6.14  
-6.12

-5.49

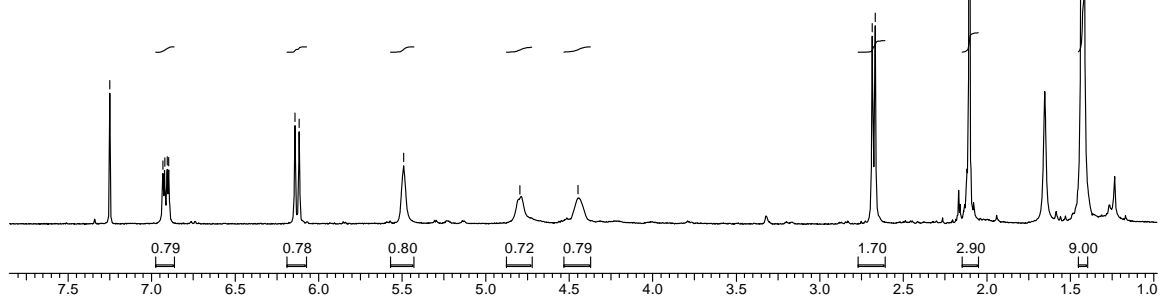
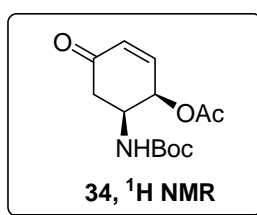
-4.80

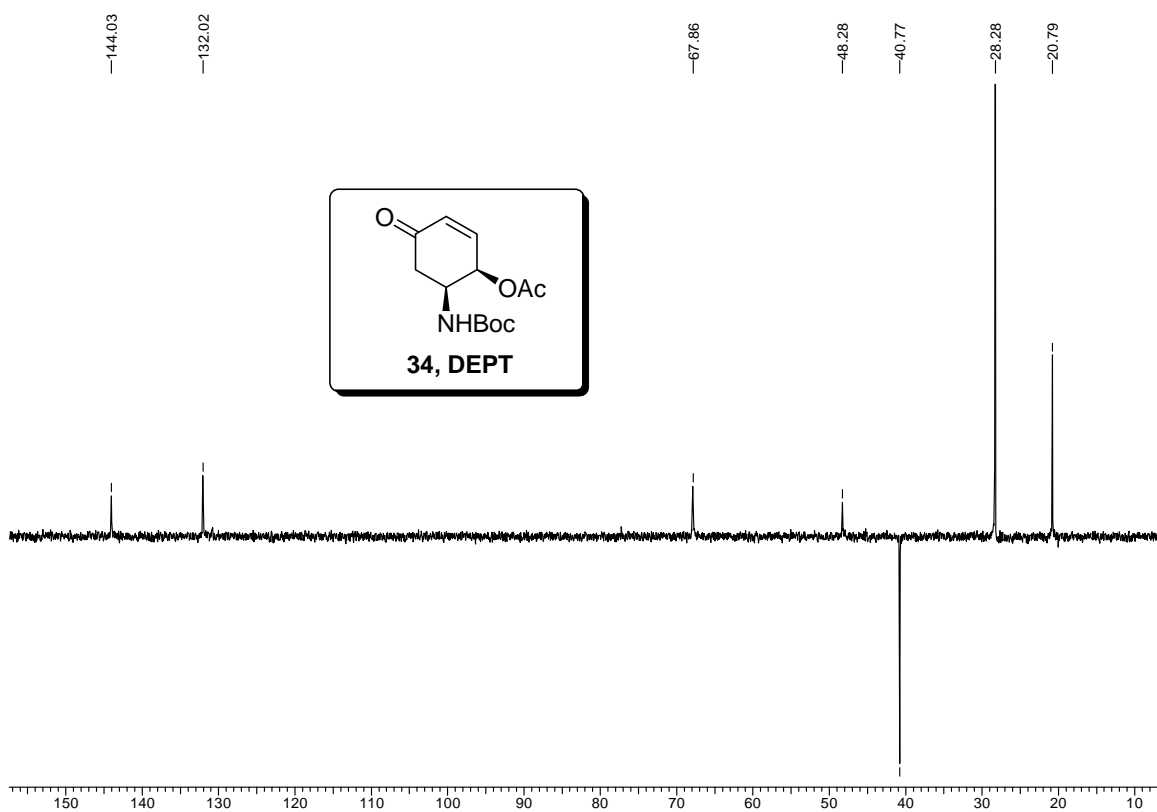
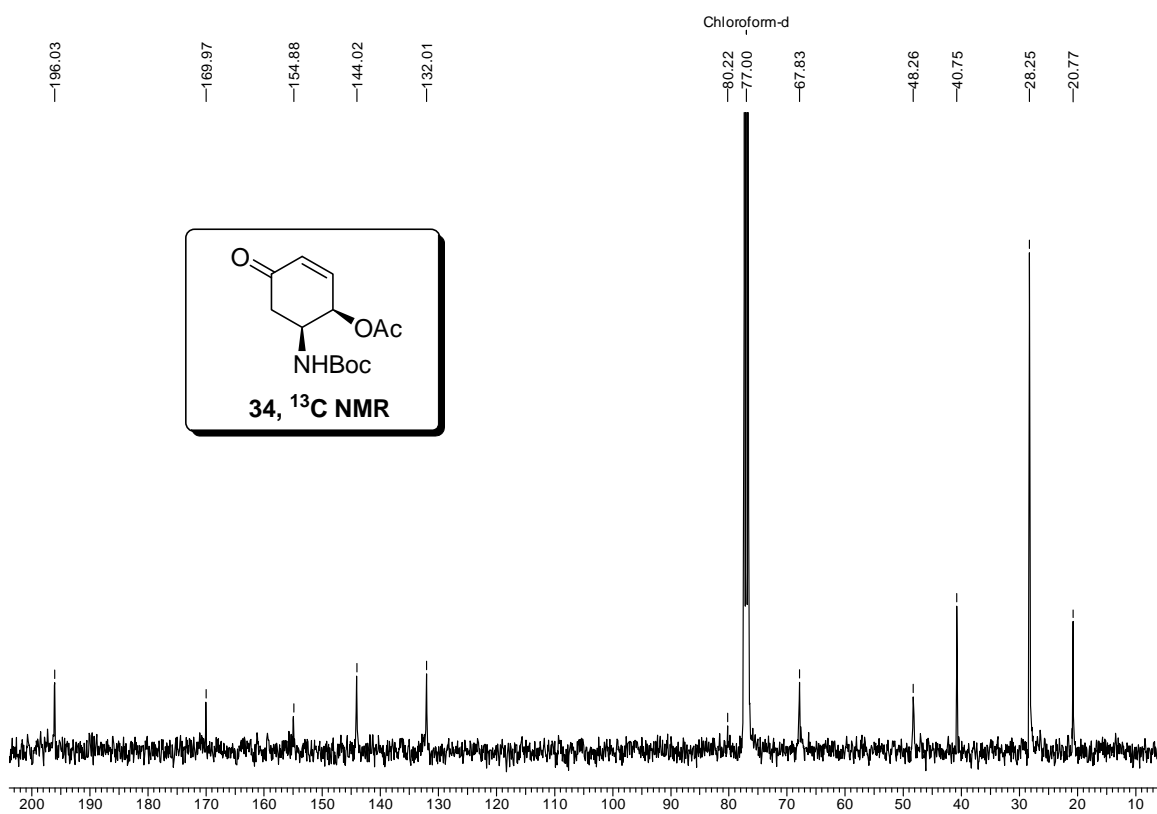
-4.45

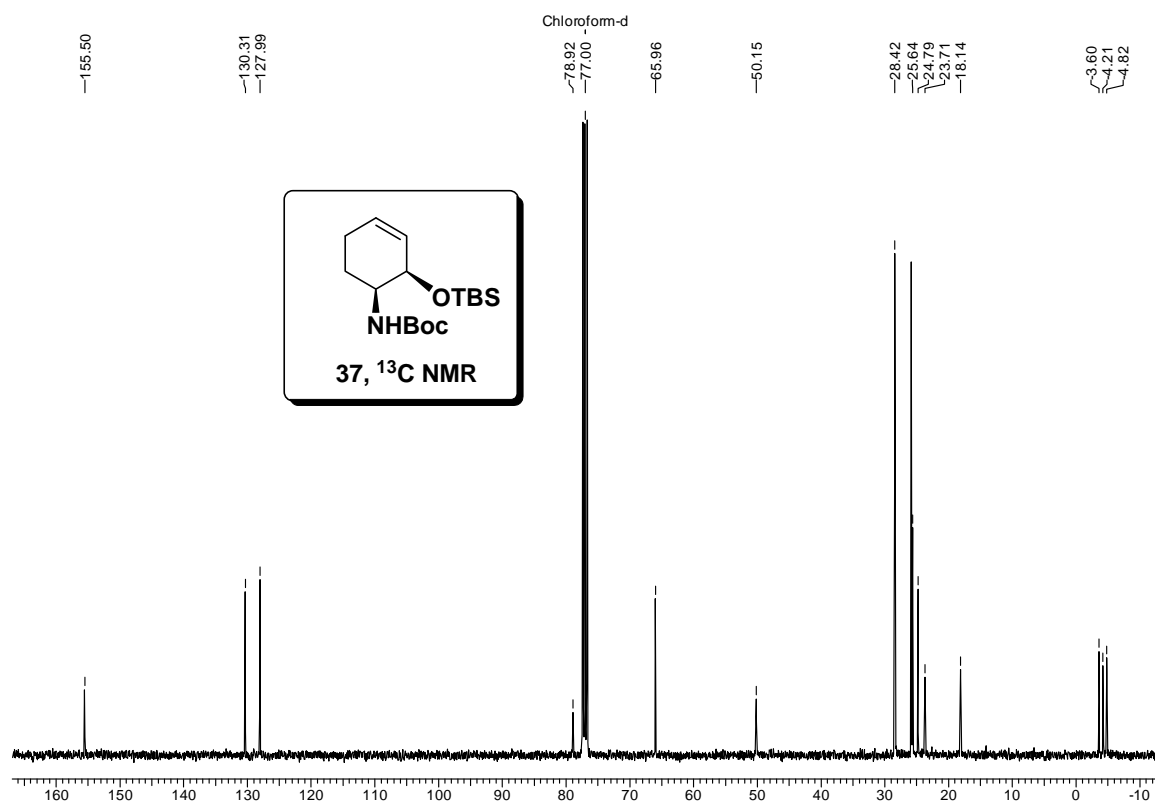
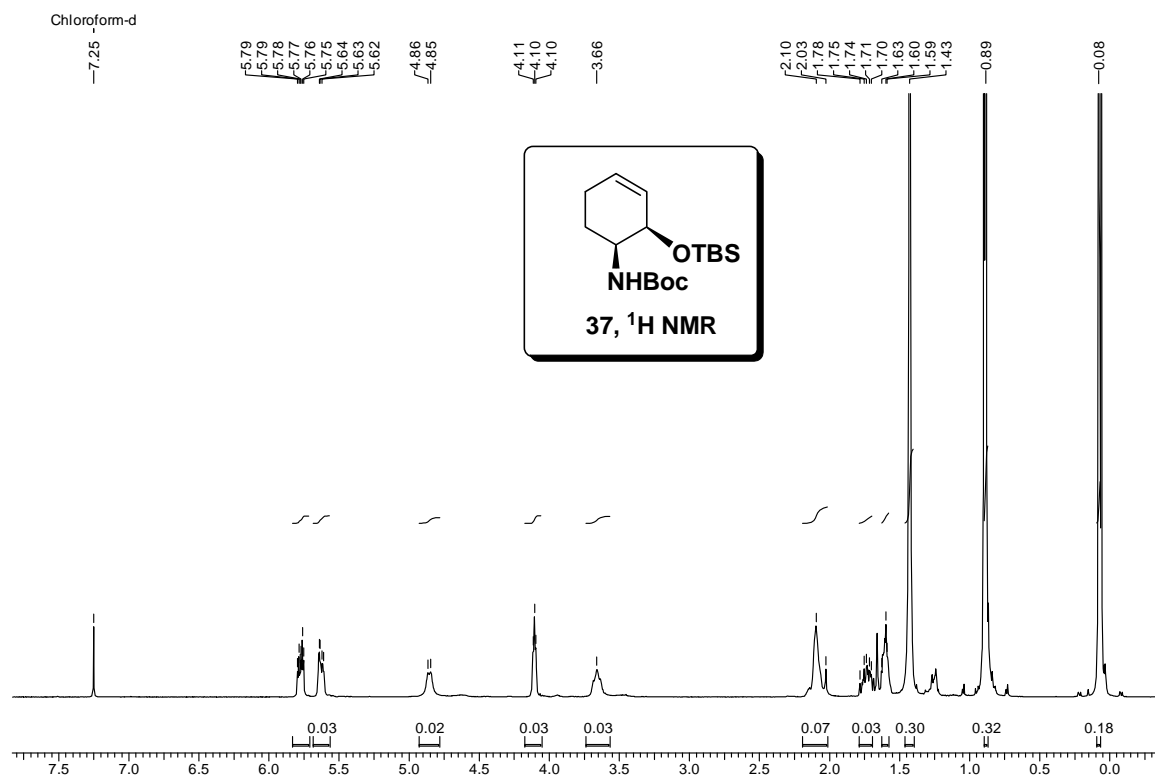
-2.69  
-2.67

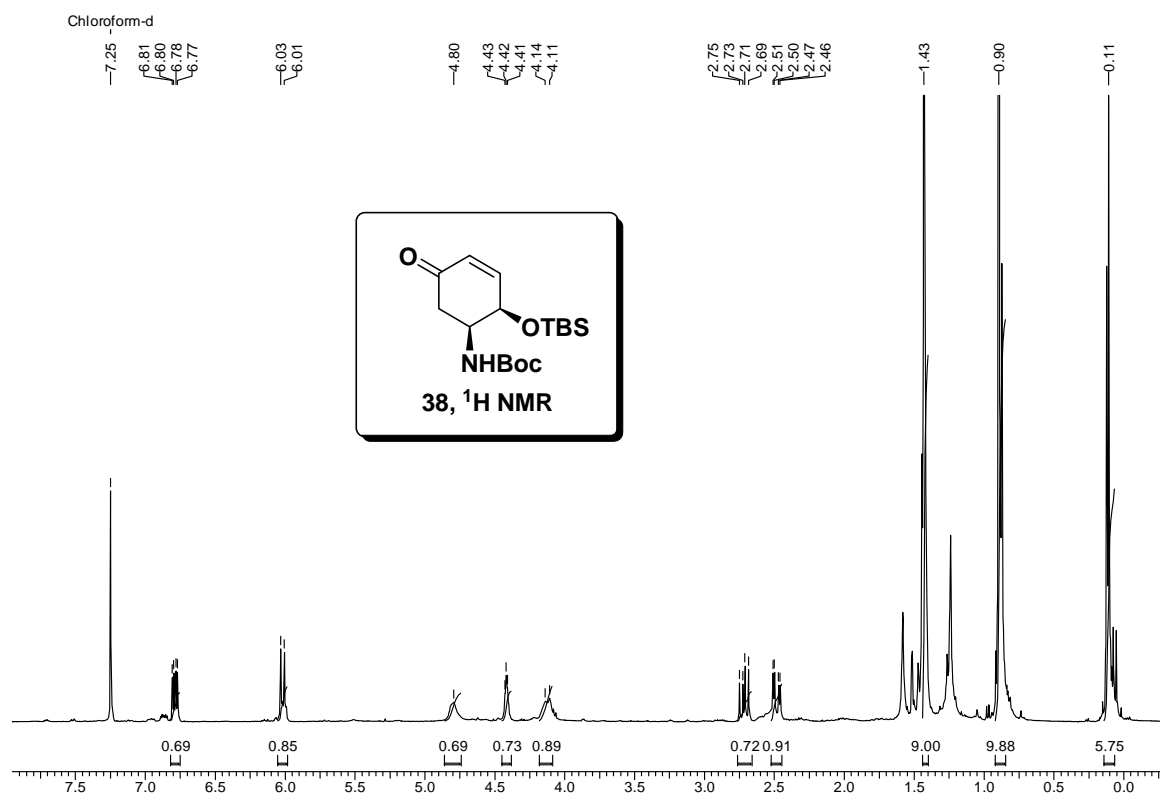
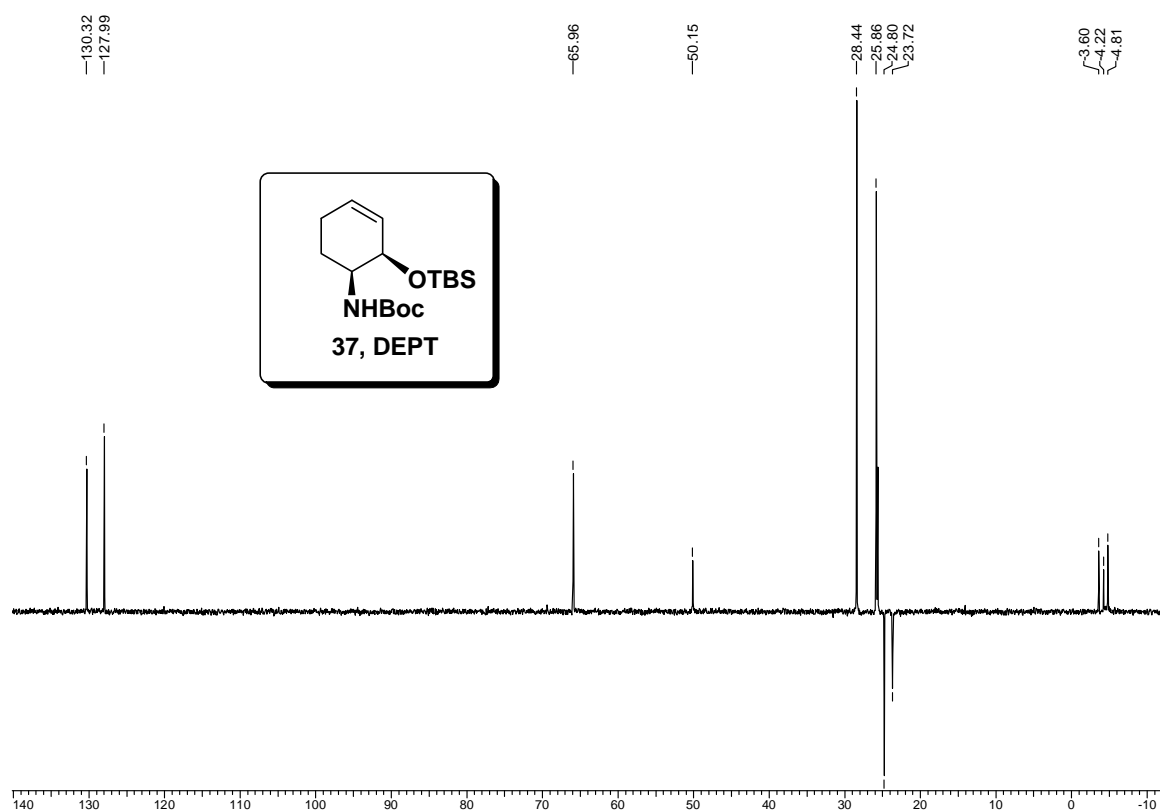
-2.10

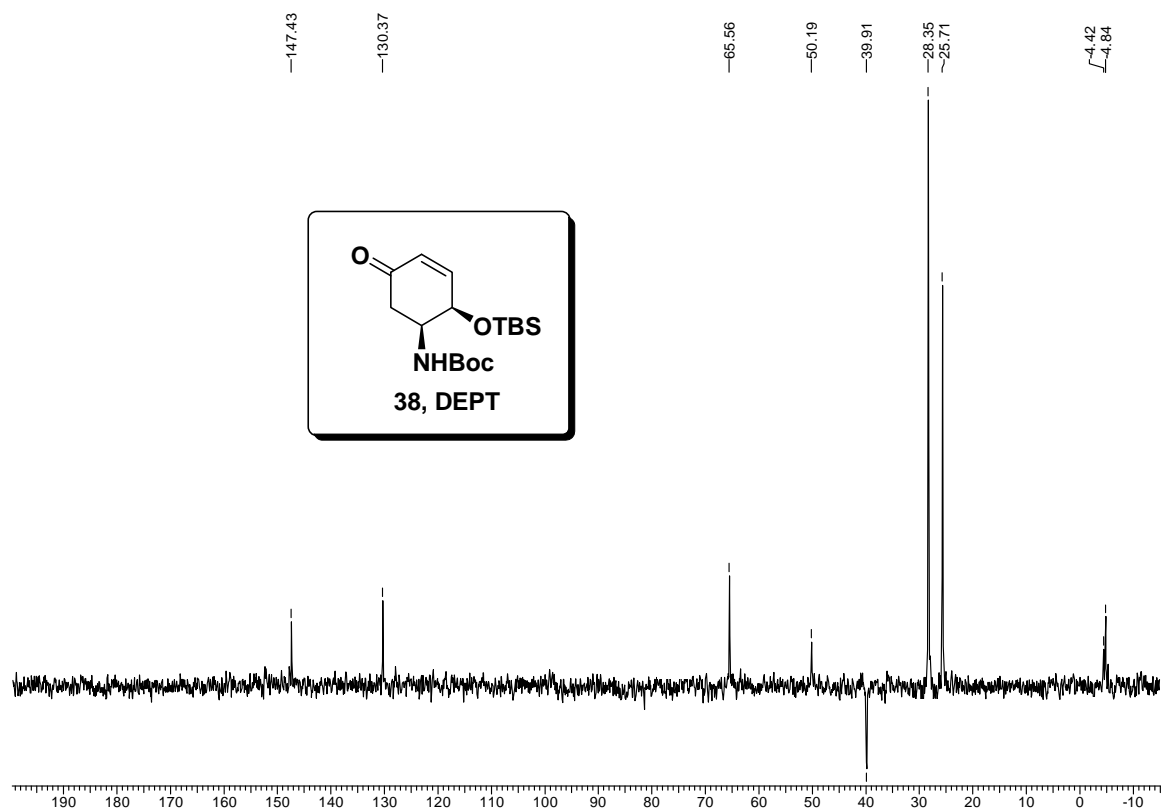
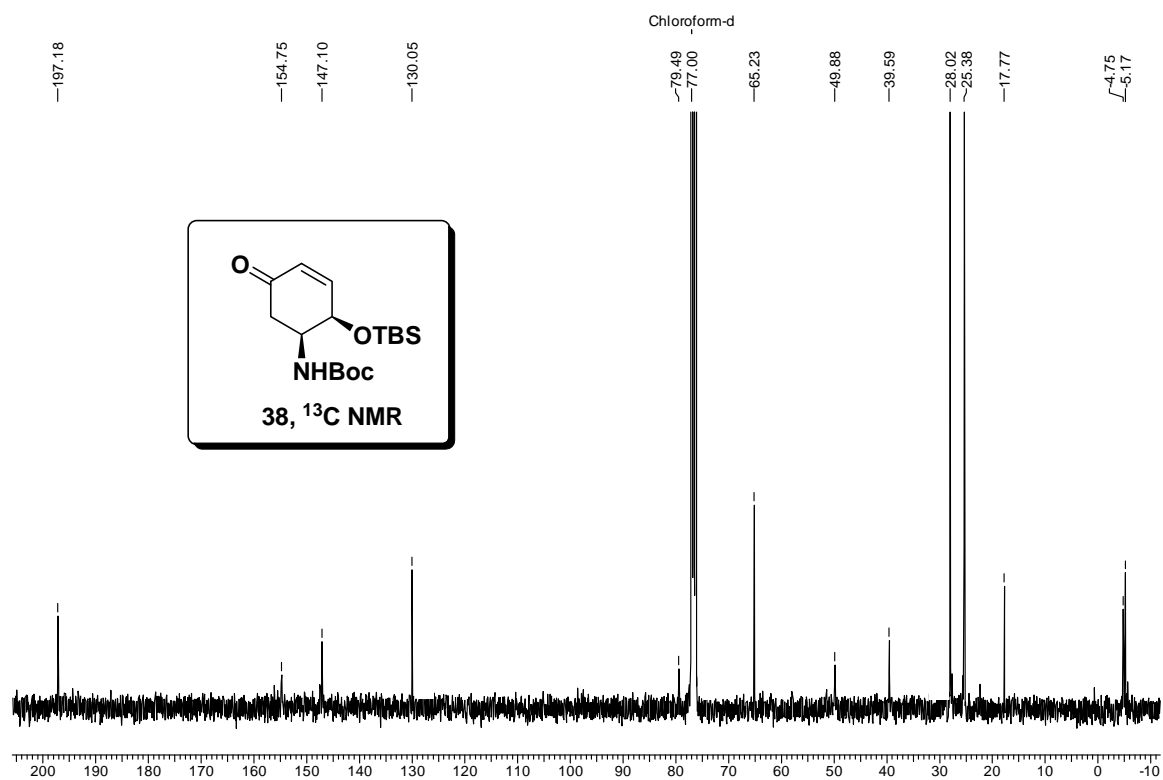
-1.43



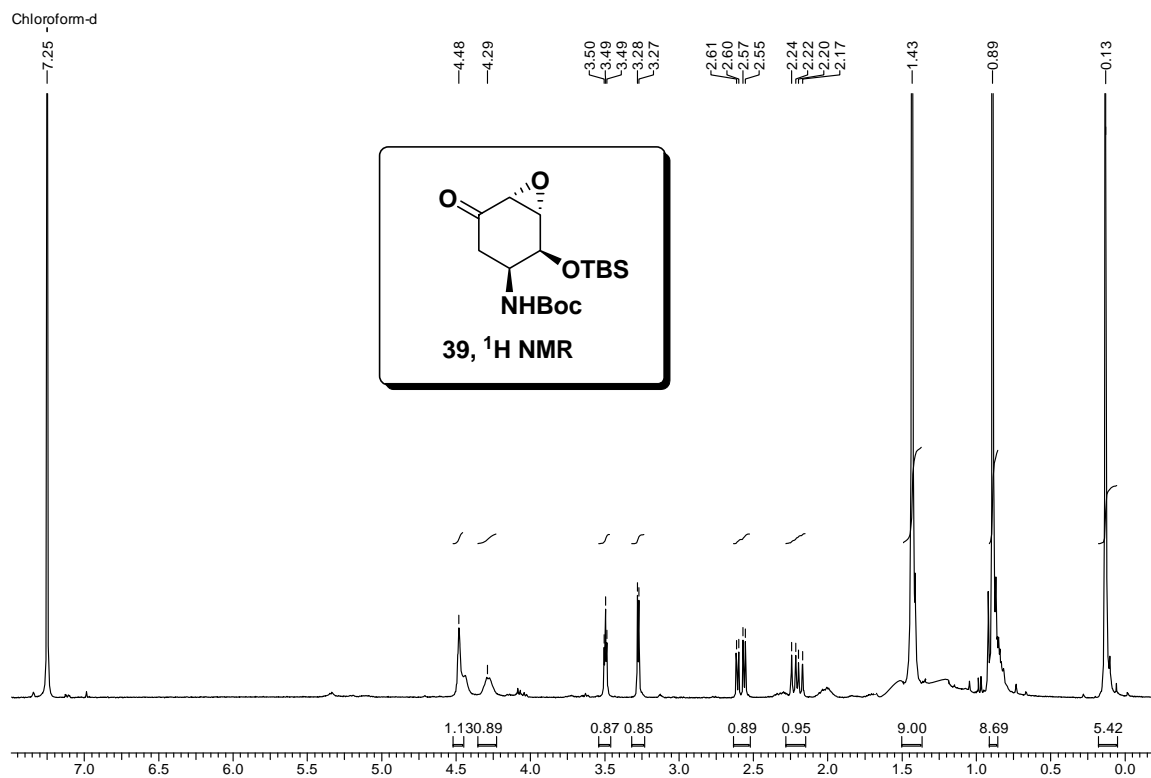
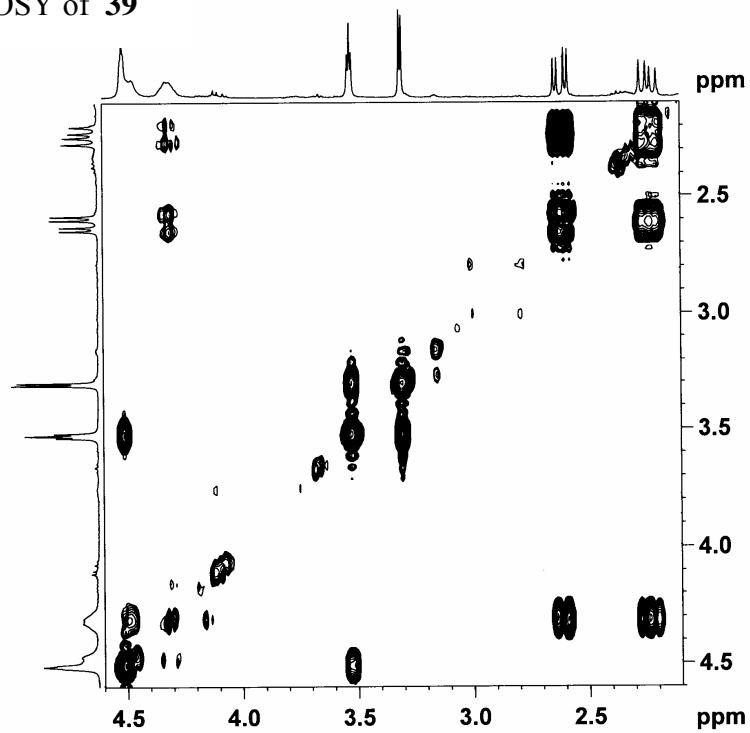


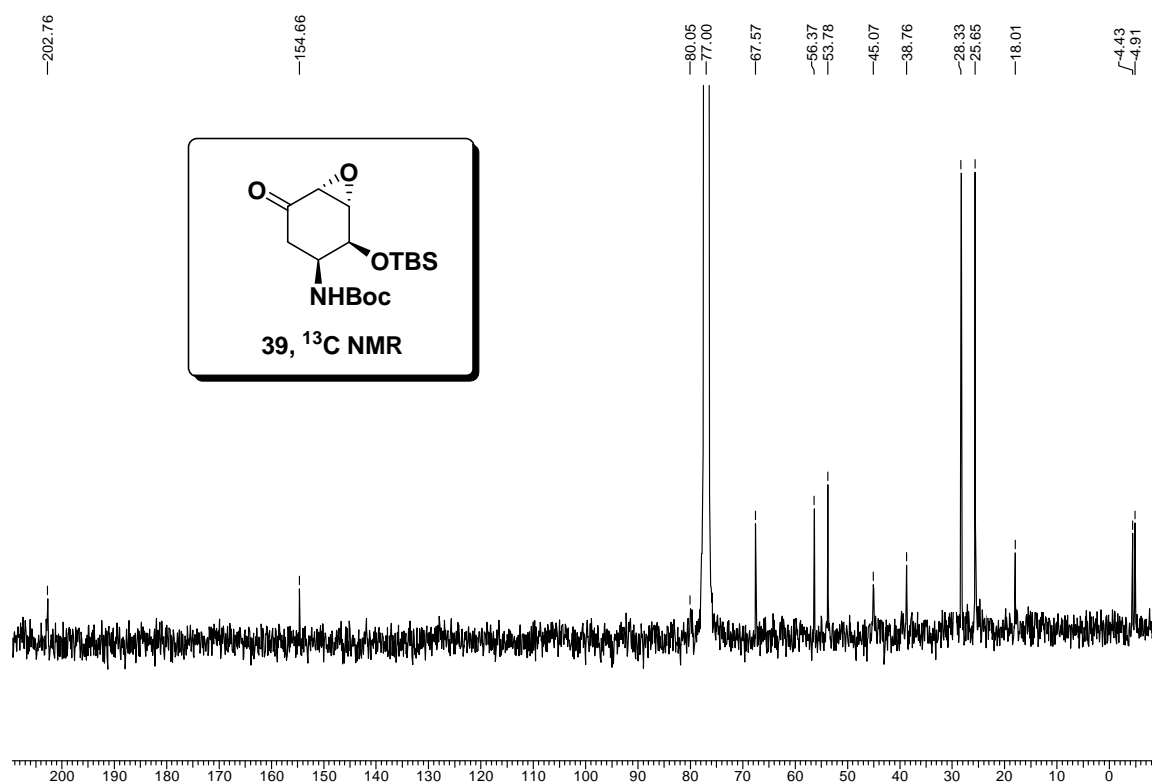
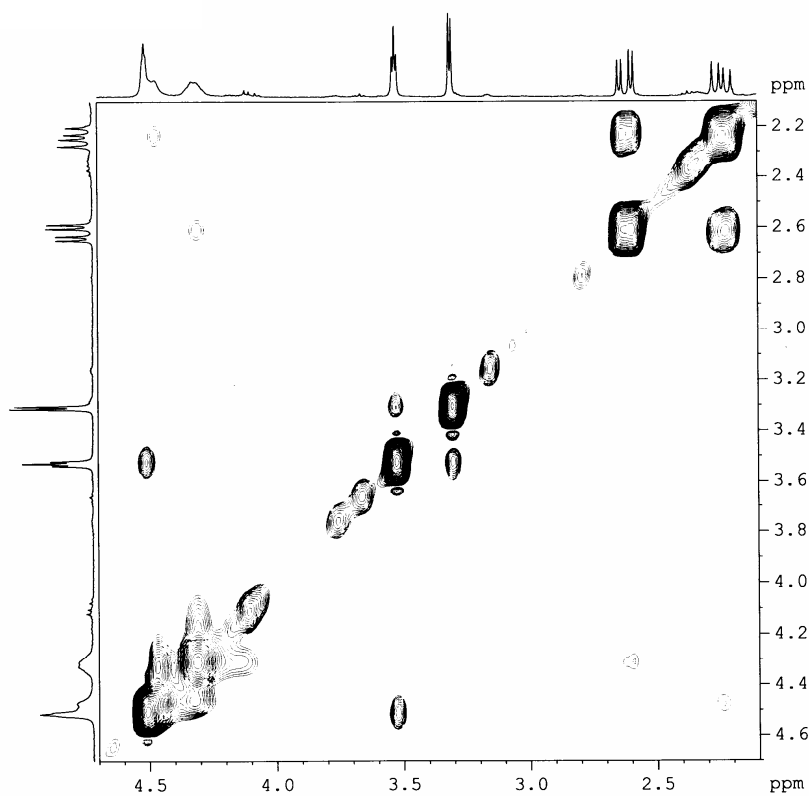


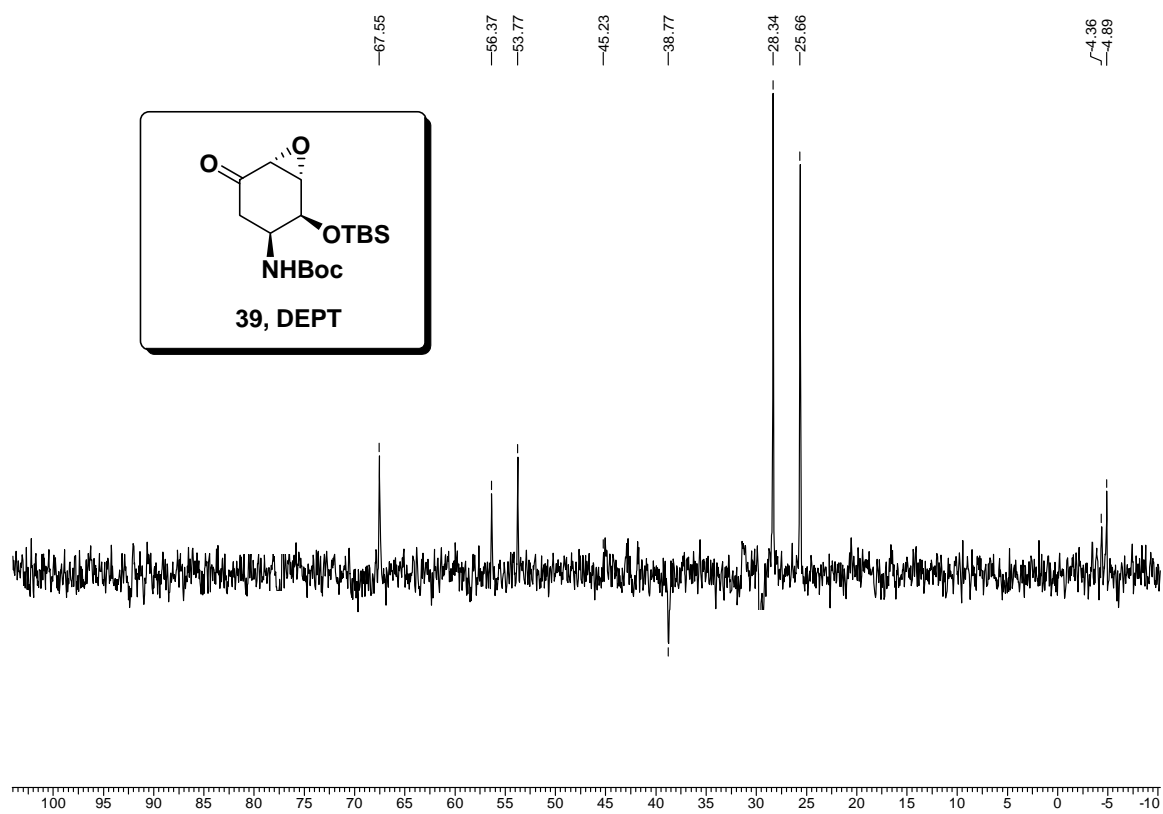






COSY of **39**

NOESY of **39**



# Use of Enantiomerically Pure 7-Azabicyclo[2.2.1]heptan-2-ol as a Chiral Template for the Synthesis of Aminocyclitols

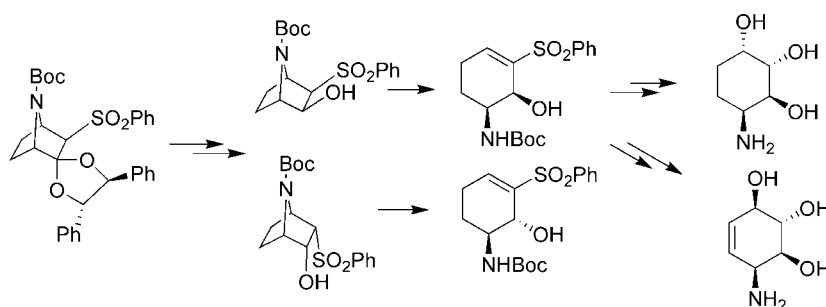
Ganesh Pandey,<sup>\*,†</sup> Keshri Nath Tiwari,<sup>†</sup> and V. G. Puranik<sup>‡</sup>

Division of Organic Chemistry and Centre for Material Characterization, National Chemical Laboratory, Pune 411008, India

gp.pandey@ncl.res.in

Received June 19, 2008

## ABSTRACT



Using enantiopure 7-azabicyclo[2.2.1]heptane-2-ol, the synthesis of *cis*- as well as *trans*-2-aminocyclohexanols, dihydroconduramine E-1, and *ent*-conduramine F-1 has been described.

Various aminocyclitols, natural (**1**) as well as synthetic (Figure 1), possess the ability to mimic oligosaccharides,<sup>1</sup> making them potential candidates as inhibitors of glycosidases. In particular, conduramines **2** and **3**, apart from being

used as probes for biological functions of oligosaccharides,<sup>2,3</sup> have also served as important synthetic precursors of amino- and diaminocyclitols<sup>4</sup> and for many other biologically active compounds.<sup>5</sup> Therefore, it is not surprising to see the considerable research interest by synthetic chemists toward the synthesis of aminocyclitols<sup>6</sup> and conduramines.<sup>7</sup>

Owing to our broad interest in the design, synthesis, and evaluation of new azasugars as glycosidase inhibitors,<sup>8</sup> it

<sup>†</sup> Division of Organic Chemistry.

<sup>‡</sup> Centre for Material Characterization.

(1) Sears, P.; Wong, C.-H. *Angew. Chem., Int. Ed.* **1999**, *38*, 2300–2324.

(2) (a) For biological properties of conduramines, see: Lysek, R.; Favre, S.; Vogel, P. *Tetrahedron* **2007**, *63*, 6558–6572, and references cited therein. (b) Lysek, R.; Schutz, C.; Vogel, P. *Bioorg. Med. Chem. Lett.* **2005**, *15*, 3071–3075.

(3) Paul, B. J.; Willis, J.; Martinot, T. A.; Ghiviriga, I.; Abboud, K. A.; Hudlicky, T. *J. Am. Chem. Soc.* **2002**, *124*, 10416–10426.

(4) (a) Chida, N.; Ohtsuka, M.; Nakazawa, K.; Ogawa, S. *J. Org. Chem.* **1991**, *56*, 2976–2983. (b) Schurrle, K.; Beier, B.; Piepersberg, W. *J. Chem. Soc., Perkin Trans. 1* **1991**, 2407–2412.

(5) (a) Hudlicky, T.; Rouden, J.; Luna, H. *J. Org. Chem.* **1993**, *58*, 985–987. (b) Hudlicky, T.; Rouden, J.; Luna, H.; Allen, S. *J. Am. Chem. Soc.* **1994**, *116*, 5099–5107. (c) Hudlicky, T.; Nugent, T.; Griffith, W. *J. Org. Chem.* **1994**, *59*, 7944–7946. (d) Chida, N.; Ohtsuka, M.; Ogawa, S. *Tetrahedron Lett.* **1991**, *32*, 4525–4528. (e) Hudlicky, T.; Olivo, H. F. *J. Am. Chem. Soc.* **1994**, *116*, 5108–5115.

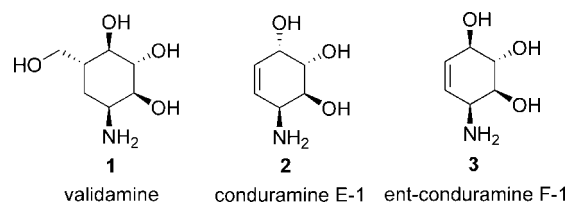
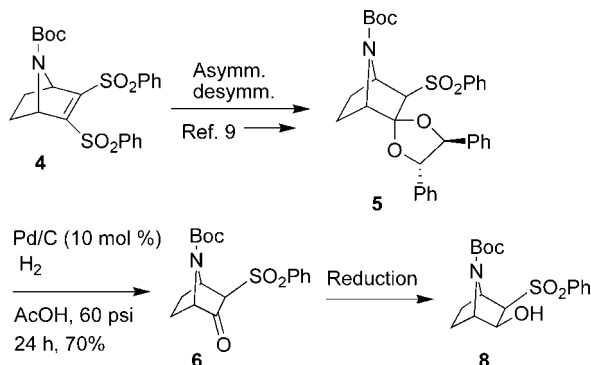


Figure 1. Some bioactive cyclic polyhydroxylated amines.

occurred to us that designing a chiral template to obtain aminocyclitols (natural and synthetic) would be an important contribution to this area. In this context, we envisioned the potential of substrate **8** for the synthesis of various aminocyclohexanols. Compound **8** could easily be obtained from optically pure 7-azabicyclo[2.2.1]hept-2-one **6**, synthesized by us a few years ago<sup>9</sup> via asymmetric desymmetrization of *meso*-**4** (Scheme 1). We had developed this strategy to synthesize (–)-epibatidine,<sup>10</sup> a powerful non-opioid analgesic.

**Scheme 1.** Synthesis of Chiral Template **8**



The idea of utilizing **8** as a chiral template for the synthesis of aminocyclitols in general emerged from its rigid bicyclic structure<sup>11</sup> and suitably juxtaposed functionalities for its easy transformation to aminocyclohexenol derivative **9** useful for the synthesis of scores of aminocyclitols as described in Scheme 2. In this paper, we disclose our preliminary results on the successful demonstration of the synthesis and use of **8** as a chiral template for the synthesis of aminocyclitols.

Desymmetrized compound **5** was obtained in 80% yield (99% de) by asymmetric desymmetrization of *meso*-**4** by employing our previously described protocol.<sup>9</sup> Removal of the ketal moiety from **5** by hydrogenation (Pd/C, 10 mol%,

(6) Alegret, C.; Benet-Buchholz, J.; Riera, A. *Org. Lett.* **2006**, *8*, 3069–3072, and references cited therein.

(7) (a) Kelebekli, L.; Celik, M.; Sahin, E.; Kara, Y.; Balci, M. *Tetrahedron Lett.* **2006**, *47*, 7031–7035. (b) Spielvogel, D.; Kammerer, J.; Prinzbach, H. *Tetrahedron Lett.* **2000**, *41*, 7863–7867. (c) Akgun, H.; Hudlicky, T. *Tetrahedron Lett.* **1999**, *40*, 3081–3084. (d) Jotterand, N.; Vogel, P. *Synlett* **1998**, 1237–1239. (e) Trost, B. M.; Pulley, S. R. *Tetrahedron Lett.* **1995**, *36*, 8737–8740. (f) Leung-Toung, R.; Liu, Y.; Muchowski, J. M.; Wu, Y.-L. *J. Org. Chem.* **1998**, *63*, 3235–3250.

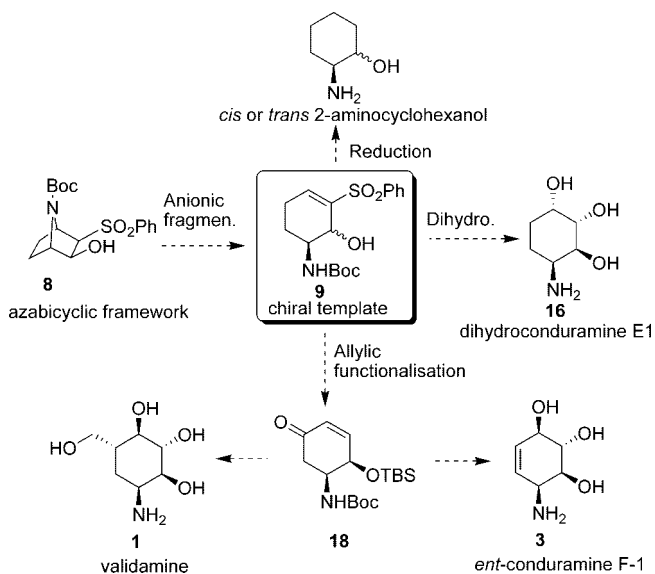
(8) (a) Pandey, G.; Kapur, M. *Tetrahedron Lett.* **2000**, *41*, 8821–8824. (b) Pandey, G.; Kapur, M. *Synthesis* **2001**, 1263–1267. (c) Pandey, G.; Kapur, M. *Org. Lett.* **2002**, *4*, 3883–3886. (d) Pandey, G.; Kapur, M.; Khan, M. I.; Gaikwad, S. M. *Org. Biomol. Chem.* **2003**, *1*, 3321–3326. (e) Pandey, G.; Dumbre, S. G.; Khan, M. I.; Shabab, M.; Puranik, V. G. *Tetrahedron Lett.* **2006**, *47*, 7923–7926. (f) Pandey, G.; Dumbre, S. G.; Khan, M. I.; Shabab, M. *J. Org. Chem.* **2006**, *71*, 8481–8488. (g) Pandey, G.; Dumbre, S. G.; Pal, S.; Khan, M. I.; Shabab, M. *Tetrahedron* **2007**, *63*, 4756–4761.

(9) Pandey, G.; Tiwari, S. K.; Singh, R. S.; Mali, R. S. *Tetrahedron Lett.* **2001**, *42*, 3947–3949.

(10) Spand, T. F.; Garraffo, H. M.; Edwards, M. W.; Yeh, H. J. C.; Pannell, L.; Daly, J. W. *J. Am. Chem. Soc.* **1992**, *114*, 3475–3478.

(11) (a) For 7-azanorborene systems, see: Hernandez, A.; Marcos, M.; Rapoport, H. *J. Org. Chem.* **1995**, *60*, 2683–2691. (b) Moreno-Vargas, A. J.; Robina, I.; Petricci, E.; Vogel, P. *J. Org. Chem.* **2004**, *69*, 4487–4491, and references cited therein. (c) Wei, Z.-L.; George, C.; Kozikowski, A. P. *Tetrahedron Lett.* **2003**, *44*, 3847–3850.

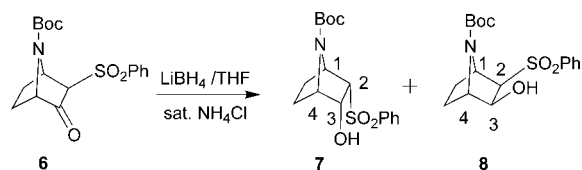
**Scheme 2.** Imaginative Pathway for the Synthesis of Aminocyclitols



AcOH, 60 psi) provided **6** in 70% yield as a diastereomerically pure compound<sup>12</sup> along with the recovery of starting material **5** (30%) (Scheme 1).

We hoped that reduction of **6** with lithium borohydride would furnish only **8**, owing to *endo*-attack of the hydride on carbonyl group. However, it unexpectedly gave a diastereomeric mixture of alcohols **7** and **8** (1:9) (Scheme 3).

**Scheme 3.** Reduction of Ketone



Fortunately, both diastereomers could be easily separated by silica gel column chromatography.

The relative configurations of both alcohols were unambiguously deduced from their <sup>1</sup>H NMR spectrum in CDCl<sub>3</sub>. For illustration, the H-2 in **7** appeared as dd ( $J = 9.3, 4.4$  Hz) coupling with bridgehead H-1 and H-3 whereas H-3 appeared as ddd ( $J = 9.6, 9.3, 4.6$  Hz) coupling with H-2, bridgehead H-4 and -OH. The coupling with -OH ( $J = 9.6$  Hz) was confirmed by D<sub>2</sub>O exchange which simplified the coupling to dd ( $J = 9.3, 4.6$  Hz). Similarly, in the case of **8**, the H-2 showed doublet ( $J = 6.5$  Hz) coupling only with H-3, whereas H-3 appeared as dd ( $J = 9.7, 6.5$  Hz) coupling with H-2 as well as O–H indicating the *endo*-orientation for H-3. This observation is in complete agreement with the

(12) The observed NMR splitting pattern in **6** is because of restricted rotation about the NCO bond (rotamers). For similar observations, see: Pavri, N. P.; Trudell, M. L. *Tetrahedron Lett.* **1997**, *38*, 7993–7996.

literature reports<sup>13,14</sup> where no coupling is seen between bridgehead and the *endo*-proton in the 7-azabicyclo[2.2.1]heptane system. Since reduction of **6** at room temperature produced diastereomeric mixtures of the corresponding alcohols (**7** and **8**), it became obvious to us that there was an epimerization of H-2 during reduction. Therefore, it occurred to us to investigate the reduction at lower temperature with the hope that it might offer diastereoselectivity. However, to our surprise, the results showed complete reversal in the diastereoselectivity and the ratio of **7** and **8** with respect to temperature is shown in Table 1.

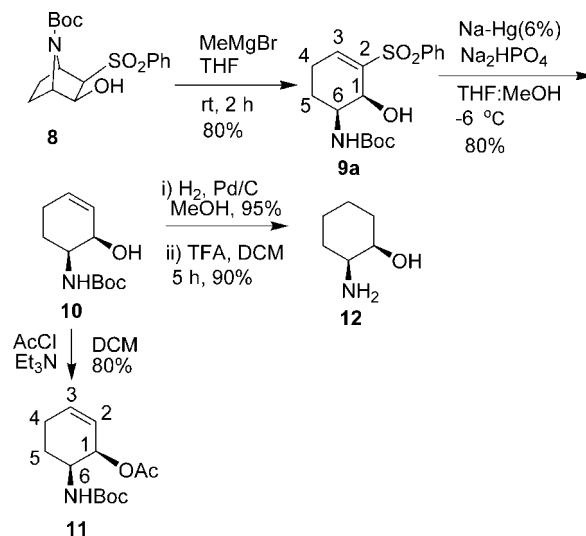
**Table 1.** Yields and Ratio of **7** and **8** during Reduction of Ketone

entry	<i>T</i> (°C)	ratio ( <b>7</b> / <b>8</b> )	time	yield (%) (combined)
1	-78	7:3	30 min	75
2	-90	7.5:2.5	45 min	70
3	25	1:9	12 h	78

The formation of both **7** and **8**, possibly, could be rationalized by considering the base mediated ( $\text{BH}_4^-$ ) epimerization of H-2 and the orientation of phenylsulfonyl group directing the face of hydride attack on the carbonyl group. While at room temperature, the thermodynamically more stable *exo*-phenylsulfonyl moiety directs the *endo*-attack of the hydride ion resulting **8** as the major product, **7** is formed in larger proportions at lower temperature due to kinetically more favored *endo*-phenylsulfone.

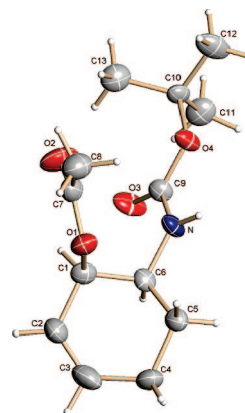
Initially, we tried the anionic rearrangement of **8** using bases such as LiHMDS and *n*-BuLi; however, they failed to give any product. Finally, ring opening of **8** succeeded by the addition of excess of methyl magnesium bromide<sup>7f</sup> in a THF solution at room temperature producing **9a** in 80% yield as a crystalline solid [mp 131 °C;  $[\alpha]^{25}_D$  -69.0 (*c* 1.00,  $\text{CHCl}_3$ )] (Scheme 4). Owing to undefined couplings between the two stereochemical protons (H-1 and H-6) in the  $^1\text{H}$  NMR of **9a** in  $\text{CDCl}_3$ , it proved difficult to assign relative configuration satisfactorily. Although **9a** was a good crystalline compound, it did not diffract properly for X-ray analysis. Therefore, we removed the phenylsulfonyl group from **9a** using 6% sodium amalgam in a buffered methanol and derivatized the free hydroxyl to corresponding *O*-acetate **11**. Luckily, this compound turned out to be a good crystalline solid (mp 66 °C) and produced the X-ray structure<sup>15</sup> (Figure 2) confirming the *cis*-1,6-amino alcohol configuration for **9a** (Scheme 4). Highly encouraged with the success of the ring-opening reaction of **8**, we considered that **7** could also be equally susceptible for rearrangement. However, reaction of **7** with methyl magnesium bromide under similar reaction conditions as described for **8** was not equally rewarding as

**Scheme 4.** Anionic Fragmentation of **8**



it failed to give any product. A close look at the structure of **7** indicated that in this molecule, the orientation of sulfone moiety is *endo* which may not allow the fragmentation due to the lack of antiperiplanarity between the bonds to be cleaved. Therefore, in order to support our observation, we epimerized the *endo*-sulfone moiety to *exo* using KHMDS as a base, which gave **13** in 70% yield. The epimerization of **7** was not successful using LiHMDS, possibly due to the chelation of the lithium between hydroxyl and sulfonyl oxygen. The structure of **13** was confirmed on the basis of  $^1\text{H}$  NMR analysis in  $\text{CDCl}_3$  as H-2 appeared as a doublet ( $J = 3.6$  Hz) which is possible only when sulfone is *exo*-oriented. Subjecting **13** to the usual anionic rearrangement yielded **9b** in 70% yield [crystalline solid; mp 125 °C;  $[\alpha]^{25}_D$  +14.6 (*c* 0.40,  $\text{CHCl}_3$ )] (Scheme 5). The stereochemistry of **9b** was confirmed by carrying out COSY experiments.

Since both **9a** as well as **9b** can be obtained from desymmetrized compound **6**, simple experimental manipulations such as sulfonyl group removal, reduction of the olefinic

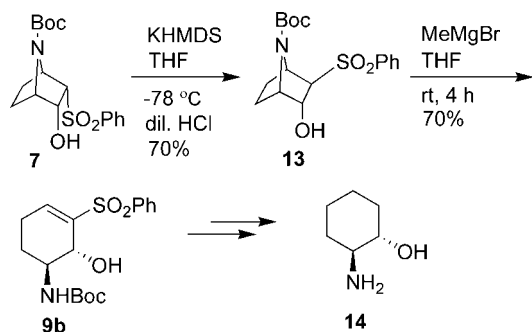


**Figure 2.** ORTEP diagram of **11**.

(13) Pandey, G.; Bagul, T. D.; Sahoo, A. K. *J. Org. Chem.* **1998**, *63*, 760–768.

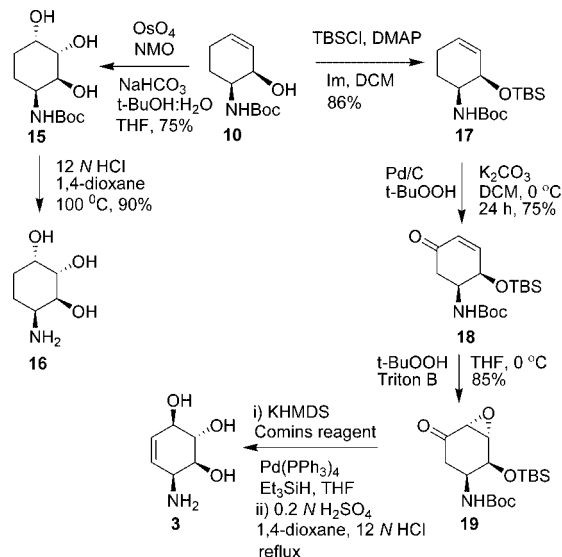
(14) Ramey, K. C.; Lini, D. C.; Moriarty, R. M.; Gopal, H.; Welsh, H. G. *J. Am. Chem. Soc.* **1967**, *89*, 2401–2408.

(15) Crystallographic data for the structure reported in this paper have been deposited with the Cambridge Crystallographic Data Centre as supplementary publication no. CCDC-691970.

**Scheme 5.** Ring Opening of Epimerized Alcohol

double bond, and *N*-Boc deprotection produced *cis*- as well as *trans*-2-aminocyclohexanols (**12** and **14**), respectively. It may be important to mention that these compounds have been fascinating targets for synthesis due to their wide applicability as ligands in asymmetric syntheses<sup>16</sup> and as small molecular probes for quorum-sensing modulation.<sup>17</sup> Optically pure *trans*-1,2-aminocyclohexanol (**14**) is obtained by either the aminolysis of cyclohexene epoxides using enantiopure methylbenzylamine in the presence of trimethylaluminum<sup>18</sup> or enantioselective opening of the *meso*-epoxide by an appropriate nucleophile using chiral catalyst.<sup>19,20</sup> In contrast, optical resolution has been the only method available for the synthesis of enantiomerically pure *cis*-1,2-aminocyclohexanol (**12**).<sup>21</sup>

As we had obtained **10** in larger quantity initially, we proceeded to explore its synthetic utility in the synthesis of *ent*-conduramine F-1 (**3**) as well as dihydroconduramine E-1 (**16**). While conduramine **3**, also called norvalienamine, is as active as valienamine in inhibiting  $\alpha$ -glucosidase from yeast,<sup>22</sup> compound **16** is unknown in all respects. Toward transforming **10** into **16**, we carried out OsO<sub>4</sub>-catalyzed dihydroxylation of the olefinic bond which gave expected **15** in 75% yield as a single isomer and was characterized by detailed COSY, NOESY, and <sup>13</sup>CMR data. The observed dihydroxylation stereochemistry of **15** was in accordance with Donohoe's<sup>23</sup> report. The carbamate deprotection using dilute HCl yielded **16** in 90% yield (Scheme 6) [mp 95 °C [ $\alpha$ ]<sub>D</sub><sup>25</sup> +55 (c 0.5, H<sub>2</sub>O)]. To explore its synthetic utility in

**Scheme 6.** Synthesis of Dihydroconduramine E1 **16** and Epoxy Ketone **19**

the synthesis of **3**, the free hydroxy moiety of **10** was protected as the –OTBS ether (**17**, 86% yield). The allylic oxidation of **17** by stirring with Pd/C (10 mol %) and *t*-BuOOH in DCM at 0 °C furnished enone **18** in 75% yield.<sup>24</sup> The nucleophilic epoxidation of enone **18** using TBHP and Triton-B in THF at 0 °C yielded single product **19** in 85% yield as a crystalline solid [mp 110 °C [ $\alpha$ ]<sub>D</sub><sup>25</sup> –45.0 (c 0.50, CHCl<sub>3</sub>)]. The epoxy ketone **19** was fully characterized by <sup>1</sup>H NMR, <sup>13</sup>C NMR, and mass spectra. The stereochemistry of the epoxide was confirmed by detailed COSEY and NOESY studies. Compound **19** was transformed into the corresponding enol triflate by reaction with KHMDS/Comins reagent<sup>25</sup> which upon treatment with Pd(PPh<sub>3</sub>)<sub>4</sub> and Et<sub>3</sub>SiH produces the corresponding olefin derivative. One-pot epoxide ring opening and global deprotection by refluxing with 0.2 N H<sub>2</sub>SO<sub>4</sub> and 10 N HCl in dioxane produced *ent*-conduramine F-1 (**3**) (Scheme 6). Optimization of the reactions conditions and the synthesis of corresponding analogues starting from **9b** are in progress and will be detailed appropriately in a full paper.

**Acknowledgment.** K.N.T. is thankful to UGC, New Delhi, for the award of research fellowship.

**Supporting Information Available:** Experimental details and NMR spectroscopic and mass spectroscopic data for the new compounds are given in the Supporting Information. This material is available free of charge via the Internet at <http://pubs.acs.org>.

OL801381T

(24) Yu, J.-Q.; Corey, E. J. *Org. Lett.* **2002**, *4*, 2727–2730.

(25) Comins, D. L.; Dehghani, A. *Tetrahedron Lett.* **1992**, *33*, 6299–6302.

(16) (a) Schiffrers, I.; Rantanen, T.; Schmidt, F.; Bergmans, W.; Zani, L.; Bolm, C. *J. Org. Chem.* **2006**, *71*, 2320–2331. (b) Parrodi, C. A.; Juaristi, E. *Synlett* **2006**, 2699–2715.

(17) Jog, G. J.; Igarashi, J.; Suga, H. *Chem. Biol.* **2006**, *13*, 123–128.

(18) Overmann, L. E.; Sugai, S. *J. Org. Chem.* **1985**, *50*, 4154–4155.

(19) Martinez, L. E.; Leighton, J. L.; Carsten, D. H.; Jacobsen, E. N. *J. Am. Chem. Soc.* **1995**, *117*, 5897–5898.

(20) Schneider, C.; Sreekanth, A. R.; Mai, E. *Angew. Chem., Int. Ed.* **2004**, *43*, 5691–5694.

(21) (a) Miyano, S.; Lu, L. D.-L.; Viti, S. M.; Sharpless, K. B. *J. Org. Chem.* **1985**, *50*, 4350–4360. (b) Kawabata, T.; Yamamoto, K.; Momose, Y.; Yoshida, H.; Nagaoka, Y.; Fujii, K. *Chem. Commun.* **2001**, 2700–2701.

(22) Lysek, R.; Schutz, C.; Favre, S.; O'Sullivan, A. C.; Pillonel, C.; Krulle, T.; Jung, P. M. J.; Clotet-Codina, I.; Este, J. A.; Vogel, P. *Bioorg. Med. Chem.* **2006**, *14*, 6255–6282.

(23) Donohoe, T. J.; Moore, P. R.; Beddoes, R. L. *J. Chem. Soc., Perkin Trans. 1* **1997**, 43–52.

---

## Erratum

---