

**Studies Towards the total Synthesis of Cyclodidemniserinol trisulfate by
Employing Pd-Mediated Alkynol Cycloisomerizations and A [2+2+2]
Alkyne Trimerization Approach for Synthesis of Some Carbapenems.**

THESIS

Submitted To The

UNIVERSITY OF PUNE

For The Degree Of

DOCTOR OF PHILOSOPHY

In

CHEMISTRY

By

ROSY MALLIK

Dr. Mukund K. Gurjar

(Research Guide)

**ORGANIC CHEMISTRY DIVISION
NATIONAL CHEMICAL LABORATORY
PUNE-411 008, INDIA
APRIL 2009**

Dedicated

To

My Beloved Parents

DECLARATION

The research work embodied in this thesis has been carried out at National Chemical Laboratory, Pune under the supervision of **Dr. M. K. Gurjar**, Organic Chemistry Division; National Chemical Laboratory, Pune-411 008. This work is original and has not been submitted in part or full, for any degree or diploma of this or any other University.

Date:

(Rosy Mallik)

Organic Chemistry Division

National Chemical Laboratory

Pune-411 008

CERTIFICATE

The research work presented in thesis entitled “**Studies Towards the total Synthesis of Cyclodidemniserinol trisulfate by Employing Pd-Mediated Alkynol Cycloisomerizations and A [2+2+2] Alkyne Trimerization Approach for Synthesis of Some Carbapenems.**” has been carried out under my supervision and is a bonafide work of Ms. Rosy Mallik. This work is original and has not been submitted for any other degree or diploma of this or any other University.

Place: Pune

Date:

(Dr. M. K. Gurjar)

Research Guide

Acknowledgements

It would have been impossible to complete this work without a number of persons who graced their presence in my research career and beyond to influence me in myriad ways. In particular **I would like to thank:**

My revered mentor **Dr. M. K. Gurjar**, Former Deputy Director & Head: Organic Chemistry Division; NCL, Pune, for his proficient guidance. I convey my heartfelt gratitude to him for giving me the opportunity to work under his able and astute supervision. My association with him was a great learning experience which will guide me in my future quests for sure.

Dr. C. V. Ramana, for unpretentious support in every way I needed. His unmatched patience and perseverance have given shape to this thesis and it will be unjust to disparage them by mere words. The freedom he rendered for thinking, working and for asking was vital for successful execution of research work. His never-say-no approach has taught me to look at every aspect of life with a different perspective. I owe him much more than the success of this thesis.

Dr. D. K. Mohapatra, Dr. Srinivas Hotha, Mr. I. Shivkumar, Dr. Thulsiram, Dr. R. A. Joshi, Dr. (Mrs.) R. R. Joshi, Dr. M. N. Deshmukh, Dr. Sawaikar, Dr. Borate and Dr. U. R. Kalkote, for their valuable suggestions. I sincerely thank Mrs. Raphel, Mrs. Kulkarni and all OCD office staff for their cooperation. Help from the spectroscopy, analytical and mass group is gratefully acknowledged. I sincerely thank Dr. Rajmohan, Dr. Gonnade and Mrs. Santhakumari for their unhesitant support and assistance. My special thanks to the NMR faculty Balu, Sonu, Kavitha, Ganesh, Yogitha, and Jima for their timely help.

My senior colleagues—Dr. Sankar, Dr. Ekambaram, Dr. Smruti, Dr. Sukhen, Dr. Manjusha, Dr. Dhananjoy, Dr. Bhagwat, Dr. Ramdas, Dr. Tushar, Dr. Gorakh, and Dr. Bhargav for their support. I wholeheartedly thank my colleagues Dr. Rahman, Dr. Rita, Dr. Ramesh, Dr. Susheel, Pradip, Dr. Chinmoy, Bhaskar, Abhijit, Ganesh, Sulake, Anil, Debabrata, Ankush and Anand for their co-operation.

My GRG labmates—Kulbhusan, Anuj, Raghupathi, Kiran, Nageshwar, Soumitra, Shrinivas, Sharad, Mondal, Rambabu, Giri, Pandeyji, Rahul, Mangesh, Shyam, Sachin, Ajay, Yadagiri, Yogesh, Sridhar, Sunil, Senthil and Chandrababu for their ever-extended helping hands. I wholeheartedly thank them all for their company and making our laboratory the finest place to work in. Thanks to Indu for being there for me every way she could and for her moral support. On the same note, I sincerely thank to my G. J. and New hostel friends, Shridevi, Sweta, Purva, Mahima, Maitri, Gowri, Tanpreet, Ritika and Rekha for making life easy and pleasant whenever it seemed to be getting tough.

“ALLCHEMIST” members– Manoj bhai, Seetaram bhai, Sabita apa, Sashi bhai, Shivsankar bhai, Debashish, Manaswini, Suman, Bhuban, Anup & Dibya, Ramakanta, Pitambar, Subash & Karubaki, Tini, Mandakini and Chaka for creating a *home- away -from-home* ambiance.

My M. Sc. Teachers in Bhanjavihar University– especially Prof. C. S. Panda for his unique way of teaching and Prof. Mrs. Bhattamishra for her constant encouragement. I earnestly thank my B. Sc. teachers for introducing me to this fascinating world of chemistry. I am truly indebted to my high school teacher Laxmidhar sir and my science teacher, late Mayadhar sir.

Saswati, Swagatika, Sagarika, Shivani, Sunita, Manu, Subrat, Dhananjaya, Santosh, Anup and Suresh for making my university days memorable. Heartfelt thanks to my graduation colleagues, especially Rashmi. I owe a singular mention to Sangeeta, who stood by me all the way not by compulsion but by her conviction and for sharing my every up and down.

My grandparents– for their endless affection and blessings and who deserve more than a mere word of thanks. It is impossible to express my sense of gratitude to my **Maa** (my first teacher) and **Bapa** (my philosopher) who granted me everything I wished for, without any expectation. My every little success will be a dedication to them and a form of thanking them. I am grateful to my uncle **Shiva kaka**, the best teacher I ever had and who shaped my academic career from the very beginning. I thank Kuni & Babu, Tikina, Kunmun and Tapu for their love and unconditional support. Special thanks to my Mother-in-law, brother-in-law and sister-in-law for their affection, support and never ending encouragement. I am very much thankful to Sunu and niece li'l Mamuni who brushed away my worries and made stressful moments lighter while writing this thesis. Most importantly I thank my husband, Gokarneswar, who always instilled confidence in me in one way or other. I am indeed grateful to him not only for giving me a lot of his time to proof-read the manuscript and giving constructive suggestions but also for giving me moral support in the most taxing period of writing.

Finally, I thank Director, NCL, Pune for providing infrastructure facilities to complete my work successfully. I am also thankful to UGC, New Delhi for the financial assistance in the form of a fellowship.

Rosy Mallik

Every man is free to rise as far as he's able or willing, but it's only the degree to which he thinks that determines the degree to which he'll rise.

Ayn Rand (Atlas shrugged)

ABBREVIATIONS

Ac	-	Acetyl
Anh.	-	Anhydrous
Aq.	-	Aquous
BF ₃ .Et ₂ O	-	Boron trifluoride diethyl ether complex
BH ₃ .DMS	-	Boron dimethylsulfide complex
BINOL	-	1,1'-Bi-2-naphthol
Bn	-	Benzyl
BnBr	-	Benzyl bromide
Bu	-	Butyl
COSY	-	Correlation Spectroscopy
DDQ	-	2,3-Dichloro-5,6-dicyanobenzoquinone
DEPT	-	Distorted Enhancement Polarized Transform
DIBAL-H	-	Diisobutylaluminium hydride
DMF	-	<i>N,N'</i> -Dimethylformamide
DMAP	-	<i>N,N'</i> -Dimethylaminopyridine
DMSO	-	Dimethyl sulfoxide
dr	-	Diastereomeric ratio
Et	-	Ethyl
EtOAc	-	Ethyl acetate
FGT	-	Functional group transformation
GDA	-	Glucose diacetone
HMBC	-	Heteronuclear Multiple Bond Correlation
HSQC	-	Heteronuclear Single Quantum Coherence
Im	-	Imidazole
IBX	-	Iodoxybenzoic acid
LAH	-	Lithium aluminium hydride
Me	-	Methyl
Ms	-	Methanesulfonyl
NMR	-	Nuclear Magnetic Resonance

NOESY	-	Nuclear Overhauser Enhancement Spectroscopy
ORTEP	-	Oak Ridge Thermal Ellipsoid Plot
Pd/C	-	Palladium on Carbon
Ph	-	Phenyl
Pr	-	Propyl
Py	-	Pyridine
PDC	-	Pyridiniumdichromate
PdCl ₂	-	Palladium (II) chloride
PMBCl	-	<i>para</i> -Methoxy benzyl chloride
<i>p</i> -TSA	-	<i>para</i> -Toluenesulfonic acid
rt	-	Room temperature
Sat.	-	Saturated
TBAF	-	Tetra- <i>n</i> -butylammonium fluoride
TBDMS-Cl	-	<i>tert</i> -Butyldimethyl silyl chloride
THF	-	Tetrahydrofuran
TPP	-	Triphenylphosphine
Ts	-	Tosyl

Abbreviations used for NMR spectral informations:

br	-	Broad	q	-	Quartet
d	-	Doublet	s	-	Singlet
m	-	Multiplet	t	-	Triplet

GENERAL REMARKS

- ^1H NMR spectra were recorded on AC-200 MHz, AV-200 MHz, MSL-300 MHz, AV-400 MHz and DRX-500 MHz spectrometers using tetramethylsilane (TMS) as an internal standard. Chemical shifts have been expressed in ppm units downfield from TMS.
- ^{13}C NMR spectra were recorded on AC-50 MHz, AV-50 MHz, MSL-75 MHz, AV-100 MHz, and DRX-125 MHz spectrometer.
- EI Mass spectra were recorded on Finnigan MAT-1020 spectrometer at 70 eV using a direct inlet system.
- Infrared spectra were scanned on Shimadzu IR 470 and Perkin-Elmer 683 or 1310 spectrometers with sodium chloride optics and are measured in cm^{-1} .
- Optical rotations were measured with a JASCO DIP 370 digital polarimeter.
- Melting points were recorded on Buchi 535 melting point apparatus and are uncorrected.
- The X-ray Crystal data were collected on Bruker SMART APEX CCD diffractometer using Mo K_α radiation with fine focus tube with 50 kV and 30 MA.
- All reactions are monitored by Thin Layer chromatography (TLC) carried out on 0.25 mm E-Merck silica gel plates (60F-254) with UV light, I_2 and anisaldehyde in ethanol as development reagents.
- All solvents and reagents were purified and dried by according to procedures given in Vogel's Text Book of Practical Organic Chemistry. All reactions were carried out under Nitrogen or Argon atmosphere with dry, freshly distilled solvents under anhydrous conditions unless otherwise specified. Yields refer to chromatographically and spectroscopically homogeneous materials unless otherwise stated.
- All evaporations were carried out under reduced pressure on Buchi rotary evaporator below 40 °C.
- Silica gel (60–120), (100-200), and (230-400) mesh were used for column chromatography.
- Different numbers were assigned for compounds in Abstract and each chapter.

CONTENTS

	Page No.
Abstract	i-xiv
Chapter I Pd-mediated Cycloisomerization on Sugar Alkynols	
1.1 Introduction	1
1.2 Present work	15
1.3 Experimental	38
1.4 Spectra	81
1.5 References	105
Chapter II Studies Towards the Total Synthesis of Cyclodidemniserinol trisulfate	
2.1 Introduction	110
2.2 Present work	116
2.3 Experimental	131
2.4 Spectra	153
2.5 References	183
Chapter III A [2+2+2] Alkyne Trimerization Approach for Synthesis of Some Carbapenems	
3.1 Introduction	184
3.2 Present work	194
3.3 Experimental	202
3.4 Spectra	213
3.5 References	232
List of Publications	234

Abstract

Research Student	: Rosy Mallik
Research Guide	: Dr. Mukund K. Gurjar
Title of Thesis	: Studies Towards the total Synthesis of Cyclodidemniserinol trisulfate by Employing Pd-Mediated Alkynol Cycloisomerizations and A [2+2+2] Alkyne Trimerization Approach for Synthesis of Some Carbapenems.
Registration No.	: E1/262/Ph.D/2008
Date of Registration	: 07. 11. 2006
Place of Work	: Organic Chemistry Division, National Chemical Laboratory, Pune (INDIA)

Abstract

The thesis entitled “**Studies Towards the total Synthesis of Cyclodidemniserinol trisulfate by Employing Pd-Mediated Alkynol Cycloisomerizations and A [2+2+2] Alkyne Trimerization Approach for Synthesis of Some Carbapenems.**” is divided into three chapters. The first chapter deliberates the Pd-mediated cycloisomerizations on sugar alkynols. The second chapter describes studies towards the total synthesis of cyclodidemniserinol trisulfate employing Pd-mediated alkynol cycloisomerizations. The third chapter presents a [2+2+2] alkyne cyclotrimerization approach for synthesis of some carbapenems.

CHAPTER I: Pd-mediated cycloisomerizations on sugar alkynols

Designing effective routes to construct complex cyclic structures through organo transition-metal catalyzed reactions provide many attractive possibilities, which by conventional wisdom, would need a large number of synthetic maneuverings. Cycloisomerization of alkynols is projected as a tool to synthesize the oxygen containing heterocycles encompassing functionalized furan, pyran, benzo-pyran and spiro-ketal

skeletons. The metal mediated hydroalkoxylation reactions of carbohydrate precursors have been less explored and mainly confined to glycols, *exo*-glycols and related derivatives. In this chapter, a novel strategy of tandem cycloisomerization of 3-*C*-acetylinic sugar derivatives and the trapping of intermediary alkenylpalladium species with acrolein to derive the novel bicyclic ketals and cyclic enol ether derivatives was reported (Figure 1). We focused on sugar based molecular diversity as these molecules offer inherent rigidity and molecular asymmetry.

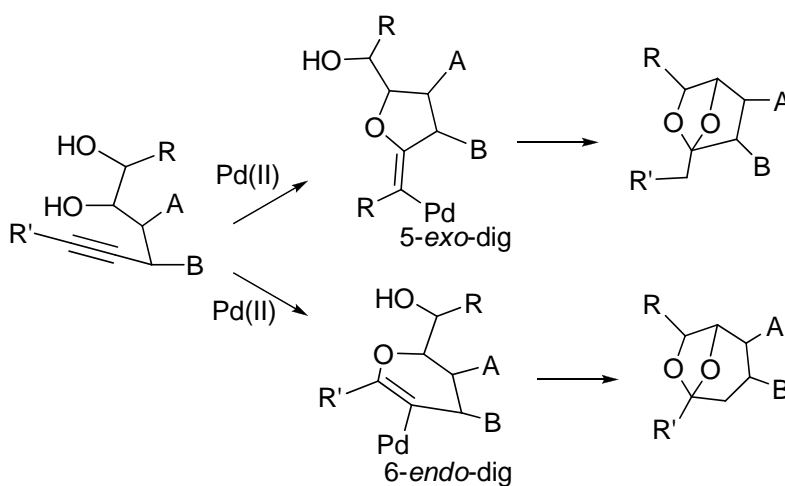
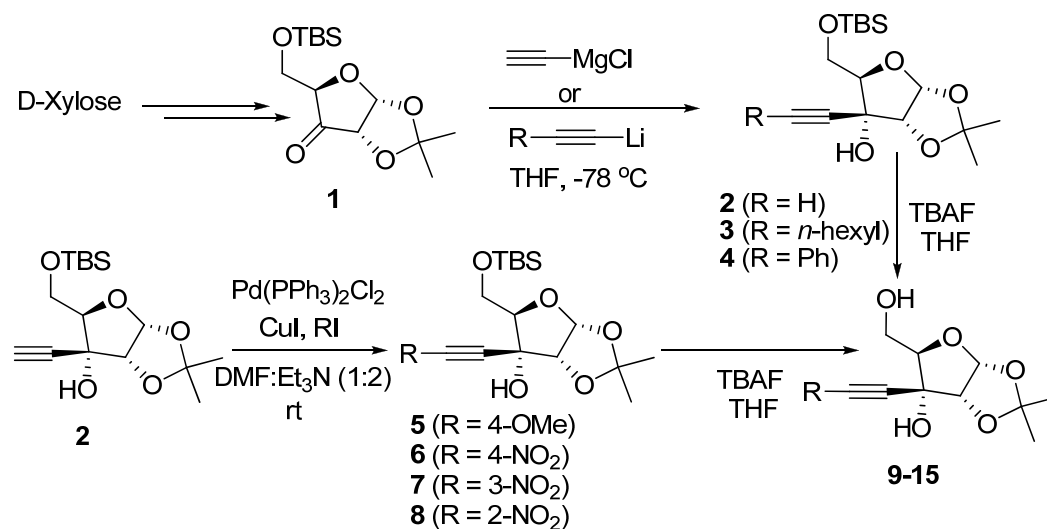


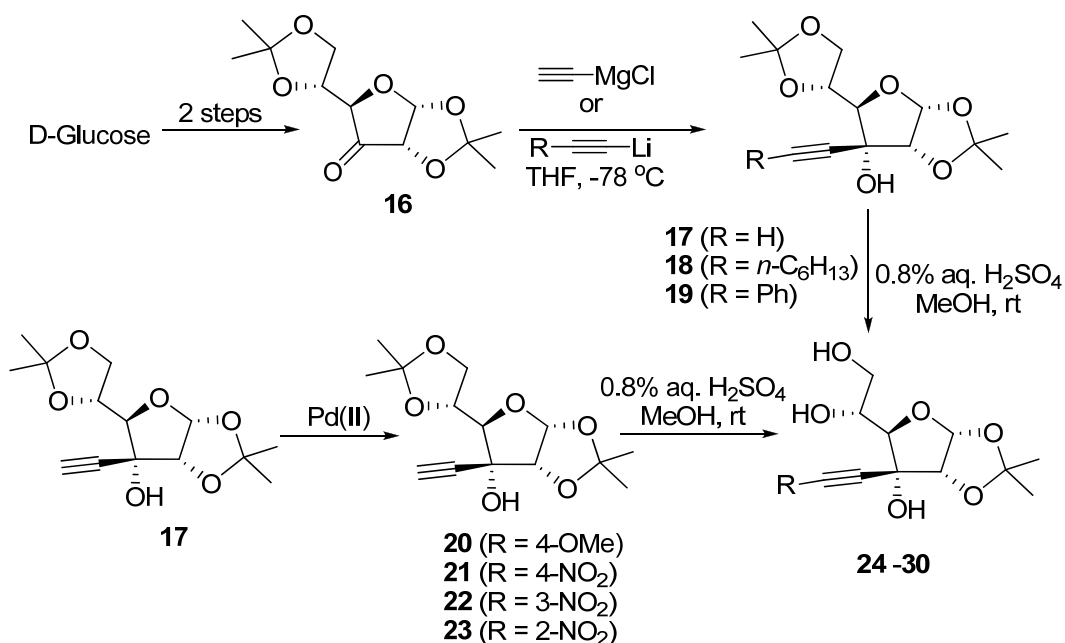
Figure 1: Key issue of *exo* vs *endo* dig cyclisations.

The synthesis of the requisite model 3-*C*-alkynyl-*ribo*-furanose derivatives was started from the known 3-*ulose* derivative. According to known procedure *D*-xylose was converted to **1** in four steps which upon treatment with acetylene Grignard reagent furnished **2**. To achieve different substituted alkynes, two different routes were followed. First, addition of the lithiated salts of 1-octyne and phenylacetylene to **1** gave **3** and **4** respectively. Sonogashira coupling reaction of **2** with different aryl iodides was carried out as our second route to get functionalized alkyne substrates **5–8**. Accordingly the reaction was performed in a mixture of Et₃N:DMF (2:1) as the solvent using catalytic Pd(PPh₃)₂Cl₂ and CuI. The TBS groups present at *O*-5 of **2–8** were subsequently removed by using TBAF-THF to give alkynol substrates **9–15** (Scheme 1).



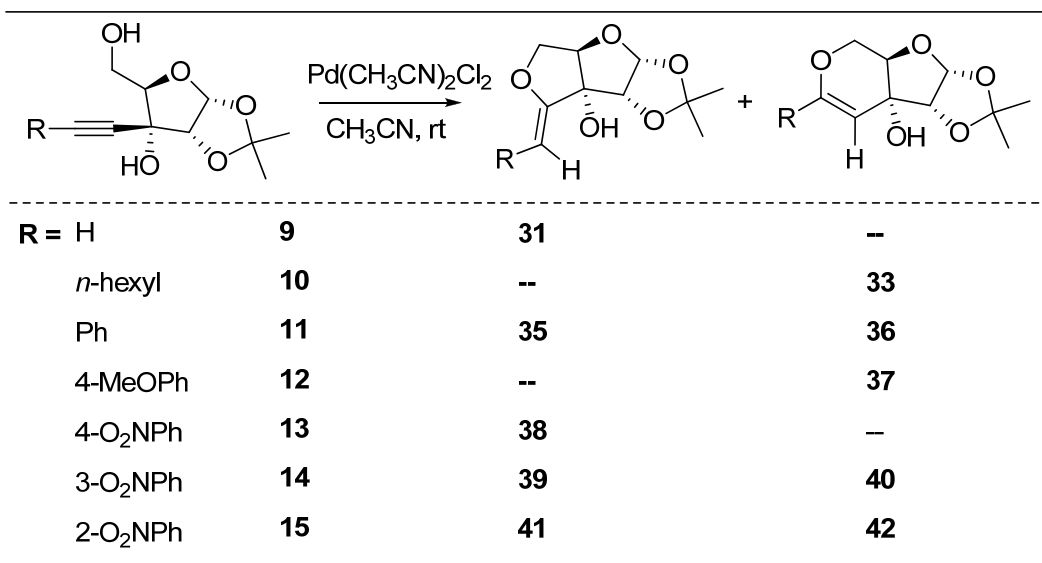
Scheme 1

The synthesis of the second set of cycloisomerization substrates **24–30** was carried out in a similar manner from ulose **16**. Compound **17** was obtained by adding acetylene Grignard reagent to **16**. Addition of the lithiated salts of 1-octyne and phenylacetylene to **16** resulted in **18** and **19** respectively. Sonogashira coupling reaction of **17** with different aryl iodides was carried out to give compounds **20–23**. The selective hydrolysis of the terminal 5,6-acetonide group of **17–23** with aq. H₂SO₄ in methanol completed the synthesis of projected cycloisomerization precursors **24–30** (Scheme 2).



Scheme 2

Palladium-mediated cycloisomerization reactions with 3-*C*-alkynyl-*ribo*-furanose derivatives **9–15** were carried out at room temperature taking Pd(CH₃CN)₂Cl₂ as the catalyst in dry acetonitrile. The results are summarized in Scheme 3.



Scheme 3

The parent compound **9** gave exclusively ketal **32** resulting from hydrolysis of the transient *exo*-enol product **31** (Figure 2). Cycloisomerization of alkynol **10** and **12** afforded the *endo*-products **33** and **37** exclusively. Compound **33** was found to be susceptible to hydration in CDCl₃ and resulted in the formation of hemiketal **34** as a single anomer. Compound **13** gave only *exo*-product **38**, whereas a mixture of 5-*exo*- and 6-*endo*- products were obtained in cycloisomerization reactions of **14** as well as **15**.

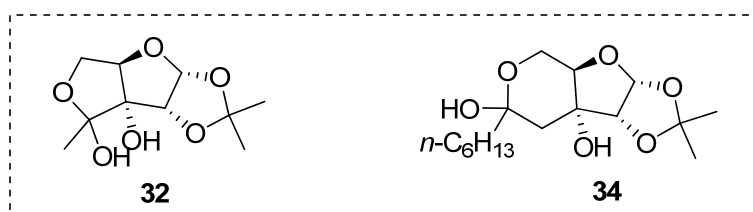
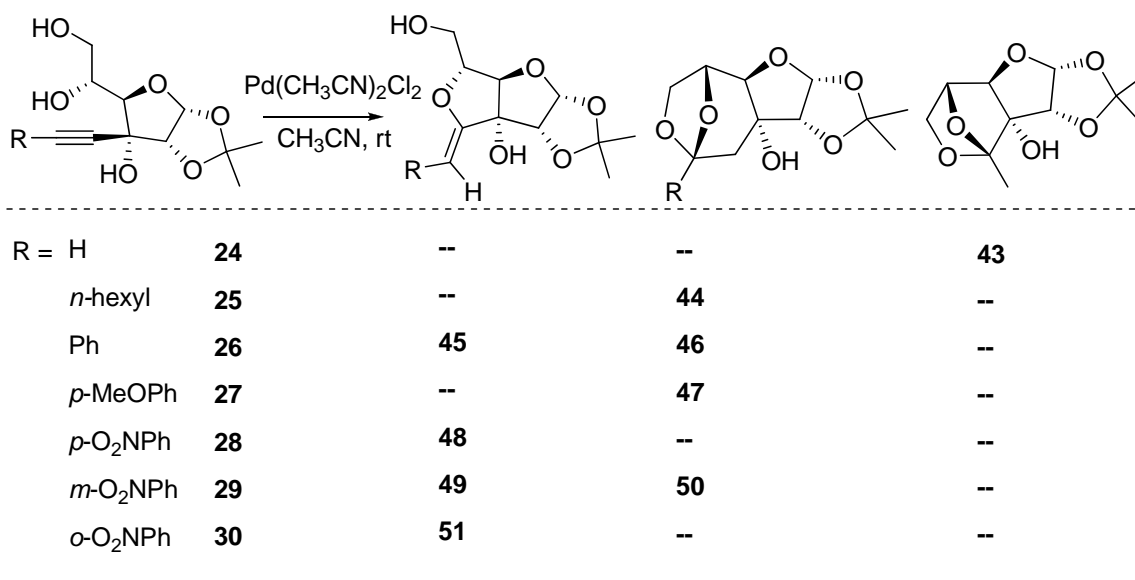


Figure 2

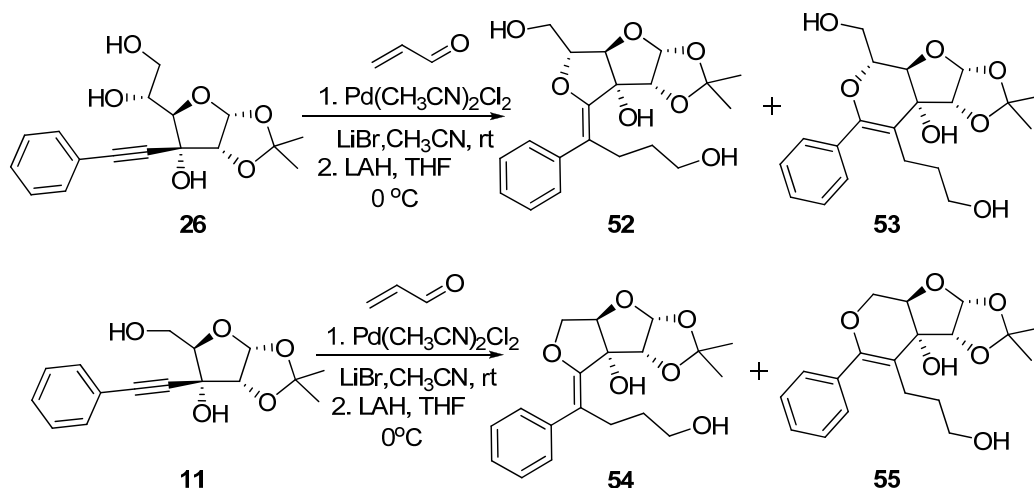
Palladium-mediated cycloisomerization reactions with 3-*C*-alkynyl-*allo*-furanose derivatives **24–30** were carried out as above. The results are summarized in Scheme 4.



Scheme 4

The cycloisomerization of monosubstituted alkynol **24** gave exclusively the [2,2,1] bicyclic acetal **43**. In case of *n*-hexyl substituted alkynol **25**, we obtained the *endo*-product **44** exclusively. With phenyl substituted alkynol **26**, two products **45** and **46** were isolated. The [3,2,1] bicyclic ketal structure of **46** was confirmed by the single crystal structural analysis. The cycloisomerization of *p*- and *o*-nitrophenyl substituted alkynols **28** and **30** gave exclusively *exo*-cyclic products **48** and **51** respectively; however, *m*-nitro derivative **29** gave small amounts of [3,2,1] bicyclic ketal **50** along with the *exo*-cyclic product **49** (Scheme 4). All monocyclic 5-*exo*- products had characteristic downfield shift for olefin proton.

In order to trap the intermediate σ -Pd complex with an appropriate electrophile we have conducted the cycloisomerization of compounds in presence of acrolein. The cycloisomerization of **26** in presence of acrolein followed by reduction by LAH gave two products **52** and **53** (Scheme 5). The phenyl derivative **11** under similar reaction condition provided **54** and **55**.



Scheme 5

In summary, electronic control over the 5-*exo*-dig versus 6-*endo*-dig modes of cyclizations in Pd-mediated cycloisomerization reaction has been studied in detail. 3-C-alkynyl-*allo* and *ribo*-furanose derivatives with systematic variation of functional groups at the opposite side of alkyne were employed to understand the competitive balance between inductive effect of furanose ring and mesomeric effect of aryl substituent.

CHAPTER II: Studies towards the total synthesis of cyclodidemniserinol trisulfate

Cyclodidemniserinol trisulfate (**56**) was isolated from the Palauan ascidian *Didemnum guttatum*, at Ngerchaol Island, Palau. It was found to inhibit purified integrase with an IC_{50} of 60 $\mu\text{g/mL}$ and MCV topoisomerase with an IC_{50} of 72 $\mu\text{g/mL}$.

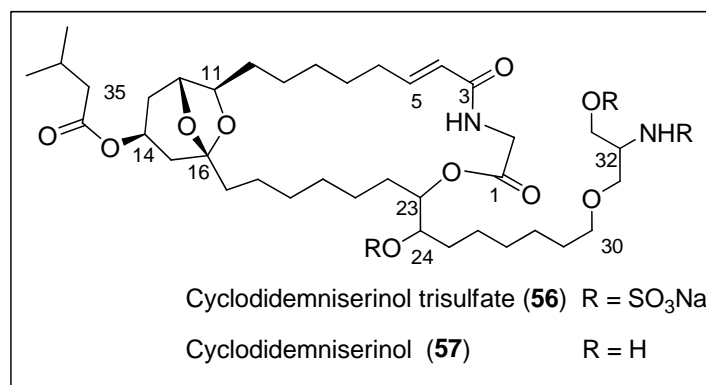


Figure 3

Retrosynthetic strategy:

Considering the cycloisomerization as the key reaction to achieve the target fragment **59**, we opted to place the alkyne favorably for 6-*endo-dig* cyclization. A metal mediated alkyne addition to aldehyde placed at right side of the diol substrate **60** and a 5-carbon Wittig reaction for 7-carbon chain extension at the left part of diol substrate was planned. Hence three fragments **61**, **62** and **63** were identified as important coupling partners for a convergent synthesis of the advanced intermediate **59** (Figure 4).

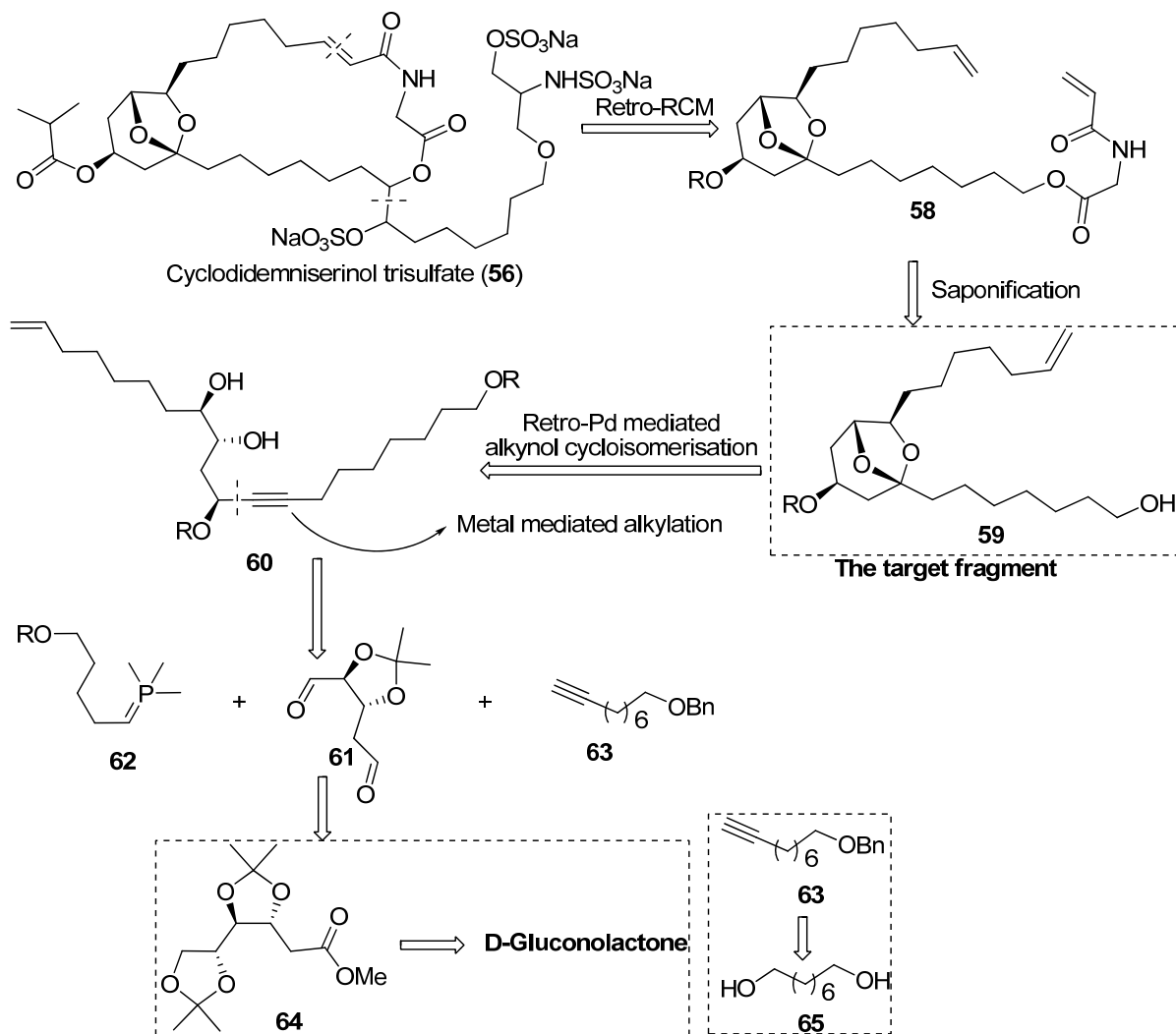
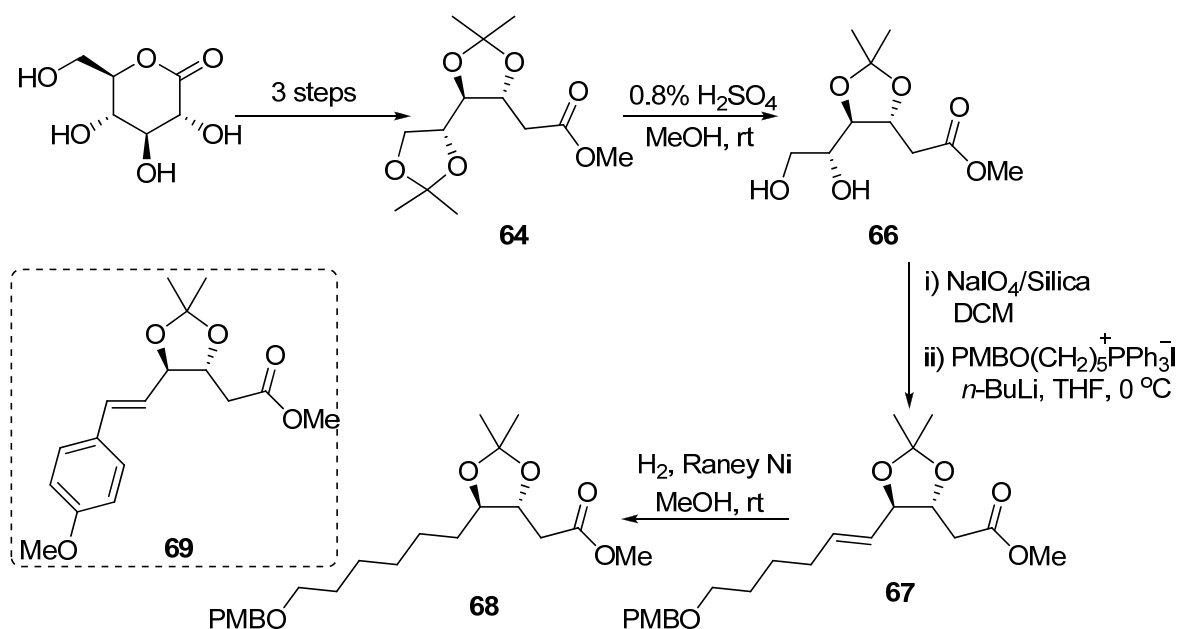


Figure 4: Retrosynthetic strategy for Cyclodidemniserinoltrisulfate

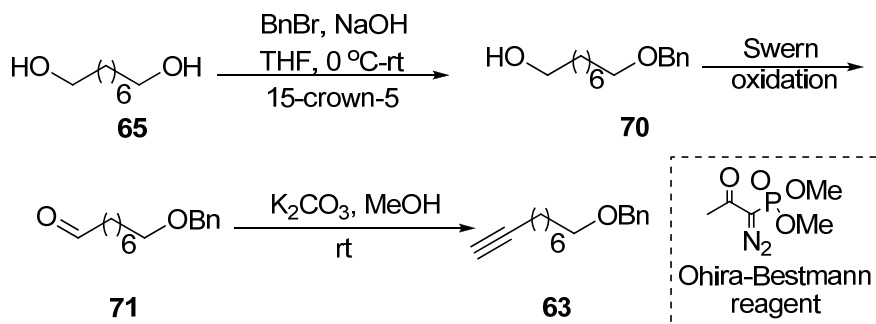
The synthesis was started from the D-gluconolactone which was converted to the corresponding diacetonide **64** followed by acetonide deprotection to get the diol **66**. The oxidative cleavage of the diol **66** and Wittig reaction with 5-carbon Wittig ylide gave **67**

in poor yield (< 10%). Repetition of the reaction with different bases such as K-O^tBu and NaHMDS, resulted in an undesired side product **69** either as major or sole product.



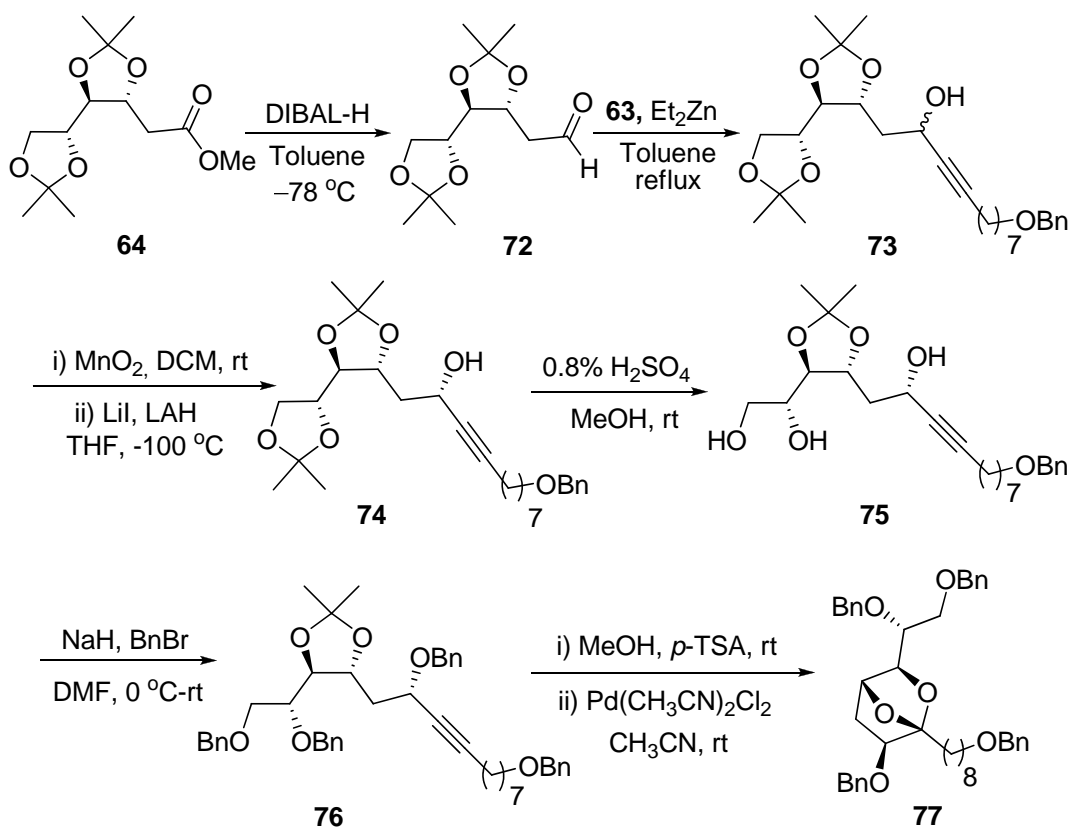
Scheme 6

After being unsuccessful to achieve Wittig product, we thought to introduce the alkyne fragment to the substrate first. Mono benzyl protection of 1,8-octanediol followed by oxidation under Swern conditions yielded aldehyde **71**, which was then exposed to Ohira-Bestmann reagent to achieve terminal alkyne product **63**.



Scheme 7

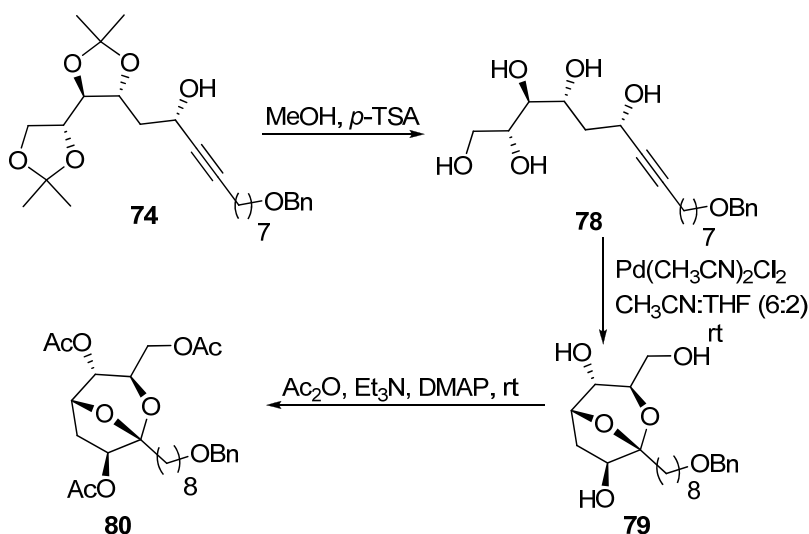
To introduce alkyne **63** to the sugar moiety, the methyl ester **64** was partially reduced to aldehyde **72**. Alkyne **63** was refluxed with Et_2Zn in toluene, which was then added to aldehyde to achieve diastereomeric mixture (6:4) of propargyl alcohol **73**. The resulted alcohol was oxidized to ketone by MnO_2 which was then subjected to selective 1, 3-*syn* reduction in presence of LiI -LAH. The terminal isopropylidene group was deprotected furnishing the triol **75**. Triol **75** was protected as benzyl ether **76** using NaH and BnBr . The cycloisomerization reaction of **76** using $\text{Pd}(\text{CH}_3\text{CN})_2\text{Cl}_2$ as the catalyst afforded **77** as the exclusive product (Scheme 8). The constitution of the bicyclic ketal unit present in **77** was investigated with the help of spectral data analysis. These findings supported the *exo*-cyclization product **77** with a [2,2,1] bicyclic ketal structure.



Scheme 8

In order to do some experimentation with this substrate to ensure the mode of cyclization after we failed to get desired cyclized product, **74** was subjected to its global deprotection to obtain **78**. Cycloisomerization of **78** with $\text{Pd}(\text{CH}_3\text{CN})_2\text{Cl}_2$ in CH_3CN

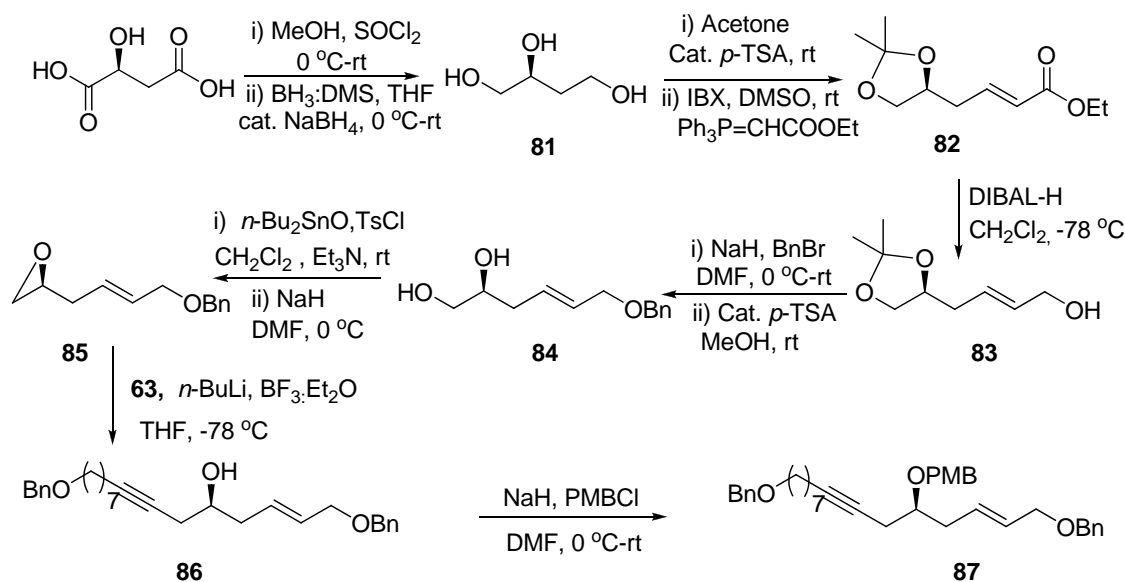
obtained cyclized product **79** which was converted to its acetate **80** by using Ac₂O, Et₃N and DMAP.



Scheme 9

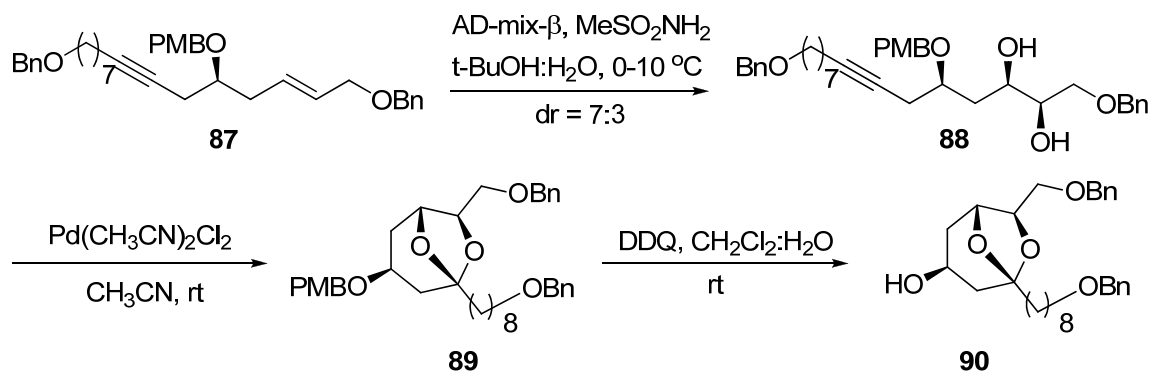
Extensive NMR studies revealed the 2,8-dioxabicyclo [3,2,1] octane skeleton of the structure **80**. The exclusive formation of *exo*-cyclized products in both cases pushed us for the development of a new strategy. So as to achieve our desired [3,2,1] bicyclic core of the natural product based on the above findings, we planned for a precursor with an extra carbon between the alkyne and ring –OH for the cyclization reaction. To achieve the desired bicyclic ketal core, we opted for L-malic acid as the starting material.

L-malic acid was converted to its methyl ester which was reduced by BH₃:DMS to get the triol **81**. The triol was then selectively protected as 5-membered dioxole which upon one pot sequential oxidation with IBX in DMSO, followed by treatment with 2-carbon Wittig ylide furnished the *trans*-olefin **82**. Compound **82** was then reduced selectively by DIBAL-H to give alcohol **83**. Benzyl protection and deprotection of isopropylidene group of compound **83** resulted diol **84**. Epoxide **85** was obtained by selectively conversion of the primary hydroxyl group to its tosylate with catalytic *n*-Bu₂SnO followed by S_N2 displacement with vicinal hydroxyl group. Epoxide ring opening using Yamaguchi protocol resulted in alcohol **86** which was protected as its PMB ether **87** by NaH and PMBCl.



Scheme 10

Compound **87** was subjected to Sharpless asymmetric dihydroxylation in presence of AD-mix- β . Having the key diol **88**, we intended to implement Pd-mediated alkynol cycloisomerization to build the requisite [3,2,1] bicyclic ketal unit. Accordingly compound **88** was exposed to the catalyst $\text{Pd}(\text{CH}_3\text{CN})_2\text{Cl}_2$ in CH_3CN . The structure and stereochemistry of the isolated bicyclic product could be assigned from NMR studies.



Scheme 11

In summary, we compiled our investigations aimed at developing a flexible approach for the total synthesis of cyclodidemniserinol and its trisulfate. Our initial design anticipating an exclusive 6-*endo* mode of cycloisomerization was ended up with exclusive 5-*exo*-dig mode of ring closure giving a [2,2,1] bicyclic ketal and a 2,8-

dioxabicyclo [3,2,1] octane system. Hence, we redesigned our model substrate of the cycloisomerization reaction projecting an exclusive 6-*exo*-dig mode of cyclization which afforded the required [3,2,1] bicyclic ketal core of the cyclodidemniserniol and its trisulfate.

CHAPTER III: A [2+2+2] alkyne trimerization approach for the synthesis of some carbapenems

The extensive use of common β -lactam antibiotics such as penicillins and cephalosporins in medicine has resulted in an increasing number of resistant strains of bacteria through mutation and β -lactamase gene transfer. Visualizing the possibility of synthesizing 4/5/6 tricyclic framework similar to 6-(1-hydroxyethyl)cyclonocardicins **A** (Figure 5) which shows activity against a wide range of pathogens including both Gram positive (*S.aureus*, *Strep. Pyogenes*, *B. subtilis*) and Gram negative (*E. coli*, *Pseudomonas*, *Proteus morgani* etc.), we designed our strategy as shown in figure 5.

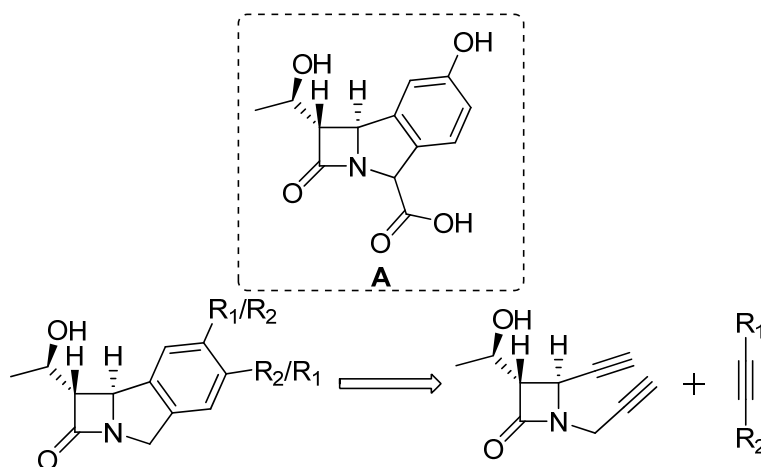
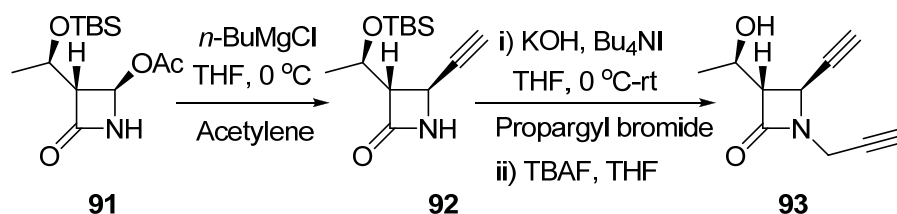


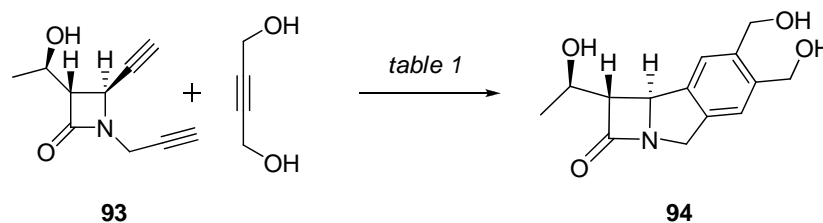
Figure 5

The alkyne compound **92** was obtained by addition of ethynyl Grignard $\text{CH}\equiv\text{CMgCl}$ (generated by passing dry acetylene gas to a solution of preformed *n*-BuMgCl Grignard reagent in THF) to 2-azitidinone **91**, which was then subjected to propargylation reaction by using propargyl bromide and KOH in the presence of a phase transfer catalyst in THF. The deprotection of OTBS group by TBAF in THF furnished our required diyne substrate **93** (Scheme 12).



Scheme 12

Wilkinson's catalyst was found to be superior among various catalysts screened for proposed cyclotrimerization reaction and resulted in the formation of a new UV-active compound **94** from the reaction of dialkyne **93** and 2-butyn-1,4-diol.

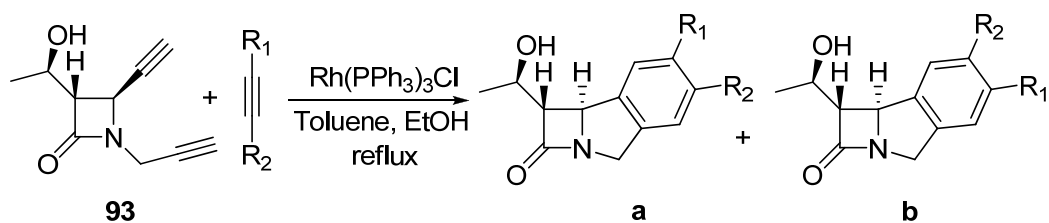


Scheme 13

Catalyst	Solvent	Temp.	time	Yield
Ni(cod) ₂ / PPh ₃	THF-Toluene	reflux	18 h	13%
Mo(CO) ₆	THF-Toluene	reflux	6 h	08%
Rh(PPh ₃) ₃ Cl	Toluene-ethanol	80 °C	3 h	65%
CoCl ₂ .6H ₂ O / Zn	THF	reflux	-	-
[Ir(cod)Cl] ₂ dppe	THF-Toluene	reflux	-	-

Table 1

To prove the versatility of our intended strategy, we employed commercially available alkynes having different functional groups for the projected [2+2+2] alkyne cyclotrimerization reaction. In case of asymmetric alkynes, regiomer mixtures were obtained. We were able to separate only **97a**, **98b** and **99a** from their respective mixtures.



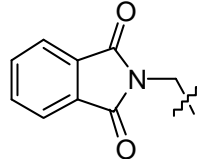
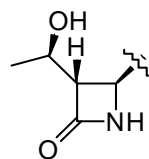
Entry	R ₁	R ₂	Product	
1	CH ₂ OH	CH ₂ OH	94	
2	H	H	95	
3	CH ₂ OH	H	96a + 96b	R ₃ =  R ₄ = 
4	C ₂ H ₄ OH	H	97a + 97b	
5	C ₅ H ₁₁	H	98a + 98b	
6	C ₁₄ H ₂₉	H	99a + 99b	
7	Ph	H	100a + 100b	
8	R ₃	H	101a + 101b	
9	R ₄	H	102a + 102b	

Table 2

In conclusion, a [2+2+2] alkyne cyclotrimerization reaction was employed successfully to construct the central framework of 4/5/6 tricyclic carbapenem structure. Introduction of different substituents to the structure was achieved easily by using different alkynes.

Chapter I:

Pd-mediated Cycloisomerizations on Sugar Alkynols

1.1 INTRODUCTION

Oxygenated heterocycles are one of the most common structural motifs spread across natural products in the form of furans and pyrans in carbohydrates, leucascandrolide A^{1a} (**1a**), ketals (brevicomines) and spiroketals such as spiroloxines^{1b} (**1b**). Complex metabolites such as phorboxazoles^{1c} (**1c**) and other marine natural products such as pinnatoxins^{1d} (**1d**) contain oxygenated heterocycles even more elaborately.

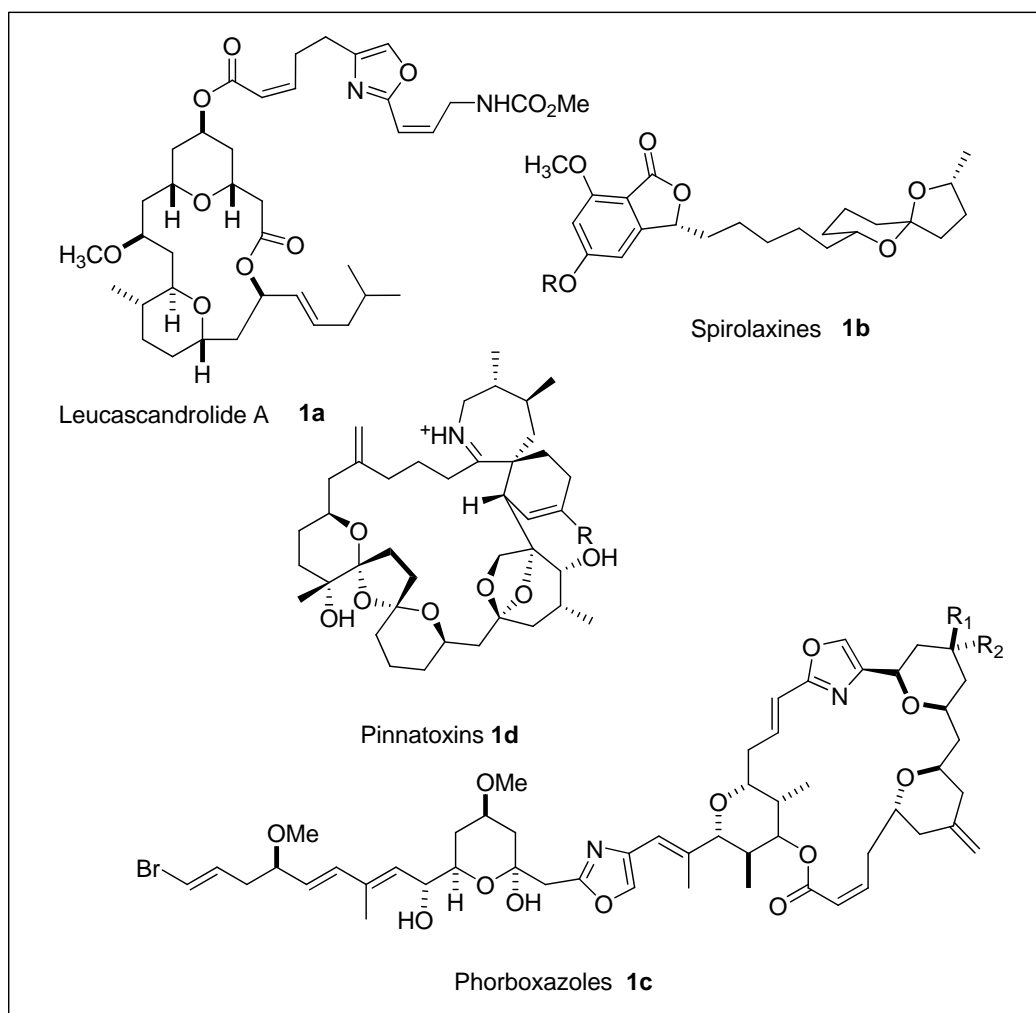


Figure 1

Due to the remarkably rich array of functionalities and chiral centers that these cyclic compounds can incorporate, their stereoselective preparation has become a continuous challenge for organic synthesis practitioners. Apart from conventional methods such as Baeyer-Villiger oxidation^{2a} of cyclopentanones, Hetero-Diels Alder

reactions,^{2b,c} or intramolecular cyclizations³, there is a set of important methodologies based on the cyclization of an oxygenated precursor that affords cyclic ethers in a highly efficient and straightforward manner. In spite of the achievements mentioned above, the use and removal of stoichiometric amounts of often toxic elements have fuelled research into alternative activators of unsaturated substrates that allow the desired intramolecular cyclizations under mild conditions and in a catalytic fashion. In this context, transition-metal catalysts⁴ have been emerged as a new frontier which has enhanced the proficiency of synthetic organic chemists to assemble complex molecular frameworks keeping atom economy of a reaction as one of the primary objectives.

Palladium catalysts in organic synthesis

Palladium, among other transition metals, which has been formerly used only for redox reactions, has recently achieved a prominent role in synthesis due to its potential in mediating manifold and unique transformations, often in a catalytic mode. The large number of organic transformations mediated, the wide functional group tolerance, and the catalytic nature of most of these processes make palladium an ideal basis for devising new methodologies.

Palladium complexes exist in three oxidation states: Pd(0), Pd(II), and Pd(IV). The facile interconversion between these oxidation states is responsible for the broad utility of palladium in organic chemistry, since each oxidation state exhibits different chemistry. Palladium(0) complexes are fairly nucleophilic, rather labile, and also easily oxidized, usually to the Pd(II) state. The most synthetically useful Pd(0) chemistry is based on the oxidative addition of aryl, vinylic or allylic halides or triflates to Pd(0). Palladium(II) complexes are extremely important in organopalladium chemistry. They are typically electrophilic, soluble in most common organic solvents, and stable to air. Thus, they are easily stored and handled. The most common organic substrates for Pd(II) are electron-rich species such as olefins, alkynes, and arenes.

The intramolecular cyclization of palladium π -olefin and π -alkyne complexes is a powerful method for the construction of heterocycles. The π -olefin or π -alkyne complexes are stable but reactive in the presence of a nucleophile. Nucleophilic attack on the π -olefin species usually occurs *anti* to the metal at the more substituted vinylic carbon to give a σ -alkylpalladium(II) complex, which may then undergo a wide variety of

processes resulting in the final heterocycle. Depending on the reaction conditions, these subsequent processes may involve palladium β -hydride elimination, reduction, nucleophilic substitution of the metal, transmetalation, or various insertion processes as outlined in Figure 2.⁶ Pd(0) is usually produced in the final step, which means that a reoxidant is required to transform Pd(0) to Pd(II) to affect a process catalytic in palladium. Common reoxidants are $O_2/CuCl_2$, benzoquinone, $O_2/DMSO$, $FeCl_3$, and $K_2S_2O_8$. The Pd(II)-catalyzed reactions of simple alkenes and dienes, olefins bearing internal nucleophiles, and alkynes thus provides a very valuable approach to a wide range of heterocycles.

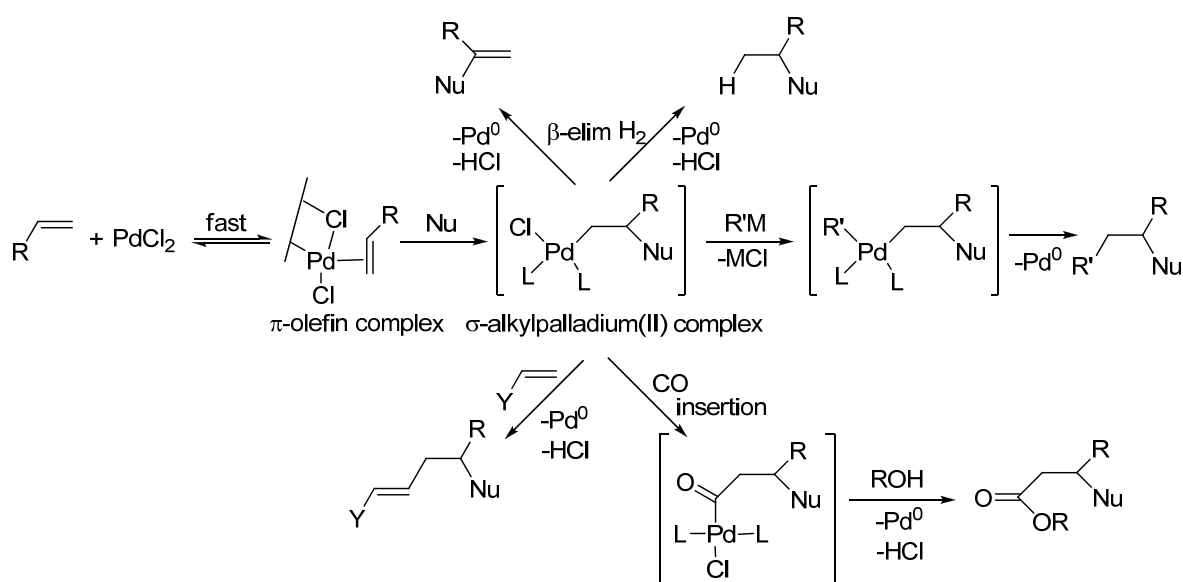


Figure 2: Reaction Pathways Available to π -Olefin Palladium(II) Complexes

Cycloisomerizations catalyzed by Palladium:

The broad range of reactions catalyzed by palladium can be classified into two types based on the nature of products formed- (a) Those forming carbocycles. (b) Those forming heterocycles.

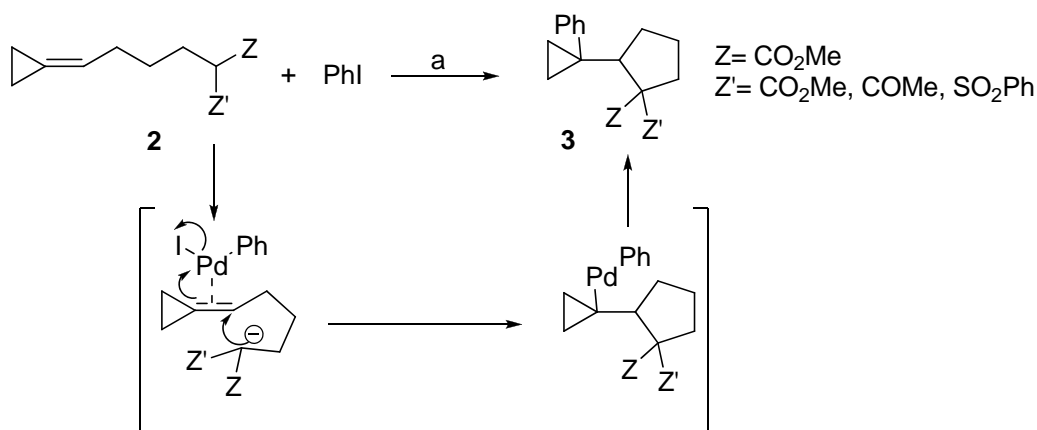
Carbocycle formation:

These set of reactions can be further classified into two types based on the substrates involved i.e. alkenes or alkynes.

Cyclization of unactivated alkenes:

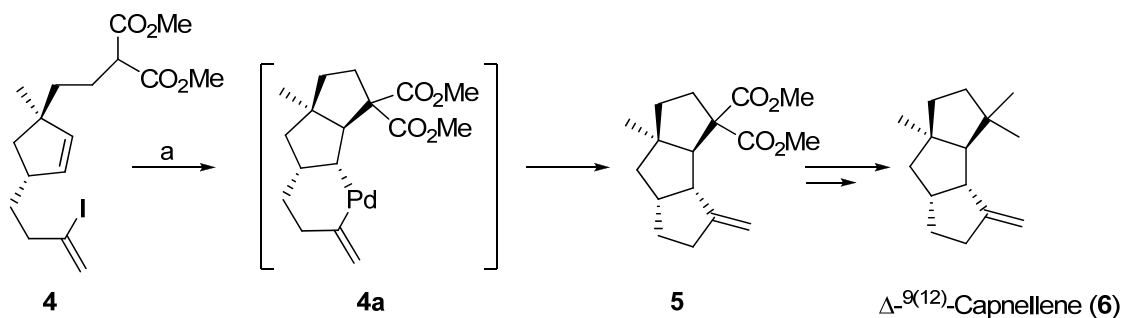
The first example of an intramolecular nucleophilic attack on an unsaturated electrophile activated by an organopalladium species, was reported by Goré and Balme in

1987, where the palladium-mediated reaction of alkylidene cyclopropanes **2** bearing a stabilized carbon nucleophile with phenyl iodide yielded the bicyclic compound **3** (Scheme 1).⁷ Though unactivated olefins are inert towards nucleophilic attack, when complexed to palladium(II) salts, stabilized carbanions may react with these olefin palladium(II) complexes to generate alkyl palladium complexes. In this new cyclization reaction, an organopalladium(II) halide, not a palladium(II) salt, acts as the electrophilic partner of the cyclization. Therefore, this reaction, which only requires catalytic quantities of the metal, results in overall difunctionalization of the olefinic substrate.



Scheme 1: Reagents and conditions: a) NaH, Pd(dba)₂, dppe, DMSO, 95 °C.

Intramolecular version of this strategy has been used for the stereocontrolled total synthesis of the fused tricyclopentanoid (±)-capnellene (**6**), a marine natural product, by applying the palladium-mediated carbocyclization to the internal vinyl iodide **4** as the key step.⁸ The reaction took place in the presence of potassium hydride as base and Pd(OAc)₂/dppe as catalytic system leading to triquinane **5** which was converted into capnellene by standard methods (Scheme 2).

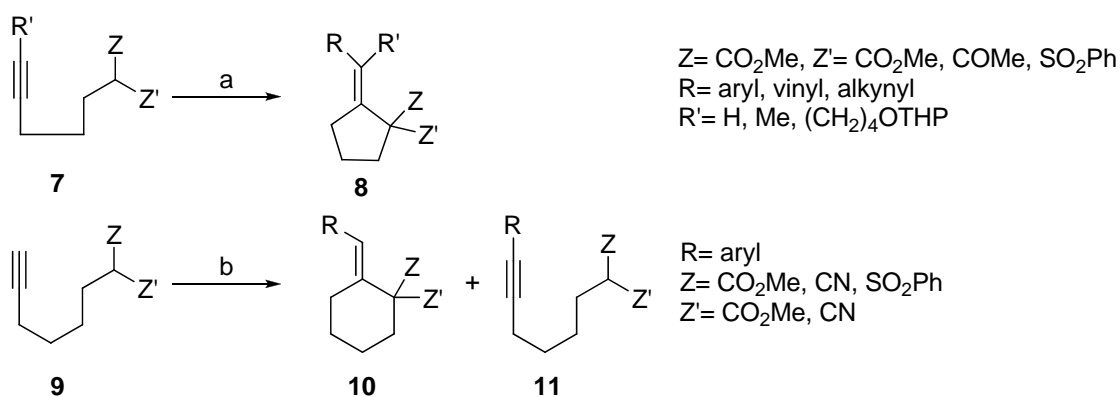


Scheme 2: Reagents and conditions: a) KH, Pd(dppe), THF, rt.

While the methodology for the preparation of cyclopentane derivatives has been well established, the construction of cyclohexane homologues proved to be more difficult. For instance, dimethyl 5-hexenylmalonate showed a strong tendency to give a direct coupling reaction of the alkene with the aryl halide (classical Heck reaction).⁹ However, the cyclization/Heck reaction balance here was also strongly affected by the nature of the nucleophilic part of the precursors.

Cyclization of unactivated alkynes:

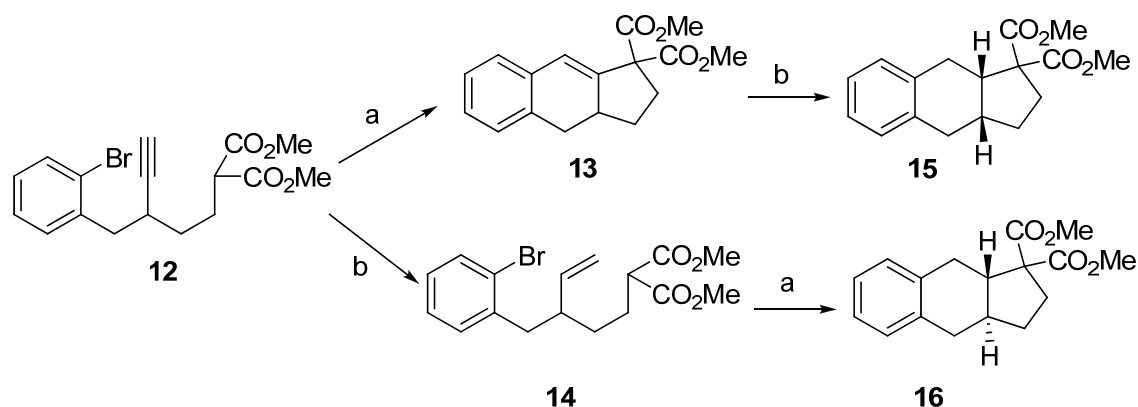
This new cyclopentannulation method was applied to the acetylenic homologues **7** and it must be emphasized that stereodefined exocyclic double bonds were formed even in the case of substituted alkynes ($R_1 \neq H$), the carbonucleophile and the organopalladium species adding in a *trans* fashion across the unsaturated bond. Unfortunately, for acetylenic compounds, the palladium-catalyzed tandem cyclization/coupling reaction remains limited to the formation of five membered rings **8**.¹¹ By using substrates **9** with one carbon more in the side chain, some severe limitations were observed: the palladium mediated reaction led to the formation of the desired stereodefined arylidene cyclohexane compound **10** accompanied by the linear coupling product **11** resulting from the classical Sonogashira type¹⁰ reaction (Scheme 3).



Scheme 3: Reagents and conditions: a) RX, Pd(dba)₂, dppe, *t*-BuOK, THF, rt; b) RX, Pd(dba)₂, dppe, *t*-BuOK, DMSO, 80 °C.

A practical and efficient strategy for the synthesis of either *cis*- or *trans*-hexahydro-1*H*-benz[*f*]indene **15** and **16** was developed starting from the common

acetylenic precursor **12**. The synthetic strategy executes different stereo chemical outcome just by changing the sequence of the reactions (Scheme 4).¹²



Scheme 4: Reagents and conditions: a) Pd(dppe), KH, NMP; b) H₂, Pd/C, EtOH.

Heterocycle formation:

Although there are a number of examples of intramolecular reactions of soft carbo nucleophiles on alkenes coordinated by organopalladium complexes, there are no examples of the same reaction realized in the presence of heteronucleophiles. In this case, the palladium-catalyzed arylation of olefins (Heck reaction)⁹ prevails over the intramolecular attack of the heteronucleophile on the activated carbon-carbon double bond, leading to the linear arylated product. Such difference in reactivity may be due, in part, to the higher basicity of heteronucleophiles. It is noteworthy that a variety of heterocyclic systems have been synthesized by attack of oxygen or nitrogen nucleophiles on alkenes coordinated by palladium salts such as palladium chloride or palladium acetate (Figure 3).

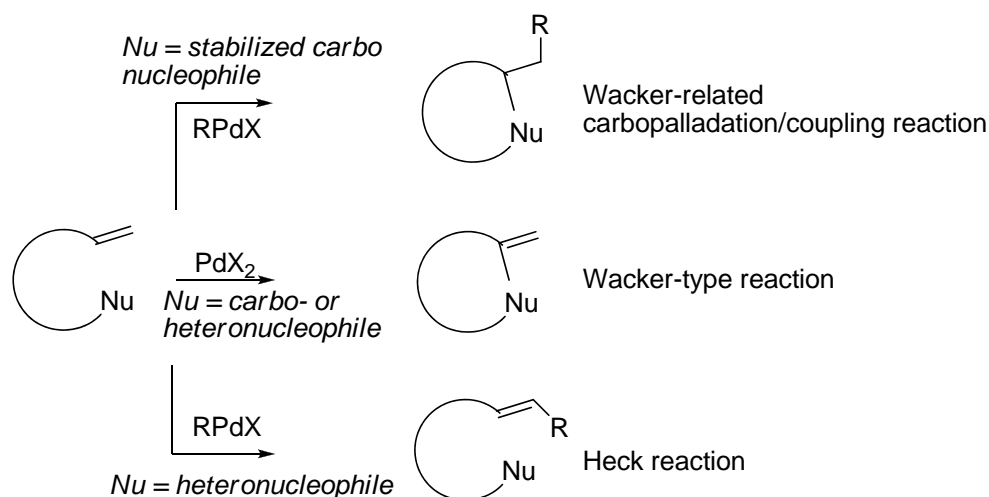


Figure 3: Various Pd-catalyzed intramolecular cyclizations of alkenes.

In marked contrast, various electrophilic organopalladium complexes are able to trigger the intramolecular nucleophilic attack of a heteronucleophile on alkynes through coordination, and a variety of heterocyclic systems have been elaborated using this strategy. However, a competitive reaction may arise when terminal alkynes are involved, i.e. the direct coupling reaction of the alkyne with the unsaturated halide or triflate (Figure 4).

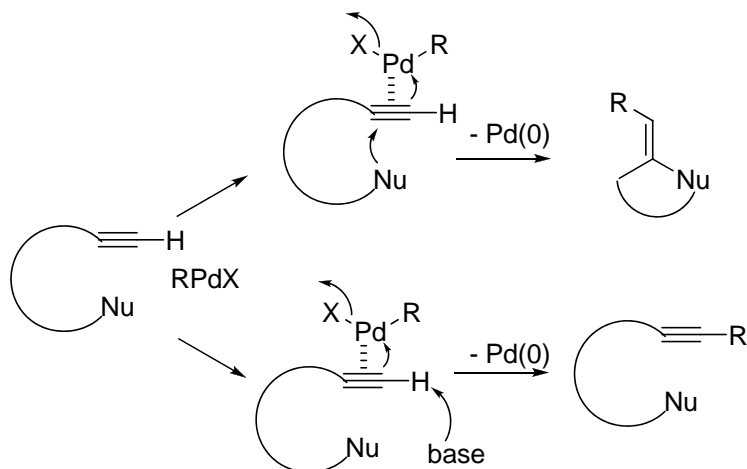
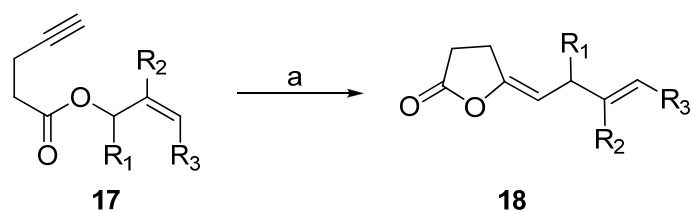


Figure 4: Intramolecular additions to Pd-complexed alkynes.

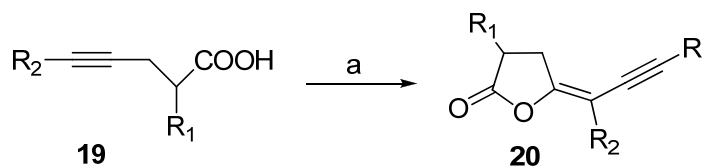
Oxygen heterocycles:

Tsuda and Seagusa in 1988 first developed an organopalladium catalyzed cyclization of an acetylenic heteronucleophile on allyl 4-pentynoates **17** (Scheme 5) to produce the substituted unsaturated lactones **18** regio- and stereoselectively.¹³



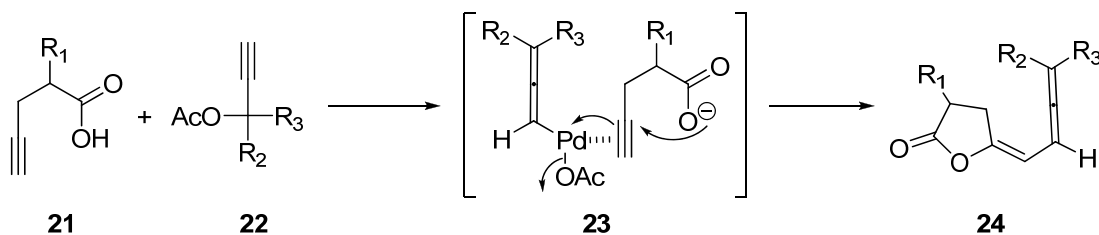
Scheme 5: Reagents and conditions: a) $\text{Pd}_2(\text{dba})_3 \cdot \text{CHCl}_3$, $\text{P}(\text{OCH}_2)_3\text{CEt}$.

The transformation of similar pentynoates to the biologically active enol lactones **20**, under the influence of σ -ethynylpalladium complexes generated from alkynyl bromides was reported by Balme and co-workers (Scheme 6).¹⁴



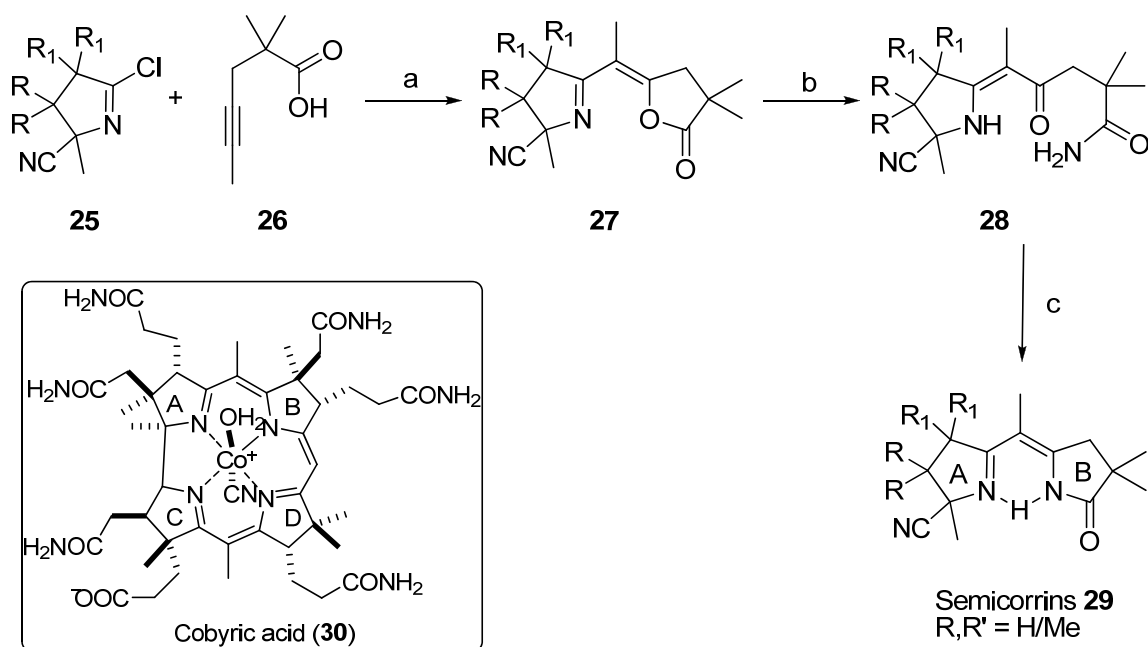
Scheme 6: Reagents and conditions: a) $\text{RC}\equiv\text{CBr}$, $\text{Pd}(\text{OAc})_2$, TFP, $t\text{BuOK}$, DMSO.

A similar procedure in which σ -allenylpalladium complexes **23** issued from propargyl acetates **22** activate the carbon-carbon triple bond was then developed to yield potentially bioactive new unsaturated *exo*-enol lactones **24** (Scheme 7).¹⁵



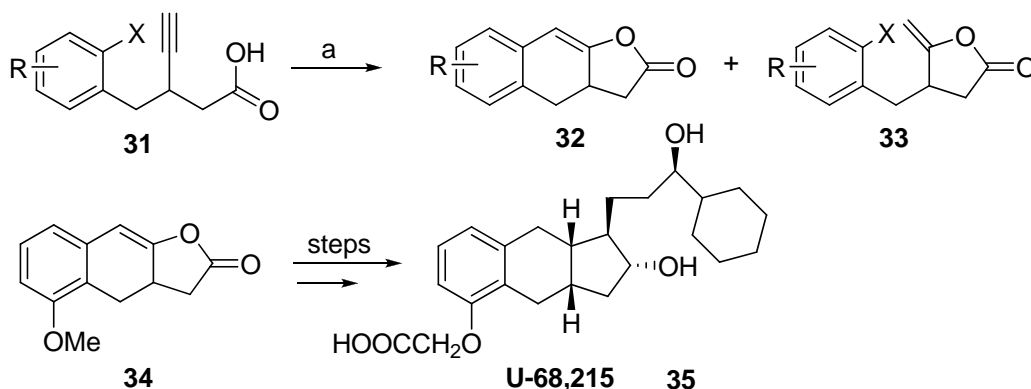
Scheme 7: Reagents and conditions: $\text{Pd}(\text{OAc})_2$, TFP, K_2CO_3 , DMSO.

Jacobi and coworkers¹⁶ extended the palladium-mediated coupling/cyclization reaction of alkynoic acids for the preparation of meso-substituted semicorrins **29**, as an approach towards the synthesis of Corrin derivatives such as Cobyric acid **30** (Scheme 8). A similar strategy was used for the synthesis of compounds of the Chlorin family.



Scheme 8: Reagents and conditions: a) Pd(PPh₃)₄, BnNEt₃Cl, NEt₃, MeCN, 60 °C; b) NH₃; c) P₂O₅.

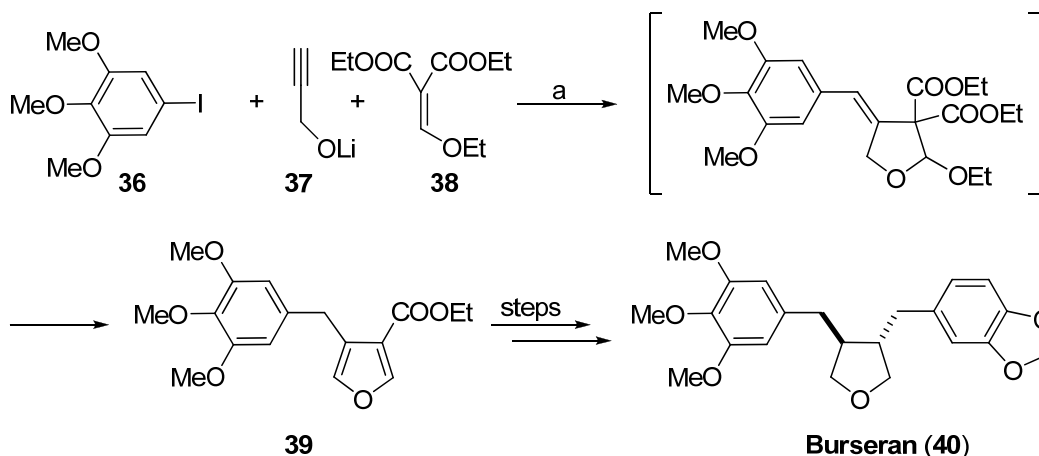
The cytotoxic tricyclic compound U-68,215 (**35**) has been synthesized by Balme and coworkers¹⁷ (Scheme 9) employing intramolecular cyclization/coupling reaction of alkynoic acids that was developed by the same group for the synthesis of various benzo-annulated enol lactones of type **33**.



Scheme 9: Reagents and conditions: a) Pd(OAc)₂, TFP, KF, DMSO.

A novel one-pot, two-step synthetic entry into functionalized 4-benzylfuran derivatives of type **39** was then developed by extending this strategy to the commercially available diethyl ethoxymethylene malonate as conjugate acceptor. It involved a conjugate addition, a palladium-catalyzed cyclization/coupling reaction, an alkoxide-induced decarboxylative elimination, and finally a double bond isomerization.¹⁹ A formal

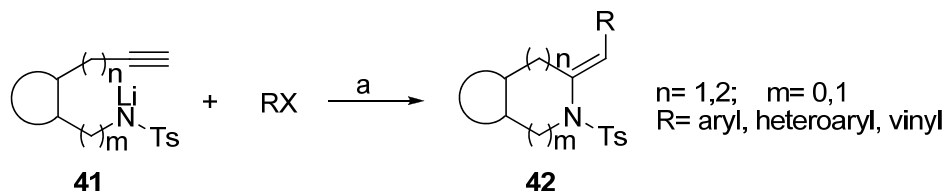
synthesis of the lignan anti-tumor Burseran (**40**) employed this process as a key step illustrating the potential utility of this concept in the synthesis of important natural products of the lignan family (Scheme 10).



Scheme 10: Reagents and conditions: a) $\text{PdCl}_2(\text{PPh}_3)_2$, $n\text{-BuLi}$, DMSO-THF, 20 °C.

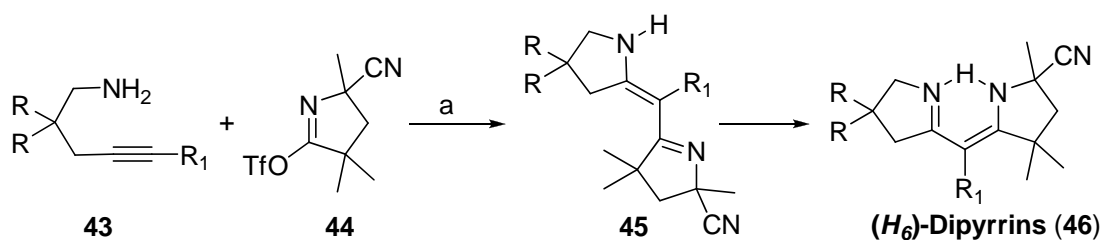
Nitrogen heterocycles:

Various nitrogen heterocycles can be synthesized efficiently by intramolecular *trans* addition of alkenyl or aryl groups and amines to internal or terminal alkynes.²⁰ This strategy has been applied to the construction of stereodefined 2-alkylidene pyrrolidine or piperidine derivatives **42** (Scheme 11).



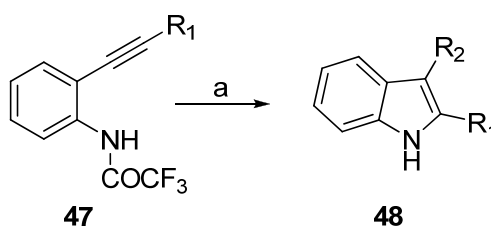
Scheme 11: Reagents and conditions: a) $\text{Pd}(\text{OAc})_2$, PPh_3 , THF, 60 °C.

This strategy was used for the construction of hexahydrodipyrins **45**, in a study directed toward the construction of Corrins **46**, a class of natural products having interesting biological activities, in particular a potential utility in photodynamic therapy (Scheme 12).²¹



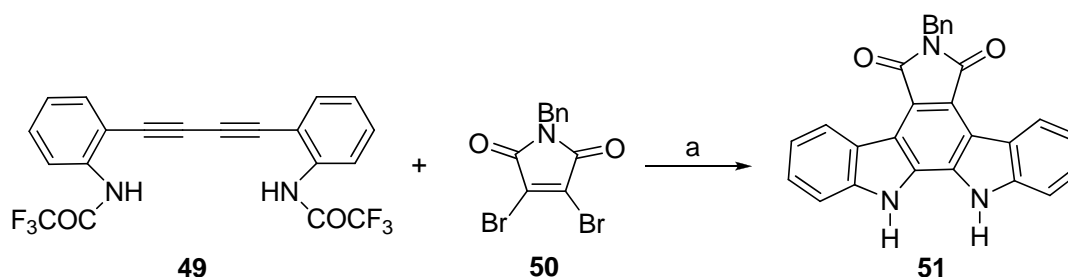
Scheme 12: Reagents and conditions: a) Pd(PPh₃)₄, THF, rt (or) Pd₂dba₃, TFP, MeCN, 80 °C.

The cyclization reaction of *o*-alkynyltrifluoroacetanilides **47** promoted by various organopalladium complexes generated *in situ* from *Csp*² donors such as aryl and vinyl halides (or triflates), as well as allyl esters and alkyl halides have been developed by Cacchi (Scheme 13).²² It allowed for the preparation of a large variety of functionalized indole derivatives as **48**.



Scheme 13: Reagents and conditions: a) R²X, Pd(PPh₃)₄, K₂CO₃, MeCN, 20-80 °C.

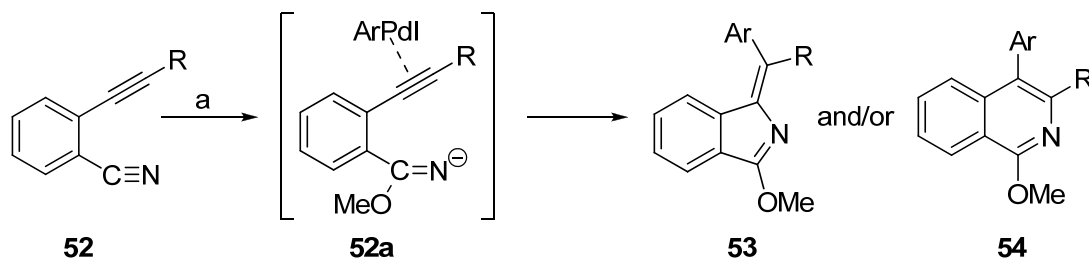
Based on the same strategy, the indolo[2,3-*a*]carbazole ring system **51**, common to Arcyriaflavin A and Rebeccamycin was prepared by palladium(0)-catalyzed poly annulation of diacetylene **49** with *N*-benzyl-3,4-dibromomaleimide **50**, wherein two carbon-carbon, and two nitrogen-carbon bonds were formed in a single step (Scheme 14).²³



Scheme 14: Reagents and conditions: a) Pd(PPh₃)₄, K₂CO₃, MeCN, 50 °C.

The reaction of 2-alkynylbenzonitriles **52** with sodium methoxide and phenyl iodide, or other aryl iodides bearing electron-donating substituents, was developed using

$\text{Pd}(\text{PPh}_3)_4$ as catalyst for the formation of five or/and six membered ring heterocycles, namely the isoindoles **53** and isoquinolines **54** respectively. The product distribution was shown to be dependent on the nature of the substituent on the terminal alkyne carbon (Scheme 15).²⁶



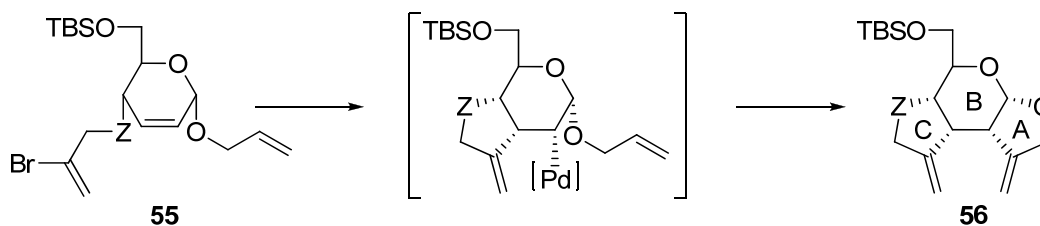
Scheme 15: Reagents and conditions: a) ArI , $\text{Pd}(\text{PPh}_3)_4$, Na/MeOH , reflux.

Cycloisomerisations on sugar templates:

Besides the above transformations, palladium catalyzed cyclization on sugar derived templates deserves a special mention, which is rather a remote area. Monosaccharides provide an excellent platform to tailor molecular diversity by appending desired substituents at selected positions around the sugar scaffold. The presence of five functionalized and stereocontrolled centres on the sugar scaffolds gives the chemist plenty of scope to custom design molecules to a pharmacophore model. The importance of carbohydrates in biochemistry, in medicinal chemistry, and in the various aspects of life processes coupled with the charm and structural diversity of their multichiral architecture have long challenged synthetic chemists toward a multitude of approaches to this rich class of compounds. The search for novel stereoselective and versatile methodologies to ascend the carbohydrate series represents an important goal of sugar research.

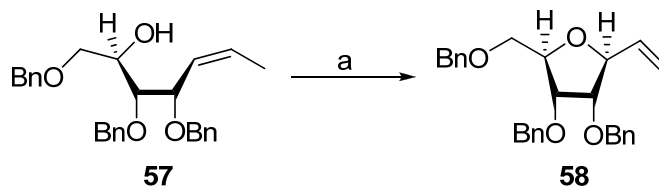
Despite the precise stereochemistry and rich functionality of the carbohydrate core in the synthesis of polycyclic molecules, the use of sugar templates for organometallic-catalyzed stereoselective cyclization remains still quite rare. Some examples of homochiral substituted cyclopentanes and their heterocyclic analogues were prepared *via* palladium-mediated cyclization of the appropriate pseudoglycols. Bis-annulated pyranosides were also obtained by the Pauson-Khand reaction.²⁷ The

carbohydrate derivatives **55** were converted into the corresponding bis-annulated pyranosides **56** via a 5-*exo* trig cascade cyclization, in the presence of a catalytic amount of Pd(OAc)₂ and PPh₃, under Jeffery's conditions, in quite good yields (Scheme 16).



Scheme 16: Pd-mediated cascade cyclizations on sugar templates.

The increasing interest in bio-active carbohydrates stems from a new appreciation that carbohydrates can play an important role in normal and disease processes. Advances made in the understanding of glycobiology, led to the development of the synthetic routes to several glycosyl mimics such as *C*-glycosides, *C*-nucleosides etc. An intramolecular oxidative cyclization protocol, making use of the Pd(OAc)₂-NaOAc-O₂ system in DMSO, has been developed for the efficient conversion of sugar derived δ -olefinic alcohols into the *C*-vinyl furanoside class of compounds **58** (Scheme 17).²⁸



Scheme 17: Reagents and conditions: a) Pd(OAc)₂-NaOAc-O₂, DMSO.

The monosaccharide-based scaffold contains four to five chiral, functionalized positions. In principle, various substituents can be appended at each position and chirality at that centre can be altered. Sugar scaffolds provide an unparalleled opportunity to generate libraries of high functional and structural diversity. If, for example, three different pharmacophore groups (read substituents) are positioned on glucose, 60 unique products are formed, all with similar molecular properties (e.g. same molecular weight and same type of functional groups) but with different orientations of the pharmacophore groups, which is achieved by just altering the position of each substituent around the scaffold. In the mid-1970s, Vasella reported the 1,3-dipolar cycloaddition reactions of nitrones incorporated into sugar templates.²⁹ Vasella's studies were regarded as seminal

for the development of the stereoselective organic reactions achieved on sugar templates. Sugar-template-based stereoselective reactions have been actively investigated by a number of groups; especially in the past ten years.³⁰ The sugar-based templates utilized for asymmetric synthesis are mainly classified into five-membered glycofuranosidic frameworks or six-membered glycopyranosidic frameworks. Among glycofuranosidic templates, the utility of so-called diacetone-D-glucose i.e. 1,2:5,6-di-*O*-isopropylidene- α -D-glucofuranose has been extensively investigated.

Conclusion:

Palladium-catalyzed cyclization processes provide a powerful methodology for the elaboration of carbocyclic as well as heterocyclic derivatives, allowing the stereoselective formation of bridged rings or spirocycles. Recent studies in our laboratory were concerned with the use of palladium as a tool for the stereoselective transformation of carbohydrates. Pd mediated cyclizations on sugar derived templates comprise a very remote as well as a dormant area wherein several carbon frameworks could be devised with an ease which would otherwise seem to be difficult using the conventional methods of carbon-carbon bond formation.

Hence devising a common strategy for sugar templates that enables suitable conditions for the synthesis of a plethora of compounds that would constitute a library of compounds is targeted. Further editing the target molecule *via* functional group modifications i.e. the preparation of analogues may provide sufficient insight into the biological activity of a particular compound/molecule.



1.2 PRESENT WORK

Transition metal-catalysed reactions belong to the powerful tools of contemporary organic synthesis. Transition metal mediated addition of *C*-and hetero atom nucleophiles across a carbon-carbon double and/or triple bonds is one of the most interesting and important reactions in organic chemistry.²⁸ They allow a considerable increase in the molecular complexity in a single operation with substantial chemo-, regio- and stereoselectivities. Designing effective routes to construct complex cyclic structures through organotransition-metal catalyzed reactions provides many attractive possibilities, which by conventional procedures would need a large number of synthetic transformations.

The intramolecular version of this reaction falls under the broad category of cycloisomerization reactions. Cycloisomerization reactions are characterized by their complete atom economy and have been recognized as attractive tools for delivering complex molecular diversity.²⁹ Cycloisomerization of alkynols is projected as a contrivance to synthesize oxygen-containing heterocycles encompassing functionalized furan, pyran, benzopyran and spiroketal skeletons.³⁰ Various transition metals like palladium, platinum, tungsten, molybdenum, ruthenium, rhodium, gold and iridium have been explored as catalysts for cycloisomerization reactions.³¹

As the exploration of the properties of complex natural products becomes increasingly more sophisticated with the technological advances being made in their screening and evaluation and as structural details of their interaction with biological targets becomes more accessible, the importance and opportunities for providing unique solutions to complex biological problems has grown. Recent disclosures describing the unique structures and biological activities of recently isolated spiroketals like Cyclodidemniserinol trisulfate (**59**), Didemniserinolipid B (**60**) and Integrastatin (**61**) having prominent HIV-1 integrase inhibitory activity have generated much excitement in the chemical and pharmaceutical communities (Figure 5).³² In search of better anti-retroviral chemotherapy, these compounds are emerged as potential targets for total synthesis on one hand as key pharmacophores on which the new leads can be build up.

Their isolation has motivated many research groups to begin programs aimed at developing efficient routes to these compounds.

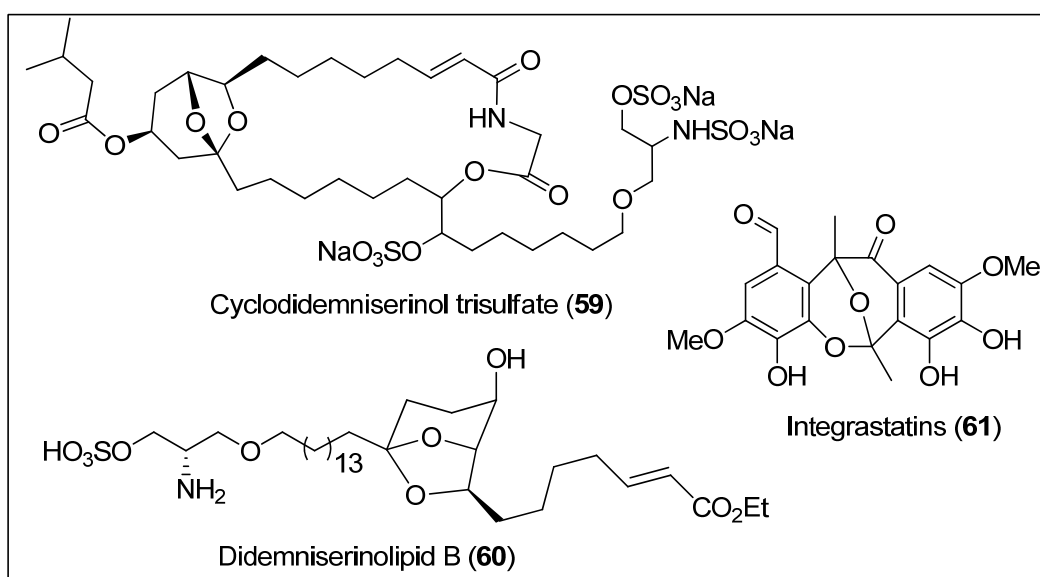


Figure 5: Novel HIV-Integrase inhibitors with ketal moieties.

Considering the promising HIV-integrase activity of these natural products and more importantly the presence of the key bicyclic ketal unit in these natural products we have initiated a program to synthesize these natural products and their congeners. The basic concern of our synthesis is to identify a skeletal construct that addresses the synthesis of the central bicyclic ketal unit with enough flexibility in placing the pendant substituents. Construction of the bicyclic ketals employing a final ketalization of a suitably positioned keto diol is a commonly practiced protocol; we have opted for a more robust surrogate that will also address the flexibility in terms of the placing pendant groups. The cycloisomerization of alkyndiols has attracted our attention in this context. Though, the alkyndiol cycloisomerization has been reported by employing Pd and Hg about three decades ago, its potential in the synthesis of complex natural products has not yet been explored. More interestingly, the influence of various parameters such as electronic and steric factors over these cycloisomerization reactions has not yet been dealt in a systematic fashion.

The key issue is the mode of cyclization *i.e.* *exo-dig* vs. *endo-dig*.³³ There are several instances in the literature that indicate the obtuse angle of $120\text{--}127^\circ$ for the

approach of a nucleophile to a triple bond triggers the dominance of 5-*exo*-dig over 6-*endo*-dig for electronically unbiased acetylenes.³⁴ The majority of theoretical and experimental studies to understand 5-*exo*-dig vs. 6-*endo*-dig cyclizations consider mainly the base mediated cyclization with hard nucleophiles,³⁵ however, investigations dealing with metal-catalyzed cyclizations³⁶ are rare. Keeping the construction of densely functionalized bicyclic ketal as the main objective in this endeavour, validity and mechanistic investigations of palladium mediated cycloisomerisations³⁷ was our goal (Figure 6).

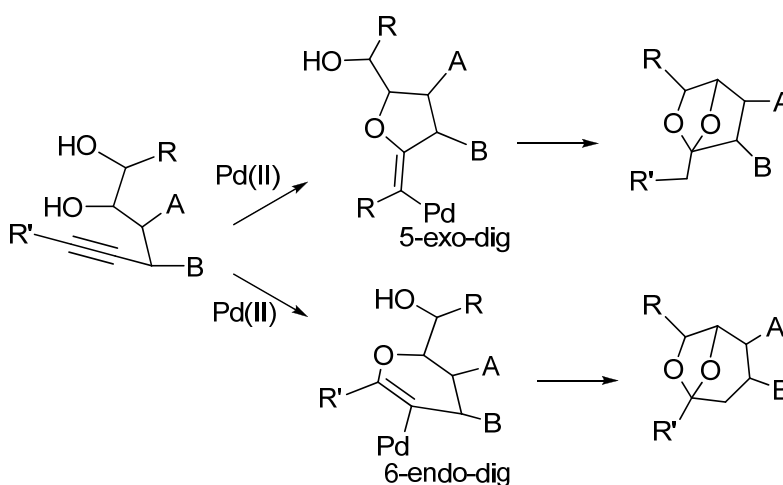


Figure 6: Key issue of *exo* vs *endo* dig cyclisations.

Considering the resemblance of the bicyclic ketal unit present in serinolipids with that 1,6-anhydrosugars, we have opted for a sugar residue as a template to pendant the key alkyne and diol unit. In order to investigate the influence of electronic factors on these cyclizations, the alkyne and diol units are projected in the same plane around the key sugar residue in our substrates. The 3-*C*-alkynylfuranosyl derivatives having either *ribo*- or *allo*-configurations have been deployed in this context and in order to interchange the electron density at the two alkyne carbons, we decided to go for a modular placing of the substituents on the other end of the alkyne by employing Sonogashira coupling. The structures of the designed substrates and the possible products one can expect from these cyclizations are given in the Figure 7.

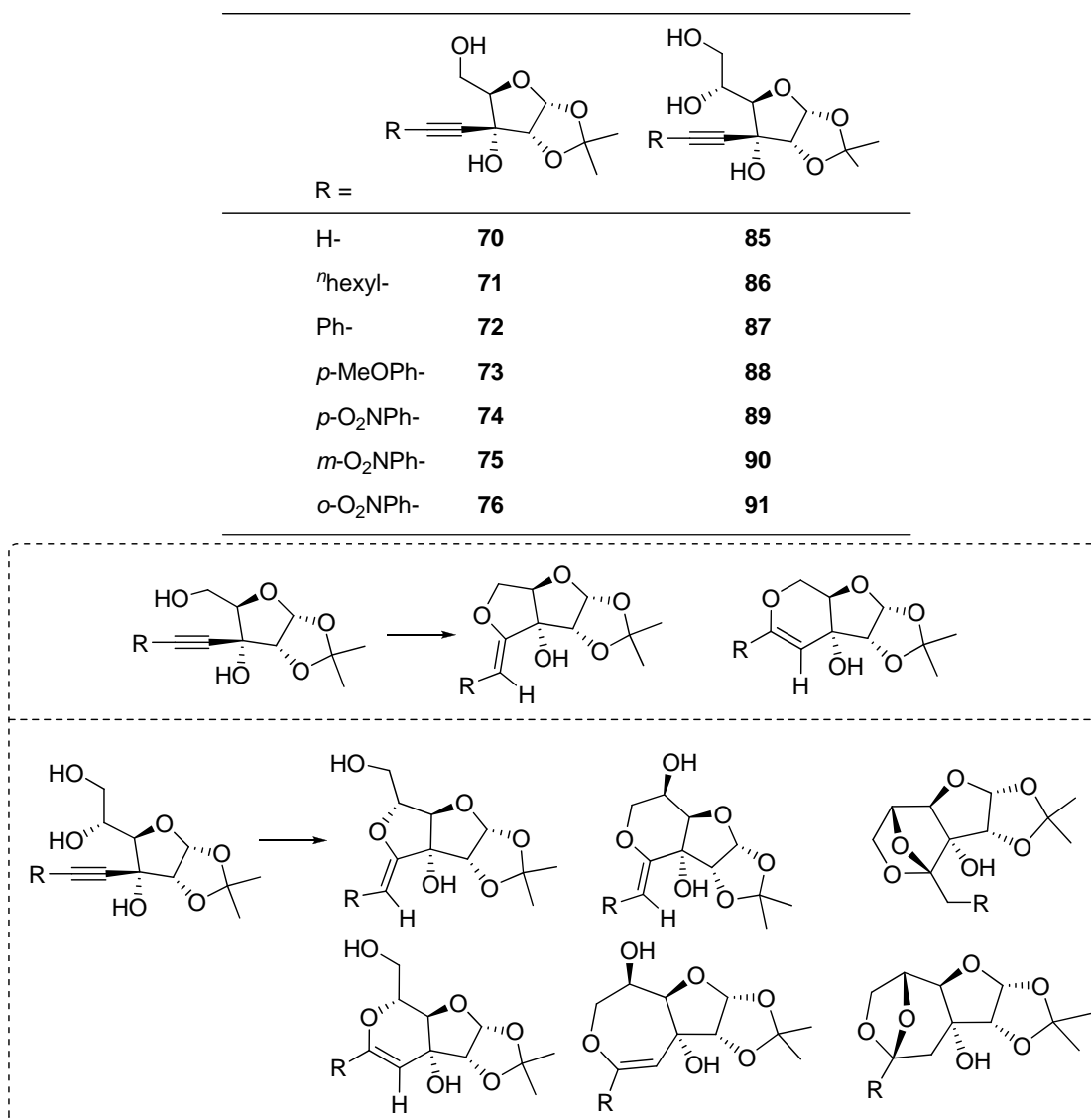
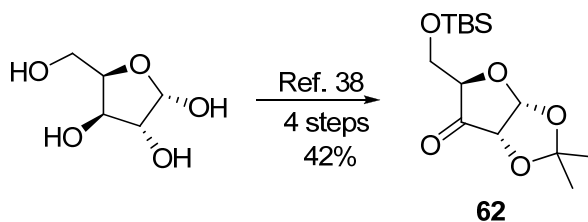


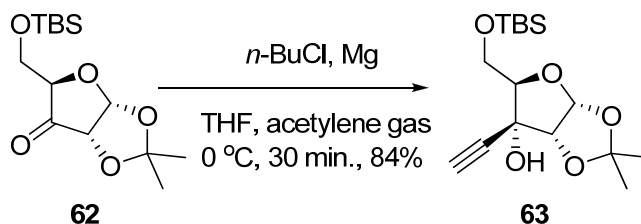
Figure 7: Model substrates for the projected alkynol cyclization reactions and the expected product structures

The synthesis of the requisite model 3-*C*-alkynyl-*ribo*-furanose derivatives **63–69** was started from the known 3-*ulose* derivative **62**.³⁸ According to known procedure D-xylose was converted to **62** in four steps with an overall yield of 42%.



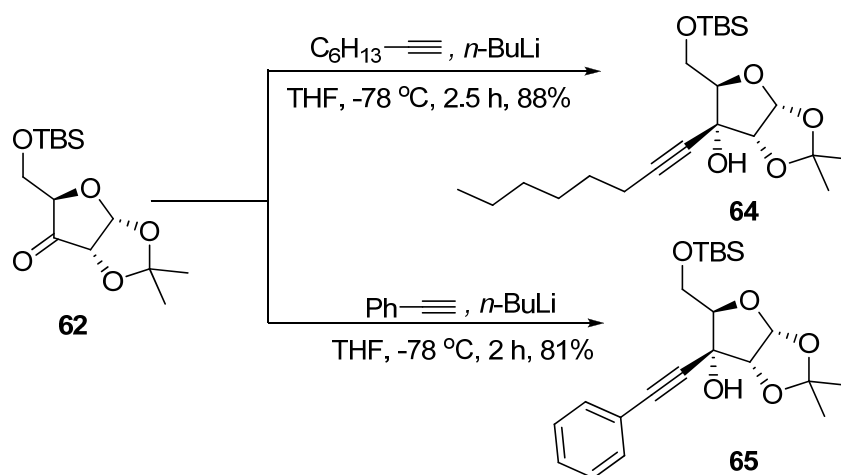
Scheme 18

Addition of ethynylmagnesium chloride, prepared by exchange with *n*-butylmagnesium chloride with acetylene to **62** resulted in **63** with 84% yield. Appearance of a singlet proton at 2.54 ppm in $^1\text{H-NMR}$ and two carbons at 76.0 (d) and 80.4(s) ppm in $^{13}\text{C-NMR}$ accounted for the presence of a terminal alkyne in **63** (Scheme 19).



Scheme 19

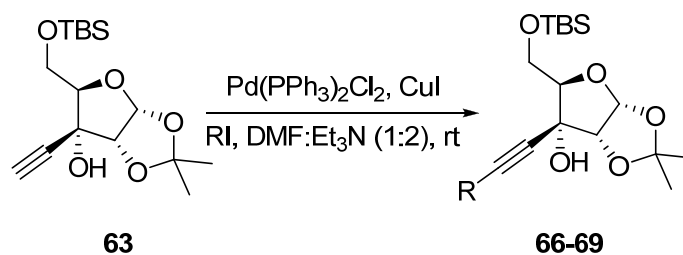
To achieve different substituted alkynes, two different routes were followed. First, addition of the lithiated salts of 1-octyne and phenylacetylene (Scheme 20) to **62** gave **64** and **65** respectively. The resonance of aliphatic protons of **64** in the up-field region in $^1\text{H-NMR}$ spectrum and presence of two acetylenic singlet carbons at 76.8 and 88.3 ppm in $^{13}\text{C-NMR}$ were in accordance with structure of **64**. The presence of aromatic protons in the region 7.29-7.45 ppm in $^1\text{H-NMR}$ and two singlet carbons at 85.7 and 87.8 ppm in $^{13}\text{C-NMR}$ approved the structure of **65**.



Scheme 20

As our second route to get functionalized alkyne substrates, we followed Sonogashira coupling.³⁹ Sonogashira coupling reaction of **63** with different aryl iodides was carried out to give compounds **66–69**. Accordingly the reaction was performed in a

mixture of Et₃N: DMF (2:1) as the solvent using catalytic Pd(PPh₃)₂Cl₂ and CuI (Scheme 21).

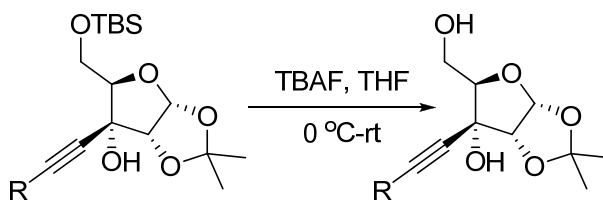


Scheme 21: Sonogashira coupling on the alkyne **63**

Product	Time	Product	Time
	Yield (%)		Yield (%)
 66	2.5 h 80	 68	2 h 76
 67	3 h 78	 69	3.2 h 81

Table 1

The TBS group present at *O*-5 of **63–69** was subsequently removed by using TBAF-THF to give alkynol substrates **70–76**.



Scheme 22

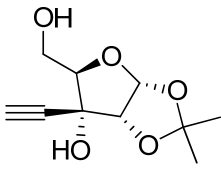
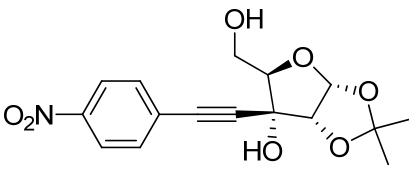
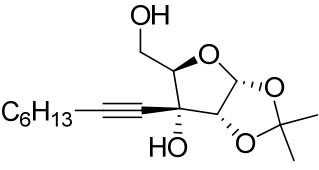
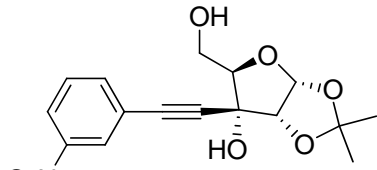
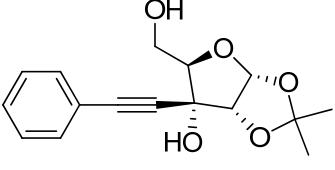
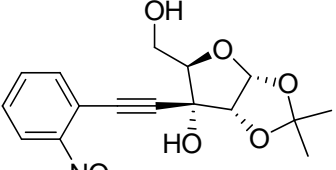
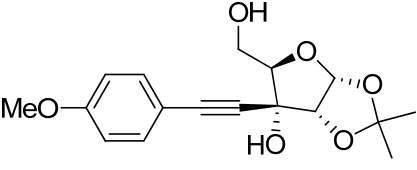
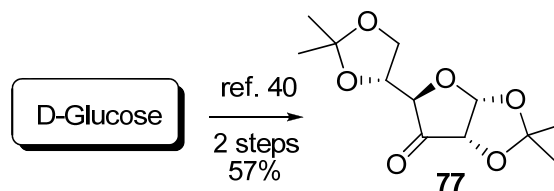
Product	Time Yield (%)	Product	Time Yield (%)
	1 h 82		1.5 h 85
70		74	
	1 h 83		2 h 80
71		75	
	1 h 80		2 h 83
72		76	
	4 h 85		
73			

Table 2

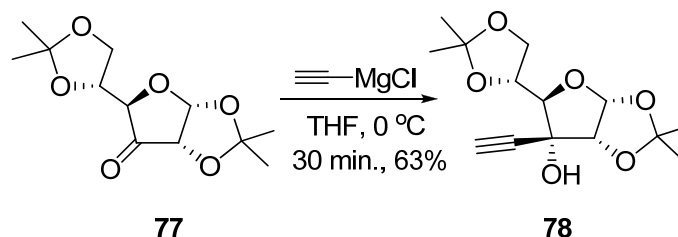
The synthesis of the second set of cycloisomerization substrates **78–84** was carried out in a similar manner from ulose **77** (Scheme 23).⁴⁰



Scheme 23

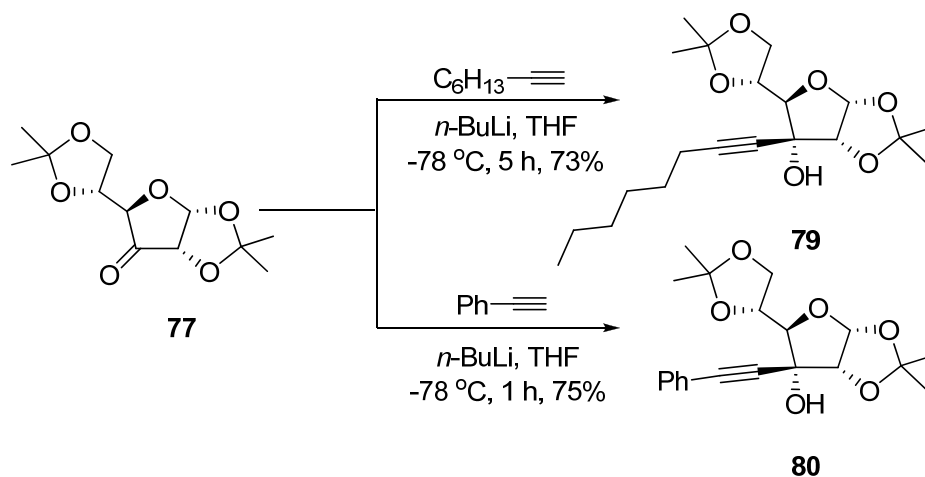
Following the established sequence for **62**, addition of ethynylmagnesium chloride, prepared by exchange with *n*-butylmagnesium chloride with acetylene to **77**

resulted in **78** with 63% yield. A singlet proton appearing at 2.64 ppm in $^1\text{H-NMR}$ and two carbons at 75.7($-\text{C}\equiv\text{CH}$) and 76.8($-\text{C}\equiv\text{CH}$) ppm in $^{13}\text{C-NMR}$ accounted for the presence of a terminal alkyne in **78** (Scheme 24).



Scheme 24

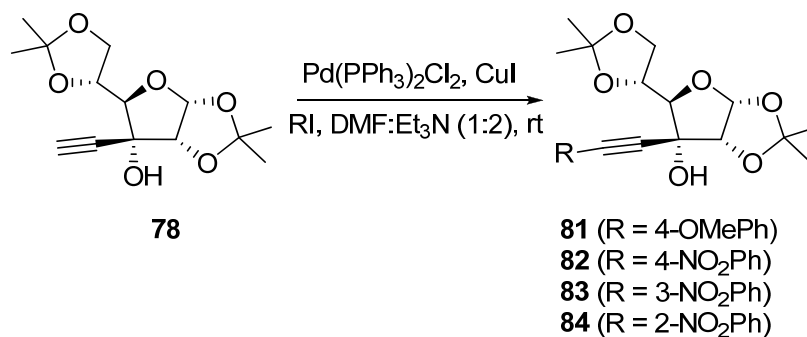
Addition of the lithiated salts of 1-octyne and phenylacetylene to **77** resulted in **79** and **80** respectively (Scheme 25). The resonance of aliphatic protons of **79** in the up-field region in $^1\text{H-NMR}$ spectrum and presence of two acetylenic singlet carbons at 77.8 and 89.7 ppm in $^{13}\text{C-NMR}$ were in accordance with structure of **79**. The presence of 5 aromatic protons in the region 7.29-7.47 ppm in $^1\text{H-NMR}$ and two singlet carbons at 85.7 and 88.4 ppm in $^{13}\text{C-NMR}$ approved the structure of **80**.



Scheme 25

Sonogashira coupling reaction of **78** with different aryl iodides was carried out to give compounds **81–84**. The reaction in general were performed at room temperature in a mixture of Et_3N : DMF (2:1) as the solvent using catalytic $\text{Pd}(\text{PPh}_3)_2\text{Cl}_2$ and CuI (Scheme 26). Structures of all the coupled products were well characterized from their spectral

data and elemental analysis. The observed similarities of characteristic acetylenic singlet carbons in the ^{13}C NMR spectra are tabulated below (Table 3).

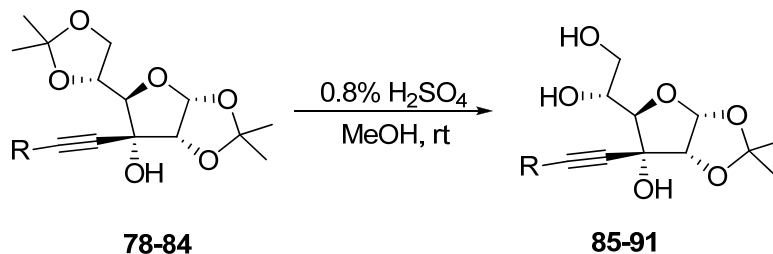


Scheme 26

Compound	Time Yield (%)	δ of the alkyne carbons
 81	10 h 70	84.2 and 88.8 ppm
 82	4 h 91	86.4 and 90.8 ppm
 83	5 h 95	85.8 and 88.4 ppm
 84	5 h 84	83.6 and 93.6 ppm

Table 3: Characteristic ^{13}C chemical shifts of the alkynes.

The selective hydrolysis of the terminal 5,6-acetonide group of **78–84** with cat. H_2SO_4 in methanol completed the synthesis of projected cyclisomerization substrates **85–91** (Scheme 27 and Table 4).



Scheme 27

Product	Time	Yield (%)	Product	Time	Yield (%)
	12 h	68		14 h	75
85			89		
	15 h	79		12 h	77
86			90		
	15 h	70		12 h	73
87			91		
	12 h	80			
88					

Table 4

Having both sets of model substrates i.e. 3-*C*-alkynyl-*ribo*-furanose derivatives **70–76** and 3-*C*-alkynyl-*allo*-furanose derivatives **85–91** in hand; our next concern was their Pd-mediated cycloisomerization reaction. All the reactions were carried out at room temperature employing Pd(CH₃CN)₂Cl₂ as the catalyst in dry acetonitrile. The results are summarized in scheme 28 and table 5.

R	Substrate	Time (h)	Product 1 (Yield)	Product 2 (Yield)
H	70	1	92 (67%)	--
<i>n</i> -hexyl	71	32	--	94 (51%)
Ph	72	48	96 (29%)	97 (59%)
4-MeOPh	73	27	--	98 (77%)
4-O ₂ NPh	74	12	99 (80%)	–
3-O ₂ NPh	75	12	100 (64%)	101 (14%)
2-O ₂ NPh	76	12	102 (60%)	103 (20%)

Table 5

Scheme 28: Cycloisomerization reactions of 3-*C*-alkynyl-*ribo*-furanose derivatives **70–76**

The parent compound **70** gave exclusively ketal **93** resulting from hydrolysis of the transient exo-enol product **92**. The structure of **93** was elucidated by spectral and elemental analysis. The appearance of a 3-proton singlet at 1.56 ppm in ¹H-NMR and characteristic hemiketal carbon singlet at 105.6 ppm in ¹³C-NMR confirmed the assigned structure (Figure 8). Cycloisomerization of alkynol **71** afforded the *endo*-product **94** exclusively, whose structure was supported by spectral and elemental analysis. A broad singlet corresponding to olefinic-H was appeared at much higher field (4.40 ppm) in the ¹H NMR spectrum and the olefinic carbons with substantial chemical shift difference [δ 94.1 (d), 159.6 (s)] and upfield OCH₂ triplet at 62.9 ppm in the ¹³C NMR spectrum of compound **94** clearly established the presence of a dihydropyran unit. Compound **94** was found to be susceptible to hydration in CDCl₃ and resulted in the formation of hemiketal **95** as a single anomer. The spectral data of resulting product **95** supported the assigned

structure and further single crystal X-ray structural analysis confirmed the assigned structure (Figure 9).

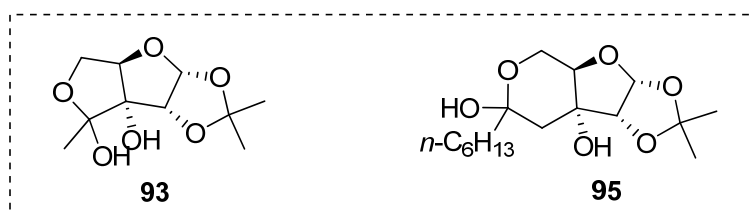


Figure 8

While the cycloisomerization of the simple phenyllakynol **72** gave a regiomeric mixture of *exo*-product **96** (29%) and *endo*-product **97** (59%), only formation of *endo*-product **98** was observed with methoxyphenyl alkynol **73**. The structures of the *exo*-product **96** and of the *endo*-product **97** were proposed with the help of ¹H, ¹³C NMR analysis. For example, the characteristic furan ring CH₂ triplet of **96** (71.2 ppm) was resonated at 9.6 ppm down field when compared to corresponding pyran **97** (63.6 ppm) in the ¹³C NMR spectrum. The single crystal X-ray study (Figure 9) of the *endo*-product **97** proved its structure.

The cycloisomerization of the regiomeric nitrophenylalkynols **74–76** afforded 5-*exo*-products exclusively or as the major product. From the cycloisomerization reactions of *m*- and *o*-nitro derivatives **75** and **76**, the *endo*-products **101** and **103** respectively, could be isolated and characterized. The comparative NMR spectral pattern of **101**, and **103** with that of corresponding *endo*-products **94**, **97** and **98** confirmed their assigned structure. Comparative chemical shifts of *endo*- and *exo*-cyclic enolic-H are given in table 6. In general the olefinic-protons of the *endo*-enols (in dihydropyran derivatives **97**, **98**, **101**, **103**) were found to be more shielded compared to the olefinic-H of corresponding isomeric *exo*-enols (furan derivatives **96**, **99**, **100**, **102**). The single crystal X-ray structural analysis of the *exo*-products **99** and **102** proved their structures unambiguously (Figure 9).

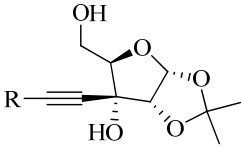
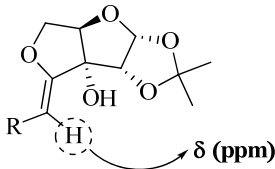
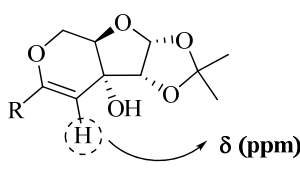
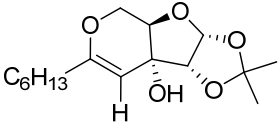
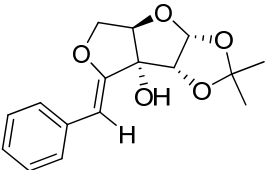
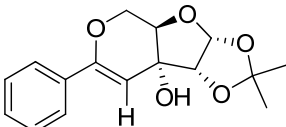
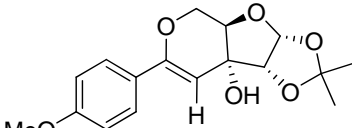
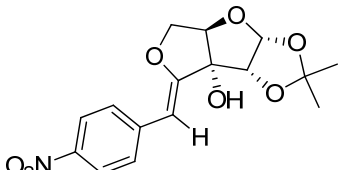
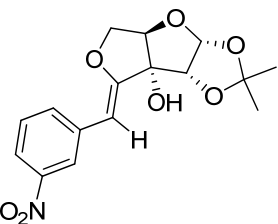
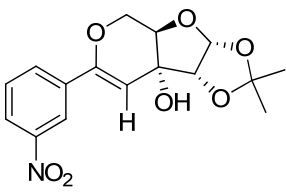
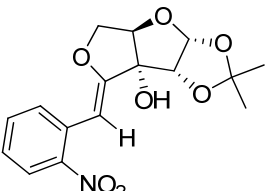
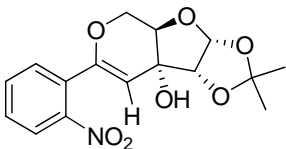
			
R = C ₆ H ₁₃			 4.40 94
R = Ph	 5.51 96		 5.19 97
R = 4-OMe Ph			 5.06 98
R = 4-NO ₂ Ph	 5.61 99		
R = 3-NO ₂ Ph	 5.59 100		 5.37 101
R = 2-NO ₂ Ph	 6.00 102		 4.97 103

Table 6: Characteristic ¹H chemical shifts of the *exo*- and *endo*- enol derivatives.

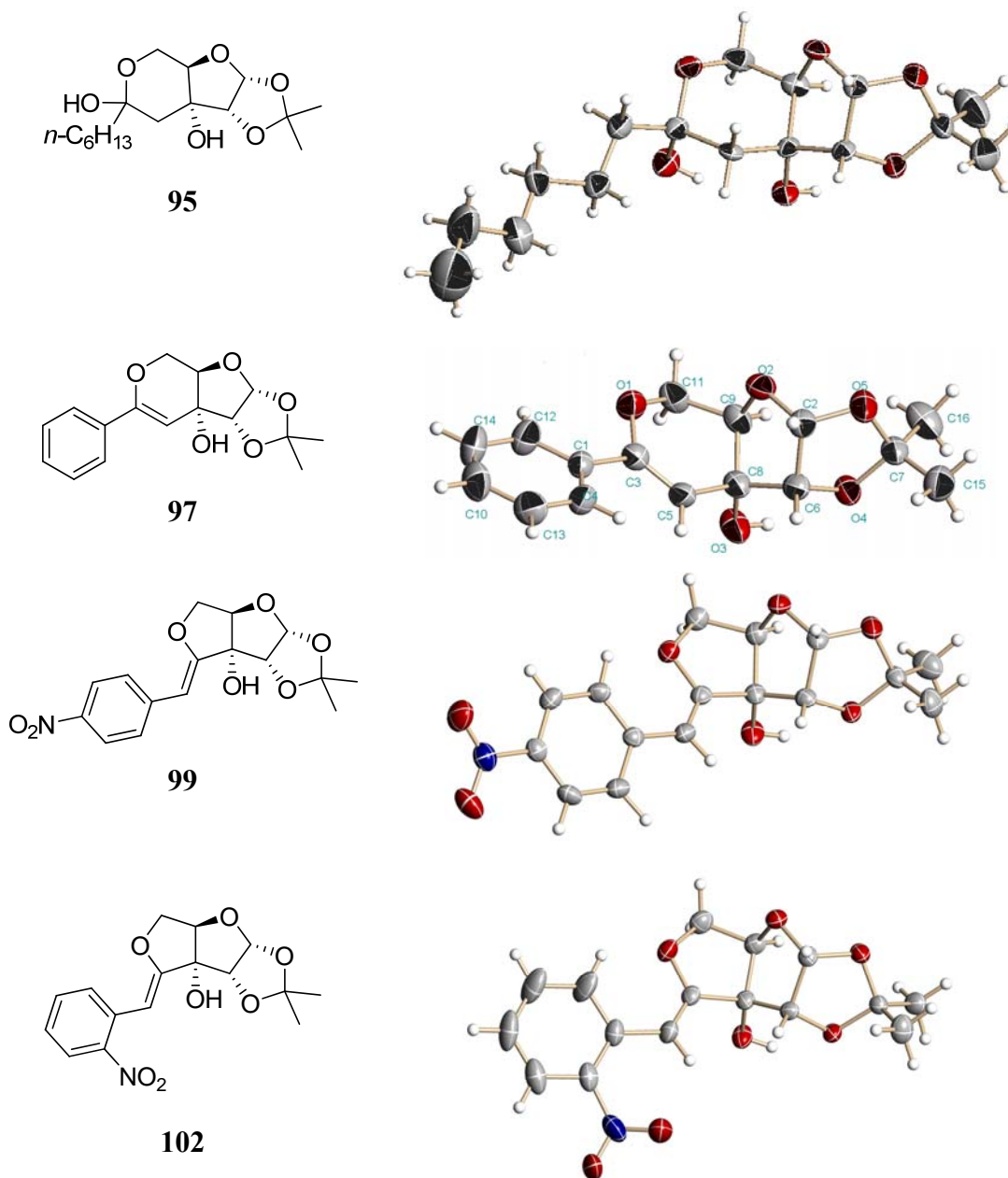
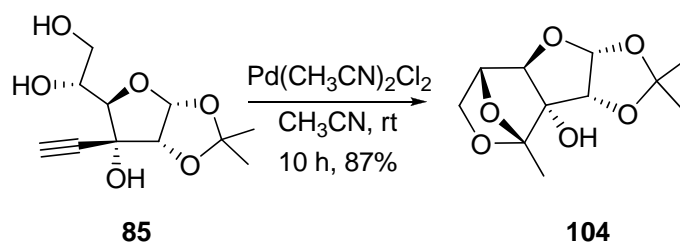


Figure 9: ORTEP structures of compounds **95**, **97**, **99** and **102**
(Crystal data of **95**, **97**, **99** and **102** are given in **Table 12** at the
end of the experimental section)

After successful execution of cycloisomerization reactions and interpretation of the structures of respective cyclized products, we proceeded with our second set of alkynols substrates i.e. 3-*C*-alkynyl-*allo*-furanose derivatives.

The cycloisomerization of monosubstituted alkynol **85** gave exclusively the known [2,2,1] bicyclic acetal **104**.^{40b} The structure of compound **104** was assigned from the appearance of a 3-proton singlet at 1.56 ppm and a singlet carbon at 114.0 ppm for [CH₃-C(OCH-)₂] (Scheme 29).



Scheme 29: Cycloisomerization reaction of **85**

In case of *n*-hexyl substituted alkynol **86**, we obtained the *endo*-product **105** exclusively. The appearance of one of the methylene unit protons separately as doublets at δ 1.60 and 1.93 with large geminal coupling constant (14.5 Hz) in the ¹H NMR spectrum of **105** clearly indicated that this methylene unit had no adjacent-H coupled and thus established the assigned [3,2,1] bicyclic ketal structure.⁴¹

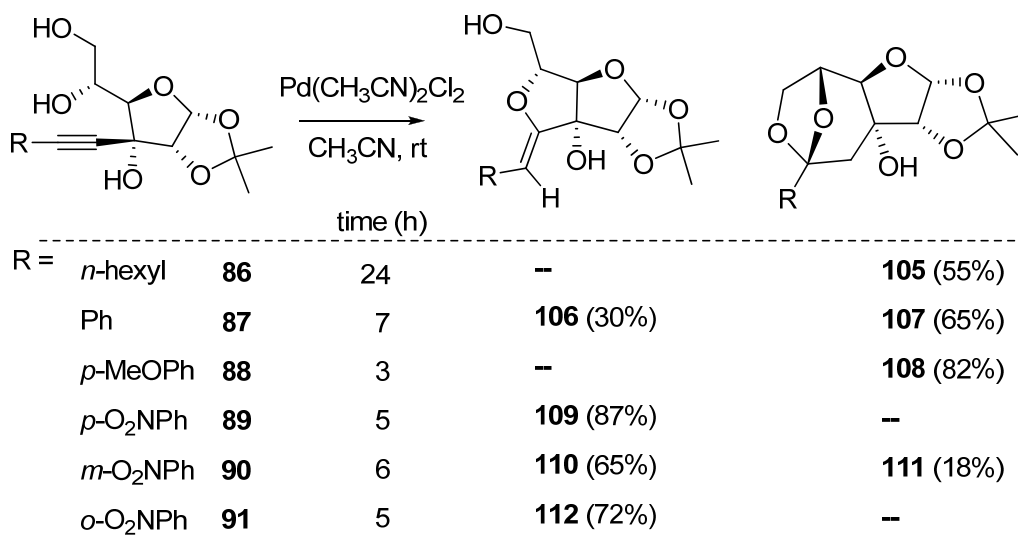


Table 7

Scheme 30: Cycloisomerization reactions of 3-C-alkynyl-*allo*-furanose derivatives **86–91**

With phenyl substituted alkynol **87**, two products **106** and **107** were isolated in 30% and 65%, respectively. Considering the similarity in the ^1H NMR spectral pattern of **107** with **105** (two doublets at δ 1.80 and 2.18 with $J_{gem} = 14.6$ Hz), we assigned a [3,2,1] bicyclic ketal structure, which was further confirmed by the single crystal structural analysis (Figure 10).

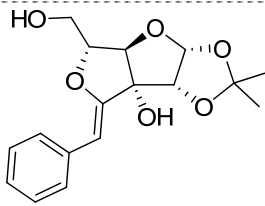
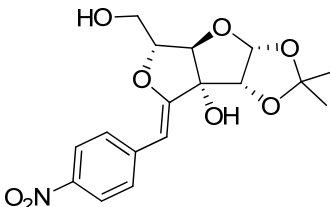
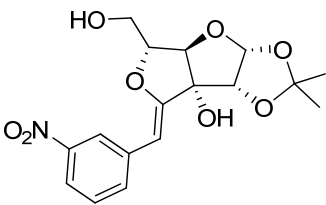
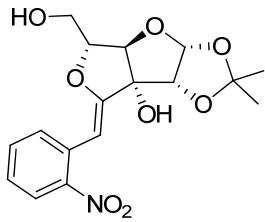
Product	^1H -shift of olefin proton (ppm)	^{13}C - shift of olefin carbons (ppm)
 <p>106</p>	5.50	102.7 (d) and 156.8 (s)
 <p>109</p>	5.52	100.4 (d) and 161.4 (s)
 <p>110</p>	5.53	100.1 (d) and 159.7 (s)
 <p>112</p>	6.00	96.1 (d) and 160.0 (s)

Table 8: Characteristic ^1H and ^{13}C chemical shifts of 5-*exo*-products.

The appearance of the enolic-H at 5.50 ppm in the ^1H NMR spectrum of minor product **106** clearly indicated its *exo*-cyclic nature. Compound **88** resulted in [3,2,1]

bicyclic ketal **108**. The cycloisomerization of *p*- and *o*-nitrophenyl substituted alkynols **89** and **91** gave exclusively *exo*-cyclic products **109** and **112** respectively; however, *m*-nitro derivative **90** gave small amounts of [3,2,1] bicyclic ketal **111** along with the *exo*-cyclic product **110**. These results are comparable with the results we obtained for the ribose derivatives **70–76** (Scheme 30)..

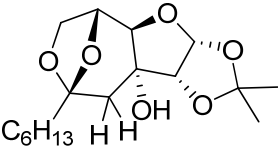
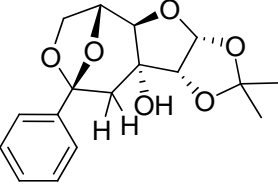
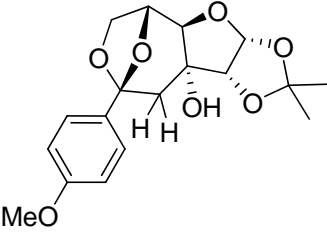
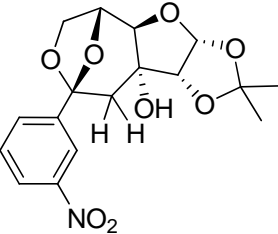
Products	¹ H-NMR (ppm)	¹³ C-NMR (ppm)
 <p>105</p>	1.60 (d, <i>J</i> = 14.5 Hz, 1H) 1.93 (d, <i>J</i> = 14.5 Hz, 1H)	40.9
 <p>107</p>	1.82 (d, <i>J</i> = 14.7 Hz, 1H) 2.20 (d, <i>J</i> = 14.7 Hz, 1H)	43.3
 <p>108</p>	1.89 (d, <i>J</i> = 14.7 Hz, 1H), 2.27 (d, <i>J</i> = 14.7 Hz, 1H)	43.0
 <p>111</p>	1.90 (d, <i>J</i> = 14.6 Hz, 1H), 2.28 (d, <i>J</i> = 14.6 Hz, 1H)	43.0

Table 9: Characteristic ¹H and ¹³C chemical shifts of bicyclic ketals.

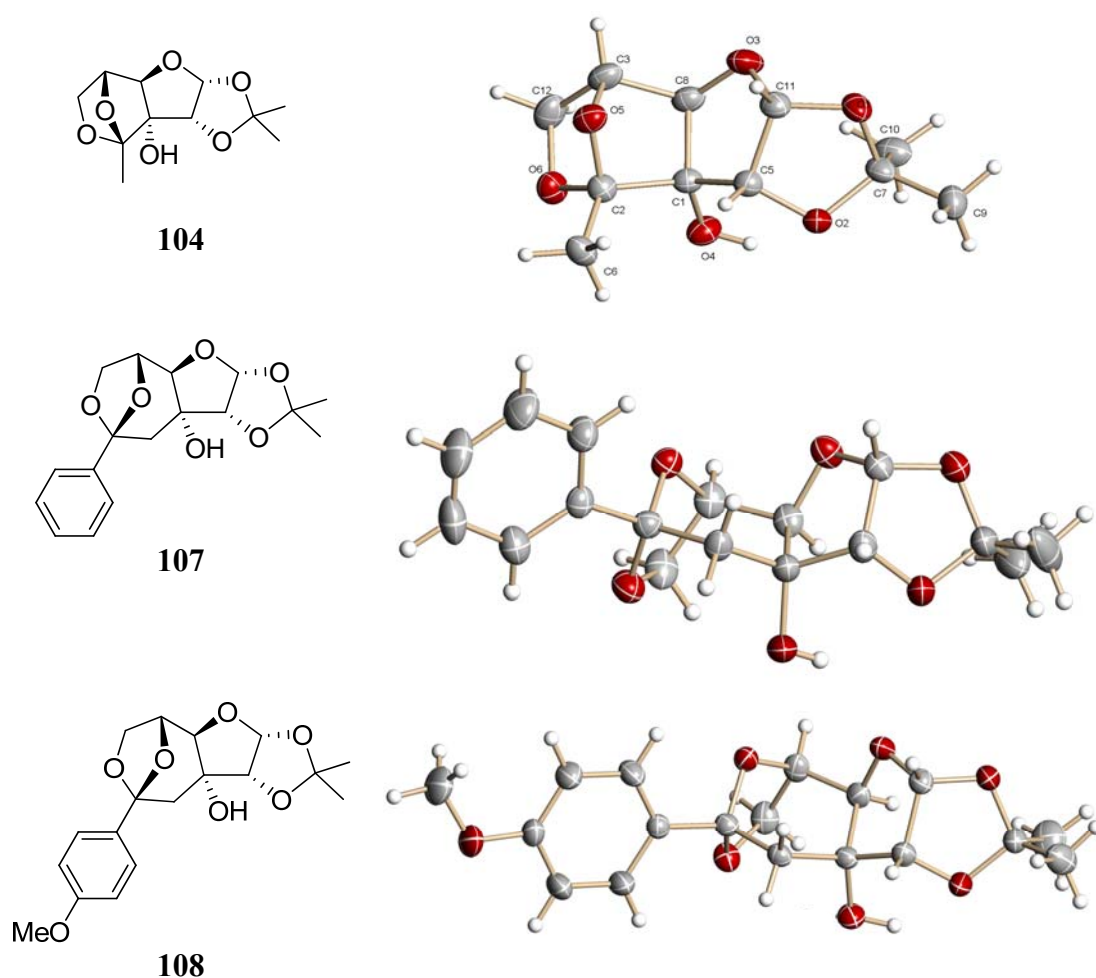


Figure 10: ORTEP structures of compounds **104**, **107** and **108**
(Crystal data of **104**, **107** and **108** are given in **Table 13** at the end of the experimental section)

After having executed a systematic investigation on the influence of electronic factors over the Pd-mediated cycloisomerization reactions, focussing on the competition between 5-*exo* vs 6-*endo* mode of ring closures, we next turned our attention towards the the trapping of the intermediate σ -Pd complex with an appropriate electrophile. The reason why we have intended to do this exercise is that it should also shed some light upon the proximity of the nucleophile and its influence upon the regiochemistry of the cyclization. Though it was clear from the cycloisomerization of nitroaryl substrates, that the proximity of the nucleophile is critical in deciding the ring closures, however we can't rule out the competition between the 6-*endo* vs 7-*exo* ring closure especially with

the substrates having the *n*-hexyl, phenyl and *p*-methoxy substituents [path b] (Figure 11).

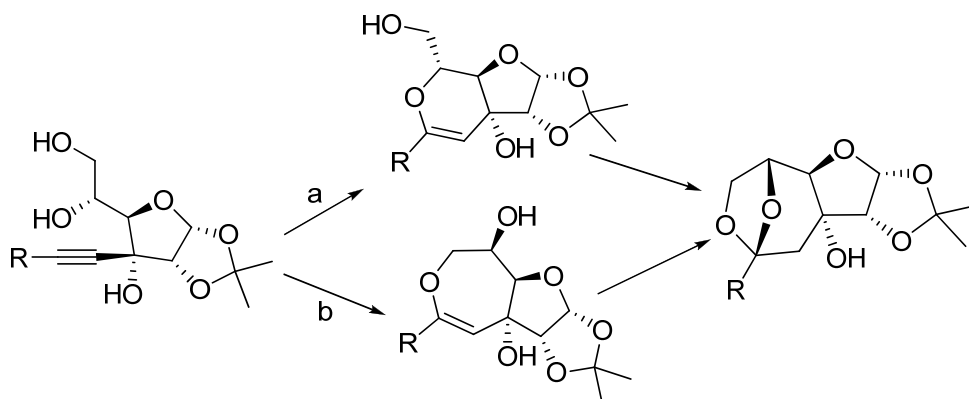
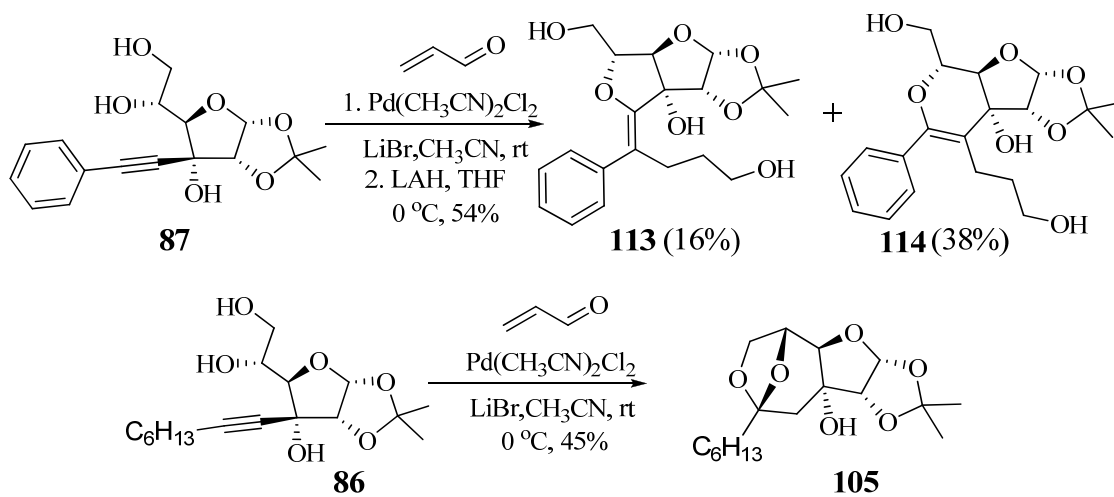
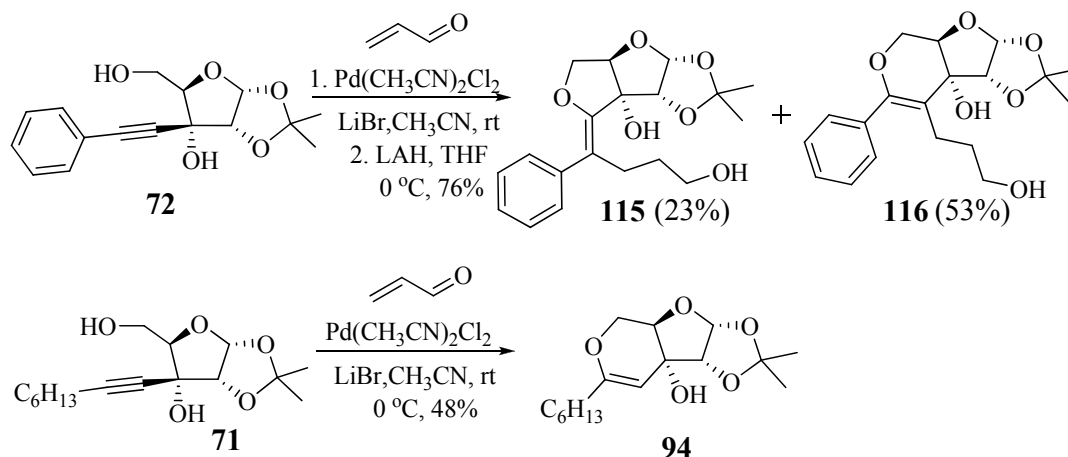


Figure 11

In order to address this we have conducted the cycloisomerization of compounds in presence of acrolein.⁴² To circumvent the problems associated with the stability of the resulting aldehyde derivatives, we chose to reduce them with LAH before isolation and characterization.

The cycloisomerization of **87** in presence acrolein followed by reduction by LAH gave two products **113** (16%) and **114** (38%) (Scheme 31). However, under similar conditions when the cycloisomerization of *n*-hexyl derivative **86** was carried out, it gave exclusively the bicyclic ketal **105** in moderate yields. The *exo*- product **113** showed resonances in the regions 2.58 to 2.63 ppm and 2.71 to 2.78 ppm for protons at α -carbon, whereas the *endo*- product **114** resonated in the upfield region (2.13 and 2.53 ppm).



Scheme 31: Cycloisomerization and conjugate addition of **87** and **86****Scheme 32:** Cycloisomerization and conjugate addition of **72** and **71**

	α	β	γ
 113	2.58-2.63	1.38-1.43	3.46-3.50
	2.71-2.78	1.57-1.63	3.54-3.62
 114	2.13	1.20-1.26	3.38
	2.53	1.41-1.46	3.47

Table 10: Characteristic ^1H shifts of **113** and **114**

Later we have employed the ribofuranose substrates for the similar type of cycloisomerization and trapping of the intermediate organopalladium species with the acrolein followed by LAH reduction. Once again the reaction with the phenyl derivative **72** provided two products **115** and **116**, whereas **71** under similar conditions gave only the dihydropyran derivative **94**. NMR, mass and elemental analysis, supported the structures of **115** and **116**. For **115**, protons at α -carbon resonated in more deshielded

region (2.63 and 2.75 ppm) compared to that of **116** (2.14 and 2.56 ppm) due to the presence of a perfect conjugation of oxygen lone pair into the aromatic ring. Remarkable difference in ^{13}C chemical shift of the olefinic carbon ($-\underline{\text{C}}=\text{C}-\text{O}-$), 113.9 ppm for **115** and 104.8 ppm for **116** can be attributed to their corresponding ring size.

The formation of a bicyclic ketal with **86** and a dihydropyran with **71** without any conjugate addition indicate that the proto-demetalation of intermediate organopalladium species surpassed the conjugate addition due to the unfavourable electronic influence from the enol-oxygen that was substantiated by the presence of +I group such as an alkyl group.

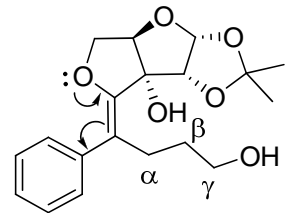
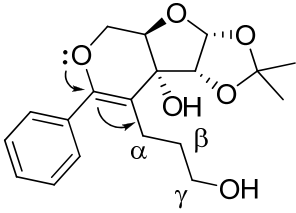
	α	β	γ
 <p>115</p>	2.63	1.36-1.41	3.47
	2.75	1.59-1.66	3.58
 <p>116</p>	2.14	1.42-1.48	3.37
	2.56	1.57-1.61	3.52

Table 11: Characteristic ^1H shifts of **115** and **116**

A mechanistic hypothesis based on the available data is depicted in Figure 12. The alkynol is first coordinated to Pd(II) and thus activated for intramolecular attack by the alcohol to yield *endo*- or *exo*- adducts. Electron-withdrawing substituents trigger the *exo*-approach of nucleophile (path a) while electron-releasing substituents make the terminal alkyne carbon relatively positive and vulnerable to nucleophilic attack (path b).

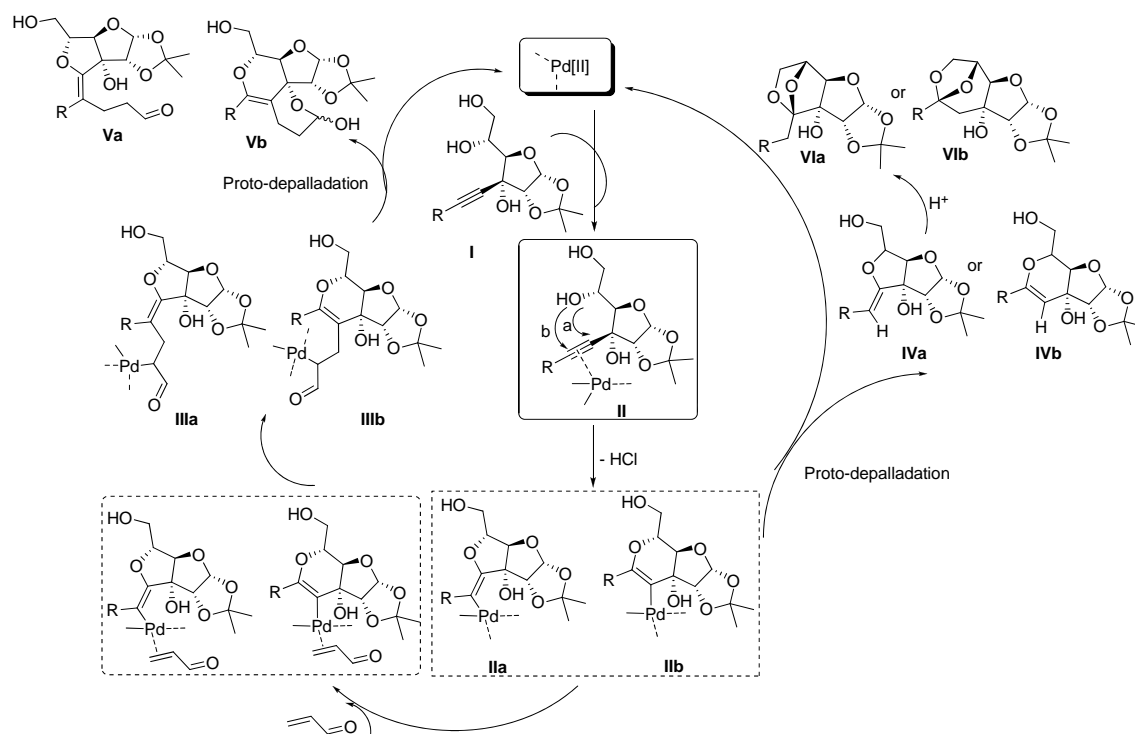


Figure 12

From the results obtained with alkynols **70–76** and **85–91**, it is evident that the regioselectivity of ring closure depends upon the nature of the substituents on alkyne. The formation of exclusive 5-*exo*-products from parent alkynols **70** and **85** was expected as in general terminal alkynes prefer *exo*-mode of approach of the incoming nucleophile in an intra- and intermolecular nucleophilic addition reactions.^{28, 43} Though, the formation of the *endo*-product from the alkynols **71** and **86** contrasts with the results obtained in the cyclization of **A** (Figure 13).⁴⁴ However, the relative inductive effects of the *n*-hexyl and the furanose rings explain this. In case of aryl substituted alkynols **72–76** and **87–91**, it is evident from the results obtained that a competitive balance between $-I$ effect of the furanose ring and $+M$ effect of the aryl substituents is operational. These studies reveal that the presence of a $+M$ substituent ($-OMe$ in our case) on the aromatic ring in general enforce a 6-*endo*-dig while $-M$ group ($-NO_2$ in our case) favored 5-*exo*-dig modes of cyclization. However, the directional influence of the $+M$ group is strong when it is positioned para to the alkyne.

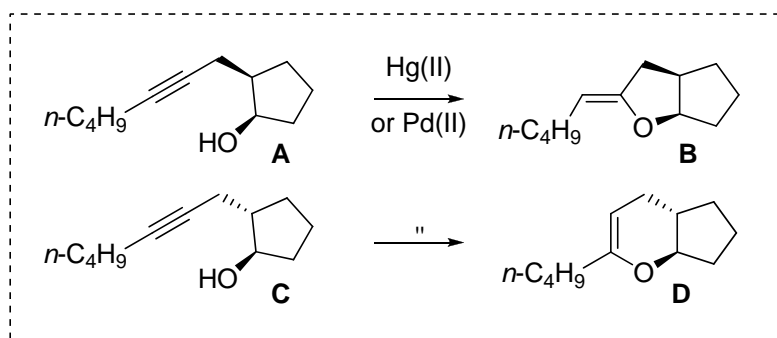


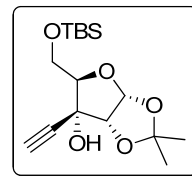
Figure 13

Thus, existence of an electronic control over the mode of cyclization in Pd-mediated cycloisomerization was perceived. The information is significant when compared to the base mediated cycloisomerization reactions. Base mediated cycloisomerization of sugar derived alkyneols was dealt in detail by Vasella and co-workers,⁴⁵ who reported that these cycloisomerizations in general prefer either 5- or 6-*exo-dig* mode of cyclization and in case if the *exo*-mode of ring closure is disfavoured due to ring strain, isomerisation to the allenes is preferred over an alkyneol cycloisomerization. Along similar lines, Hiroya *et al.*^{35a} concluded that the regioselectivity in base mediated cycloisomerization reactions is not influenced by the electronic nature of the functional group on the triple bond, but by steric congestion.

In summary, electronic control over the 5-*exo-dig* vs. 6-*endo-dig* modes of cyclizations in Pd-mediated cycloisomerization reaction were studied in detail. 3-*C*-alkynyl *ribo*- and *allo*-furanose derivatives with systematic variation of functional groups at one terminal of alkyne were employed to understand the competitive balance between inductive effect of furanose ring and mesomeric effect of aryl substituent. A preference for *endo-dig* cyclization over *exo-dig* was observed for electron releasing and insufficiently electron withdrawing aryl substituents. At the out set of these studies, a simple access to highly functionalized tetrahydrofuran fused bicyclic ketals and enol ether derivatives has been achieved using easily accessible sugar derived alkyneols and Pd-mediated coupling and cyclization reactions.

1.3 EXPERIMENTAL

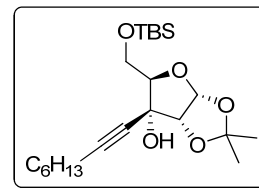
1,2-*O*-isopropylidene-5-*O*-(*tert*-butyldimethylsilyl)-3-*C*-ethynyl- α -*D*-ribo-furanose (**63**):



Mg (1.12 g, 46.3 mmol) was flame dried in a two neck R.B. flask fitted with a reflux condenser and cooled to room temperature in argon atmosphere. Dry THF (30 mL) was introduced followed by a few crystals of Iodine. Half of the total volume of *n*-BuCl (4.84 mL, 46.3 mmol) was added and the contents were refluxed till the generation of Grignard. Heating was removed and rest of *n*-BuCl was added. Stirring continued at room temperature till all the magnesium was consumed. Then the reaction mixture was cooled to 0 °C and acetylene gas was bubbled into it for 15 min. Ketone **62** (3.5 g, 11.57 mmol) in THF (20 mL) was added at 0 °C and stirred for 30 min. The reaction was quenched with saturated NH₄Cl solution, diluted with water and extracted with ethyl acetate. The combined organic layer was dried over Na₂SO₄, concentrated and purified on silica gel (10% ethyl acetate in light petroleum) to give **63** (3.2 g, 84%) as a colorless oil.

Mol. Formula	: C ₁₆ H ₂₈ O ₅ Si
Mol. Weight	: 328.48
[α]_D²⁵	: +10.5 (<i>c</i> 1, CHCl ₃)
IR (CHCl₃, cm⁻¹)	: 3306, 3019, 2931, 2401, 1514, 1459, 1376, 1163, 1092, 1012.
¹H NMR (200 MHz, CDCl ₃)	: δ 0.08 (s, 3H), 0.09 (s, 3H), 0.89 (s, 9H), 1.36 (s, 3H), 1.58 (s, 3H), 2.54 (s, 1H), 3.05 (br s, 1H), 3.91–3.98 (m, 3H), 4.55 (d, <i>J</i> = 3.7 Hz, 1H), 5.82 (d, <i>J</i> = 3.7 Hz, 1H).
¹³C NMR (50 MHz, CDCl ₃)	: δ -5.6 (q), -5.4 (q), 18.1 (s), 25.8 (q, 3C), 26.5 (q), 26.6 (q), 62.7 (t), 75.1 (s), 76.0 (d), 80.4 (s), 80.9 (d), 83.7 (d), 104.0 (d), 113.2 (s).
Elemental Analysis	: Calcd: C, 58.50; H, 8.59. Found: C, 58.32; H, 8.41.
ESI-MS <i>m/z</i>	: 351.14 [M+Na] ⁺

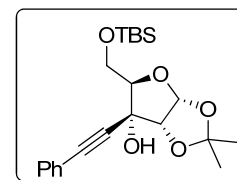
1,2-*O*-isopropylidene-5-*O*-(*tert*-butyldimethylsilyl)-3-*C*-(oct-1-ynyl)- α -D-ribo-furanose (64**):**



To a solution of 1-octyne (273 mg, 2.5 mmol) in THF (10 mL) at $-78\text{ }^{\circ}\text{C}$, *n*-BuLi (1.25 mL, 2 mmol, 1.6 M in hexane) was added drop wise. After 1 h, a solution of compound **62** (500 mg, 1.65 mmol) in THF (8 mL) was added and stirring was continued for 2.5 h at $-78\text{ }^{\circ}\text{C}$. The reaction mixture was quenched with sat. NH_4Cl solution and the aqueous phase was extracted with ethyl acetate. The combined organic layer was dried over Na_2SO_4 , concentrated and purified by chromatography (10% ethyl acetate in light petroleum) to give **64** (600 mg, 88%) as a syrup.

Mol. Formula	: $\text{C}_{22}\text{H}_{40}\text{O}_5\text{Si}$
Mol. Weight	: 412.64
$[\alpha]_{\text{D}}^{25}$: +9.7 (<i>c</i> 0.9, CHCl_3)
IR (CHCl_3, cm^{-1})	: 3537, 3019, 2930, 2857, 2242, 1463, 1375, 1361, 1256, 1217, 1164, 1083, 1007, 873, 838, 667.
^1H NMR (200 MHz, CDCl_3)	: δ 0.07 (s, 3H), 0.08 (s, 3H), 0.87 (t, $J = 6.9$ Hz, 3H), 0.89 (s, 9H), 1.24–1.32 (m, 5H), 1.35 (s, 3H), 1.43–1.53 (m, 3H), 1.57 (s, 3H), 2.21 (t, $J = 7.0$ Hz, 2H), 2.91 (s, 1H), 3.91–3.94 (m, 3H), 4.47 (d, $J = 3.6$ Hz, 1H), 5.79 (d, $J = 3.6$ Hz, 1H).
^{13}C NMR (50 MHz, CDCl_3)	: δ -5.7 (q), -5.5 (q), 13.7 (q), 18.0 (s), 18.4 (t), 22.2 (t), 25.6 (q, 3C), 26.4 (q), 26.5 (q), 28.1 (t), 28.2 (t), 31.0 (t), 63.0 (t), 75.0 (s), 76.8 (s), 81.8 (d), 84.1 (d), 88.3 (s), 103.9 (d), 112.7 (s).
Elemental Analysis	: Calcd: C, 64.04; H, 9.77. Found: C, 64.15; H, 10.01.
ESI-MS m/z	: 435.54 $[\text{M}+\text{Na}]^+$

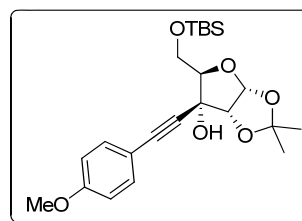
1,2-*O*-isopropylidene-5-*O*-(*tert*-butyldimethylsilyl)-3-*C*-phenyl ethynyl- α -D-ribo-furanose (65**):**



To a solution of phenylacetylene (400 mg, 3.9 mmol) in THF (20 mL) at $-78\text{ }^{\circ}\text{C}$, *n*-BuLi (2 mL, 3.13 mmol, 1.6 M in hexane) was added drop wise. After 1 h, a solution of ketone **62** (790 mg, 2.6 mmol) in THF (10 mL) was added and stirred for 2 h at $-78\text{ }^{\circ}\text{C}$. The reaction was quenched with sat. NH_4Cl solution, diluted with water and extracted with ethyl acetate. The combined organic layer was dried over Na_2SO_4 and concentrated. The residue was purified on silica gel (10% ethyl acetate in light petroleum) to afford **65** (856 mg, 81%) as a syrup.

Mol. Formula	: $\text{C}_{22}\text{H}_{32}\text{O}_5\text{Si}$
Mol. Weight	: 404.57
$[\alpha]_{\text{D}}^{25}$: +2.5 (<i>c</i> 1.5, CHCl_3)
IR (CHCl_3 , cm^{-1})	: 3459, 2929, 2856, 1599, 1492, 1463, 1383, 1254, 1099, 1035, 1001, 880, 836, 690.
^1H NMR (200 MHz, CDCl_3)	: δ 0.09 (s, 3H), 0.10 (s, 3H), 0.90 (s, 9H), 1.38 (s, 3H), 1.62 (s, 3H), 3.14 (s, 1H), 3.99–4.12 (m, 3H), 4.65 (d, <i>J</i> = 3.6 Hz, 1H), 5.89 (d, <i>J</i> = 3.6 Hz, 1H), 7.29–7.35 (m, 3H), 7.40–7.45 (m, 2H).
^{13}C NMR (50 MHz, CDCl_3)	: δ -5.5 (q), -5.3 (q), 18.2 (s), 25.9 (q, 3C), 26.7 (q, 2C), 63.1 (t), 76.0 (s), 81.7 (d), 84.2 (d), 85.7 (s), 87.8 (s), 104.3 (d), 113.4 (s), 121.9 (s), 128.2 (d, 2C), 128.8 (d), 131.8 (d, 2C).
Elemental Analysis	: Calcd: C, 65.31; H, 7.97. Found: C, 65.59; H, 7.80.
ESI-MS <i>m/z</i>	: 427.44 $[\text{M}+\text{Na}]^+$

1,2-*O*-isopropylidene-5-*O*-(*tert*-butyldimethylsilyl)-3-*C*-(4-methoxy-phenyl ethynyl)- α -*D*-ribo-furanose (66**):**

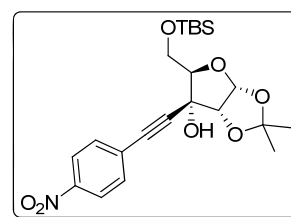


4-Iodoanisole (267 mg, 1.14 mmol) was taken in a mixture of Et_3N and DMF (2:1, 5 mL). To this CuI (14 mg, 0.08 mmol), PPh_3 (20 mg, 0.08 mmol) and $\text{Pd}(\text{PPh}_3)_2\text{Cl}_2$ (53 mg, 0.08 mmol) were added followed by alkyne (250 mg, 0.76 mmol). Argon was

flushed several times and stirred for 2.5 h. The reaction mixture was diluted with EtOAc, the organic layer was washed with water, brine, dried over Na₂SO₄ and concentrated. Purification of the residue by column chromatography (18% EtOAc in light petroleum) afforded **66** (265 mg, 80%) as a white spongy mass.

Mol. Formula	: C ₂₃ H ₃₄ O ₆ Si
Mol. Weight	: 434.60
[α]_D²⁵	: +5.1 (<i>c</i> 1, CHCl ₃)
IR (CHCl₃, cm⁻¹)	: 3394, 3019, 1607, 1510, 1124, 757, 668.
¹H NMR (200 MHz, CDCl ₃)	: δ 0.09 (s, 6H), 0.90 (s, 9H), 1.37 (s, 3H), 1.61 (s, 3H), 3.08 (s, 1H), 3.80 (s, 3H), 3.96–4.1 (m, 3H), 4.62 (d, <i>J</i> = 3.7 Hz, 1H), 5.87 (d, <i>J</i> = 3.7 Hz, 1H), 6.81 (d, <i>J</i> = 8.9 Hz, 2H), 7.34 (d, <i>J</i> = 8.9 Hz, 2H).
¹³C NMR (50 MHz, CDCl ₃)	: δ -5.4 (q), -5.2 (q), 18.4 (s), 25.9 (q, 3C), 26.8 (q), 26.9 (q), 55.2 (q), 63.1 (t), 76.1 (s), 81.4 (d), 84.1 (s), 84.2 (d), 87.9 (s), 104.4 (d), 113.4 (s), 113.9 (s), 113.9 (d, 2C), 133.3 (d, 2C), 160.0 (s).
Elemental Analysis	: Calcd: C, 63.56; H 7.89. Found: C, 63.25; H, 8.01.
ESI-MS <i>m/z</i>	: 457.12 [M+Na] ⁺

1,2-*O*-isopropylidene-5-*O*-(*tert*-butyldimethylsilyl)-3-*C*-(4-nitrophenyl ethynyl)- α -D-ribo-furanose (67**):**

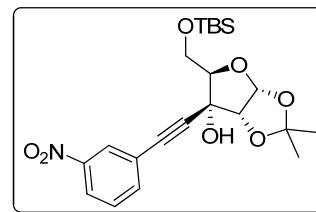


To a solution of 4-nitroiodobenzene (341 mg, 1.37 mmol) in 2:1 mixture of Et₃N:DMF (5 mL) were added CuI (17 mg, 0.09 mmol), PPh₃ (24 mg, 0.09 mmol) and Pd(PPh₃)₂Cl₂ (64 mg, 0.09 mmol) followed by alkyne **63** (300 mg, 0.913 mmol). The reaction mixture was flushed with argon and stirring was continued for 3 h at 25 °C. Following usual workup procedure and purification by column chromatography (20% EtOAc in light petroleum) gave **67** (321 mg, 78%) as a yellow oil.

Mol. Formula	: C ₂₂ H ₃₁ NO ₇ Si
---------------------	--

Mol. Weight	: 449.57
$[\alpha]_D^{25}$: +1.3 (<i>c</i> 0.8, CHCl ₃)
IR (CHCl₃, cm⁻¹)	: 3523, 3020, 2931, 2400, 1595, 1523, 1471, 1346, 1096, 838.
¹H NMR (200 MHz, CDCl₃)	: δ 0.09 (s, 6H), 0.90 (s, 9H), 1.39 (s, 3H), 1.62 (s, 3H), 3.21 (s, 1H), 3.97–4.12 (m, 1H), 4.66 (d, <i>J</i> = 3.7 Hz, 2H), 5.89 (d, <i>J</i> = 3.7 Hz, 2H), 7.58 (d, <i>J</i> = 9.0 Hz, 2H), 8.20 (d, <i>J</i> = 9.0 Hz, 2H).
¹³C NMR (50 MHz, CDCl₃)	: δ -5.5 (q), -5.3 (q), 18.3 (s), 25.9 (q, 3C), 26.6 (q), 26.8 (q), 62.9 (t), 76.2 (s), 81.2 (d), 83.8 (d), 85.7 (s), 91.0 (s), 104.3 (d), 113.7 (s), 123.6 (d, 2C), 128.5 (s), 132.5 (d, 2C), 147.5 (s).
Elemental Analysis	: Calcd: C, 58.78; H 6.95; N, 3.12. Found: C, 58.99; H, 6.77; N, 3.14.
ESI-MS <i>m/z</i>	: 472.28 [M+Na] ⁺

1,2-*O*-isopropylidene-5-*O*-(*tert*-butyldimethylsilyl)-3-*C*-(3-nitrophenyl ethynyl)- α -D-ribo-furanose (68**):**

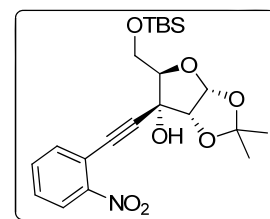


Following a similar procedure as described above, the coupling of 3-nitroiodobenzene (295 mg, 1.19 mmol) and alkyne **23** (260 mg, 0.79 mmol) using CuI (15 mg, 0.079 mmol), PPh₃ (21 mg, 0.079 mmol) and Pd (PPh₃)₂Cl₂ (55 mg, 0.079 mmol) afforded **68** (270 mg, 76%) as a colorless oil.

Mol. Formula	: C ₂₂ H ₃₁ NO ₇ Si
Mol. Weight	: 449.57
$[\alpha]_D^{25}$: +2.03 (<i>c</i> 1, CHCl ₃)
IR (CHCl₃, cm⁻¹)	: 3450, 2931, 1533, 1472, 1352, 1258, 1102, 838.
¹H NMR (200 MHz, CDCl₃)	: δ 0.10 (s, 6H), 0.9 (s, 9H), 1.39 (s, 3H), 1.62 (s, 3H), 3.2 (s, 1H), 3.98–4.12 (m, 3H), 4.66 (d, <i>J</i> = 3.7 Hz, 1H), 5.89 (d, <i>J</i> = 3.7 Hz, 1H), 7.51 (t, <i>J</i> = 8.0 Hz, 1H), 7.72 (dt, <i>J</i> =

- 1.4, 7.7 Hz, 1H), 8.2 (ddd, $J = 1.1, 2.3, 8.2$ Hz, 1H), 8.26–8.28 (m, 1H).
- ^{13}C NMR** : δ -5.5 (q), -5.3 (q), 18.3 (s), 25.8 (q, 3C), 26.6 (q), 26.7 (75 MHz, CDCl_3) (q), 62.9 (t), 76.1 (s), 81.2 (d), 83.8 (d), 85.2 (s), 88.6 (s), 104.3 (d), 113.6 (s), 123.6 (s), 123.6 (d), 126.6 (d), 129.4 (d), 137.3 (d), 148.1 (s).
- Elemental Analysis** : Calcd: C, 58.78; H 6.95; N, 3.12.
Found: C, 58.83; H, 6.75; N, 3.10.
- ESI-MS m/z** : 472.17 $[\text{M}+\text{Na}]^+$

1,2-*O*-isopropylidene-5-*O*-(*tert*-butyldimethylsilyl)-3-*C*-(2-nitrophenyl ethynyl)- α -*D*-ribo-furanose (69**):**



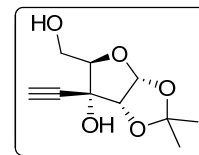
Coupling of 2-nitro-iodobenzene (568 mg, 2.28 mmol) and alkyne **23** (500 mg, 1.52 mmol) was carried out by using CuI (29 mg, 0.152 mmol), PPh_3 (40 mg, 0.152 mmol) and $\text{Pd}(\text{PPh}_3)_2\text{Cl}_2$ (107 mg, 0.152 mmol) to procure **69** (555 mg, 81%) after column chromatography (2:8, EtOAc / light petroleum) as a pale yellow oil.

- Mol. Formula** : $\text{C}_{22}\text{H}_{31}\text{NO}_7\text{Si}$
- Mol. Weight** : 449.57
- $[\alpha]_D^{25}$** : +1.2 (c 1, CHCl_3)
- IR (CHCl_3 , cm^{-1})** : 3526, 3020, 2956, 2410, 1530, 1471, 1346, 1216, 1097.
- ^1H NMR** : δ 0.08 (s, 6H), 0.89 (s, 9H), 1.38 (s, 3H), 1.60 (s, 3H), 3.2 (200 MHz, CDCl_3) (s, 1H), 3.99–4.09 (m, 3H), 4.68 (d, $J = 3.7$ Hz, 1H), 5.93 (d, $J = 3.7$ Hz, 1H), 7.44–7.63 (m, 3H), 8.04–8.08 (m, 1H).
- ^{13}C NMR** : δ -5.6 (q), -5.4 (q), 18.2 (s), 25.8 (q, 3C), 26.6 (q), 26.7 (75 MHz, CDCl_3) (q), 62.9 (t), 76.2 (s), 81.4 (d), 82.9 (s), 83.8 (d), 93.6 (s), 104.3 (d), 113.4 (s), 117.2 (s), 124.7 (d), 129.3 (d), 132.8 (d), 134.7 (d), 149.7 (s).
- Elemental Analysis** : Calcd: C, 58.78; H, 6.95; N, 3.12.

Found: C, 58.60; H, 6.99; N, 3.14.

ESI-MS m/z : 472.06 [M+Na]⁺

1,2-*O*-isopropylidene-3-*C*-ethynyl- α -D-ribo-furanose (70):



A solution of **63** (140 mg, 0.42 mmol) in THF (2 mL) was treated with TBAF (0.5 mL, 0.5 mmol, 1 M in THF) at 0 °C and stirred for 1 h. The reaction mixture was quenched with saturated NH₄Cl solution and partitioned between ethyl acetate–water. The aqueous layer was extracted with ethyl acetate and the combined organic layers were dried over Na₂SO₄ and concentrated. The residue was purified on silica gel by eluting with 50% ethyl acetate in light petroleum to obtain **70** (75 mg, 82%) as a colorless sticky mass.

Mol. Formula : C₁₀H₁₄O₅

Mol. Weight : 214.22

[α]_D²⁵ : +36.7 (*c* 1, CHCl₃)

IR (CHCl₃, cm⁻¹) : 3305, 3019, 2401, 1519, 1377, 1163, 1019.

¹H NMR (200 MHz, CDCl₃) : δ 1.35 (s, 3H), 1.57 (s, 3H), 2.43 (br s, 1H), 2.59 (s, 1H), 3.29 (br s, 1H), 3.89–3.98 (m, 3H), 4.51 (d, *J* = 3.7 Hz, 1H), 5.84 (d, *J* = 3.7 Hz, 1H).

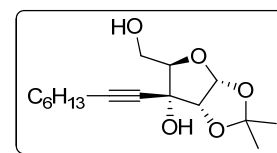
¹³C NMR (50 MHz, CDCl₃) : δ 26.5 (q), 26.7 (q), 61.8 (t), 74.7 (s), 76.8 (d), 79.9 (s), 81.5 (d), 83.8 (d), 103.9 (d), 113.5 (s).

Elemental Analysis : Calcd: C, 56.07; H, 6.59.

Found: C, 56.19; H, 6.47.

ESI-MS m/z : 237.09 [M+Na]⁺

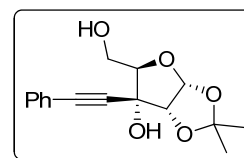
1,2-*O*-isopropylidene-3-*C*-(oct-1-ynyl)- α -D-ribo-furanose (71):



A solution of **64** (1 g, 2.42 mmol) in THF (25 mL) and TBAF (2.9 mL, 2.9 mmol, 1 M solution in THF) was stirred at 0 °C for 1 h. Usual workup followed by purification over silica gel (40% ethyl acetate in light petroleum) gave **71** (600 mg, 83%) as a syrup.

Mol. Formula	: C ₁₆ H ₂₆ O ₅
Mol. Weight	: 298.37
[α]_D²⁵	: +41.0 (<i>c</i> 0.5, CHCl ₃)
IR (CHCl₃, cm⁻¹)	: 3460, 3019, 2934, 2860, 2240, 1456, 1377, 1163, 1078, 1008, 873, 668.
¹H NMR (200 MHz, CDCl ₃)	: δ 0.87 (t, <i>J</i> = 6.9 Hz, 3H), 1.20–1.31 (m, 6H), 1.34 (s, 3H), 1.43–1.50 (m, 2H), 1.56 (s, 3H), 2.20 (t, <i>J</i> = 7.0 Hz, 2H), 3.0 (br s, 1H), 3.82–3.95 (m, 3H), 4.44 (d, <i>J</i> = 3.7 Hz, 1H), 5.81 (d, <i>J</i> = 3.7 Hz, 1H).
¹³C NMR (50 MHz, CDCl ₃)	: δ 13.7 (q), 18.3 (t), 22.2 (t), 26.3 (q), 26.4 (q), 28.0 (t), 28.2 (t), 30.9 (t), 61.7 (t), 74.5 (s), 76.0 (s), 81.6 (d), 84.0 (d), 88.9 (s), 103.6 (d), 112.9 (s).
Elemental Analysis	: Calcd: C, 64.41; H, 8.78. Found: C, 64.55; H, 8.61.
ESI-MS <i>m/z</i>	: 321.15 [M+Na] ⁺

1,2-*O*-isopropylidene-3-*C*-phenethynyl- α -*D*-ribo-furanose (72):

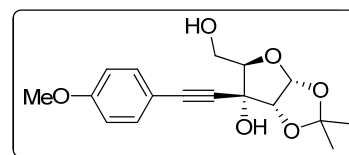


A solution of **65** (1.125 g, 2.8 mmol) in THF (25 mL) was treated with TBAF (3.3 mL, 3.3 mmol, 1 M in THF) at 0 °C and stirred for 1 h. Usual workup and purification by column chromatography (50% ethyl acetate in light petroleum) gave **72** (646 mg, 80%) as a colorless solid.

M.P.	: 112 °C
Mol. Formula	: C ₁₆ H ₁₈ O ₅
Mol. Weight	: 290.31
[α]_D²⁵	: +50.5 (<i>c</i> 1, CHCl ₃)
IR (CHCl₃, cm⁻¹)	: 3436, 2924, 2852, 1612, 1489, 1384, 1083, 1061, 1019, 879, 691.
¹H NMR (200 MHz, CDCl ₃)	: δ 1.40 (s, 3H), 1.62 (s, 3H), 2.98 (s, 1H), 3.93–4.15 (complex AB, 3H), 4.63 (d, <i>J</i> = 3.7 Hz, 1H), 5.93 (d, <i>J</i> =

	3.7 Hz, 1H), 7.30–7.36 (m, 3H), 7.42–7.47 (m, 2H).
¹³ C NMR (50 MHz, CDCl ₃)	: δ 26.5 (q), 26.7 (q), 62.0 (t), 75.2 (s), 82.0 (d), 84.0 (d), 84.8 (s), 88.2 (s), 103.9 (d), 113.3 (s), 121.4 (s), 128.2 (d, 2C), 128.9 (d), 131.8 (d, 2C).
Elemental Analysis	: Calcd: C, 66.19; H, 6.25. Found: C, 65.96; H, 6.35.
ESI-MS <i>m/z</i>	: 313.10 [M+Na] ⁺

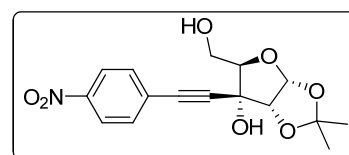
1,2-*O*-isopropylidene-3-*C*-(4-methoxyphenyl-ethynyl)- α -D-ribo-furanose (73):



A solution of **66** (200 mg, 0.46 mmol) and 1 M TBAF in THF (0.6 mL, 0.6 mmol) in THF (10 mL) was stirred at 0 °C for 4 h. Usual workup and purification of the crude product by column chromatography (1:1, EtOAc/ light petroleum) gave **73** (125 mg, 85%) as a colorless oil.

Mol. Formula	: C ₁₇ H ₂₀ O ₆
Mol. Weight	: 320.34
[α]_D²⁵	: +36.1 (<i>c</i> 1.2, CHCl ₃)
IR (CHCl₃, cm⁻¹)	: 3397, 3020, 2395, 1211, 1421, 1037, 926.
¹H NMR (200 MHz, CDCl ₃)	: δ 1.39 (s, 3H), 1.6 (s, 3H), 3.0 (s, 1H), 3.8 (s, 3H), 4.04 (br s, 3H), 4.62 (d, <i>J</i> = 3.8 Hz, 1H), 5.93 (d, <i>J</i> = 3.8 Hz, 1H), 6.83 (d, <i>J</i> = 8.9 Hz, 2H), 7.37 (d, <i>J</i> = 8.9 Hz, 2H).
¹³C NMR (50 MHz, CDCl ₃)	: δ 26.6 (q), 26.8 (q), 55.3 (q), 62.3 (t), 75.3 (s), 82.2 (d), 83.12 (s), 84.1 (d), 88.7 (s), 104.2 (d), 113.4 (s), 113.5 (s), 114.0 (d, 2C), 133.5 (d, 2C), 160.2 (s).
Elemental Analysis	: Calcd: C, 63.74; H, 6.29. Found: C, 63.51; H, 6.47.
ESI-MS <i>m/z</i>	: 343.18 [M+Na] ⁺

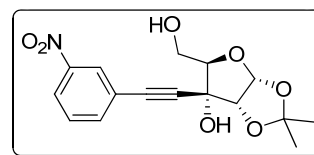
1,2-*O*-isopropylidene-3-*C*-(4-nitrophenylethynyl)- α -D-ribo-furanose (74):



Following the procedure as described, treatment of **67** (250 mg, 0.55 mmol) with 1 M TBAF in THF (0.66 mL, 0.66 mmol) followed by usual workup and purification by column chromatography (1:1, EtOAc/ light petroleum) gave **74** (158 mg, 85%) as a colorless oil.

Mol. Formula	: C ₁₆ H ₁₇ NO ₇
Mol. Weight	: 335.31
[α]_D²⁵	: +51.6 (c 1, CHCl ₃)
IR (CHCl₃, cm⁻¹)	: 3423, 2917, 1665, 1591, 1377, 1342, 858.
¹H NMR (200 MHz, CDCl ₃)	: δ 1.4 (s, 3H), 1.61 (s, 3H), 3.2 (s, 1H), 4.01–4.11 (m, 3H), 4.64 (d, <i>J</i> = 3.7 Hz, 1H), 5.95 (d, <i>J</i> = 3.7 Hz, 1H), 7.61 (d, <i>J</i> = 8.8 Hz, 2H), 8.18 (d, <i>J</i> = 8.8 Hz, 2H).
¹³C NMR (50 MHz, CDCl ₃)	: δ 26.4 (q), 26.8 (q), 62.1 (t), 75.4 (s), 82.2 (d), 83.7 (d), 86.3 (s), 89.8 (s), 104.1 (d), 113.8 (s), 123.6 (d, 2C), 128.2 (s), 132.7 (d, 2C), 147.7 (s).
Elemental Analysis	: Calcd: C, 57.31; H, 5.11; N, 4.18. Found: C, 57.28; H, 5.17; N, 4.23.
ESI-MS <i>m/z</i>	: 358.10 [M+Na] ⁺

1,2-*O*-isopropylidene-3-*C*-(3-nitrophenylethynyl)- α -D-ribofuranose (75**):**



A solution of **68** (210 mg, 0.47 mmol) and 1 M TBAF (0.56 mL, 0.56 mmol) in THF (10 mL) was stirred for 2 h at 0 °C. After completion, the reaction mixture was worked up as described above and the crude product was purified by column chromatography (45% EtOAc in light petroleum) to obtain **75** (126 mg, 80%) as a colorless oil.

Mol. Formula	: C ₁₆ H ₁₇ NO ₇
Mol. Weight	: 335.31
[α]_D²⁵	: -1.7 (c 1.5, CHCl ₃)
IR (CHCl₃, cm⁻¹)	: 466, 3078, 2923, 1531, 1459, 1354, 1050, 884.
¹H NMR	: δ 1.39 (s, 3H), 1.61 (s, 3H), 2.9 (br s, 2H), 3.98–4.09 (m,

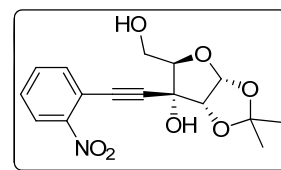
(200 MHz, CDCl₃) 3H), 4.63 (d, $J = 3.7$ Hz, 1H), 5.93 (d, $J = 3.7$ Hz, 1H), 7.51 (t, $J = 8.0$ Hz, 1H), 7.74 (dt, $J = 1.4, 7.8$ Hz, 1H), 8.19 (ddd, $J = 1.2, 2.2, 8.3$ Hz, 1H), 8.28 (t, $J = 1.9$ Hz, 1H).

¹³C NMR : δ 25.7 (q), 25.9 (q), 61.2 (t), 74.7 (s), 81.4 (d), 83.47 (d), (50 MHz, CDCl₃) 84.2 (s), 88.1 (s), 95.3 (s), 103.4 (d), 112.4 (s), 122.8 (d), 125.7 (d), 129.0 (d), 136.8 (d), 147.4 (s).

Elemental Analysis : Calcd: C, 57.31; H 5.11; N, 4.18.
Found: C, 57.35; H, 5.19; N, 4.15.

ESI-MS m/z : 358.11 [M+Na]⁺

1,2-*O*-isopropylidene-3-*C*-(2-nitrophenylethynyl)- α -D-ribofuranose (76**):**



A solution of **69** (300 mg, 0.67 mmol) in THF (10 mL) was cooled to 0 °C. 1 M TBAF in THF (0.8 mL, 0.8 mmol) was added drop wise and stirring continued for 2 h. After completion, the reaction mixture was treated with saturated NH₄Cl solution and extracted with EtOAc. The combined organic layers were dried over Na₂SO₄, concentrated and purified by column chromatography (50% EtOAc in light petroleum) to obtain **76** (185 mg, 83%) as a colorless oil.

Mol. Formula : C₁₆H₁₇NO₇

Mol. Weight : 335.31

[α]_D²⁵ : +36.7 (c 1, CHCl₃)

IR (CHCl₃, cm⁻¹) : 3427, 3020, 1609, 1473, 1377, 1346, 1164, 1047, 872.

¹H NMR : δ 1.38 (s, 3H), 1.60 (s, 3H), 2.28 (br s, 1H), 3.34 (s, 1H), (200 MHz, CDCl₃) 3.99–4.09 (m, 3H), 4.67 (d, $J = 3.7$ Hz, 1H), 5.96 (d, $J = 3.69$ Hz, 1H), 7.45–7.68 (m, 3H), 8.07 (br d, $J = 8.1$ Hz, 1H).

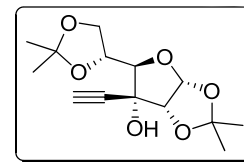
¹³C NMR : δ 26.6 (q), 26.8 (q), 62.0 (t), 75.6 (s), 82.2 (d), 83.5 (s), (50 MHz, CDCl₃) 83.9 (d), 92.9 (s), 104.2 (d), 113.6 (s), 117.1 (s), 124.8 (d), 129.5 (d), 133.0 (d), 135.0 (d), 149.7 (s).

Elemental Analysis : Calcd: C, 57.31; H 5.11; N, 4.18.

Found: C, 57.15; H, 4.98; N, 4.35.

ESI-MS m/z : 357.99 [M+Na]⁺

1,2:5,6-di-*O*-isopropylidene-3-*C*-ethynyl- α -D-*allo*-furanose (78):



As described for compound **63**, at 0 °C to a solution of ketone **77** (5 g, 19.35 mmol) in THF (25 mL) was added ethynyl MgCl [generated from Mg (1.88 g, 77.43 mmol) and *n*-BuCl (8.1 mL, 77.43 mmol)] and stirred for 30 min. usual workup and purification by column chromatography (10% ethyl acetate in light petroleum) gave **78** (3.5 g, 63%).

Mol. Formula : C₁₄H₂₀O₆

Mol. Weight : 284.31

[α]_D²⁵ : +7.9 (*c* 2.5, CHCl₃)

¹H NMR (200 MHz, CDCl₃) : δ 1.35 (s, 6H), 1.44 (s, 3H), 1.58 (s, 3H), 2.64 (s, 1H), 3.09 (s, 1H), 3.82 (d, *J* = 8.2 Hz, 1H), 4.0 (dd, *J* = 4.6, 8.8 Hz, 1H), 4.12 (dd, *J* = 6.2, 8.8 Hz, 1H), 4.4 (ddd, *J* = 5.6, 6.1, 8.2 Hz, 1H), 4.58 (d, *J* = 3.5 Hz, 1H), 5.78 (d, *J* = 3.5 Hz, 1H).

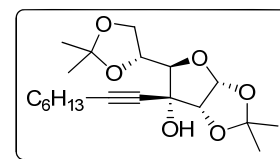
¹³C NMR (50 MHz, CDCl₃) : δ 25.1 (q), 26.5 (q), 26.6 (q, 2C), 66.8 (t), 74.6 (d), 75.7 (s), 76.8 (s), 76.8 (d), 80.9 (d), 84.1 (d), 103.9 (d), 109.4 (s), 113.2 (s).

Elemental Analysis : Calcd: C, 59.14; H 7.09.

Found: C, 59.03; H, 7.14.

ESI-MS m/z : 307.26 [M+Na]⁺

1,2:5,6-di-*O*-isopropylidene-3-*C*-(oct-1-ynyl)- α -D-*allo*-furanose (79):

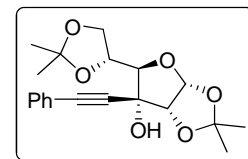


Compound **79** was prepared by treating the ketone **77** (1 g, 3.87 mmol) with lithium salt of 1-octyne prepared from 1-octyne (640 mg, 5.8 mmol) and *n*-BuLi (2.9 mL,

4.6 mmol, 1.6 M in hexane) stirring at $-78\text{ }^{\circ}\text{C}$ for 5 h followed by usual work up. The resulting residue was purified by silica gel chromatography (20% ethyl acetate in light petroleum) to afford **79** (1.04 g, 73%) as thick syrup.

Mol. Formula	: $\text{C}_{20}\text{H}_{32}\text{O}_6$
Mol. Weight	: 368.46
$[\alpha]_{\text{D}}^{25}$: +6.7 (<i>c</i> 1.6, CHCl_3)
^1H NMR (200 MHz, CDCl_3)	: δ 0.87 (t, $J = 6.7$ Hz, 3H), 1.24–1.30 (m, 6H), 1.34 (s, 6H), 1.43 (s, 3H), 1.48–1.51 (m, 2H), 1.57 (s, 3H), 2.23 (t, $J = 7.0$ Hz, 2H), 3.82 (d, $J = 7.6$ Hz, 1H), 3.99 (dd, $J = 5.1, 8.6$ Hz, 1H), 4.09 (dd, $J = 6.2, 8.6$ Hz, 1H), 4.36 (ddd, $J = 5.1, 6.2, 7.6$ Hz, 1H), 4.51 (d, $J = 3.6$ Hz, 1H), 5.75 (d, $J = 3.6$ Hz, 1H).
^{13}C NMR (50 MHz, CDCl_3)	: δ 14.0 (q), 18.7 (t), 22.5 (t), 25.2 (q), 26.7 (q, 3C), 28.3 (t), 28.4 (t), 31.2 (t), 66.8 (t), 74.9 (d), 75.7 (s), 77.8 (s), 81.2 (d), 84.4 (d), 89.7 (s), 104.0 (d), 109.3 (s), 113.4 (s).
Elemental Analysis	: Calcd: C, 65.19; H, 8.75. Found: C, 65.30; H, 8.78.

1,2:5,6-di-*O*-isopropylidene-3-*C*-phenylethynyl- α -D-*allo*-furanose (80**):**



Compound **80** was prepared by treating the ketone **77** (1 g, 3.87 mmol) with lithium salt of phenylacetylene prepared from phenylacetylene (593 mg, 5.8 mmol) and *n*-BuLi (2.9 mL, 4.6 mmol, 1.6 M in hexane) at $-78\text{ }^{\circ}\text{C}$ for 1 h followed by usual workup and purification on silica gel column (20% ethyl acetate in light petroleum) gave **80** (1.05 g, 75%).

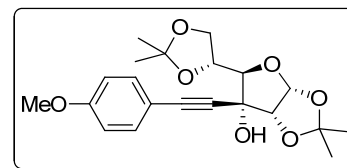
Mol. Formula	: $\text{C}_{20}\text{H}_{24}\text{O}_6$
Mol. Weight	: 360.4
$[\alpha]_{\text{D}}^{25}$: -8.4 (<i>c</i> 0.4, CHCl_3)
IR (CHCl_3 , cm^{-1})	: 3684, 3543, 3019, 2992, 2938, 2230, 1599, 1520, 1069, 1042, 873, 841, 625.

¹H NMR : δ 1.37 (s, 3H), 1.38 (s, 3H), 1.46 (s, 3H), 1.61 (s, 3H),
(200 MHz, CDCl₃) 3.11 (s, 1H), 3.93 (d, J = 7.6 Hz, 1H), 4.06 (dd, J = 5.2,
8.7 Hz, 1H), 4.15 (dd, J = 6.1, 8.7 Hz, 1H), 4.47 (ddd, J =
5.2, 6.1, 7.6 Hz, 1H), 4.67 (d, J = 3.6 Hz, 1H), 5.85 (d, J
= 3.6 Hz, 1H), 7.29–7.35 (m, 3H), 7.42–7.47 (m, 2H).

¹³C NMR : δ 25.1 (q), 26.5 (q, 2C), 26.6 (q), 66.7 (t), 74.8 (d), 76.1
(50 MHz, CDCl₃) (s), 81.5 (d), 84.1 (d), 85.7 (s), 88.4 (s), 104.1 (d), 109.3
(s), 113.5 (s), 121.6 (s), 128.2 (d, 2C), 128.8 (d), 131.7 (d,
2C).

Elemental Analysis : Calcd: C, 66.65; H, 6.71.
Found: C, 66.45; H, 6.43.

**1,2:5,6-di-*O*-isopropylidene-3-*C*-(4-methoxy-phenyl
ethynyl)- α -D-*allo*-furanose (**81**):**



A solution of alkyne **78** (0.5 g, 1.76 mmol), *p*-iodoanisole (618 mg, 2.64 mmol), Et₃N (10 mL), CuI (33 mg, 0.17 mmol), PPh₃ (46 mg, 0.17 mmol) and Pd (PPh₃)₂Cl₂ (123 mg, 0.17 mmol) in DMF (5 mL) was flushed with argon for 30 min and stirred for 10 h. The reaction mixture was diluted with ethyl acetate, washed with water, brine, dried over Na₂SO₄ and concentrated. The residue was purified on silica gel column (30% ethyl acetate in light petroleum) to obtain **81** (481 mg, 70%) as a solid.

M.P. : 120 °C
Mol. Formula : C₂₁H₂₆O₇
Mol. Weight : 390.43
[α]_D²⁵ : -7.1 (*c* 1, CHCl₃)
IR (CHCl₃, cm⁻¹) : 3437, 3019, 2936, 1606, 1511, 1384, 1216, 1070, 1034,
834, 668.
¹H NMR : δ 1.37 (s, 6H), 1.46 (s, 3H), 1.61 (s, 3H), 3.13 (s, 1H),
(200 MHz, CDCl₃) 3.80 (s, 3H), 3.96 (d, J = 7.4 Hz, 1H), 4.07 (dd, J = 5.2,
8.7 Hz, 1H), 4.15 (dd, J = 6.1, 8.7 Hz, 1H), 4.49 (ddd, J =
5.2, 6.1, 7.6 Hz, 1H), 4.67 (d, J = 3.6 Hz, 1H), 5.86 (d, J

= 3.6 Hz, 1H), 6.83 (d, $J = 8.9$ Hz, 2H), 7.37 (d, $J = 8.9$ Hz, 2H).

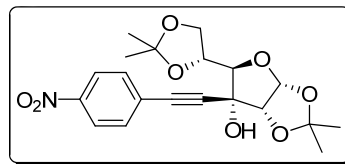
^{13}C NMR : δ 25.1 (q), 26.6 (q), 26.7 (q, 2C), 55.3 (q), 66.9 (t), 74.9 (125 MHz, CDCl_3) (d), 76.2 (s), 81.4 (d), 84.1 (d), 84.2 (s), 88.8 (s), 104.2 (d), 109.5 (s), 113.6 (s), 113.7 (s), 114.0 (d, 2C), 133.3 (d, 2C), 160.1 (s).

Elemental Analysis : Calcd: C, 64.60; H, 6.71.

Found: C, 64.43; H, 6.90.

ESI-MS m/z : 413.22 $[\text{M}+\text{Na}]^+$

1,2:5,6-di-*O*-isopropylidene-3-*C*-(4-nitrophenyl ethynyl)- α -D-*allo*-furanose (82**):**



To a solution of 4-nitroiodobenzene (328 mg, 1.3 mmol) in Et_3N -DMF (6 mL, 2:1) was successively added CuI (17 mg, 0.09 mmol), PPh_3 (23 mg, 0.09 mmol), Pd (PPh_3) $_2\text{Cl}_2$ (62 mg, 0.09 mmol) and alkyne **78** (250 mg, 0.88 mmol). The reaction mixture was flushed with Argon for 30 min and the stirring continued for 4 h. After usual workup, the residue was chromatographed on silica gel (40% ethyl acetate in light petroleum) to procure **82** (324 mg, 91%) as a syrup.

Mol. Formula : $\text{C}_{20}\text{H}_{23}\text{NO}_8$

Mol. Weight : 405.4

$[\alpha]_D^{25}$: -20.5 (c 1.5, CHCl_3)

IR (CHCl_3 , cm^{-1}) : 3447, 3020, 1596, 1523, 1384, 1347, 1071, 855, 669.

^1H NMR : δ 1.37 (s, 3H), 1.39 (s, 3H), 1.47 (s, 3H), 1.62 (s, 3H), (200 MHz, CDCl_3) 3.22 (s, 1H), 3.92 (d, $J = 8.1$ Hz, 1H), 4.05 (dd, $J = 4.8$, 8.8 Hz, 1H), 4.15 (dd, $J = 6.1$, 8.8 Hz, 1H), 4.43 (ddd, $J = 4.9$, 6.1, 8.1 Hz, 1H), 4.70 (d, $J = 3.6$ Hz, 1H), 5.87 (d, $J = 3.6$ Hz, 1H), 7.61 (br d, $J = 8.9$ Hz, 2H), 8.20 (br d, $J = 8.9$ Hz, 2H).

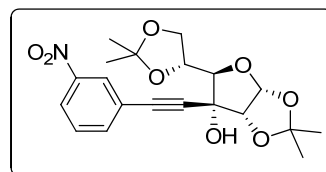
^{13}C NMR : δ 25.1 (q), 26.6 (q, 2C), 26.7 (q), 67.0 (t), 74.8 (d), 76.4 (50 MHz, CDCl_3) (s), 81.0 (d), 83.8 (d), 86.4 (s), 90.8 (s), 104.0 (d), 109.7

(s), 113.8 (s), 123.5 (d, 2C), 128.2 (s), 132.6 (d, 2C),
147.5 (s).

Elemental Analysis : Calcd: C, 59.25; H, 5.72; N, 3.46.
Found: C, 59.55; H, 5.69; N, 3.48.

ESI-MS m/z : 428.17 [M+Na]⁺

1,2:5,6-di-*O*-isopropylidene-3-*C*-(3-nitrophenyl ethynyl)- α -D-*allo*-furanose (83**):**



Preparation of **83** was carried out by treating **78** (260 mg, 0.91 mmol) with 3-nitroiodobenzene (341 mg, 1.37 mmol), CuI (17 mg, 0.09 mmol), PPh₃ (24 mg, 0.09 mmol) and Pd (PPh₃)₂Cl₂ (63 mg, 0.09 mmol) and stirring the contents for 5 h followed by usual workup and chromatographic (30% ethyl acetate in light petroleum) purification to obtain **83** (352 mg, 95%) as a liquid.

Mol. Formula : C₂₀H₂₃NO₈

Mol. Weight : 405.4

[α]_D²⁵ : -14.0 (*c* 1, CHCl₃)

IR (CHCl₃, cm⁻¹) : 3537, 3020, 2992, 1534, 1455, 1384, 1354, 1164, 1071,
928, 841, 623.

¹H NMR : δ 1.37 (s, 3H), 1.38 (s, 3H), 1.47 (s, 3H), 1.61 (s, 3H),
(200 MHz, CDCl₃) 3.21 (s, 1H), 3.91 (d, *J* = 8.0 Hz, 1H), 4.05 (dd, *J* = 4.9,
8.7 Hz, 1H), 4.15 (dd, *J* = 6.1, 8.7 Hz, 1H), 4.44 (ddd, *J* =
4.9, 6.1, 8.0 Hz, 1H), 4.69 (d, *J* = 3.6 Hz, 1H), 5.86 (d, *J* =
3.6 Hz, 1H), 7.52 (t, *J* = 8.1 Hz, 1H), 7.75 (dt, *J* = 1.3,
7.7 Hz, 1H), 8.20 (ddd, *J* = 1.1, 2.3, 8.2 Hz, 1H), 8.09 (br
t, *J* = 1.8 Hz, 1H).

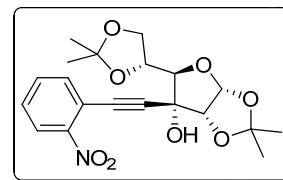
¹³C NMR : δ 25.1 (q), 26.5 (q, 2C), 26.6 (q), 66.9 (t), 74.8 (d), 76.2
(50 MHz, CDCl₃) (s), 81.0 (d), 83.9 (d), 85.8 (s), 88.4 (s), 104.0 (d), 109.6
(s), 113.7 (s), 123.3 (s), 123.6 (d), 126.5 (d), 129.4 (d),
137.3 (d), 147.9 (s).

Elemental Analysis : Calcd: C, 59.25; H, 5.72; N, 3.46.

Found: C, 58.98; H, 5.46; N, 3.18.

ESI-MS m/z : 428.17 $[M+Na]^+$

1,2:5,6-di-*O*-isopropylidene-3-*C*-(2-nitrophenyl ethynyl)- α -*D*-allo-furanose (84):



The preparation of **84** was carried out by treating **78** (250 mg, 0.88 mmol) with 2-nitroiodobenzene (326 mg, 1.3 mmol), CuI (17 mg, 0.088 mmol), PPh₃ (23 mg, 0.088 mmol) and Pd (PPh₃)₂Cl₂ (62 mg, 0.088 mmol) in Et₃N-DMF (6 mL, 2:1) as described earlier for 5 h. The residue was chromatographed on silica gel (20% ethyl acetate in light petroleum) to afford **84** (300 mg, 84%) as a colorless oil.

Mol. Formula : C₂₀H₂₃NO₈

Mol. Weight : 405.40

$[\alpha]_D^{25}$: -16.1 (*c* 1.9, CHCl₃)

IR (CHCl₃, cm⁻¹) : 3437, 3020, 1530, 1385, 1352, 1084, 1029, 929, 668.

¹H NMR (200 MHz, CDCl₃) : δ 1.37 (s, 3H), 1.39 (s, 3H), 1.47 (s, 3H), 1.61 (s, 3H), 3.22 (s, 1H), 3.9 (d, *J* = 8.2 Hz, 1H), 4.02 (dd, *J* = 4.9, 8.8 Hz, 1H), 4.12 (dd, *J* = 6.1, 8.8 Hz, 1H), 4.44–4.54 (m, 1H), 4.72 (d, *J* = 3.61 Hz, 1H), 5.89 (d, *J* = 3.61 Hz, 1H), 7.47–7.69 (m, 3H), 8.1 (d, *J* = 8.01 Hz, 1H).

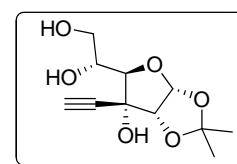
¹³C NMR (50 MHz, CDCl₃) : δ 25.0 (q), 26.6 (q), 26.7 (q, 2C), 67.1 (t), 74.8 (d), 76.5 (s), 81.2 (d), 83.6 (s), 84.0 (d), 93.6 (s), 104.1 (d), 109.5 (s), 113.6 (s), 117.1 (s), 124.7 (d), 129.4 (d), 132.8 (d), 134.8 (d), 149.6 (s).

Elemental Analysis : Calcd: C, 59.25; H, 5.72; N, 3.46.

Found: C, 59.01; H, 5.61; N, 3.28.

ESI-MS m/z : 428.17 $[M+Na]^+$

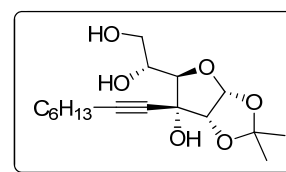
1,2-*O*-isopropylidene-3-*C*-ethynyl- α -*D*-allo-furanose (85):



Compound **78** (170 mg, 0.6 mmol) and 0.8% H₂SO₄ (1 mL) in MeOH (4 mL) was stirred for 12 h. The reaction mixture was neutralized with NaHCO₃ and extracted with ethyl acetate. The combined organic phase was washed with brine, dried over Na₂SO₄ and concentrated. The residue was purified by silica gel chromatography (90% ethyl acetate in light petroleum) to give **85** (100 mg, 68%) as colorless thick liquid.

Mol. Formula	: C ₁₁ H ₁₆ O ₆
Mol. Weight	: 244.24
[α]_D²⁵	: +53.8 (<i>c</i> 1, CHCl ₃)
IR (CHCl₃, cm⁻¹)	: 3445, 3251, 3020, 2941, 1603, 1386, 1166, 1107, 1072, 1017, 874, 669.
¹H NMR (200 MHz, D ₂ O)	: δ 1.39 (s, 3H), 1.58 (s, 3H), 3.63 (dd, <i>J</i> = 5.8, 12.1 Hz, 1H) 3.8 (dd, <i>J</i> = 2.7, 12.1 Hz, 1H), 3.91 (d, <i>J</i> = 8.6 Hz, 1H), 4.04 (ddd, <i>J</i> = 2.7, 5.8, 8.5 Hz, 1H), 4.75 (d, <i>J</i> = 3.7 Hz, 1H), 5.93 (d, <i>J</i> = 3.7 Hz, 1H).
¹³C NMR (50 MHz, CDCl ₃)	: δ 27.3 (q, 2C), 65.2 (t), 72.7 (d), 77.2 (s), 80.4 (d), 85.9 (d), 105.1 (d), 115.9 (s).
Elemental Analysis	: Calcd: C, 54.09; H, 6.60. Found: C, 54.34; H, 6.47.
ESI-MS <i>m/z</i>	: 267.09 [M+Na] ⁺

1,2-*O*-isopropylidene-3-*C*-(oct-1-nyl)- α -D-*allo*-furanose (86**):**

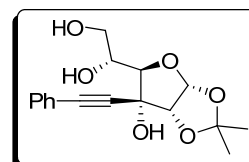


Compound **86** was prepared by treating **79** (500 mg, 1.36 mmol) with 0.8% H₂SO₄ (5 mL) for 15 h and usual work-up. The residue was chromatographed on silica gel (80% ethyl acetate in light petroleum) to obtain **86** (352 mg, 79%) as a solid.

M.P.	: 76 °C
Mol. Formula	: C ₁₇ H ₂₈ O ₆
Mol. Weight	: 328.40
[α]_D²⁵	: 31.8 (<i>c</i> 1.3, CHCl ₃)

IR (CHCl ₃ , cm ⁻¹)	: 3400, 3019, 2933, 1644, 1428, 1377, 1163, 1076, 1045, 1007, 929, 872, 668.
¹H NMR (200 MHz, CDCl ₃)	: δ 0.87 (t, <i>J</i> = 6.8 Hz, 3H), 1.28–1.32 (m, 6H), 1.35 (s, 3H), 1.45–1.52 (m, 2H), 1.57 (s, 3H), 2.24 (t, <i>J</i> = 7.0 Hz, 2H), 2.57 (br s, 1H), 2.96 (d, <i>J</i> = 4.0 Hz, 1H), 3.47 (s, 1H), 3.69–3.9 (m, 3H), 4.0–4.10 (m, 1H), 4.51 (d, <i>J</i> = 3.6 Hz, 1H), 5.77 (d, <i>J</i> = 3.6 Hz, 1H).
¹³C NMR (125 MHz, CDCl ₃)	: δ 13.9 (q), 18.7 (t), 22.4 (t), 26.6 (q, 2C), 28.4 (t), 28.5 (t), 31.2 (t), 63.9 (t), 71.8 (d), 76.2 (s), 76.8 (s), 79.6 (d), 84.4 (d), 90.2 (s), 103.9 (d), 113.5 (s).
Elemental Analysis	: Calcd: C, 62.17; H, 8.59. Found: C, 62.15; H, 8.36.
ESI-MS <i>m/z</i>	: 351.17 [M+Na] ⁺

1,2-*O*-isopropylidene-3-*C*-phenylethynyl- α -*D*-allo-furanose (87):



A solution of **80** (500 mg, 1.39 mmol) in MeOH (20 mL) and dil. H₂SO₄ (5 mL, 0.8% in water) was stirred at 25 °C for 15 h, quenched with NaHCO₃ and concentrated. The residue was partitioned between ethyl acetate–water and the aqueous layer was extracted with ethyl acetate. The combined organic phase was dried over Na₂SO₄, concentrated and purified by column chromatography with 80% ethyl acetate in light petroleum to obtain **87** (312 mg, 70%) as white solid.

M.P.	: 126 °C
Mol. Formula	: C ₁₇ H ₂₀ O ₆
Mol. Weight	: 320.34
[α]_D²⁵	: +40.1 (<i>c</i> 1, CHCl ₃)
IR (CHCl ₃ , cm ⁻¹)	: 3468, 3019, 1385, 1039, 929, 874, 669.
¹H NMR (200 MHz, CDCl ₃)	: δ 1.35 (s, 3H), 1.59 (s, 3H), 3.37 (br s, 3H), 3.73 (dd, <i>J</i> = 4.9, 11.8 Hz, 1H), 3.87 (dd, <i>J</i> = 3.1, 11.8 Hz, 1H), 3.96 (d, <i>J</i> = 8.6 Hz, 1H), 4.15 (ddd, <i>J</i> = 3.1, 4.9, 8.3 Hz, 1H),

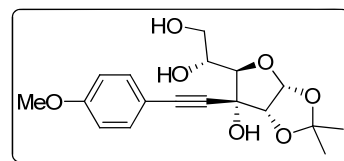
4.66 (d, $J = 3.7$ Hz, 1H), 5.84 (d, $J = 3.7$ Hz, 1H), 7.28–7.32 (m, 3H), 7.42–7.47 (m, 2H).

^{13}C NMR : δ 26.6 (q, 2C), 64.0 (t), 71.8 (d), 76.6 (s), 79.6 (d), 84.1 (50 MHz, CDCl_3) (d), 85.4 (s), 88.8 (s), 103.9 (d), 113.7 (s), 121.4 (s), 128.4 (d, 2C), 129.0 (d), 132.0 (d, 2C).

Elemental Analysis : Calcd: C, 63.74; H, 6.29.
Found: C, 63.75; H, 6.05.

ESI-MS m/z : 343.09 $[\text{M}+\text{Na}]^+$

1,2-*O*-isopropylidene-3-*C*-(4-methoxyphenyl ethynyl)- α -*D*-allo-furanose (88**):**



81 (100 mg, 0.26 mmol) and 0.8% H_2SO_4 (1 mL) in MeOH (4 mL) were stirred for 12 h, neutralized with NaHCO_3 and worked up as usual to give a residue which was purified on silica gel (80% ethyl acetate in light petroleum) to afford **88** (72 mg, 80%) as a white solid.

M.P. : 116 °C

Mol. Formula : $\text{C}_{18}\text{H}_{22}\text{O}_7$

Mol. Weight : 350.36

$[\alpha]_D^{25}$: +42.3 (c 1, CHCl_3)

IR (CHCl_3 , cm^{-1}) : 3404, 3019, 1606, 1511, 1250, 1106, 1035, 930, 874, 834.

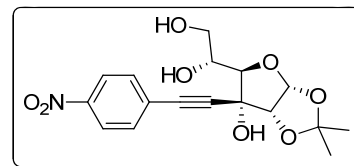
^1H NMR : δ 1.35 (s, 3H), 1.58 (s, 3H), 3.10 (br s, 2H), 3.72–3.78 (m, 2H), 3.77 (s, 3H), 3.83 (br s, 1H), 3.91 (d, $J = 8.6$ Hz, 1H), 4.07–4.17 (m, 1H), 4.62 (d, $J = 3.6$ Hz, 1H), 5.81 (d, $J = 3.6$ Hz, 1H), 6.79 (d, $J = 8.8$ Hz, 2H), 7.37 (d, $J = 8.8$ Hz, 2H).

^{13}C NMR : δ 26.7 (q, 2C), 55.2 (q), 64.0 (t), 71.8 (d), 76.7 (s), 79.6 (50 MHz, CDCl_3) (d), 84.1 (s), 84.2 (d), 88.8 (s), 103.9 (d), 113.6 (s, 2C), 114.0 (d, 2C), 133.5 (d, 2C), 160.2 (s).

Elemental Analysis : Calcd: C, 61.71; H, 6.33.
Found: C, 61.55; H, 6.27.

ESI-MS m/z : 373.14 [M+Na]⁺

1,2-*O*-isopropylidene-3-*C*-(4-nitrophenyl ethynyl)- α -D-*allo*-furanose (89**):**



Compound **89** (75% yield) was prepared by adopting similar reaction condition as reported for **78**.

M.P. : 139 °C

Mol. Formula : C₁₇H₁₉NO₈

Mol. Weight : 365.33

[α]_D²⁵ : +36.9 (*c* 1, CH₃OH)

IR (CHCl₃, cm⁻¹) : 3419, 3020, 1594, 1522, 1377, 1346, 1020, 929, 855, 669.

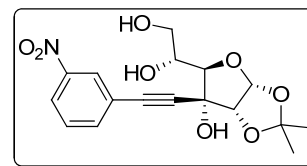
¹H NMR (200 MHz, CDCl₃, DMSO-d₆) : δ 1.30 (s, 3H), 1.53 (s, 3H), 3.49 (br s, 1H), 3.62 (br d, *J* = 10.7 Hz, 1H), 3.79 (br d, *J* = 10.7 Hz, 1H), 3.93 (br d, *J* = 8.9 Hz, 1H), 3.98–4.08 (m, 2H), 4.50 (s, 1H), 4.62 (d, *J* = 3.6 Hz, 1H), 5.78 (d, *J* = 3.6 Hz, 1H), 7.55 (br d, *J* = 8.4 Hz, 2H), 8.10 (br d, *J* = 8.4 Hz, 2H).

¹³C NMR (50 MHz, CDCl₃) : δ 26.2 (q), 26.3 (q), 63.8 (t), 71.7 (d), 76.4 (s), 79.0 (d), 83.8 (d), 85.5 (s), 91.8 (s), 103.5 (d), 113.3 (s), 123.1 (d, 2C), 128.4 (s), 132.4 (d, 2C), 147.0 (s).

Elemental Analysis : Calcd: C, 55.89; H, 5.24; N, 3.83.
Found: C, 56.08; H, 5.37; N, 3.62.

ESI-MS m/z : 388.11 [M+Na]⁺

1,2-*O*-isopropylidene-3-*C*-(3-nitrophenyl ethynyl)- α -D-*allo*-furanose (90**):**



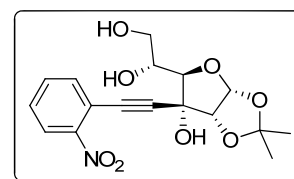
Following a similar procedure reported for the deprotection of **78**, triol **90** (347 mg, 77%) was obtained by deprotection of **83** (500 mg, 1.23 mmol).

Mol. Formula : C₁₇H₁₉NO₈

Mol. Weight : 365.33

$[\alpha]_D^{25}$: +35.7 (<i>c</i> 1, MeOH)
IR (CHCl ₃ , cm ⁻¹)	: 3433, 3020, 2935, 1533, 1385, 1164, 1353, 1084, 1040, 929, 872, 624.
¹ H NMR (200 MHz, CDCl ₃)	: δ 1.40 (s, 3H), 1.62 (s, 3H), 2.70 (br s, 1H), 3.57 (br s, 1H), 3.79 (dd, <i>J</i> = 4.8, 11.5 Hz, 1H), 3.93 (dd, <i>J</i> = 3.3, 11.5 Hz, 1H), 3.97 (d, <i>J</i> = 8.0 Hz, 1H), 4.14–4.22 (m, 1H), 4.71 (d, <i>J</i> = 3.6 Hz, 1H), 5.91 (d, <i>J</i> = 3.6 Hz, 1H), 7.53 (t, <i>J</i> = 8.0 Hz, 1H), 7.78 (dt, <i>J</i> = 1.4, 7.7 Hz, 1H), 8.21 (ddd, <i>J</i> = 1.1, 2.3, 8.3 Hz, 1H), 8.31 (br t, <i>J</i> = 1.9 Hz, 1H).
¹³ C NMR (50 MHz, CDCl ₃)	: δ 26.0 (q), 26.1 (q), 63.5 (t), 71.4 (d), 76.1 (s), 78.8 (d), 83.7 (d), 84.7 (s), 89.2 (s), 103.2 (d), 112.8 (s), 122.8 (d), 123.2 (s), 126.0 (d), 129.0 (d), 137.1 (d), 147.4 (s).
Elemental Analysis	: Calcd: C, 55.89; H, 5.24; N, 3.83. Found: C, 55.90; H, 5.43; N, 3.57.
ESI-MS <i>m/z</i>	: 388.09 [M+Na] ⁺

1,2-*O*-isopropylidene-3-*C*-(2-nitrophenylethynyl)- α -D-*allo*-furanose (91**):**



Compound **91** (73%) was prepared by adopting similar reaction condition as reported for **78**.

Mol. Formula	: C ₁₇ H ₁₉ NO ₈
Mol. Weight	: 365.33
$[\alpha]_D^{25}$: +26.0 (<i>c</i> 1, MeOH)
IR (CHCl ₃ , cm ⁻¹)	: 3401, 2924, 1610, 1527, 1384, 1217, 1084, 1030, 930.
¹ H NMR (200 MHz, CDCl ₃)	: δ 1.39 (s, 3H), 1.6 (s, 3H), 2.47 (br s, 1H), 3.06 (br s, 1H), 3.76 (dd, <i>J</i> = 4., 11.7 Hz, 1H), 3.91 (dd, <i>J</i> = 3.2, 11.7 Hz, 1H), 4.01 (d, <i>J</i> = 8.2 Hz, 1H), 4.20 (ddd, <i>J</i> = 3.2, 4.8, 8.2 Hz, 1H), 4.74 (d, <i>J</i> = 3.7 Hz, 1H), 5.93 (d, <i>J</i> = 3.7 Hz, 1H), 7.50 (ddd, <i>J</i> = 1.8, 7.3, 8.0 Hz, 1H), 7.61 (dt, <i>J</i> =

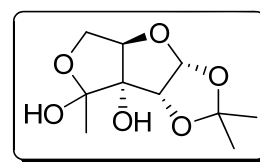
1.5, 7.5 Hz, 1H), 7.69 (dd, $J = 1.8, 7.6$ Hz, 1H), 8.08 (dd, $J = 1.3, 8.0$ Hz, 1H).

^{13}C NMR : δ 26.6 (q, 2C), 64.1 (t), 71.8 (d), 76.7 (s), 79.8 (d), 83.5 (75 MHz, CDCl_3) (s), 84.1 (d), 94.1 (s), 104.0 (d), 113.7 (s), 117.2 (s), 124.6 (d), 129.4 (d), 133.0 (d), 135.1 (d), 149.6 (s).

Elemental Analysis : Calcd: C, 55.89; H, 5.24; N, 3.83.
Found: C, 55.80; H, 5.33; N, 3.74.

ESI-MS m/z : 388.09 $[\text{M}+\text{Na}]^+$

1,2-*O*-isopropylidene-3-*C*-(1'-acetyl)- α -D-ribo-furanose-(1'-*C*,5-*O*)-hemiketal (93**):**



A solution of **70** (60 mg, 0.28 mmol) and $\text{PdCl}_2(\text{CH}_3\text{CN})_2$ (7 mg, 28 μmol) in dry CH_3CN (4 mL) under argon atmosphere was stirred at 25 $^\circ\text{C}$ for 1 h. The crude product was purified by column chromatography on silica gel (30% ethyl acetate in light petroleum) to obtain **93** (44 mg, 67%) as a colorless liquid.

Mol. Formula : $\text{C}_{10}\text{H}_{16}\text{O}_6$

Mol. Weight : 232.23

$[\alpha]_D^{25}$: +56.7 (c 0.75, CHCl_3)

IR (CHCl_3 , cm^{-1}) : 3466, 3019, 2991, 1456, 1384, 1165, 1087, 1025.

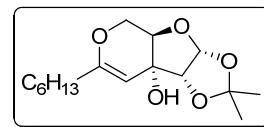
^1H NMR : δ 1.38 (s, 3H), 1.45 (s, 3H), 1.56 (s, 3H), 2.70 (s, 1H), (200 MHz, CDCl_3) 3.00 (s, 1H), 4.01 (dd, $J = 1.6, 10.5$ Hz, 1H), 4.19 (dd, $J = 5.1, 10.5$ Hz, 1H), 4.43 (m, 1H), 4.49 (d, $J = 3.8$ Hz, 1H), 5.86 (d, $J = 3.8$ Hz, 1H).

^{13}C NMR : δ 21.8 (q), 26.9 (q), 27.2 (q), 70.8 (t), 78.9 (d), 86.6 (d), (50 MHz, CDCl_3) 89.3 (s), 105.6 (s), 108.1 (d), 112.4 (s).

Elemental Analysis : Calcd: C, 51.72; H, 6.94.
Found: C, 51.79; H, 7.13.

ESI-MS m/z : 255.12 $[\text{M}+\text{Na}]^+$

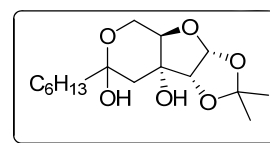
1,2-*O*-isopropylidene-3-*C*-(2'-hydroxy-oct-1'-(*Z*)-enyl)-2',5-anhydro- α -D-ribo-furanose (94**):**



A solution of **71** (200 mg, 0.67 mmol) and PdCl₂(CH₃CN)₂ (17 mg, 67 μ mol) in dry CH₃CN (6 mL) was stirred under Argon for 32 h. Usual workup followed by chromatographic purification (30% ethyl acetate in light petroleum) gave **94** (51 mg, 51%) and unreacted **71** (100 mg).

Mol. Formula	: C ₁₆ H ₂₆ O ₅
Mol. Weight	: 298.37
[α]_D²⁵	: +35.2 (<i>c</i> 0.25, CHCl ₃)
IR (CHCl₃, cm⁻¹)	: 3381, 3019, 2930, 1376, 1163, 1124, 1066, 668.
¹H NMR (200 MHz, CDCl ₃)	: δ 0.87 (t, <i>J</i> = 6.5 Hz, 3H), 1.26–1.28 (m, 6H), 1.36 (s, 3H), 1.42–1.57 (m, 2H), 1.57 (s, 3H), 2.05 (t, <i>J</i> = 7.3 Hz, 2H), 2.86 (s, 1H), 3.84 (dd, <i>J</i> = 1.1, 12.3 Hz, 1H), 3.90–3.91 (m, 1H), 4.19 (d, <i>J</i> = 3.7 Hz, 1H), 4.33 (ddd, <i>J</i> = 0.8, 1.9, 12.3 Hz, 1H), 4.40 (br s, 1H), 5.70 (d, <i>J</i> = 3.7 Hz, 1H).
¹³C NMR (125 MHz, CDCl ₃)	: δ 13.9 (q), 22.4 (t), 26.3 (t), 26.6 (q), 26.9 (q), 28.6 (t), 31.4 (t), 34.0 (t), 62.9 (t), 71.1 (s), 76.6 (d), 83.4 (d), 94.1 (d), 104.0 (d), 112.6 (s), 159.6 (s).
Elemental Analysis	: Calcd: C, 64.41; H, 8.78. Found: C, 64.65; H, 8.60.
ESI-MS <i>m/z</i>	: 321.18 [M+Na] ⁺

1,2-*O*-isopropylidene-3-*C*-(2'-oxooctyl)- α -D-ribo-furanose-(2'-*C*,5-*O*)-hemiketal (95**):**



Mol. Formula	: C ₁₆ H ₂₈ O ₆
Mol. Weight	: 316.39
[α]_D²⁵	: -3.7 (<i>c</i> 0.4, CHCl ₃)
IR (CHCl₃, cm⁻¹)	: 3516, 3019, 2930, 1422, 1376, 1105, 1051, 1005, 877.
¹H NMR	: δ 0.85 (t, <i>J</i> = 6.6 Hz, 3H), 1.23–1.29 (m, 6H), 1.32 (s,

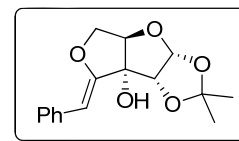
(500 MHz, CDCl₃) 3H), 1.35–1.42 (m, 2H), 1.51 (d, *J* = 14.0 Hz, 1H), 1.54 (s, 3H), 1.56–1.59 (m, 2H), 1.77 (d, *J* = 14.0 Hz, 1H), 3.28 (br s, 1H), 3.66 (br s, 1H), 3.91 (d, *J* = 13.8 Hz, 1H), 4.05 (d, *J* = 3.7 Hz, 1H), 4.11 (dd, *J* = 2.1, 14.0 Hz, 1H), 4.16 (br s, 1H), 5.74 (d, *J* = 3.7 Hz, 1H).

¹³C NMR : δ 14.1 (q), 22.6 (t), 22.7 (t), 26.4 (q), 26.5 (q), 29.5 (t), (125 MHz, CDCl₃) 31.8 (t), 36.8 (t), 41.6 (t), 57.3 (t), 74.0 (d), 74.6 (s), 82.6 (d), 95.5 (s), 103.6 (d), 112.7 (s).

Elemental Analysis : Calcd: C, 60.74; H, 8.98.
Found C, 60.52; H, 9.02.

ESI-MS *m/z* : 339.18 [M+Na]⁺

1,2-*O*-isopropylidene-3-*C*-(1'-hydroxy-2'-phenyl-1'-(*Z*)-enyl)-1',5-anhydro- α -D-ribo-furanose (96**):**



The reaction of **72** (100 mg, 0.34 mmol) and PdCl₂(CH₃CN)₂ (9 mg, 34 μmol) in dry CH₃CN (6 mL) was carried out as described earlier for 48 h at 25 °C followed by chromatography on silica (10% ethyl acetate in light petroleum) to obtain **96** (29 mg, 29%) as a colorless oil .

Mol. Formula : C₁₆H₁₈O₅

Mol. Weight : 290.31

[α]_D²⁵ : +21.3 (*c* 0.3, CHCl₃)

IR (CHCl₃, cm⁻¹) : 3393, 3020, 1495, 1385, 1165, 1143, 1083, 1060, 1011, 978, 876.

¹H NMR : δ 1.42 (s, 3H), 1.62 (s, 3H), 3.15 (s, 1H), 4.35 (dd, *J* = (500 MHz, CDCl₃) 2.7, 10.4 Hz, 1H), 4.43 (d, *J* = 10.4 Hz, 1H), 4.46 (d, *J* = 2.7 Hz, 1H), 4.62 (d, *J* = 3.8 Hz, 1H), 5.51 (s, 1H), 5.88 (d, *J* = 3.8 Hz, 1H), 7.13 (t, *J* = 7.3 Hz, 1H), 7.27 (t, *J* = 7.8 Hz, 2H), 7.57 (d, *J* = 7.8 Hz, 2H)

¹³C NMR : δ 27.1 (q), 27.3 (q), 73.2 (t), 83.2 (d), 83.8 (d), 87.1 (s), (125 MHz, CDCl₃) 103.3 (d), 105.8 (d), 113.2 (s), 126.3 (d), 128.3 (2d, 4C),

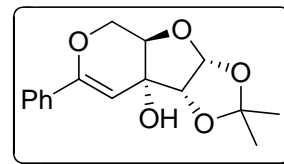
135.2 (s), 155.7 (s).

Elemental Analysis : Calcd: C, 66.19; H, 6.25.

Found: C, 66.10, H, 6.47.

ESI-MS m/z : 313.14 [M+Na]⁺

1,2-*O*-isopropylidene-3-*C*-(2'-hydroxy-2'-phenyl-1'-(*Z*)-enyl)-2',5-anhydro- α -D-ribo-furanose (97):



Further elution with 20% ethyl acetate in light petroleum gave **97** (59 mg, 59%) as white solid.

M.P. : 103 °C

Mol. Formula : C₁₆H₁₈O₅

Mol. Weight : 290.31

[α]_D²⁵ : -58.2 (*c* 0.3, CHCl₃)

IR (CHCl₃, cm⁻¹) : 3531, 3019, 2928, 1451, 1384, 1164, 1116, 1087, 1056, 1009, 895, 874, 693, 668, 623.

¹H NMR : δ 1.38 (s, 3H), 1.60 (s, 3H), 3.06 (s, 1H), 4.03 (br s, 1H), (200 MHz, CDCl₃) 4.04 (d, *J* = 11.6 Hz, 1H), 4.32 (d, *J* = 3.7 Hz, 1H), 4.54 (br d, *J* = 12.1 Hz, 1H), 5.19 (s, 1H), 5.74 (d, *J* = 3.7 Hz, 1H), 7.31–7.32 (m, 3H), 7.59–7.60 (m, 2H).

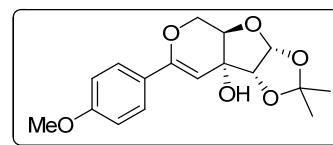
¹³C NMR : δ 26.8 (q), 27.1 (q), 63.6 (t), 71.7 (s), 77.4 (d), 83.5 (d), (125 MHz, CDCl₃) 95.1 (d), 104.2 (d), 112.8 (s), 125.2 (d, 2C), 128.2 (d, 2C), 129.2 (d), 134.3 (s), 155.5 (s).

Elemental Analysis : Calcd: C, 66.19; H, 6.25.

Found: C, 66.40, H, 6.23.

ESI-MS m/z : 313.11 [M+Na]⁺

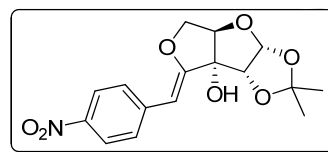
1,2-*O*-isopropylidene-3-*C*-[2'-hydroxy-2'-(4-methoxyphenyl)-1'-(*Z*)-enyl]-2',5-anhydro- α -D-ribo-furanose (98):



Alkyne **73** (130 mg, 0.41 mmol) was taken in CH₃CN in argon atmosphere. PdCl₂(CH₃CN)₂ (10 mg, 40 μmol) was added to it. After completion of reaction the reaction mixture was concentrated and purified by column chromatography (4:6, EtOAc: Hexane). The product **98** was obtained as white crystalline solid (100 mg, 77%).

M.P.	: 110.8 °C
Mol. Formula	: C ₁₇ H ₂₀ O ₆
Mol. Weight	: 320.34
[α]_D²⁵	: -77.16 (<i>c</i> 1, CHCl ₃)
IR (CHCl₃, cm⁻¹)	: 3480, 2989, 1651, 1455, 1249, 1056, 898.
¹H NMR (200 MHz, CDCl ₃)	: δ 1.37 (s, 3H), 1.59 (s, 3H), 3.02 (s, 1H), 3.80 (s, 3H), 4.00–4.05 (m, 2H), 4.31 (d, <i>J</i> = 3.7 Hz, 1H), 4.53 (ddd, <i>J</i> = 0.7, 2.1, 12.5 Hz, 1H), 5.06 (d, <i>J</i> = 1.9 Hz, 1H), 5.75 (d, <i>J</i> = 3.7 Hz, 1H), 6.83 (d, <i>J</i> = 8.9 Hz, 2H), 7.52 (d, <i>J</i> = 8.9 Hz, 2H).
¹³C NMR (75 MHz, CDCl ₃)	: δ 26.8 (q), 27.0 (q), 55.2 (q), 63.5 (t), 71.7 (d), 77.3 (d), 83.5 (s), 93.3 (d), 104.2 (d), 112.8 (s), 113.5 (d, 2C), 126.6 (d, 2C), 126.8 (s), 155.2 (s), 160.4 (s).
Elemental Analysis	: Calcd: C, 63.74; H, 6.29. Found: C, 63.53; H, 6.47.
ESI-MS <i>m/z</i>	: 343.18 [M+Na] ⁺

1,2-*O*-isopropylidene-3-*C*-[1'-hydroxy-2'-(4-nitro-phenyl)-1'-(*Z*)-enyl]-1',5-anhydro- α -D-ribo-furanose (99**):**

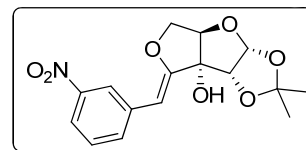


A solution of alkyne **74** (50 mg, 0.15 mmol) and PdCl₂(CH₃CN)₂ (4 mg, 15 μmol) in CH₃CN (6 mL) was stirred under Argon atmosphere at 25 °C for 12 h. After completion of reaction the reaction mixture was concentrated and purified by column chromatography (35% EtOAc in light petroleum) to afford **99** (40 mg, 80%) as yellow crystalline solid.

M.P.	: 220.4 °C
Mol. Formula	: C ₁₆ H ₁₇ NO ₇

Mol. Weight	: 335.31
$[\alpha]_D^{25}$: +42.9 (<i>c</i> 1, CHCl ₃)
IR (CHCl₃, cm⁻¹)	: 3458, 3019, 1674, 1592, 1508, 1344, 1257, 1150, 1060, 878.
¹H NMR (200 MHz, CDCl₃)	: δ 1.43 (s, 3H), 1.63 (s, 3H), 3.34 (s, 1H), 4.42 (dd, <i>J</i> = 2.8, 10.8 Hz, 1H), 4.51 (d, <i>J</i> = 2.8 Hz, 1H), 4.54 (d, <i>J</i> = 10.8 Hz, 1H), 4.62 (d, <i>J</i> = 3.9 Hz, 1H), 5.61 (s, 1H), 5.91 (d, <i>J</i> = 3.9 Hz, 1H), 7.70 (d, <i>J</i> = 8.9 Hz, 2H), 8.14 (d, <i>J</i> = 8.9 Hz, 2H).
¹³C NMR (50 MHz, CDCl₃)	: δ 26.9 (q), 27.0 (q), 74.2 (t), 82.7 (d), 83.2 (d), 87.5 (s), 101.3 (d), 105.7 (d), 113.5 (s), 123.7 (d, 2C), 128.4 (d, 2C), 142.1 (s), 145.4 (s), 159.8 (s).
Elemental Analysis	: Calcd: C, 57.30; H, 5.11, N; 4.18. Found C, 57.19; H, 5.24; N, 4.01.
ESI-MS <i>m/z</i>	: 358.15 [M+Na] ⁺

1,2-*O*-isopropylidene-3-*C*-[1'-hydroxy-2'-(3-nitro-phenyl)-(Z)-enyl]-1',5-anhydro- α -D-ribo-furanose (100**):**



Alkyne **75** (50 mg, 0.15 mmol) and PdCl₂(CH₃CN)₂ (4 mg, 15 μ mol) were taken in CH₃CN (5 mL) and stirred under Argon for 12 h. After completion of reaction the reaction mixture was concentrated and purified by column chromatography (30% ethyl acetate in light petroleum) to obtain **100** (32 mg, 64%) as yellow syrup.

Mol. Formula	: C ₁₆ H ₁₇ NO ₇
Mol. Weight	: 335.31
$[\alpha]_D^{25}$: +16.4 (<i>c</i> 1.8, CHCl ₃)
IR (CHCl₃, cm⁻¹)	: 3502, 3021, 2991, 1673, 1528, 1459, 1376, 1351, 1165, 1085, 1012, 876.
¹H NMR (400 MHz, CDCl₃)	: δ 1.42 (s, 3H), 1.62 (s, 3H), 3.32 (s, 1H), 4.42 (dd, <i>J</i> = 2.8, 10.6 Hz, 1H), 4.50 (m, 1H), 4.52 (d, <i>J</i> = 10.6 Hz, 1H), 4.62 (d, <i>J</i> = 3.8 Hz, 1H), 5.59 (s, 1H), 5.91 (d, <i>J</i> =

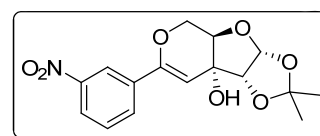
3.8 Hz, 1H), 7.42 (t, $J = 7.9$ Hz, 1H), 7.84 (d, $J = 7.9$ Hz, 1H), 7.98 (ddd, $J = 0.8, 2.0, 8.2$ Hz, 1H), 8.46 (s, 1H).

^{13}C NMR : δ 26.9 (q), 27.0 (q), 73.9 (t), 82.8 (d), 83.4 (d), 87.3 (s),
(100 MHz, CDCl_3) 100.9 (d), 105.7 (d), 113.4 (s), 120.7 (d), 122.6 (d), 128.9
(d), 133.8 (d), 136.9 (s), 148.4 (s), 158.4 (s).

Elemental Analysis : Calcd: C, 57.31; H, 5.11; N, 4.18.
Found: C, 57.22; H, 5.03; N, 4.09.

ESI-MS m/z : 358.15 $[\text{M}+\text{Na}]^+$

1,2-*O*-isopropylidene-3-*C*-[2'-hydroxy-2'-(3-nitro-phenyl)-1'-(*Z*)-enyl]-2',5-anhydro- α -D-ribo-furanose (101**):**



Further elution (35% ethyl acetate in light petroleum) gave **101** (7 mg, 14%) as a colorless oil.

Mol. Formula : $\text{C}_{16}\text{H}_{17}\text{NO}_7$

Mol. Weight : 335.31

$[\alpha]_D^{25}$: -41.5 (c 0.5, CHCl_3)

IR (CHCl_3 , cm^{-1}) : 3478, 3019, 2927, 2855, 1654, 1533, 1451, 1350, 1118, 1057, 1020, 874.

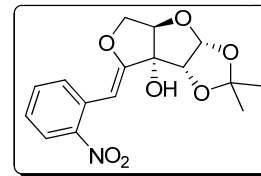
^1H NMR : δ 1.40 (s, 3H), 1.62 (s, 3H), 3.14 (s, 1H), 4.09 (s, 1H),
(400 MHz, CDCl_3) 4.11 (d, $J = 12.5$ Hz, 1H), 4.39 (d, $J = 3.7$ Hz, 1H), 4.62
(br d, $J = 12.5$ Hz, 1H), 5.37 (s, 1H), 5.80 (d, $J = 3.7$ Hz, 1H), 7.52 (t, $J = 8.0$ Hz, 1H), 7.93 (d, $J = 7.9$ Hz, 1H), 8.19 (d, $J = 8.0$ Hz, 1H), 8.48 (s, 1H).

^{13}C NMR : δ 26.8 (q), 26.9 (q), 63.9 (t), 71.5 (s), 77.2 (d), 83.1 (d),
(100 MHz, CDCl_3) 97.4 (d), 104.2 (d), 113.1 (s), 120.3 (d), 123.8 (d), 129.3
(d), 130.9 (d), 136.0 (s), 148.4 (s), 153.2 (s).

Elemental Analysis : Calcd: C, 57.31; H 5.11; N, 4.18.
Found: C, 57.19; H, 4.91; N, 3.98.

ESI-MS m/z : 358.12 $[\text{M}+\text{Na}]^+$

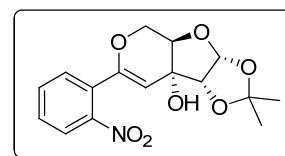
1,2-*O*-isopropylidene-3-*C*-[1'-hydroxy-2'-(2-nitro-phenyl)1'-(*Z*)-enyl]-1',5-anhydro- α -D-ribo-furanose (102**):**



A solution of alkyne **76** (50 mg, 0.15 mmol) and PdCl₂(CH₃CN)₂ (4 mg, 15 μ mol) in CH₃CN (5 mL) was stirred under argon atmosphere for 12 h. After completion of reaction, the reaction mixture was concentrated and purified by column chromatography (40% ethyl acetate in light petroleum) to obtain **102** (30 mg, 60%) as yellow crystalline solid.

M.P.	: 163.4 °C
Mol. Formula	: C ₁₆ H ₁₇ NO ₇
Mol. Weight	: 335.31
[α]_D²⁵	: +17.4 (<i>c</i> 1.5, CHCl ₃)
IR (CHCl₃, cm⁻¹)	: 3401, 3020, 1605, 1522, 1423, 1347, 1165, 1086, 1018.
¹H NMR (200 MHz, CDCl ₃)	: δ 1.35 (s, 3H), 1.54 (s, 3H), 3.24 (s, 1H), 4.32 (d, <i>J</i> = 2.4 Hz, 1H), 4.34 (s, 1H), 4.39 (d, <i>J</i> = 2.4 Hz, 1H), 4.56 (d, <i>J</i> = 3.9 Hz, 1H), 5.82 (d, <i>J</i> = 3.9 Hz, 1H), 6.00 (s, 1H), 7.18 (ddd, <i>J</i> = 1.4, 7.4, 8.2 Hz , 1H), 7.43 (ddd, <i>J</i> = 1.4, 7.6, 8.3 Hz , 1H), 7.78 (dd, <i>J</i> = 1.4, 8.2 Hz , 1H), 8.07 (dd, <i>J</i> = 1.4, 8.1 Hz, 1H).
¹³C NMR (75 MHz, CDCl ₃)	: δ 27.0 (q), 27.1 (q), 73.9 (t), 82.7 (d), 83.3 (d), 87.4 (s), 96.5 (d), 105.7 (d), 113.4 (s), 124.5 (d), 126.5 (d), 129.6 (s), 130.6 (d), 132.4 (d), 147.4 (s), 159.2 (s).
Elemental Analysis	: Calcd: C, 57.31; H 5.11; N, 4.18. Found: C, 57.43; H, 5.25; N, 4.92.
ESI-MS <i>m/z</i>	: 358.10 [M+Na] ⁺

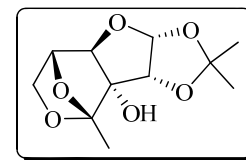
1,2-*O*-isopropylidene-3-*C*-[2'-hydroxy-2'-(2-nitro-phenyl)-1'-(*Z*)-enyl]-2',5-anhydro- α -D-ribo-furanose (103**):**



Further elution (35% ethyl acetate in light petroleum) gave **103** (10 mg, 20%) as colorless oil.

Mol. Formula	: C ₁₆ H ₁₇ NO ₇
Mol. Weight	: 335.31
[α]_D²⁵	: +95.8 (<i>c</i> 0.8, CHCl ₃)
IR (CHCl₃, cm⁻¹)	: 3493, 3020, 2928, 1663, 1609, 1449, 1357, 1100, 999, 897.
¹H NMR (200 MHz, CDCl ₃)	: δ 1.40 (s, 3H), 1.61 (s, 3H), 3.02 (s, 1H), 3.99 (br d, <i>J</i> = 12.1 Hz, 1H), 4.05 (m, 1H), 4.32 (d, <i>J</i> = 3.7 Hz, 1H), 4.43 (ddd, <i>J</i> = 0.8, 1.9, 12.1 Hz, 1H), 4.97 (d, <i>J</i> = 1.9 Hz, 1H), 5.85 (d, <i>J</i> = 3.7 Hz, 1H), 7.44–7.57 (m, 3H), 7.79–7.84 (m, 1H).
¹³C NMR (100 MHz, CDCl ₃)	: δ 26.9 (q), 27.1 (q), 64.6 (t), 71.6 (s), 77.8 (d), 83.2 (d), 100.1 (d), 104.3 (d), 113.0 (s), 124.2 (d), 130.0 (d), 130.3 (d), 130.5 (s), 132.2 (d), 148.9 (s), 154.2 (s).
Elemental Analysis	: Calcd: C, 57.31; H, 5.11; N, 4.18. Found: C, 57.51; H, 4.95; N, 4.30.
ESI-MS <i>m/z</i>	: 358.04 [M+Na] ⁺

1,2-*O*-isopropylidene-[3-*C*,5-*O*,6-*O*(methoxymethylidene)]-α-*D*-allo-furanose (104**):**



A solution of **85** (50 mg, 0.20 mmol) and PdCl₂(CH₃CN)₂ (5 mg, 20 μmol) in CH₃CN (4 mL) was stirred at 25 °C for 10 h under argon atmosphere. The reaction mixture was concentrated and chromatographed on silica gel (40% ethyl acetate in light petroleum) to obtain **104** (44 mg, 87%) as a solid.

M.P.	: 159 °C
Mol. Formula	: C ₁₁ H ₁₆ O ₆
Mol. Weight	: 244.24
[α]_D²⁵	: -40.1 (<i>c</i> 1, CHCl ₃)

IR (CHCl₃, cm⁻¹) : 3491, 2995, 2942, 1456, 1378, 1239, 1216, 1160, 1100, 1009, 936.

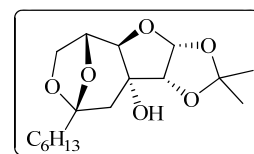
¹H NMR (200 MHz, CDCl₃) : δ 1.40 (s, 3H), 1.56 (s, 6H), 3.19 (s, 1H), 3.60–3.69 (m, 2H), 4.16 (s, 1H), 4.32 (d, *J* = 4.0 Hz, 1H), 4.50 (br d, *J* = 3.2 Hz, 1H), 5.86 (d, *J* = 4.0 Hz, 1H).

¹³C NMR (75 MHz, CDCl₃) : δ 13.4 (q), 27.4 (q, 2C), 64.9 (t), 81.6 (d), 81.9 (d), 88.0 (s), 88.7 (d), 107.1 (d), 107.6 (s), 114.0 (s).

Elemental Analysis : Calcd: C, 54.09; H, 6.60.
Found: C, 53.88; H, 6.69.

ESI-MS *m/z* : 267.10 [M+Na]⁺

1,2-*O*-isopropylidene-3-*C*-(2'-oxooctyl)- α -D-*allo*-furanose-(2'-*C*,5-*O*,6-*O*)-ketal (105):



Compound **105** was prepared as described earlier by treating **86** (200 mg, 0.61 mmol) with PdCl₂(CH₃CN)₂ (15 mg, 61 μ mol) in dry CH₃CN (10 mL) under argon at 25 °C for 24 h, followed by chromatography on silica gel (30% ethyl acetate in light petroleum) to obtain **105** (50 mg, 55%) based on recovered **86** (110 mg).

Mol. Formula : C₁₇H₂₈O₆

Mol. Weight : 328.40

[α]_D²⁵ : -1.2 (*c* 0.8, CHCl₃)

IR (CHCl₃, cm⁻¹) : 3406, 3019, 2957, 2927, 1495, 1457, 1384, 1164, 1100, 1081, 1050, 695.

¹H NMR (500 MHz, CDCl₃) : δ 0.86 (t, *J* = 6.7 Hz, 3H), 1.23–1.31 (m, 6H), 1.35 (s, 3H), 1.39–1.44 (m, 2H), 1.57 (s, 3H), 1.60 (d, *J* = 14.5 Hz, 1H), 1.69–1.72 (m, 2H), 1.93 (d, *J* = 14.5 Hz, 1H), 3.05 (br s, 1H), 3.75 (s, 1H), 3.80 (dd, *J* = 5.7, 7.2 Hz, 1H), 4.09 (d, *J* = 3.7 Hz, 1H), 4.17 (d, *J* = 7.3 Hz, 1H), 4.67 (br d, *J* = 5.2 Hz, 1H), 5.85 (d, *J* = 3.7 Hz, 1H).

¹³C NMR (125 MHz, CDCl₃) : δ 14.1 (q), 22.5 (t), 22.6 (t), 26.7 (q), 26.9 (q), 29.4 (t), 31.7 (t), 37.2 (t), 40.9 (t), 65.5 (t), 73.8 (d), 75.0 (s), 78.1

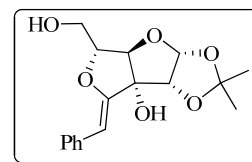
(d), 84.0 (d), 104.0 (d), 107.0 (s), 112.8 (s).

Elemental Analysis : Calcd: C, 62.17; H, 8.59.

Found: C, 62.46; H, 8.71.

ESI-MS m/z : 351.19 [M+Na]⁺

1,2-*O*-isopropylidene-3-*C*-(1'-hydroxy-2'-phenyl-1'-(*Z*)-enyl)-1',5-anhydro- α -D-*allo*-furanose (106**):**



87 (100 mg, 0.31 mmol) and PdCl₂(CH₃CN)₂ (8 mg, 31 μ mol) in dry CH₃CN (6 mL) were stirred under argon for 7 h at 25 °C. The reaction mixture was concentrated and purified on silica gel (10% ethyl acetate in light petroleum) to obtain **106** (30 mg, 30%) as colorless oil and **107** (65 mg, 65%) as yellow solid.

Mol. Formula : C₁₇H₂₀O₆

Mol. Weight : 320.34

[α]_D²⁵ : +24.9 (*c* 1.3, CHCl₃)

IR (CHCl₃, cm⁻¹) : 3415, 2928, 2854, 1751, 1671, 1599, 1494, 1449, 1375, 1083, 1023, 872, 696.

¹H NMR (200 MHz, CDCl₃) : δ 1.41 (s, 3H), 1.62 (s, 3H), 3.83 (dd, *J* = 4.3, 12.1 Hz, 1H), 3.91 (dd, *J* = 4.0, 12.1 Hz, 1H), 4.22 (br s, 1H), 4.47 (s, 1H), 4.60 (t, *J* = 4.2 Hz, 1H), 4.64 (d, *J* = 3.6 Hz, 1H), 5.50 (s, 1H), 5.85 (d, *J* = 3.6 Hz, 1H), 7.11–7.19 (m, 1H), 7.26–7.33 (m, 2H), 7.55–7.59 (m, 2H).

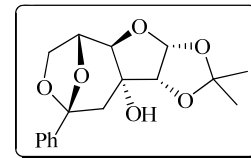
¹³C NMR (75 MHz, CDCl₃) : δ 27.1 (q), 27.3 (q), 62.6 (t), 83.8 (d), 85.6 (d), 86.1 (d), 86.7 (s), 102.7 (d), 105.8 (d), 113.5 (s), 126.3 (d), 128.2 (d), 128.3 (d, 3C), 135.3 (s), 156.8 (s).

Elemental Analysis : Calcd: C, 63.74; H, 6.29.

Found: C, 64.01; H, 6.54.

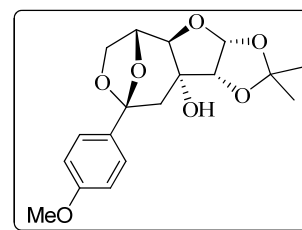
ESI-MS m/z : 343.11 [M+Na]⁺

1,2-*O*-isopropylidene-3-*C*-(2'-oxo-2'-phenylethyl)- α -D-*allo*-furanose-(2'-*C*,5-*O*,6-*O*)-ketal (107):



- M.P.** : 123 °C
- Mol. Formula** : C₁₇H₂₀O₆
- Mol. Weight** : 320.34
- [α]_D²⁵** : -2.2 (*c* 1, CHCl₃)
- IR (CHCl₃, cm⁻¹)** : 3515, 2986, 2899, 1450, 1384, 1374, 1053, 1011, 890, 872, 700.
- ¹H NMR** (200 MHz, CDCl₃) : δ 1.31 (s, 3H), 1.55 (s, 3H), 1.82 (d, *J* = 14.7 Hz, 1H), 2.20 (d, *J* = 14.7 Hz, 1H), 3.10 (br s, 1H), 3.78 (s, 1H), 3.91 (dd, *J* = 5.3, 7.3 Hz, 1H), 4.06 (d, *J* = 3.7 Hz, 1H), 4.28 (d, *J* = 7.3 Hz, 1H), 4.81 (d, *J* = 5.3 Hz, 1H), 5.82 (d, *J* = 3.7 Hz, 1H), 7.24–7.32 (m, 3H), 7.49–7.52 (m, 2H).
- ¹³C NMR** (75 MHz, CDCl₃) : δ 26.7 (q), 27.0 (q), 43.3 (t), 65.6 (t), 74.3 (d), 75.2 (s), 78.1 (d), 84.1 (d), 104.2 (d), 106.2 (s), 112.9 (s), 125.1 (d, 2C), 128.2 (d, 2C), 128.5 (d), 139.9 (s).
- Elemental Analysis** : Calcd: C, 63.74; H, 6.29.
Found: C, 63.99; H, 6.48.
- ESI-MS *m/z*** : 343.12 [M+Na]⁺

1,2-*O*-isopropylidene-3-*C*-[2'-oxo-2'-(4-methoxyphenyl)ethyl]- α -D-*allo*-furanose-(2'-*C*,5-*O*,6-*O*)-ketal (108):

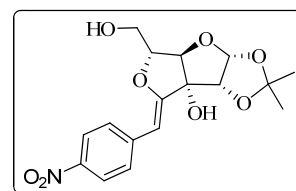


A solution of **88** (50 mg, 0.14 mmol) and PdCl₂(CH₃CN)₂ (4 mg, 14 μ mol) in dry CH₃CN (4 mL) was stirred at 25 °C for 3 h and concentrated. The residue was purified on silica gel by (50% ethyl acetate in light petroleum) to give **108** (41 mg, 82%) as white solid.

- M.P.** : 168 °C

Mol. Formula	: C ₁₈ H ₂₂ O ₇
Mol. Weight	: 350.36
[α]_D²⁵	: +2.5 (c 1.25, CHCl ₃)
IR (CHCl₃, cm⁻¹)	: 3019, 1516, 1249, 1177, 1084, 1052, 873, 802, 669.
¹H NMR (200 MHz, CDCl ₃)	: δ 1.37 (s, 3H), 1.60 (s, 3H), 1.89 (d, <i>J</i> = 14.7 Hz, 1H), 2.27 (d, <i>J</i> = 14.7 Hz, 1H), 3.17 (s, 1H), 3.79 (s, 3H), 3.84 (br s, 1H), 3.98 (dd, <i>J</i> = 5.7, 7.2 Hz, 1H), 4.13 (br d, <i>J</i> = 3.7 Hz, 1H), 4.33 (dd, <i>J</i> = 0.8, 7.3 Hz, 1H), 4.87 (br d, <i>J</i> = 5.4 Hz, 1H), 5.91 (d, <i>J</i> = 3.7 Hz, 1H), 6.86 (d, <i>J</i> = 8.9 Hz, 2H), 7.48 (d, <i>J</i> = 8.9 Hz, 2H).
¹³C NMR (50 MHz, CDCl ₃)	: δ 26.6 (q), 26.9 (q), 43.0 (t), 55.2 (q), 65.6 (t), 74.2 (d), 75.2 (s), 77.8 (d), 83.8 (d), 104.0 (d), 106.1 (s), 112.9 (s), 113.5 (d, 2C), 126.4 (d, 2C), 132.1 (s), 159.7 (s).
Elemental Analysis	: Calcd: C, 61.71; H, 6.33. Found: C, 61.77; H, 6.22.
ESI-MS <i>m/z</i>	: 373.11 [M+Na] ⁺

1,2-*O*-isopropylidene-3-*C*-[1'-hydroxy-2'-(4-nitro-phenyl)-1'-(*Z*)-enyl]-1',5-anhydro- α -D-*allo*-furanose (109**):**



89 (100 mg, 0.27 mmol) and PdCl₂(CH₃CN)₂ (7 mg, 27 μmol) in dry CH₃CN (4 mL) were stirred under argon atmosphere at 25 °C for 5 h and concentrated. The residue was purified on silica gel (50% ethyl acetate in light petroleum) to obtain **109** (87 mg, 87%) as a yellow oil.

Mol. Formula	: C ₁₇ H ₁₉ NO ₈
Mol. Weight	: 365.33
[α]_D²⁵	: +33.8 (c 1.5, CHCl ₃)
IR (CHCl₃, cm⁻¹)	: 3437, 3020, 2938, 1781, 1661, 1593, 1513, 1376, 1341, 1216, 1165, 1086, 1027, 861.
¹H NMR	: δ 1.40 (s, 3H), 1.61 (s, 3H), 3.14 (br s, 1H), 3.88 (dd, <i>J</i> =

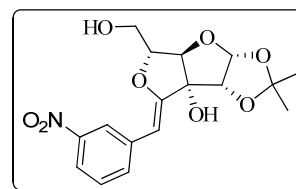
(200 MHz, CDCl₃) 3.7, 12.1 Hz, 1H), 4.01 (dd, $J = 3.6, 12.1$ Hz, 1H), 4.50 (s, 2H), 4.64 (d, $J = 3.7$ Hz, 1H), 4.69 (t, $J = 3.7$ Hz, 1H), 5.52 (s, 1H), 5.84 (d, $J = 3.7$ Hz, 1H), 7.61 (d, $J = 8.9$ Hz, 2H), 8.01 (d, $J = 8.9$ Hz, 2H).

¹³C NMR (50 MHz, CDCl₃) : δ 27.0 (q), 27.2 (q), 62.5 (t), 83.5 (d), 85.2 (d), 87.0 (s), 87.2 (d), 100.4 (d), 105.6 (d), 113.8 (s), 123.7 (d, 2C), 128.3 (d, 2C), 142.3 (s), 145.1 (s), 161.4 (s).

Elemental Analysis : Calcd: C, 55.89; H, 5.24; N, 3.83.
Found: C, 56.08; H, 5.16; N, 3.71.

ESI-MS m/z : 388.12 [M+Na]⁺

1,2-*O*-isopropylidene-3-*C*-[1'-hydroxy-2'-(3-nitrophenyl)-*E*-vinyl]-1',5-anhydro- α -D-*allo*-furanose (110**):**



The reaction of **90** (100 mg, 0.27 mmol) and PdCl₂ (CH₃CN)₂ (7 mg, 27 μ mol) in dry CH₃CN (4 mL) was carried out as described earlier to procure **110** (65 mg, 65%) and **111** (18 mg, 18%).

Mol. Formula : C₁₇H₁₉NO₈

Mol. Weight : 365.33

[α]_D²⁵ : +7.4 (*c* 1.5, CHCl₃)

IR (CHCl₃, cm⁻¹) : 3535, 3020, 1609, 1529, 1384, 1346, 1164, 1083, 842.

¹H NMR (200 MHz, CDCl₃) : δ 1.40 (s, 3H), 1.61 (s, 3H), 3.03 (br s, 1H), 3.88 (dd, $J = 3.8, 12.1$ Hz, 1H), 4.0 (dd, $J = 3.3, 12.1$ Hz, 1H), 4.50 (s, 1H), 4.51 (s, 1H), 4.64 (d, $J = 3.7$ Hz, 1H), 4.69 (t, $J = 3.8$ Hz, 1H), 5.53 (s, 1H), 5.84 (d, $J = 3.7$ Hz, 1H), 7.39 (t, $J = 8.0$ Hz, 1H), 7.79 (dt, $J = 1.3, 7.8$ Hz, 1H), 7.92 (ddd, $J = 1.0, 2.3, 8.2$ Hz, 1H), 8.42 (t, $J = 1.9$ Hz, 1H).

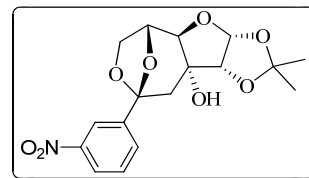
¹³C NMR (50 MHz, CDCl₃) : δ 27.0 (q), 27.2 (q), 62.5 (t), 83.5 (d), 85.3 (d), 86.7 (d), 86.8 (s), 100.1 (d), 105.6 (d), 113.8 (s), 120.6 (d), 122.6 (d), 129.0 (d), 133.8 (d), 137.0 (s), 148.3 (s), 159.7 (s).

Elemental Analysis : Calcd: C, 55.89; H, 5.24; N, 3.83.

Found: C, 55.85; H, 5.43; N, 3.87.

ESI-MS m/z : 388.09 [M+Na]⁺

1,2-*O*-isopropylidene-3-*C*-[2'-oxo-2'-(3-nitrophenyl)-*E*-ethyl]- α -*D*-allo-furanose-(2'-*C*,5-*O*,6-*O*)-ketal (111):



Mol. Formula : C₁₇H₁₉NO₈

Mol. Weight : 365.33

[α]_D²⁵ : +3.7 (*c* 0.8, CHCl₃)

IR (CHCl₃, cm⁻¹) : 3400, 3020, 1533, 1385, 1352, 1165, 1084, 1053, 992, 890.

¹H NMR (500 MHz, CDCl₃) : δ 1.39 (s, 3H), 1.62 (s, 3H), 1.90 (d, *J* = 14.6 Hz, 1H), 2.28 (d, *J* = 14.6 Hz, 1H), 3.18 (s, 1H), 3.85 (s, 1H), 4.01 (dd, *J* = 5.9, 7.0 Hz, 1H), 4.14 (d, *J* = 3.7 Hz, 1H), 4.40 (d, *J* = 7.3 Hz, 1H), 4.92 (br d, *J* = 5.4 Hz, 1H), 5.94 (d, *J* = 3.7 Hz, 1H), 7.55 (t, *J* = 8.0 Hz, 1H), 7.91 (d, *J* = 7.7 Hz, 1H), 8.21 (dd, *J* = 1.6, 8.0 Hz, 1H), 8.46 (br t, *J* = 1.6 Hz, 1H).

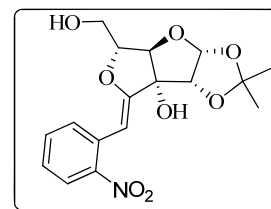
¹³C NMR (125 MHz, CDCl₃) : δ 26.8 (q), 26.9 (q), 43.0 (t), 65.9 (t), 74.5 (d), 75.2 (s), 77.9 (d), 83.7 (d), 104.2 (d), 105.3 (s), 113.1 (s), 120.8 (d), 123.6 (d), 129.3 (d), 131.4 (d), 141.9 (s), 148.3 (s).

Elemental Analysis : Calcd: C, 55.89; H, 5.24; N, 3.83.

Found: C, 56.17; H, 5.53; N, 3.48.

ESI-MS m/z : 388.08 [M+Na]⁺

1,2-*O*-isopropylidene-3-*C*-[1'-hydroxy-2'-(2-nitrophenyl)-*E*-vinyl]-1',5-anhydro- α -*D*-allo-furanose (112):

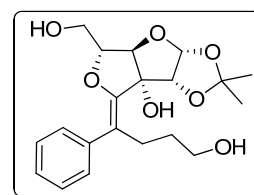


A solution of **91** (50 mg, 0.137 mmol) and PdCl₂(CH₃CN)₂ (4 mg, 14 μ mol) in dry CH₃CN (4 mL) was stirred under argon atmosphere for 5 h at 25 °C. The reaction

mixture was concentrated and the residue chromatographed on silica (30% ethyl acetate in light petroleum) to obtain **112** (36 mg, 72%) as yellow oil.

Mol. Formula	: C ₁₇ H ₁₉ NO ₈
Mol. Weight	: 365.33
[α]_D²⁵	: +76.9 (c 0.5, CHCl ₃)
IR (CHCl₃, cm⁻¹)	: 3435, 3020, 1729, 1662, 1523, 1376, 1346, 1165, 1085, 1027, 873.
¹H NMR (200 MHz, CDCl ₃)	: δ 1.42 (s, 3H), 1.62 (s, 3H), 3.88 (dd, <i>J</i> = 4.3, 12.1 Hz, 1H), 3.96 (dd, <i>J</i> = 3.8, 12.1 Hz, 1H), 4.49 (br s, 1H), 4.62 (t, <i>J</i> = 4.2 Hz, 1H), 4.69 (d, <i>J</i> = 3.7 Hz, 1H), 5.89 (d, <i>J</i> = 3.7 Hz, 1H), 6.00 (s, 1H), 7.27 (ddd, <i>J</i> = 1.4, 7.4, 8.4 Hz, 1H), 7.52 (ddd, <i>J</i> = 1.4, 7.6, 8.9 Hz, 1H), 7.83 (dd, <i>J</i> = 1.3, 8.2 Hz, 1H), 7.99 (dd, <i>J</i> = 1.3, 8.0 Hz, 1H).
¹³C NMR (75 MHz, CDCl ₃)	: δ 27.0 (q), 27.2 (q), 62.6 (t), 83.5 (d), 85.4 (d), 86.9 (s), 86.9 (d), 96.2 (d), 105.8 (d), 113.8 (s), 124.5 (d), 126.7 (d), 129.6 (s), 130.9 (d), 132.4 (d), 147.7 (s), 160.0 (s).
Elemental Analysis	: Calcd: C, 55.89; H, 5.24; N, 3.83. Found: C, 55.91; H, 5.39; N, 3.73.
ESI-MS <i>m/z</i>	: 388.11 [M+Na] ⁺

1,2-*O*-isopropylidene-3-*C*-[(*Z*)1'-hydroxy-2'-phenyl(hydroxy propyl)-1'-enyl]-1',5-anhydro- α -D-*allo*-furanose (113**):**

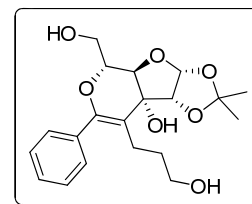


Alkyne **87** (1 g, 3.12 mmol) was taken in CH₃CN in argon atmosphere and cooled to 0 °C. LiBr (542 mg, 6.24 mmol) was added followed by Pd(CH₃CN)₂Cl₂ (81 mg, 0.31 mmol) while stirring. Freshly distilled acrolein (2 mL, 31.2 mmol) was added to it. After completion of reaction the reaction mixture was concentrated and purified by column chromatography to get two major products, which were then reduced with LAH to get **113** (190 mg, 16%) and **114** (450 mg, 38%).

Mol. Formula	: C ₂₀ H ₂₆ O ₇
---------------------	--

Mol. Weight	: 378.42
$[\alpha]_D^{25}$: -39.8 (<i>c</i> 0.1, CHCl ₃)
IR (CHCl₃, cm⁻¹)	: 3500, 3019, 2927, 1384, 1083, 669.
¹H NMR (200 MHz, CDCl ₃)	: δ 1.38–1.43 (m, 1H), 1.43 (s, 3H), 1.57–1.63 (m, 1H), 1.63 (s, 3H), 2.58–2.63 (m, 1H), 2.71–2.78 (m, 1H), 3.46– 3.50 (m, 3H), 3.54–3.62 (m, 1H), 3.85 (d, <i>J</i> = 4.7 Hz, 2H), 4.32 (br t, <i>J</i> = 4.5 Hz, 1H), 4.52 (s, 1H), 4.87 (d, <i>J</i> = 3.6 Hz, 1H), 5.93 (d, <i>J</i> = 3.6 Hz, 1H), 7.16–7.21 (m, 1H), 7.28–7.37 (m, 4H).
¹³C NMR (125 MHz, CDCl ₃)	: δ 25.1 (t), 27.2 (q), 27.2 (q), 29.3 (t), 59.9 (t), 62.3 (t), 83.2 (d), 83.6 (d), 85.5 (s), 87.9 (d), 106.2 (d), 112.9 (s), 113.4 (s), 126.5 (d), 128.1 (d, 2C), 128.5 (d, 2C), 137.8 (s), 152.4 (s).
Elemental Analysis	: Calcd: C, 63.48; H, 6.93. Found: C, 63.60; H, 6.97.
ESI-MS <i>m/z</i>	: 401.13 [M+Na] ⁺

1,2-*O*-isopropylidene-3-*C*-[(*Z*)1'-hydroxypropyl-2'-hydroxy-phenyl-1-enyl]-1',5-anhydro- α -D-*allo*-furanose (114):



Mol. Formula	: C ₂₀ H ₂₆ O ₇
Mol. Weight	: 378.42
$[\alpha]_D^{25}$: -15.72 (<i>c</i> 0.5, CHCl ₃)
IR (CHCl₃, cm⁻¹)	: 3429, 2926, 2853, 1726, 1651, 1446, 1375, 1164, 1050, 1008, 874, 701.
¹H NMR (500 MHz, CDCl ₃)	: δ 1.20–1.26 (m, 1H), 1.41 (s, 3H), 1.43–1.47 (m, 1H), 1.63 (s, 3H), 2.13 (ddd, <i>J</i> = 7.2, 8.9, 15.0 Hz, 1H), 2.53 (ddd, <i>J</i> = 5.1, 7.0, 15.0 Hz, 1H), 2.67 (br s, 1H), 3.38 (dt, <i>J</i> = 5.1, 11.1 Hz, 1H), 3.47 (ddd, <i>J</i> = 4.1, 8.8, 11.1 Hz, 1H), 3.90 (dd, <i>J</i> = 5.1, 12.0 Hz, 1H), 3.98 (s, 1H), 4.08

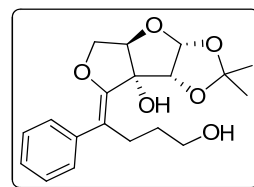
(dd, $J = 6.8, 12.0$ Hz, 1H), 4.23 (s, 1H), 4.52–4.53 (m, 1H), 4.53 (d, $J = 3.8$ Hz, 1H), 5.87 (d, $J = 3.8$ Hz, 1H), 7.32–7.37 (m, 5H).

^{13}C NMR (125 MHz, CDCl_3) : δ 22.6 (t), 26.8 (q), 27.0 (q), 31.2 (t), 60.4 (t), 60.9 (t), 74.2 (d), 74.6 (s), 78.8 (d), 81.5 (d), 104.0 (s), 104.1 (d), 113.0 (s), 128.4 (d, 2C), 128.7 (d, 2C), 128.9 (d), 135.9 (s), 151.9 (s).

Elemental Analysis : Calcd: C, 63.48; H, 6.93.
Found: C, 63.15; H, 6.79.

ESI-MS m/z : 401.16 $[\text{M}+\text{Na}]^+$

1,2-*O*-isopropylidene-3-*C*-[(*Z*)1'-hydroxy-2'-phenyl-hydroxy propyl-1-enyl]-1',5-anhydro- α -D-ribo-furanose (115**):**



Alkyne **72** (135 mg, 0.47 mmol) was taken in CH_3CN in argon atmosphere and cooled to 0°C . LiBr (80 mg, 0.93 mmol) was added followed by $\text{Pd}(\text{CH}_3\text{CN})_2\text{Cl}_2$ (12 mg, 46 μmol) while stirring. Freshly distilled acrolein (0.31 mL, 4.6 mmol) was added to it. After completion of reaction the reaction mixture was concentrated and purified by column chromatography to get two major products, which were then reduced with LAH to get **115** (37 mg, 23%) and **116** (85 mg, 53%).

Mol. Formula : $\text{C}_{19}\text{H}_{24}\text{O}_6$

Mol. Weight : 348.39

$[\alpha]_D^{25}$: -75.38 (c 1.25, CHCl_3)

IR (CHCl_3 , cm^{-1}) : 3470, 3019, 1384, 1164, 1121, 1086, 965, 877, 701, 669.

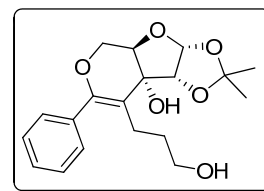
^1H NMR (500 MHz, CDCl_3) : δ 1.36–1.43 (m, 1H), 1.43 (s, 3H), 1.59–1.65 (m, 1H), 1.62 (s, 3H), 2.64 (ddd, $J = 4.5, 5.5, 14.4$ Hz, 1H), 2.76 (ddd, $J = 5.5, 10.8, 14.4$ Hz, 1H), 3.47 (dt, $J = 4.2, 11.3$ Hz, 1H), 3.58 (dt, $J = 3.1, 11.0$ Hz, 1H), 4.13 (br s, 2H), 4.50 (s, 1H), 4.83 (d, $J = 3.9$ Hz, 1H), 5.91 (d, $J = 3.9$ Hz, 1H), 7.17 (tt, $J = 1.3, 7.3$ Hz, 1H), 7.28–7.31 (m, 2H), 7.35–7.37 (m, 2H).

^{13}C NMR : δ 25.2 (t), 27.2 (q), 27.3 (q), 29.6 (t), 59.9 (t), 71.6 (t),
(125 MHz, CDCl_3) 82.6 (d), 85.9 (s), 86.4 (d), 106.3 (d), 113.2 (s), 114.0 (s),
126.6 (d), 128.1 (d, 2C), 128.5 (d, 2C), 137.7 (s), 151.5
(s).

Elemental Analysis : Calcd: C, 65.50; H, 6.94.
Found: C, 65.79; H, 6.80.

ESI-MS m/z : 371.14 $[\text{M}+\text{Na}]^+$

**1,2-*O*-isopropylidene-3-*C*-[(*Z*)1'-hydroxypropyl-2'-phenyl-
hydroxy-1-enyl]-1',5-anhydro- α -D-ribo-furanose (116):**



Mol. Formula : $\text{C}_{19}\text{H}_{24}\text{O}_6$

Mol. Weight : 348.39

$[\alpha]_D^{25}$: -44.75 (c 2.5, CHCl_3)

IR (CHCl_3 , cm^{-1}) : 3461, 3019, 1384, 1084, 928, 669.

^1H NMR : δ 1.41 (s, 3H), 1.42–1.48 (m, 1H), 1.57–1.61 (m, 1H),
(500 MHz, CDCl_3) 1.61 (s, 3H), 2.14 (ddd, $J = 6.7, 9.7, 15.3$ Hz, 1H), 2.56
(ddd, $J = 4.8, 6.9, 14.9$ Hz, 1H), 3.37 (dt, $J = 4.8, 11.3$
Hz, 1H), 3.52 (ddd, $J = 3.8, 9.2, 11.3$ Hz, 1H), 3.67 (br s,
1H), 3.96 (d, $J = 11.8$ Hz, 1H), 4.09 (br s, 1H), 4.40 (dd,
 $J = 1.7, 11.8$ Hz, 1H), 4.50 (d, $J = 3.8$ Hz, 1H), 5.86 (d, J
 $= 3.8$ Hz, 1H), 7.31–7.36 (m, 5H).

^{13}C NMR : δ 22.5 (t), 26.9 (q), 27.0 (q), 31.3 (t), 60.5 (t), 63.3 (t),
(125 MHz, CDCl_3) 75.2 (s), 79.2 (d), 81.2 (d), 104.5 (d), 104.8 (s), 112.9 (s),
128.3 (d, 2C), 128.7 (d, 2C), 128.9 (d), 135.8 (s), 154.4
(s).

Elemental Analysis : Calcd: C, 65.50; H, 6.94.
Found: C, 65.38; H, 7.10.

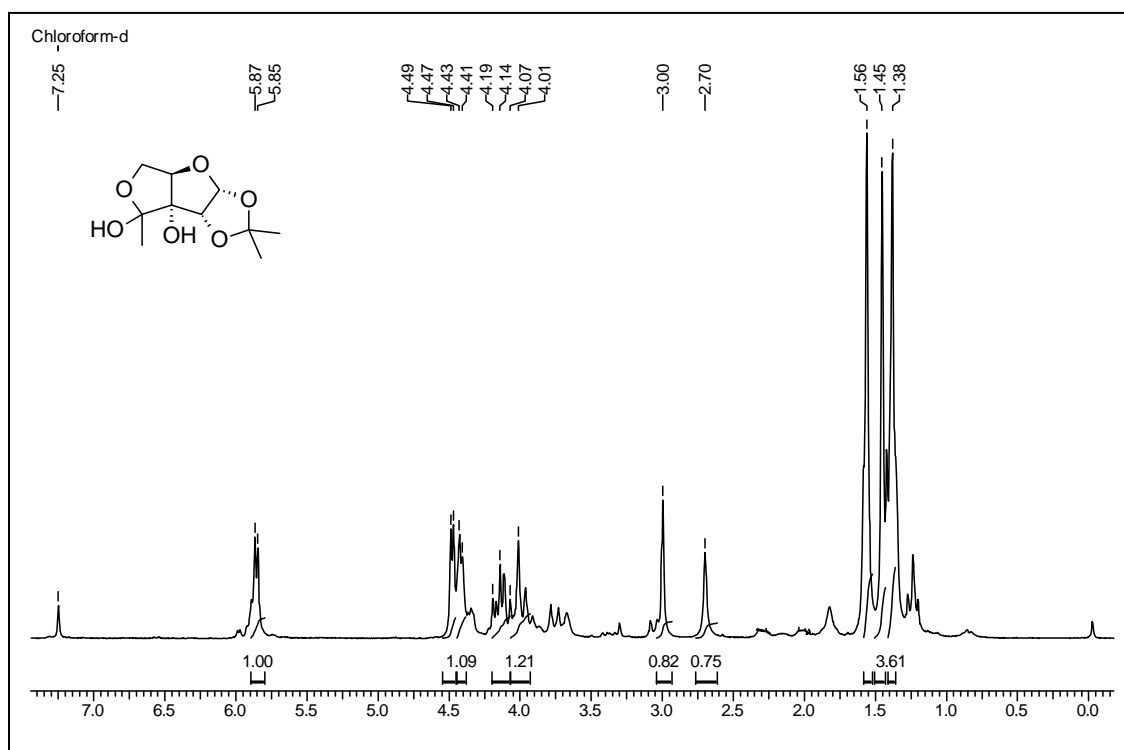
ESI-MS m/z : 371.16 $[\text{M}+\text{Na}]^+$

Crystal data	95	97	99	102
Formula	C ₁₆ H ₂₈ O ₆	C ₁₆ H ₁₈ O ₅	C ₁₆ H ₁₇ NO ₇	C ₁₆ H ₁₇ NO ₇
M _r	316.38	290.30	335.31	335.31
Crystal size, mm	0.92x0.08x0.06	0.73x0.36x0.14	0.56x0.16x0.04	0.43x0.41x0.25
Crystal system	Orthorhombic	Monoclinic	Monoclinic	Monoclinic
Space group	P2 ₁ 2 ₁ 2 ₁	C2	P2 ₁	P2 ₁
a [Å]	5.460(3)	18.566(7)	5.6459(19)	5.6601(6)
b [Å]	10.235(5)	6.108(2)	8.098(3)	9.8552(11)
c [Å]	30.624(14)	12.932(5)	17.191(6)	13.9858(15)
α [°]	90	90	90	90
β [°]	90	99.458(6)	91.759(6)	93.574(2)
γ [°]	90	90	90	90
V [Å ³]	1711.4(13)	1446.5(10)	785.6(5)	778.63(15)
Z	4	4	2	2
F(000)	688	616	352	352
D calc [g cm ⁻³]	1.228	1.333	1.417	1.430
μ [mm ⁻¹]	0.093	0.099	0.112	0.113
Absorption correction	Multi-scan	Multi-scan	Multi-scan	Multi-scan
T _{min} / T _{max}	0.9033/0.9945	0.9310/0.9858	0.9396 / 0.9951	0.9532 / 0.9716
Reflns. collected	15902	5227	5763	3981
Unique reflns.	3000	2498	2776	2451
Observed reflns.	2768	2327	2402	2340
No of parameters	210	196	263	242
R ₁ [I>2σ(I)]	0.0771	0.0309	0.0364	0.0307
WR ₂	0.1407	0.0759	0.0665	0.0763
R ₁ (all data)	0.0849	0.0340	0.0450	0.0323
WR ₂ (all data)	0.1435	0.0777	0.0710	0.0777
goodness-of-fit	1.272	1.068	1.076	1.055
Δρ _{max}	+0.226,-0.161	+0.135, -0.112	+0.130, -0.087	+0.116, -0.140
Δρ _{min} (eÅ ⁻³)				

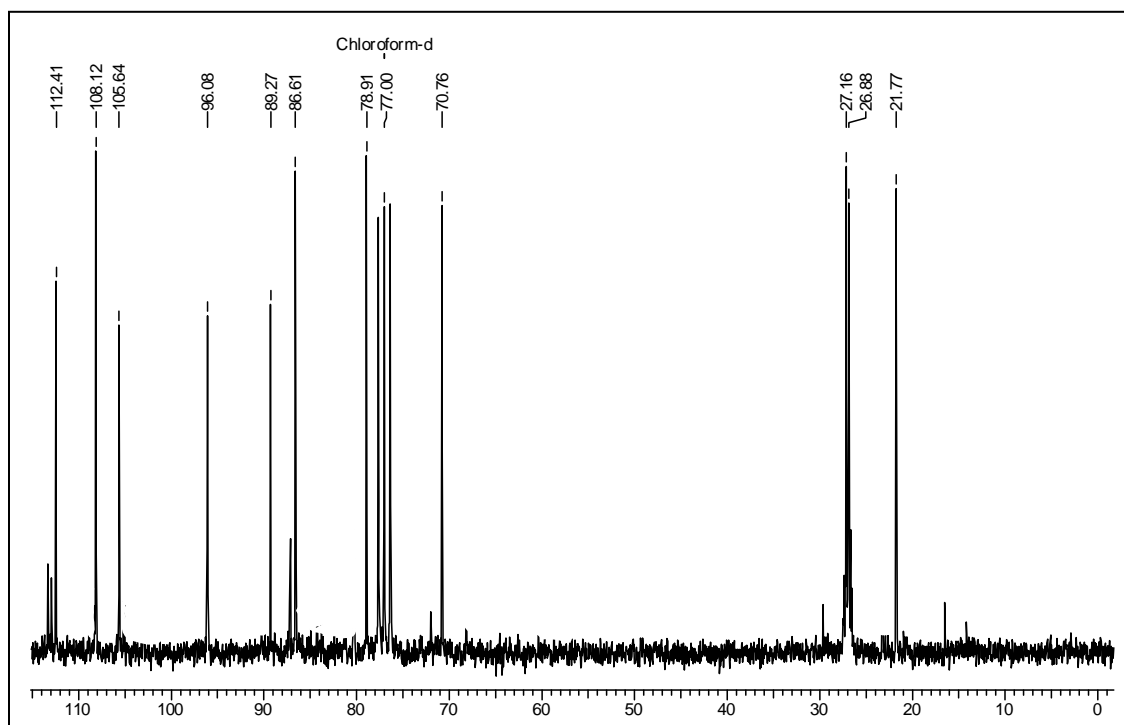
Table 12: Crystal data for compounds 95, 97, 99 and 102

Crystal data	104	107	108
Formula	C ₁₁ H ₁₆ O ₆	C ₁₇ H ₂₀ O ₆	C ₁₈ H ₂₂ O ₇
M _r	244.24	320.33	350.36
Crystal size, mm	0.86x0.49x0.23	0.75x0.43x0.37	0.77x0.56x0.41
Crystal system	Monoclinic	Monoclinic	Orthorhombic
Space group	P2 ₁	P2 ₁	P2 ₁ 2 ₁ 2 ₁
a [Å]	5.633(4)	9.003(3)	5.946(2)
b [Å]	9.792(6)	6.838(2)	14.795(5)
c [Å]	10.049(7)	12.987(4)	19.346(7)
α [°]	90	90	90
β [°]	95.430(15)	97.972(5)	90
γ [°]	90	90	90
V [Å ³]	551.8(6)	791.8(4)	1702.0(10)
Z	2	2	4
F(000)	260	340	744
D calc [g cm ⁻³]	1.470	1.344	1.367
μ [mm ⁻¹]	0.120	0.102	0.105
Absorption correction	Multi-scan	Multi-scan	Multi-scan
T _{min} / T _{max}	0.9729 / 0.9037	0.9274 / 0.9638	0.9233 / 0.9581
Reflns. collected	3034	5633	12270
Unique reflns.	1638	2583	2958
Observed reflns.	1638	2455	2865
No of parameters	162	215	237
R ₁ [I>2σ(I)]	0.0359	0.0339	0.0311
WR ₂	0.0948	0.0881	0.0776
R ₁ (all data)	0.0374	0.0357	0.0320
WR ₂ (all data)	0.0959	0.0898	0.0782
goodness-of-fit	1.119	1.036	1.076
Δρ _{max} , Δρ _{min} (eÅ ⁻³)	+0.159, -0.226	+0.159, -0.159	+0.111, -0.176

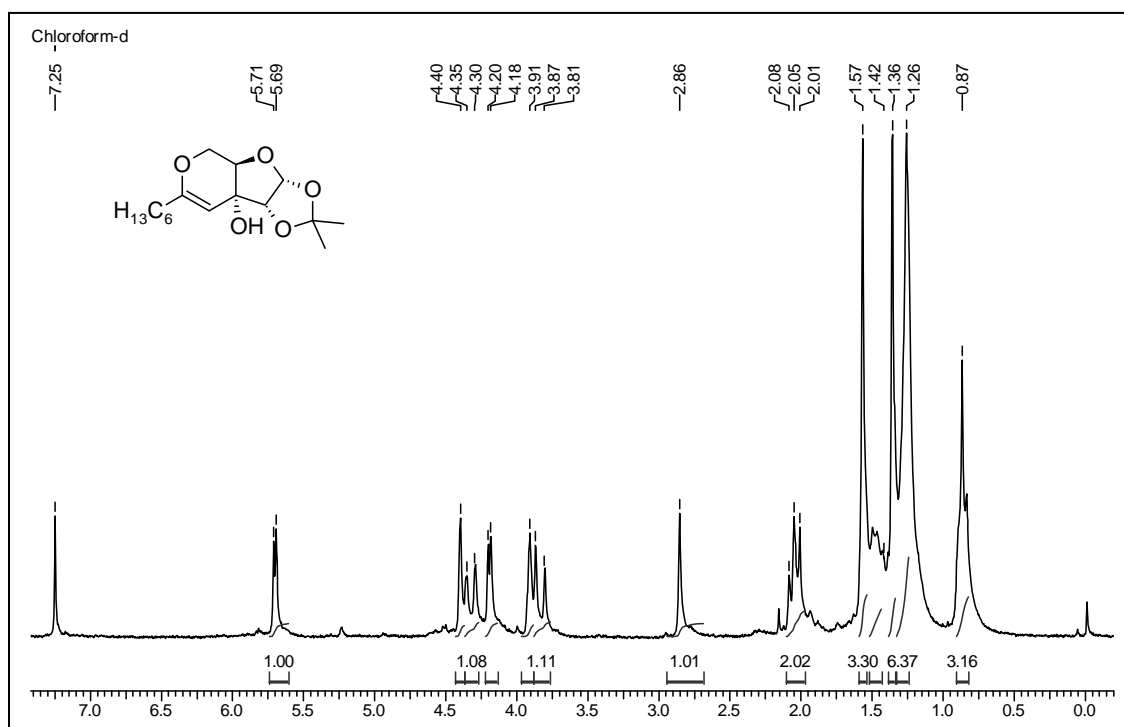
Table 13: Crystal data for compounds 104, 107 and 108



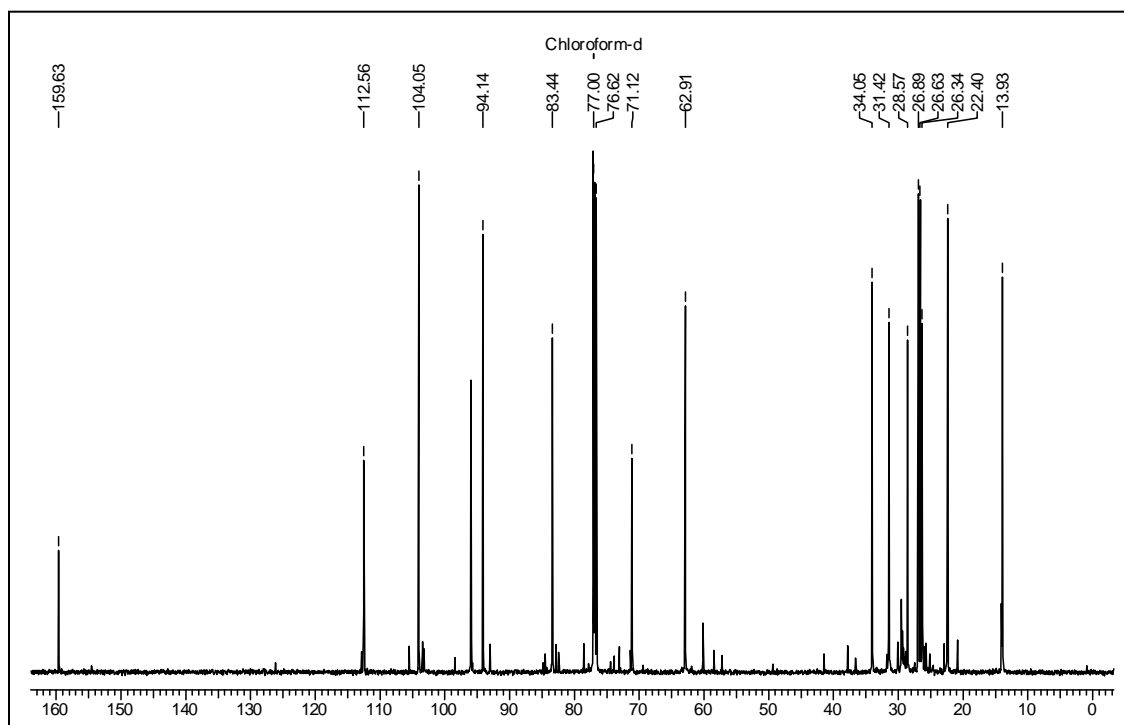
¹H NMR Spectrum of 93 in CDCl₃



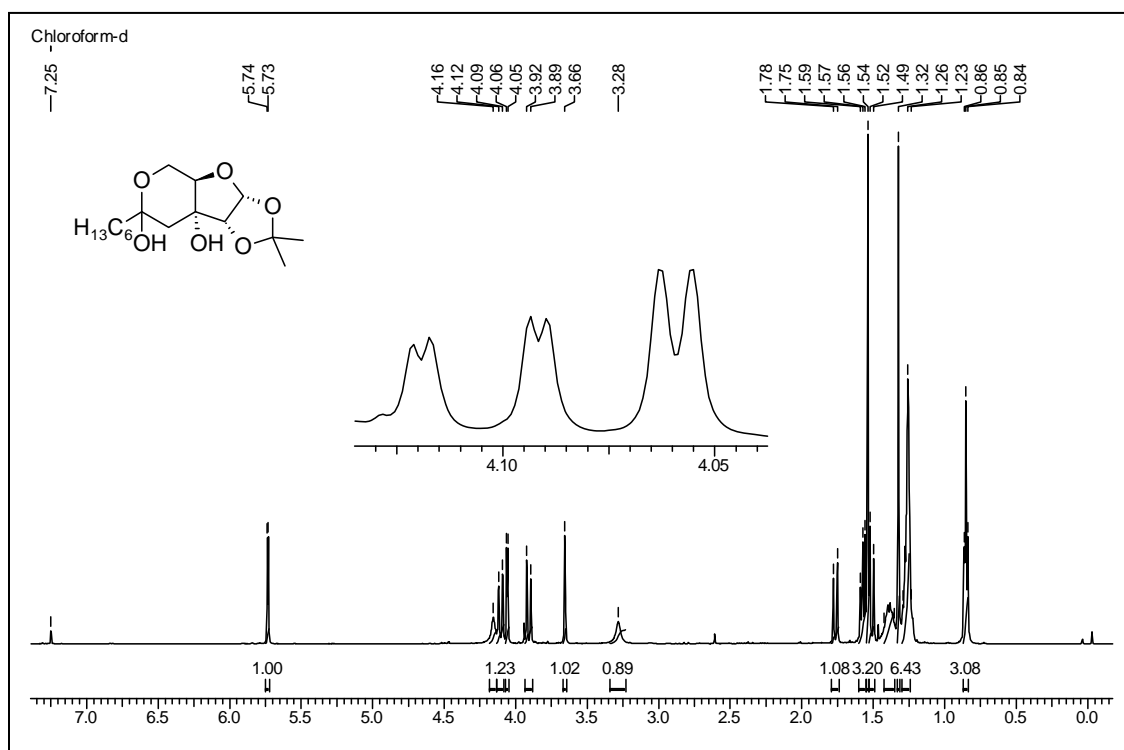
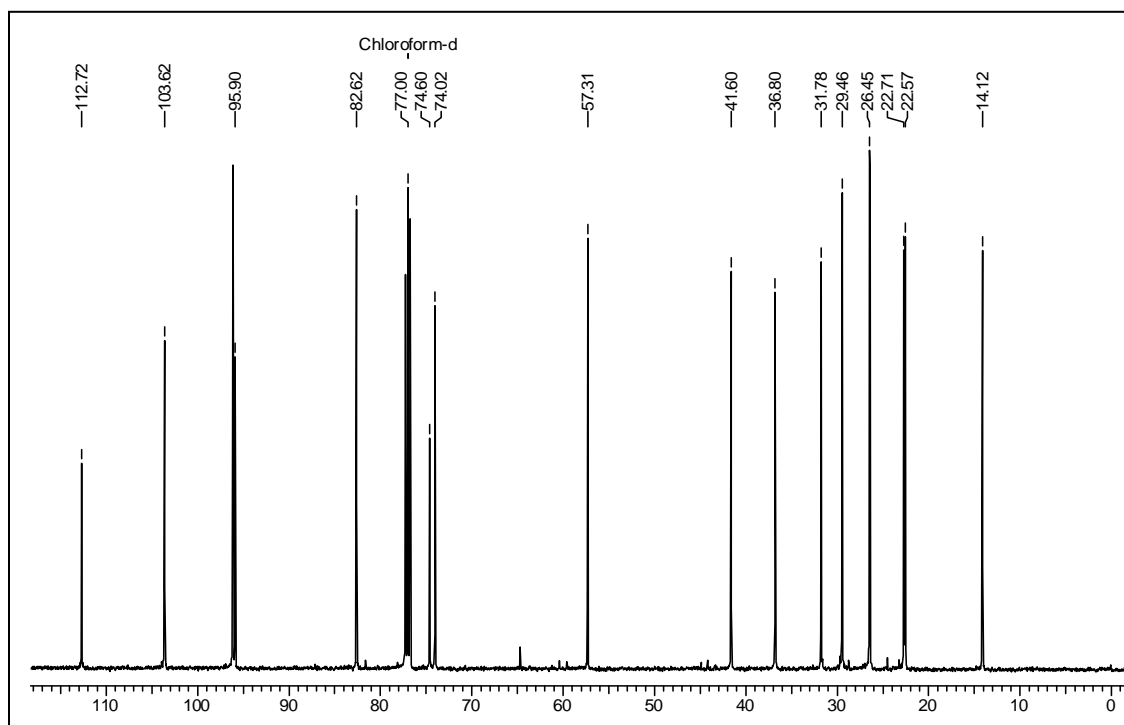
¹³C NMR Spectrum of 93 in CDCl₃

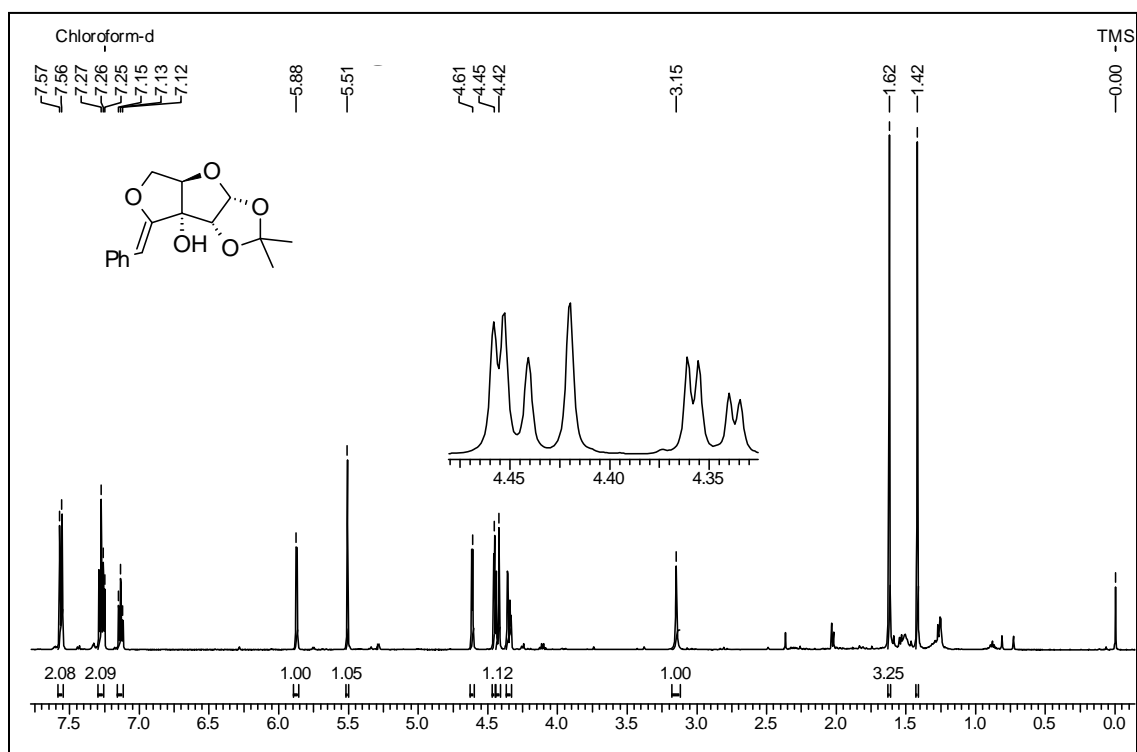
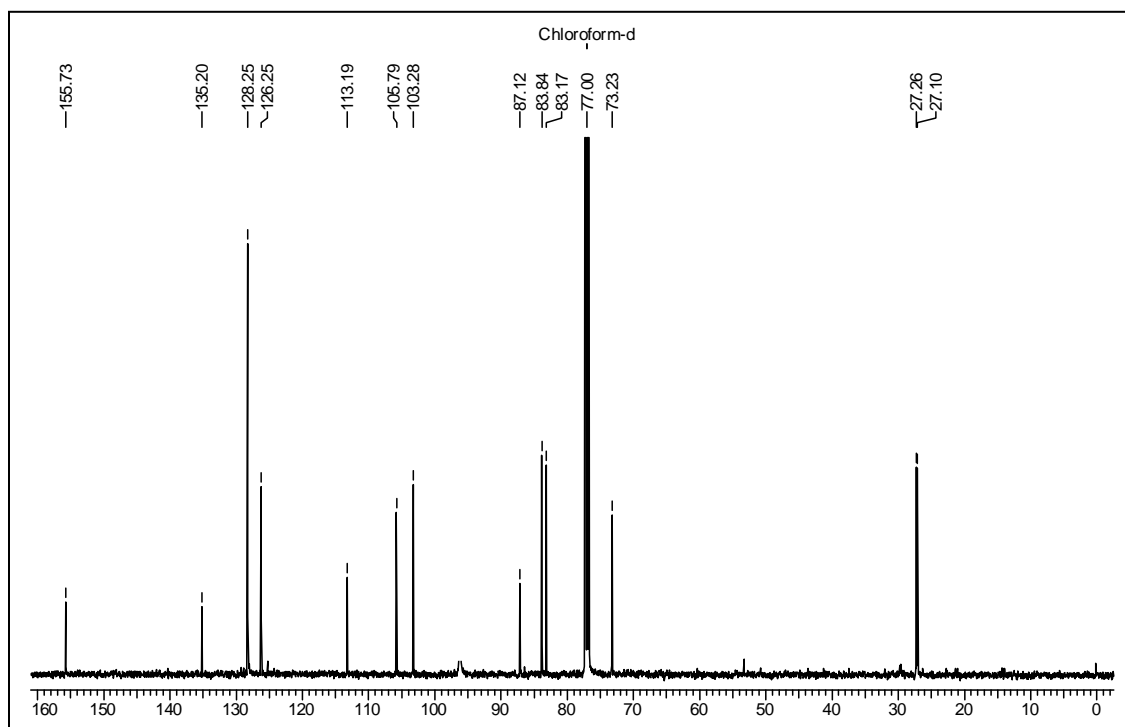


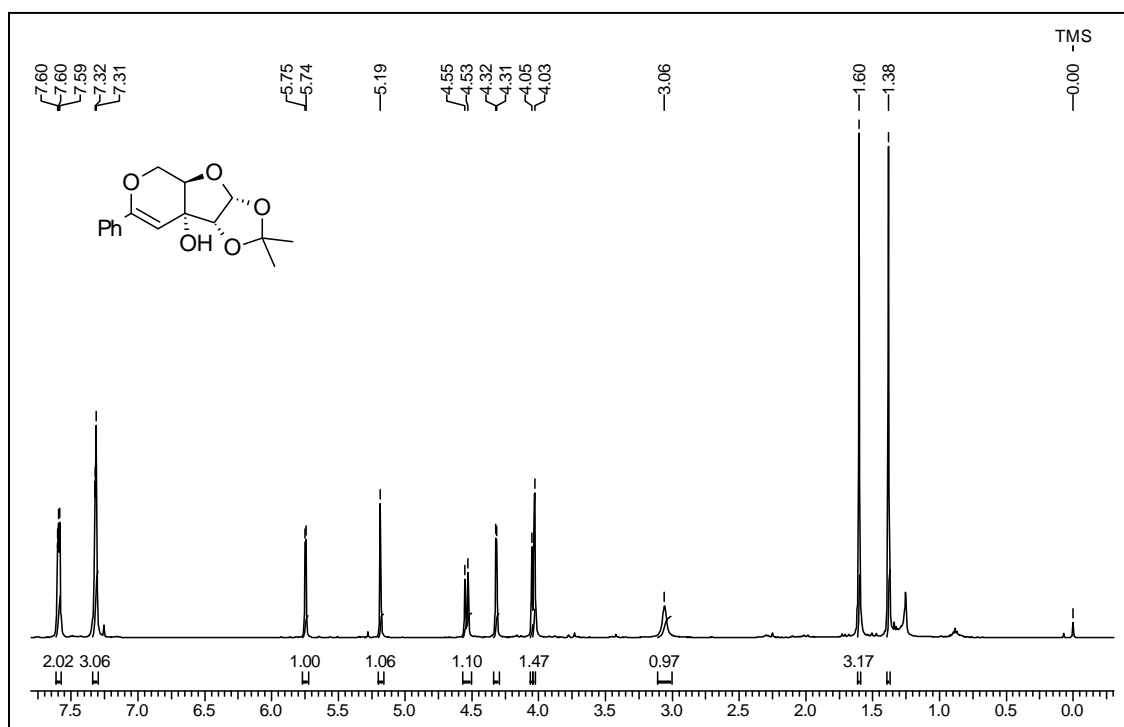
^1H NMR Spectrum of 94 in CDCl_3



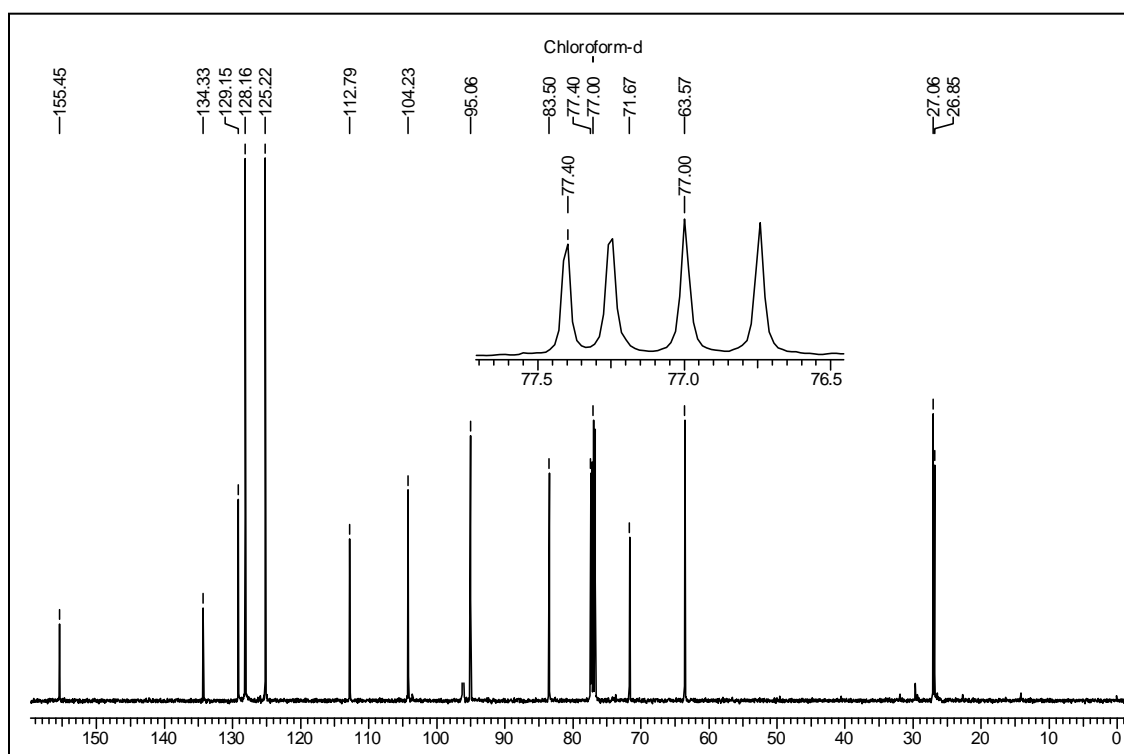
^{13}C NMR Spectrum of 94 in CDCl_3

 1H NMR Spectrum of 95 in $CDCl_3$  ^{13}C NMR Spectrum of 95 in $CDCl_3$

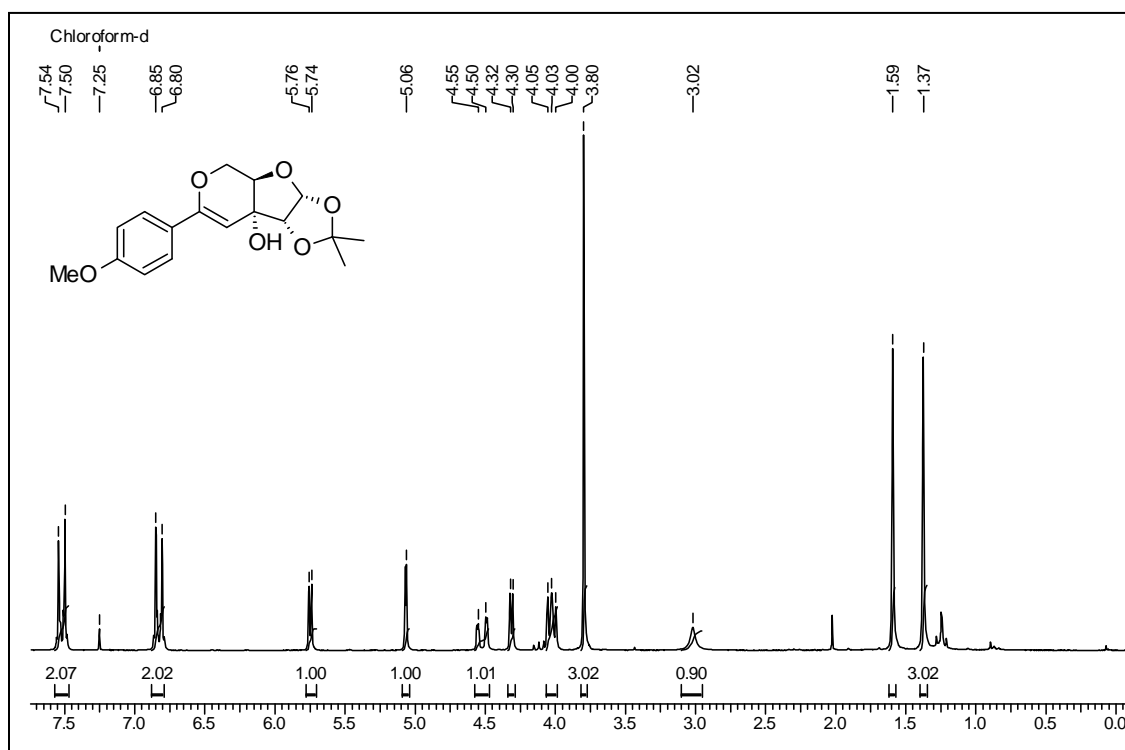
¹H NMR Spectrum of 96 in CDCl₃¹³C NMR Spectrum of 96 in CDCl₃



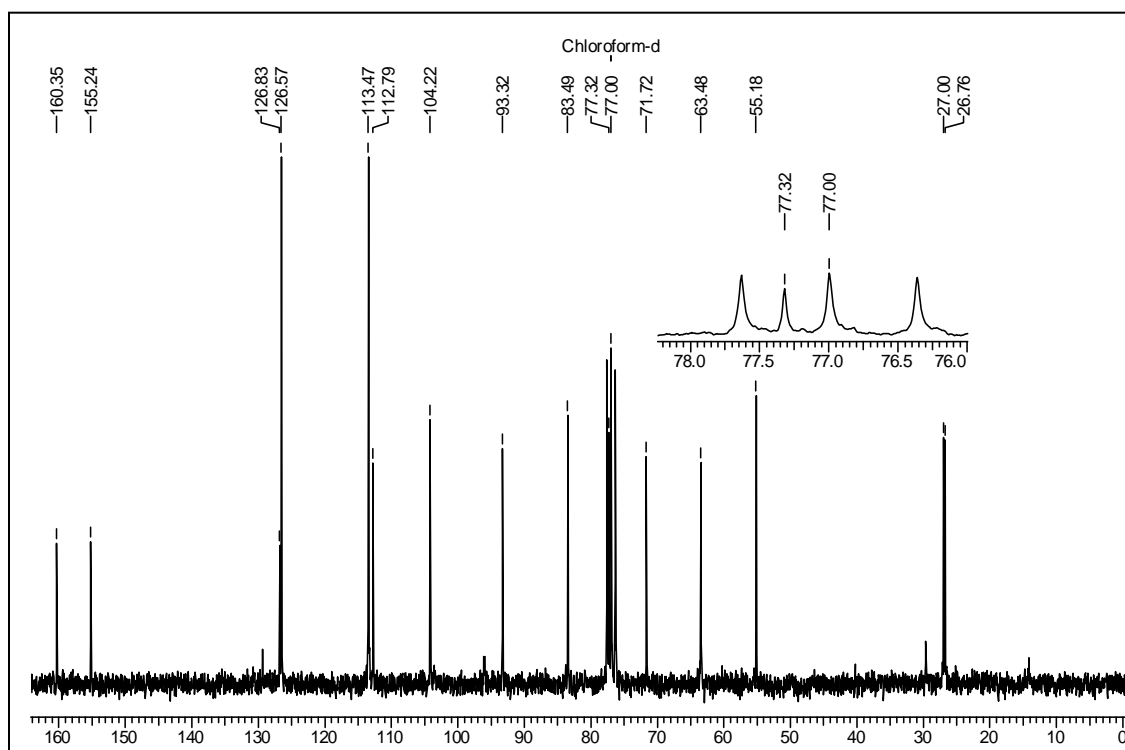
¹H NMR Spectrum of 97 in CDCl₃



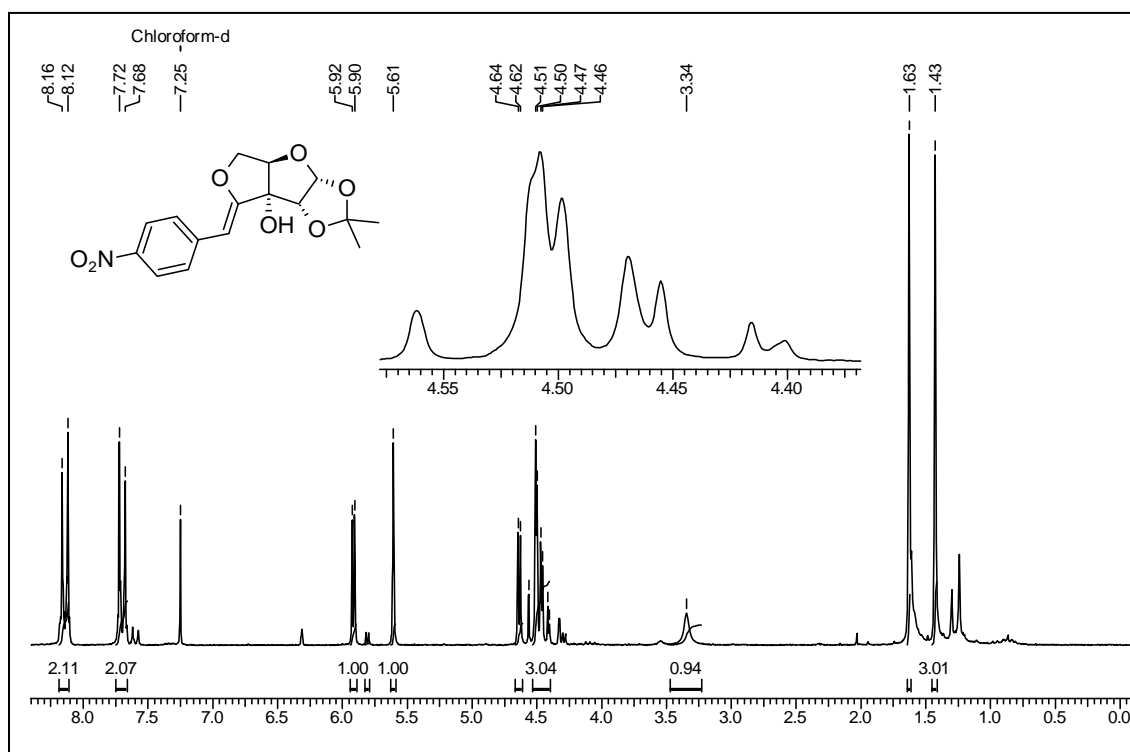
¹³C NMR Spectrum of 97 in CDCl₃



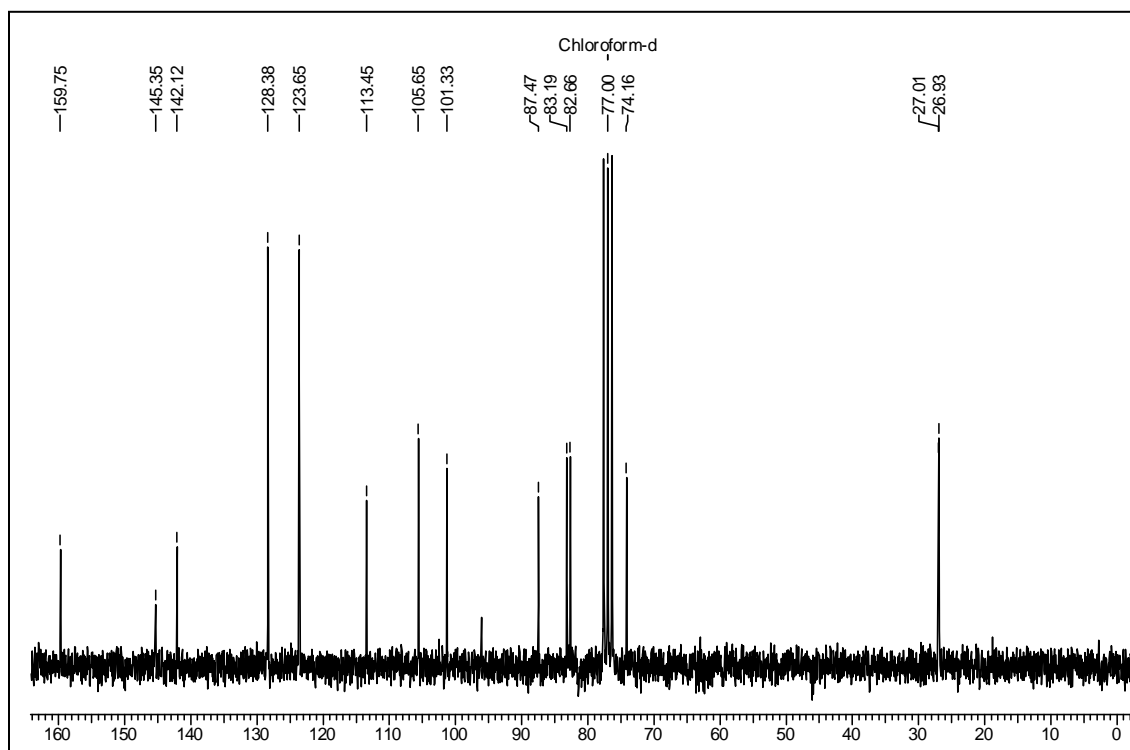
^1H NMR Spectrum of 98 in CDCl_3



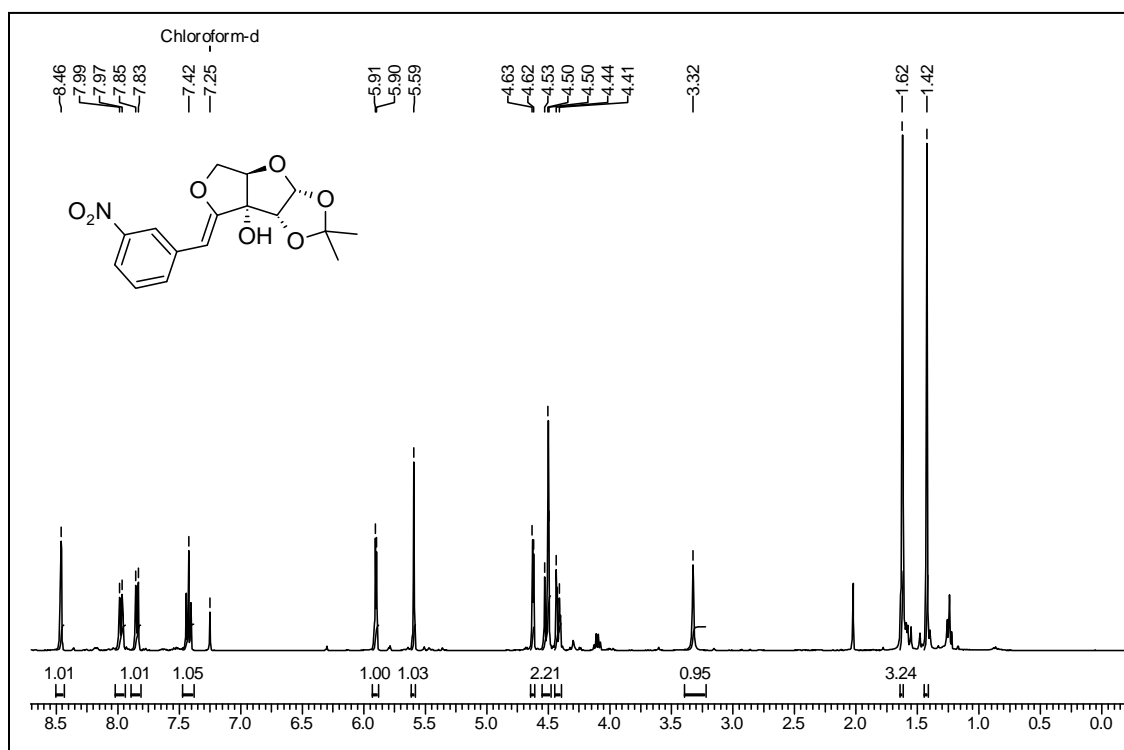
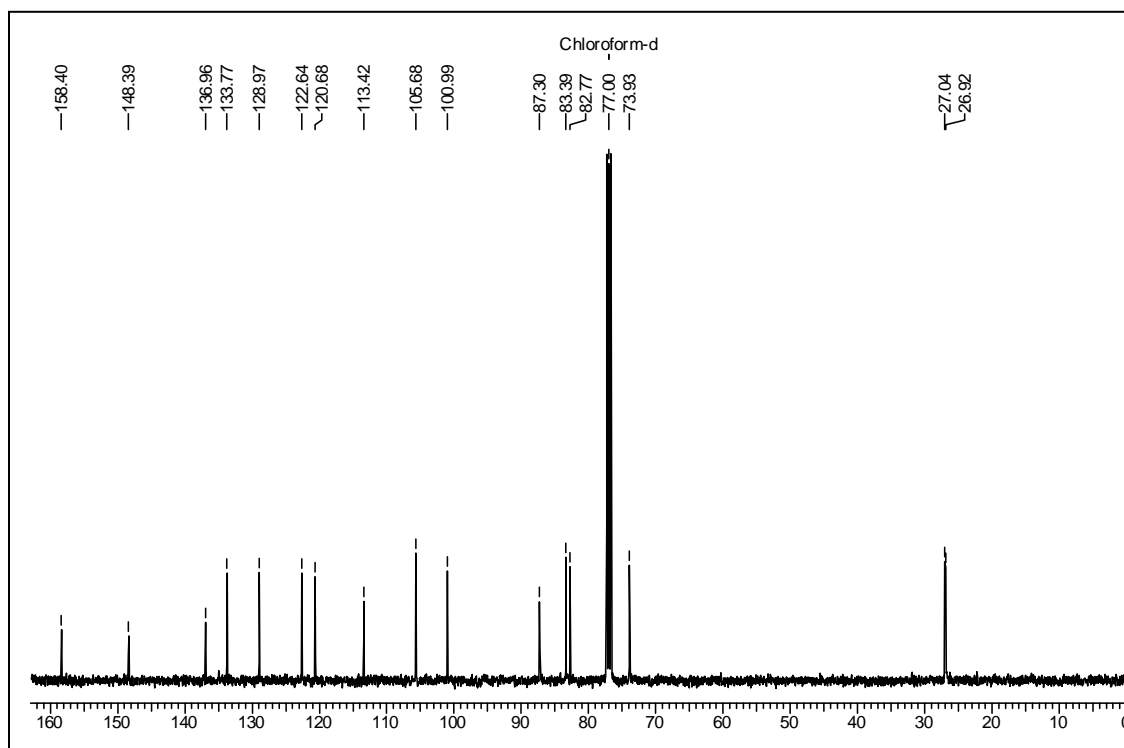
^{13}C NMR Spectrum of 98 in CDCl_3

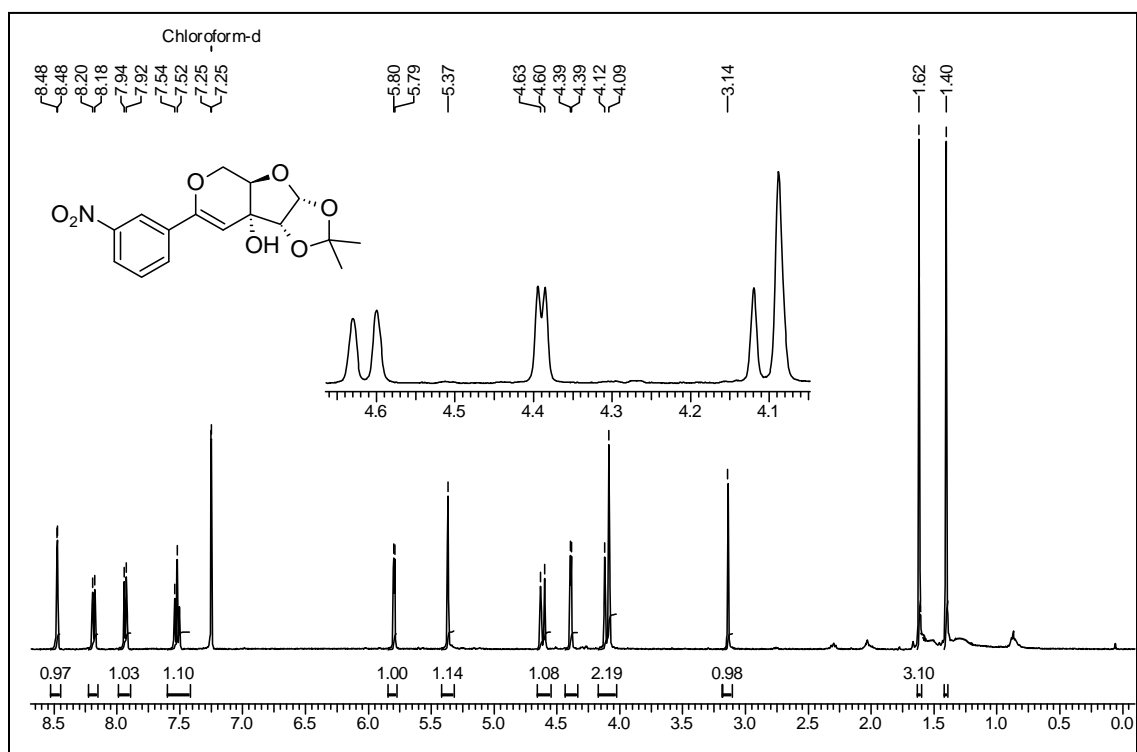


¹H NMR Spectrum of 99 in CDCl₃

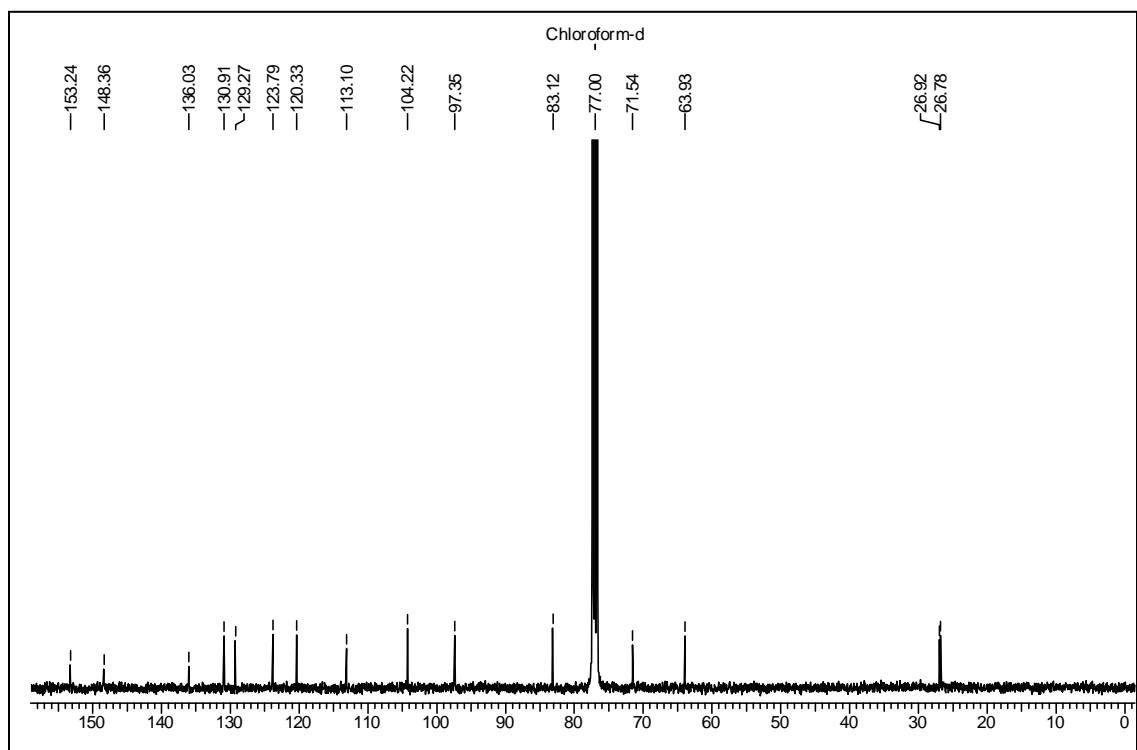


¹³C NMR Spectrum of 99 in CDCl₃

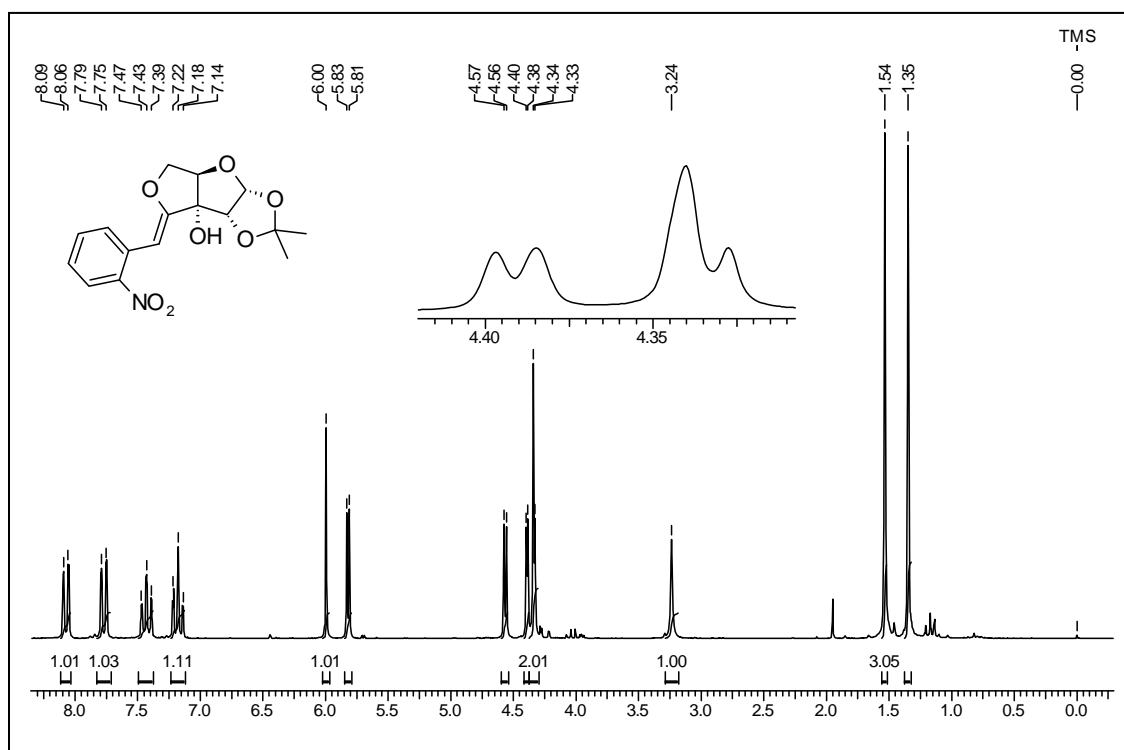
 ^1H NMR Spectrum of 100 in CDCl_3  ^{13}C NMR Spectrum of 100 in CDCl_3



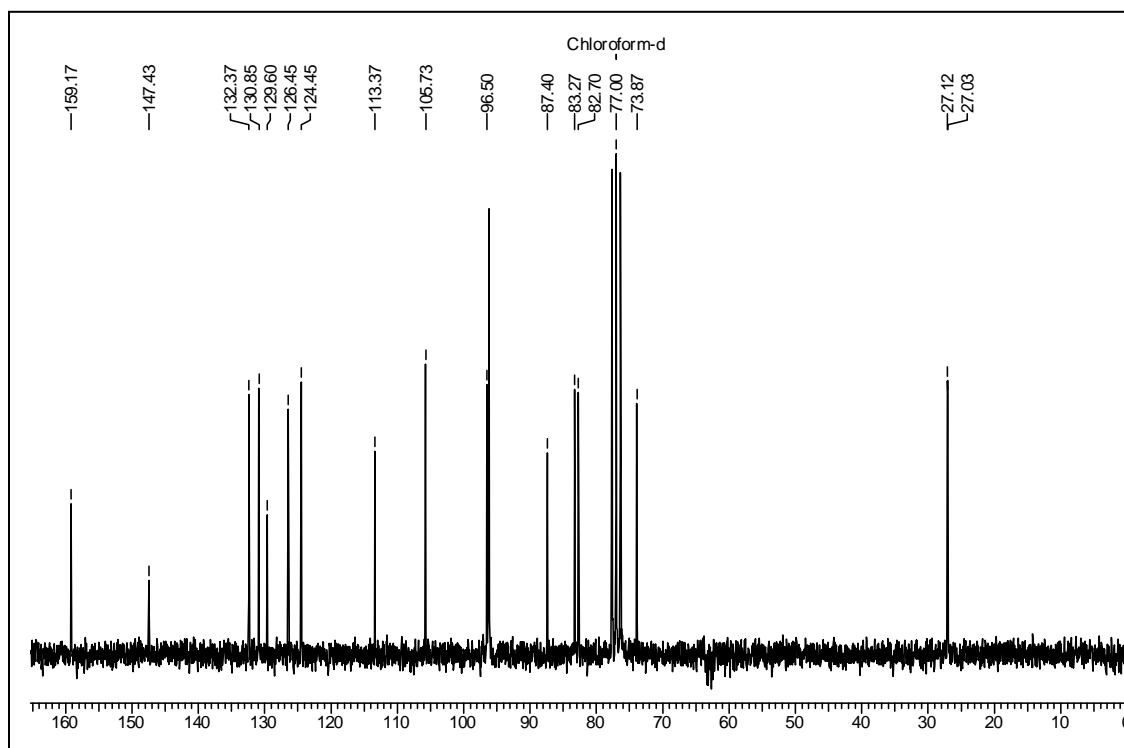
^1H NMR Spectrum of 101 in CDCl_3



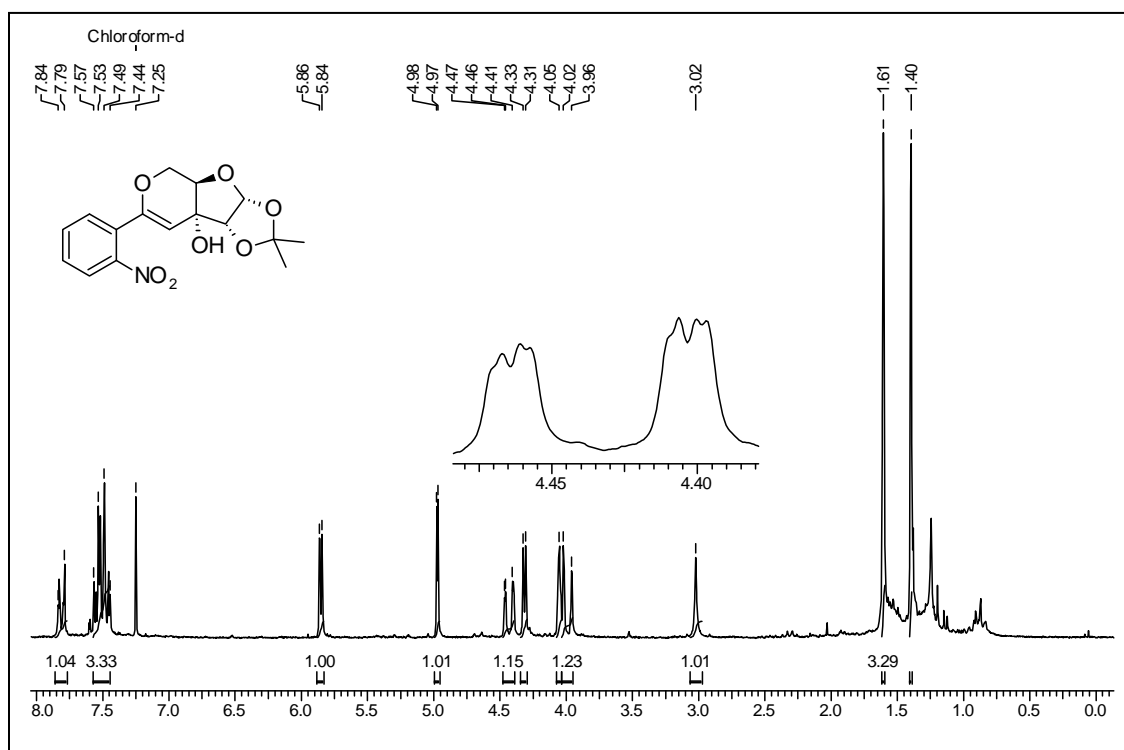
^{13}C NMR Spectrum of 101 in CDCl_3



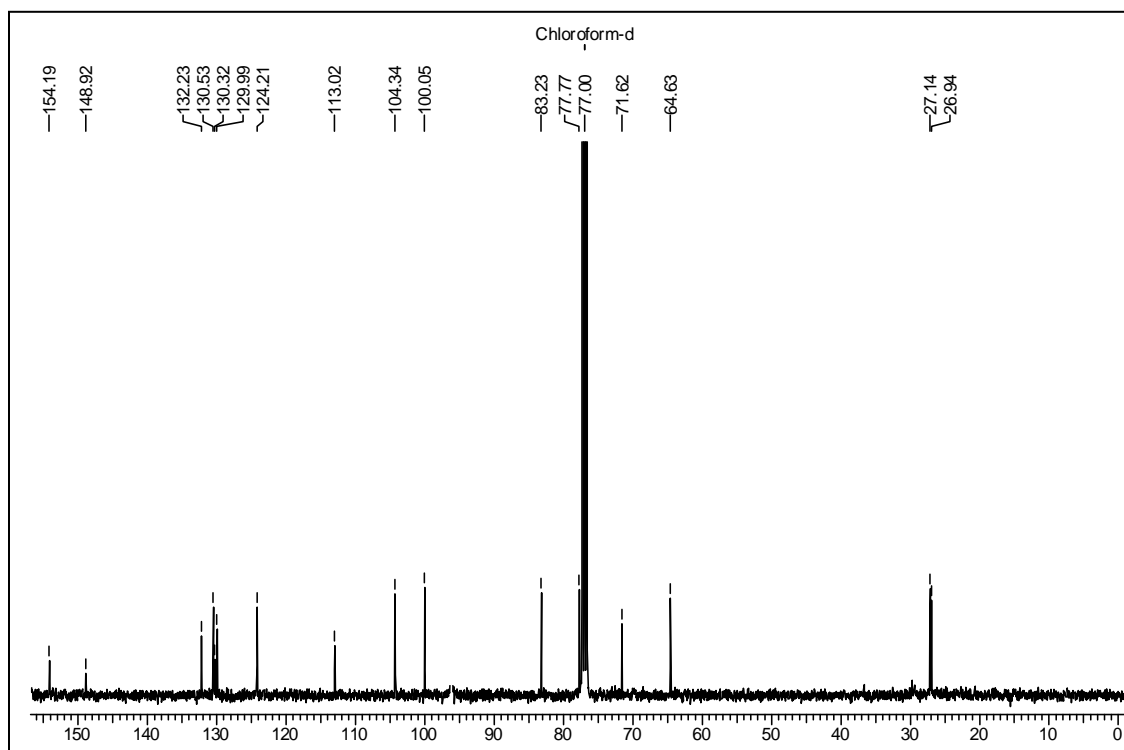
¹H NMR Spectrum of 102 in CDCl₃



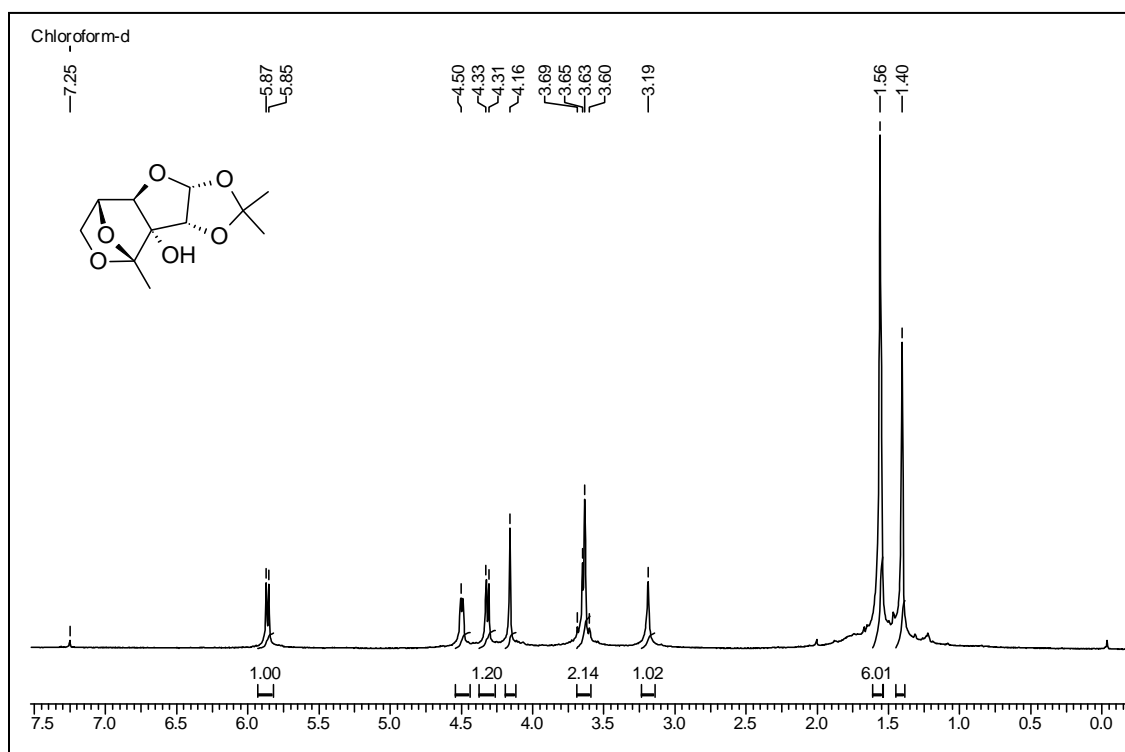
¹³C NMR Spectrum of 102 in CDCl₃



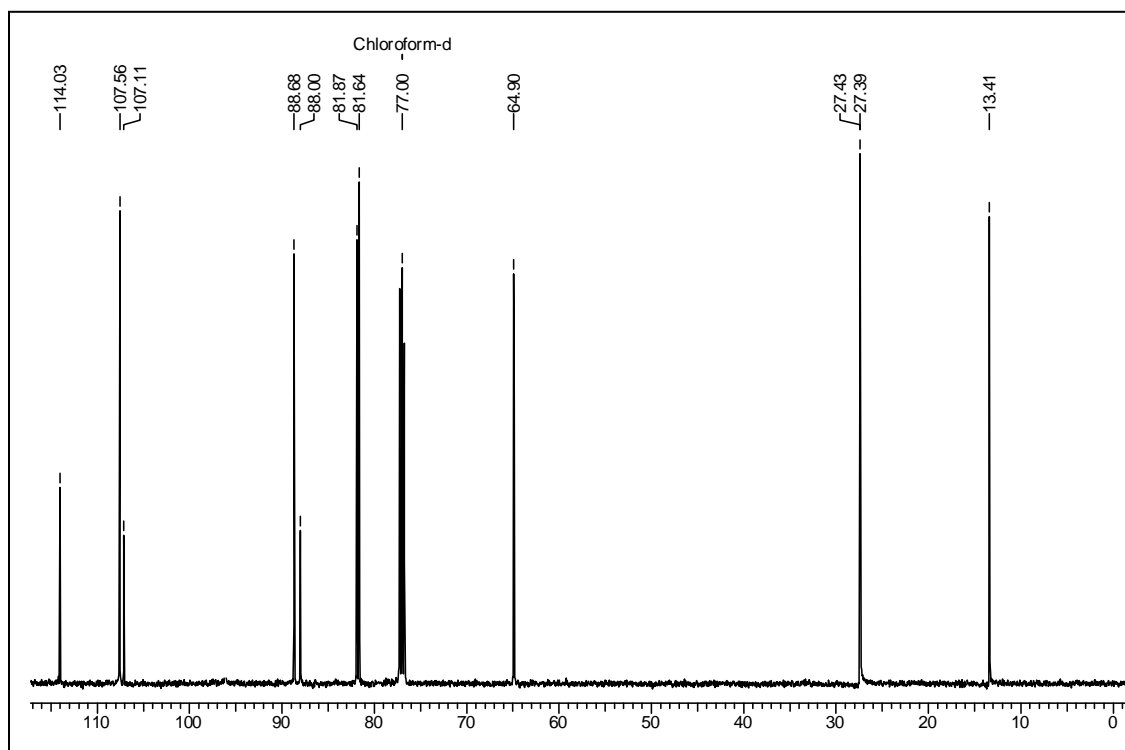
¹H NMR Spectrum of 103 in CDCl₃



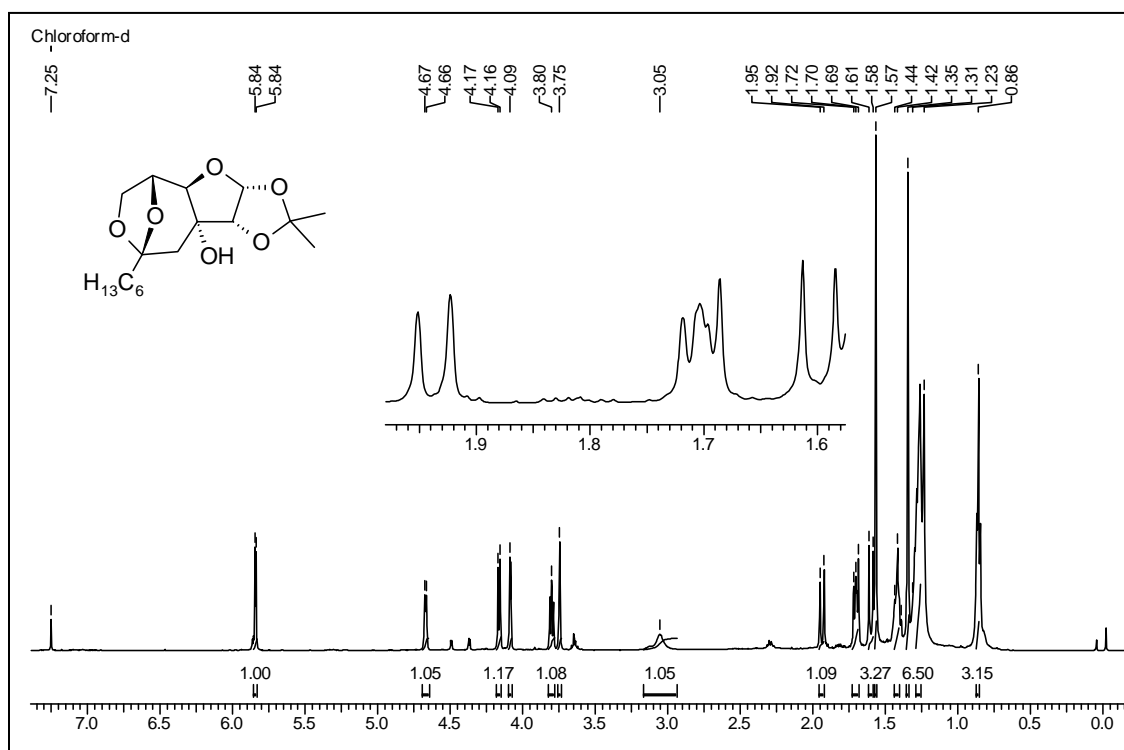
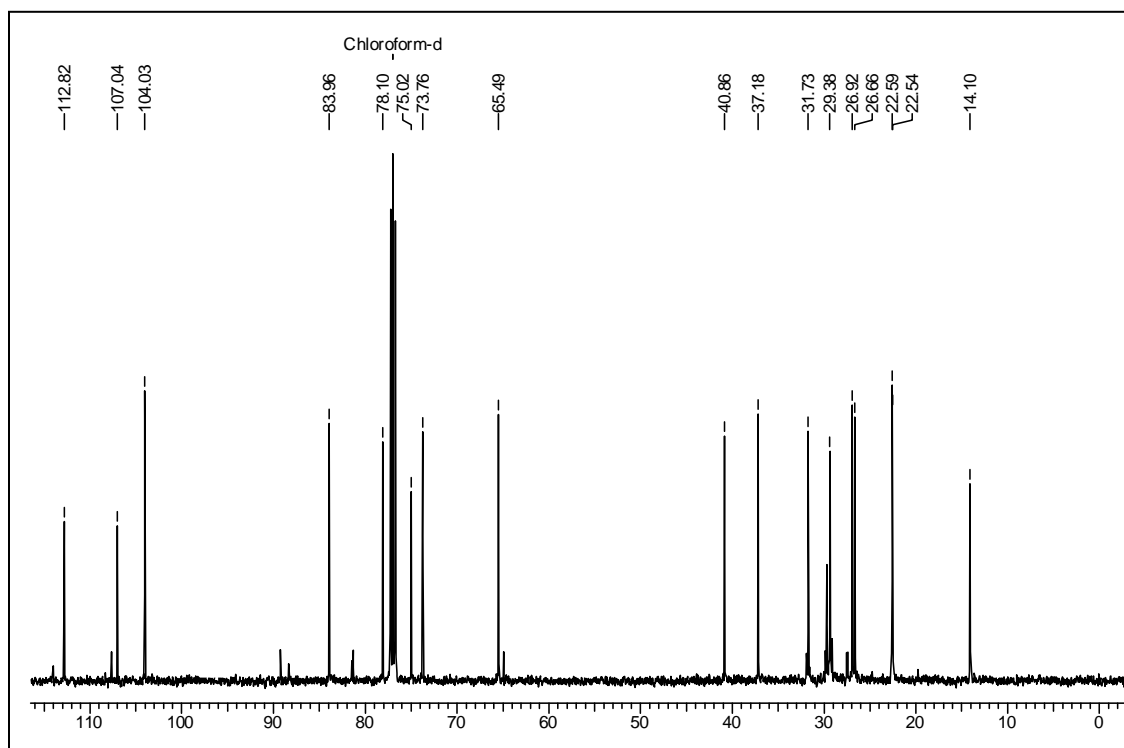
¹³C NMR Spectrum of 103 in CDCl₃

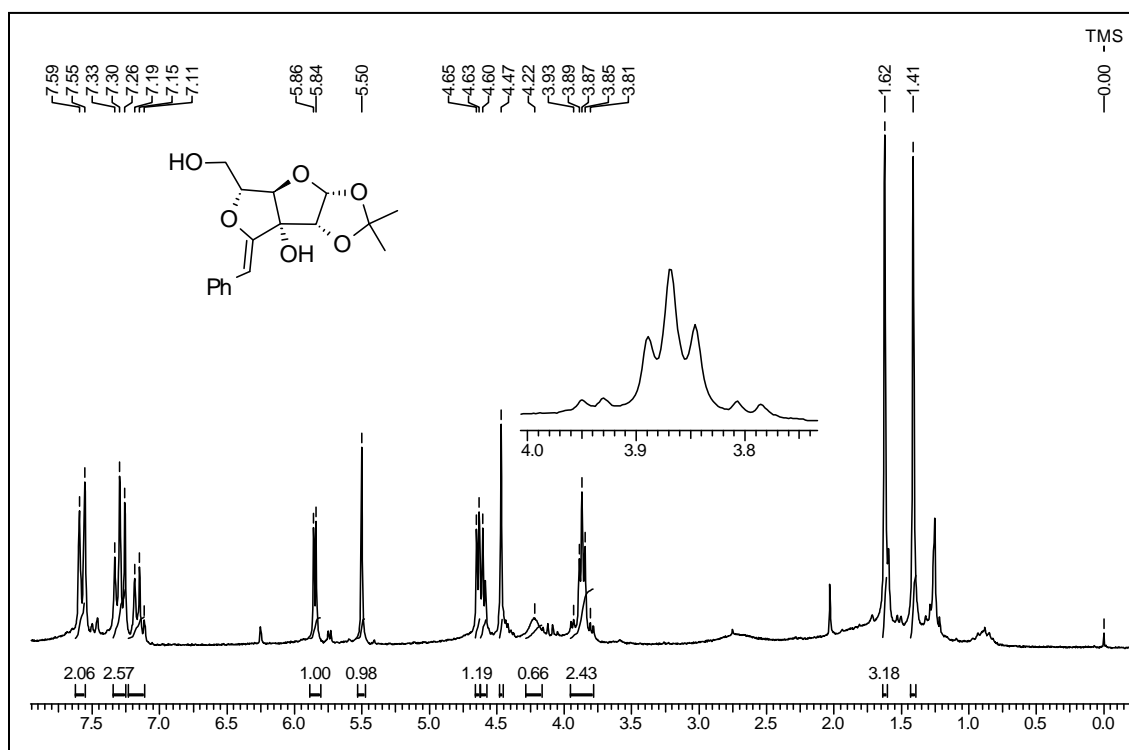
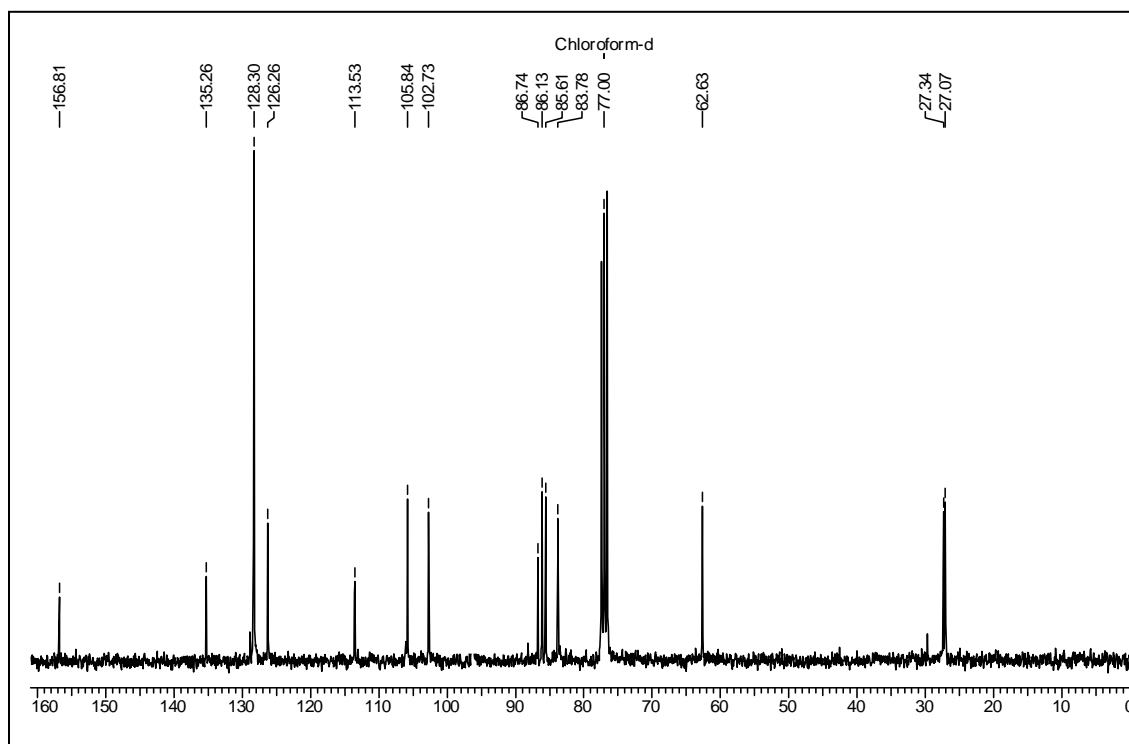


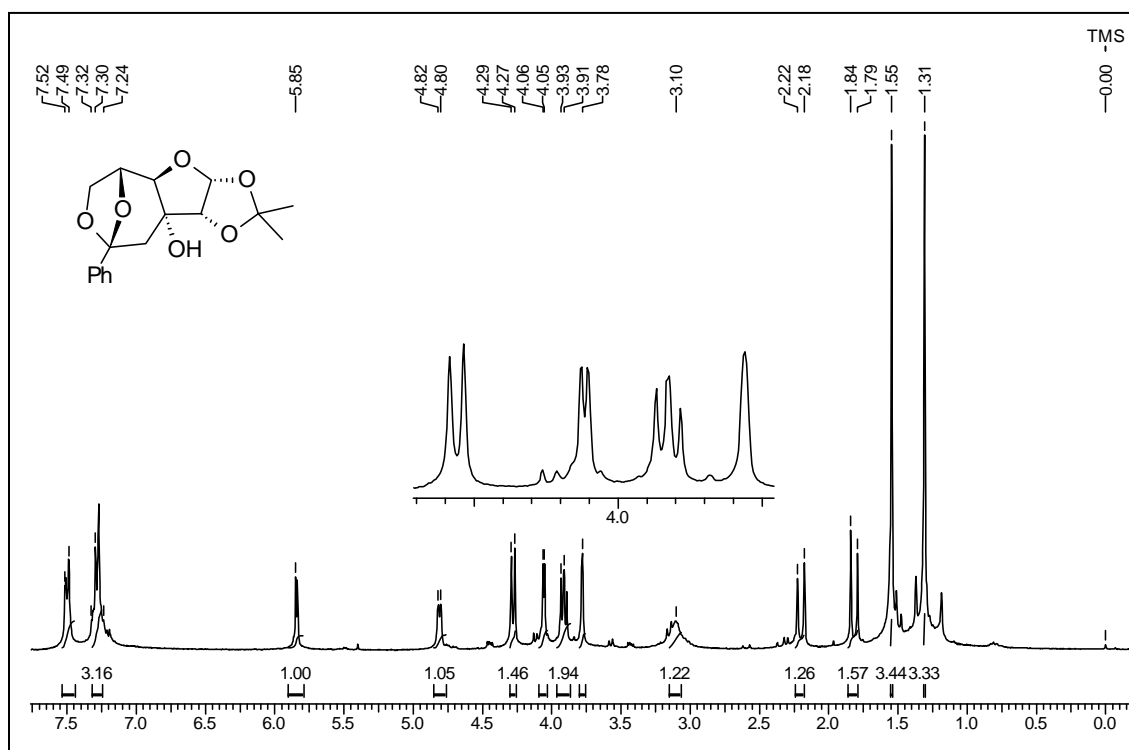
^1H NMR Spectrum of 104 in CDCl_3



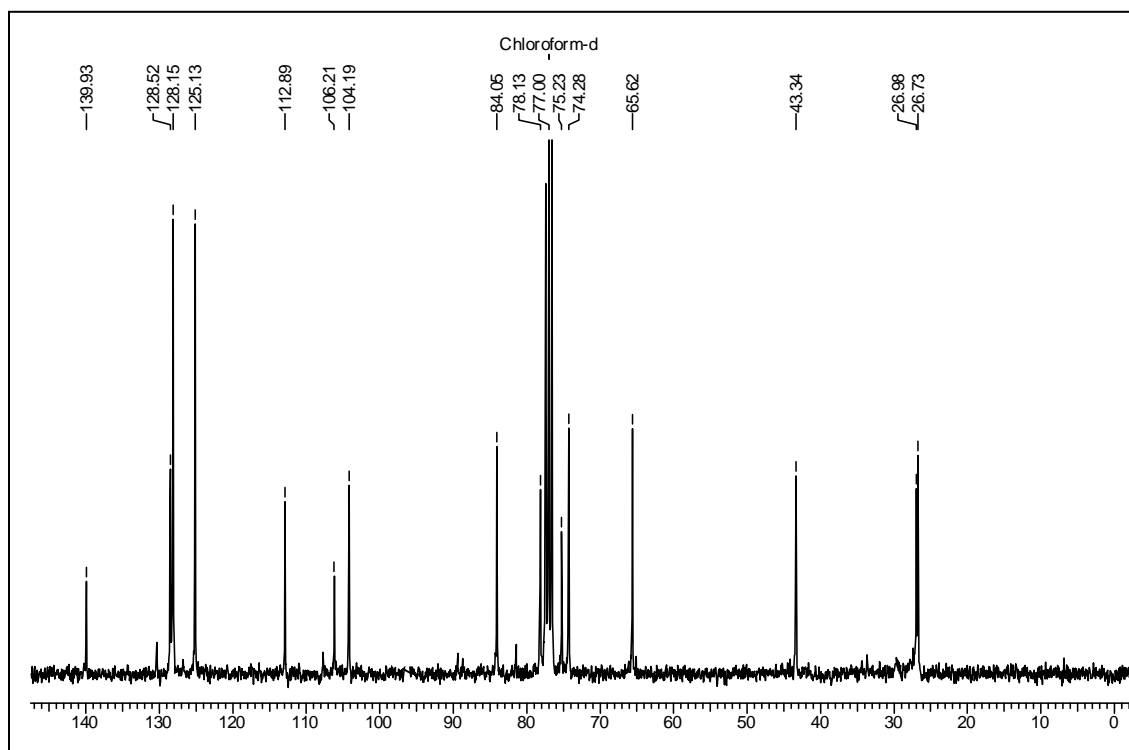
^{13}C NMR Spectrum of 104 in CDCl_3

 ^1H NMR Spectrum of 105 in CDCl_3  ^{13}C NMR Spectrum of 105 in CDCl_3

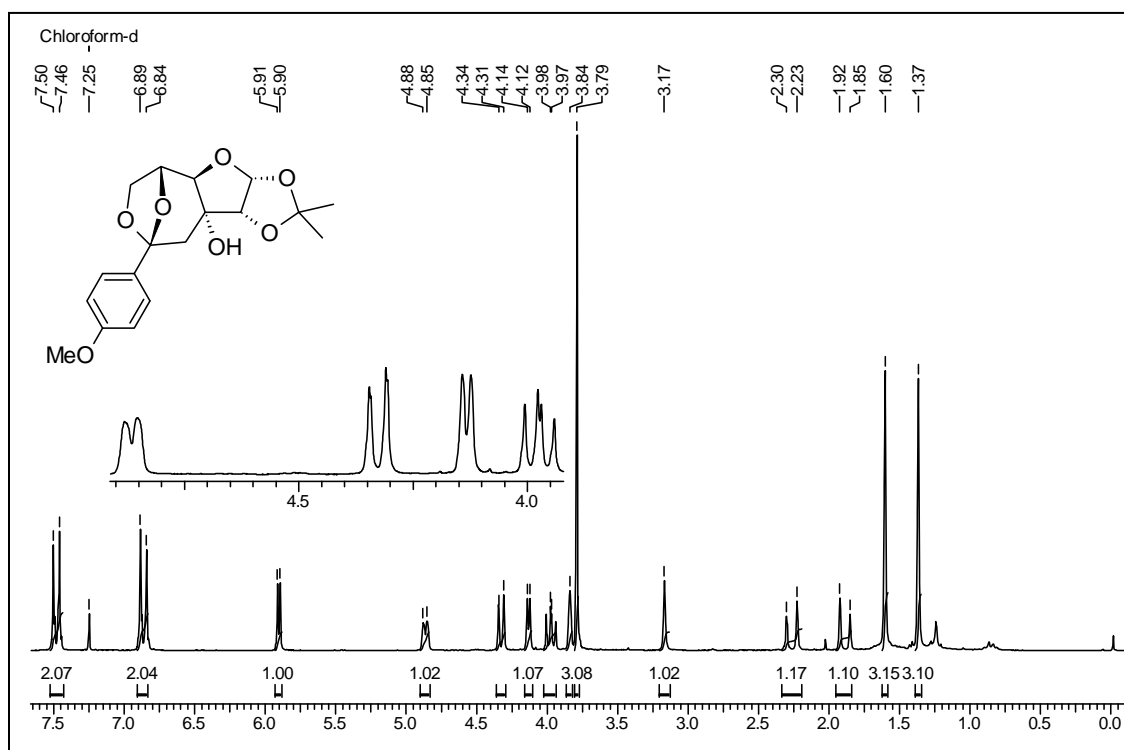
 ^1H NMR Spectrum of 106 in CDCl_3  ^{13}C NMR Spectrum of 106 in CDCl_3



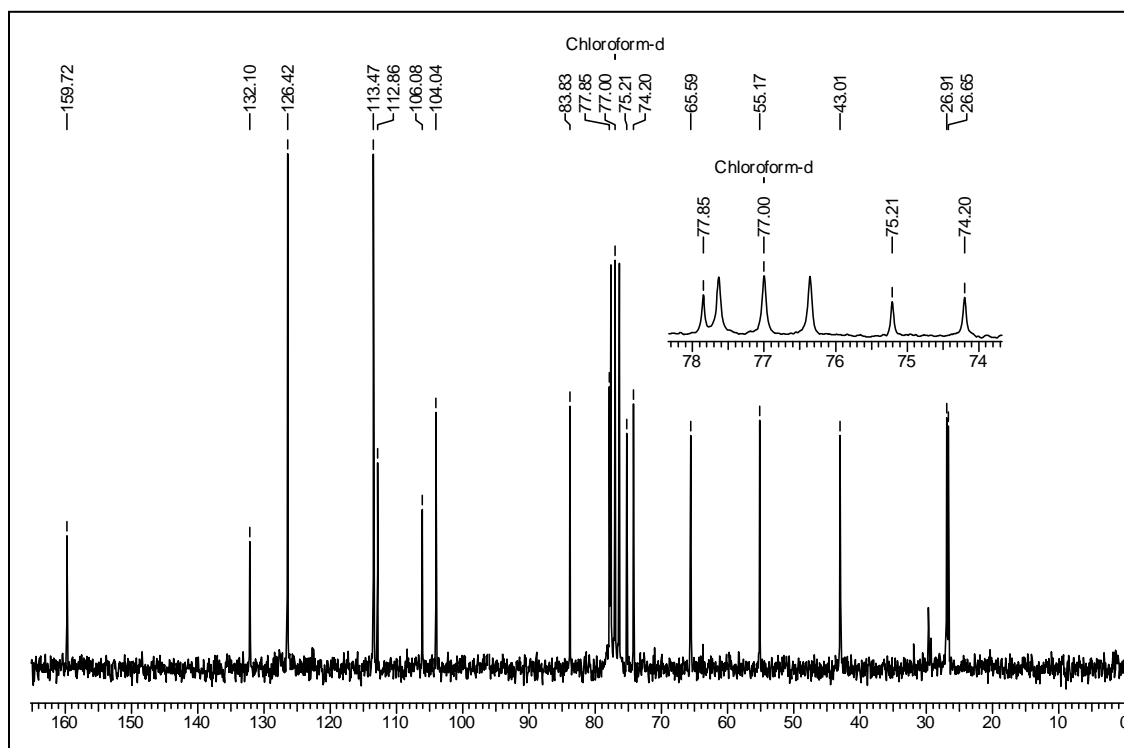
¹H NMR Spectrum of 107 in CDCl₃



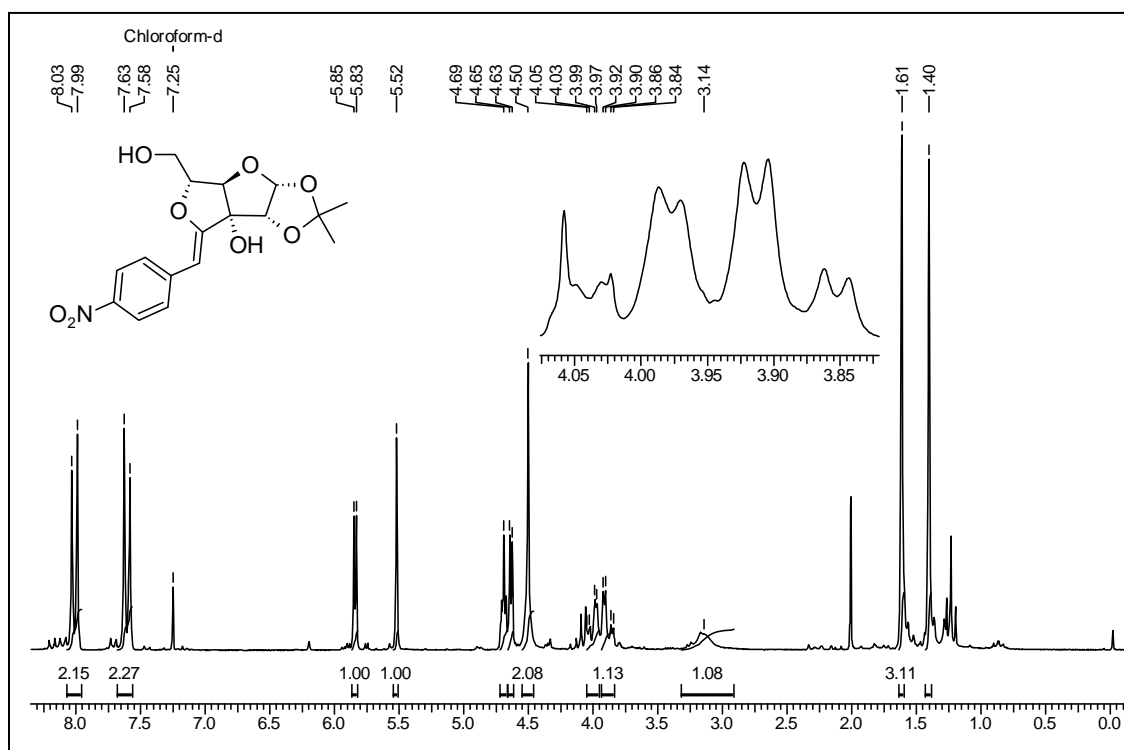
¹³C NMR Spectrum of 107 in CDCl₃



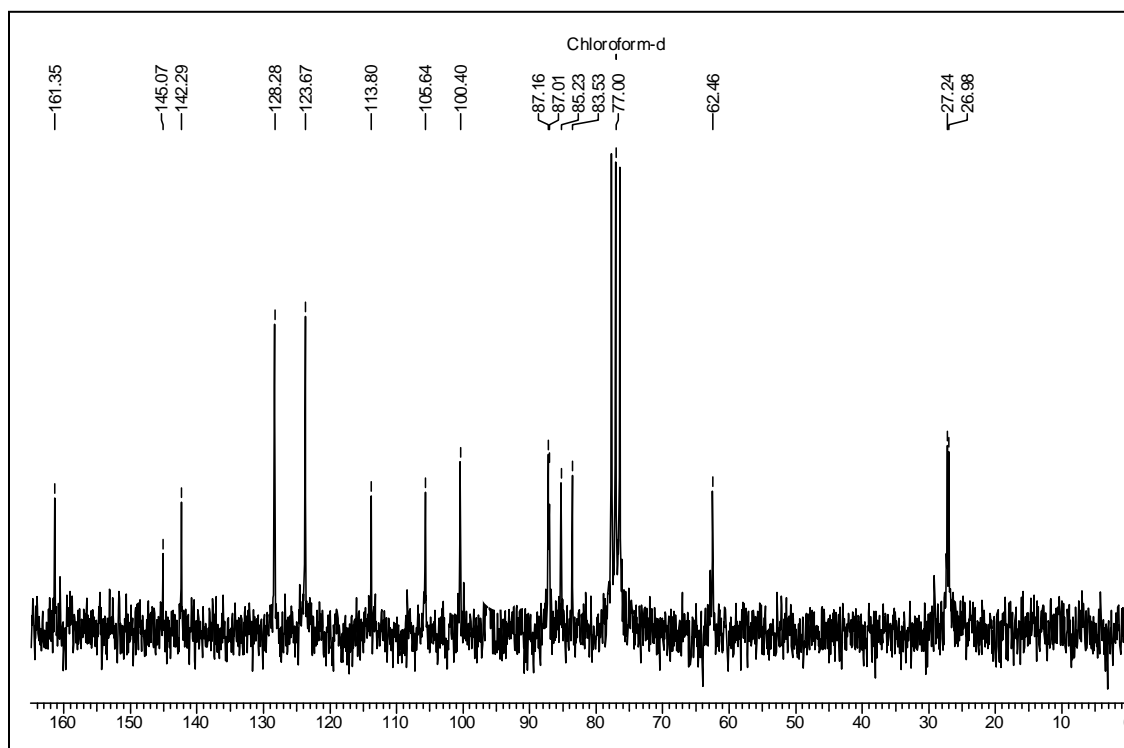
¹H NMR Spectrum of 108 in CDCl₃



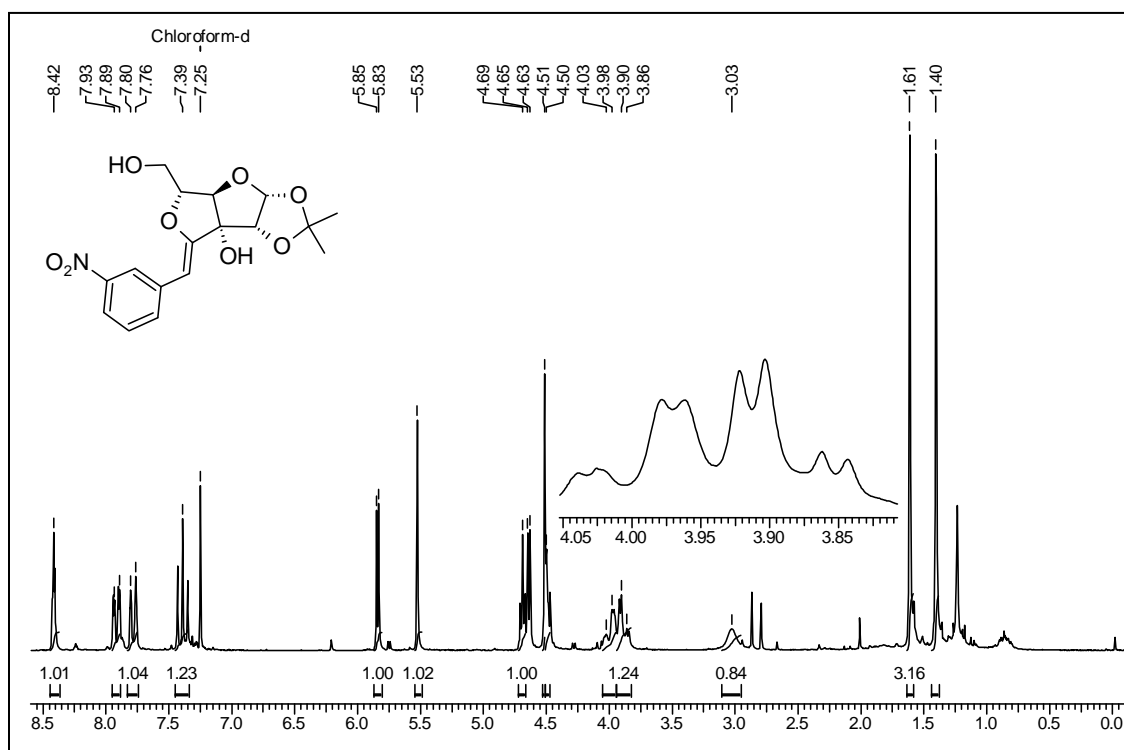
¹³C NMR Spectrum of 108 in CDCl₃



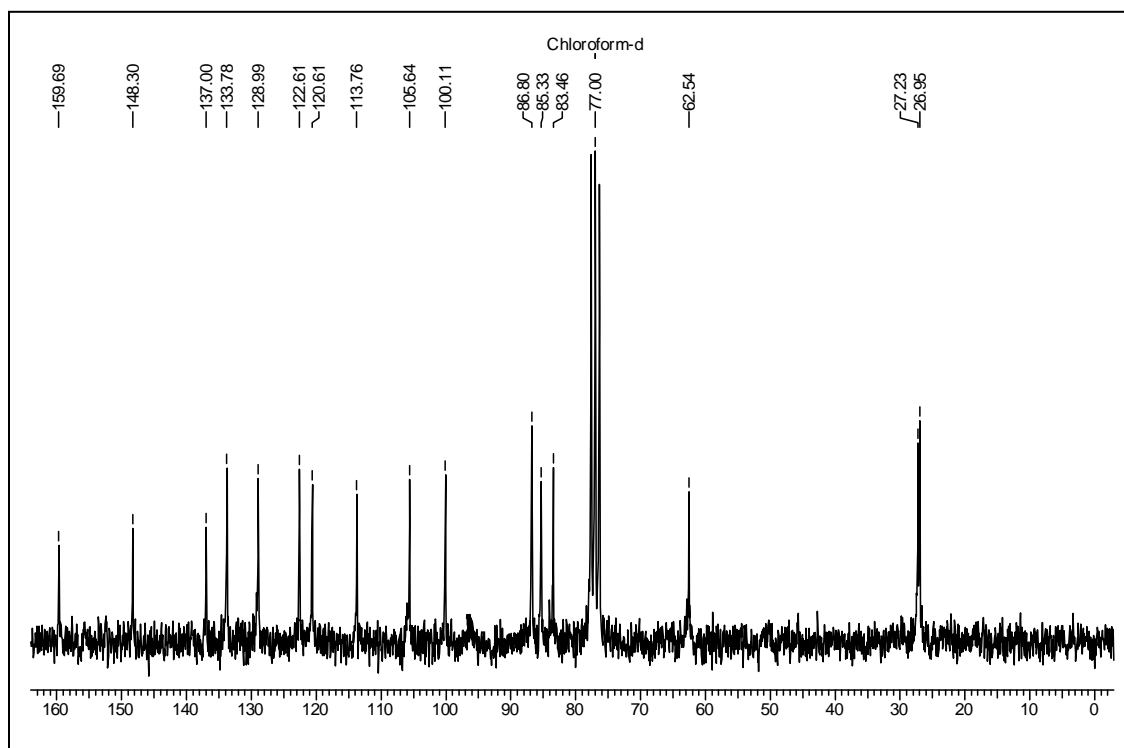
^1H NMR Spectrum of 109 in CDCl_3



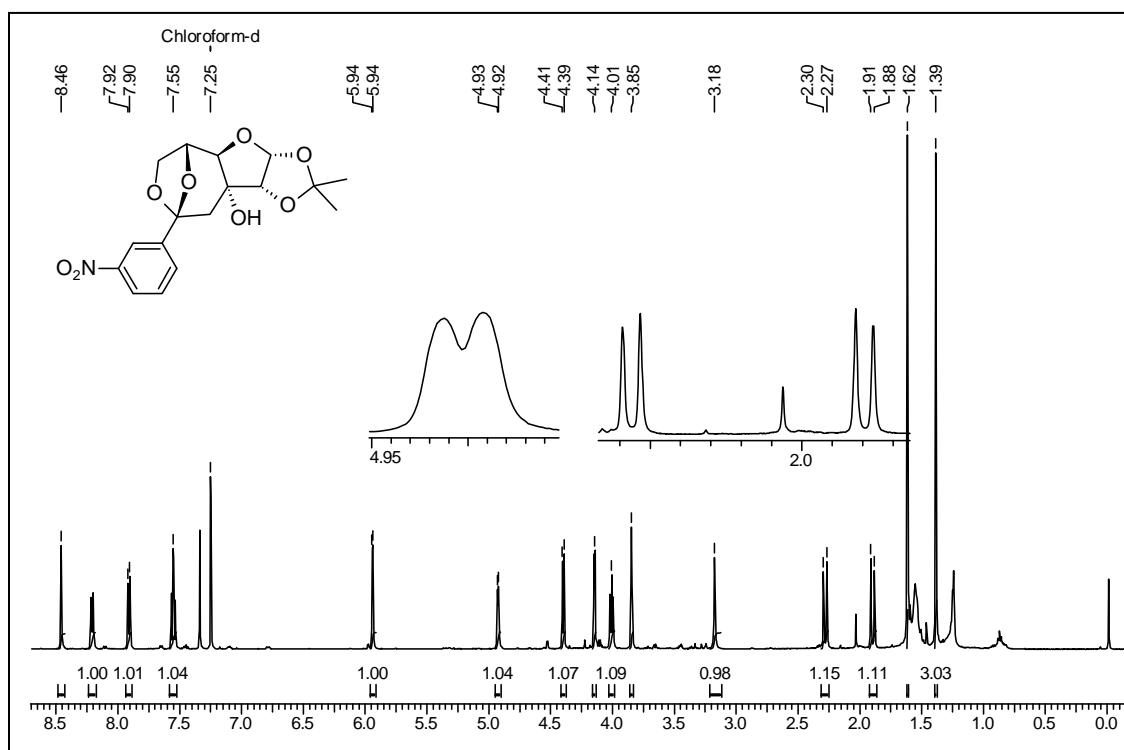
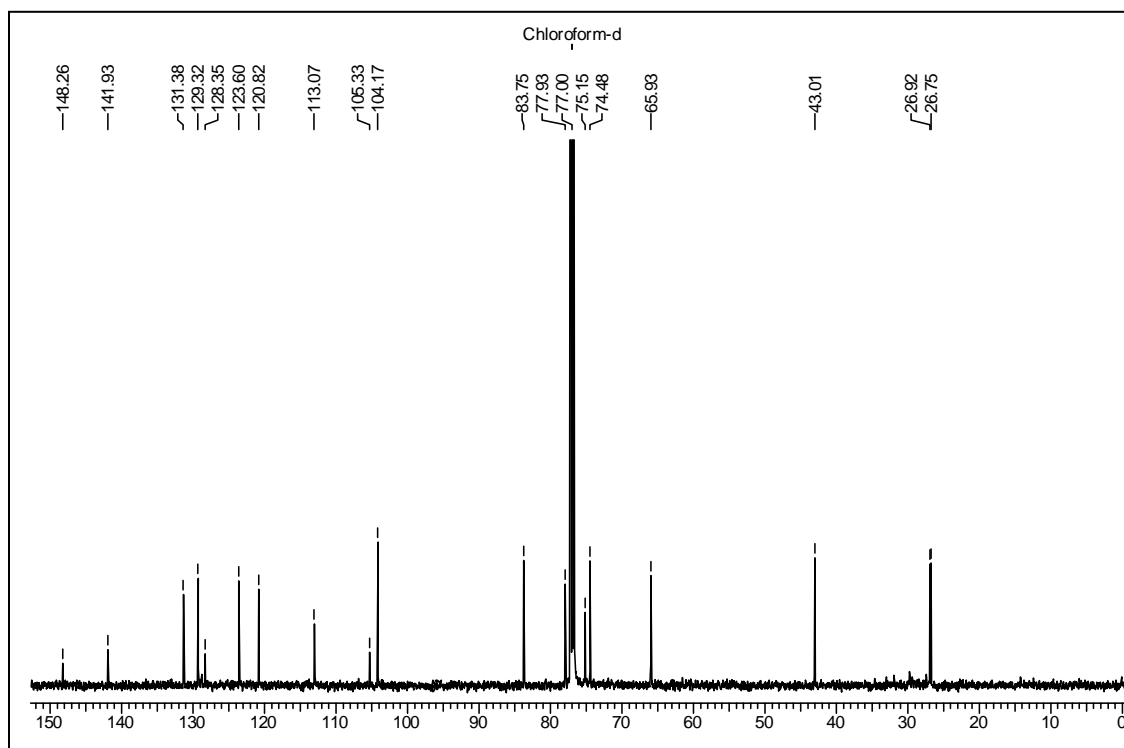
^{13}C NMR Spectrum of 109 in CDCl_3

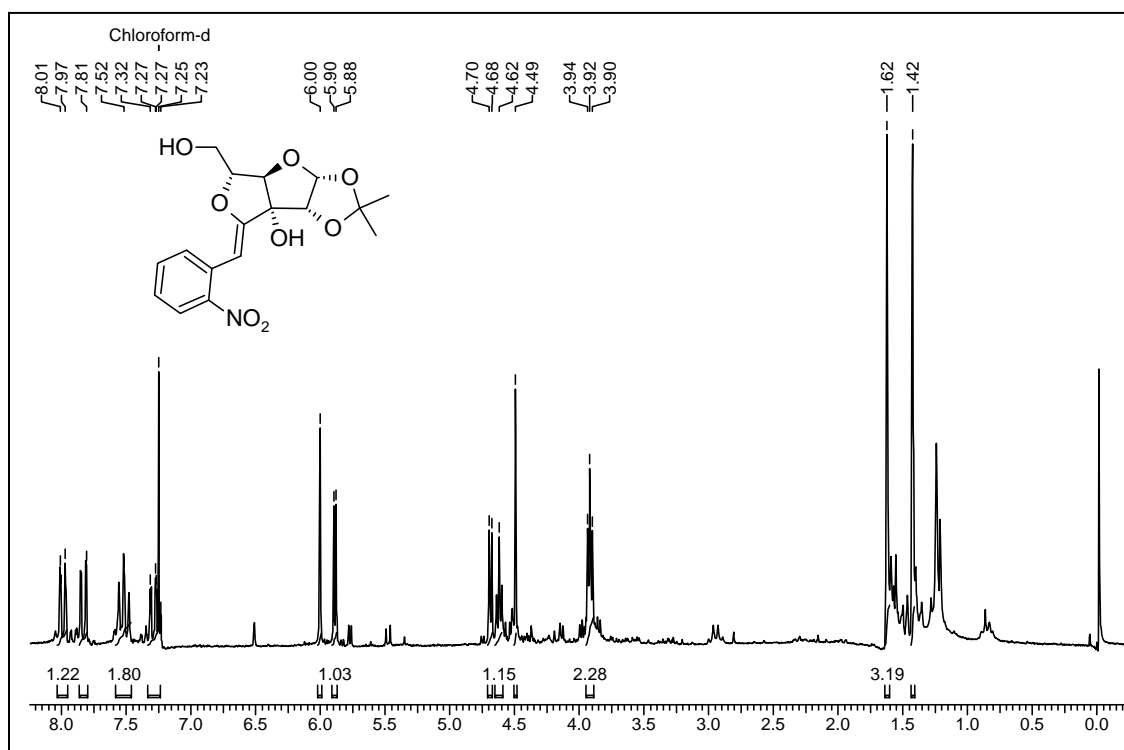


^1H NMR Spectrum of 110 in CDCl_3

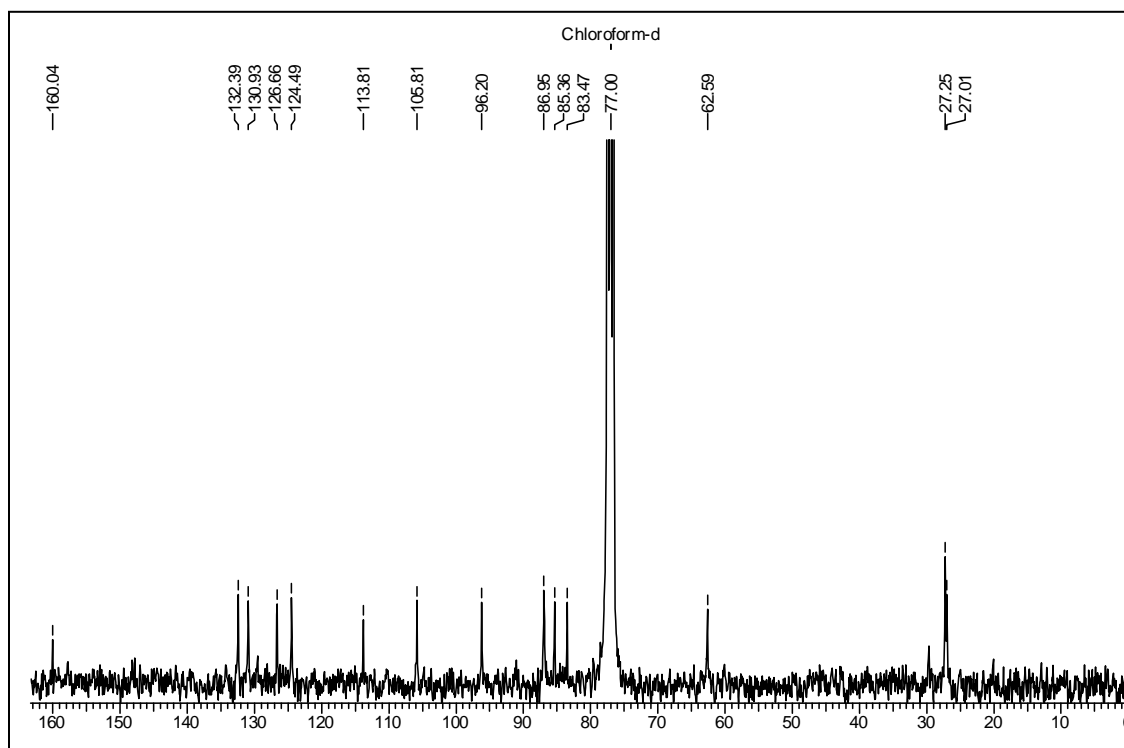


^{13}C NMR Spectrum of 110 in CDCl_3

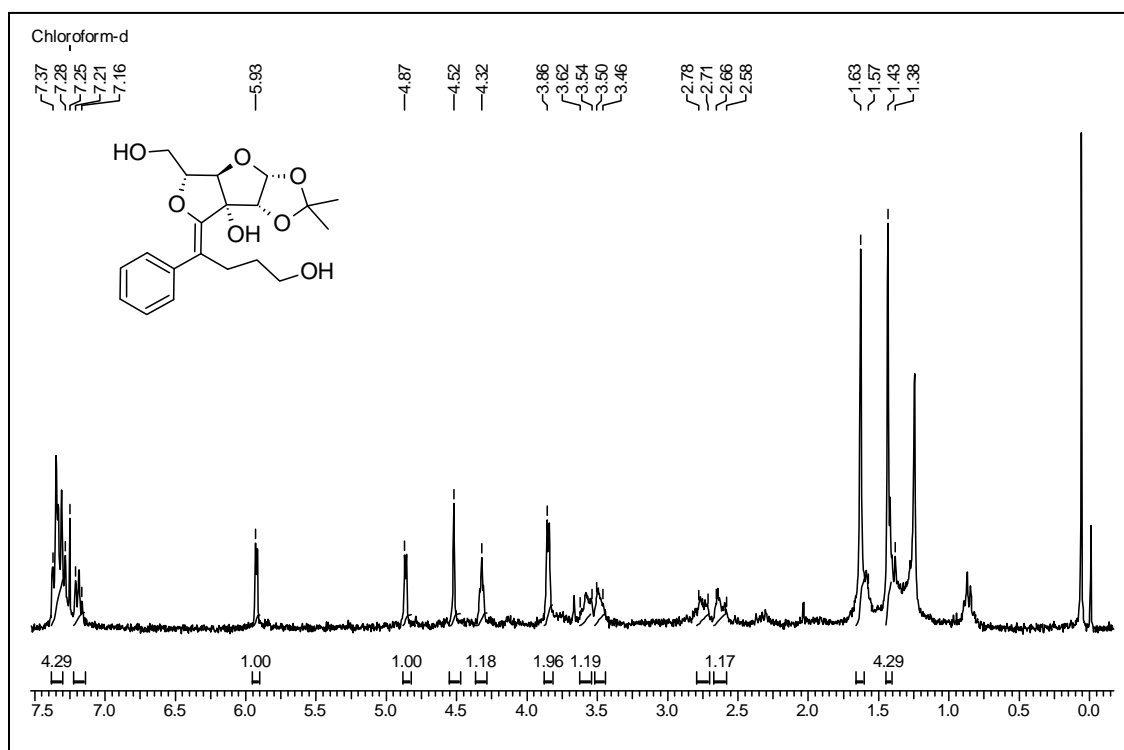
 ^1H NMR Spectrum of 111 in CDCl_3  ^{13}C NMR Spectrum of 111 in CDCl_3



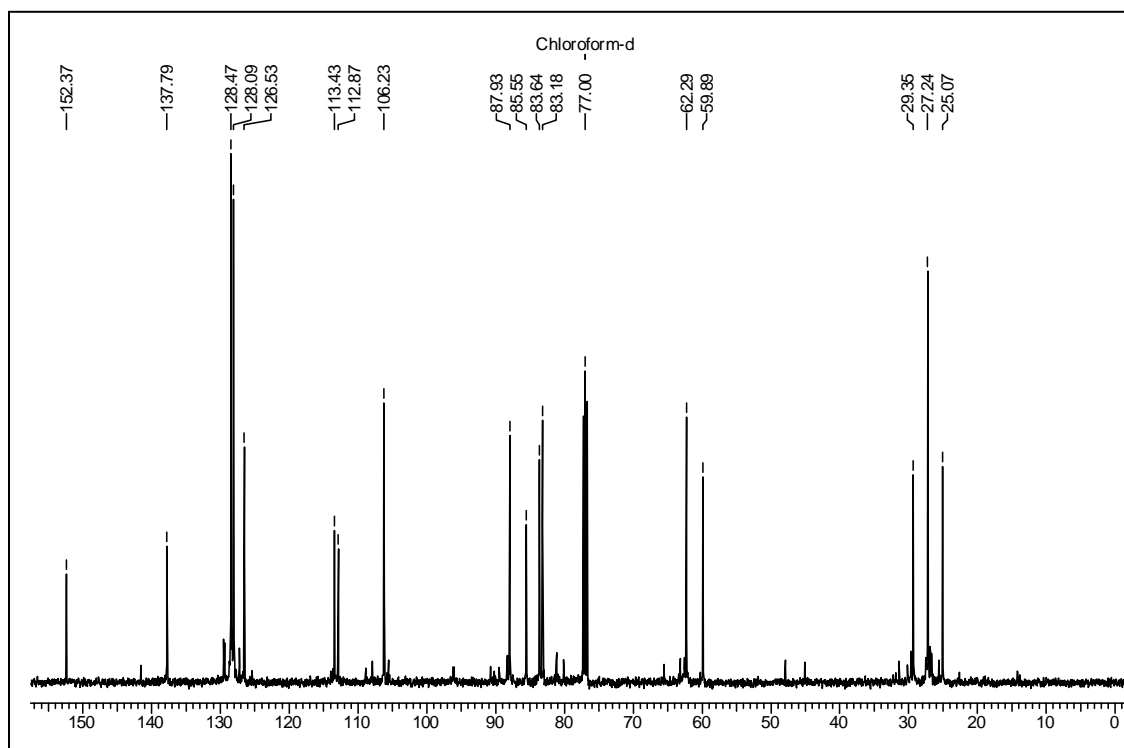
^1H NMR Spectrum of 112 in CDCl_3



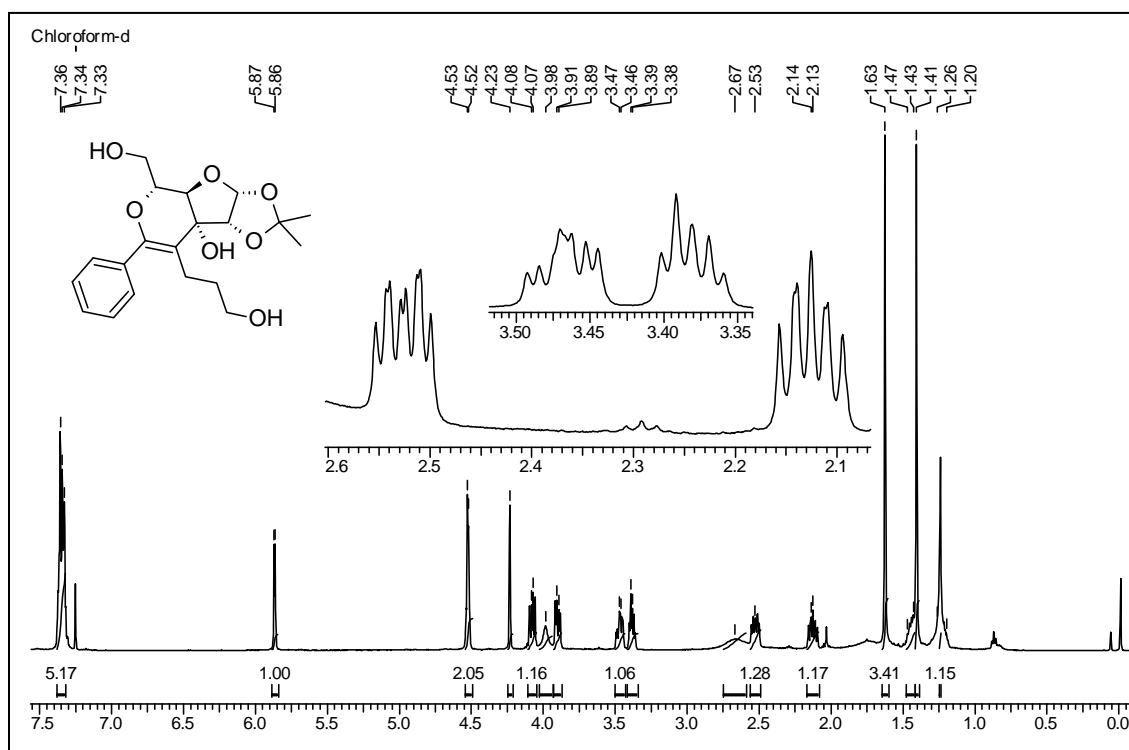
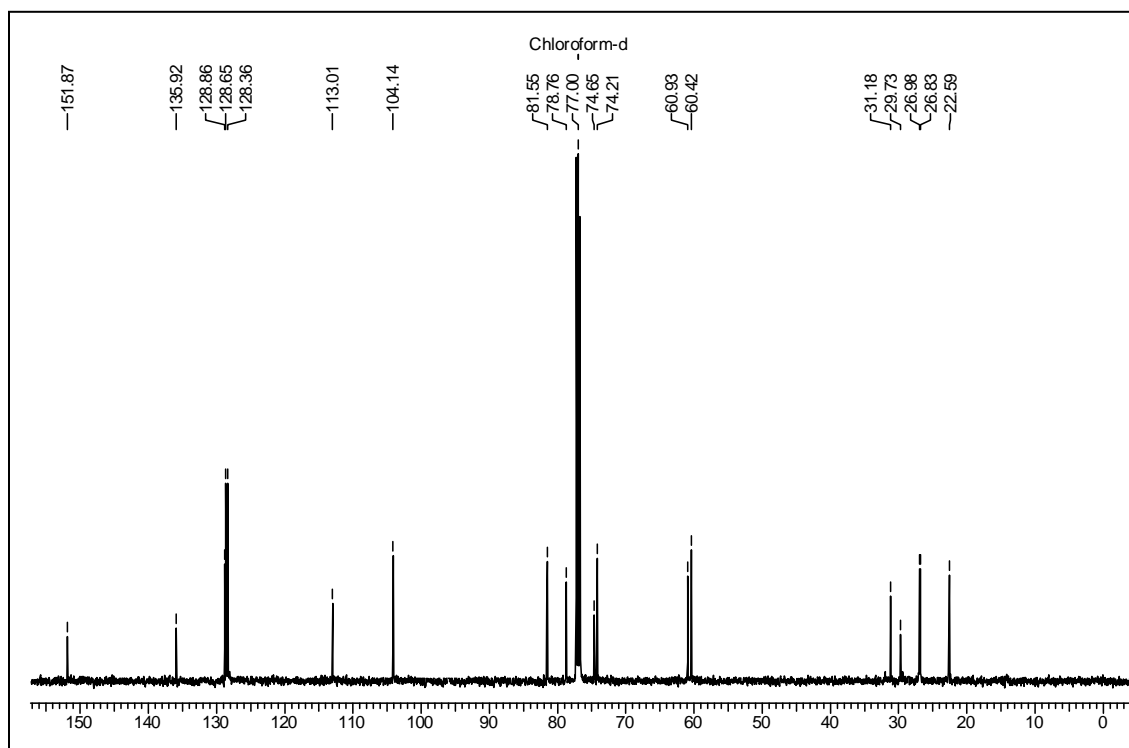
^{13}C NMR Spectrum of 112 in CDCl_3

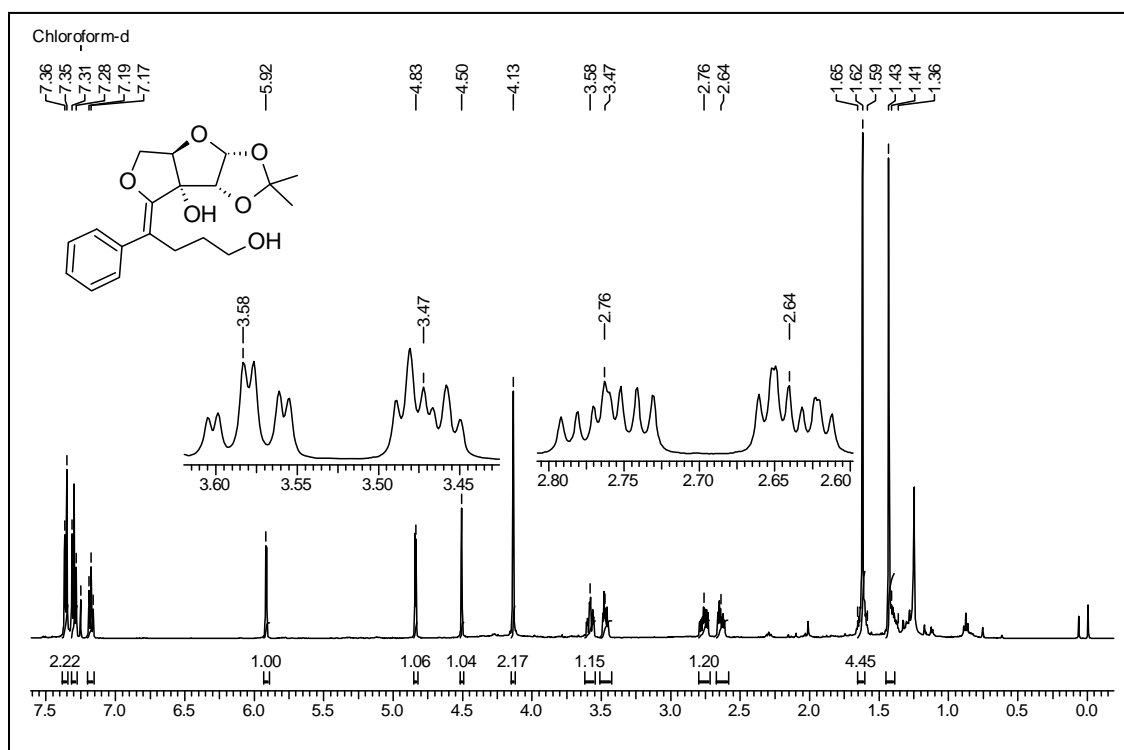
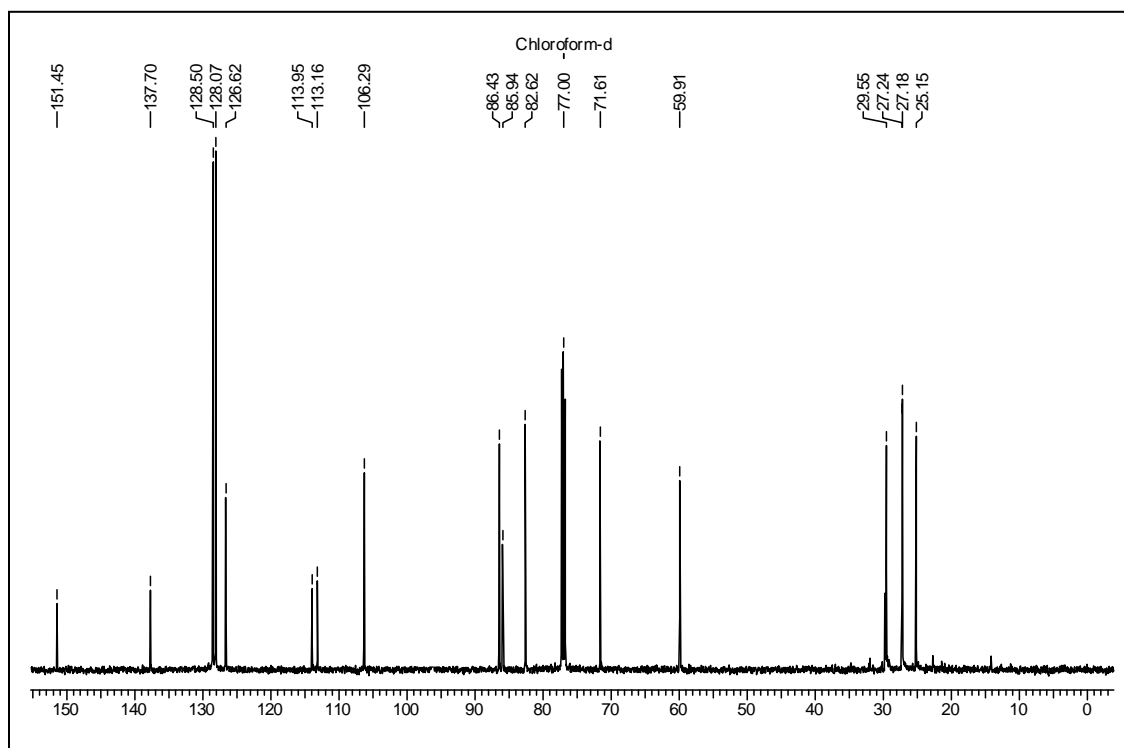


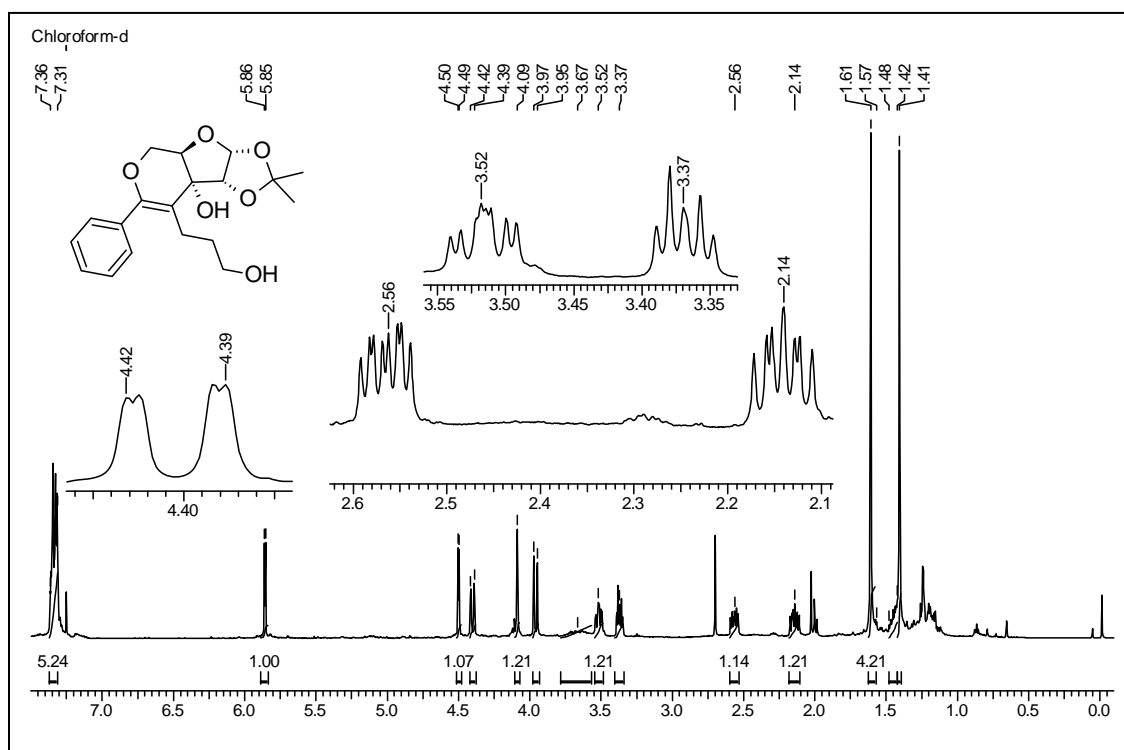
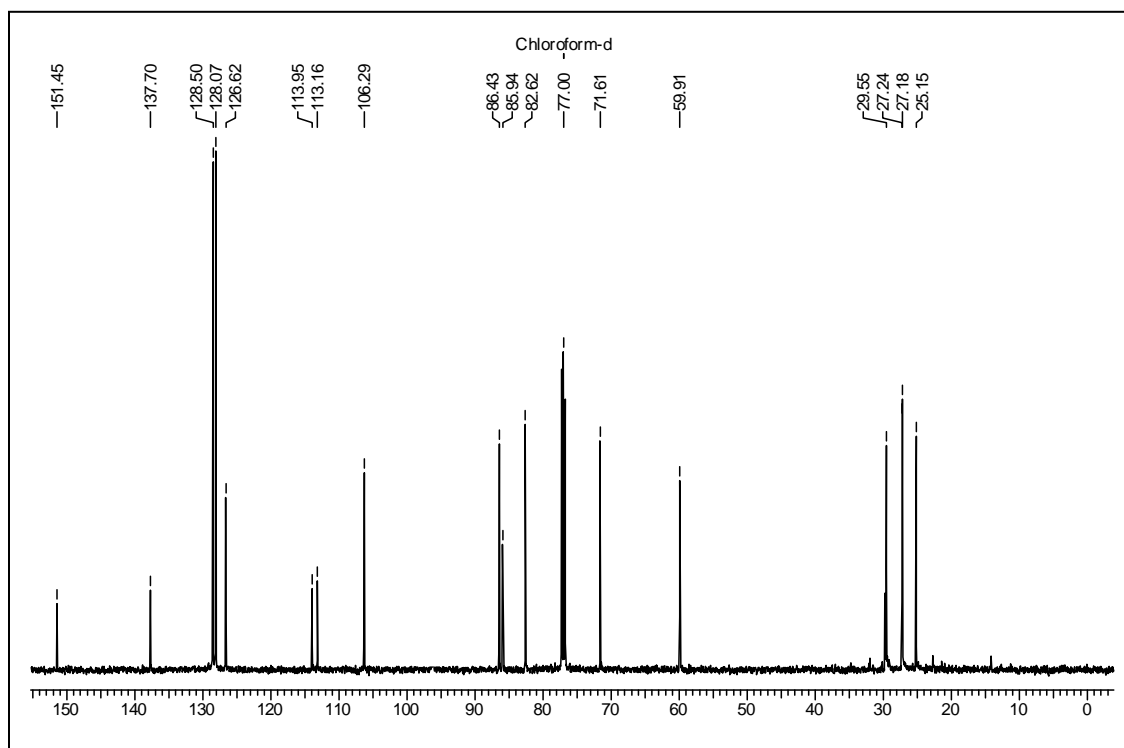
^1H NMR Spectrum of 113 in CDCl_3



^{13}C NMR Spectrum of 113 in CDCl_3

 ^1H NMR Spectrum of 114 in CDCl_3  ^{13}C NMR Spectrum of 114 in CDCl_3

 ^1H NMR Spectrum of 115 in CDCl_3  ^{13}C NMR Spectrum of 115 in CDCl_3

 ^1H NMR Spectrum of 116 in CDCl_3  ^{13}C NMR Spectrum of 116 in CDCl_3

1.5 REFERENCES

- (a) Ambrosio, M. D'; Guerriero, A.; Debitus, C.; Pietra, F. *Helv. Chim. Acta* **1996**, *79*, 51. (b) Arnone, A.; Assante, G.; Nasini, G.; Vajna de Pava O. *Phytochemistry* **1990**, *29*, 613. (c) Searle, P. A.; Molinski, T. F. *J. Am. Chem. Soc.* **1995**, *117*, 8126. (d) Kita, M.; Uemura, D. *Chem. Lett.* **2005**, *34*, 454.
- (a) Baeyer, A.; Villiger, V. *Ber.* **1899**, *32*, 3625. (b) Krow, G. R. *Org. React.* **1993**, *43*, 251. (c) Huang, Y.; Rawal, V. H. *Org. Lett.* **2000**, *2*, 3321. (d) Doyle, M. P.; Phillips, I. M.; Hu, W. *J. Am. Chem. Soc.* **2001**, *123*, 5366.
- (a) Nakamura, I.; Yamamoto, Y. *Chem. Rev.* **2004**, *104*, 2127. (b) Deiters, A.; Martin, S. F. *Chem. Rev.* **2004**, *104*, 2199. (c) Barluenga, J.; Santamaría, J.; Tomás, M. *Chem. Rev.* **2004**, *104*, 2259. (d) Zeni, G.; Larock, R. C. *Chem. Rev.* **2004**, *104*, 2285. (e) Muzart, J. *Tetrahedron* **2005**, *61*, 5955.
- (a) L. S. Hegeudus, *Transition Metals in the Synthesis of Complex Organic Molecules*, 2nd ed., University Science Books, Sausalito, **1999**. (b) E. Negishi, *Handbook of Organopalladium Chemistry for Organic Synthesis*, Wiley Interscience, New York, **2002**.
- (a) Hartley, F. R. *The Chemistry of Platinum and Palladium*; Applied Science: London, **1972**. (b) Hosokawa, T.; Miyagi, S.; Murahashi, S.; Sonoda, A. *J. Org. Chem.* **1978**, *43*, 2752. (c) Kharasch, M. S.; Seyler, R. C.; Mayo, R. R. *J. Am. Chem. Soc.* **1938**, *60*, 882.
- (a) Zeni, G.; Larock, R. C. *Chem. Rev.* **2004**, *104*, 2285.
- Fournet, G.; Balme, G.; Goré, J. *Tetrahedron Lett.* **1987**, *28*, 4533.
- Balme, G.; Bouyssi, D. *Tetrahedron* **1994**, *50*, 403.
- a) Heck, R. F. *Acc. Chem. Res.* **1979**, *12*, 146. b) Heck, R. F. *Org. React.* **1982**, *27*, 345. (c) Beletskaya, I. P.; Cheprakov, A. V. *Chem. Rev.* **2000**, *100*, 3009 and references cited therein.
- Sonogashira, K.; Tohda, Y.; Hagihara, N. *Tetrahedron Lett.* **1975**, 4467.
- (a) Fournet, G.; Balme, G.; Van Hemelryck, B.; Goré, J. *Tetrahedron Lett.* **1990**, *31*, 5147. (b) Fournet, G.; Balme, G.; Goré, J. *Tetrahedron* **1991**, *47*, 6293.
- Coudanne, I.; Balme, G. *Synlett.* **1998**, 998.

13. Tsuda, T.; Ohashi, Y.; Nagahama, N.; Sumiya, R.; Saegusa, T. *J. Org. Chem.* **1988**, *53*, 2650.
14. Bouyssi, D.; Goré, J.; Balme, G. *Tetrahedron. Lett.* **1992**, *33*, 2811.
15. Bouyssi, D.; Goré, J.; Balme, G.; Louis, D.; Wallach, J. *Tetrahedron Lett.* **1993**, *34*, 3129.
16. Jacobi, P. A.; Liu, H. *J. Org. Chem.* **1999**, *64*, 1778.
17. (a) Cavicchioli, M.; Bouyssi, D.; Goré, J.; Balme, G. *Tetrahedron Lett.* **1996**, *37*, 1429. (b) Cavicchioli, M.; Decortiat, S.; Bouyssi, D.; Goré, J.; Balme, G. *Tetrahedron* **1996**, *52*, 11463.
18. Garçon, S.; Vassiliou, S.; Cavicchioli, M.; Hartmann, B.; Monteiro, N.; Balme, G. *J. Org. Chem.* **2001**, *66*, 4069.
19. Luo, F.-T.; Wang, R.-T. *Tetrahedron Lett.* **1992**, *33*, 6835.
20. Jacobi, P. A.; Liu, H. *J. Org. Chem.* **2000**, *65*, 7676.
21. (a) Arcadi, A.; Cacchi, S.; Marinelli, F. *Tetrahedron Lett.* **1992**, *33*, 3915. (b) Cacchi, S.; Fabrizi, G.; Pace, P.; Marinelli, F. *J. Org. Chem.* **1998**, *63*, 1001. (c) Battistuzzi, G.; Cacchi, S.; Fabrizi, G.; Marinelli, F.; Parisi, L. M. *Org. Lett.* **2002**, *4*, 2409. (d) Cacchi, S.; Fabrizi, G.; Pace, P.; Marinelli, F. *Synlett* **1999**, 620.
22. Saulnier, M. G.; Frennesson, D. B.; Deshpande, M. S.; Vyas, D. M. *Tetrahedron Lett.* **1995**, *36*, 7841.
23. Wei, L.-M.; Lin, C.-F.; Wu, M.-J. *Tetrahedron Lett.* **2000**, *41*, 1215.
24. Pauson, P. L. *Tetrahedron* **1985**, *41*, 5855.
25. Sharma, G. V. M.; Subash Chander, A.; Krishnudu, K.; Radha Krishna, P. *Tetrahedron Lett.* **1998**, *39*, 6957.
26. (a) Vasella, A. *Helv. Chim. Acta.* **1977**, *60*, 426. (a) Vasella, A. *Helv. Chim. Acta.* **1977**, *60*, 1273.
27. (a) Schumacher, R. Reissing, H. U. *Synlett* **1996**, 1121. (b) Enholm, E. J., Cottone, J. S.; Allais, F. *Org. Lett.* **2001**, *3*, 145. (c) Ross, G. F.; Herdtweck, E.; Ugi, I. *Tetrahedron* **2002**, *58*, 6127. (d) Huang, L.-L.; Xu, M.-H.; Lin, G.-Q. *J. Org. Chem.* **2005**, *70*, 529.

28. (a) Muzart, J. *Tetrahedron* **2005**, *61*, 5955. (b) Xu, C.; Negishi, E.-C. In *Handbook of Organopalladium Chemistry for Organic Synthesis*; Negishi, E.-C., Ed.; John Wiley & Sons, Inc.: **2002**; Vol. 1, p 2289.
29. (a) Walsh, D. P.; Chang, Y.-T. *Chem. Rev.* **2006**, *106*, 2476. (b) Tan, D. S. *Nat. Chem. Biol.* **2005**, *1*, 74. (c) Schreiber, S. L.; Nicolaou, K. C.; Davies, K. *Chem. Biol.* **2002**, *9*, 1. (d) Schreiber, S. L. *Science* **2000**, *287*, 1964.
30. (a) Zeni, G.; Larock, R. C. *Chem. Rev.* **2004**, *104*, 2285. (b) Alonso, F.; Yus, M.; Beletskaya, I. P. *Chem. Rev.* **2004**, *104*, 3079. (c) Beller, M.; Seayad, J.; Tillack, A.; Jiao, H. *Angew. Chem.; Int. Ed.* **2004**, *43*, 3368. (d) Li, J. J.; Gribble, G. W. *Palladium in Heterocyclic Chemistry* **2000**. (e) Poli, G.; Giambastiani, G.; Heumann, A. *Tetrahedron* **2000**, *56*, 5959. (f) Cacchi, S. *J. Organomet. Chem.* **1999**, *576*, 42. (g) Utimoto, K. *Pure Appl. Chem.* **1983**, *55*, 1845.
31. (a) Pt: Qian, H.; Han, X.; Widenhofer, R. A. *J. Am. Chem. Soc.* **2004**, *126*, 9536. (b) Au: Antoniotti, S.; Genin, E.; Michelet, V.; Genêt, J.-P. *J. Am. Chem. Soc.* **2005**, *127*, 99767. (c) Rh/Ru: Trost, B. M.; Rudd, M. T. *J. Am. Chem. Soc.* **2005**, *127*, 4763. (d) Trost, B. M.; Rhee, Y. H. *J. Am. Chem. Soc.* **2003**, *125*, 7482. (e) Trost, B. M.; Rhee, Y. H. *J. Am. Chem. Soc.* **2002**, *124*, 2528. (f) Wo: Wipf, P.; Graham, T. H. *J. Org. Chem.* **2003**, *68*, 8798. (g) Mo: McDonald, F. E. *Chem. Euro J.* **1999**, *5*, 3103. (h) Ir: Genin, E.; Antoniotti, S.; Michelet, V.; Genêt, J.-P. *Angew. Chem.; Int. Ed.* **2005**, *44*, 4949.
32. (a) Mitchell, S. S.; Rhodes, D.; Bushman, F. D.; Faulkner, D. J. *Org. Lett.* **2000**, *2*, 1605. (b) González, N.; Rodríguez, J.; Jiménez, C. *J. Org. Chem.* **1999**, *64*, 5705.
33. (a) Baldwin, J. E. *J. Chem. Soc., Chem. Commun.* **1976**, 734. (b) Baldwin, J. E.; Cutting, J.; Dupont, W.; Kruse, L.; Silberman, L.; Thomas, R. C. *J. Chem. Soc., Chem. Commun.* **1976**, 736. (c) Baldwin, J. E. *J. Chem. Soc., Chem. Commun.* **1976**, 738. (d) Baldwin, J. E.; Thomas, R. C.; Kruse, L. I.; Silberman, L. *J. Org. Chem.* **1977**, *42*, 3846. (e) Johnson, C. D. *Acc. Chem. Res.* **1993**, *26*, 476.
34. (a) Elliott, R. J.; Richards, W. G. *J. Mol. Struct. (Theochem.)* **1982**, *87*, 247. (b) Houk, K. N.; Strozier, R. W.; Rozeboom, M. D.; Nagaze, S. *J. Am. Chem. Soc.* **1982**, *104*, 323. (c) Perkins, M. J.; Wong, P. C.; Barrett, J.; Shalival., G. *J. Org.*

- Chem.* **1981**, *46*, 2196. (d) Eisenstein, O.; Procter, G.; Dunitz, J. D. *Helv. Chim. Acta.* **1978**, *61*, 2538. (e) Dykstra, C. E.; Arduengo, A. J.; Fukunaga, F. T. *J. Am. Chem. Soc.* **1978**, *100*, 6007. (f) Strozier, R. W.; Caramella, P.; Houk, K. N. *J. Am. Chem. Soc.* **1979**, *101*, 1340.
35. (a) Hiroya, K.; Jouka, R.; Kameda, M.; Yasuhara, A.; Sakamoto, T. *Tetrahedron* **2001**, *57*, 9697. (b) Nakatani, K.; Okamoto, A.; Saito, I. *Tetrahedron* **1996**, *52*, 9427. (c) Padwa, A.; Krumpke, K. E.; Weingarten, M. D. *J. Org. Chem.* **1995**, *60*, 5595. (d) Weingarten, M. D.; Padwa, A. *Tetrahedron Lett.* **1995**, *36*, 4717. (e) Torii, S.; Okumoto, H.; Xu, L. H.; Sadakane, M.; Shostakovskiy, M. V.; Ponomaryov, A. B.; Kalinin, V. N. *Tetrahedron* **1993**, *49*, 6773.
36. (a) Gulías, M.; Rodríguez, J. R.; Castedo, L.; Mascareñas, J. L. *Org. Lett.* **2003**, *5*, 1975. (b) Trost, B. M.; Horne, D. B.; Woltering, M. J. *Angew. Chem.; Int. Ed.* **2003**, *42*, 5987. (c) Gabriele, B.; Salerno, G.; Fazio, A.; Pittelli, R. *Tetrahedron* **2003**, *59*, 6251. (d) Marshall, J. A.; Yanik, M. M. *Tetrahedron Lett.* **2000**, *41*, 4717. (e) Fukuda, Y.; Shiragami, H.; Utimoto, K.; Nozaki, H. *J. Org. Chem.* **1991**, *56*, 5816. (f) Luo, F.-T.; Schreuder, I.; Wang, R.-T. *J. Org. Chem.* **1992**, *57*, 2213.
37. (a) Alonso, F.; Yus, M.; Beletskaya, I. P. *Chem. Rev.* **2004**, *104*, 3079. (b) Beller, M.; Seayad, J.; Tillack, A.; Jiao, H. *Angew. Chem.; Int. Ed.* **2004**, *43*, 3368. (c) Li, J. J.; Gribble, G. W. *Palladium in Heterocyclic Chemistry*; Pergamon: Oxford, UK, **2000**. (d) Poli, G.; Giambastiani, G.; Heumann, A. *Tetrahedron* **2000**, *56*, 5959. (e) Cacchi, S. *J. Organomet. Chem.* **1999**, *576*, 42. (f) Utimoto, K. *Pure Appl. Chem.* **1983**, *55*, 1845.
38. (a) Sharma, G. V. M.; Reddy, J. J.; Rao, M. H. V. R.; Gallois, N. *Tetrahedron Asymmetry* **2002**, *13*, 1599. (b) Matsuda, A.; Hattori, H.; Tanaka, M.; Sasaki, T. *Bioorg. Med. Chem. Lett.* **1996**, *6*, 1887. (c) Sano, T.; Ueda, T. *Chem. Pharm. Bull.* **1986**, *34*, 423.
39. (a) Witulski, B.; Alayrac, C.; Arnautu, A.; Collot, V.; Rault, S.; Azcon, J. R. *Synthesis* **2005**, 771. (b) Hundertmark, T.; Littke, A. F.; Buchwald, S. L.; Fu, G. C. *Org. Lett.* **2000**, *2*, 1729. (c) Nguéfacq, J.-F.; Bolitt, V.; Sinou, D. *Tetrahedron*

- Lett.* **1996**, *37*, 5527. (d) Sonogashira, K.; Tohda, Y.; Hagihara, N. *Tetrahedron Lett.* **1975**, *16*, 4467.
40. (a) Qureshi, S.; Shaw, G. *J. Chem. Soc. Perkin Trans. 1* **1985**, 875. (b) Baker, D. C.; Brown, D. K.; Horton, D.; Nickol, R. G. *Carbohydr. Res.* **1974**, *32*, 299.
41. Yoshimura, J.; Sato, K. -I.; Wakai, H.; Funabashi, M. *Bull. Chem. Soc. Jpn.* **1976**, *49*, 1169.
42. (a) Liu, G.; Lu, X. *Org. Lett.* **2001**, *3*, 3879. (b) Lei, A.; Lu, X. *Org. Lett.* **2000**, *2*, 2699. (c) Wang, Z.; Lu, X. *J. Org. Chem.* **1996**, *61*, 2254.
43. (a) Scheffknecht, C.; Peringer, P. *J. Organomet. Chem.* **1997**, *535*, 77 and references cited there in. (b) Lucchini, V.; Modena, G. *J. Am. Chem. Soc.* **1990**, *112*, 6291.
44. (a) Riediker, M.; Schwartz, J. *J. Am. Chem. Soc.*, Vol. **1982**, *104*, 5842. (b) Luo, F-T.; Schreuder, I.; Wang, R-T. *J. Org. Chem.* **1992**, *57*, 2213.
45. (a) Xu, M.; Miao, Z.; Bernet, B.; Vasella, A. *Helv. Chim. Acta* **2005**, *88*, 2918. (b) Miao, Z.; Xu, M.; Hoffmann, B.; Bernet, B.; Vasella, A. *Helv. Chim. Acta* **2005**, *88*, 1885.
-
-

Chapter II:

Studies Towards The Total Synthesis of Cyclodidemniserinol Trisulfate

2.1 INTRODUCTION

Bicyclic ketal unit is one of the common units present in many of insect and animal pheromones. The initial interest in the field of bicyclic ketals synthesis thus stems from the fact that these constitute as a basic skeleton in a wide variety of these pheromones, and that physiological and biological aspects of pheromones which aid in the behavioural and ecological studies.¹ The pheromones frontalin (**1**), multistriatin (**2**), *exo*-brevicommin (**3**) play a decisive role in the communication system of bark beetles and other insects and are used on a large scale in traps for the protection of forests. The male pheromone (**4**) of the hepialid moth, *Endocrita excrescens* represents one of the several important insect pheromones containing a bicyclic ketal core as in brevicomin (*vide infra*) (Figure 1).

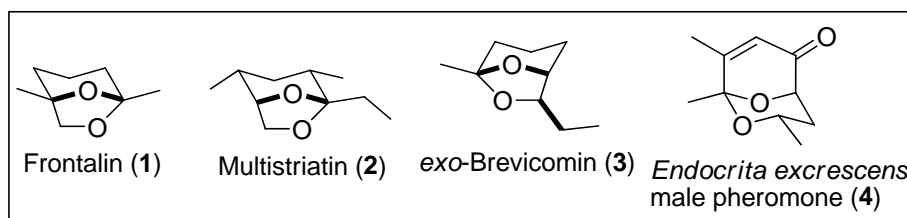


Figure 1: Some representative pheromones containing key bicyclic ketal unit.

The synthesis of **1–4** and their stereoisomers were highly desirable in the study of structure-activity relationships and in pest management and resulted in several syntheses since early 80's (Figure 2).

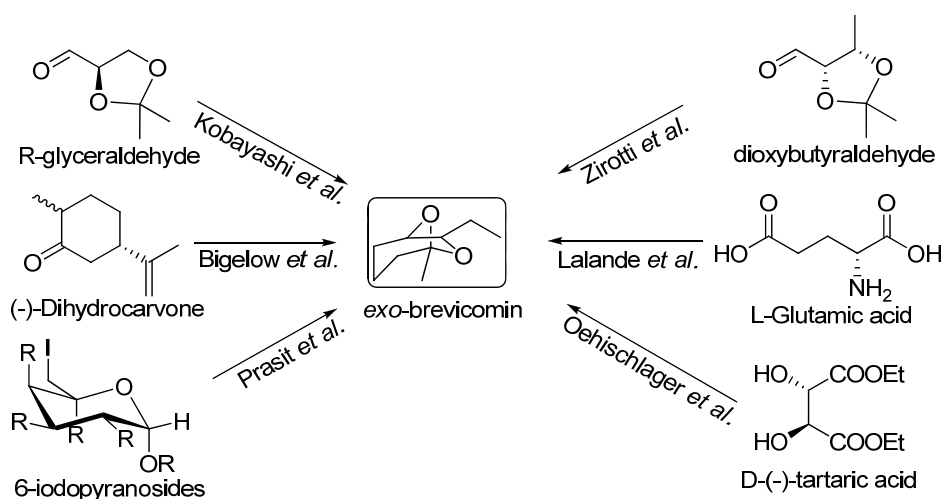


Figure 2: Literature syntheses of *exo*-brevicommin (**3**).

Apart from the insect pheromones, various natural products having significant biological activities were isolated in recent past comprising bicyclic ketal core. The presence of bicyclic ketal system in wide variety of natural products ranging from small and simple molecules such as Buergenin F (**5**) and Buergenin G (**6**),² as well as in more intricate and large molecules such as polytoxins is remarkable.

However, new methodological advancements in the area of bicyclic ketal synthesis remained dormant until the isolation³ of another class of bicycle [3,2,1] octanes wherein a renewed interest was observed owing to their marked biological significance.

Buergenin F (**5**) has been known to be antiphogistic and febrifuge agent. Zaragozic acid (**7**) and its derivatives were shown to be potent inhibitors of squalene synthase, the enzyme catalyzing the first committed step in cholesterol biosynthesis. Therefore, the zaragozic acids are promising lead compounds for the development of new cholesterol-lowering drugs. Additionally, members of this class of compounds were shown to inhibit ras farnesyl transferase, and thus have potential as antitumor agents. Attenol B (**8**) has shown cytotoxicity ($IC_{50} = 24 \mu\text{g/mL}$) against the P388 cancer cell line and tirandamycin A (**9**) is a potent inhibitor of terminal DNA transferase and bacterial RNA polymerase, as well as a strong antibiotic against Gram-positive organisms. More recently isolated saliniketals⁴ (**10**) were found to inhibit ornithine decarboxylase induction, an important target for the chemoprevention of cancer (Figure 3). The pectenotoxin (**11**) and pinnatoxins (**12**) are potent shellfishtoxins which also incorporate this bicyclic moiety. Cyclodidemniserinol trisulfate (**15**) is structurally similar to the didemniserinolipids (*vide infra*) and a potent HIV-1 integrase inhibitor.

Clearly, a vast array of biological activities and structural complexities are encompassed among bicyclic ketal-containing natural products, making efficient and novel methods for their construction an important goal in organic synthesis and have provided interest in synthetic community to explore new approaches for and the utilization of bicyclic ketal core as a suitable scaffold of focused compound libraries. But our interest in choosing cyclodidemniserinol trisulfate as our target was manifold. First of all, it is a nonsteroidal integrase inhibitor and in the treatment of HIV-infected people, no clinically useful inhibitors of integrase have been reported till now. Hence, it can be an attractive target for anti-retroviral chemotherapy. Further, cyclodidemniserinol trisulfate

(15) is most closely related to didemniserinolipid B (13) isolated from an Indonesian *Didemnum* sp.,^{3b} with some significant differences between the two structures, most notably the presence of an additional ring containing a glycine unit and the presence of sulfate groups. Though there are a few reports of the synthesis of didemniserinolipid B⁵ including one formal synthesis from our group,⁶ there is no published account on the synthetic advancement towards cyclodidemniserinol (14) or its trisulfate (15).

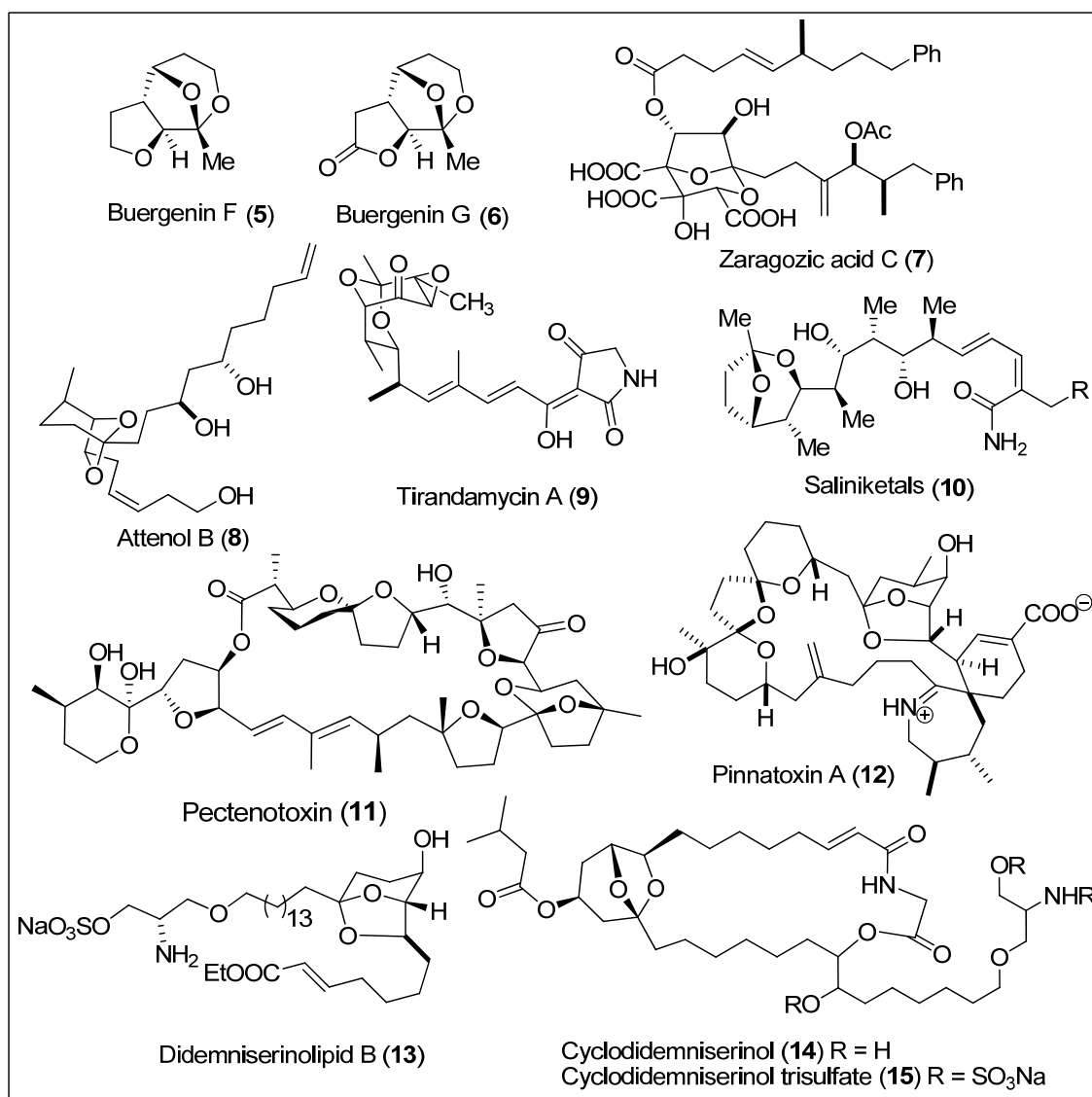


Figure 3: Natural products containing bicyclic ketal core.

Isolation and structure elucidation

Cyclodidemniserinol trisulfate (**15**) was isolated^{3a} from the Palauan ascidian *Didemnum guttatum*, at Ngerchaol Island, Palau. It was a water soluble compound and was purified by repeated reverse phase chromatography.

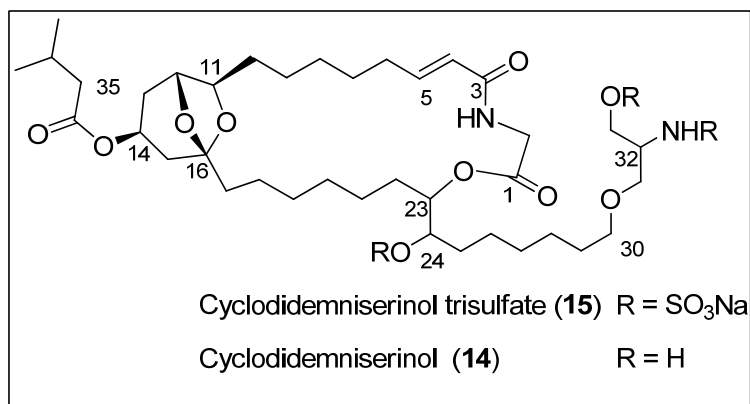


Figure 4

Cyclodidemniserinol trisulfate, $[\alpha]_D -26.6^\circ$, was a colorless oil having molecular formula, C₃₈H₆₃N₂O₁₉S₃Na₃, determined from the high-resolution mass measurement of the $[M-Na]^-$ ion at 993.2961 (Δ 2.7 ppm) and the low resolution mass of the $[M + Na]^+$ ion at m/z 1039. The IR spectrum indicated the presence of the ester (1725 cm⁻¹), α,β -unsaturated amide (3320, 1665, 1625 cm⁻¹), and sulfate (1220 cm⁻¹) groups. An absorption at 210 nm in the UV spectrum was assigned to the α,β -unsaturated amide group. The ¹³C NMR spectrum provided evidence for three carbonyl groups (δ 171.7, 169.5, 165.7), an olefin (δ 143.2, 123.8), a ketal (δ 107.8), and eight carbons bearing oxygen, of which five were methines (δ 79.4, 77.2, 76.3, 74.9, 66.2) and three were methylenes (δ 70.5, 69.8, 65.9).

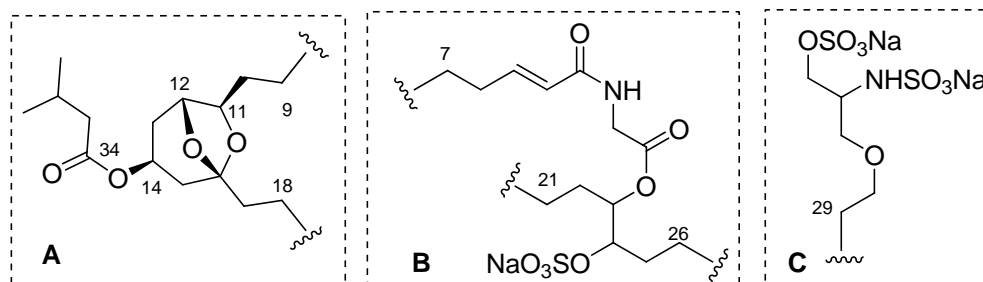


Figure 5

The isovalerate ester residue of substructure **A** (C-34 to C-38) was identified from the ¹H, ¹³C, COSY, HSQC, and HMBC data. There was a three-bond correlation from the

C-34 carbonyl to the H-14 methine signal at δ 5.05 (tt, 1H, $J = 10, 7$ Hz), which was attached to a methine carbon with an unusual upfield chemical shift (δ_C 66.2) signifying further oxygen atoms on the β -carbons. COSY data revealed that H-14 was coupled to methylene signals at δ 2.03 and 1.34 (H₂-15; δ_C 41.0), which showed no further coupling. The H-14 signal was also coupled to methylene signals at 1.98 and 1.58 (H₂-13; δ_C 34.0), that were coupled to a signal at 4.20 (br s, 1H, H-12), which was not coupled further. The ketal at C-16 showed HMBC correlations with the H₂-15, H-12 signal and to the H-11 signal at δ 3.83. The H-11/H-12 dihedral angle of approximately 90° (by molecular modeling) explained the lack of coupling between H-11 and H-12. Strong NOEs from both H-12 and H-14 to H-11 in a ROESY experiment confirmed the structure and allowed assignment of the stereochemistry shown for the bicyclic ketal substructure **A**.

The methylene protons of the glycine unit in substructure **B** showed HMBC correlations to the carbonyl signals at δ_C 169.5 (C-1) and 165.7 (C-3), which in turn was correlated to the olefinic proton signals at 5.95 (d, 1H, $J = 15.5$ Hz, H-4) and 6.65 (dt, 1H, $J = 15.5, 7$ Hz, H-5). From the COSY and HMBC data, the methylene chain could be extended to C-8, but no direct connection with substructure **A** was observed. The HMBC correlation from H-23 signal at δ 4.81 (dt, 1H, $J = 10, 6$ Hz) to C-1 and the COSY correlation to the H-24 signal at 4.11 (dt, 1H, $J = 10, 5$ Hz) revealed that the glycine unit was joined through an ester bond to a vicinal diol, of which the second oxygen must be sulfated to comply with the molecular formula. The HMBC data allowed the alkyl chain to be extended from C-21 to C-26.

The serinol unit in substructure **C** was clearly defined by the NMR data, particularly the HSQC-TOCSY data and the chemical shift of C-32 at δ_C 52.3. The ether linkage was established by the HMBC correlations from the H-31 signals to a methylene carbon signal at δ_C 70.5. The corresponding methylene proton signal at δ_H 3.30 (m, 2H, H-30) showed HMBC correlations to C-28, C-29, and C-31, thereby completing the assignments for substructure **C**, which again showed no carbon signals in common with either substructures **A** or **B**.

A weak correlation between the allylic methylene protons (H₂-6) and H-11 observed in a 70 ms TOCSY experiment, showed the linkage between substructures **A** and **B** but it did not define the length of the carbon chain joining the substructures. The

length of the chain between C-5 and C-11 was determined by oxidative degradation of **15** using acidified potassium permanganate, followed by methylation of the resulting acids using diazomethane to obtain dimethyl pimelate (MeOOC-(CH₂)₅-COOMe), which was detected by GC-MS. The mass spectrum of cyclodidemniserinol (**14**) obtained from acid-catalyzed hydrolysis of **15** contained key peaks at *m/z* 376, 334 and 203 that confirmed length of the A-B linkage and supported the proposed linkages from C-18 to C-21 and from C-26 to C-28.

Biological activity:

Cyclodidemniserinol trisulfate was found to inhibit purified integrase with an IC₅₀ of 60 μg/mL. In contrast with the results obtained for the crude extracts, cyclodidemniserinol trisulfate also inhibited MCV topoisomerase with an IC₅₀ of 72 μg/mL.

Objectives:

Considering the biological importance of various bicyclic ketal containing compounds in general and cyclodidemniserinol trisulfate (**15**) in particular, we intended to take the nascent steps towards the synthesis of its central bicyclic core by utilizing the palladium-mediated cycloisomerization reaction of an alkyne diol as the key reaction.



2.2 PRESENT WORK

Remarkable biological activities exhibited by cyclodidemisnerinol trisulfate has provided sufficient window to explore new approaches for, and the utilization of bicyclic ketal core as a suitable scaffold of focused compound libraries. We were interested to explore the synthetic potential of alkyne diol cycloisomerization for the construction of the bicyclic ketal. Our basic idea behind this program was to provide sufficient scope for the library synthesis by functionalizing the alkyne end with a suitable functional group. Further, having established our strategy for the synthesis of ketals by the palladium mediated cycloisomerizations on sugar based alkyne diols as described in Chapter I, we aimed to synthesize the central bicyclic core by using the Palladium-mediated cycloisomerization reaction of an alkyne diol. The key features of our total synthesis program are depicted in the following retrosynthetic scheme.

Retrosynthesis:

Figure 6 describes the salient bond disconnections made for a convergent synthesis of cyclodidemisnerinoltrisulfate (**15**). Considering the cycloisomerization as the key reaction to achieve the target fragment **17** and keeping the knowledge we acquired with the model cycloisomerization reactions, we have opted to place the alkyne favorably for a *6-endo-dig* cyclization. This led the visualization of a metal mediated alkyne addition to aldehyde placed at right side of the diol substrate **18**. The 7-carbon chain extension at the left part of diol substrate was planned by a 5-carbon Wittig reaction with **20**, which later on would provide the terminal olefin by another one carbon Wittig homologation.

Hence, based upon these key transforms, three fragments **19**, **20** and **21** were identified as important coupling partners for a convergent synthesis of the advanced intermediate **18**. After rigorous stereochemical comparisons, synthesis of key diol precursor **19** was intended from diacetone **23** which in turn could be obtained from D-gluconolactone. The alkyne **21** was envisioned to be obtained from mono protected 1,8-octanediol **22** using Ohira-Bestmann reagent.

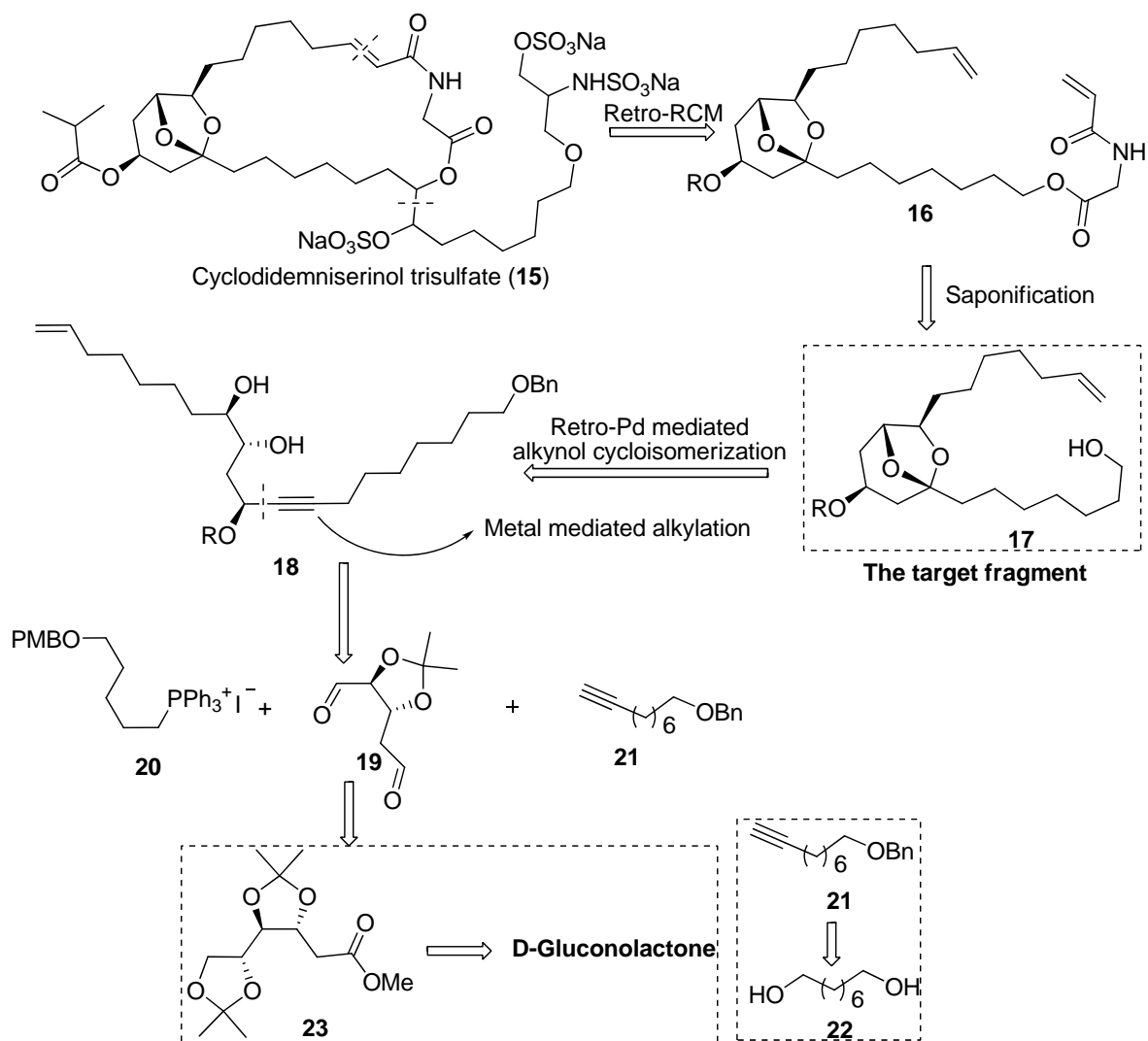
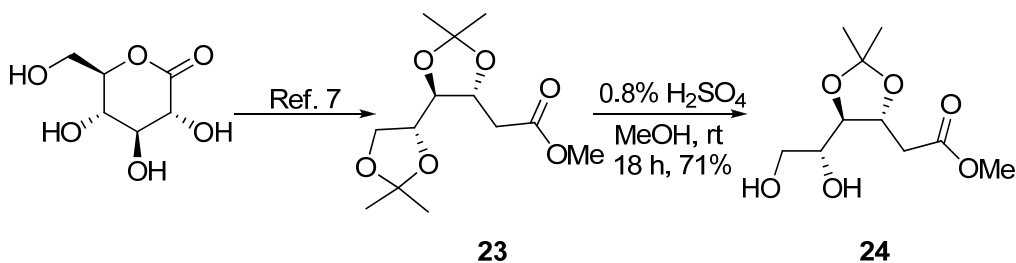


Figure 6: Retrosynthetic strategy for cyclodidemniserinoltrisulfate (**15**)

Synthesis:

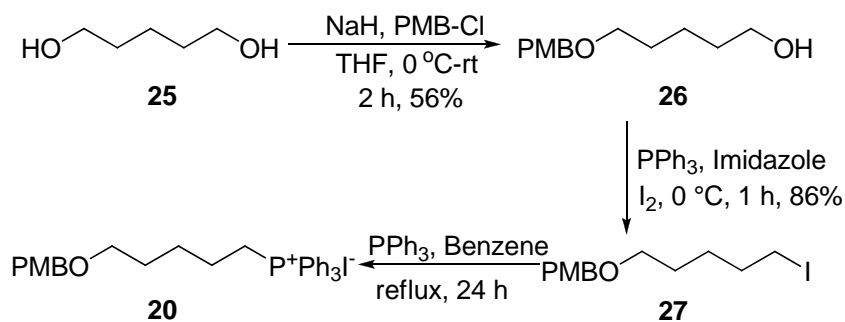
As intended, the synthesis was started from the D-gluconolactone which was converted to the corresponding diacetone **23** following the known procedure.⁷

Compound **23** was treated with 0.8% H₂SO₄ in MeOH to get the diol **24**, which would provide the aldehyde precursor for Wittig reaction.



Scheme 1

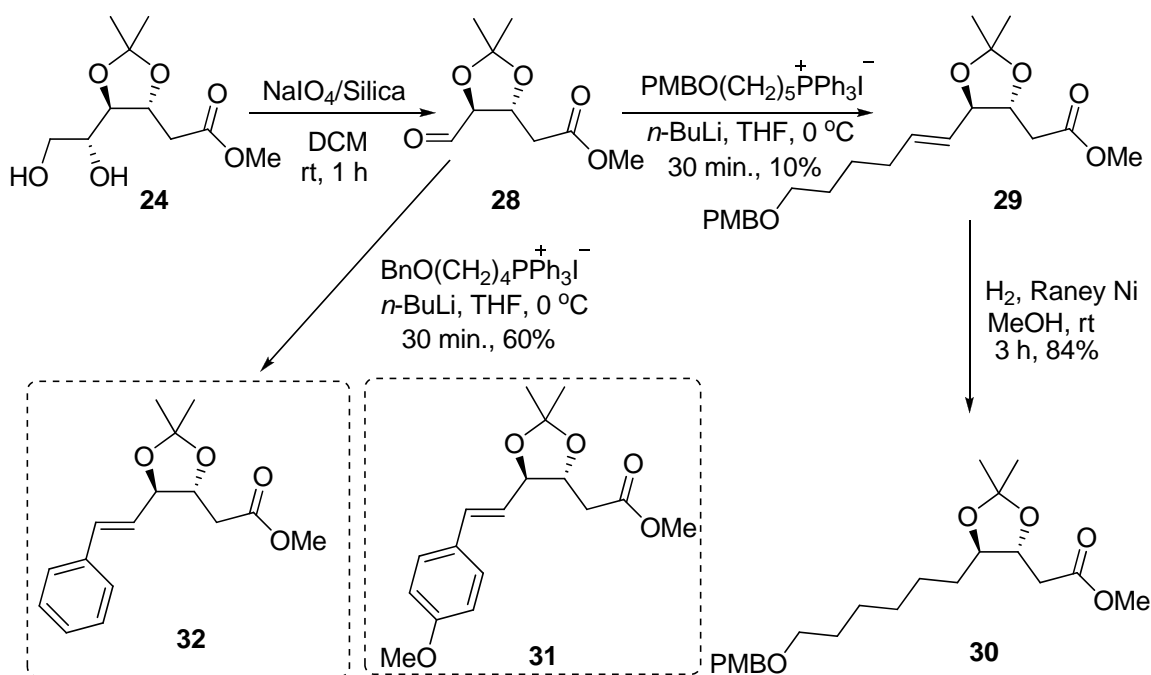
The requisite 5-carbon Wittig salt was synthesized from 1,5-pentane diol **25** which was selectively mono protected as its 4-methoxy benzyl ether **26**. Iodination of the resulting alcohol **26** using triphenylphosphine afforded the iodide **27** (Scheme 2). The preparation of the Wittig salt was a difficult task. We tried different solvents such as diethylether, benzene and toluene, and ended up with a sticky thick liquid as the salt with benzene and toluene even after prolonged heating.



Scheme 2

The oxidative cleavage of the diol **24** using NaIO_4 gave the intermediate aldehyde **28** which was further used for Wittig reaction without purification. Aldehyde **28** was treated with the ylide generated in situ from the treatment of **20** with *n*-BuLi. Formation of Wittig product **29** was confirmed by the presence of two olefinic protons at 5.36 ppm (ddt, $J = 1.5, 9.2, 10.9$ Hz, 1H) and 5.70 ppm (dt, $J = 7.4, 10.9$ Hz, 1H) in $^1\text{H-NMR}$ and resonances of the corresponding carbons at 125.5 (d) and 136.8 (d) in $^{13}\text{C-NMR}$. As the double bond was not required, it was reduced by using Raney Ni in H_2 atmosphere to get hydrogenated compound **30**. Disappearance of olefinic peaks in $^1\text{H-NMR}$ and appearance of two more methylene carbons in aliphatic region (25.9 to 29.6 ppm) in $^{13}\text{C-NMR}$ as compared to **29** accounted for the saturated product **30** (Scheme 3). Unfortunately Wittig

reaction was of very poor yield ($\leq 10\%$) and also not reproducible. Each time we repeated the reaction with different bases such as KO^tBu and NaHMDS , we got an undesired side product **31** either as major or as sole product. The product had all the expected protons of sugar part and aromatic protons as well. But there was not a single proton in aliphatic region. Also, the olefin protons were resonated quite downfield (a doublet of doublet at 5.56 ppm with $J = 9.2, 11.4$ Hz and a doublet at 6.74 ppm with $J = 11.4$ Hz).

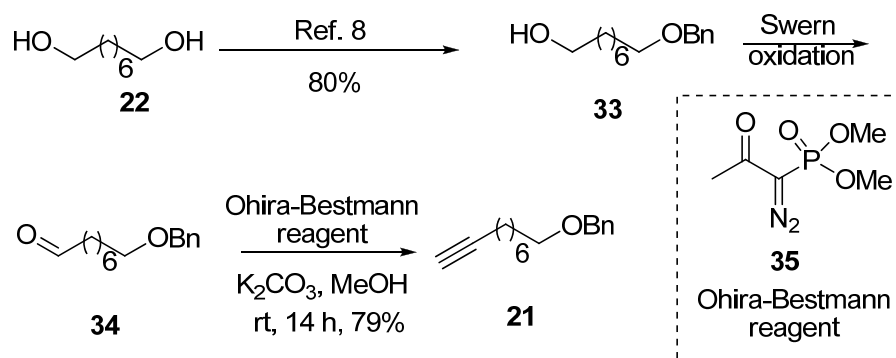


Scheme 3

Being unable to make out the actual structure of the product initially, we suspected our Wittig salt for its purity. To verify the result, we tried the same reaction with a similar but rather reliable and reported Wittig salt $\text{BnO}(\text{CH}_2)_4\text{P}^+\text{Ph}_3\text{I}^-$ and once again we landed up with a similar kind of product **32** as earlier along with traces of respective Wittig homologated product. The olefin protons appeared at 5.66 ppm (dd, $J = 9.4, 11.5$ Hz, 1H) and 6.83 ppm (d, $J = 11.5$ Hz, 1H). The ^{13}C -NMR indicated presence of 15 carbons and mass spectra showed a peak of 299.23 for $[\text{M}+\text{Na}]^+$ which vouched for the structure **32** (Scheme 3).

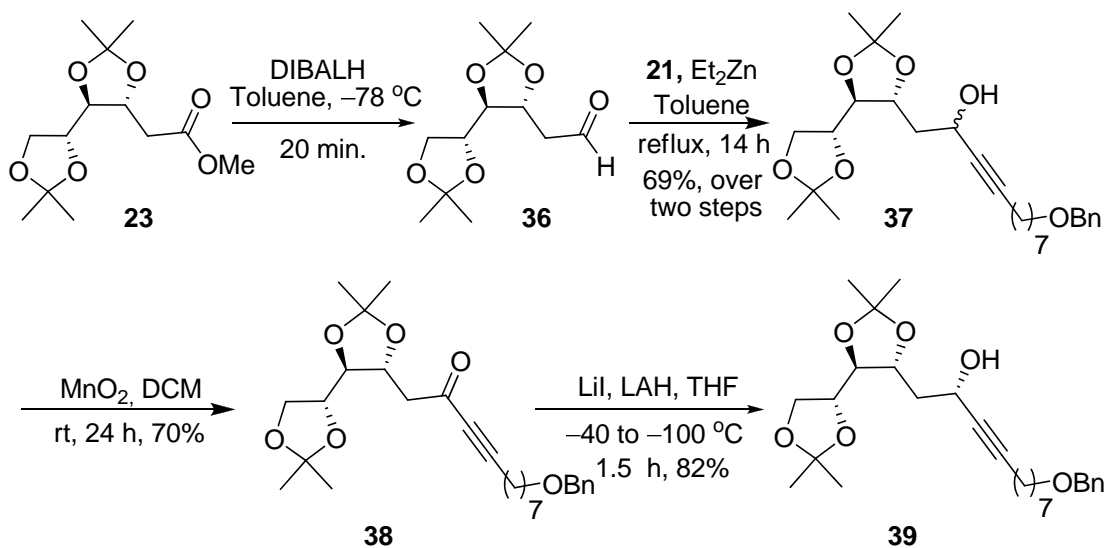
After being unsuccessful to execute the planned Wittig homologation at the initial stages, we thought to carry on the synthesis from right side of the molecule, i.e. introduction of the alkyne fragment to the substrate.

The synthesis of 9-carbon alkyne fragment was started from 1,8-octanediol. The 1,8-octanediol **22** was selectively protected as its mono benzyl ether **33** following the literature procedure⁸ using NaOH and BnBr in presence of 15-crown-5 ether with 80% yield. Alcohol **33** was oxidized under Swern conditions using DMSO and oxalyl chloride to get the aldehyde **34** which was then exposed to Ohira-Bestmann reagent⁹ employing K₂CO₃ as a base to procure the terminal alkyne product **21** in good yields. The formation of **21** was substantiated by the presence of a triplet proton at 1.93 ppm (HC≡C-) (Scheme 4).



Having the alkyne fragment **21**, our immediate concern was its stereoselective addition to the sugar moiety. Hence the methyl ester **23** was subjected to a controlled reduction to aldehyde using DIBAL-H in toluene at -78°C and subjected to a modified Careirra alkynylation condition where the zinc acetylide was prepared *in situ* by Et₂Zn.¹⁰ Though, the required alkyne addition to aldehyde was found to be facile with Et₂Zn, Ti(O^{*i*}Pr)₄ and (*S*)-BINOL, however, the diastereomeric ratio was very poor. A similar diastereomeric ratio was observed when the reaction was carried out without chiral ligand (*S*)-BINOL. This prompted us to carry the alkynylation reaction without the chiral ligand. The optimized conditions for the alkynylation involves the heating of a solution of alkyne **21** with Et₂Zn in toluene at reflux temperatures, then the resulting solution was added to aldehyde **36** to achieve diastereomeric mixture (6:4) of **37** in fairly good yields. Presence of peaks for alkyne carbons at 80.3 (s), 80.6 (s) and 85.5 (s) ppm supported the structure of **37**.

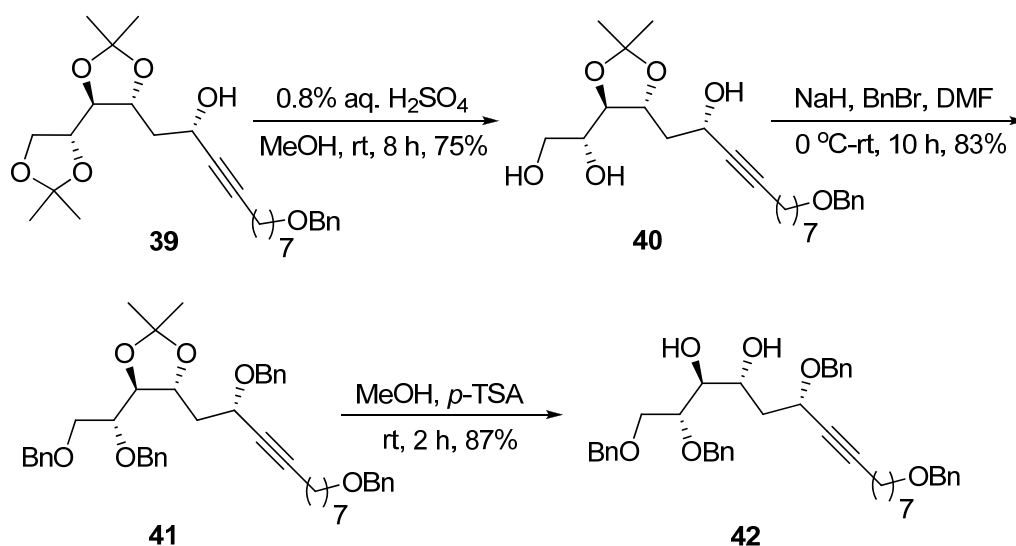
To oxidize the resulted propargylic –OH group, we applied some general oxidation procedures. PDC was found to be unsuccessful in oxidizing the alcohol **37**. Under Swern conditions, the yields are poor and with IBX, the reaction proceeded slowly which caused the decomposition of product due to long standing in reaction condition. Finally, when MnO₂ was used as the oxidizing agent, though the reaction was slow, the product was stable in the reaction conditions and no unwanted side product was observed. Ketone **38** was then subjected to selective 1,3-*syn* reduction in presence of LiI-LAH¹¹ at –100 °C. The structure of the reduced product **39** was confirmed from its ¹H- and ¹³C-NMR spectral data and elemental analysis. Each methyl of the two isopropylidene groups appeared as clean singlets indicating compound **39** to be a single isomer (Scheme 5).



Scheme 5

At this point, having the desired alkyne and prospective diol in place, we felt the urge for a trial of our much awaited cycloisomerization with this immature substrate and to observe whether the reaction would follow an *exo*- or an *endo*- mode of cyclization. As a result, the terminal isopropylidene group was deprotected by 0.8% aqueous H₂SO₄ and MeOH furnishing the triol **40**. Absence of two singlets for 6 protons of one isopropylidene group in the region 1.35 to 1.42 ppm in ¹H-NMR and also absence of corresponding carbons at δ 25.2 (q), 26.6 (q) and 109.8 (s) in ¹³C-NMR substantiated the result. Triol **40** was perbenzylated using NaH and BnBr to afford **41**. A surge in the number of protons in

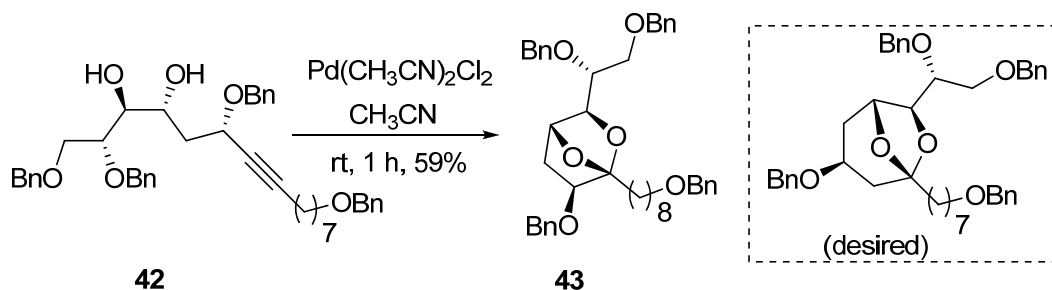
aromatic region δ 7.24–7.33 (m, 20H) acknowledged the presence of 3 additional benzyl groups in the product. Mass [m/z 727.58 for $(M+Na)^+$] and elemental analysis supported the structure of **41**. To obtain required alkynol substrate, the acetonide group of compound **41** was deprotected in acidic condition by treatment with catalytic *p*-TSA in MeOH at room temperature. Diol **42** was assigned for its structure by the obvious disappearance of peaks for acetonide protons in $^1\text{H-NMR}$. The structure of **42** was further supported by Mass [m/z 687.66 for $(M+Na)^+$] and elemental analysis (Scheme 6).



Scheme 6

After having the key triol **42**, now the stage was set for executing the key transformation to build the requisite [3,2,1]-bicyclic ketal unit by employing Pd-mediated alkynol cycloisomerization reaction. When employed $\text{Pd}(\text{CH}_3\text{CN})_2\text{Cl}_2$ as the catalyst, the reaction advanced smoothly with the disappearance of starting compound within 1 h and afforded **43** as the exclusive product. The constitution of the bicyclic ketal unit present in **43** was investigated with the help of spectral data analysis. Downfield shift of a proton was noticed which appeared at 4.38 ppm as a doublet ($J = 12.1$ Hz). Another two protons appeared as doublet of doublets at δ 3.67 ($J = 2.7, 6.6$ Hz) and 3.75 ($J = 1.9, 10.7$ Hz). In $^{13}\text{C-NMR}$ spectrum, characteristic ketal carbon peak appeared at 110.7 ppm, but we noticed one more CH_2 triplet to be resonated below 30 ppm and also an upfield shift of the propargylic carbon which now resonated at 37.2 ppm. This made us to review our

postulation of the expected [3,2,1] bicyclic structure which would have been resulted in two CH₂ triplets separately in the down field region. These findings supported the *exo*-cyclization product **30** with a [2,2,1] bicyclic ketal structure.

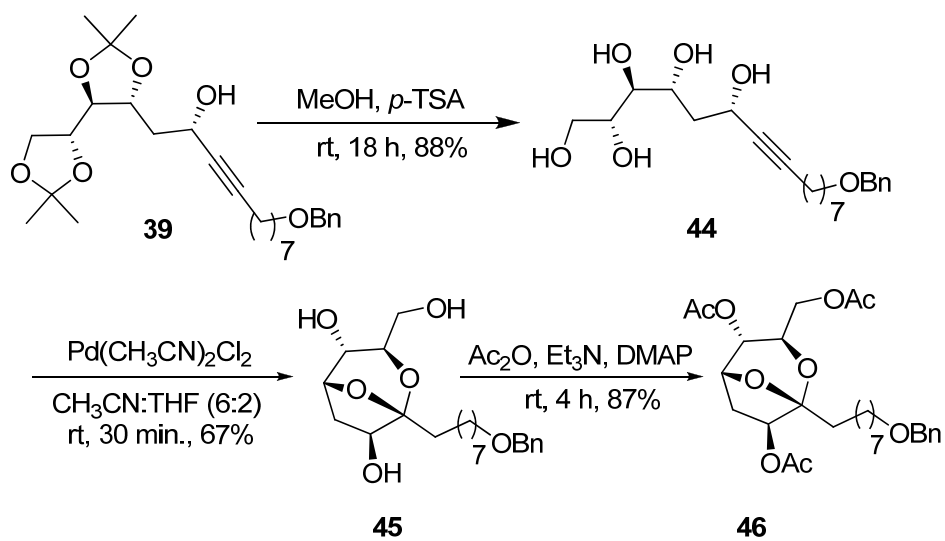


Scheme 7

The unanticipated *exo*-selectivity resulting with an undesired cycloisomerization product led us to do some experimentation with this substrate to ensure the mode of cyclization. The global deprotection of **39** resulted in pentitol **44**. Cycloisomerization of **44** with Pd(CH₃CN)₂Cl₂ in CH₃CN proceeded smoothly and gave a single product **45**. The appearance of a peak at δ 108.0 (s) characteristic of a ketal carbon pledged for the formation of a bicyclic ketal product. A closer look to the ¹³C-NMR spectrum revealed that there were 8 methylene carbons resonating in the region 23.3 to 35.1 ppm. The cyclized product was converted to the corresponding triacetate **46** by treating with Ac₂O, Et₃N and DMAP.

Compound **46** was subjected for the structural characterization using COSY, NOESY and HMBC spectra (Figure 7). The connectivity of the ring-H has been deduced with the help of the COSY and the spatial proximity by NOE experiments. The C-1-ketal carbon has shown HMBC correlation with two of the ring-H i.e. H-3 and H-4 which is indicative of (C-1)-O-(C-4) tetrahydrofuran unit. The chemical shifts of the H-5 (4.82 ppm) and of H-6 (3.78 ppm) with large coupling const $^3J_{5,6} = 9.5$ Hz indicated (C-6)-O to be a part of the bicyclic ketal unit and also there was a diaxial relation between these two protons. Further, the strong NOE observed between H-6 and H-2 (5.22 ppm), and H-6 and H'-3 (2.60 ppm) and the relative downfield resonance of H-2 and H'-3 indicated a close proximity between these 3H and also with (C-5)-OAc. This information has suggested the formation of a 2,8-dioxabicyclo [3,2,1] octane skeleton during the

cycloisomerization. The other chemical shifts, coupling constants and the through spatial interactions (Table 1) have further confirmed the assigned structure of **46** (Figure 7).



Scheme 8

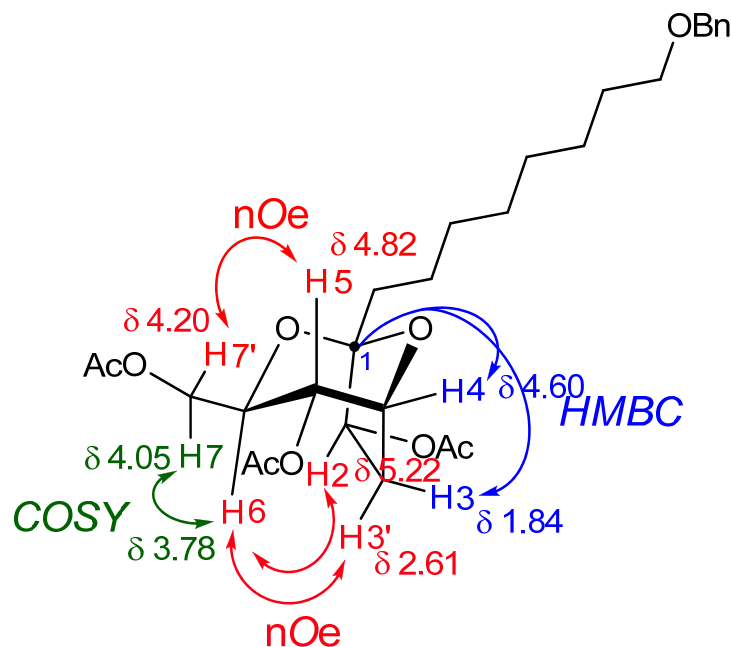


Figure 7

¹³ C	¹ H	Mult.	<i>J</i> Value	COSY	NOESY	HMBC
C-1 107.1 (s)						H-3, H-4
C-2 75.7 (d)	5.22	dd	3.1, 7.5	H-3, H ^γ -3	H ^γ -3, H-6	
C-3 33.5 (t)	1.84	ddd	3.1, 7.5, 14.4	H-4	H-4	C-1, C-2, C-5
	2.61	dd	7.5, 14.4	H-2	H-6, H-2	
C-4 73.6 (d)	4.60	dd	4.0, 7.5	H-3, H-6	H-5	C-1, C-2, C-5
C-5 65.0 (d)	4.82	dd	4.0, 9.5	H-6	H-4	C-4
C-6 70.0 (d)	3.78	ddd	2.6, 5.0, 9.5	H-5	H-7, H-2	
C-7 63.4 (t)	4.05	dd	5.0, 12.1	H-6	H-6	C-5, C-6
	4.20	dd	2.5, 12.1			

Table 1: Chemical shifts and coupling constants of the bicyclic ketal unit in **46**

As the above strategy explained the formation of [2, 2,1] bicyclic core in **43** and a 2,8-dioxabicyclo [3,2,1] octane system in **46**, which was of no help for persuading the total synthesis of the natural product, we opted for a review of the strategy. We attribute the result to an exclusive *exo*-attack of the suitably placed hydroxyl groups to the alkyne functionality. Although there was scope for formation of *endo*- bicyclic ketal, even as a competitive product in both the cases, the exclusive formation of *exo*- cyclised product indicates an acyclic stereocontrol over the cycloisomerization reactions and has pushed us for the development of a new strategy.

Route 2

So as to achieve our desired [3,2,1] bicyclic core of the natural product based on the above findings, we planned for a precursor with an extra carbon in-between for the cyclisation reaction.

Retrosynthetic strategy:

A careful inquisitive study of the natural product revealed the advanced intermediate **47** as the synthon, which we could attempt to synthesize. To achieve the desired bicyclic ketal core of **47**, we opted for L-malic acid as the starting material. The consequence of the previous strategy i.e. *exo*-cyclisation exclusively, automatically claims **48** as the appropriate synthon. The polyhydroxyl intermediate **48** was delineated to L(-)-Malic acid through some functional group transformation, important among them

were i) The chirality introducing Sharpless asymmetric dihydroxylation,¹² ii) Yamaguchi epoxide opening reaction;¹³ iii) Wittig reaction for chain elongation (Figure 8).

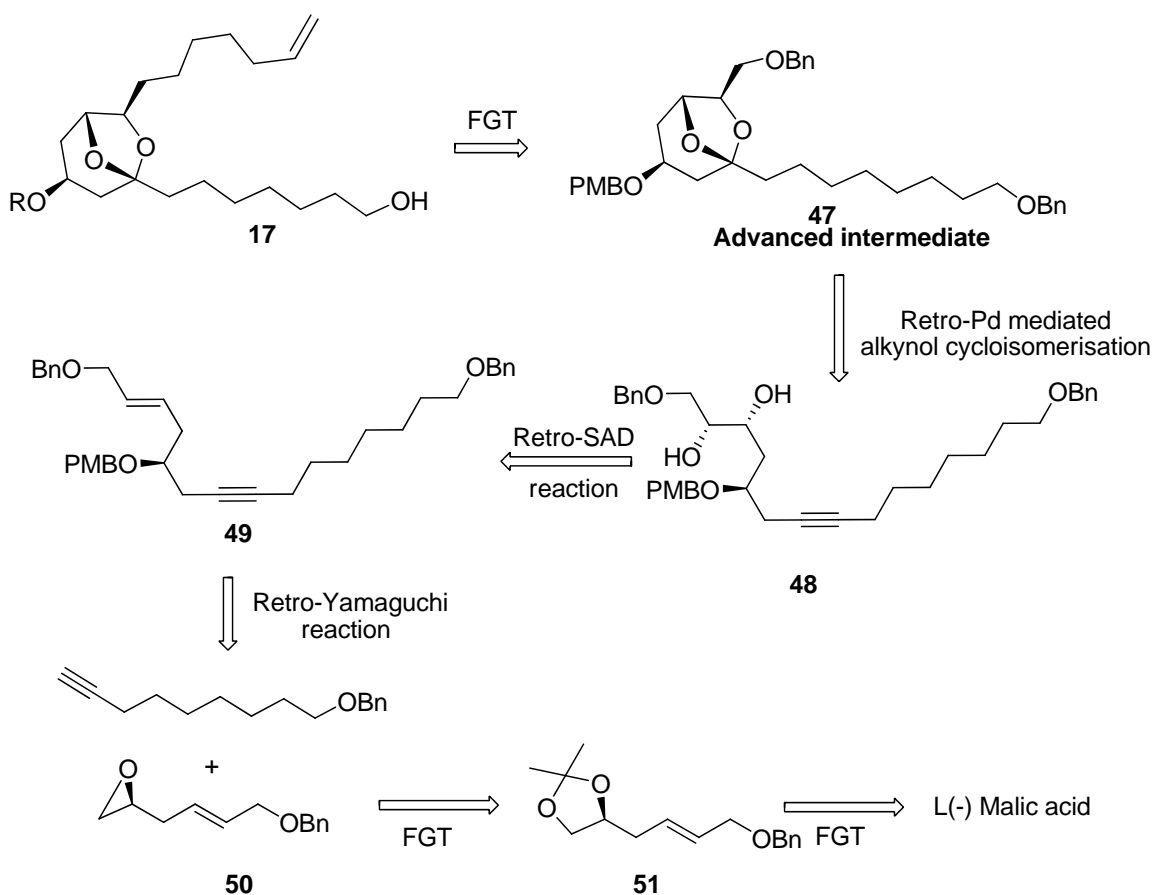
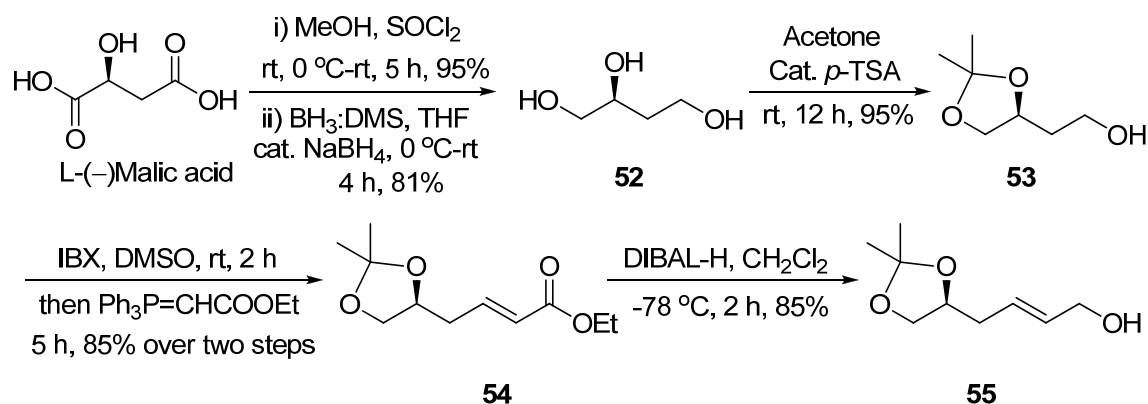


Figure 8: Retrosynthetic strategy

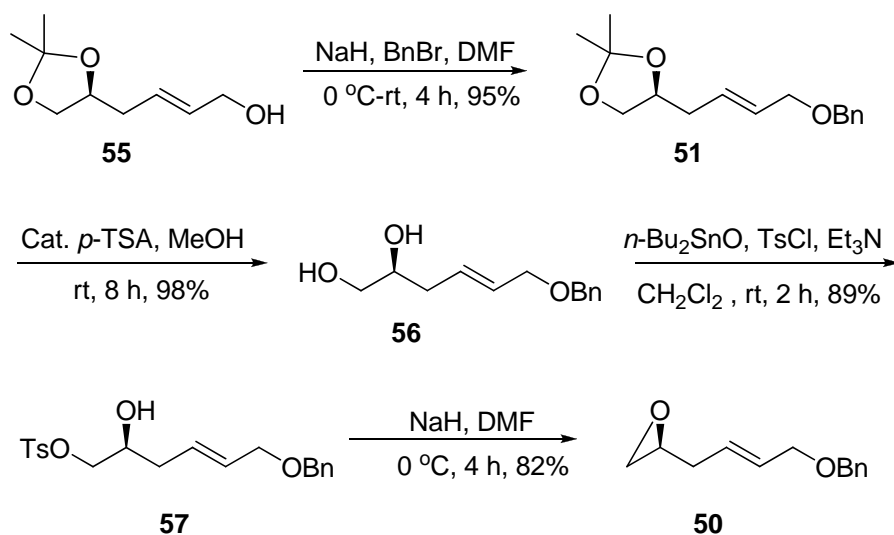
Synthesis:

The synthesis began with the conversion of L-malic acid to its methyl ester and reduction of the diester by BH_3 : DMS to get the triol **52**. The triol was then selectively protected in aprotic acidic medium as 5-membered dioxole **53**. One pot sequential oxidation of alcohol **53** with IBX in DMSO, followed by treatment with 2-carbon Wittig ylide furnished the *trans*-olefin **54**. Compound **54** was then reduced selectively by DIBAL-H to give the allyl alcohol **55** (Scheme 9).



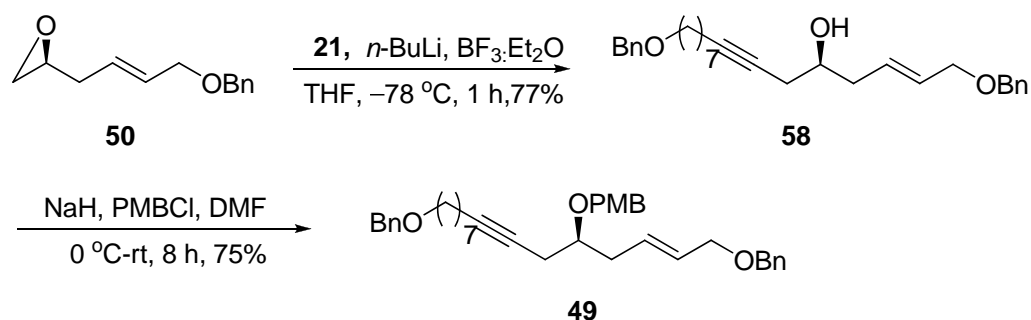
Scheme 9

Allylic alcohol **55** was subjected for the benzylation using NaH and BnBr to afford the identified retron **51**. The presence of aromatic protons in the region 7.31-7.36 ppm and a singlet for two protons at 4.50 ppm in $^1\text{H-NMR}$ approved the structure of **51**. The isopropylidene group of compound **51** was detached in protic acidic medium to acquire diol **56**. Disappearance of two singlets in aliphatic region supported the diol structure. To get epoxide **50** with retention of stereochemistry, the primary hydroxyl group was selectively converted to its tosylate **57** with catalytic $n\text{-Bu}_2\text{SnO}$ followed by $\text{S}_{\text{N}}2$ displacement with vicinal hydroxyl group. Shift of 3 protons to upfield region as compared to diol precursor in $^1\text{H-NMR}$ and also an upfield shift of a carbon to δ 46.6 (t) indicated the formation of epoxide **50**. The structure of **50** was further supported by Mass [m/z 227.19 for $(\text{M}+\text{Na})^+$] and elemental analysis (Scheme 10).



Scheme 10

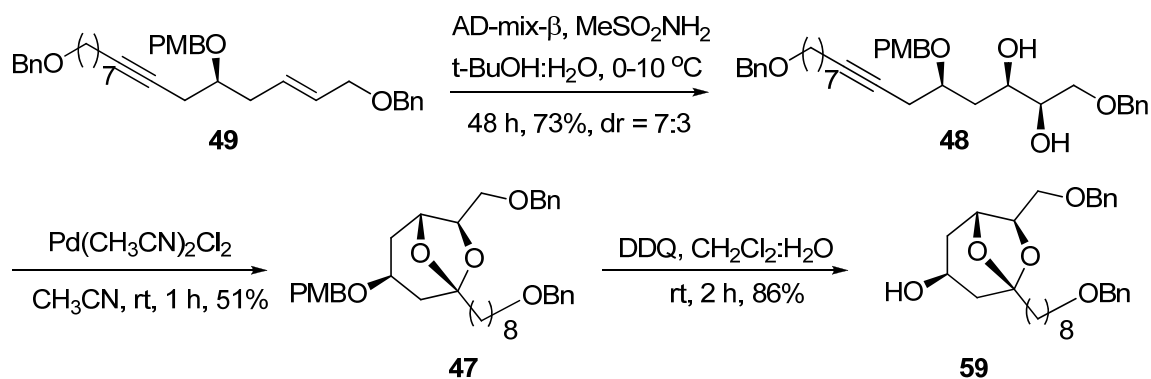
The introduction of the alkyne chain **21** to substrate **50** was accessed by epoxide ring opening using Yamaguchi protocol. Thus, the reaction of **21** with epoxide **50** in presence of *n*-BuLi and BF₃.Et₂O at -78 °C gave homopropargylic alcohol **58** with 62% yield. The ¹H NMR spectrum of **58** showed a multiplet in the region δ 1.33–1.67 integrating for 10 protons and another multiplet for the propargylic protons in the region δ 2.33–2.36 (4H). The IR spectrum showed the O-H stretching at 3377 cm⁻¹. The structure was further supported by mass [*m/z* 457.40 for (M+Na)⁺] and elemental analysis. Alcohol **58** was protected as its PMB ether **49** by NaH and PMBCl. Two additional doublets at δ 6.84 and 7.26 with *J* value of 8.5 Hz indicated the presence of PMB group in the product (Scheme 11).



Scheme 11

To attain the requisite diol system in our substrate, compound **49** was subjected to Sharpless asymmetric dihydroxylation in presence of AD-mix-β. Though the reaction was continued at 0 °C to 4 °C for 24 hours in order to get high stereoselectivity, no progress was noticed. Hence we were forced to increase the reaction temperature to 10 °C to get dihydroxy compound **48** in a 7:3 diastereomeric mixture. Disappearance of the peaks indicative of olefin protons (5.67–5.78 ppm) and also the absence of a two proton doublet at 3.98 ppm owing to allylic ether protons (=CH₂-O) implied the transformation of starting material. In ¹³C-NMR spectrum, two doublet carbons resonated at 70.8 and 72.6 ppm due to CH-OH. A broad peak at 3310 cm⁻¹ for the O-H stretching justified the presence of hydroxyl groups. Further supplementations by mass [*m/z* 611.67 for (M+Na)⁺] and elemental analysis agreed to the structure of **48** (Scheme 12).

Having the key diol **48**, we intended to implement Pd-mediated alkynol cycloisomerization to build the requisite [3,2,1] bicyclic ketal unit. Accordingly compound **48** was exposed to the catalyst Pd(CH₃CN)₂Cl₂ in CH₃CN and after 1 h, the starting material disappeared resulting in a relatively nonpolar product as monitored by TLC. Presence of the ketal unit could be confirmed by the presence of a singlet carbon at 109.1 ppm in ¹³C-NMR spectrum and in this case we observed two CH₂ peaks in downfield region at δ 37.6 (t) and 40.9 (t). This indicated a [3,2,1] bicyclic system in our product **47**.



The stereochemistry of the isolated bicyclic product could be assigned from COSY and NOESY studies. There was no COSY interaction observed between H-3 and H-2 which indicated a dihedral angle of 90° between them as reported^{3a}. In NOE spectra, H-5 showed interaction with H-2, but no correlation was observed for H-5 and H-3.

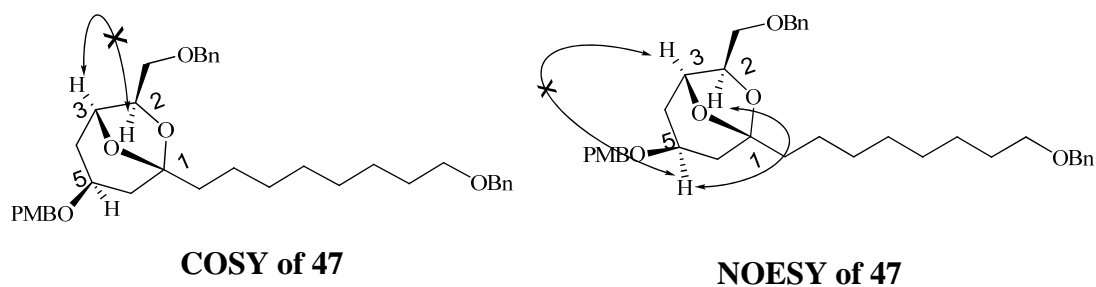


Figure 9: COSY and NOESY interactions in compound 47

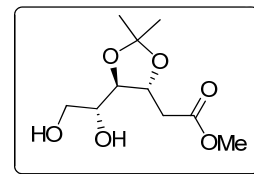
Conclusion:

Here in we compiled our investigations that were aimed at developing a flexible approach for the total synthesis of cyclodidemniserinol and its trisulfate. Our initial design anticipating an exclusive 6-*endo* mode of cycloisomerization was ended up with an unpredicted exclusive 5-*exo*-dig mode of ring closure giving either a [2,2,1] bicyclic ketal or a [3,2,1] bicyclic ketal depending upon the availability of 5-OH compound. This has been tentatively attributed to the acyclic stereocontrol over the cycloisomerization reaction which has no precedence. Considering this, we redesigned our model substrate of the cycloisomerization reaction aiming an exclusive 6-*exo*-dig mode of cyclization to afford the required [3,2,1] bicyclic ketal. To this end, by using the redesigned substrate, we could materialize our Pd-mediated alkynediol cycloisomerization strategy for the construction of the central bicyclic ketal core of the cyclodidemniserinol and its trisulfate. Presently, the total synthesis of cyclodidemniserinol by employing this approach is at an advance stage.



2.3 EXPERIMENTAL

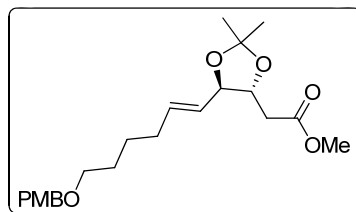
Methyl 2-deoxy-3,4-*O*-isopropylidene-D-gluconoate (**24**):



A solution of **23** (2 g, 7.29 mmol) in MeOH (50 mL) and dilute H₂SO₄ (5 mL, 0.8% in water) was stirred at 25 °C for 15 h, quenched with NaHCO₃ and concentrated. The residue was partitioned between ethyl acetate–water and the aqueous layer was extracted with ethyl acetate. The combined organic phase was dried over Na₂SO₄, concentrated and purified by column chromatography (50% ethyl acetate in light petroleum) to obtain **24** (970 mg, 71%) as colorless thick liquid along with recovered starting material **23** (400 mg).

Mol. Formula	: C ₁₀ H ₁₈ O ₆
Mol. Weight	: 234.25
[α]_D²⁵	: +15.9 (<i>c</i> 1.25, CHCl ₃)
IR (CHCl₃, cm⁻¹)	: 3413, 2988, 2936, 1736, 1654, 1439, 1373, 1361, 1175, 848.
¹H NMR (200 MHz, CDCl ₃)	: δ 1.36 (s, 6H), 2.61 (dd, <i>J</i> = 7.7, 15.9 Hz, 1H), 2.81 (dd, <i>J</i> = 4.4, 15.9 Hz, 1H), 3.59–3.69 (m, 3H), 3.69 (s, 3H), 3.74–3.81 (m, 1H), 4.32–4.42 (m, 1H).
¹³C NMR (50 MHz, CDCl ₃)	: δ 26.9 (q), 27.0 (q), 38.9 (t), 51.6 (q), 63.9 (t), 73.1 (d), 76.1 (d), 79.8 (d), 109.3 (s), 171.7 (s).
Elemental Analysis	: Calcd: C, 51.27; H, 7.75. Found: C, 51.15; H, 7.61.
ESI-MS <i>m/z</i>	: 257.11 [M+Na] ⁺

Methyl 2-((4*R*,5*R*)-5-((*E*)-6-(4-methoxybenzyloxy)hex-1-enyl)-2,2-dimethyl-1,3-dioxolan-4-yl)acetate (**29**):

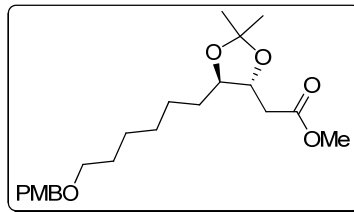


To the solution of diol **24** (400 mg, 1.7 mmol) in DCM, NaIO₄ (2.7 gm, adsorbed on silica) was added and stirred for 1h. The reaction mixture was filtered over a *Celite*

pad, dried over Na_2SO_4 and concentrated. The crude aldehyde **28** was used for Wittig reaction. To the aldehyde **28** in THF (5 mL) at 0 °C, a solution of the ylide generated from $\text{PMBO}(\text{CH}_2)_5\text{P}^+\text{Ph}_3\text{I}^-$ **20** (5 g, 8.5 mmol) using *n*-BuLi (4.2 mL of 1.6 M solution, 6.8 mmol) in THF was added dropwise and stirred for 30 min. The reaction mixture was quenched with saturated NH_4Cl (5 mL), the organic layer was separated and the aqueous layer was extracted with ethyl acetate. The combined organic layer was washed with brine, dried (Na_2SO_4) and concentrated. Purification of the crude product by column chromatography (10% ethyl acetate in petroleum ether) afforded **29** (67 mg, 10%) as colorless syrup.

Mol. Formula	: $\text{C}_{22}\text{H}_{32}\text{O}_6$
Mol. Weight	: 392.49
$[\alpha]_{\text{D}}^{25}$: -3.2 (<i>c</i> 1.2, CHCl_3)
IR (CHCl_3 , cm^{-1})	: 3445, 3154, 2931, 1743, 1613, 1514, 1403, 1247, 1172, 755.
^1H NMR (400 MHz, CDCl_3)	: δ 1.41 (s, 3H), 1.43 (s, 3H), 1.44–1.50 (m, 2H), 1.58–1.65 (m, 2H), 2.10 (ddd, $J = 1.4, 7.2, 14.6$ Hz, 1H), 2.14–2.22 (m, 1H), 2.53 (d, $J = 2.3$ Hz, 1H), 2.54 (d, $J = 4.5$ Hz, 1H), 3.44 (t, $J = 6.3$ Hz, 2H), 3.69 (s, 3H), 3.80 (s, 3H), 4.04 (ddd, $J = 5.0, 7.2, 8.3$ Hz, 1H), 4.42 (s, 2H), 4.46 (t, $J = 8.8$ Hz, 1H), 5.36 (ddt, $J = 1.5, 9.2, 10.9$ Hz, 1H), 5.70 (dt, $J = 7.4, 10.9$ Hz, 1H), 6.88 (d, $J = 8.6$ Hz, 2H), 7.25 (d, $J = 8.6$ Hz, 2H).
^{13}C NMR (100 MHz, CDCl_3)	: δ 26.3 (t), 27.1 (q, 2C), 27.6 (t), 29.3 (t), 36.6 (t), 51.8 (q), 55.2 (q), 69.7 (t), 72.5 (t), 75.9 (d), 77.0 (d), 109.1 (s), 113.7 (d, 2C), 125.5 (d), 129.2 (d, 2C), 130.6 (s), 136.8 (d), 159.1 (s), 170.9 (s).
Elemental Analysis	: Calcd: C, 67.32; H, 8.22. Found: C, 67.59; H, 8.10.
ESI-MS m/z	: 415.14 $[\text{M}+\text{Na}]^+$

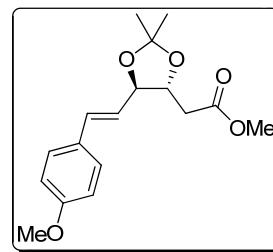
Methyl 2-((4*R*,5*R*)-5-(6-(4-methoxybenzyloxy)hexyl)-2,2-dimethyl-1,3-dioxolan-4-yl)acetate (30**):**



A suspension of the compound of **29** (20 mg, 0.05 mmol), Raney-Ni (catalytic) in ethanol (2 mL) was flushed with hydrogen gas and stirred under hydrogen (20 *psi*) atmosphere for 3 h. The reaction mixture was filtered through *Celite*, concentrated and the crude product was purified by column chromatography (10% ethyl acetate in petroleum ether) to yield **30** (17 mg, 84%) as white syrup.

Mol. Formula	: C ₂₂ H ₃₄ O ₆
Mol. Weight	: 394.50
[α]_D²⁵	: +13.6 (<i>c</i> 0.7, CHCl ₃)
IR (CHCl₃, cm⁻¹)	: 3394, 3019, 1607, 1510, 1124, 757, 668.
¹H NMR (400 MHz, CDCl ₃)	: δ 1.30–1.38 (m, 6H), 1.38 (s, 3H), 1.40 (s, 3H), 1.47–1.57 (m, 4H), 2.54 (br s, 1H), 2.57 (d, <i>J</i> = 2.2 Hz, 1H), 3.43 (t, <i>J</i> = 6.5 Hz, 2H), 3.64–3.74 (m, 1H), 3.71 (s, 3H), 3.81 (s, 3H), 4.03 (ddd, <i>J</i> = 5.4, 6.8, 8.0 Hz, 1H), 4.43 (s, 2H), 6.88 (d, <i>J</i> = 8.7 Hz, 2H), 7.26 (d, <i>J</i> = 8.7 Hz, 2H).
¹³C NMR (100 MHz, CDCl ₃)	: δ 25.9 (t), 26.1 (t), 27.1 (q), 27.3 (q), 29.5 (t), 29.6 (t), 32.5 (t), 38.1 (t), 51.8 (q), 55.2 (q), 70.1 (t), 72.5 (t), 76.9 (d), 80.5 (d), 108.6 (s), 113.7 (d, 2C), 129.2 (d, 2C), 130.7 (s), 160.1 (s), 171.1 (s).
Elemental Analysis	: Calcd: C, 66.98; H 8.69. Found: C, 66.75; H, 8.81.
ESI-MS <i>m/z</i>	: 417.1 [M+Na] ⁺

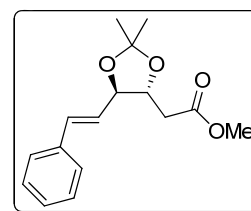
Methyl 2-((4*R*,5*R*)-5-((*E*)-4-methoxystyryl)-2,2-dimethyl-1,3-dioxolan-4-yl)acetate (31**):**



Compound **31** was obtained as a major product from the above Wittig reaction.

Mol. Formula	: C ₁₇ H ₂₂ O ₅
Mol. Weight	: 306.35
¹H NMR (200 MHz, CDCl ₃)	: δ 1.44 (s, 3H), 1.47 (s, 3H), 2.47 (d, <i>J</i> = 1.2 Hz, 1H), 2.50 (d, <i>J</i> = 3.1 Hz, 1H), 3.66 (s, 3H), 3.82 (s, 3H), 4.17 (ddd, <i>J</i> = 5.3, 7.1, 8.1 Hz, 1H), 4.50 (ddd, <i>J</i> = 0.9, 8.1, 9.2 Hz, 1H), 5.56 (dd, <i>J</i> = 9.2, 11.4 Hz, 1H), 6.74 (d, <i>J</i> = 11.4 Hz, 1H), 6.87 (d, <i>J</i> = 8.2 Hz, 2H), 7.28 (d, <i>J</i> = 8.2 Hz, 2H).
ESI-MS <i>m/z</i>	: 329.31 [M+Na] ⁺

Methyl 2-((4*R*,5*R*)-2,2-dimethyl-5-((*E*)-styryl)-1,3-dioxolan-4-yl) acetate (32**):**



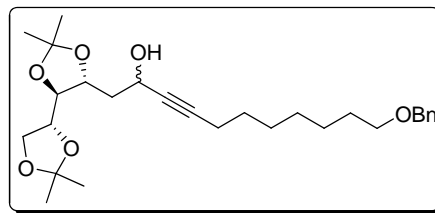
The aldehyde **28** (150 mg, 0.75 mmol) was treated with the ylide generated from BnO(CH₂)₄P⁺Ph₃I⁻ (2.1 g, 3.74 mmol) using *n*-BuLi (1.8 mL of 1.6 M solution, 3 mmol) in THF at 0 °C, and stirred for 30 min. Following the same work up and purification procedure as the above mentioned Wittig reaction, **32** was obtained (124 mg, 60%) as colorless syrup.

Mol. Formula	: C ₁₆ H ₂₀ O ₄
Mol. Weight	: 276.33
IR (CHCl₃, cm⁻¹)	: 3402, 3027, 2928, 1741, 1643, 1402, 1330, 1053, 1020, 770.
¹H NMR (200 MHz, CDCl ₃)	: δ 1.43 (s, 3H), 1.48 (s, 3H), 2.47 (s, 1H), 2.50 (d, <i>J</i> = 2.4 Hz, 1H), 3.65 (s, 3H), 4.20 (ddd, <i>J</i> = 5.4, 7.0, 8.2 Hz, 1H), 4.51 (ddd, <i>J</i> = 0.8, 8.2, 9.2 Hz, 1H), 5.66 (dd, <i>J</i> = 9.3, 11.4 Hz, 1H), 6.83 (d, <i>J</i> = 11.4 Hz, 1H), 7.28–7.37 (m, 5H).
¹³C NMR (50 MHz, CDCl ₃)	: δ 27.1 (q), 27.2 (q), 36.9 (t), 51.8 (q), 76.3 (d), 77.5 (d), 109.3 (s), 126.9 (d), 127.6 (d), 128.3 (d, 2C), 128.6 (d, 2C), 135.9 (d), 136.6 (s), 170.8 (s).
Elemental Analysis	: Calcd: C, 70.86; H, 8.92.

Found: C, 70.99; H, 8.48.

ESI-MS m/z : 297.38 $[M+Na]^+$

(*R/S*)-11-(benzyloxy)-1-((4*S*,4'*R*,5*R*)-2,2,2',2'-tetramethyl-4,4'-bi(1,3-dioxolan)-5-yl)undec-3-yn-2-ol (37):



To a solution of diacetonide **23** (1 g, 3.64 mmol) in dry toluene (15 mL) at -78 °C, DIBAL-H (2.3 mL, 5.47 mmol, 2.34 M in toluene) was added slowly and stirred for 20 min. maintaining the temperature. The reaction mixture was quenched with saturated solution of sodium potassium tartarate at -78 °C. The organic layer was separated and the aqueous layer was washed with ethyl acetate. The combined organic layer was washed with brine, dried (Na_2SO_4), and concentrated. Crude aldehyde was used as such for next reaction. Alkyne **21** (3.35 g, 14.56 mmol) was refluxed with Et_2Zn (14.6 mL, 14.56 mmol, 1 M in toluene) in toluene for 1 h and cooled to room temperature. Aldehyde **36** in dry Toluene (7 mL) was added to it and the reaction mixture was stirred for another 13 h. The reaction mixture was quenched with saturated NH_4Cl solution. The organic layer was separated and the aqueous layer was washed with ethyl acetate. The combined organic layer was washed with brine, dried over Na_2SO_4 and concentrated. The residue was purified by column chromatography (15% ethyl acetate in petroleum ether) to afford **37** (1.2 g, 69% in two steps) as a colorless syrup.

Mol. Formula : $C_{28}H_{42}O_6$

Mol. Weight : 474.63

IR ($CHCl_3$, cm^{-1}) : 3523, 3020, 2931, 2400, 1595, 1523, 1471, 1346, 1096, 838.

1H NMR : δ 1.34 (2s, 3H), 1.37 (2s, 3H), 1.39 (s, 3H), 1.41 (2s, 3H),
(200 MHz, $CDCl_3$) 1.34–1.41 (m, 6H), 1.50–1.67 (m, 6H), 1.88–2.02 (m,
(Diastereomeric mixture) 1H), 2.08–2.15 (m, 1H), 2.21 (dt, $J = 1.9, 6.9$ Hz, 2H),
2.99–3.08 (m, 1H), 3.46 (t, $J = 6.6$ Hz, 2H), 3.58–3.7 (m,
1H), 3.91–4.18 (m, 3.5H), 4.30 (ddd, $J = 3.3, 7.8, 9.1$ Hz,
0.5H), 4.50 (s, 2H), 4.62 (br s, 1H), 7.28–7.35 (m, 5H).

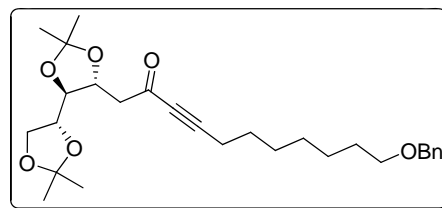
^{13}C NMR : δ 18.6 (t), 25.2 (t), 26.0 (q), 26.6 (q, 2C), 26.8 (q), 27.1 (q), 27.2 (q), 28.5 (t), 28.7 (t), 28.9 (t), 29.6 (t), 40.9 (t), (Diastereomeric mixture) 42.0 (t), 60.4 (d), 61.2 (d), 67.6 (t), 67.7 (t), 70.3 (t), 72.8 (t), 76.8 (d), 77.0 (d), 77.4 (d), 78.9 (d), 80.3 (s), 80.6 (s), 81.0 (d), 81.3 (d), 85.5 (s), 109.2 (s), 109.4 (s), 109.7 (s, 2C), 127.4 (d), 127.6 (d, 2C), 128.3 (d), 138.6 (s).

Elemental Analysis : Calcd: C, 70.86; H 8.92.

Found: C, 70.99; H, 8.68.

ESI-MS m/z : 497.28 $[\text{M}+\text{Na}]^+$

11-(benzyloxy)-1-((4*S*,4'*R*,5*R*)-2,2,2',2'-tetramethyl-4,4'-bi(1,3-dioxolan)-5-yl)undec-3-yn-2-one (38):



Compound **37** (400 mg, 0.84 mmol) was dissolved in DCM (10 mL) and MnO_2 (366 mg, 4.21 mmol) was added to it. The reaction mixture was stirred for 24 h and filtered through a *Celite* pad. The filtrate was concentrated and column chromatographed to get **38** (278 mg, 70%) as a colorless oil.

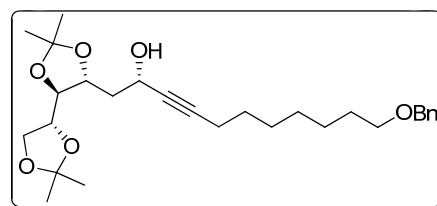
Mol. Formula : $\text{C}_{28}\text{H}_{40}\text{O}_6$

Mol. Weight : 472.63

^1H NMR : δ 1.33 (s, 3H), 1.38 (s, 6H), 1.40 (s, 3H), 1.33–1.40 (m, 6H), 1.55–1.64 (m, 4H), 2.37 (t, $J = 6.9$ Hz, 2H), 2.80 (dd, $J = 0.8, 16.4$ Hz, 1H), 3.00 (dd, $J = 3.2, 16.4$ Hz, 1H), 3.46 (t, $J = 6.5$ Hz, 2H), 3.56 (t, $J = 7.8$ Hz, 1H), 3.91–4.17 (m, 4H), 4.50 (s, 2H), 7.31–7.35 (m, 5H).

ESI-MS m/z : 495.71 $[\text{M}+\text{Na}]^+$

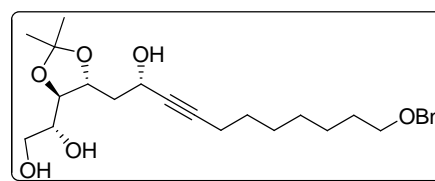
(*S*)-11-(benzyloxy)-1-((4*S*,4'*R*,5*R*)-2,2,2',2'-tetramethyl-4,4'-bi(1,3-dioxolan)-5-yl)undec-3-yn-2-ol (39):



Compound **38** (300 mg, 0.63 mmol) was taken in anh. THF (10 mL) and LiI (849 mg, 6.34 mmol) was added to it. The reaction mixture was stirred at $-40\text{ }^{\circ}\text{C}$ for 30 min. Then the reaction mixture was further cooled to $-100\text{ }^{\circ}\text{C}$ and LAH (240 mg, 6.34 mmol) was added to it and stirred for 1 h. After completion, the reaction mixture was quenched with saturated sodium potassium tartarate solution and partitioned between water and ethyl acetate. The organic layer was washed with brine, dried and concentrated to afford the crude product which on column chromatographic purification (15% ethyl acetate in light petroleum) yielded **39** (247 mg, 82%) as a colorless oil.

Mol. Formula	: $\text{C}_{28}\text{H}_{42}\text{O}_6$
Mol. Weight	: 474.63
$[\alpha]_D^{25}$: +6.3 (<i>c</i> 1, CHCl_3)
IR (CHCl_3 , cm^{-1})	: 3526, 3020, 2956, 2410, 1530, 1471, 1346, 1216, 1097.
^1H NMR (200 MHz, CDCl_3)	: δ 1.35 (s, 3H), 1.36 (s, 3H), 1.39 (s, 3H), 1.42 (s, 3H), 1.35–1.42 (m, 6H), 1.51–1.67 (m, 4H), 1.99 (dd, $J = 8.3$, 14.1 Hz, 1H), 2.10 (dd, $J = 5.0, 9.7$ Hz, 1H), 2.22 (dt, $J =$ 1.9, 6.9 Hz, 2H), 3.08 (d, $J = 3.8$ Hz, 1H), 3.46 (t, $J = 6.6$ Hz, 2H), 3.64 (t, $J = 7.6$ Hz, 1H), 3.91–4.18 (m, 4H), 4.50 (s, 2H), 4.57–4.69 (m, 1H), 7.31–7.35 (m, 5H).
^{13}C NMR (75 MHz, CDCl_3)	: δ 18.7 (t), 25.2 (q), 26.1 (t), 26.6 (q), 26.9 (q), 27.1 (q), 28.5 (t), 28.7 (t), 28.9 (t), 29.7 (t), 42.0 (t), 61.3 (d), 67.8 (t), 70.4 (t), 72.8 (t), 77.1 (d), 79.0 (d), 80.4 (s), 81.4 (d), 85.5 (s), 109.4 (s), 109.8 (s), 127.4 (d), 127.6 (d, 2C), 128.3 (d, 2C), 138.6 (s).
Elemental Analysis	: Calcd: C, 70.86; H, 8.92. Found: C, 70.63; H, 8.79.
ESI-MS m/z	: 497.46 $[\text{M}+\text{Na}]^+$

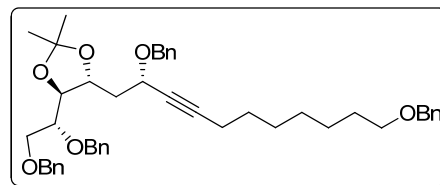
(*R*)-1-((4*R*,5*R*)-5-((*S*)-11-(benzyloxy)-2-hydroxyundec-3-ynyl)-2,2-dimethyl-1,3-dioxolan-4-yl)ethane-1,2-diol (40**):**



A solution of **39** (200 mg, 0.42 mmol) in MeOH (10 mL) was treated with catalytic 0.8% aq. H₂SO₄ and stirred for 8 h. Usual workup and purification of the crude product by column chromatography (50% EtOAc in light petroleum) gave **40** (137 mg, 75%) as a colorless oil.

Mol. Formula	: C ₂₅ H ₃₈ O ₆
Mol. Weight	: 434.57
[α]_D²⁵	: +6.8 (<i>c</i> 1, CHCl ₃)
IR (CHCl₃, cm⁻¹)	: 3394, 2930, 2856, 1595, 1454, 1371, 1316, 1163, 858, 698.
¹H NMR (200 MHz, CDCl ₃)	: δ 1.30–1.42 (m, 6H), 1.37 (s, 3H), 1.39 (s, 3H), 1.46–1.53 (m, 2H), 1.58–1.64 (m, 2H), 2.04 (dd, <i>J</i> = 7.5, 14.2 Hz, 1H), 2.08–2.15 (m, 1H), 2.19–2.22 (m, 3H), 2.93 (br s, 1H), 3.46 (t, <i>J</i> = 6.5 Hz, 2H), 3.56 (br s, 1H), 3.62–3.65 (m, 1H), 3.72–3.77 (m, 3H), 4.21 (ddd, <i>J</i> = 4.3, 7.0, 11.70 Hz, 1H), 4.50 (s, 2H), 4.61 (br s, 1H), 7.28–7.33 (m, 5H).
¹³C NMR (50 MHz, CDCl ₃)	: δ 18.6 (t), 25.9 (t), 26.9 (q), 27.1 (q), 28.4 (t), 28.6 (t), 28.8 (t), 29.5 (t), 42.1 (t), 60.8 (d), 63.9 (t), 70.4 (t), 72.8 (t), 73.0 (d), 77.6 (d), 80.3 (s), 80.6 (d), 85.8 (s), 109.1 (s), 127.5 (d), 127.7 (d, 2C), 128.3 (d, 2C), 138.4 (s).
Elemental Analysis	: Calcd: C, 69.10; H, 8.81. Found: C, 69.31; H, 8.47.
ESI-MS <i>m/z</i>	: 457.57 [M+Na] ⁺

(4*S*,5*R*)-4-((*R*)-1,2-bis(benzyloxy)ethyl)-5-((*S*)-2,11-bis(benzyloxy)undec-3-ynyl)-2,2-dimethyl-1,3-dioxolane (41**):**

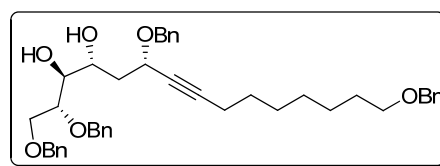


NaH (70 mg, 60% emulsion in paraffin oil, 1.7 mmol) was added to a solution of **40** (150 mg, 0.34 mmol) in DMF (10 mL) pre-cooled at 0 °C and stirred for 30 min. BnBr (0.2 mL, 1.7 mmol) was added to it and further stirred for 10 h at ambient temperature. The excess NaH was quenched with ice and reaction mixture was partitioned with water and ethyl acetate. The organic layer was washed with brine, dried over Na₂SO₄ and

concentrated to afford the crude product which on column chromatography (20% EtOAc in light petroleum) gave **41** (201 mg, 83%) as a colorless oil.

- Mol. Formula** : C₄₆H₅₆O₆
- Mol. Weight** : 704.93
- [α]_D²⁵** : -16.1 (*c* 1.05, CHCl₃)
- IR (CHCl₃, cm⁻¹)** : 3064, 3030, 2925, 2854, 1605, 1496, 1454, 1362, 1252, 1096, 1072, 906, 857, 735.
- ¹H NMR** (400 MHz, CDCl₃) : δ 1.29–1.41 (m, 6H), 1.35 (s, 3H), 1.36 (s, 3H), 1.49 (q, *J* = 7.2 Hz, 2H), 1.55–1.62 (m, 2H), 2.04 (ddd, *J* = 5.4, 9.2, 14.0 Hz, 1H), 2.13 (ddd, *J* = 5.4, 9.2, 14.0 Hz, 1H), 2.20 (dt, *J* = 1.5, 7.1 Hz, 2H), 3.43 (t, *J* = 6.7 Hz, 2H), 3.62 (dd, *J* = 5.7, 10.1 Hz, 1H), 3.70 (ddd, *J* = 3.0, 6.3, 14.0 Hz, 1H), 3.76 (dd, *J* = 2.9, 10.1 Hz, 1H), 3.86 (dd, *J* = 6.4, 7.2 Hz, 1H), 4.26 (ddd, *J* = 2.9, 7.5, 9.2 Hz, 1H), 4.33–4.36 (m, 1H), 4.47 (d, *J* = 11.4 Hz, 1H), 4.48 (s, 2H), 4.54 (s, 2H), 4.63 (d, *J* = 11.4 Hz, 1H), 4.75 (d, *J* = 11.4 Hz, 1H), 4.78 (d, *J* = 11.4 Hz, 1H), 7.24–7.33 (m, 20H).
- ¹³C NMR** (100 MHz, CDCl₃) : δ 18.7 (t), 26.1 (t), 27.0 (q), 27.3 (q), 28.6 (t), 28.8 (t), 28.9 (t), 29.7 (t), 40.6 (t), 67.2 (d), 70.1 (t), 70.4 (t), 70.6 (t), 72.8 (t), 72.9 (t), 73.4 (t), 76.4 (d), 78.4 (s), 79.2 (d), 79.8 (d), 87.4 (s), 109.0 (s), 127.4 (d, 2C), 127.5 (d, 2C), 127.6 (d, 4C), 127.9 (d, 4C), 128.2 (d, 4C), 128.3 (d, 4C), 138.2 (s, 2C), 138.3 (s), 138.6 (s).
- Elemental Analysis** : Calcd: C, 78.38; H, 8.01.
Found: C, 78.21; H, 8.19.
- ESI-MS *m/z*** : 727.58 [M+Na]⁺

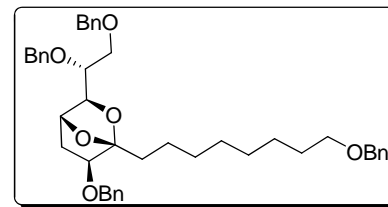
(2*R*,3*S*,4*R*,6*S*)-1,2,6,15-tetrakis(benzyloxy)pentadec-7-yne-3,4-diol (42):



A solution of **41** (200 mg, 0.28 mmol) in MeOH (5 mL) was treated with catalytic *p*-TSA and stirred for 2 h at room temperature. After completion, the reaction mixture was quenched with Et₃N, concentrated and the crude product was purified by column chromatography (50% EtOAc in light petroleum) to obtain **42** (164 mg, 87%) as a colorless oil.

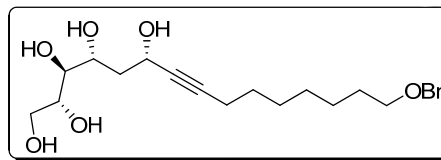
Mol. Formula	: C ₄₃ H ₅₂ O ₆
Mol. Weight	: 664.86
[α]_D²⁵	: -26.3 (<i>c</i> 1.2, CHCl ₃)
IR (CHCl₃, cm⁻¹)	: 3444, 2925, 2854, 1496, 1454, 1363, 1095, 1027, 734, 697.
¹H NMR (200 MHz, CDCl ₃)	: δ 1.33–1.61 (m, 10H), 1.87 (ddd, <i>J</i> = 3.4, 5.6, 14.2 Hz, 1H), 2.10–2.18 (m, 1H), 2.18–2.25 (m, 2H), 2.83 (d, <i>J</i> = 7.6 Hz, 1H), 3.18 (d, <i>J</i> = 3.4 Hz, 1H), 3.45 (t, <i>J</i> = 6.5 Hz, 2H), 3.55 (m, 1H), 3.65–3.78 (m, 3H), 4.09–4.19 (m, 1H), 4.30–4.36 (m, 1H), 4.49 (s, 2H), 4.50 (d, <i>J</i> = 11.6 Hz, 1H), 4.55 (s, 2H), 4.58 (d, <i>J</i> = 11.5 Hz, 1H), 4.72 (d, <i>J</i> = 11.5 Hz, 1H), 4.82 (d, <i>J</i> = 11.6 Hz, 1H), 7.29–7.34 (m, 20H).
¹³C NMR (100 MHz, CDCl ₃)	: δ 18.7 (t), 26.0 (t), 28.6 (t), 28.8 (t), 28.9 (t), 29.7 (t), 40.0 (t), 67.9 (d), 68.6 (d), 70.3 (t), 70.4 (t), 70.5 (t), 72.8 (t), 72.9 (t), 73.5 (t), 73.5 (d), 78.1 (s), 78.5 (d), 87.4 (s), 127.5 (d), 127.6 (d, 5C), 127.7 (d, 2C), 127.9 (d, 2C), 128.0 (d, 2C), 128.4 (d, 8C), 137.6 (s), 138.0 (s), 138.2 (s), 138.6 (s).
Elemental Analysis	: Calcd: C, 77.68; H 7.88. Found: C, 77.49; H, 7.93.
ESI-MS <i>m/z</i>	: 687.66 [M+Na] ⁺

(1*R*,3*S*,4*R*,6*S*)-6-(benzyloxy)-1-(8-(benzyloxy)octyl)-3-((*R*)-1,2-bis(benzyloxy)ethyl)-2,7-dioxabicyclo [2.2.1]heptane (43):



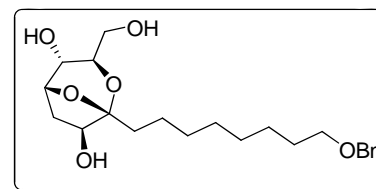
A solution of **42** (100 mg, 0.15 mmol) and PdCl₂(CH₃CN)₂ (4 mg, 15 μmol) in dry CH₃CN (6 mL) was stirred under argon for 1 h. After completion, the reaction mixture was concentrated and purified by column chromatography (15% EtOAc in light petroleum) to obtain **43** (59 mg, 59%) as a colorless oil.

Mol. Formula	: C ₄₃ H ₅₂ O ₆
Mol. Weight	: 664.86
[α]_D²⁵	: +26.5 (c 1.5, CHCl ₃)
IR (CHCl₃, cm⁻¹)	: 3412, 3011, 2929, 2856, 1645, 1496, 1454, 1401, 1363, 1027, 971, 912, 697, 667.
¹H NMR (400 MHz, CDCl ₃)	: δ 1.30–1.45 (m, 10H), 1.58–1.63 (m, 2H), 1.75 (ddd, <i>J</i> = 2.7, 5.5, 12.6 Hz, 1H), 1.86–1.94 (m, 1H), 1.96–2.01 (m, 2H), 3.37 (ddd, <i>J</i> = 1.9, 4.7, 9.0 Hz, 1H), 3.46 (t, <i>J</i> = 6.6 Hz, 2H), 3.53 (d, <i>J</i> = 9.2 Hz, 1H), 3.55 (dd, <i>J</i> = 4.7, 10.7 Hz, 1H), 3.67 (dd, <i>J</i> = 2.7, 6.6 Hz, 1H), 3.75 (dd, <i>J</i> = 1.9, 10.7 Hz, 1H), 4.38 (d, <i>J</i> = 12.1 Hz, 1H), 4.49–4.61 (m, 6H), 4.70–4.75 (m, 2H), 7.26–7.34 (m, 20H).
¹³C NMR (100 MHz, CDCl ₃)	: δ 23.2 (t), 26.2 (t), 28.2 (t), 29.4 (t), 29.5 (t), 29.8 (t), 29.9 (t), 37.2 (t), 68.7 (t), 70.5 (t), 70.6 (t), 72.5 (t), 72.8 (t), 73.3 (t), 76.0 (d), 78.3 (d), 78.4 (d), 80.0 (d), 110.7 (s), 127.4 (d), 127.5 (d), 127.6 (d, 2C), 127.6 (d, 2C), 127.7 (d), 127.9 (d, 2C), 128.0 (d, 2C), 128.3 (d, 2C), 128.4 (d, 5C), 128.4 (d, 2C), 137.9 (s), 138.3 (s), 138.4 (s), 138.7 (s).
Elemental Analysis	: Calcd: C, 77.68; H 7.88. Found: C, 77.39; H, 8.03.
ESI-MS <i>m/z</i>	: 687.99 [M+Na] ⁺

(2R,3S,4R,6S)-15-(benzyloxy)pentadec-7-yne-1,2,3,4,6-pentaol (44):

A solution of **39** (200 mg, 0.42 mmol) in MeOH (10 mL) was treated with catalytic *p*-TSA and stirred for 18 h. The reaction mixture was quenched with Et₃N and concentrated at reduced pressure to remove MeOH. The residue was purified on silica gel by eluting with ethyl acetate to obtain **44** (146 mg, 88%) as a colorless gum.

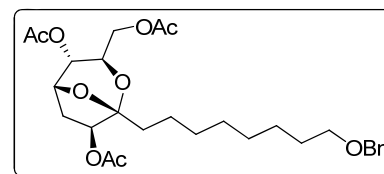
Mol. Formula	: C ₂₂ H ₃₄ O ₆
Mol. Weight	: 394.50
[α]_D²⁵	: +5.8 (<i>c</i> 1.3, CHCl ₃)
IR (MeOH, cm⁻¹)	: 3274, 2928, 2853, 1453, 1364, 1313, 1086, 1027, 925, 958, 871, 750.
¹H NMR (200 MHz, CDCl ₃)	: δ 1.29–1.61 (m, 10H), 1.79–1.92 (m, 1H), 1.96–2.06 (m, 1H), 2.13–2.24 (m, 2H), 3.33–3.50 (m, 1H), 3.43 (t, <i>J</i> = 6.6 Hz, 2H), 3.57–3.90 (m, 5H), 4.09 (br s, 1H), 4.47 (s, 2H), 4.57–4.85 (m, 4H), 7.28–7.32 (m, 5H).
¹³C NMR (50 MHz, CDCl ₃)	: δ 18.5 (t), 25.8 (t), 28.4 (t), 28.6 (t), 28.8 (t), 29.4 (t), 41.2 (t), 60.6 (d), 63.7 (t), 69.0 (d), 70.3 (t), 71.6 (d), 72.8 (t), 73.3 (d), 80.5 (s), 85.2 (s), 127.5 (d), 127.6 (d, 2C), 128.2 (d, 2C), 138.2 (s).
Elemental Analysis	: Calcd: C, 66.98; H, 8.69 Found: C, 66.69; H, 8.47.
ESI-MS <i>m/z</i>	: 417.21 [M+Na] ⁺

(1R,3R,4S,5R,7S)-1-(8-(benzyloxy)octyl)-3-(hydroxymethyl)-2,8-dioxabicyclo [3.2.1]octane-4,7-diol (45):

A solution of alkynol **44** (125 mg, 0.31 mmol) and PdCl₂(CH₃CN)₂ (8 mg, 31 μmol) in dry CH₃CN and THF (6:2 mL) was stirred under argon for 30 min. Concentration followed by chromatographic purification (40% ethyl acetate in light petroleum) gave **45** (83 mg, 67 %).

Mol. Formula	: C ₂₂ H ₃₄ O ₆
Mol. Weight	: 394.50
[α]_D²⁵	: +21.6 (<i>c</i> 1, CHCl ₃)
IR (CHCl₃, cm⁻¹)	: 3401, 2926, 2853, 1719, 1654, 1559, 1538, 1505, 1454, 1363, 1203, 736.
¹H NMR (400 MHz, CDCl ₃)	: δ 1.30–1.50 (m, 10H), 1.57–1.63 (m, 2H), 1.70–1.78 (m, 2H), 2.23–2.47 (m, 4H), 2.60 (dd, <i>J</i> = 7.4, 14.3 Hz, 1H), 3.35–3.39 (m, 1H), 3.46 (t, <i>J</i> = 6.6 Hz, 2H), 3.64–3.77 (m, 3H), 4.19 (dd, <i>J</i> = 2.4, 7.4 Hz, 1H), 4.41 (dd, <i>J</i> = 3.9, 7.4 Hz, 1H), 4.49 (s, 2H), 7.30–7.35 (m, 5H).
¹³C NMR (100 MHz, CDCl ₃)	: δ 23.3 (t), 26.1 (t), 29.3 (t), 29.4 (t), 29.7 (t), 29.9 (t), 32.6 (t), 35.1 (t), 62.8 (t), 64.1 (d), 70.5 (t), 72.8 (t), 73.8 (d), 74.6 (d), 76.2 (d), 108.0 (s), 127.5 (d), 127.6 (d, 2C), 128.3 (d, 2C), 138.6 (s).
Elemental Analysis	: Calcd: C, 66.98; H, 8.69. Found: C, 66.75; H, 8.71.
ESI-MS <i>m/z</i>	: 417.30 [M+Na] ⁺

(1*R*,3*R*,4*S*,5*R*,7*S*)-3-(acetoxymethyl)-1-(8-(benzyloxy)octyl)-2,8-dioxabicyclo[3.2.1]octane-4,7-diyl diacetate (46):



To a solution of **45** (25 mg, 0.06 mmol) in Et₃N (6 mL) was added Ac₂O (0.03 mL, 0.32 mmol), and catalytic DMAP at 0 °C and stirred for 4 h. After completion of the reaction, reaction mixture was concentrated and purified by column chromatography (20% ethyl acetate in light petroleum) to obtain **46** (29 mg, 87%) as a colorless liquid.

Mol. Formula	: C ₂₈ H ₄₀ O ₉
Mol. Weight	: 520.61
[α]_D²⁵	: +61.0 (<i>c</i> 1, CHCl ₃)
IR (CHCl₃, cm⁻¹)	: 3391, 2931, 2851, 1745, 1648, 1402, 1231, 1045, 755, 602.
¹H NMR	: δ 1.29–1.40 (m, 9H), 1.44–1.52 (m, 1H), 1.59–1.62 (m,

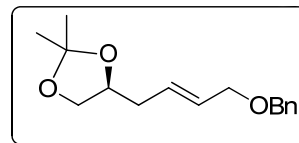
(500 MHz, CDCl₃) 2H), 1.71–1.79 (m, 2H), 1.84 (ddd, $J = 3.1, 7.5, 14.4$ Hz, 1H), 2.06 (s, 3H), 2.08 (s, 6H), 2.61 (dd, $J = 7.5, 14.4$ Hz, 1H), 3.46 (t, $J = 6.6$ Hz, 2H), 3.78 (ddd, $J = 2.6, 5.0, 9.5$ Hz, 1H), 4.05 (dd, $J = 5.0, 12.1$ Hz, 1H), 4.20 (dd, $J = 2.5, 12.1$ Hz, 1H), 4.50 (s, 2H), 4.60 (dd, $J = 4.0, 7.5$ Hz, 1H), 4.82 (dd, $J = 4.0, 9.5$ Hz, 1H), 5.22 (dd, $J = 3.1, 7.5$ Hz, 1H), 7.27–7.34 (m, 5H).

¹³C NMR (125 MHz, CDCl₃) : δ 20.8 (q, 2C), 21.0 (q), 23.0 (t), 26.2 (t), 29.4 (t), 29.4 (t), 29.8 (t, 2C), 32.4 (t), 33.5 (t), 63.4 (t), 65.0 (d), 70.0 (d), 70.5 (t), 72.8 (t), 73.6 (d), 75.7 (d), 107.1 (s), 127.4 (d), 127.6 (d, 2C), 128.3 (d, 2C), 138.7 (s), 169.5 (s), 170.0 (s), 170.8 (s).

Elemental Analysis : Calcd: C, 64.60; H, 7.74.
Found: C, 64.86; H, 7.35.

ESI-MS m/z : 543.10 [M+Na]⁺

(*S,E*)-4-(4-(benzyloxy)but-2-enyl)-2,2-dimethyl-1,3-dioxolane (51):



To a DMF (15 mL) solution of allylic alcohol **55** (1.2 g, 6.9 mmol), at 0 °C, was added NaH (334 mg, 60% emulsion in paraffin oil, 8.4 mmol) and stirred for 30 min. BnBr (1 mL, 8.4 mmol) was added and stirring continued for 4 h at ambient temperature. Usual workup and purification by column chromatography (10% ethyl acetate in light petroleum) gave **51** (1.7 g, 95%) as a colorless oil.

Mol. Formula : C₁₆H₂₂O₃

Mol. Weight : 262.34

[α]_D²⁵ : +5.0 (*c* 0.5, CHCl₃)

IR (CHCl₃, cm⁻¹) : 3154, 1610, 1538, 1506, 1403, 1048, 929.

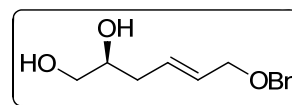
¹H NMR (200 MHz, CDCl₃) : δ 1.36 (s, 3H), 1.42 (s, 3H), 2.22–2.49 (m, 2H), 3.58 (dd, $J = 6.9, 7.9$ Hz, 1H), 3.96–4.06 (m, 3H), 4.16 (q, $J = 6.3$ Hz, 1H), 4.50 (s, 2H), 5.68–5.73 (m, 2H), 7.31–7.36 (m,

5H).

^{13}C NMR : δ 25.6 (q), 26.8 (q), 36.6 (t), 68.9 (t), 70.5 (t), 72.0 (t),
(50 MHz, CDCl_3) 75.2 (d), 108.9 (s), 127.6 (d), 127.7 (d, 2C), 128.3 (d, 2C),
129.0 (d), 129.5 (d), 138.2 (s).

Elemental Analysis : Calcd: C, 73.25; H, 8.45.
Found: C, 73.59; H, 8.30.

ESI-MS m/z : 285.14 $[\text{M}+\text{Na}]^+$

(*S,E*)-6-(benzyloxy)hex-4-ene-1,2-diol (56):

A solution of **51** (600 mg, 2.29 mmol) in MeOH (10 mL) was treated with catalytic *p*-TSA and stirred for 8 h. The reaction mixture was quenched with Et_3N and concentrated at reduced pressure. The residue was purified on silica gel by eluting with 40% ethyl acetate in light petroleum to obtain **56** (497 mg, 98%) as a thick liquid.

Mol. Formula : $\text{C}_{13}\text{H}_{18}\text{O}_3$

Mol. Weight : 222.28

$[\alpha]_D^{25}$: +1.9 (*c* 0.6, CHCl_3)

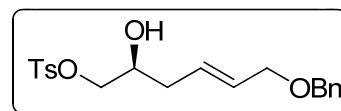
IR (CHCl_3 , cm^{-1}) : 3156, 3019, 1653, 1538, 1403, 1099, 1050, 668.

^1H NMR : δ 2.14–2.20 (m, 2H), 3.31–3.68 (m, 5H), 3.96 (d, $J = 4.3$
(200 MHz, CDCl_3) Hz, 2H), 4.48 (s, 2H), 5.66–5.71 (m, 2H), 7.30–7.34 (m,
5H).

^{13}C NMR : δ 36.2 (t), 65.9 (t), 70.5 (t), 71.3 (d), 72.1 (t), 127.6 (d),
(50 MHz, CDCl_3) 127.7 (d, 2C), 128.3 (d, 2C), 129.2 (d), 129.9 (d), 137.9
(s).

Elemental Analysis : Calcd: C, 70.24; H, 8.16.
Found: C, 70.30; H, 8.38.

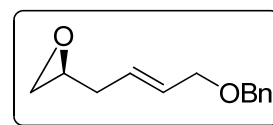
ESI-MS m/z : 245.57 $[\text{M}+\text{Na}]^+$

(*S,E*)-6-(benzyloxy)-2-hydroxyhex-4-enyl-4-methyl benzenesulfonate (57):

Catalytic *n*-Bu₂SnO was added to a solution of diol **56** (500 mg, 2.25 mmol) in DCM (5 mL), followed by Et₃N (0.6 mL, 4.49 mmol) and TsCl (515 mg, 2.69 mmol) and stirred for 2 h. The solvent was evaporated and crude residue was purified by column chromatography (30% ethyl acetate in light petroleum) to get tosylated product **57** (754 mg, 89%)

Mol. Formula	: C ₂₀ H ₂₄ O ₅ S
Mol. Weight	: 376.46
[α]_D²⁵	: +5.0 (<i>c</i> 1, CHCl ₃)
IR (CHCl₃, cm⁻¹)	: 3777, 3152, 1598, 1189, 1175, 1096, 975, 814, 749, 667.
¹H NMR (200 MHz, CDCl ₃)	: δ 2.21–2.27 (m, 2H), 2.36–2.41 (m, 1H), 2.43 (s, 3H), 3.86–4.04 (m, 5H), 4.48 (s, 2H), 5.63–5.68 (m, 2H), 7.31–7.35 (m, 7H), 7.79 (d, <i>J</i> = 8.3 Hz, 2H).
¹³C NMR (50 MHz, CDCl ₃)	: δ 21.6 (q), 35.9 (t), 68.7 (d), 70.3 (t), 72.2 (t), 73.0 (t), 127.6 (d), 127.7 (d, 2C), 127.9 (d, 2C), 128.0 (d), 128.4 (d, 2C), 129.9 (d, 2C), 130.6 (d), 132.6 (s), 138.1 (s), 145.0 (s).
Elemental Analysis	: Calcd: C, 63.81; H, 6.43. Found: C, 63.65; H, 6.53.
ESI-MS <i>m/z</i>	: 400.01 [M+Na] ⁺

(*S,E*)-2-(4-(benzyloxy)but-2-enyl)oxirane (50**):**

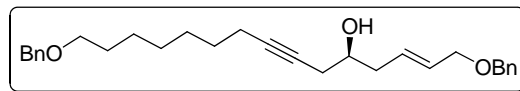


To a solution of tosylated product **57** (300 mg, 0.79 mmol) in THF (8 mL), NaH (38 mg, 60% emulsion in paraffin oil, 0.95 mmol) was added at 0 °C and stirred for 4 h while warming the reaction mixture to room temperature. The reaction mixture was quenched with ice, diluted with ethyl acetate, washed with water, brine, dried over Na₂SO₄ and concentrated. The residue was purified on silica gel column (20% ethyl acetate in light petroleum) to obtain **50** (133 mg, 82%) as a colorless liquid.

Mol. Formula	: C ₁₃ H ₁₆ O ₂
Mol. Weight	: 204.26
[α]_D²⁵	: –2.6 (<i>c</i> 1, CHCl ₃)

- IR** (CHCl₃, cm⁻¹) : 3150, 2925, 2854, 1621, 1538, 1217, 1097, 1027, 973, 834, 698.
- ¹H NMR** (400 MHz, CDCl₃) : δ 2.28–2.39 (m, 2H), 2.50 (dd, *J* = 2.8, 5.0 Hz, 1H), 2.76 (t, *J* = 4.4 Hz, 1H), 2.97–3.02 (m, 1H), 4.00–4.01 (m, 2H), 4.51 (s, 2H), 5.74–5.75 (m, 2H), 7.27–7.30 (m, 1H), 7.34–7.37 (m, 4H).
- ¹³C NMR** (50 MHz, CDCl₃) : δ 35.1 (t), 46.6 (t), 51.2 (d), 70.5 (t), 72.1 (t), 127.6 (d), 127.7 (d, 2C), 128.2 (d), 128.3 (d, 2C), 129.5 (d), 138.2 (s).
- Elemental Analysis** : Calcd: C, 76.44; H, 7.90.
Found: C, 76.23; H, 8.09.
- ESI-MS** *m/z* : 227.19 [M+Na]⁺

(*S,E*)-1,15-bis(benzyloxy)pentadec-2-en-7-yn-5-ol (58**):**



To a solution of alkyne **21** (230 mg, 1 mmol) in THF (10 mL) at -78 °C, *n*-BuLi (0.6 mL, 1.6 M solution, 0.98 mmol) was added and stirred for 15 min. To this, BF₃.Et₂O (0.12 mL, 0.98 mmol) was added and stirred again for 15 min. A solution of the epoxide **50** (100 mg, 0.49 mmol) in THF (5 mL) was added at -78 °C and stirred further at the same temperature for another 1 h. The reaction mixture was quenched with THF-H₂O (1:1) at -78 °C. The organic layer was separated and the aqueous layer was washed with ethyl acetate. The combined organic layer was washed with brine, dried (Na₂SO₄), and concentrated. The residue was chromatographed on silica gel (20% ethyl acetate in light petroleum) to procure **58** (164 mg, 77%) as a syrup.

- Mol. Formula** : C₂₉H₃₈O₃
- Mol. Weight** : 434.61
- [α]_D²⁵** : -3.2 (*c* 1.9, CHCl₃)
- IR** (CHCl₃, cm⁻¹) : 3377, 3030, 2928, 2855, 1657, 1496, 1454, 1361, 1192, 1097, 1070, 1028, 973, 816, 736, 666.
- ¹H NMR** (200 MHz, CDCl₃) : δ 1.33–1.67 (m, 10H), 2.06–2.16 (m, 3H), 2.33–2.36 (m, 4H), 3.46 (t, *J* = 6.6 Hz, 2H), 3.71–3.80 (m, 1H), 4.00 (d,

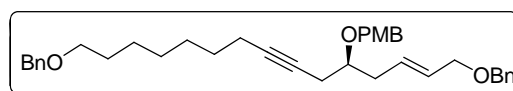
$J = 4.2$ Hz, 2H), 4.50 (s, 2H), 4.51 (s, 2H), 5.71–5.76 (m, 2H), 7.31–7.35 (m, 10H).

^{13}C NMR : δ 18.7 (t), 26.0 (t), 27.1 (t), 28.8 (t), 28.9 (t), 28.9 (t), 29.7 (t), 39.1 (t), 69.6 (d), 70.4 (t), 70.6 (t), 72.1 (t), 72.8 (t), 75.8 (s), 83.4 (s), 127.4 (d), 127.6 (d, 2C), 127.7 (d, 2C), 128.3 (d, 2C), 128.4 (d, 3C), 129.6 (d), 129.8 (d), 138.3 (s), 138.6 (s).

Elemental Analysis : Calcd: C, 80.14; H, 8.81.
Found: C, 80.31; H, 8.69.

ESI-MS m/z : 457.40 $[\text{M}+\text{Na}]^+$

(*S,E*)-(5-(4-methoxybenzyloxy)pentadec-2-en-7-yne-1,15-diyl)bis(oxy)bis(methylene)dibenzene (49):



Preparation of **49** was carried out by treating **58** (100 mg, 0.23 mmol) in DMF (5 mL) with NaH (11 mg, 60% emulsion in paraffin oil, 0.27 mmol) and PMBCl (43 mg, 0.27 mmol) at 0 °C and stirring the contents for 8 h. Usual workup and chromatographic (30% ethyl acetate in light petroleum) purification resulted in **49** (96 mg, 75%) as a colorless liquid.

Mol. Formula : $\text{C}_{37}\text{H}_{46}\text{O}_4$

Mol. Weight : 554.76

$[\alpha]_D^{25}$: -6.4 (c 1, CHCl_3)

IR (CHCl_3 , cm^{-1}) : 3583, 3029, 2930, 2855, 1613, 1513, 1454, 1360, 1173, 1095, 1036, 972, 821, 736, 697.

^1H NMR : δ 1.30–1.41 (m, 6H), 1.44–1.52 (m, 2H), 1.57–1.64 (m, 2H), 2.14 (tt, $J = 2.3, 7.1$ Hz, 2H), 2.32–2.49 (m, 4H), 3.45 (t, $J = 6.7$ Hz, 2H), 3.54 (q, $J = 5.9$ Hz, 1H), 3.77 (s, 3H), 3.98 (d, $J = 5.2$ Hz, 2H), 4.46 (d, $J = 11.5$ Hz, 1H), 4.49 (s, 4H), 4.55 (d, $J = 11.5$ Hz, 1H), 5.67–5.78 (m, 2H), 6.84 (d, $J = 8.5$ Hz, 2H), 7.26 (d, $J = 8.5$ Hz, 2H), 7.24–7.29 (m, 2H), 7.32–7.34 (m, 8H).

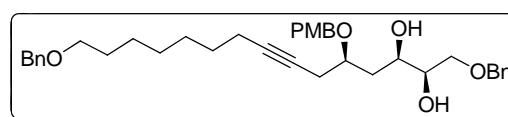
^{13}C NMR : δ 18.7 (t), 23.8 (t), 26.0 (t), 28.8 (t), 28.9 (t), 28.9 (t), 29.7

(100 MHz, CDCl₃) (t), 36.5 (t), 55.2 (q), 70.4 (t), 70.7 (t), 70.8 (t), 71.8 (t), 72.8 (t), 76.4 (s), 76.9 (d), 82.1 (s), 113.7 (d, 2C), 127.4 (d), 127.5 (d), 127.6 (d, 2C), 127.7 (d, 2C), 128.3 (d, 4C), 129.1 (d), 129.3 (d, 2C), 130.1 (d), 130.5 (s), 138.3 (s), 138.6 (s), 159.1 (s).

Elemental Analysis : Calcd: C, 80.11; H, 8.36.
Found: C, 80.28; H, 8.46.

ESI-MS *m/z* : 577.42 [M+Na]⁺

(2*R*,3*R*,5*R*)-1,15-bis(benzyloxy)-5-(4-methoxybenzyloxy)pentadec-7-yne-2,3-diol (48):



The olefin compound **49** (240 mg, 0.43 mmol) was taken in a mixture of *t*BuOH and water (1:1, 4 mL) and cooled to 0 °C. MeSO₂NH₂ (41 mg, 0.43 mmol) and AD-mix-β (605 mg, 1.4 μmol) were added to it and stirred while maintaining the bath temperature at 10 °C and stirred for 24 h. The reaction mixture was partitioned between water and ethyl acetate, aqueous layer was repeatedly washed with ethyl acetate. The combined organic layer was washed with brine, dried (Na₂SO₄), and concentrated and residue was chromatographed on silica gel (50% ethyl acetate in light petroleum) to afford **48** (185 mg, 73%) as a white foam.

Mol. Formula : C₃₇H₄₈O₆

Mol. Weight : 588.77

IR (CHCl₃, cm⁻¹) : 3310, 2930, 2856, 1612, 1586, 1514, 1454, 1361, 1301, 1173, 1094, 1036, 972, 820, 737, 697.

¹H NMR (200 MHz, CDCl₃) : δ 1.32–1.50 (m, 8H), 1.54–1.64 (m, 2H), 1.85–1.88 (m, 2H), 2.10–2.16 (m, 2H), 2.43–2.51 (m, 1H), 2.73–2.85 (m, 1H), 3.45 (t, *J* = 6.6 Hz, 2H), 3.54–3.59 (m, 3H), 3.74–3.80 (m, 1H), 3.78 (s, 3H), 3.88 (m, 1H), 4.40 (d, *J* = 11.0 Hz, 1H), 4.49 (s, 3H), 4.53 (s, 3H), 4.65 (d, *J* = 11.0 Hz, 1H), 6.85 (d, *J* = 8.6 Hz, 2H), 7.25 (d, *J* = 8.6 Hz, 2H), 7.23–7.29 (m, 1H), 7.30–7.35 (m, 9H).

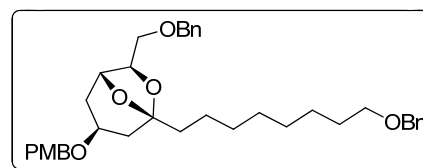
¹³C NMR : δ 18.7 (t), 24.0 (t), 26.0 (t), 28.7 (t), 28.8 (t), 28.9 (t), 29.7

(100 MHz, CDCl₃) (t), 37.3 (t), 55.2 (q), 70.4 (t), 70.7 (t), 70.8 (d), 71.8 (t), 72.6 (d), 72.8 (t), 73.5 (t), 75.8 (s), 77.2 (d), 82.7 (s), 113.8 (d), 113.9 (d), 127.4 (d), 127.6 (d), 127.7 (d), 128.3 (d), 128.4 (d), 129.5 (d), 129.6 (d), 129.7 (s), 137.9 (s), 138.6 (s), 159.3 (s).

Elemental Analysis : Calcd: C, 75.48; H, 8.22.
Found: C, 75.61; H, 8.05.

ESI-MS *m/z* : 611.67 [M+Na]⁺

(1*R*,3*S*,5*R*,7*R*)-5-(8-(benzyloxy)octyl)-7-(benzyloxymethyl)-3-(4-methoxybenzyloxy)-6,8-dioxabicyclo[3.2.1]octane (47):



A solution of alkynol **48** (55 mg, 0.09 mmol) and PdCl₂(CH₃CN)₂ (3 mg, 10 μmol) in dry CH₃CN (6 mL) was stirred under argon for 1 h. Concentration followed by chromatographic purification (20% ethyl acetate in light petroleum) gave **47** (28 mg, 51 %) as a colorless oil.

Mol. Formula : C₃₇H₄₈O₆

Mol. Weight : 588.77

[α]_D²⁵ : +11.4 (*c* 0.7, CHCl₃)

IR (CHCl₃, cm⁻¹) : 3445, 3251, 3020, 2941, 1603, 1386, 1166, 1107, 1072, 1017, 874, 669.

¹H NMR (400 MHz, CDCl₃) : δ 1.28–1.36 (m, 10H), 1.53 (dd, *J* = 10.3, 12.5 Hz, 1H), 1.62–1.76 (m, 5H), 2.05 (dd, *J* = 5.8, 13.0 Hz, 1H), 2.20 (dd, *J* = 6.1, 12.5 Hz, 1H), 3.28 (t, *J* = 8.6 Hz, 1H), 3.37 (dd, *J* = 5.5, 9.1 Hz, 1H), 3.46 (t, *J* = 6.6 Hz, 2H), 3.80 (s, 3H), 3.86–3.94 (m, 1H), 3.98 (dd, *J* = 5.7, 7.6 Hz, 1H), 4.40 (br s, 1H), 4.44 (s, 2H), 4.50 (s, 2H), 4.52 (s, 2H), 6.86 (d, *J* = 8.4 Hz, 2H), 7.23 (d, *J* = 8.4 Hz, 2H), 7.28–7.34 (m, 10H).

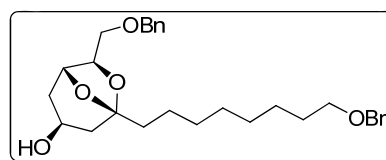
¹³C NMR (100 MHz, CDCl₃) : δ 23.1 (t), 26.2 (t), 29.4 (t), 29.5 (t), 29.6 (t), 29.7 (t), 35.2 (t), 37.6 (t), 40.9 (t), 55.3 (q), 69.7 (t), 70.0 (d), 71.4 (t),

72.8 (t), 73.4 (t), 75.7 (d), 77.2 (t), 77.6 (d), 109.1 (s),
113.7 (d), 113.8 (d), 127.4 (d), 127.6 (d, 2C), 127.7 (d,
2C), 128.3 (d, 2C), 128.4 (d, 2C), 129.0 (d), 129.2 (d,
2C), 130.5 (s), 138.0 (s), 138.7 (s), 159.2 (s).

Elemental Analysis : Calcd: C, 75.48; H, 8.22.
Found: C, 75.29; H, 8.36.

ESI-MS m/z : 611.70 [M+Na]⁺

**(1*R*,3*S*,5*R*,7*R*)-5-(8-(benzyloxy)octyl)-7-(benzyloxy
methyl)-6,8-dioxabicyclo [3.2.1]octan-3-ol (59):**



A solution of compound **47** (20 mg, 0.03 mmol) in DCM and water (9:1, 4 mL) was treated with DDQ (9 mg, 0.04 mmol) and stirred for 2 h. The reaction mixture was partitioned between water and DCM. The collective organic layer was washed with brine, dried over Na₂SO₄ and concentrated. The residue was chromatographed on silica gel (40% ethyl acetate in light petroleum) to obtain **59** (13 mg, 86%) as a colorless liquid.

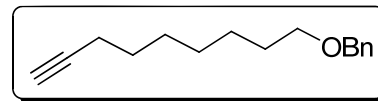
Mol. Formula : C₂₉H₄₀O₅

Mol. Weight : 468.62

¹H NMR : δ 1.28–1.40 (m, 10H), 1.48 (dd, *J* = 10.0, 12.6 Hz, 1H),
(400 MHz, CDCl₃) 1.59–1.67 (m, 5H), 2.03–2.07 (m, 1H), 2.14–2.18 (m,
1H), 3.29 (dd, *J* = 8.0, 8.9 Hz, 1H), 3.38 (dd, *J* = 5.6, 9.2
Hz, 1H), 3.46 (t, *J* = 6.6 Hz, 2H), 4.02 (dd, *J* = 5.6, 7.9
Hz, 1H), 4.14–4.23 (m, 1H), 4.41 (t, *J* = 2.6 Hz, 1H), 4.50
(s, 2H), 4.53 (s, 2H), 7.29–7.37 (m, 10H).

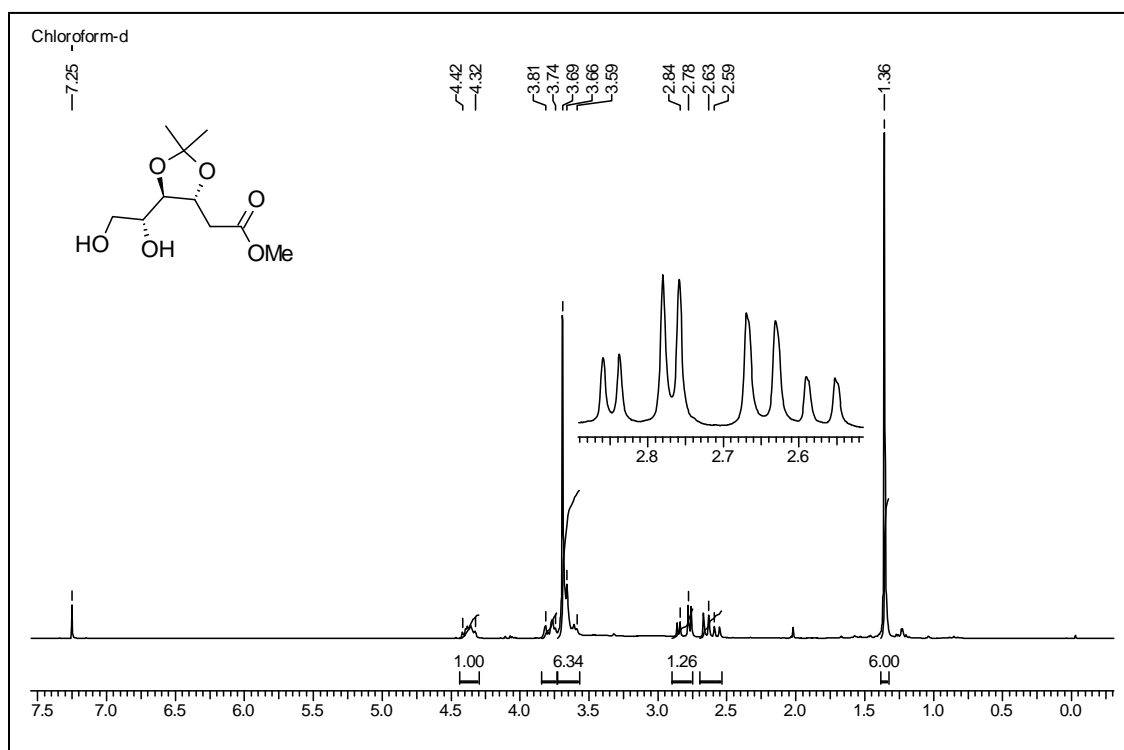
¹³C NMR : δ 23.0 (t), 26.2 (t), 29.4 (t), 29.5 (t), 29.6 (t), 29.7 (t), 37.5
(125 MHz, CDCl₃) (t), 38.0 (t), 43.8 (t), 63.9 (d), 70.5 (t), 71.3 (t), 72.8 (t),
73.4 (t), 75.6 (d), 77.6 (d), 109.0 (s), 127.5 (d), 127.6 (d,
2C), 127.8 (d, 3C), 128.3 (d, 2C), 128.4 (d, 2C), 137.9 (s),
138.7 (s).

ESI-MS m/z : 491.61 [M+Na]⁺

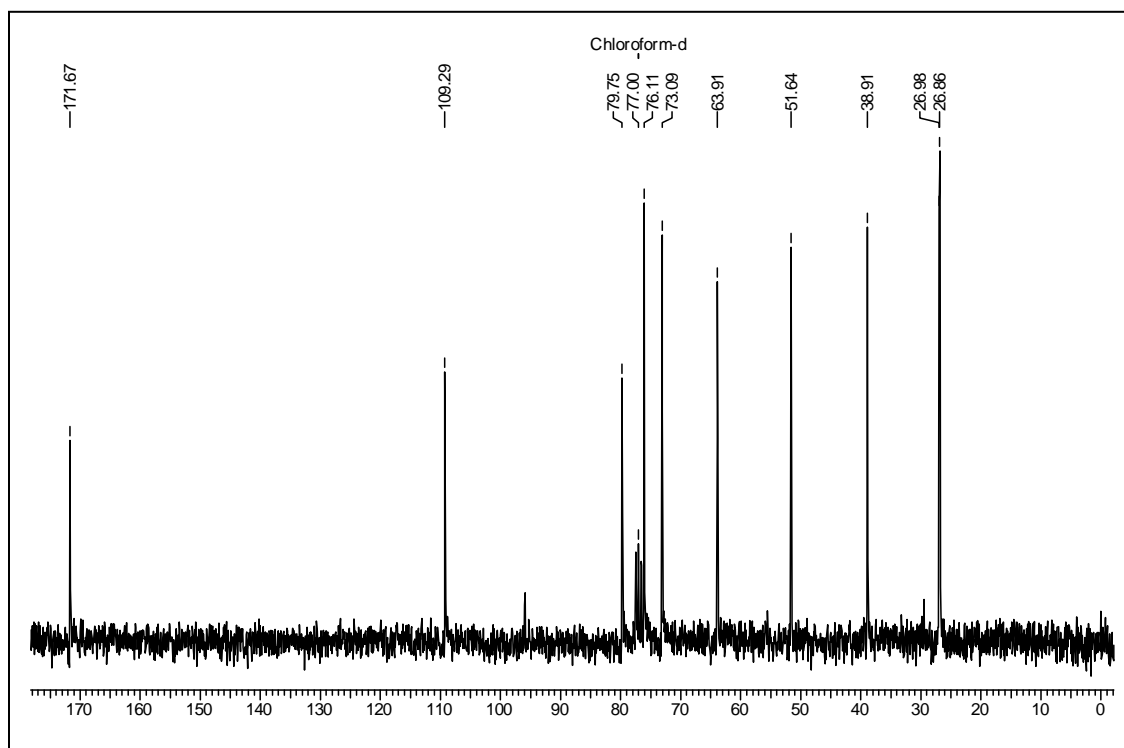
((non-8-ynyloxy)methyl)benzene (21):

Aldehyde **34** (1 g, 4.27 mmol) was treated with K_2CO_3 (1.18 g, 8.54 mmol) and Bestmann-Ohira reagent (984 mg, 5.12 mmol) in MeOH (15 mL) and stirred for 14 h at room temperature. The residue was chromatographed on silica gel (5% ethyl acetate in light petroleum) to obtain **16** (775 mg, 79%) as a colorless liquid.

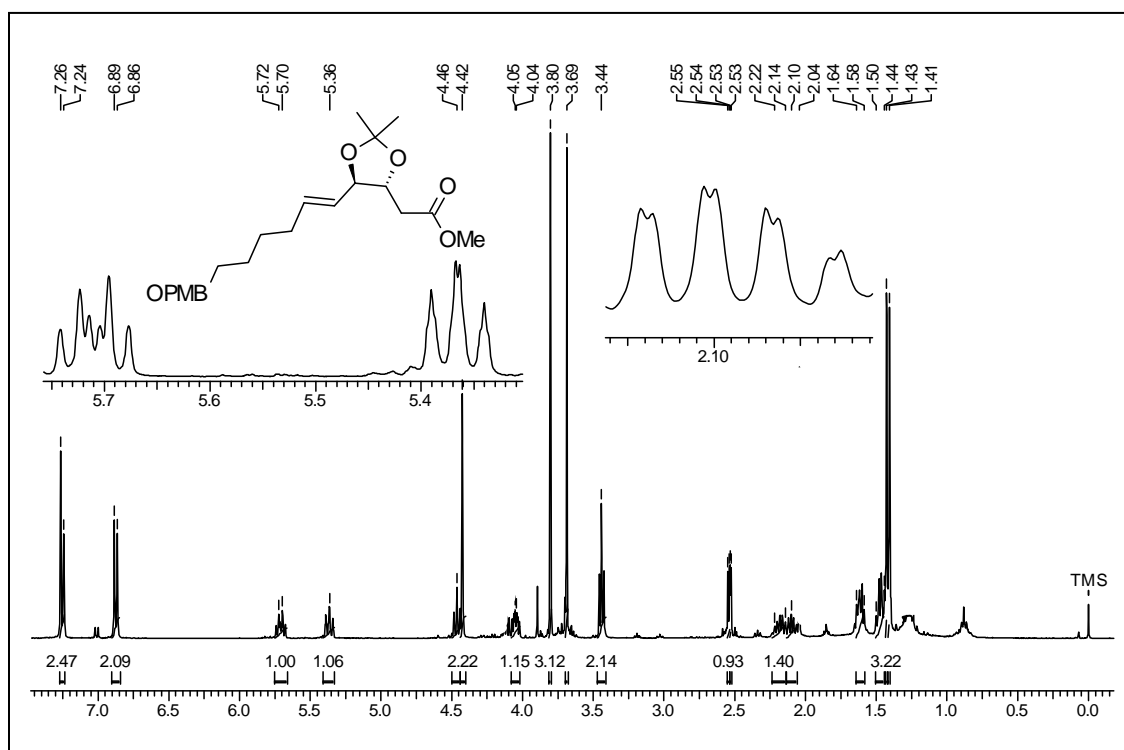
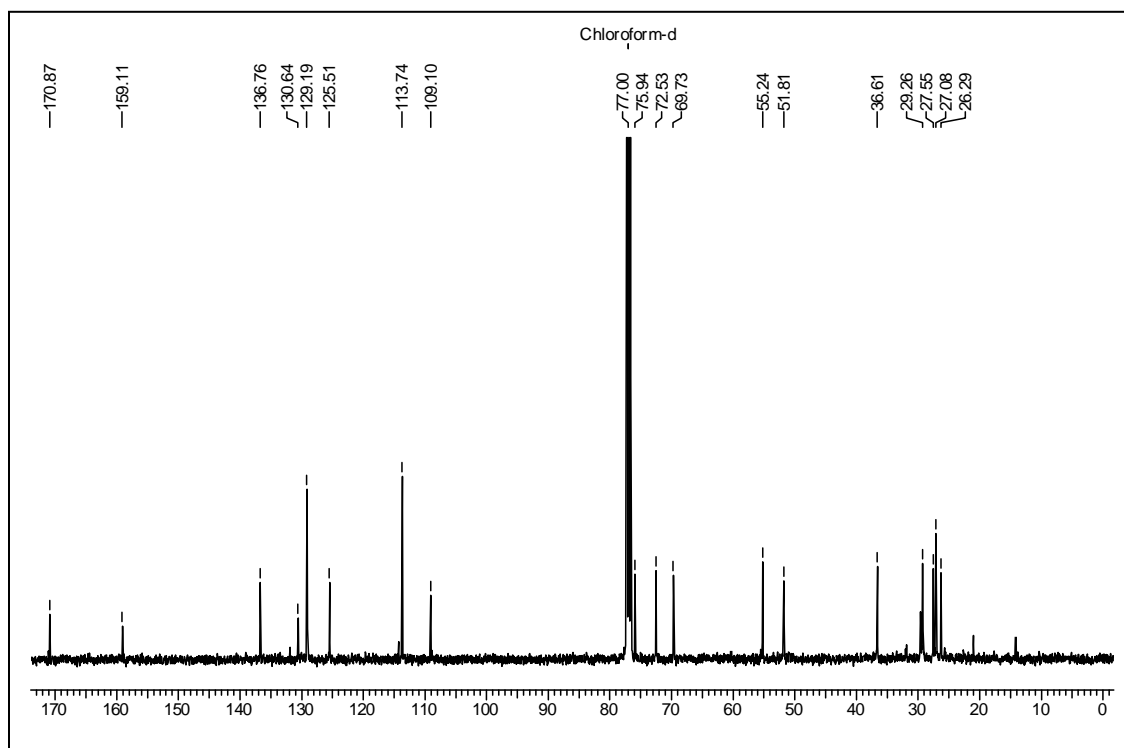
Mol. Formula	: $C_{16}H_{22}O$
Mol. Weight	: 230.35
IR (CHCl₃, cm⁻¹)	: 3308, 3064, 3029, 3010, 2934, 2857, 2116, 1954, 1495, 1454, 1362, 1099, 1028, 909.
¹H NMR (200 MHz, CDCl ₃)	: δ 1.34–1.65 (m, 10H), 1.93 (t, $J = 2.6$ Hz, 1H), 2.17 (dt, $J = 2.6, 6.9$ Hz, 2H), 3.46 (t, $J = 6.5$ Hz, 2H), 4.50 (s, 2H), 7.26–7.35 (m, 5H).
¹³C NMR (50 MHz, CDCl ₃)	: δ 18.1 (t), 25.8 (t), 28.1 (t), 28.4 (t), 28.7 (t), 29.5 (t), 68.1 (d), 70.1 (t), 72.5 (t), 84.2 (s), 127.1 (d), 127.3 (d, 2C), 128.0 (d, 2C), 138.4 (s).
Elemental Analysis	: Calcd: C, 83.43; H, 9.63. Found: C, 83.15; H, 9.76.
ESI-MS m/z	: 253.41 [M+Na] ⁺

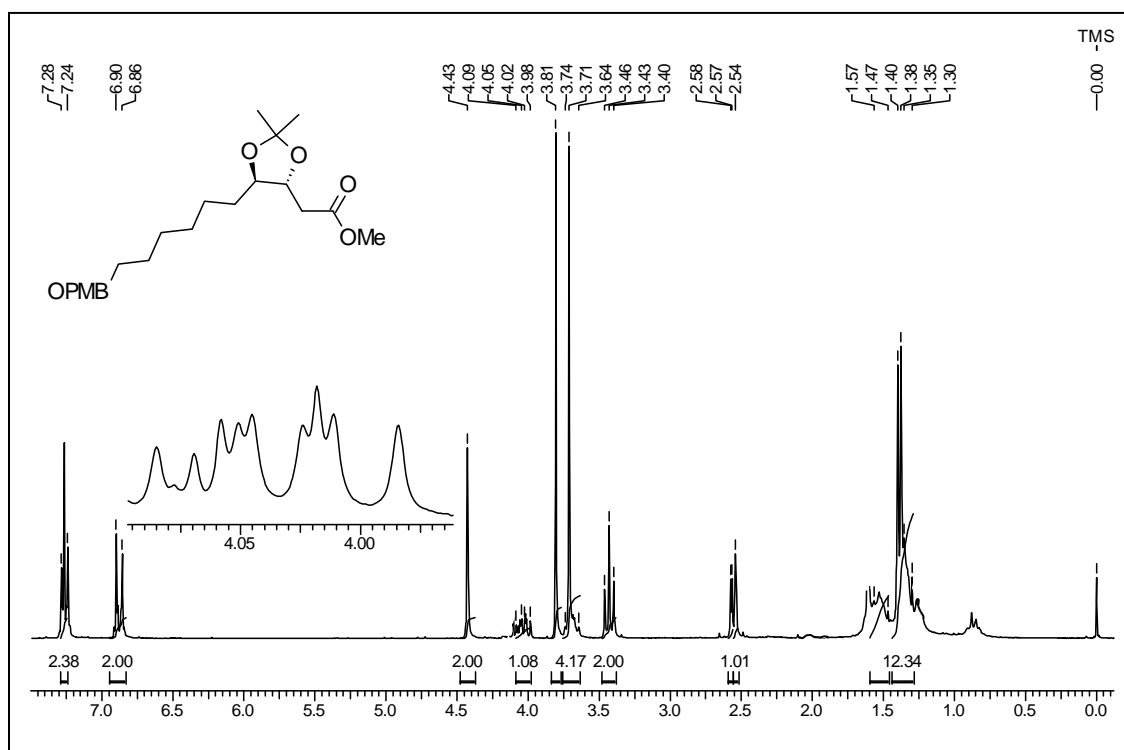
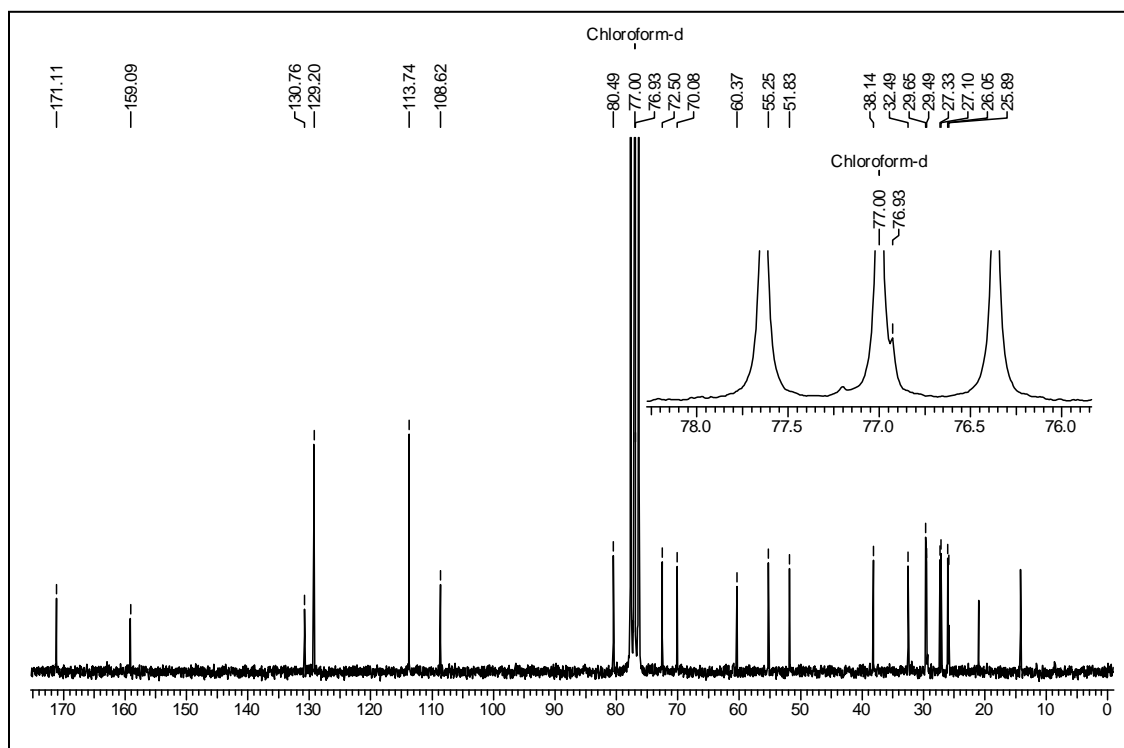


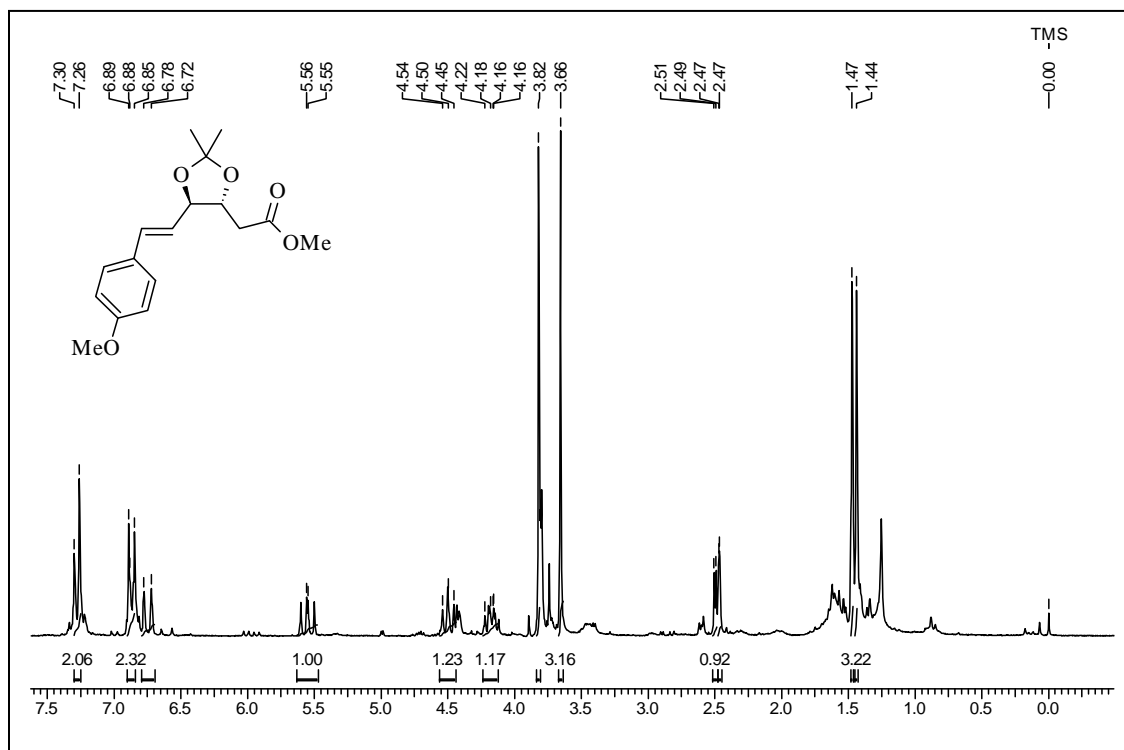
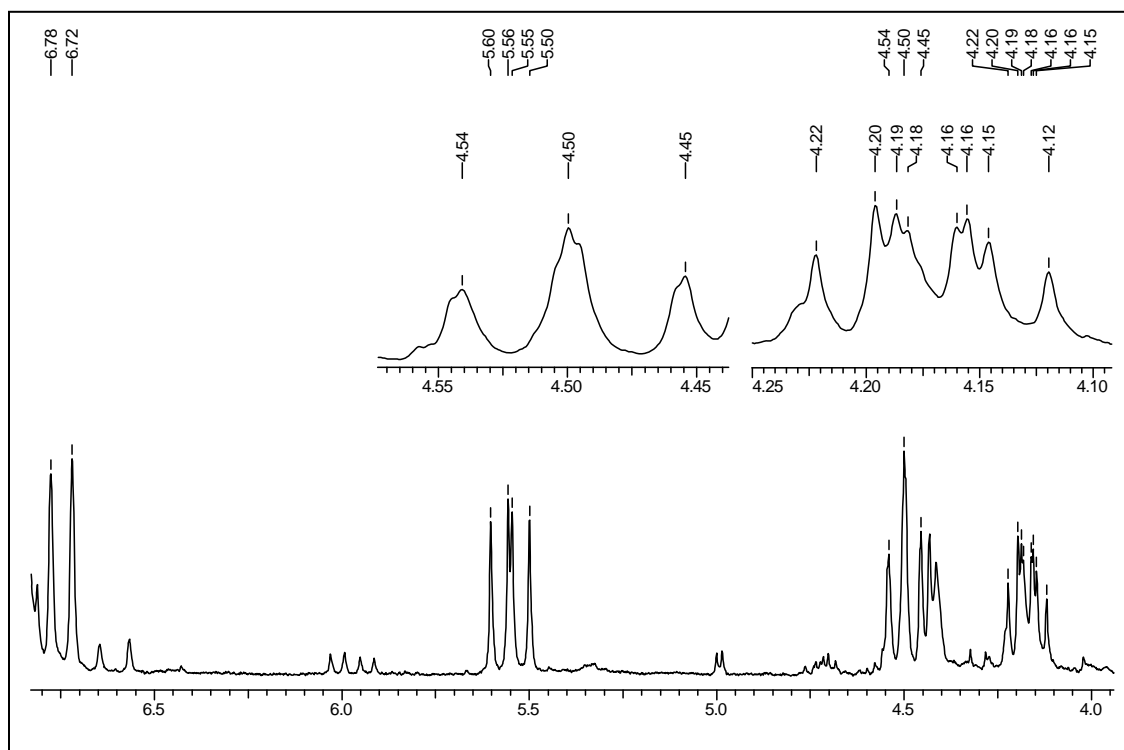
^1H NMR Spectrum of 24 in CDCl_3

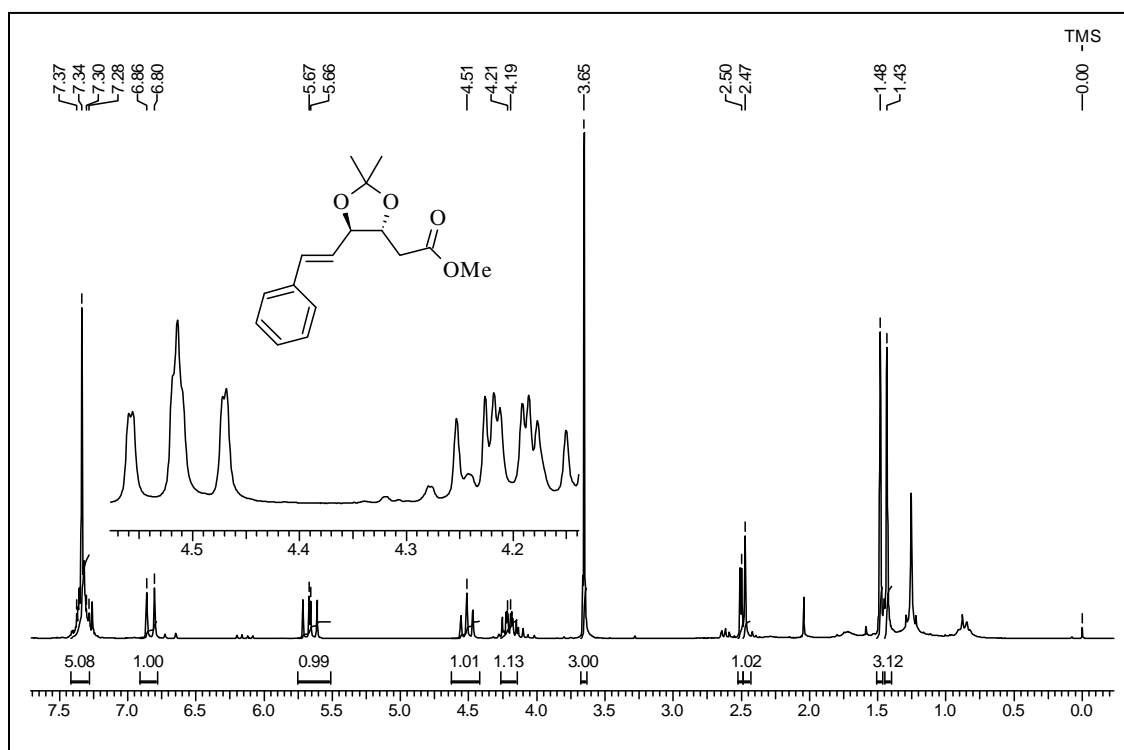


^{13}C NMR Spectrum of 24 in CDCl_3

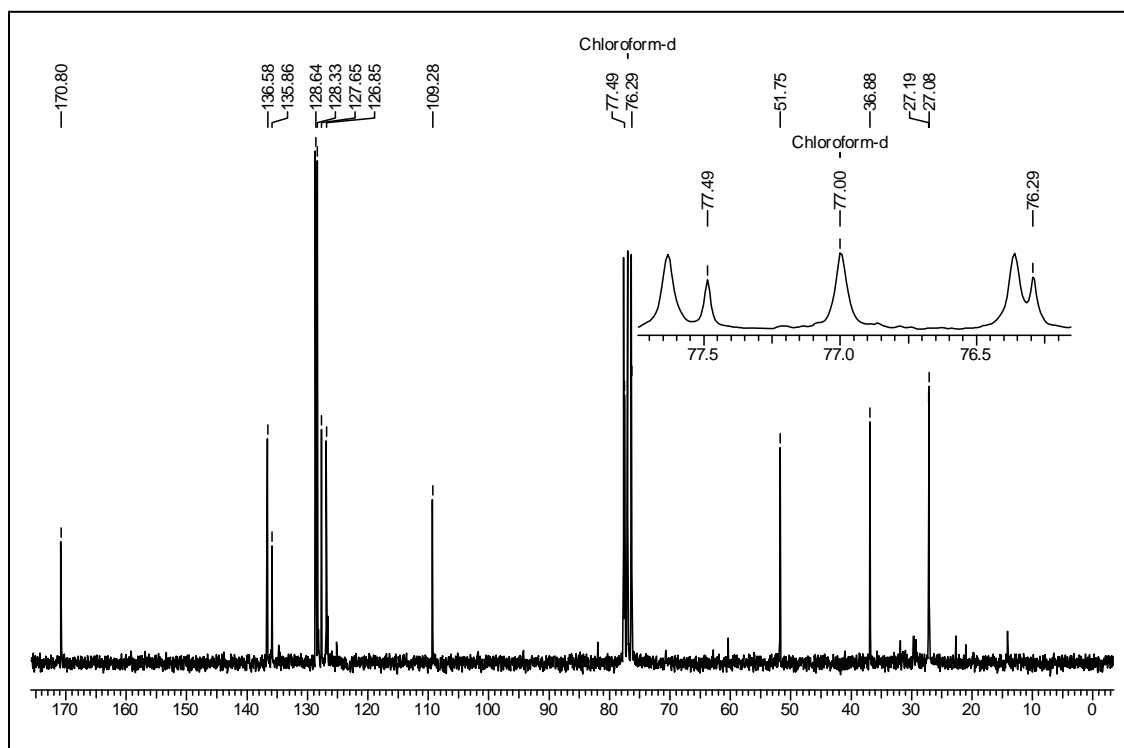
 ^1H NMR Spectrum of 29 in CDCl_3  ^{13}C NMR Spectrum of 29 in CDCl_3

**¹H NMR Spectrum of 30 in CDCl₃****¹³C NMR Spectrum of 30 in CDCl₃**

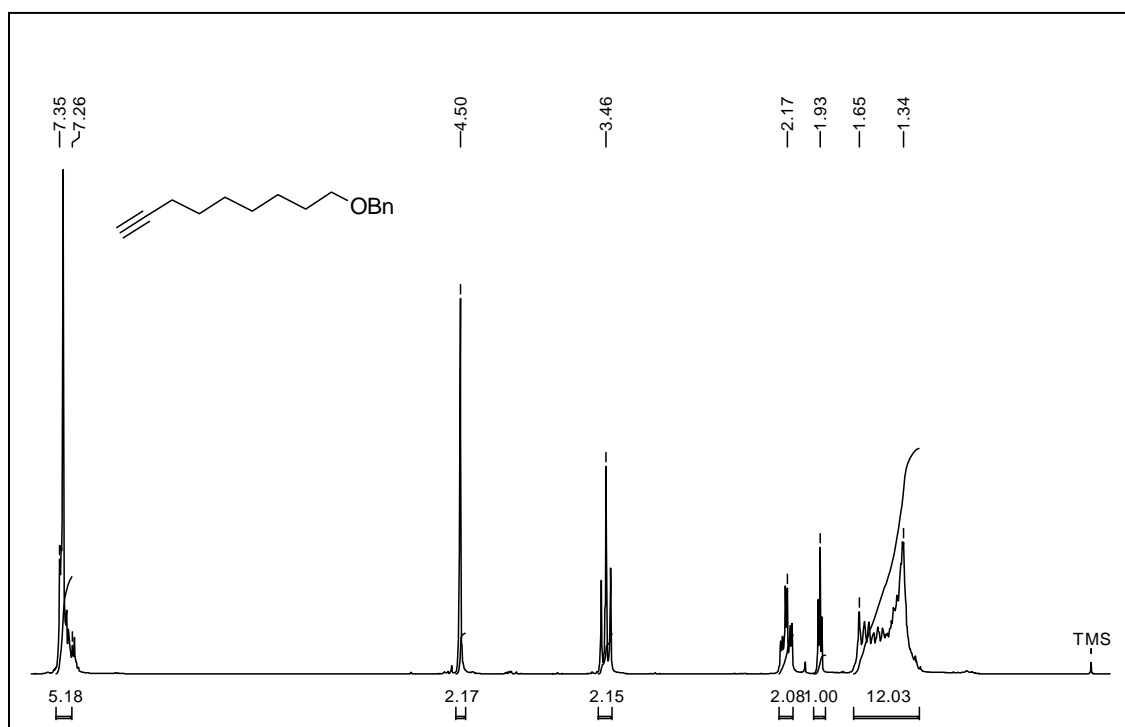
¹H NMR Spectrum of 31 in CDCl₃¹H NMR Spectrum of 31 in CDCl₃



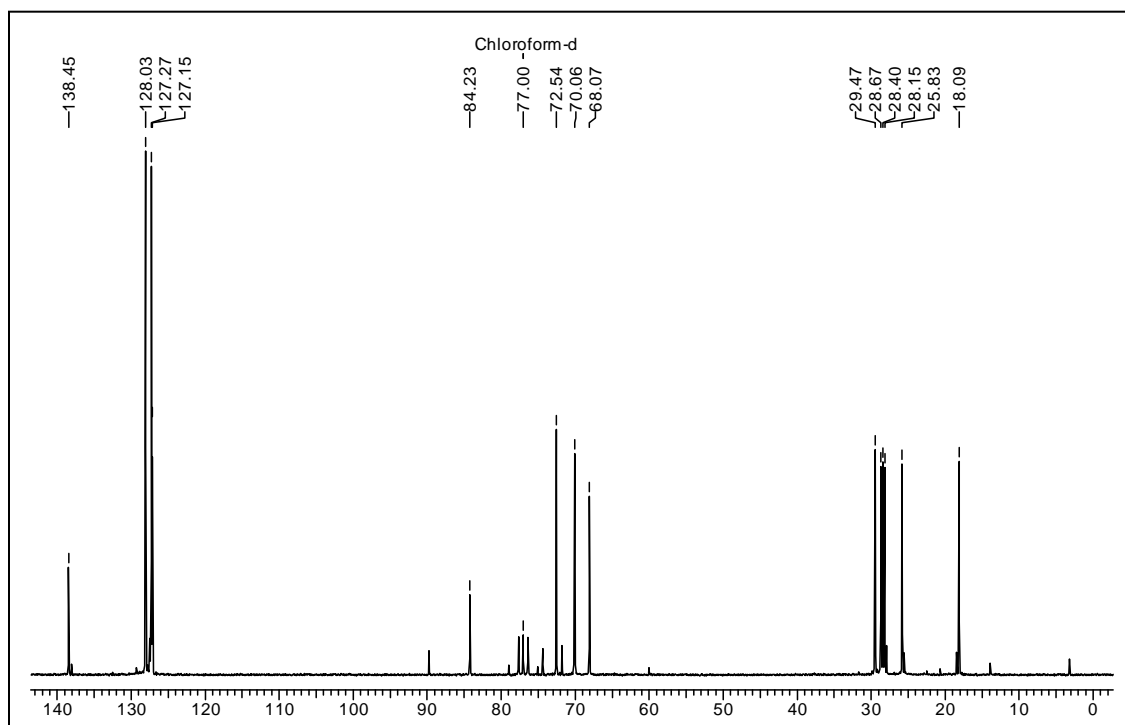
¹H NMR Spectrum of 32 in CDCl₃



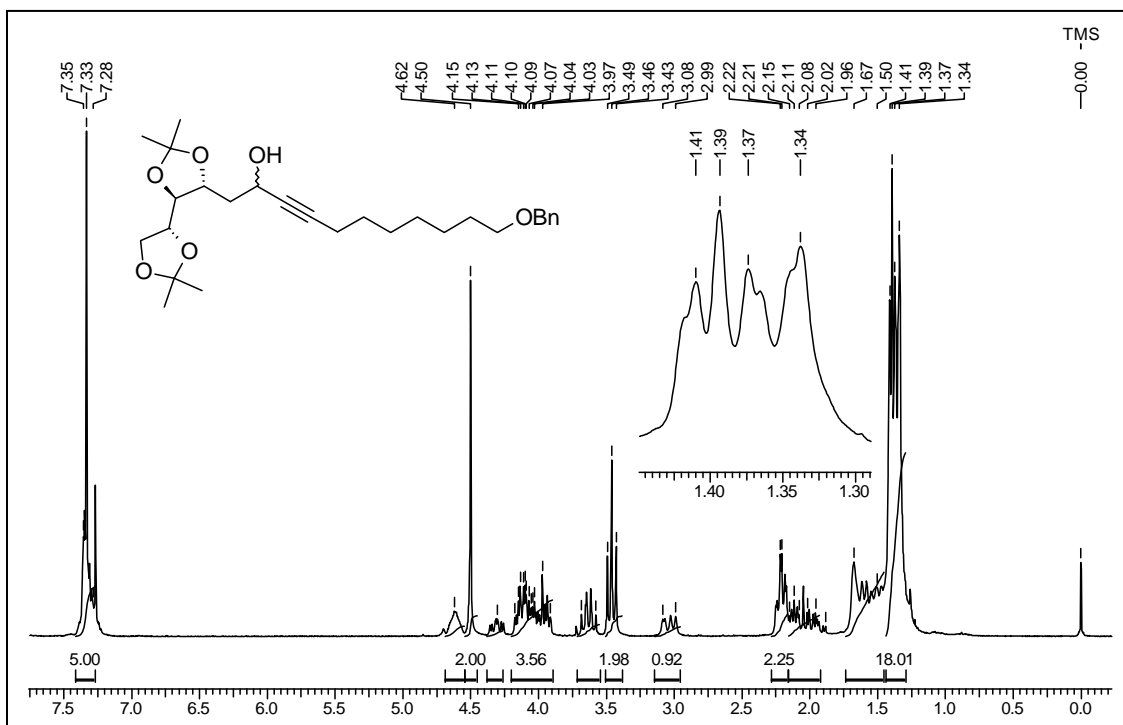
¹³C NMR Spectrum of 32 in CDCl₃



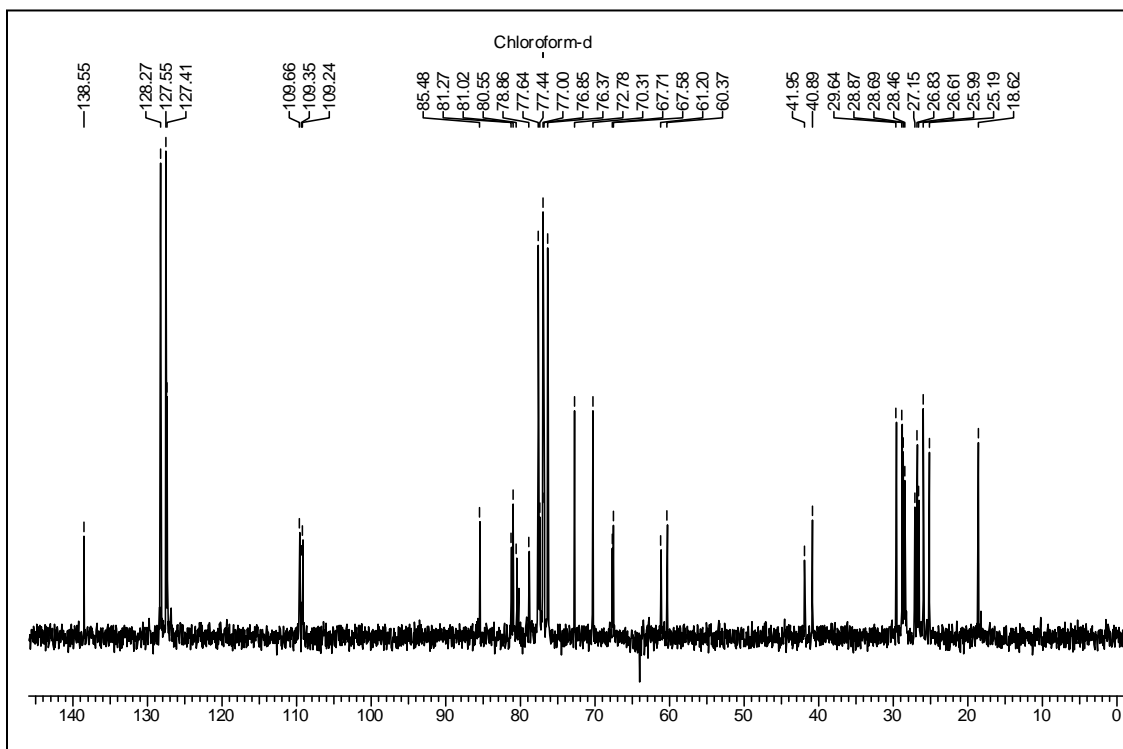
¹H NMR Spectrum of 21 in CDCl₃



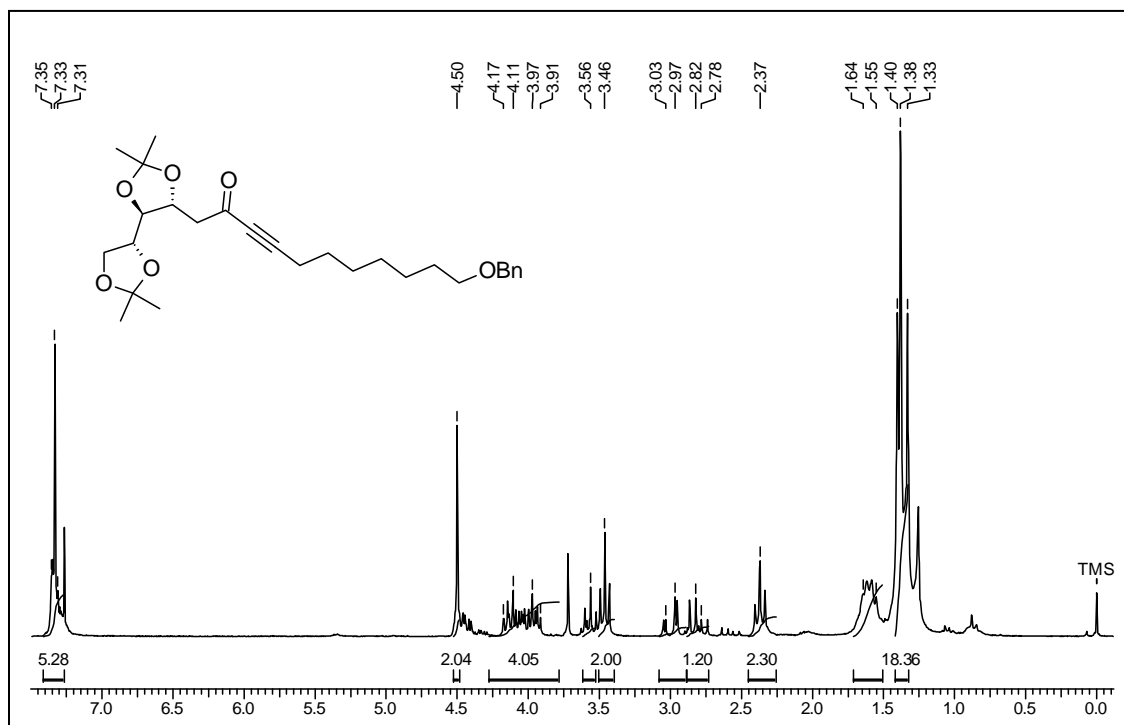
¹³C NMR Spectrum of 21 in CDCl₃



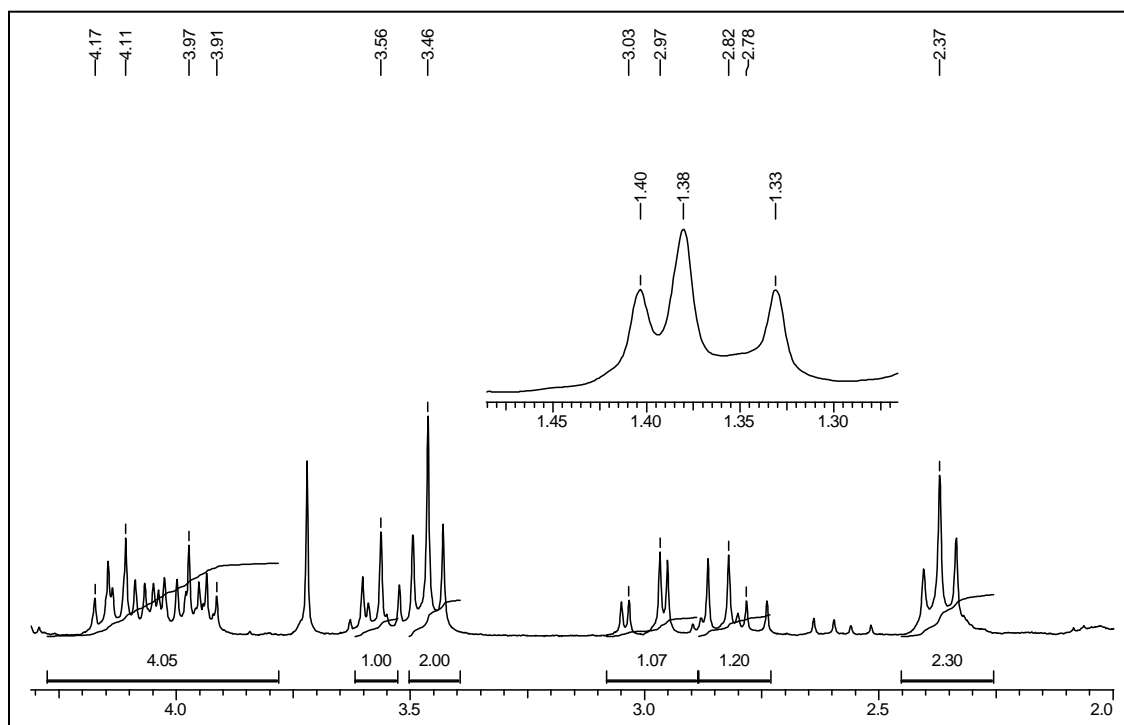
¹H NMR Spectrum of 37 in CDCl₃



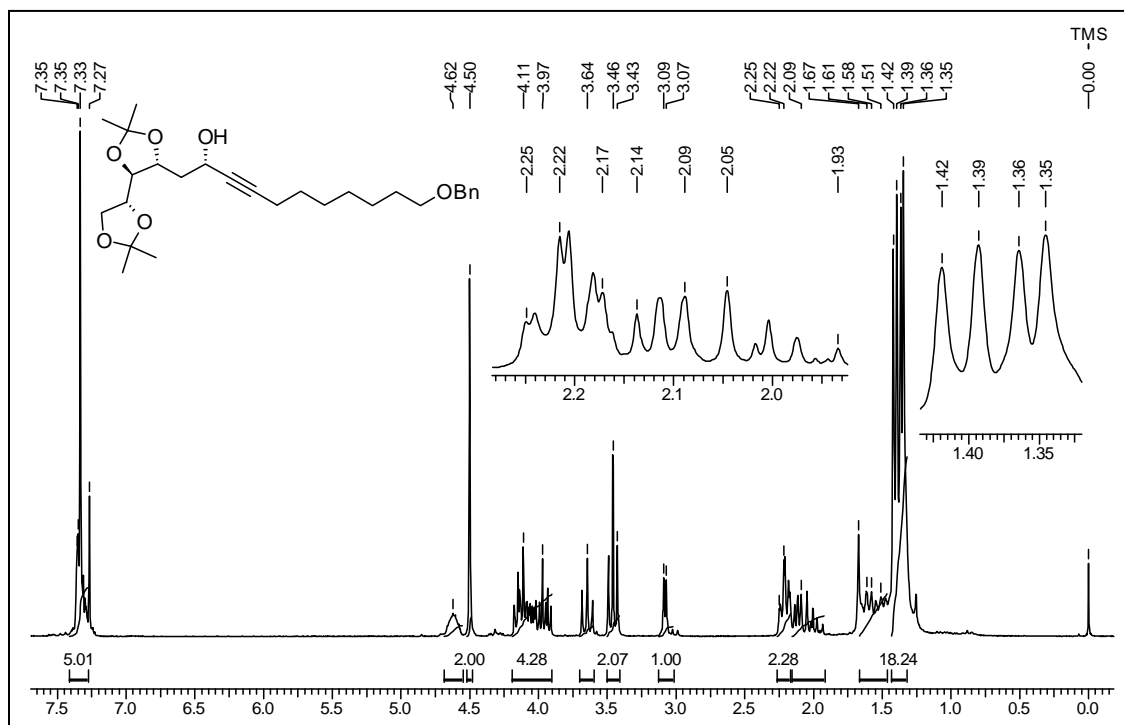
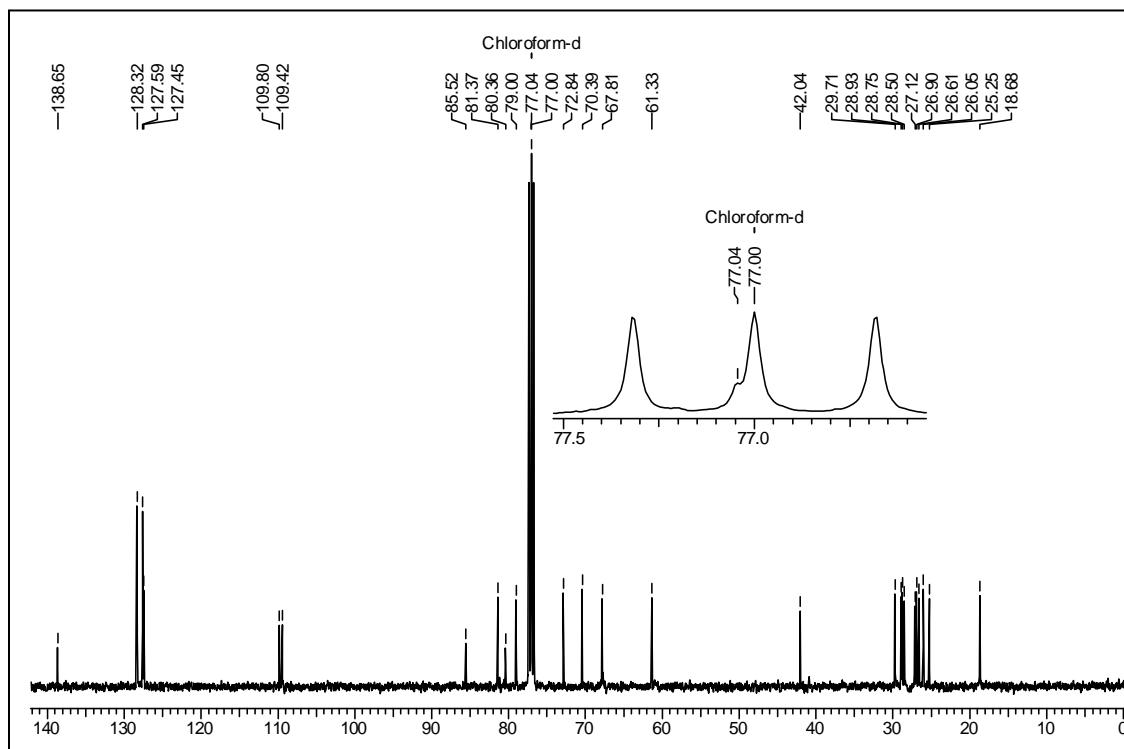
¹³C NMR Spectrum of 37 in CDCl₃

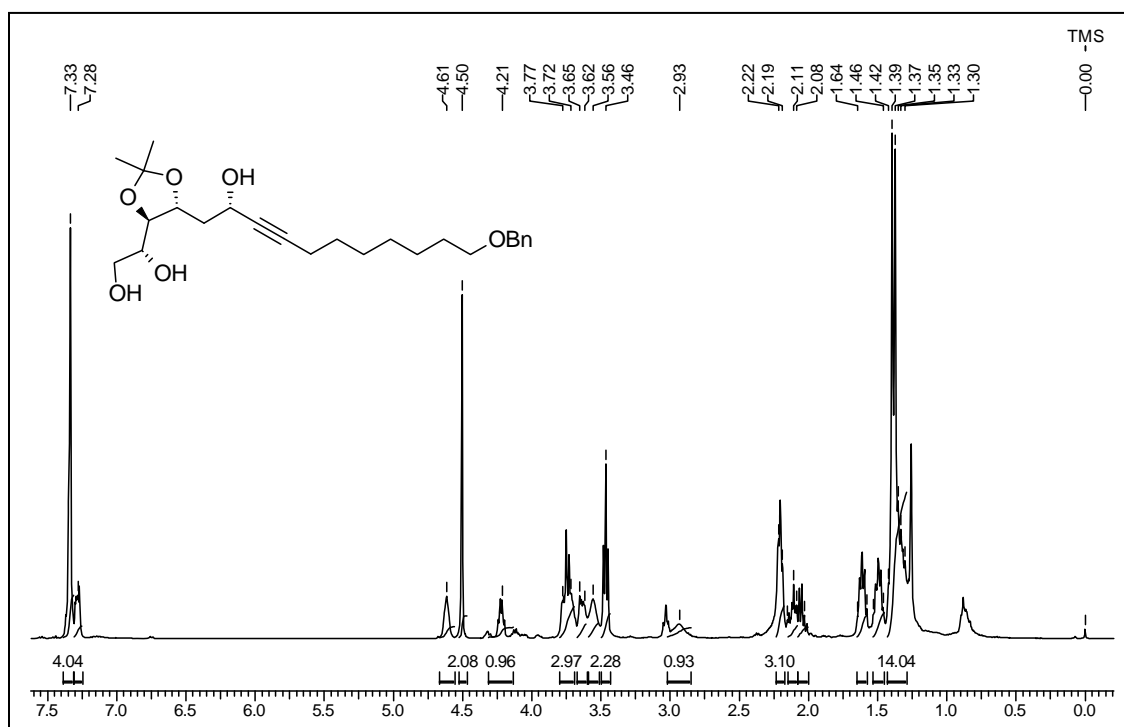


^1H NMR Spectrum of 38 in CDCl_3

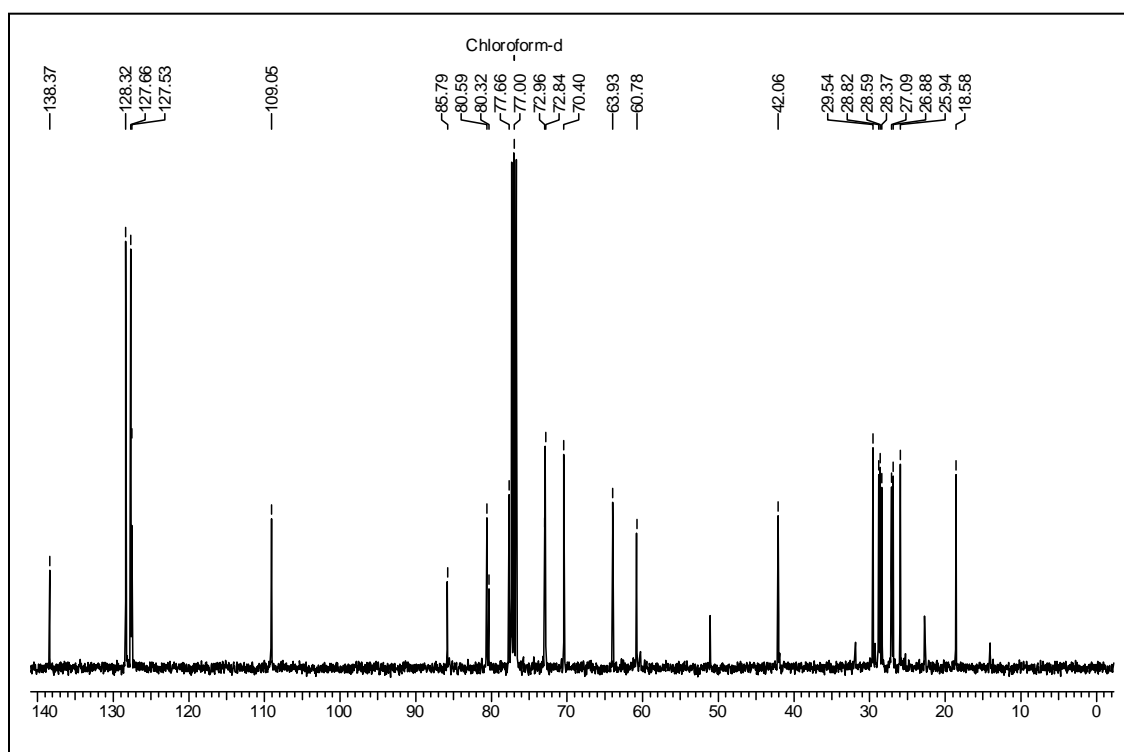


^1H NMR Spectrum of 38 in CDCl_3

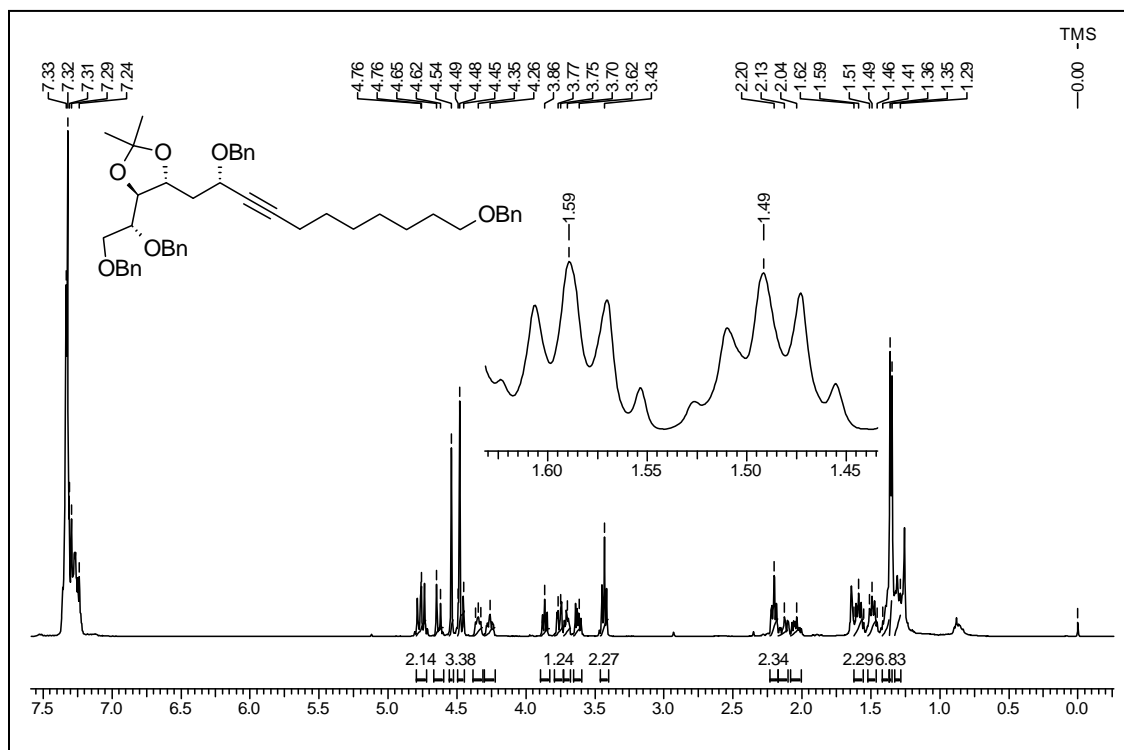
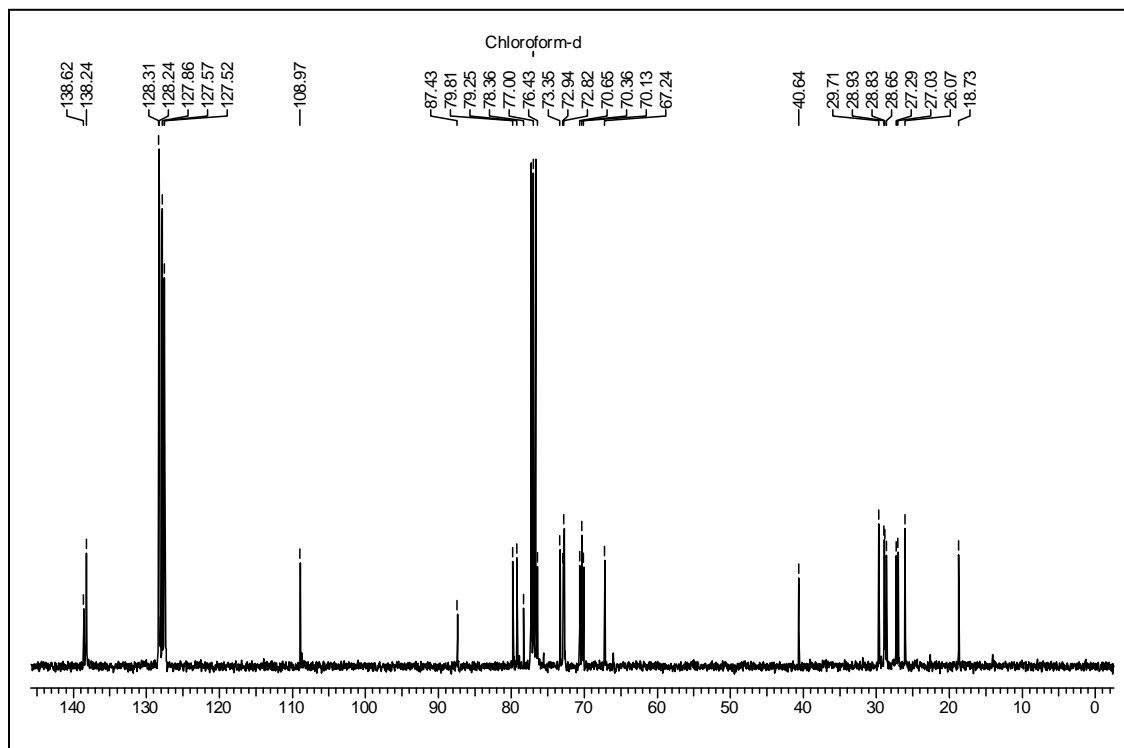
**¹H NMR Spectrum of 39 in CDCl₃****¹³C NMR Spectrum of 39 in CDCl₃**

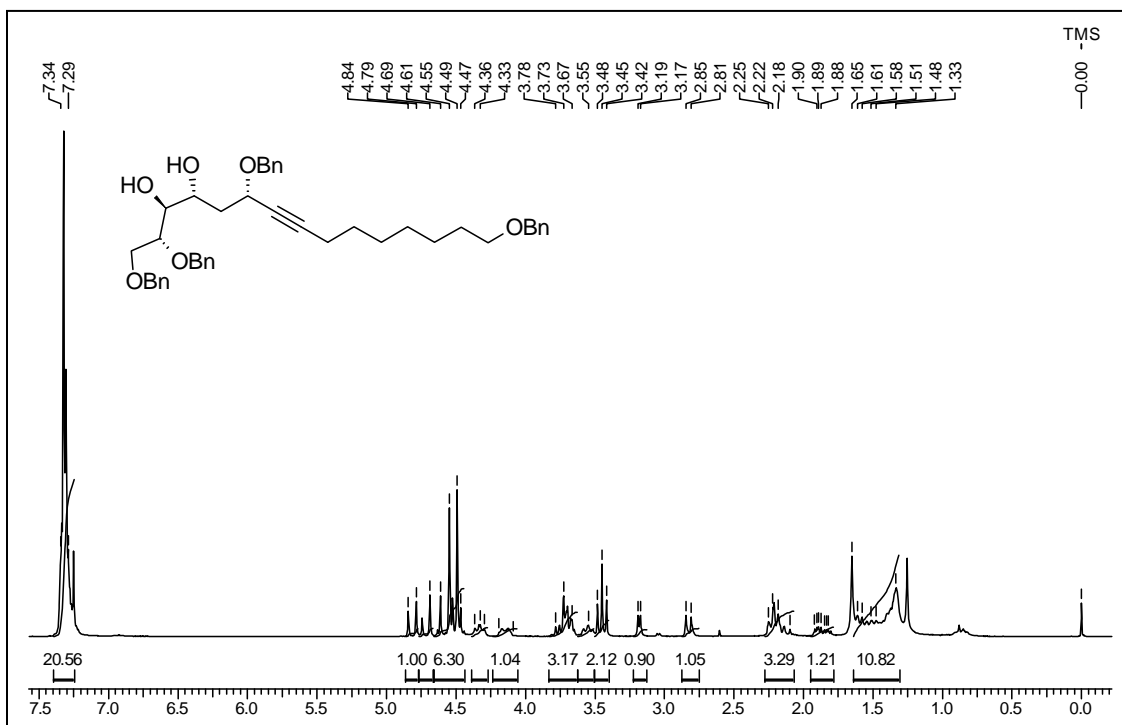
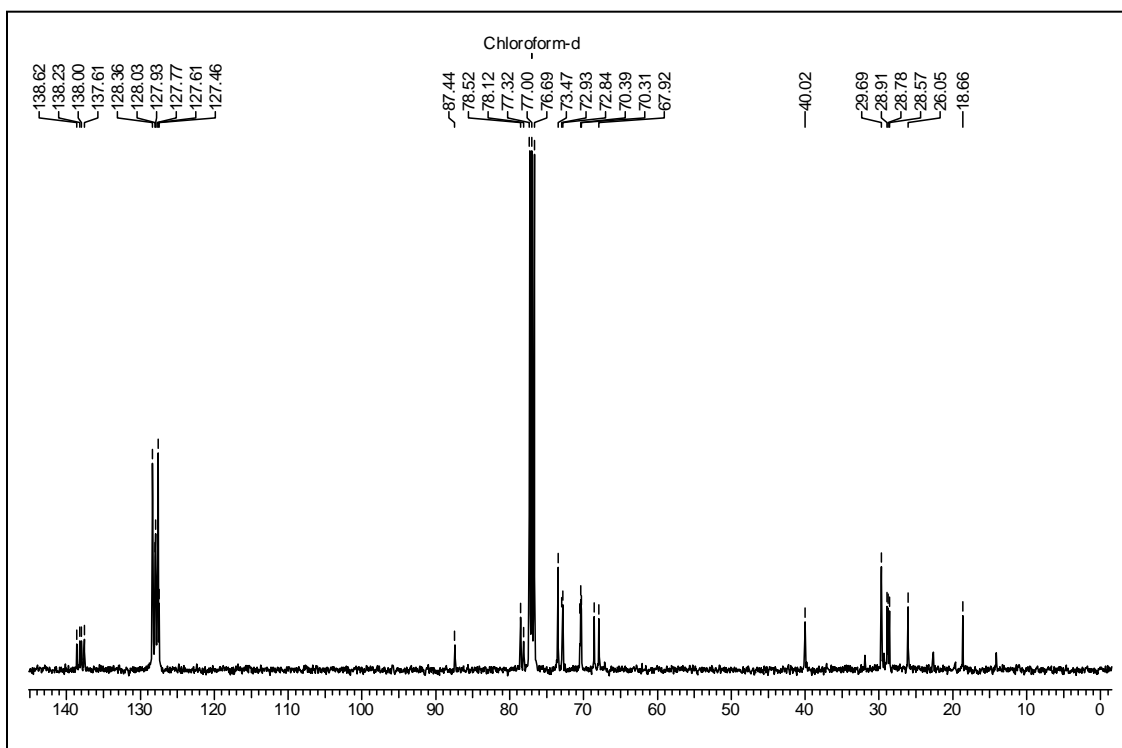


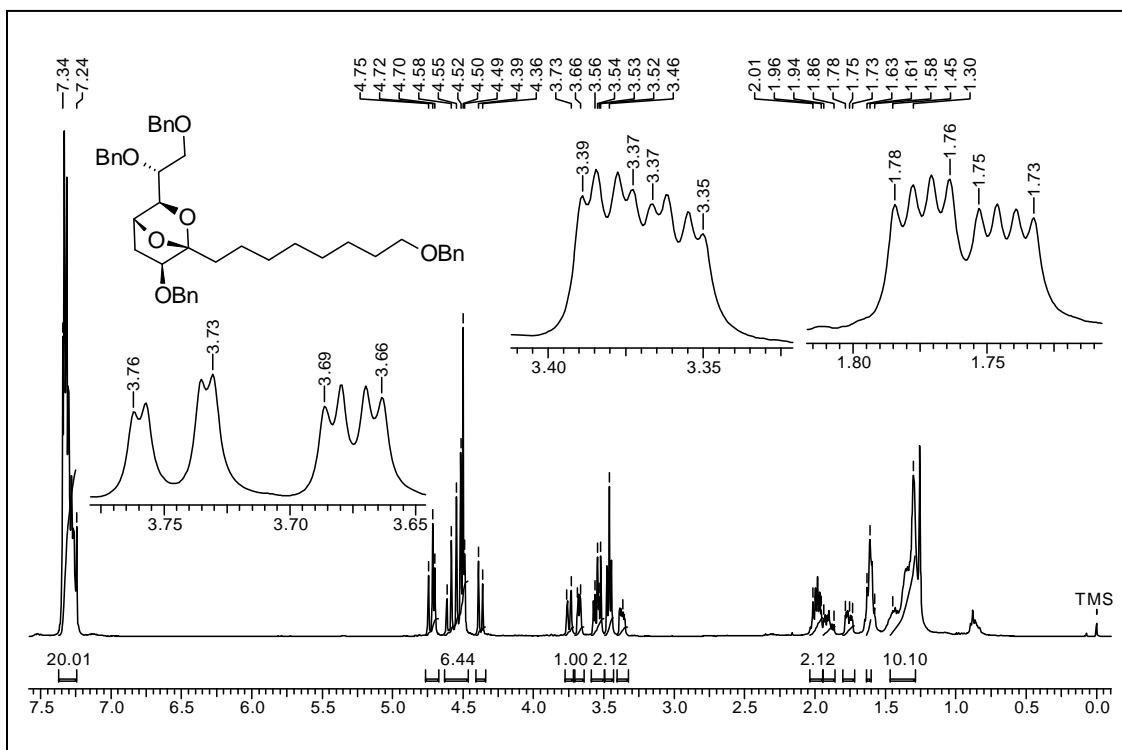
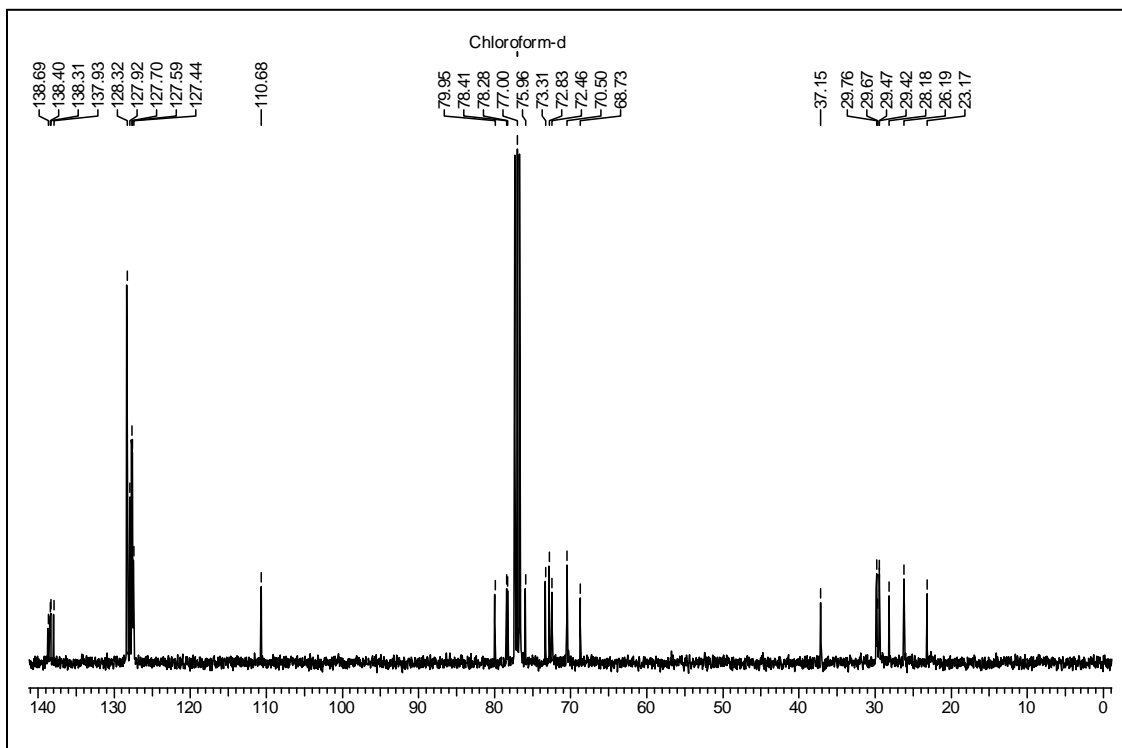
^1H NMR Spectrum of 40 in CDCl_3

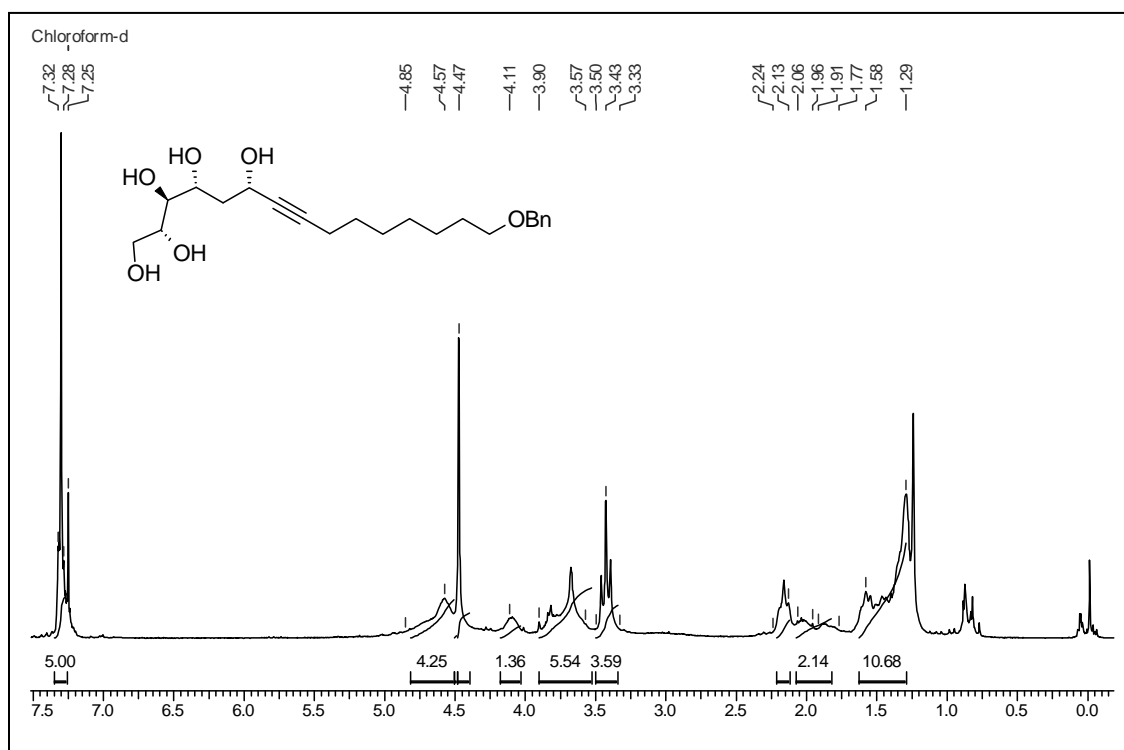
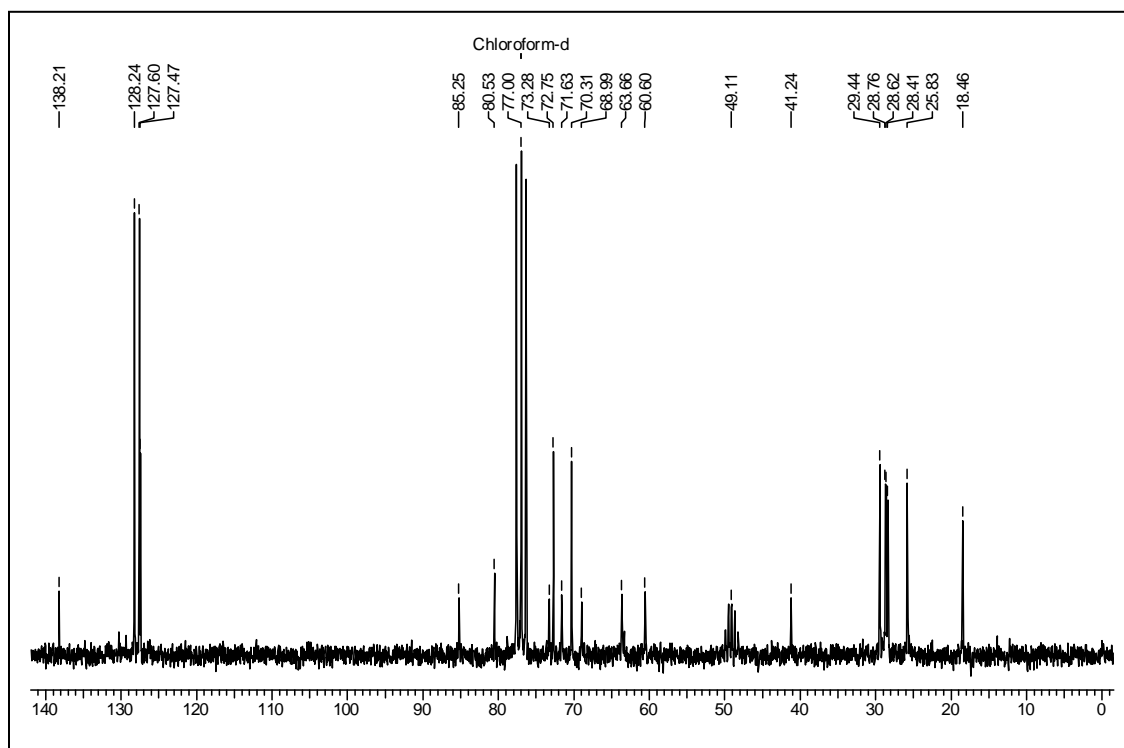


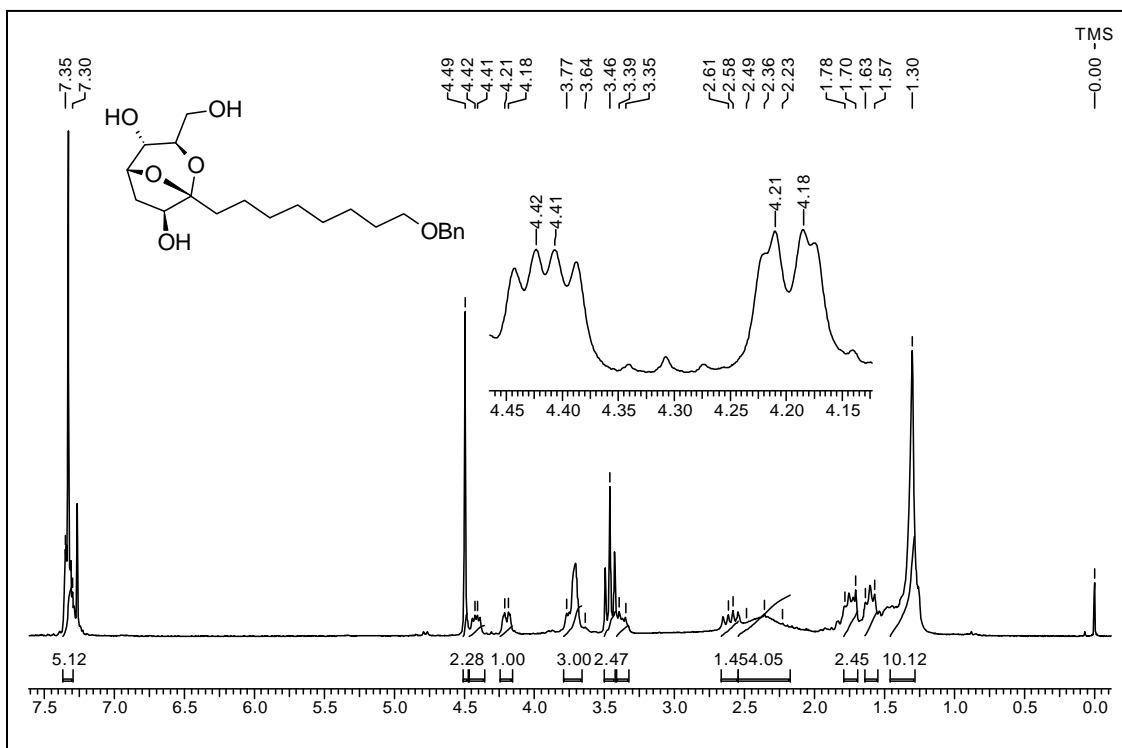
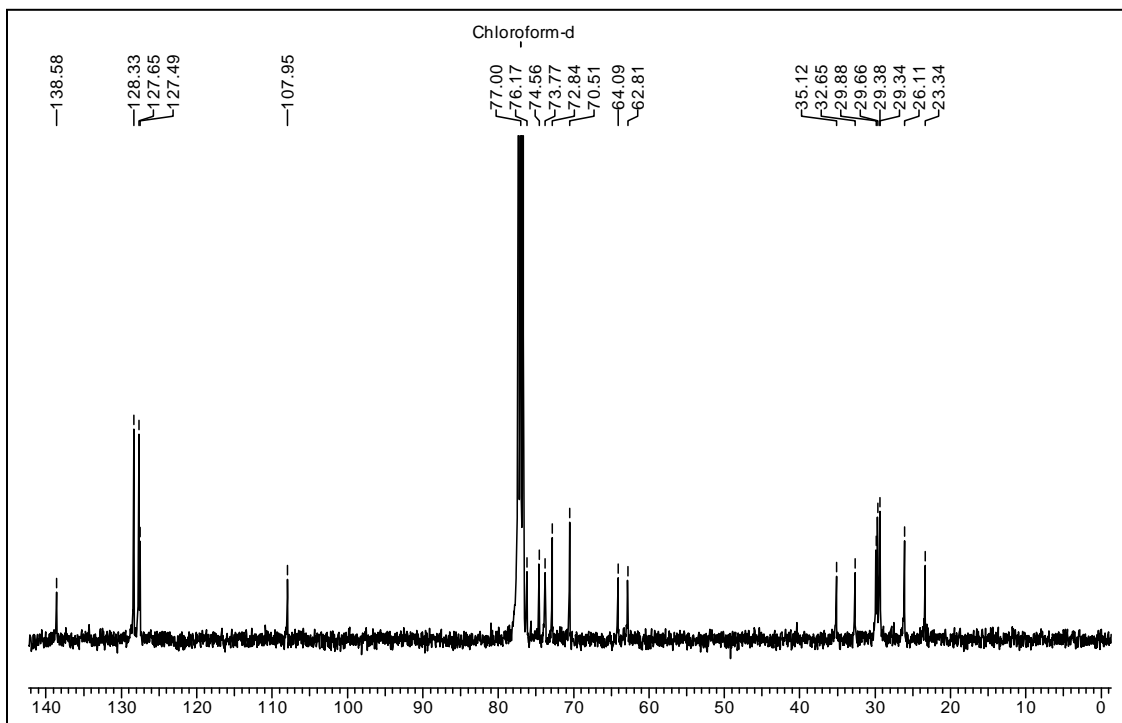
^{13}C NMR Spectrum of 40 in CDCl_3

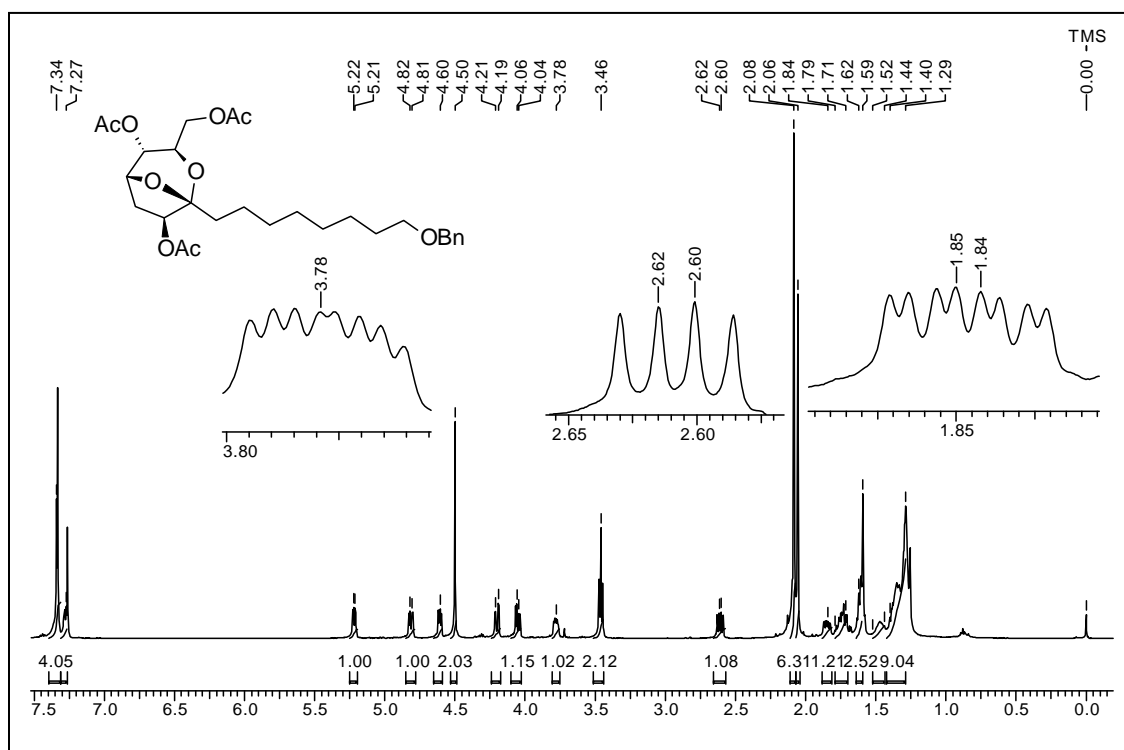
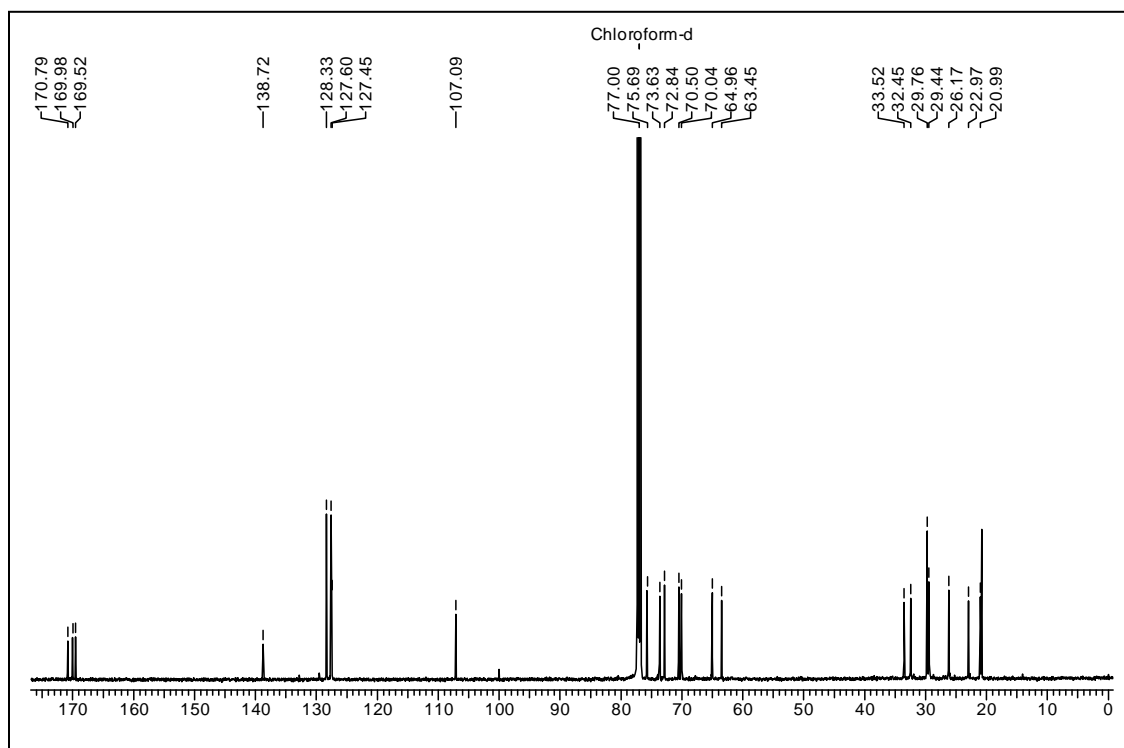
 **^1H NMR Spectrum of 41 in CDCl_3**  **^{13}C NMR Spectrum of 41 in CDCl_3**

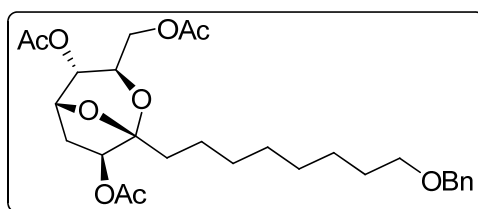
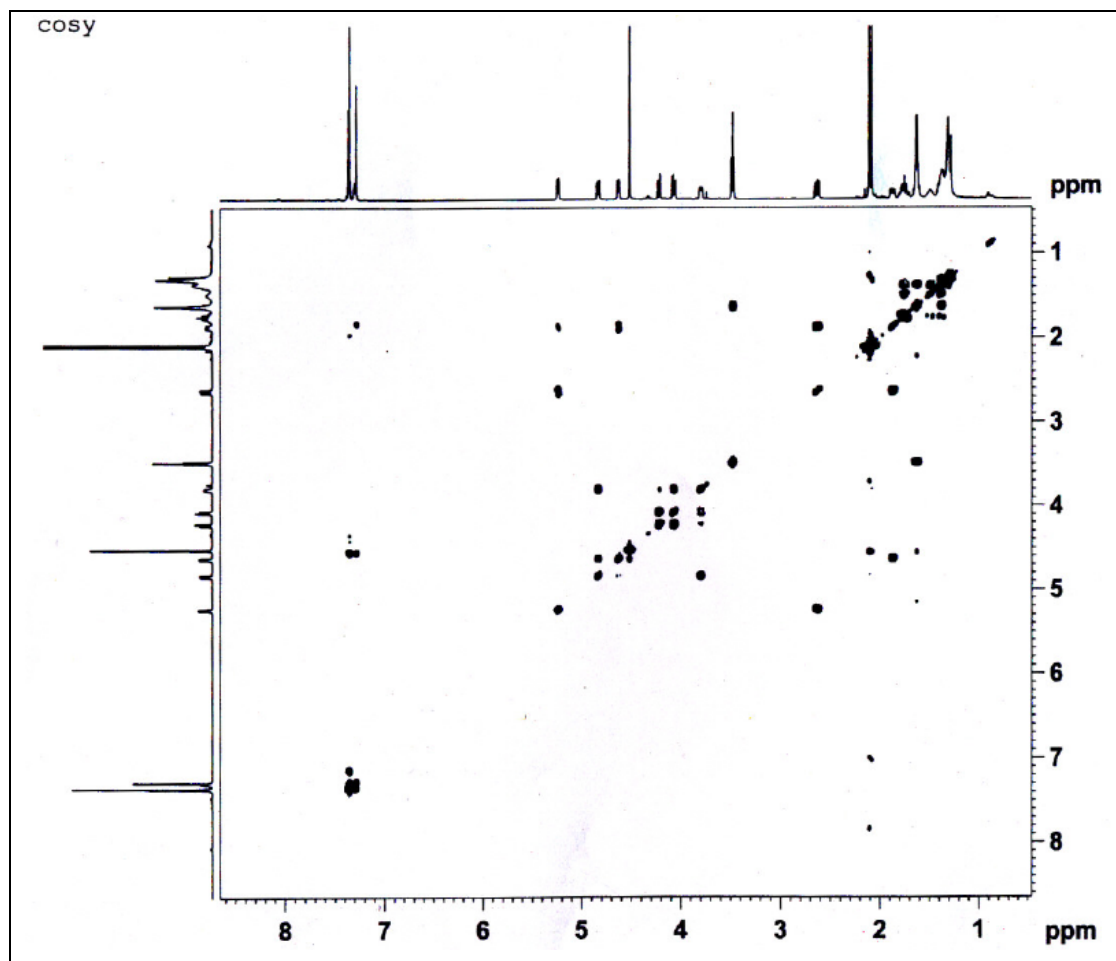
¹H NMR Spectrum of 42 in CDCl₃¹³C NMR Spectrum of 42 in CDCl₃

**¹H NMR Spectrum of 43 in CDCl₃****¹³C NMR Spectrum of 43 in CDCl₃**

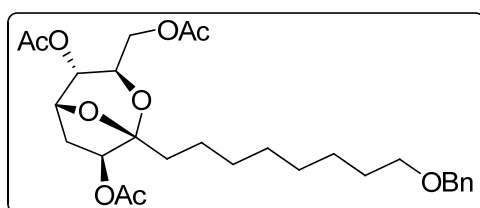
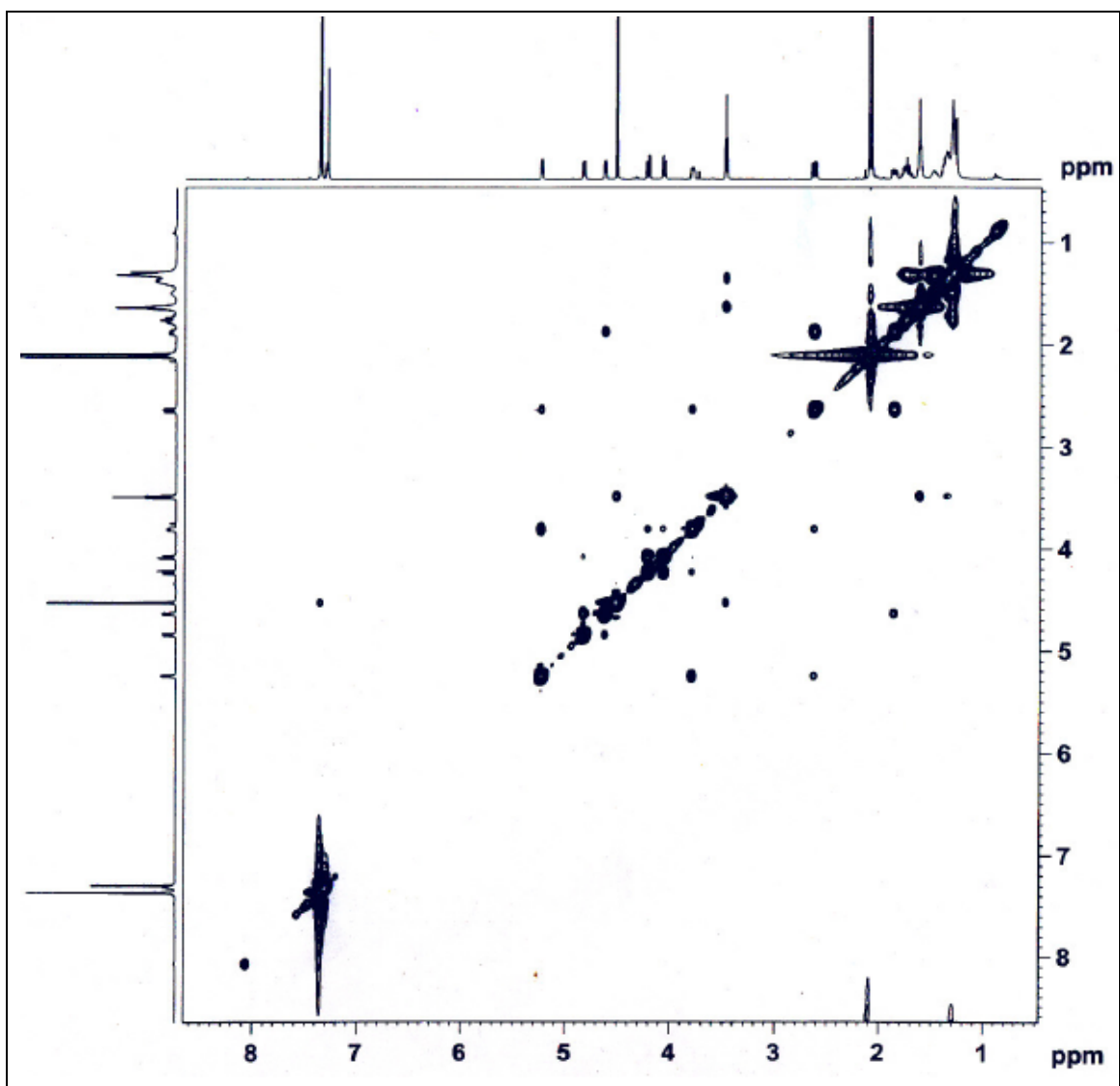
 ^1H NMR Spectrum of 44 in CDCl_3  ^{13}C NMR Spectrum of 44 in $\text{CDCl}_3+\text{DMSO}-d_6$

**¹H NMR Spectrum of 45 in CDCl₃****¹³C NMR Spectrum of 45 in CDCl₃**

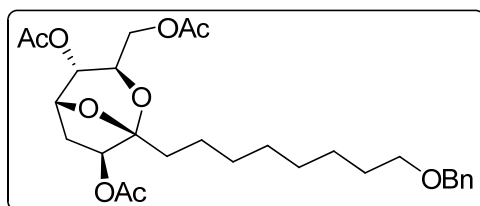
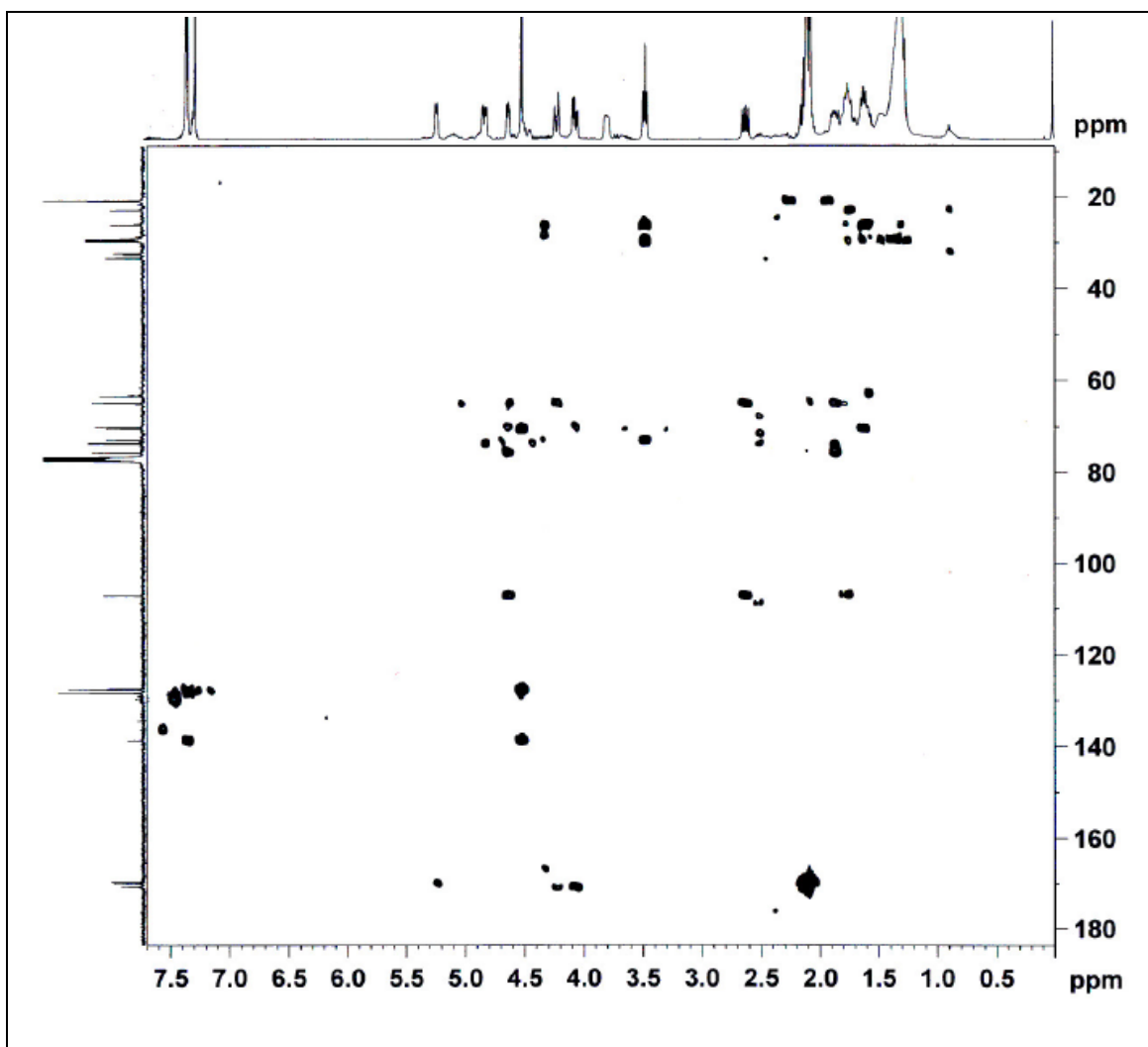
**¹H NMR Spectrum of 46 in CDCl₃****¹³C NMR Spectrum of 46 in CDCl₃**



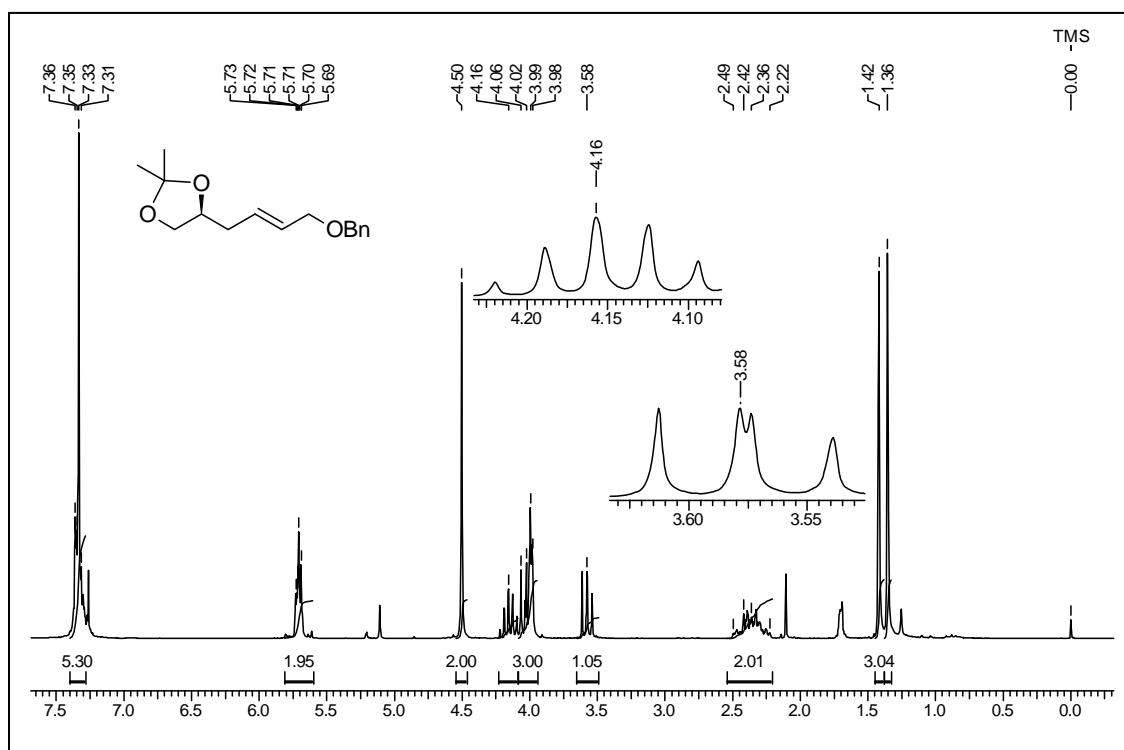
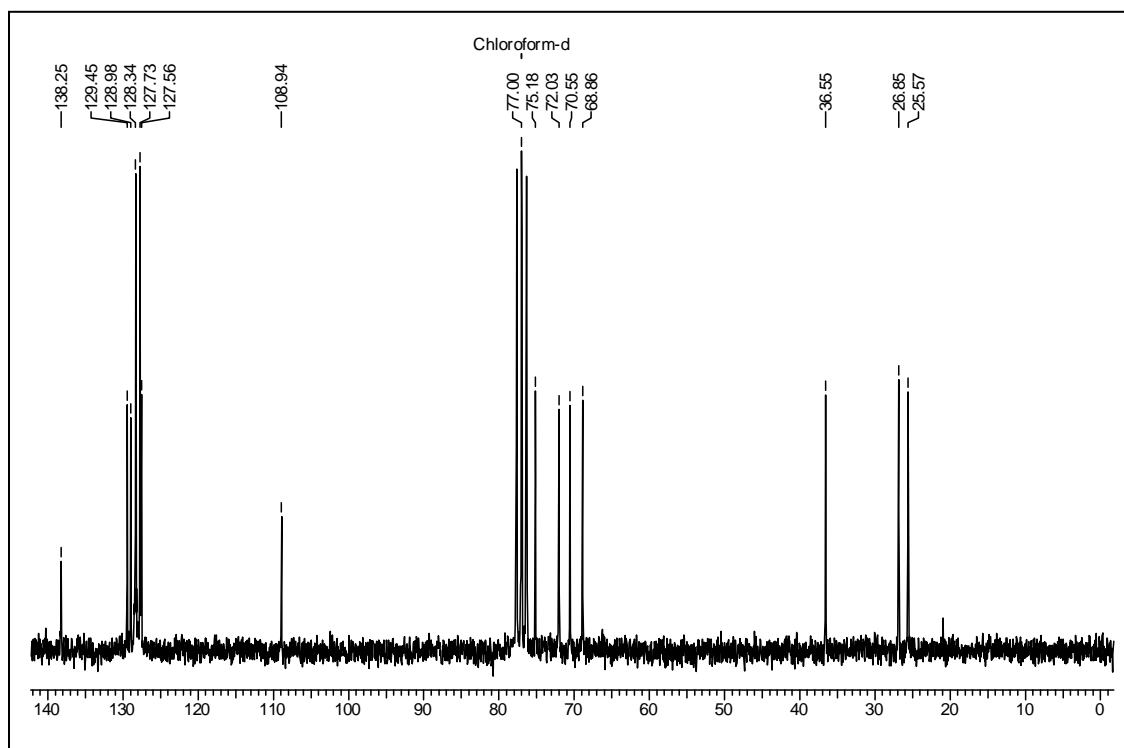
COSY Spectrum of Compound 46

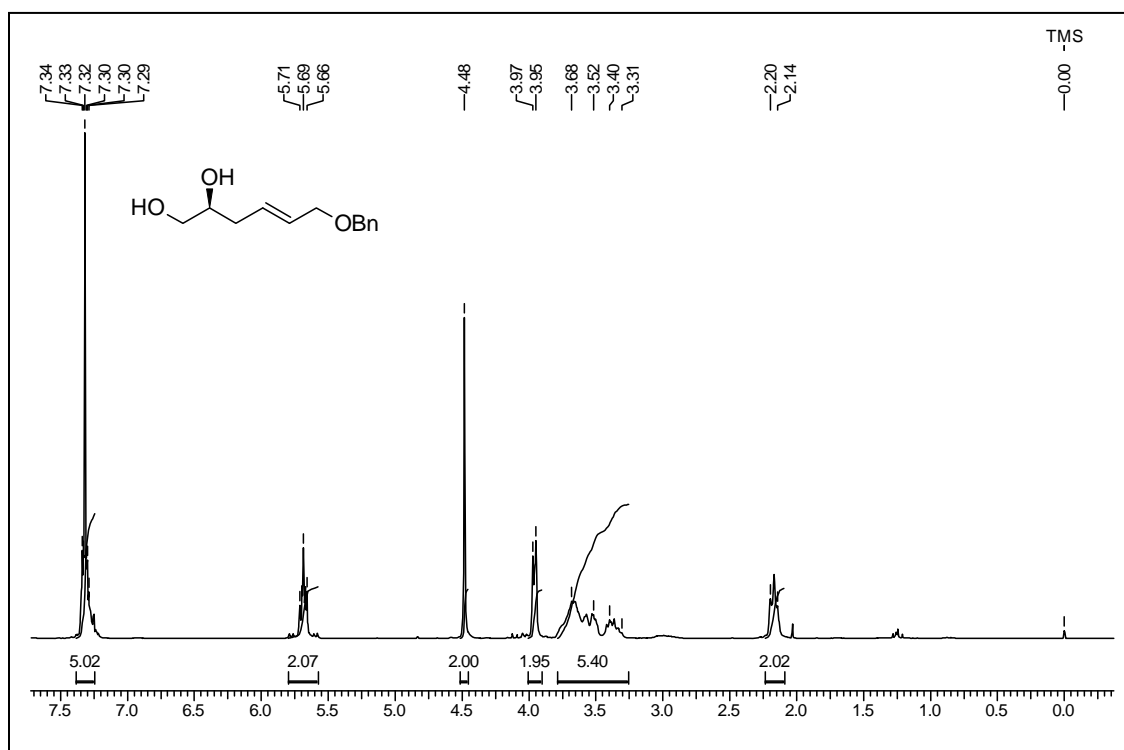


NOESY Spectrum of Compound 46

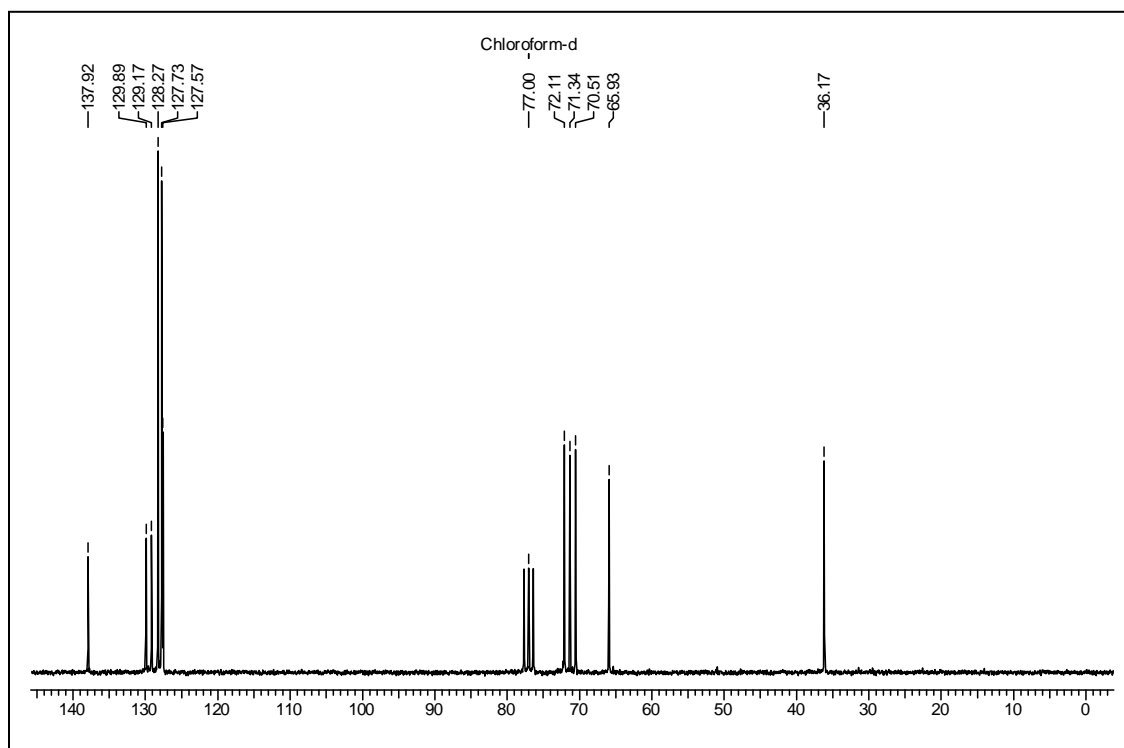


HMBC Spectrum of Compound 46

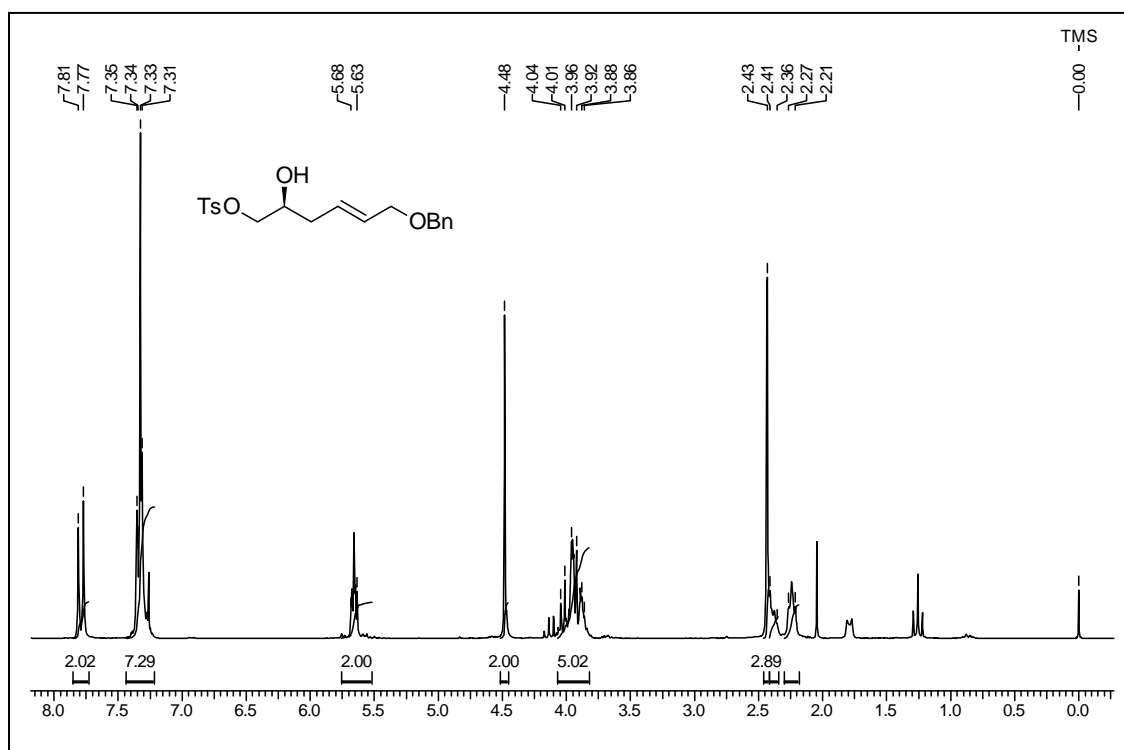
 ^1H NMR Spectrum of 51 in CDCl_3  ^{13}C NMR Spectrum of 51 in CDCl_3



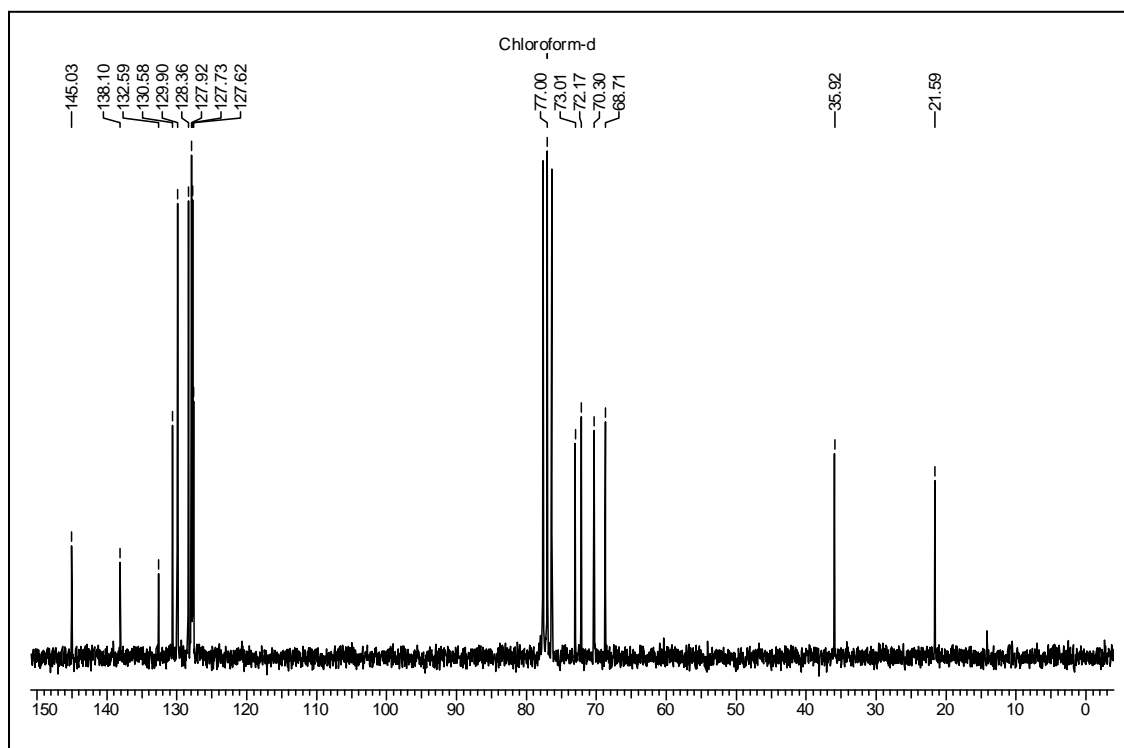
¹H NMR Spectrum of 56 in CDCl₃



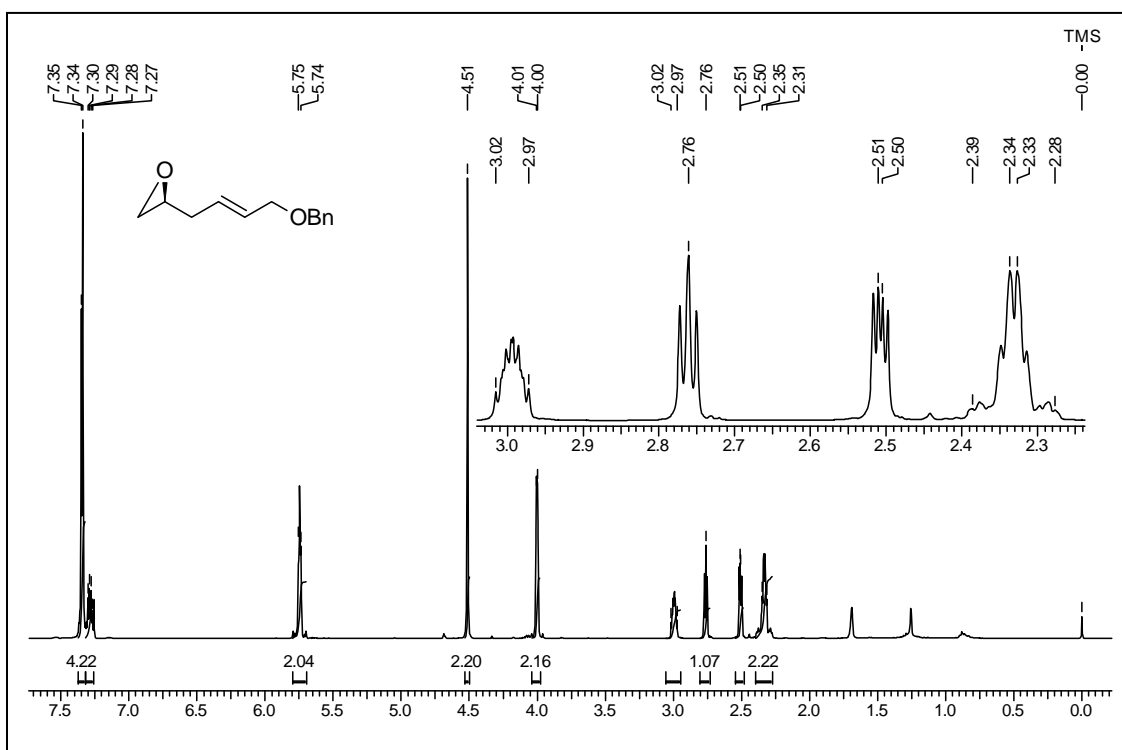
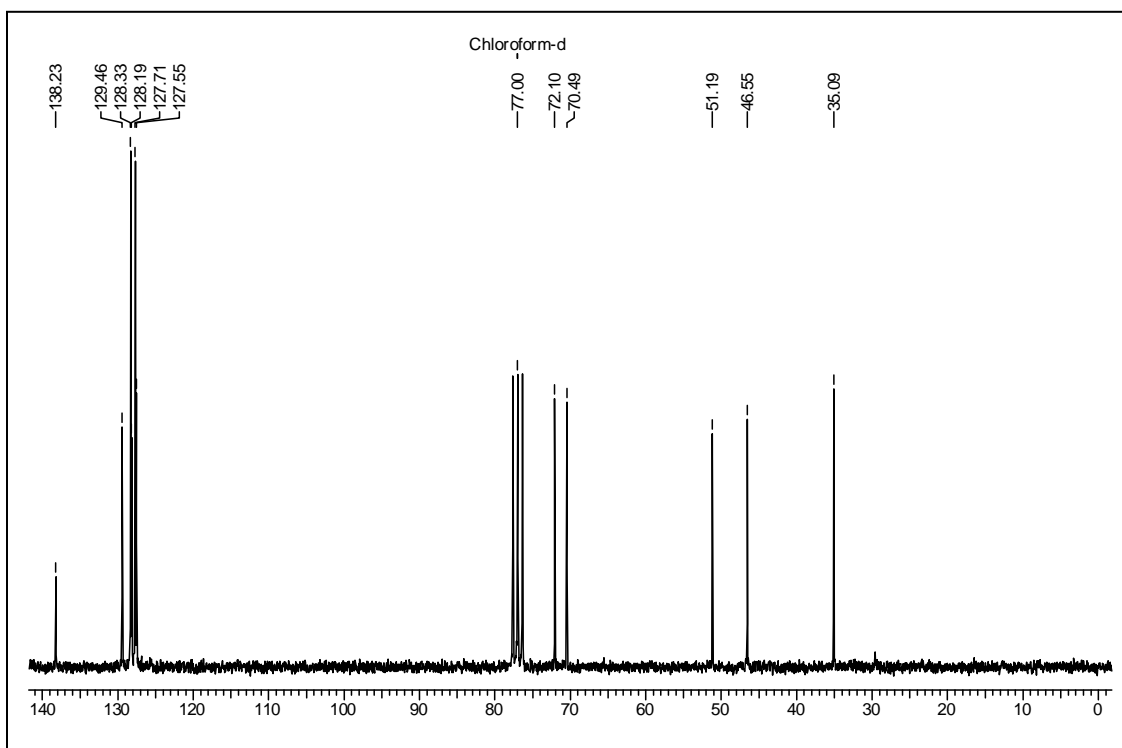
¹³C NMR Spectrum of 56 in CDCl₃

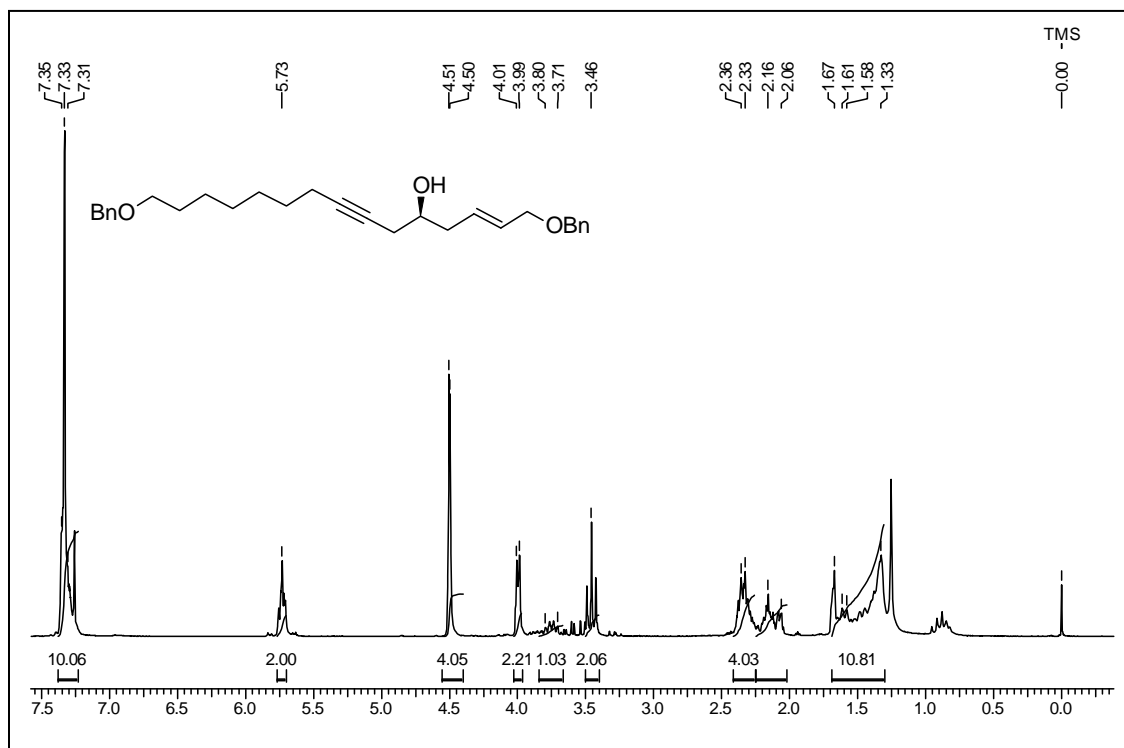


¹H NMR Spectrum of 57 in CDCl₃

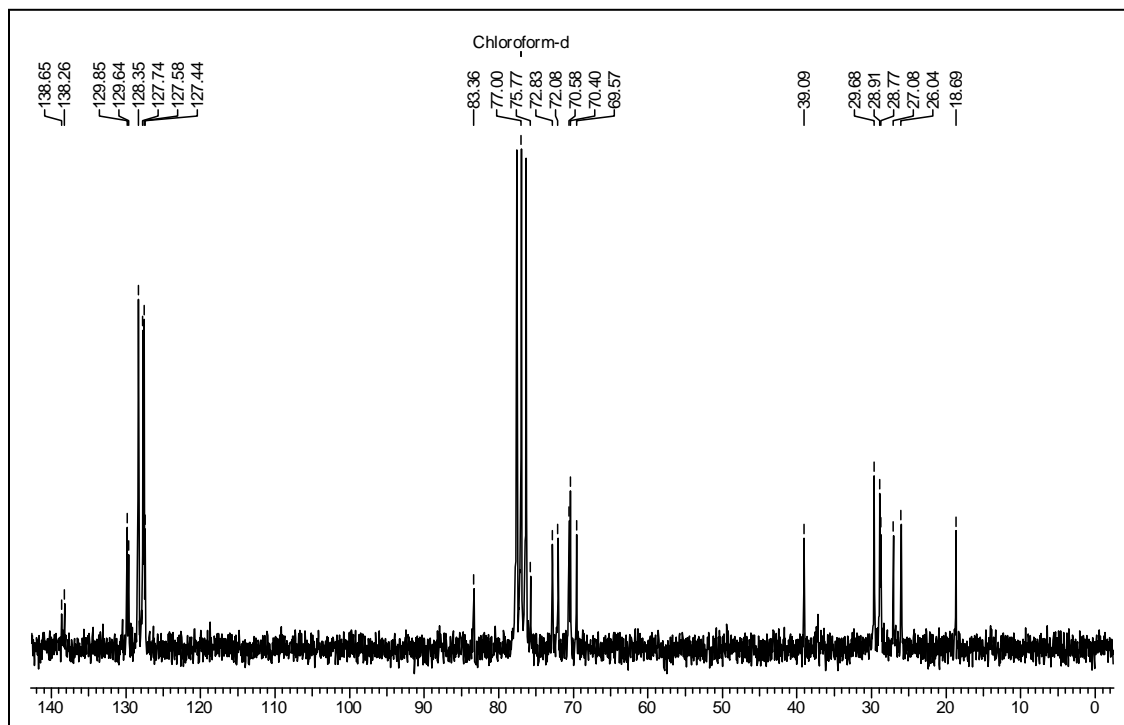


¹³C NMR Spectrum of 57 in CDCl₃

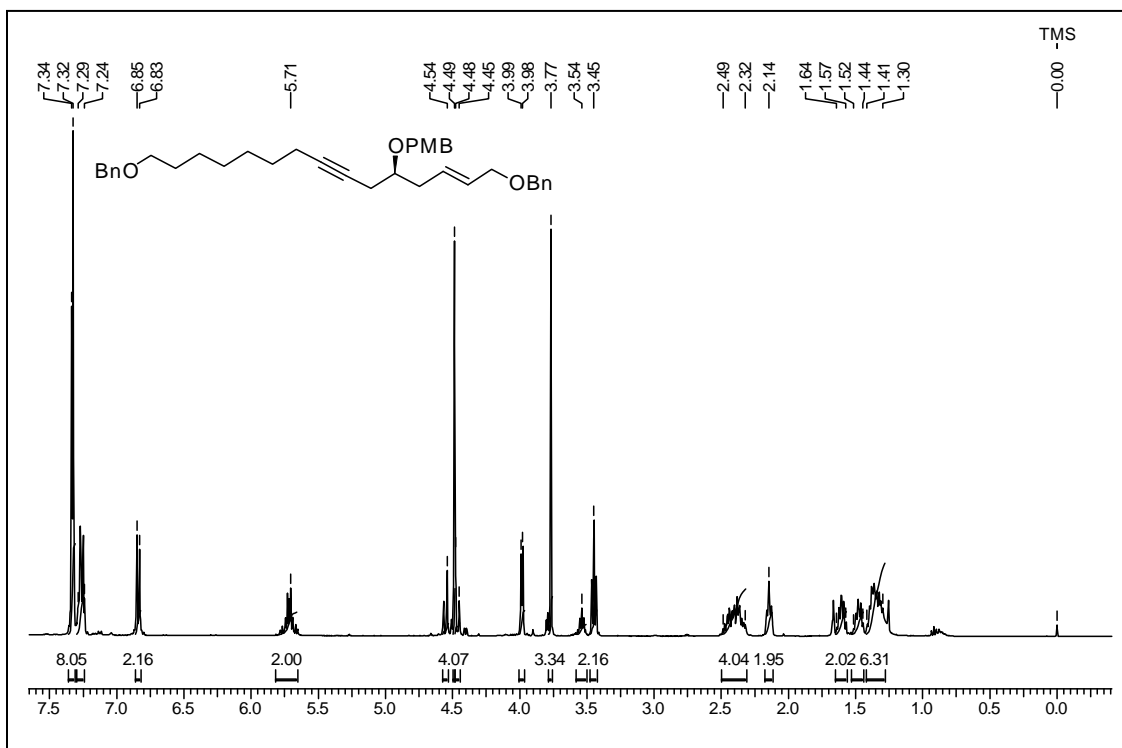
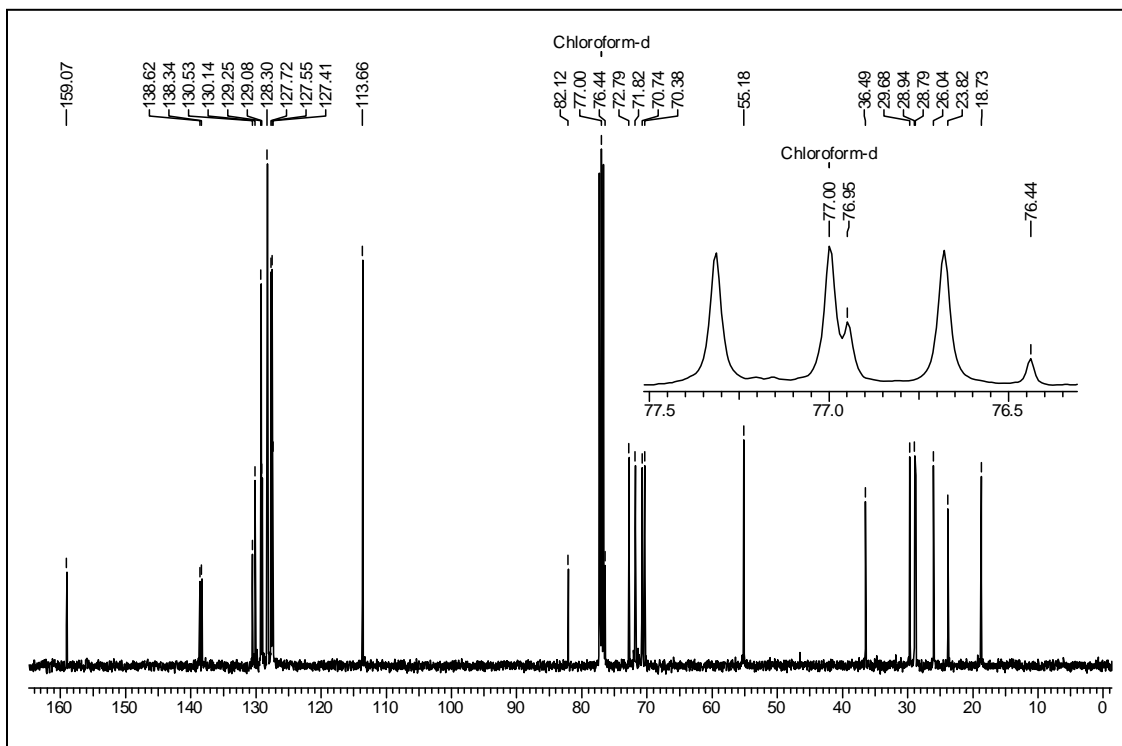
¹H NMR Spectrum of 50 in CDCl₃¹³C NMR Spectrum of 50 in CDCl₃

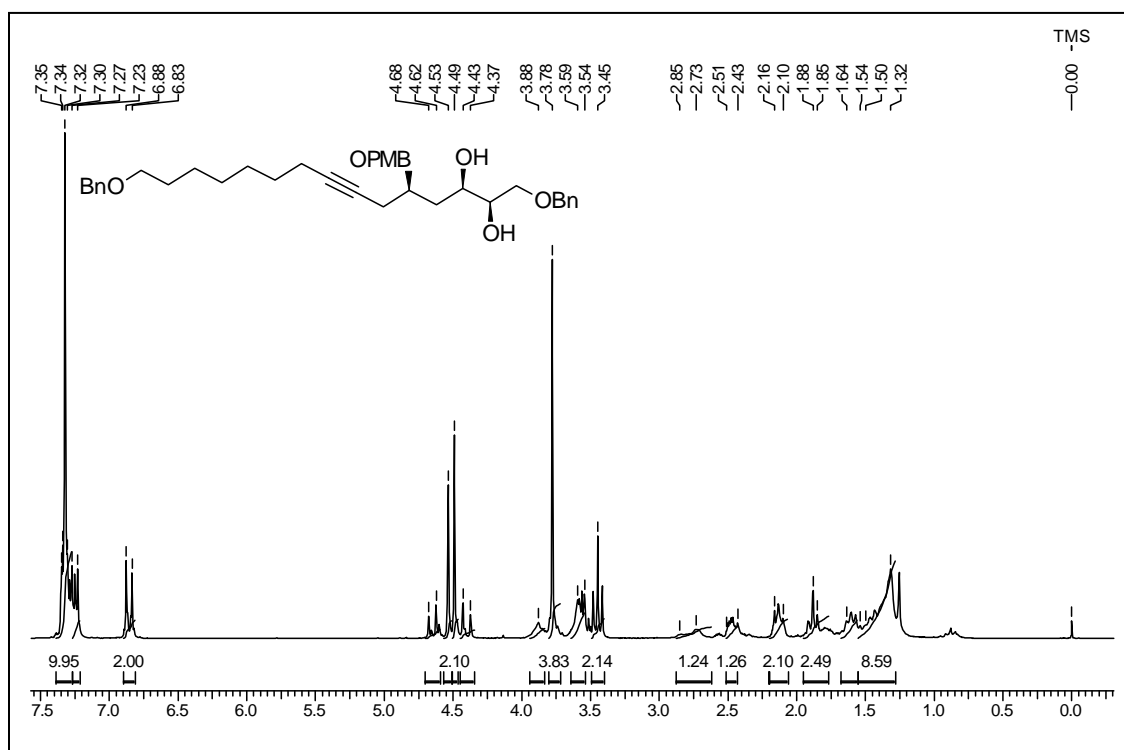
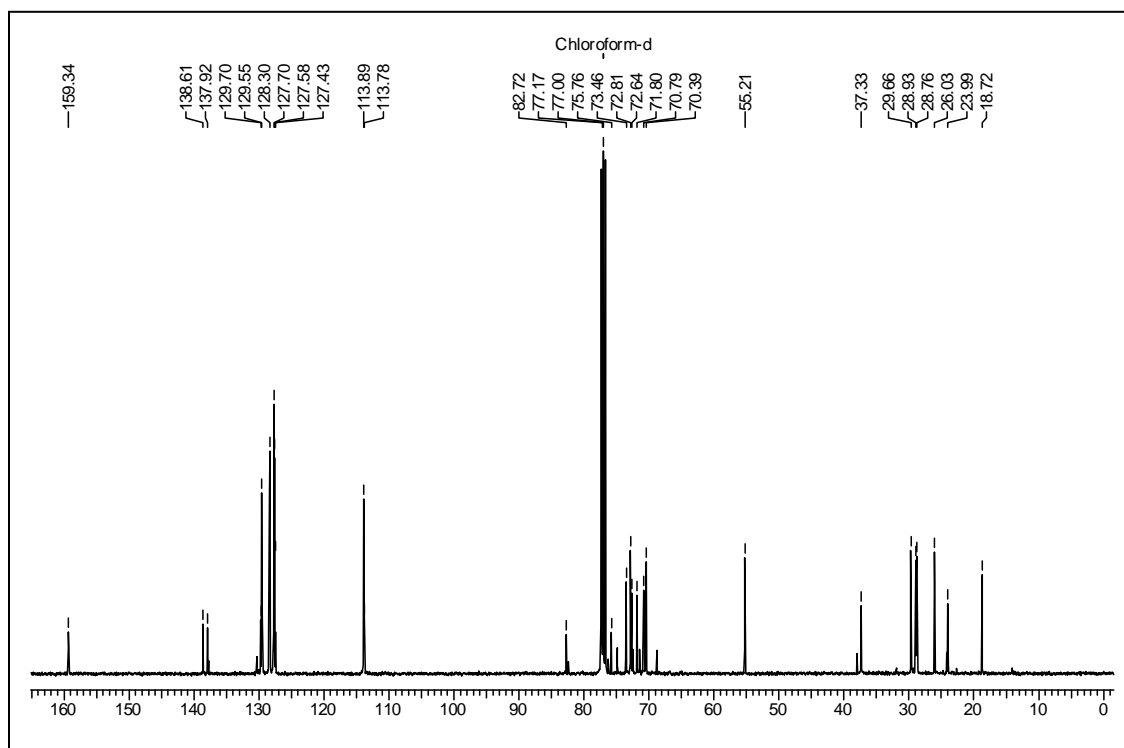


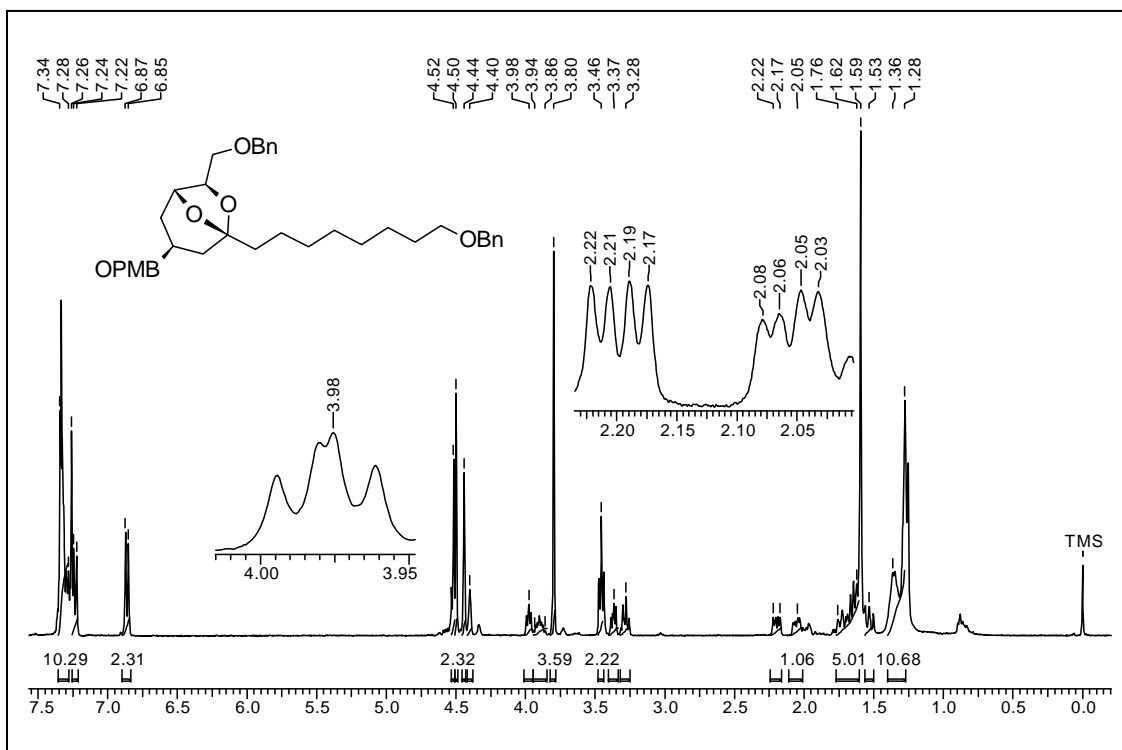
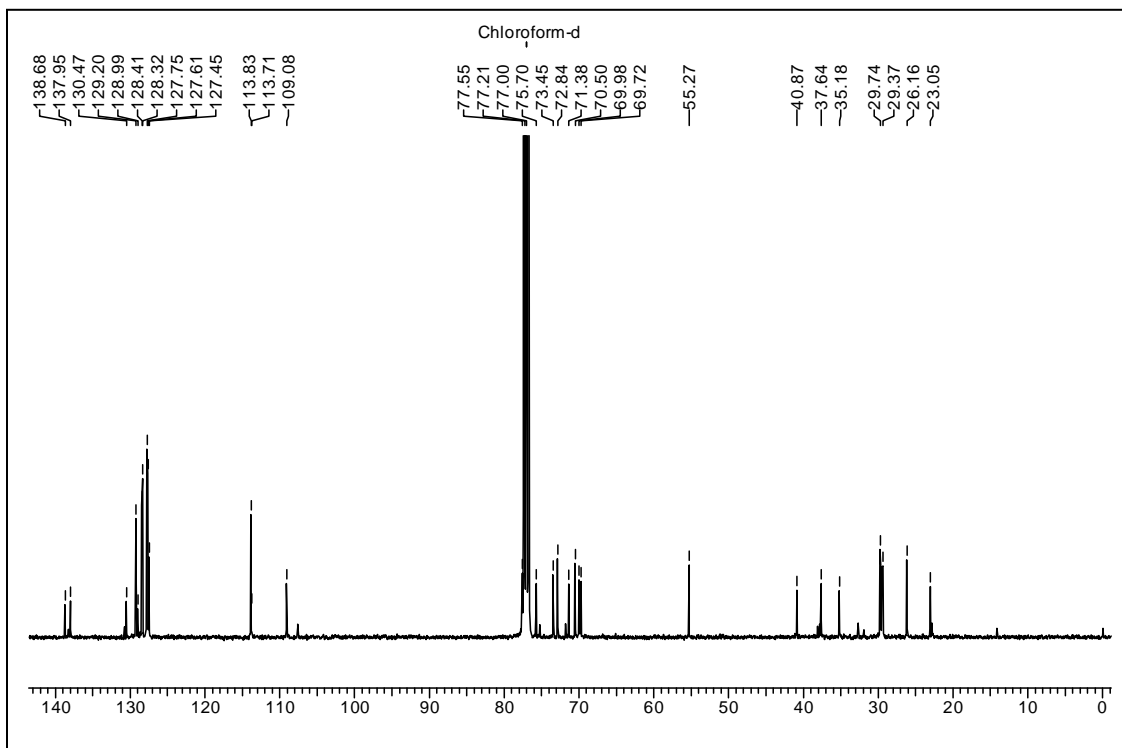
¹H NMR Spectrum of 58 in CDCl₃

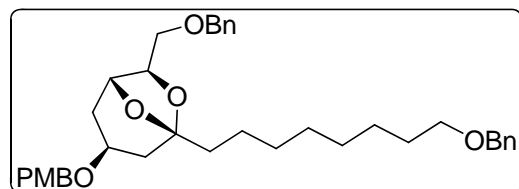
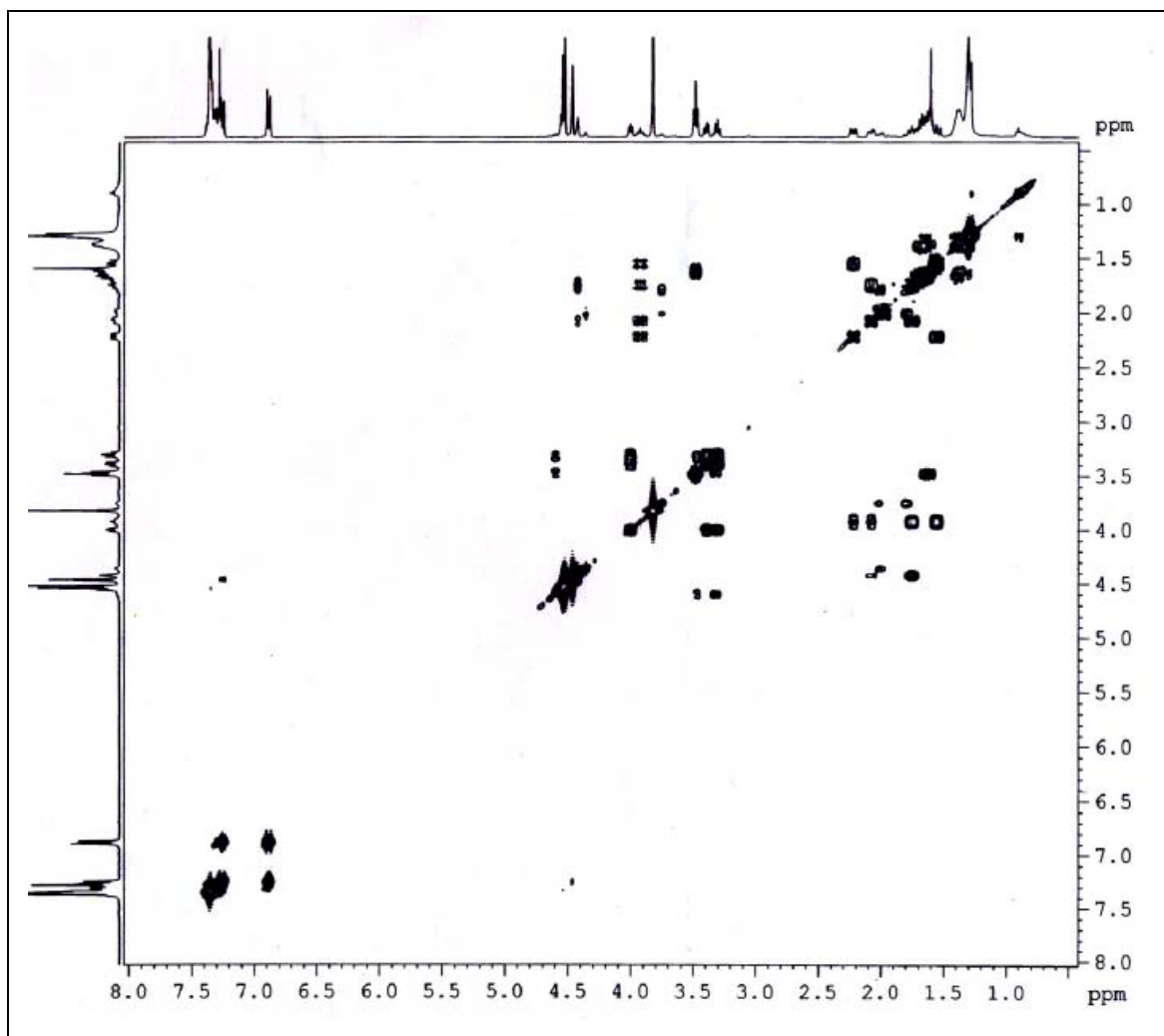


¹³C NMR Spectrum of 58 in CDCl₃

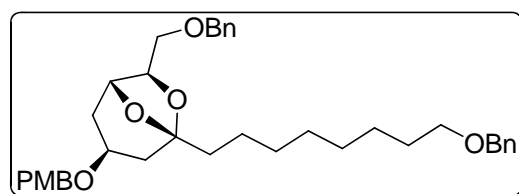
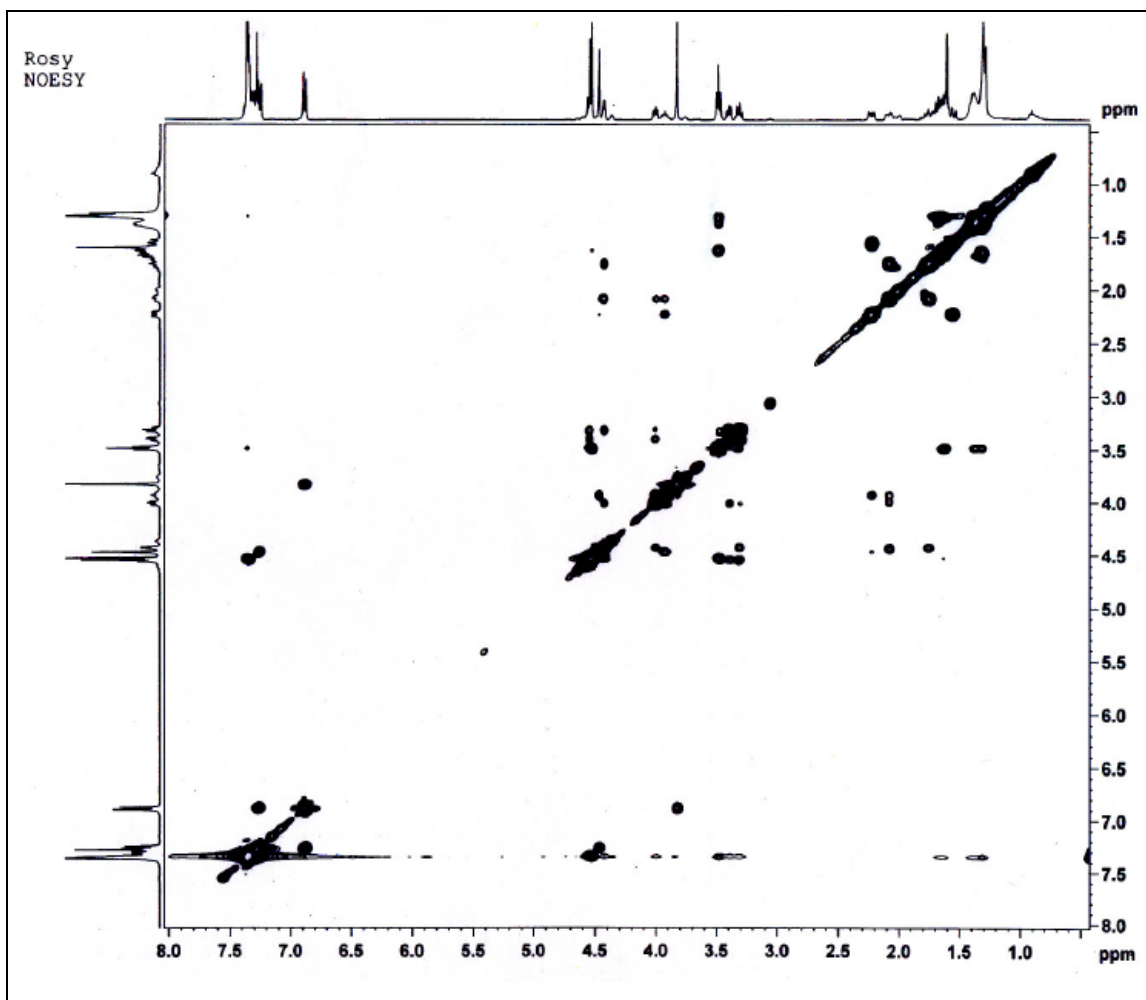
¹H NMR Spectrum of 49 in CDCl₃¹³C NMR Spectrum of 49 in CDCl₃

**¹H NMR Spectrum of 48 in CDCl₃****¹³C NMR Spectrum of 48 in CDCl₃**

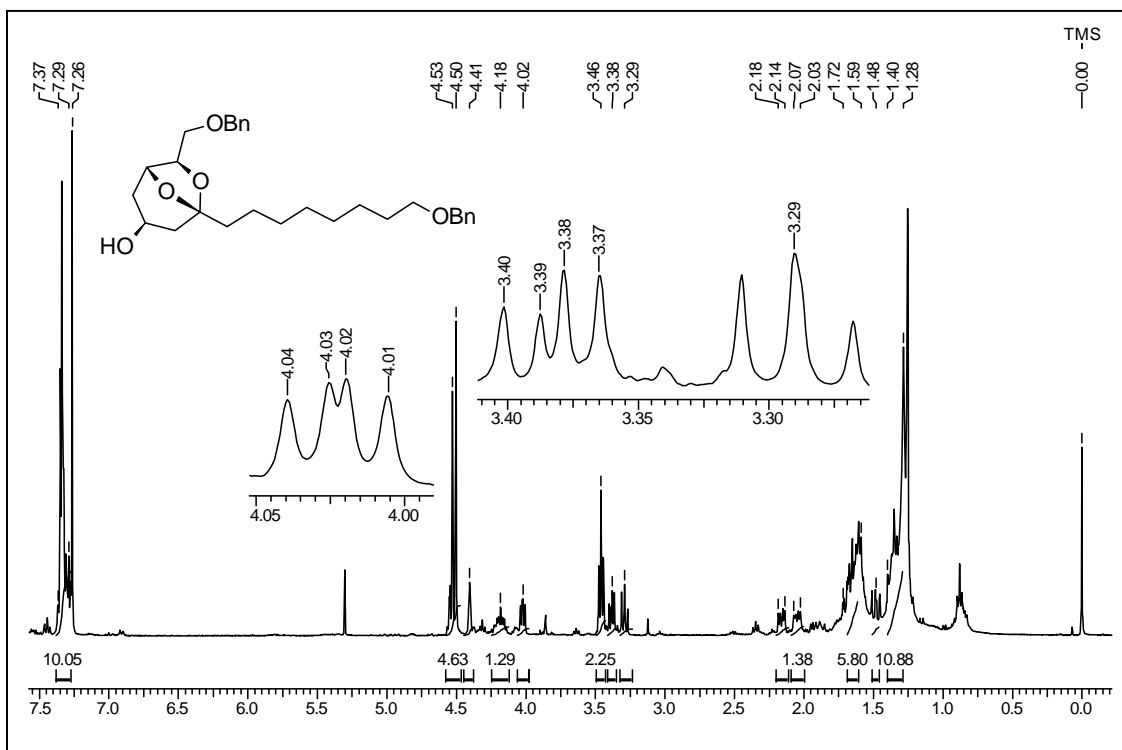
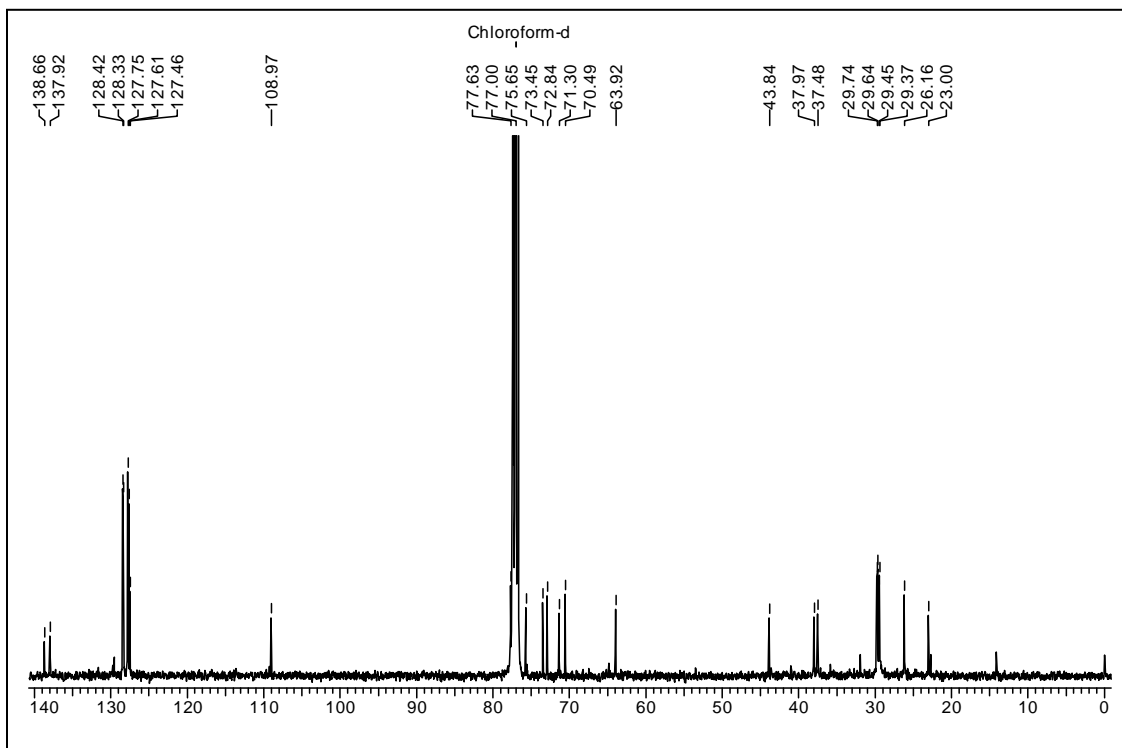
**¹H NMR Spectrum of 47 in CDCl₃****¹³C NMR Spectrum of 47 in CDCl₃**



COSY Spectrum of Compound 47



NOESY Spectrum of Compound 47

**¹H NMR Spectrum of 59 in CDCl₃****¹³C NMR Spectrum of 59 in CDCl₃**

2.5 REFERENCES

1. Wood, D. L. *Ann. Rev. Entomol.* **1982**, 27, 411.
2. Lin, S. J.; Jiang, S. H.; Li, Y. M.; Zeng, J. F.; Zhu, D. Y. *Tetrahedron Lett.* **2000**, 41, 1069.
3. (a) Mitchell, S. S.; Rhodes, D.; Bushman, F. D.; Faulkner, D. J. *Org. Lett.* **2000**, 2, 1605. (b) González, N.; Rodríguez, J.; Jiménez, C. *J. Org. Chem.* **1999**, 64, 5705.
4. Williams, P. G.; Asolkar, R. N.; Kondratyuk, T.; Pezzuto, J.M.; Jensen, P. R.; Fenical, W. *J. Nat. Prod.* **2007**, 70, 83.
5. (a) Kiyota, H.; Dixon, D. J.; Luscombe, C. K.; Hettstedt, S.; Ley, S. V. *Org. Lett.* **2002**, 4, 3223. (b) Marvin, C. C.; Voight, E. A.; Burke, S. D. *Org. Lett.* **2007**, 9, 5357.
6. Ramana, C.V., Induvadana, B. *Tetrahedron Lett.* **2009**, 50, 271.
7. (a) Vlahov, I.R.; Vlahova, P.I.; Schmidt, R.R., *Tetrahedron: Assymetry* **1993**, 4, 293. (b) Regeling, H.; Chittenden, G. J. F. *Recl. Trav. Chim. Pays-Bas* **1989**, 108, 330.
8. Bessodes, M.; Boukarim, C. *Synlett* **1996**, 1119.
9. (a) Ohira, S. *Synth. Commun.* **1989**, 19, 561. (b) Muller, S., Liepold, B., Roth, G. J.; Bestmann, H. J. *Synlett* **1996**, 521.
10. Gao, G.; Moore, D.; Xie, Ru-G.; Pu, L. *Org. Lett.* **2002**, 4, 4143.
11. (a) Mori, Y.; Kuhara, M.; Takeuchi, A.; Suzuki, M. *Tetrahedron Lett.* **1988**, 29, 5419. (b) Mori, Y.; Suzuki, M. *Tetrahedron Lett.* **1989**, 30, 4383.
12. Kolb, H. C.; Sharpless, K. B.; VanNieuwenhze, M. S. *Chem. Rev.* **1994**, 94, 2483.
13. Yamaguchi, M.; Hirao, I. *Tetrahedron Lett.* **1983**, 24, 391.

Chapter III:

A [2+2+2] Alkyne Trimerization Approach For Synthesis of Some Carbapenems

3.1 INTRODUCTION

The serendipitous discovery of penicillin by Fleming in 1928 was a great break through in the history of antibiotics, which brought solace to both patients suffering from bacterial infections and doctors alike and began the modern era of antibiotic discovery. Since then, some new classes of antibiotics have been found from natural sources, such as cephalosporins, cephamycins, monobactams and carbapenems. On the other hand, different kinds of synthetic antibiotics such as carbacephems, oxacephems and penems, have been developed in the last three decades.¹ From structural point of view, these classes are broadly divided as penams, penems and cephams (Figure 1); although all of them come under a broader genre called β -lactam antibiotics as these compounds contain a central 4-membered β -lactam ring.

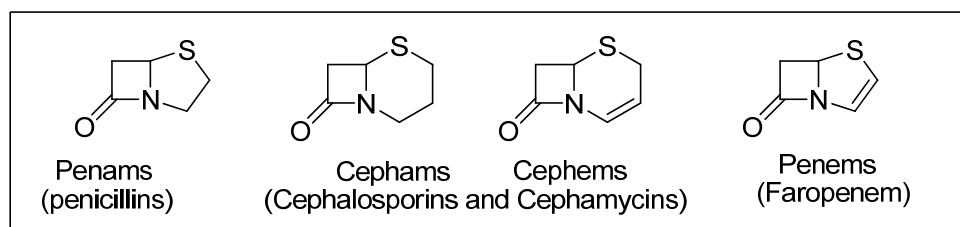


Figure 1

Till quite recently penicillins and cephalosporins were the commonly used β -lactam antibiotics. Extensive use of these antibiotics in medicine has resulted in an increasing number of resistance strains of bacteria, which has become a serious problem in clinical practice. The activity of any antibacterial compound depends upon how effectively it penetrates into the bacterial cell wall.

Cell wall structure of bacteria:

Bacteria are divided into two categories namely Gram-positive and Gram-negative bacteria, depending upon their cell wall structure.²

A relatively simple cell wall (A) of Gram positive bacteria allows lipophilic molecules to penetrate the cytoplasmic membrane. Gram negative organisms have complex 5-layer cell wall (B) which makes penetration of large antibiotic molecules rather difficult (Figure 2). But the porin channels present in the lipid bilayer outer membrane allow polar compounds to pass through. To generalize, lipophilicity of a

molecule makes it active against Gram positive organisms whereas hydrophilicity of a molecule enhances activity against Gram negative organisms.

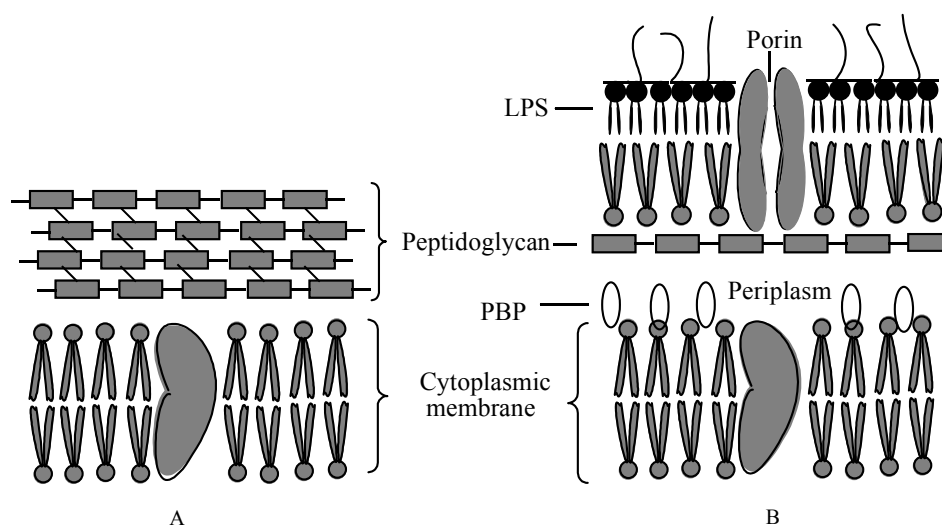


Figure 2: Cell wall structure of Gram-positive and Gram-negative bacteria

Penicillins inhibit bacterial growth by interfering with the synthesis of bacterial cell wall after binding to Penicillin binding proteins (PBPs) which are present in periplasmic space and involved in cell wall biosynthesis. Though β -lactam antibiotics have a wide range of antibacterial activity for both Gram-positive and Gram-negative bacteria, the appearance of resistant strains has become the matter of much concern in recent years. Resistance has occurred because of impaired entry into bacteria, instability to bacterial serine- or metallo- β -lactamases or inability to saturate penicillin-binding proteins (PBPs).³ The most important mechanism of bacterial resistance to penicillin is enzymatic hydrolysis of the β -lactam bond by β -lactamases, which is the most common resistance process in Gram-negative bacilli.⁴ Cephalosporins work in the same way as penicillins but are inactive against enterococci and *P. aeruginosa*. Hence the need to look beyond penicillins and cephalosporins and search for new classes of antibiotic agents arose. This led to the isolation of thienamycin (**1a**) by Merck⁵ and thus emerged Carbapenem, a new generation of antibiotics.

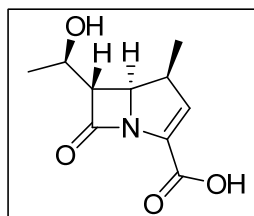


Figure 3: General structure of carbapenem

Development of Carbapenems antibiotics:

Carbapenems were found to be exceptionally broad-spectrum agents. Unfortunately, thienamycin proved to be chemically unstable due to β -lactam ring cleavage of one molecule by the primary amine in the 2' side chain of another. This led to the development of imipenem (**1b**) bearing more basic amidine function, which protonates at physiological pH. But it was found to be unstable to renal dehydropeptidase-I (DHP-I), a β -lactamase. Hence an additional compound, cilastatin^{1c} has been co-administrated with imipenem to prevent hydrolysis by (DHP-I). Though imipenem/cilastatin is an excellent broad-spectrum agent, its potential is limited due to toxicity. Also it lacks activity against methicillin-resistant *Staphylococcus aureus* (MRSA) and *P.aeruginosa*. Sankyo group in Japan marketed Panipenem⁶ (**1c**) which also needs to be co-administrated with an additive Betamipron to reduce nephrotoxicity. The introduction of 1- β -methyl substituent into the structure of Meropenem⁷ (**1d**) enhanced its stability to human renal DHP-I. This is chemically less prone to hydrolysis by DHP-I and thus marketed as a single product. Though it is little less potent than imipenem against Gram-positive aerobes, it is more active against Gram-negative aerobes (i.e.-*P.aeruginosa*) as well as anaerobes. It is tolerable at higher doses and can be used for serious infections. Like Imipenem, Meropenem is also inactive against methicillin-resistant *Staphylococci*. As the activity against Gram-positive organisms favored by more lipophilic molecule, L-786392 (**1g**) is active in vitro against Gram-positive aerobes including MRSA and enterococci,⁸ but it has reduced activity against enterobacteriaceae and it lacks anti-pseudomonal activity. Biapenem (**1e**) is a case of hydrophilic molecule in which the 2' side chain is permanently charged. Biapenem and Doripenem (**1f**) have typical carbapenem pharmacokinetics and are broad spectrum and tested against resistant strains of *P.aeruginosa* and have recently made their entry into market. Most of the above cited compounds are for parenteral use (injectable).

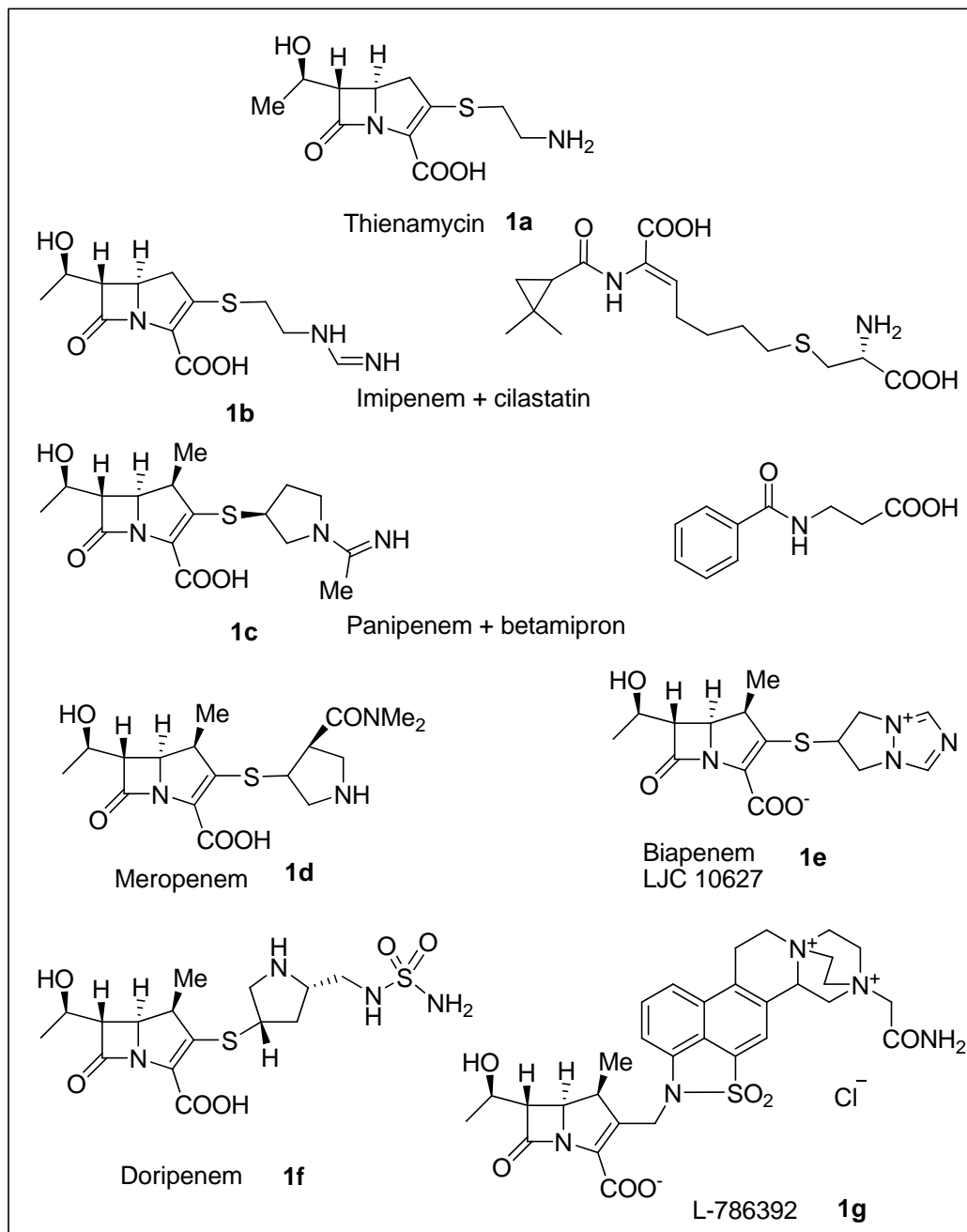


Figure 4

Oral carbapenems:

Due to their instability in gastric juice and even in neutral conditions, the development process of carbapenems as orally administrable drugs is fairly slow. Also β -lactam antibiotics are known to be difficult to absorb from the intestine. Recently, several orally active carbapenems without stability problems have been developed as prodrug

esters or prodrug peptides (Figure 5). Faropenem (**2b**) is a novel class of oral penem (not a carbapenem) which is more active than other β -lactam antibiotics.⁹

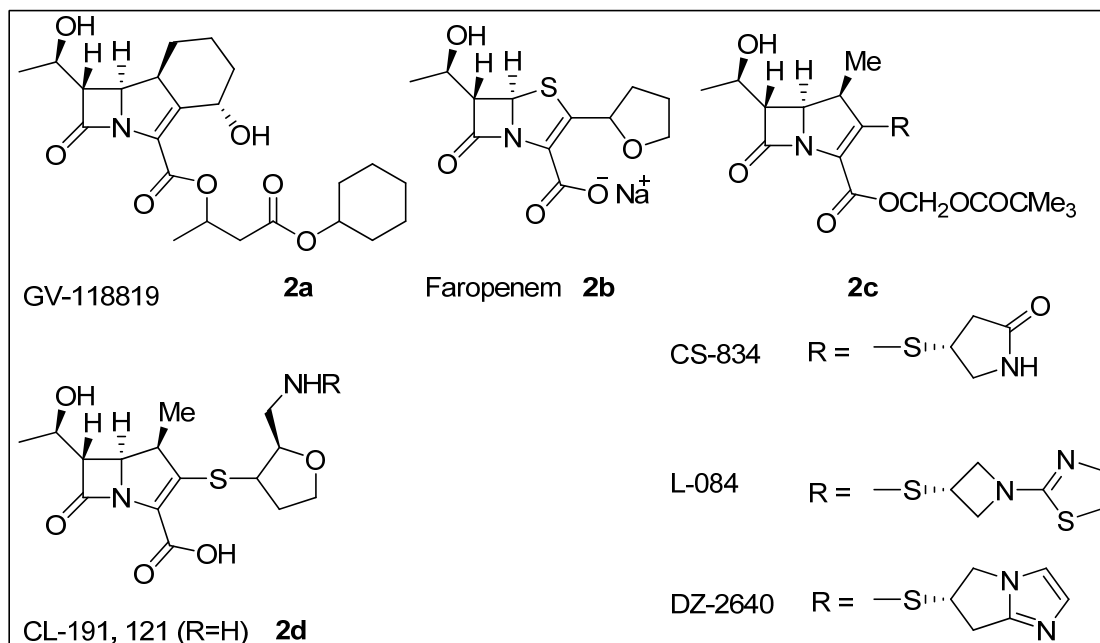


Figure 5: Some classes of oral penems.

Tricyclic β -lactam (Trinem):

Tricyclic β -lactam antibiotics, referred as trinems are a new class of synthetic antibacterial agents with the general structure of a 4/5/6 fused tricyclic system as shown in figure 6.

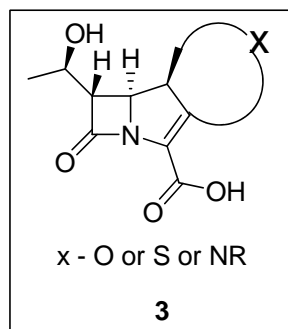


Figure 6: General structure of trinems

This is a novel class of synthetic antibiotic having good resistance to betalactamases and dehydropeptidases which was first reported by the Glaxo Wellcome group. Sanfetrinem (GV-104326) and Sanfetrinem cilexetil (GV-118819) (**2a**) developed by the same group were until recently undergoing phase-II clinical trials as oral trinems.¹⁰

Apart from these two, some other tricyclic carbapenems and their analogs have been developed and patented by various research groups. Trinems **4a** and **4b** were patented by Lek¹¹, **4c** by Hoffmann-La Roche¹², and **4d** by Merck.¹³

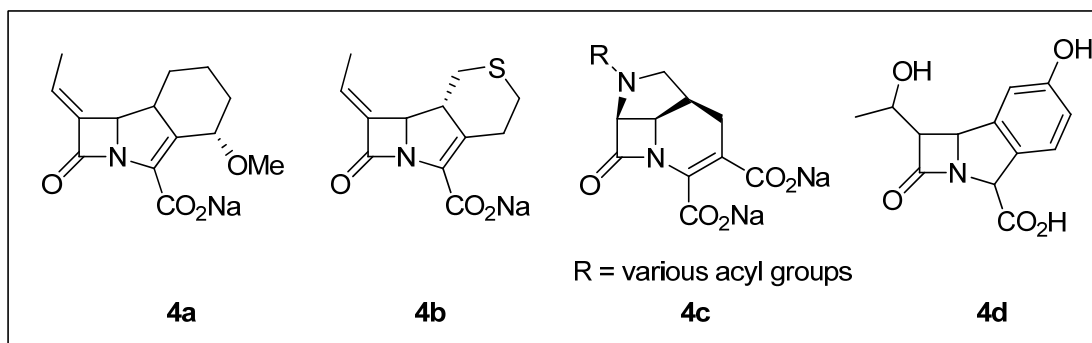


Figure 7: some tricyclic β -lactams

Chemically, a potential antibiotic must meet two essential requirements, namely: (a) enzyme-substrate interactions should facilitate the incorporation of the antibiotic, in an appropriate orientation, to the active site of the enzyme; and (b) the antibiotic should exhibit appropriate chemical reactivity. From the model studies of enzyme-substrate interactions, it has been found that the incorporation of a third fused ring to carbapenem introduces some interesting differences in chemical reactivity.

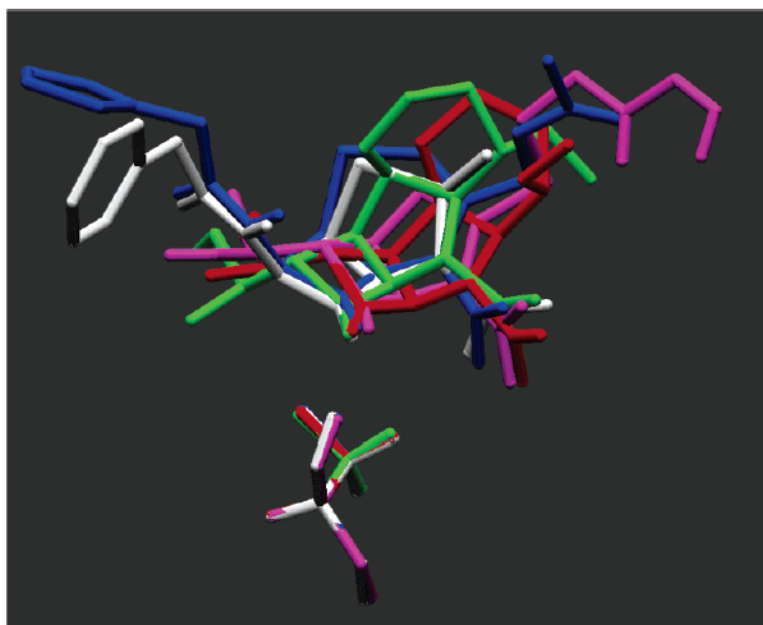


Figure 8. Superposition of active sites in the P99 complexes with imipenem (violet), cephalothin (blue), penicillin G (white), sanfetrinem (green), and 4β -methoxy trinem (red).

Also, if an appropriate substituent is incorporated, the reaction mechanism is very similar to that for cephalosporins, which can be related to an interesting antimicrobial spectrum. The results from molecular modeling studies¹⁴ reveal that subtle differences between the β -lactamases result in substantial differences with regards to the recognition of various substrates at the active site. Therefore to obtain accurate predictions of the antibiotic potential of new compounds, it is important to establish theoretical patterns. For sanfetrinem and its derivatives, the results depend on the particular enzyme. Thus, it behaves similarly to penicillin G toward class A β -lactamases (*Staphylococcus aureus* PC), and to cephalothin and imipenem toward class C β -lactamases (*Enterobacter cloacae* P99).

Reported methods for the synthesis of tricyclic carbapenems:

GV-118819 is the first tricyclic carbapenem developed by Glaxo Wellcome group as a prodrug ester.¹⁵

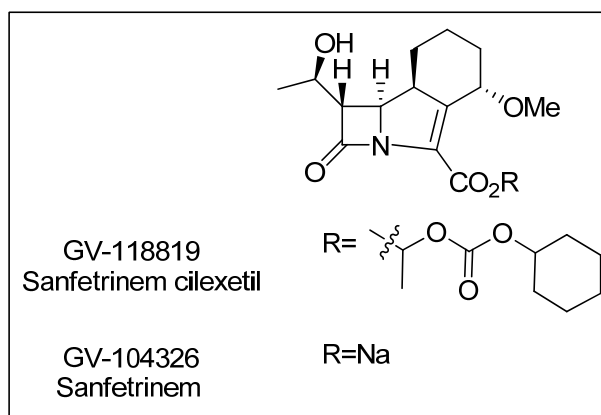
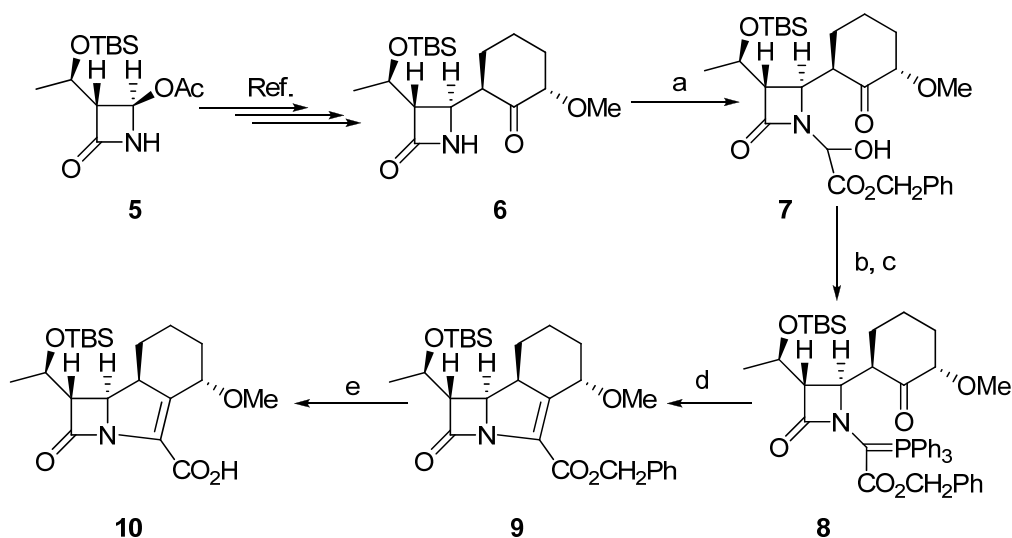


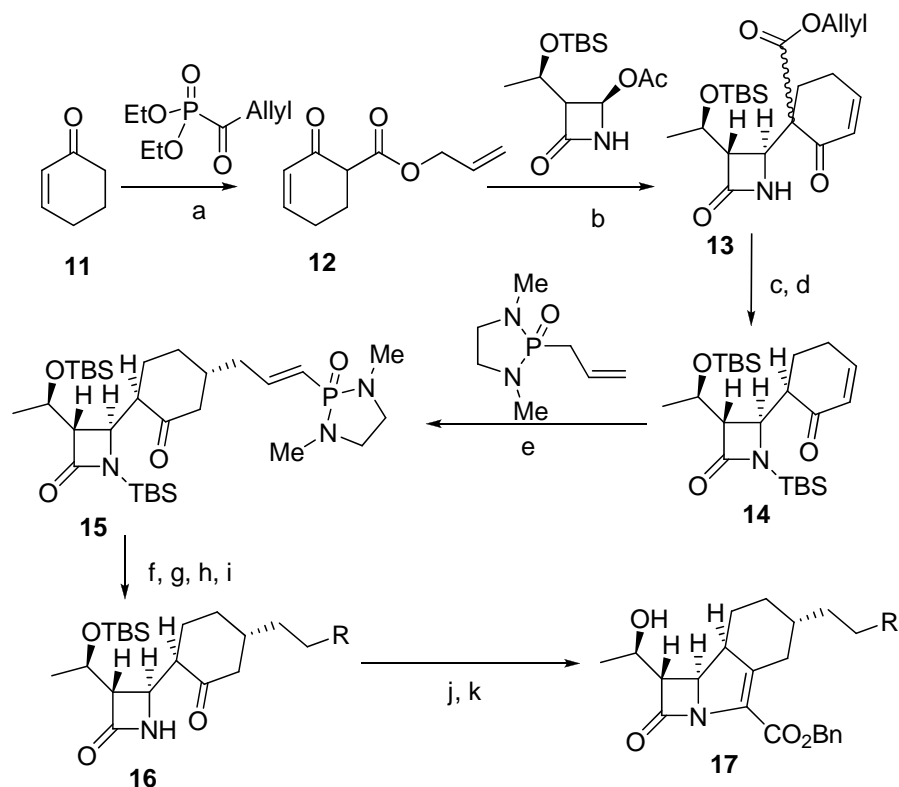
Figure 9

They started the synthesis from acetoxyazetidin-2-one **5** and achieved the racemic key intermediate **6** by reacting with 6-methoxy-1-trimethylsilyloxycyclohexene^{16a} and again stereoselectively by using 1-(trimethylsilyloxy)cyclohexene in presence of ZnCl_2 or SnCl_4 .^{16b}



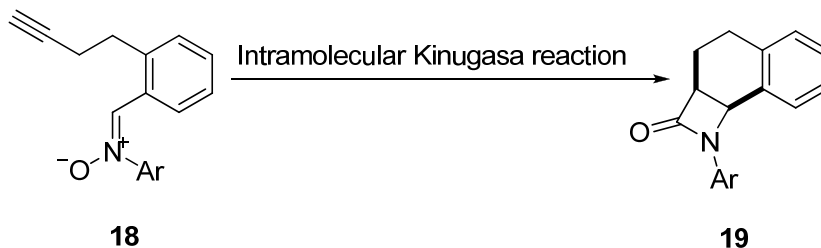
Scheme 1: Reagents and conditions: a) $\text{HCOCO}_2\text{CH}_2\text{Ph}$, C_6H_6 , reflux; b) SOCl_2 , 2,6-lutidine, THF; c) PPh_3 , 2,6-lutidine, THF; d) PhMe, reflux; e) H_2 , Pd/C, $t\text{PrOH}$, EtOAc.

In 1997 Hanessian *et al.* reported synthesis of 4 α - and 5 α -methoxy trinems and their structural variants.¹⁷



Scheme 2: Reagents and conditions: a) LDA, THF, allyl diethylphosphonofornate -78 °C; b) NaH, THF, **10**, -20 °C; c) TBSOTf, TEA, DCM, 0 °C; d) $\text{Pd}(\text{OAc})_2$, PPh_3 , formic acid, EtOAc; e) 2-allyl-1,3-dimethyl-[1,3,2]-diazaphospholidine, *n*-BuLi, THF, -78 °C; f) O_3 , DCM, DMS, -78 °C; g) 9-BBN, THF, rt; h) TBSCl, Imidazole, DMF, rt; i) TBAF, AcOH, THF, rt; j) $\text{BnOCOCOC}_2\text{Cl}$, Pyridine, DCM, 0 °C; k) $\text{P}(\text{OEt})_3$, *o*-xylene, 140 °C.

Ryo Shintani and G. C. Fu reported a ligand based intramolecular Kinugasa reaction¹⁸ of alkyne-nitrone to form tricyclic β -lactam framework.¹⁹ Among the various catalysts used, they found **B** to be more effective one.



Scheme 3: Reagents and conditions: CuBr (5%), Ligand (5.5%), (C₆H₁₁)₂NMe (0.5 eqv) MeCN, 0 °C

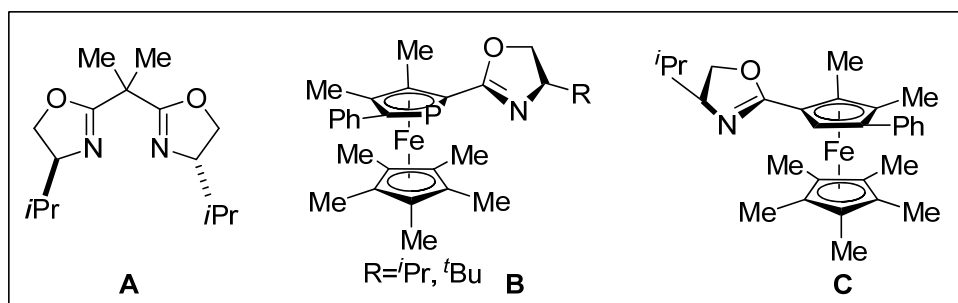
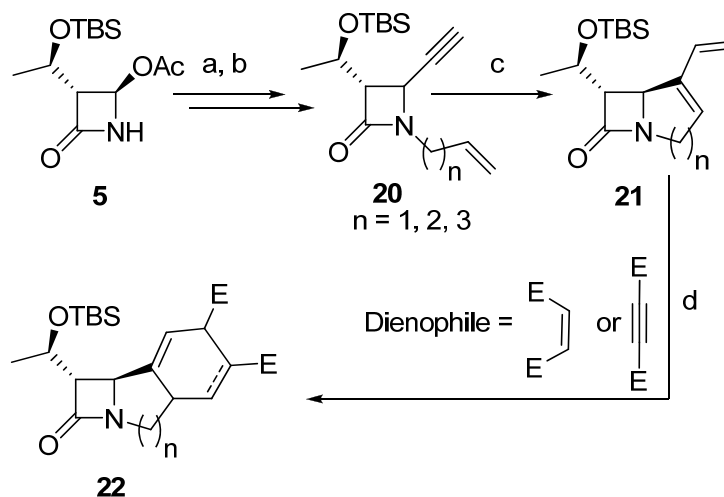


Figure 10: Ligands used for Kinugasa reaction

Savingac *et al.* reported an efficient route to construct 4/5/6 fused polycyclic β -lactams using enyne metathesis and Diels-Alder cycloaddition as the key reactions.²⁰



Scheme 4: Reagents and conditions: a) Trimethylsilylacetylene, *n*-BuLi, THF, -70 °C to -30 °C, b) Bromoalkenes, Bu₄NHSO₄, NaI, KOH, THF, rt, c) Grubb's catalyst, d) Dienophile, LPDE/ionic liquid/DCM, 80 °C.

In case of enyne metathesis, though 4/6 and 4/7 fused bicyclic dienes were readily obtained with Grubb's 1st generation catalyst, 4/5 fused bicyclic system could be achieved only by Grubb's 2nd generation catalyst. Also to get 4/5/6 system, use of ionic liquid as solvent was more preferable than DCM (Scheme 6).

Conclusion

The development of carbapenem antibiotics and emergence of new drug resistant strains of bacteria are two parallel processes boosted by each other and thus making the drug development process a double-edged sword. The drugs which are now in use as common antibiotics are flawed with limited efficacy and inadequate safety profiles, some of which are used along with additives (Imipenem, Panipenem). Also apart from the gene mutation, some of the resistant strains evolve due to prolonged clinical use and improper dosage.²¹ This calls for development of new class of futuristic antibiotics and efficient synthetic methods so that a vast number of related compounds can be synthesized and studied for potential antibacterial properties.

3.2 PRESENT WORK

The extensive use of common β -lactam antibiotics such as penicillins and cephalosporins in medicine has resulted in an increasing number of resistant strains of bacteria through mutation and β -lactamase gene transfer. The development and synthesis of new classes of β -lactam antibiotics has been a matter of much investigation and research for both industrial and academic sectors. Tricyclic β -lactam antibiotics or trinems are a new class of synthetic antibacterial agents having good resistance to β -lactamase and dehydropeptidase. Due to their biological and medicinal importance, synthesis of trinems has been lately grabbed the attention of scientific community. The challenges involved in the synthesis of tricyclic β -lactam antibiotics and the need of new methods propelled us to find effective routes in this direction.

In the continuation of the ongoing research interest in transition metal mediated cycloisomerization reactions and their utilization in synthesizing biologically active molecules in our laboratory,²² the idea of implementing cyclotrimerization reaction for the construction of tricyclic carbapenem framework was conceived.

Visualizing the possibility of synthesizing 4/5/6 tricyclic framework similar to 6-(1-hydroxyethyl)cyclonocardicins **4d** reported by Christensen *et al.* from Merck which show activity against a wide range of pathogens including both Gram positive (*S. aureus*, *Strep. Pyogenes*, *B. subtilis*) and Gram negative (*E. coli*, *Pseudomonas*, *Proteus morgani* etc.), we sketched our strategy as shown in figure 11.

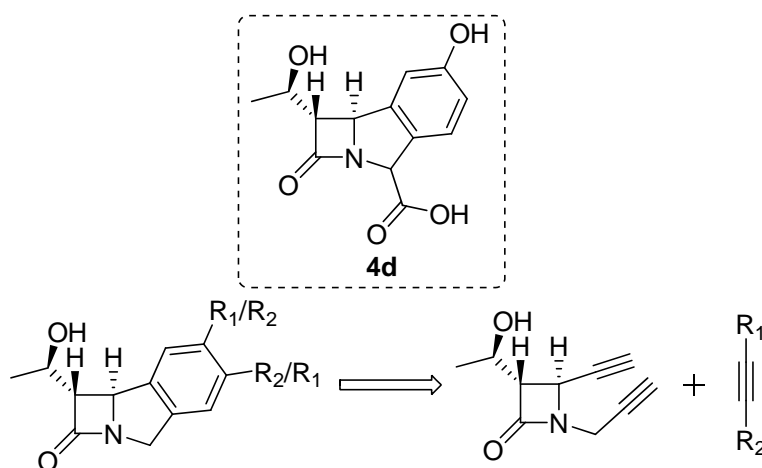
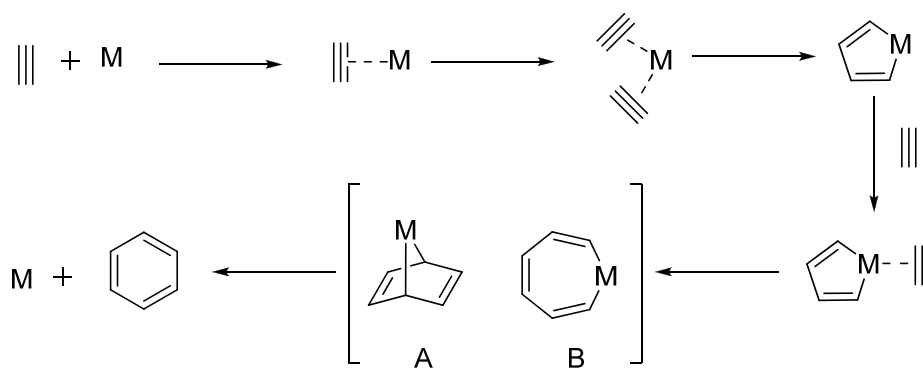


Figure 11

Note on cyclotrimerization reaction:

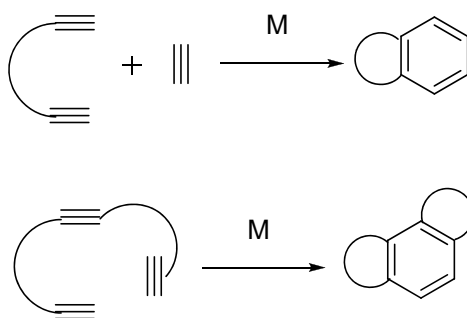
Transition metal catalysed cycloaddition reactions are among the most efficient methods in organic chemistry for the synthesis of cyclic compounds from acyclic substrates. This is because multiple bond formation in a single operation is possible which is rather difficult by conventional organic chemistry.

Cyclotrimerization reaction was first reported by Reppe.²³ The [2+2+2] cyclotrimerization of alkynes is a straight forward and atom-economical route to synthesize a wide range of polysubstituted benzenes and highly functionalized polycyclic compounds. The mechanism of cyclotrimerization reaction has been considered to be as shown in figure 12.

**Figure 12**

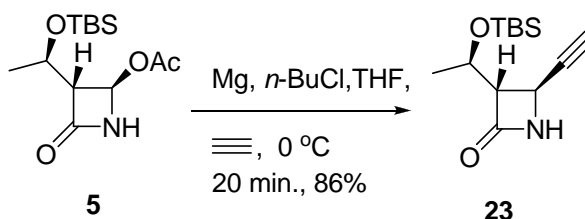
Two alkyne moieties coordinate to the metal to give metallacyclopentadiene. Addition of another alkyne gives rise to metallacycle such as **A** or **B** and then reductive elimination of metal results in the benzene ring (Figure 12).

In intermolecular cyclotrimerization reaction, chemo- and regioselectivity problems lead to a complex mixture of products. A good amount of selectivity can be achieved by following a partially intramolecular approach where two alkynes are tethered to the same substrate or a completely intramolecular approach where all three alkynes are connected (Figure 13).

**Figure 13**

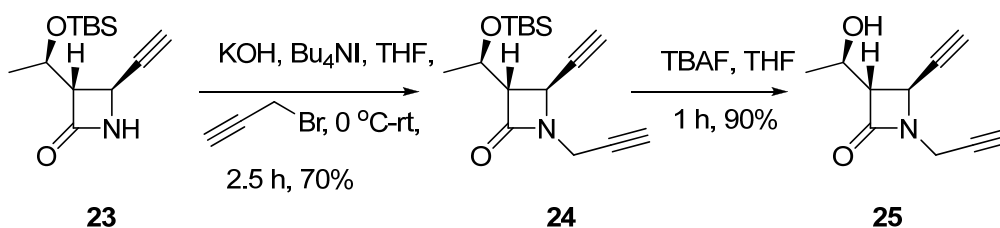
Synthesis of dialkyne **25** was started from 2-azitidinone **5**. Selective introduction of ethynyl group at C4 position was the first challenge to meet. In literature there only a few reports are available, which mostly employ a transition metal catalyzed reaction with TMS protected acetylene.²⁴

To have a simple method that can be viable on large scales, we opted for the addition of an alkynyl Grignard reagent as it will also address the flexibility on keeping the substituent on the first introducing alkyne unit. The attempted addition of ethynyl Grignard reagent $\text{CH}\equiv\text{CMgCl}$ (generated by passing dry acetylene gas to a solution of preformed *n*-BuMgCl in THF) addition to 2-azitidinone **5** resulted with **23** in an excellent yield. The structure of the product was confirmed from the spectral and analytical data. In ^1H NMR spectrum, the characteristic free acetylene proton resonated at 2.37 ppm as a doublet with $J = 2.1$ Hz. The free NH proton appeared at 6.59 ppm as a broad singlet. Signals for *sp*-carbons were observed at 73.1 and 81.8 ppm in the ^{13}C NMR spectrum of **23**. Mass [m/z 276.16 for $(\text{M}+\text{Na})^+$] and elemental analysis supported the assigned constitution of **23** (Scheme 5).



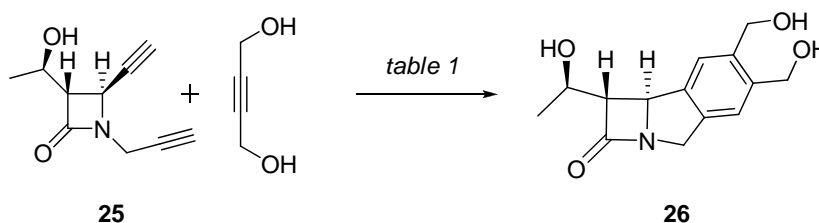
Scheme 5

Compound **23** was then subjected to propargylation reaction by using propargyl bromide and KOH in the presence of a phase transfer catalyst Bu_4NI in THF. The propargylation reaction proceeded smoothly and provided **24** in good yields. Appearance of an additional triplet at 2.19 ppm for propargylic proton in ^1H NMR and two additional signals at 74.6 and 76.4 ppm in ^{13}C NMR accounted for newly introduced alkyne in **24**. The structure was further proved by mass [m/z 314.03 for $(\text{M}+\text{Na})^+$] and elemental analysis. The deprotection of OTBS group by TBAF in THF furnished our required diyne substrate **25**. Disappearance of the characteristic peaks of TBS group (singlets at 0.04, 0.05 and 0.85 ppm) and appearance of a broad singlet at 2.50 ppm in ^1H NMR were in supportive of the assigned structure of **25**. Mass [m/z 199.50 for $(\text{M}+\text{Na})^+$] and elemental analysis further confirmed the structure (Scheme 6).



Scheme 6

With the diyne compound in hand now the objective was to find a suitable catalyst for its [2+2+2] cyclotrimerization with an external alkyne. The cyclotrimerization reaction of the diyne **25** was explored initially by employing 2-butyne-1,4-diol as the substrate. Various reported catalysts known for [2+2+2] alkyne cyclotrimerization were screened with these substrates. Amongst the various catalysts employed, the reaction with Wilkinson's catalyst provided the formation of a new compound with reasonable UV-activity for detection on the TLC plates. So a [2+2+2] cyclotrimerization reaction of **25** with butyne diol resulted in the trimerized product **26** which was proved by its proton NMR. Appearance of signals in aromatic region at 7.33 and 7.47 ppm approved the structure of trimerized product **26**.



Catalyst	Solvent	Temp.	time	Yield
Ni(cod) ₂ / PPh ₃	THF-Toluene	reflux	18 h	13%
Mo(CO) ₆	THF-Toluene	reflux	6 h	08%
Rh(PPh₃)₃Cl	Toluene-ethanol	80 °C	3 h	65%
CoCl ₂ .6H ₂ O / Zn	THF	reflux	-	-
[Ir(cod)Cl] ₂ dppe	THF-Toluene	reflux	-	-

Table 1

Scheme 7: Cyclotrimerization of diyne **25** with 2-butyne-1,4-diol

To prove the versatility of our intended strategy, we have employed commercially available symmetric alkynes having different types of functional groups for the projected [2+2+2] alkyne cyclotrimerization reaction. In case of the reactions

with simple acetylene, the reactions were conducted (a solution of **25** and Wilkinson catalyst saturated with dry acetylene gas) in a sealed tube at 80 °C (Table 2). Formation of the trimerized product **27** was evident from the absence of acetylene protons ($-\text{C}\equiv\text{CH}$) and appearance of peaks in aromatic region (7.21–7.39 ppm). Mass [m/z 226.20 for $(\text{M}+\text{Na})^+$] and elemental analysis further confirmed the assigned structure. However, the attempted trimerization reaction with sterically demanding substrates such as diphenyl acetylene and bistrimethylsilyl acetylene failed to produce the required trimerized product (Table 2).

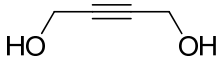
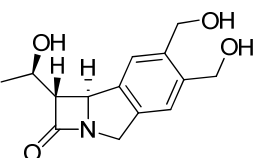
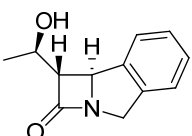
Entry	Alkyne	Product	Yield (%)
1		 26	65
2	$\text{H}-\text{C}\equiv\text{C}-\text{H}$	 27	70
3	$\text{TMS}-\text{C}\equiv\text{C}-\text{TMS}$	No reaction	
4	$\text{Ph}-\text{C}\equiv\text{C}-\text{Ph}$	No reaction	

Table 2: Trimerization reaction with symmetric alkynes.

To extend the generality of our strategy, different unsymmetric alkynes have been employed as the co-partners for the trimerization reaction and the results obtained are summarized in table 3. In general the reactions are not regioselective and resulted in almost 1:1 inseparable regiomer mixtures. However, by extensive chromatographic purifications, we could separate compounds **31**, **32** and **35** from their respective regiomer mixtures and confirm their constitution with the help of extensive 2D NMR experiments.

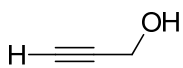
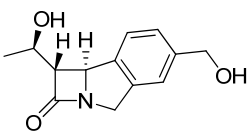
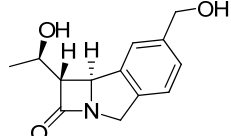
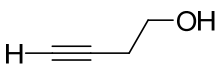
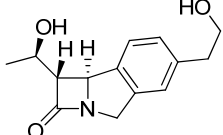
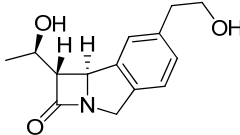
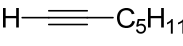
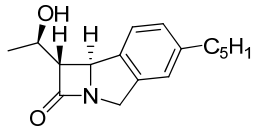
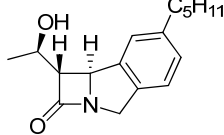
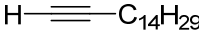
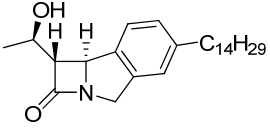
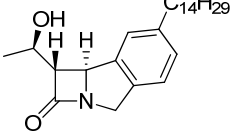
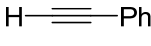
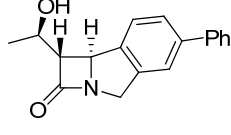
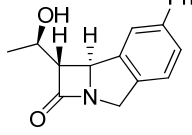
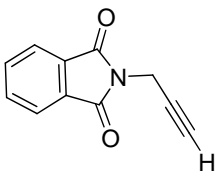
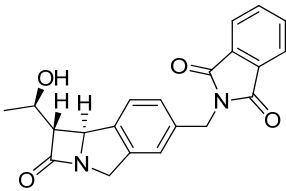
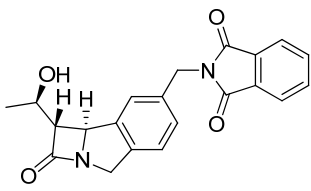
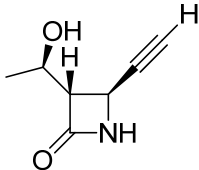
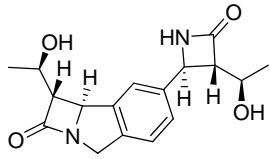
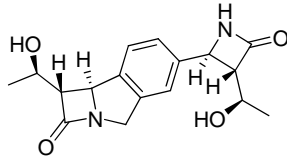
Entry	Alkyne	Products	(Ratio) /Yield (%)	
1		 28	 29	(1:1) 62
2		 30	 31*	(1:1) 60
3		 32*	 33	(1:1) 55
4		 34	 35*	(1:1) 55
5		 36	 37	(2:3) 64
6		 38	 39	(2:3) 48
7		 40	 41	(1:1) 52

Table 3. The cyclotrimerization of diyne **31** with alkynes
(Compounds with ‘*’ were isolated and characterized)

The combination of observations obtained from NOESY, HSQC and HMBC studies helped to deduce the structure of compound **31**. The proton resonating at 7.23 ppm as a singlet was found to be connected to the aromatic carbon C-8 in HSQC. In HMBC, correlations were observed between H-8 and C-12 (38.8 ppm). The protons at C-12 appearing as a triplet at 3.87 ppm also showed cross peaks with C-8 (124.1 ppm) and C-10 (129.0 ppm). There was no interaction observed between C-11 (123.1 ppm) and H-12. This confirmed the position of the side chain to be at C-9. Also in NOE spectra, correlation was observed between H-8 and H-12, indicating *ortho* position of C-12 to C-8 (Figure 14).

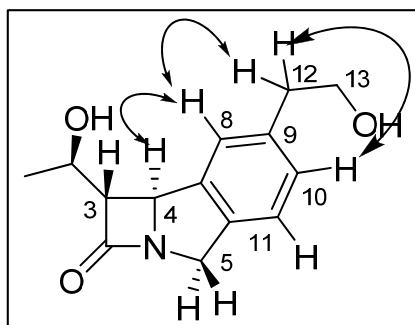


Figure 14: NOE of **31**

The structure of compound **32** was confirmed by NOE studies. One of the protons at C-5 showed interaction with the proton at C-4 which again interacted with C-8 proton. Another proton at C-5 gave NOE signal with H-11. Protons at C-12 showed interactions with H-9 and H-11, but there was no interaction with H-8, thus confirming the position of the alkyl side chain to be at C-10 (Figure 15). The single crystal X-ray crystallographic studies of **32** further approved the structure (Figure 16).

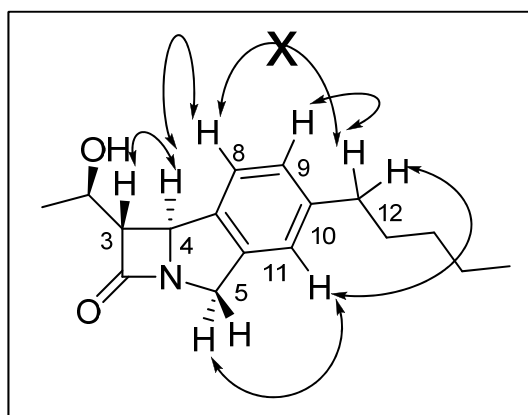


Figure 15: NOE of **32**

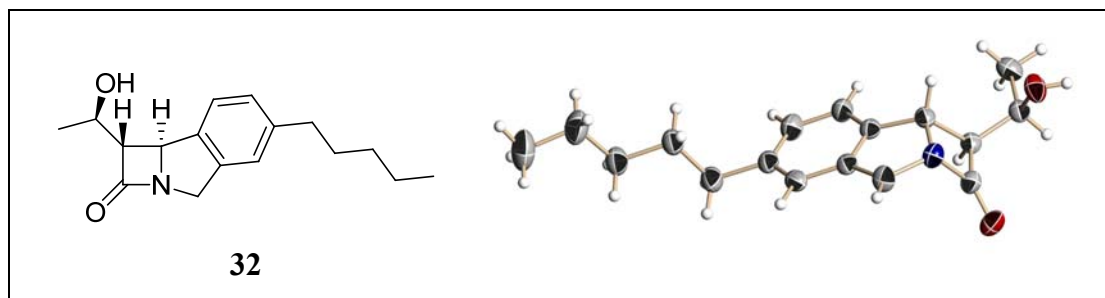


Figure 16: ORTEP diagram of 32

The NOE spectra of **35** helped in elucidating its structure. For this we had to fix the aromatic protons first. As H-4 at 4.86 ppm had an interaction with the singlet aromatic proton at 7.14 ppm, and H-4 could have interaction only with H-8, the proton at 7.14 ppm was confirmed to be H-8. The protons at C-12 showed NOE correlation with H-8, demonstrating the position of alkyl side chain to be *ortho* to C-8 (Figure 17).

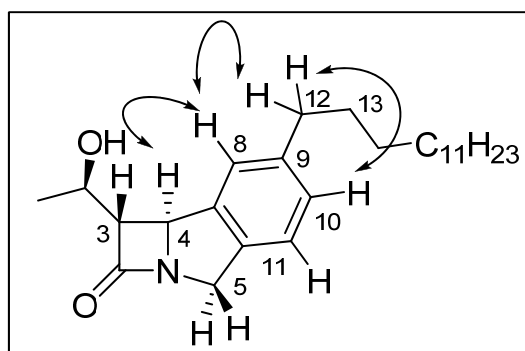


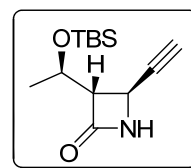
Figure 17: NOE of 35

Conclusion:

In conclusion, a [2+2+2] alkyne cyclotrimerization reaction was employed successfully to construct the central framework of 4/5/6 tricyclic carbapenem structure. Introduction of different substituents to the structure was achieved easily by using different alkynes. This leaves considerable room for functional modification at the side chain without much hassle and a library of compounds can be synthesized for further improvement.

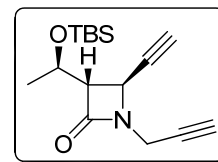
3.3 EXPERIMENTAL

(3*S*,4*S*)-3-((*R*)-1-(*tert*-butyldimethylsilyloxy)ethyl)-4-ethynyl azetidin-2-one (**23**):



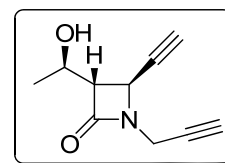
Mg (4.2 g, 173.95 mmol) was flame dried in a two neck R.B. flask fitted with a reflux condenser and cooled to room temperature in argon atmosphere. Dry THF (150 mL) was introduced followed by a few crystals of iodine. Half the total volume of *n*-BuCl (18 mL, 173.95 mmol) was added and the contents were refluxed till the generation of Grignard reagent. The reaction temperature was brought to rt and the rest of *n*-BuCl was added. Stirring continued at room temperature till all the magnesium was consumed. Then the reaction mixture was cooled to 0 °C and acetylene gas was bubbled into it for 15 min. Compound **5** (10 g, 34.79 mmol) in THF (50 mL) was added at 0 °C and stirred for 20 min. The reaction was quenched with saturated NH₄Cl solution, diluted with water and extracted with ethyl acetate. The combined organic layer was dried over Na₂SO₄, concentrated and purified on silica gel (10% ethyl acetate in light petroleum) to get alkyne compound **23** (7.6 g, 86%) as white solid.

Mol. Formula	: C ₁₃ H ₂₃ NO ₂ Si
Mol. Weight	: 253.41
[α]_D²⁵	: -5.3 (<i>c</i> 1, CHCl ₃)
IR (CHCl₃, cm⁻¹)	: 3415, 3306, 3019, 2975, 2400, 1768, 1521, 1423, 1046, 928.
¹H NMR (200 MHz, CDCl ₃)	: δ 0.02 (s, 3H), 0.03 (s, 3H), 0.83 (s, 9H), 1.20 (d, <i>J</i> = 6.3 Hz, 3H), 2.37 (d, <i>J</i> = 2.1 Hz, 1H), 3.25 (ddd, <i>J</i> = 0.8, 2.5, 3.6 Hz, 1H), 4.19 (dq, <i>J</i> = 3.6, 6.3 Hz, 1H), 4.27 (t, <i>J</i> = 2.3 Hz, 1H), 6.59 (br s, 1H).
¹³C NMR (50 MHz, CDCl ₃)	: δ -5.2 (q), -4.4 (q), 17.8 (s), 22.1 (q), 25.6 (q, 3C), 38.6 (d), 64.4 (d), 67.3 (d), 73.1 (d), 81.8 (s), 168.1 (s).
Elemental Analysis	: Calcd: C, 61.61; H, 9.15; N, 5.53. Found: C, 61.88; H, 9.37; N, 5.37.
ESI-MS <i>m/z</i>	: 276.16 [M+Na] ⁺

(3*S*,4*S*)-3-((*R*)-1-(tert-butyldimethylsilyloxy)ethyl)-4-ethynyl-1-(prop-2-ynyl)azetidin-2-one (24):

Compound **23** (4 g, 15.78 mmol) was taken in dry THF under argon. Propargyl bromide (1.32 mL, 31.56 mmol), tetrabutyl ammonium iodide (2.3 g, 6.3 mmol) and crushed KOH (2.2 g, 39.46 mmol) were added subsequently at 0 °C and stirred for 2.5 h at room temperature. The reaction was quenched with saturated NH₄Cl solution. After usual workup and concentration, the crude product was purified by column chromatography (10% ethyl acetate in light petroleum) to obtain **24** (3.2 g, 70%) as a thick liquid.

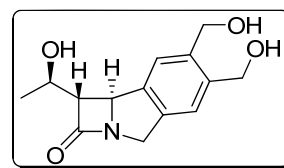
Mol. Formula	: C ₁₆ H ₂₅ NO ₂ Si
Mol. Weight	: 291.46
[α]_D²⁵	: -12.7 (<i>c</i> 1, CHCl ₃)
IR (CHCl₃, cm⁻¹)	: 3308, 3019, 2957, 2931, 2886, 2858, 2401, 1758, 1624, 1523, 1471, 1463, 1427, 1396, 1377, 1332, 1258, 1216, 1143, 1079, 1055, 987, 947, 885, 838.
¹H NMR (200 MHz, CDCl ₃)	: δ 0.04 (s, 3H), 0.05 (s, 3H), 0.85 (s, 9H), 1.21 (d, <i>J</i> = 6.3 Hz, 3H), 2.19 (t, <i>J</i> = 2.5 Hz, 1H), 2.43 (d, <i>J</i> = 2.1 Hz, 1H), 3.21 (ddd, <i>J</i> = 0.9, 2.4, 3.2 Hz, 1H), 3.72 (ddd, <i>J</i> = 0.9, 2.5, 17.8 Hz, 1H), 4.16–4.27 (m, 1H), 4.28 (dd, <i>J</i> = 2.5, 17.8 Hz, 1H), 4.39 (t, <i>J</i> = 2.2 Hz, 1H).
¹³C NMR (50 MHz, CDCl ₃)	: δ -5.0 (q), -4.4 (q), 17.9 (s), 22.3 (q), 25.8 (q, 3C), 29.6 (t), 41.7 (d), 64.2 (d), 66.2 (d), 72.5 (d), 74.6 (d), 76.4 (s), 79.9 (s), 166.1 (s).
Elemental Analysis	: Calcd: C, 65.93; H, 8.65; N, 4.81. Found: C, 65.88; H, 8.57; N, 4.49.
ESI-MS <i>m/z</i>	: 314.03 [M+Na] ⁺

(3*S*,4*S*)-4-ethynyl-3-((*R*)-1-hydroxyethyl)-1-(prop-2-ynyl)azetidin-2-one (25):

Compound **24** (2 g, 6.8 mmol) was taken in THF (15 mL) under argon. TBAF (2.1 g, 8.2 mmol) was added subsequently at 0 °C and stirred for 1 h at room temperature. The reaction was quenched with saturated NH₄Cl solution. After usual workup and concentration, the crude product was purified by column chromatography (60% ethyl acetate in light petroleum) to obtain **25** (1.1 g, 90%) as a thick liquid.

Mol. Formula	: C ₁₀ H ₁₁ NO ₂
Mol. Weight	: 177.20
[α]_D²⁵	: -34.9 (<i>c</i> 1, CHCl ₃)
IR (CHCl₃, cm⁻¹)	: 3019, 2915, 2400, 1755, 1601, 1426, 1261, 1123, 1035, 928, 909.
¹H NMR (200 MHz, CDCl ₃)	: δ 1.29 (d, <i>J</i> = 6.4 Hz, 3H), 2.25 (t, <i>J</i> = 2.6 Hz, 1H), 2.46 (d, <i>J</i> = 2.1 Hz, 1H), 2.50 (br s, 1H), 3.27 (ddd, <i>J</i> = 0.8, 2.5, 4.5 Hz, 1H), 3.77 (ddd, <i>J</i> = 0.9, 2.5, 17.8 Hz, 1H), 4.17–4.23 (m, 1H), 4.27 (dd, <i>J</i> = 2.5, 17.8 Hz, 1H), 4.37 (t, <i>J</i> = 2.2 Hz, 1H).
¹³C NMR (125 MHz, CDCl ₃)	: δ 21.1 (q), 29.9 (t), 42.5 (d), 64.1 (d), 65.7 (d), 72.8 (d), 74.9 (d), 76.2 (s), 79.3 (s), 166.6 (s).
Elemental Analysis	: Calcd: C, 67.78; H, 6.26; N, 7.90. Found: C, 67.88; H, 6.37; N, 7.37.
ESI-MS <i>m/z</i>	: 199.50 [M+Na] ⁺

(1*S*)-1-((*R*)-1-hydroxyethyl)-6,7-bis(hydroxymethyl)-1,8b-dihydroazeto[2,1-*a*] isoindol-2(4*H*)-one (26):

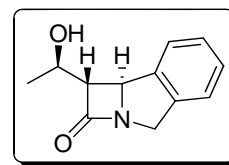


Compound **25** (100 mg, 0.56 mmol) was taken in dry toluene and EtOH mixture. Butynediol (97 mg, 1.13 mmol) and Wilkinson's catalyst (26 mg, 28 μmol) were added to it and heated at 80 °C for 3 h. After completion, the reaction mixture was concentrated and the crude product was purified by column chromatography (ethyl acetate) to obtain **26** (97 mg, 65%) as a thick liquid.

Mol. Formula	: C ₁₄ H ₁₇ NO ₄
Mol. Weight	: 263.29
[α]_D²⁵	: -19.8 (<i>c</i> 0.6, MeOH)

IR (CHCl ₃ , cm ⁻¹)	: 3397, 3340, 2925, 2855, 2724, 1756, 1560, 1463, 1376, 1256, 1187, 1168, 1139, 1076, 1032.
¹H NMR (400 MHz, CDCl ₃ + DMSO- <i>d</i> ₆)	: δ 1.30 (d, <i>J</i> = 6.2 Hz, 3H), 3.01 (dd, <i>J</i> = 2.3, 6.5 Hz, 1H), 4.05 (d, <i>J</i> = 14.4 Hz, 1H), 4.14 (t, <i>J</i> = 6.3 Hz, 1H), 4.60 (s, 2H), 4.63 (s, 2H), 4.79 (d, <i>J</i> = 14.6 Hz, 1H), 4.85 (s, 1H), 5.05 (br s, 2H), 5.14 (br s, 1H), 7.33 (s, 1H), 7.47 (s, 1H).
¹³C NMR (100 MHz, CDCl ₃ + DMSO- <i>d</i> ₆)	: δ 20.4 (q), 49.8 (t), 58.4 (d), 59.5 (t, 2C), 62.9 (d), 66.0 (d), 120.2 (d), 120.8 (d), 137.1 (s), 137.9 (s), 138.0 (s), 139.0 (s), 177.6 (s).
Elemental Analysis	: Calcd: C, 63.87; H, 6.51; N, 5.32. Found: C, 63.88; H, 6.37; N, 5.37.
ESI-MS <i>m/z</i>	: 296.16 [M+Na] ⁺

(1*S*)-1-((*R*)-1-hydroxyethyl)-1,8*b*-dihydroazeto[2,1-*a*]isoindol-2(4*H*)-one (27):



Compound **25** (150 mg, 0.84 mmol) was taken in dry toluene and EtOH mixture (5:1, 6 mL) in a sealed tube. Wilkinson's catalyst (39 mg, 42 μmol) was added to it. The tube was cooled to -78 °C and dry acetylene gas was bubbled through it for 10–15 min. The tube was closed by septum and heated at 80 °C for 3 h. The reaction was concentrated, the crude product was purified by column chromatography (10% ethyl acetate in light petroleum) to obtain **27** (120 mg, 70%) as a thick liquid.

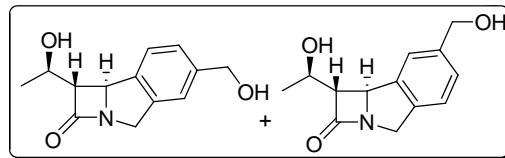
Mol. Formula	: C ₁₂ H ₁₃ NO ₂
Mol. Weight	: 203.24
[α]_D²⁵	: 2.2 (<i>c</i> 1, CHCl ₃)
IR (CHCl ₃ , cm ⁻¹)	: 3428, 3019, 2932, 1752, 1560, 1457, 1321, 1268, 1134, 1045, 926, 890, 839.
¹H NMR (200 MHz, CDCl ₃)	: δ 1.42 (d, <i>J</i> = 6.3 Hz, 3H), 2.98 (br s, 1H), 3.18 (dd, <i>J</i> = 2.5, 5.9 Hz, 1H), 4.10 (dd, <i>J</i> = 2.0, 14.9 Hz, 1H), 4.34 (q, <i>J</i> = 6.2 Hz, 1H), 4.87–4.93 (m, 2H), 7.21–7.39 (m, 4H).
¹³C NMR (100 MHz, CDCl ₃)	: δ 21.8 (q), 51.7 (t), 59.9 (d), 65.2 (d), 67.2 (d), 123.0 (d), 123.5 (d), 127.9 (d), 128.0 (d), 139.6 (s), 142.1 (s), 179.1 (s).

Elemental Analysis : Calcd: C, 70.92; H, 6.45; N, 6.89.

Found: C, 70.88; H, 6.31; N, 6.74.

ESI-MS m/z : 226.20 $[M+Na]^+$

(1S)-1-((R)-1-hydroxyethyl)-6/7-(hydroxymethyl)-1,8b-dihydroazeto[2,1-a] isoindol-2(4H)-one 28 and 29:



Compound **25** (90 mg, 0.51 mmol) was taken in dry toluene and EtOH mixture (5:1, 4 mL). Propargyl alcohol (57 mg, 1.01 mmol) and Wilkinson's catalyst (23 mg, 25 μmol) were added to it. Reaction mixture was heated at 80 °C for 5 h. After completion, the reaction mixture was concentrated and the crude product was purified by column chromatography (70% ethyl acetate in light petroleum) to obtain **28** and **29** (73 mg, 62%) as a thick liquid.

Mol. Formula : $\text{C}_{13}\text{H}_{15}\text{NO}_3$

Mol. Weight : 233.26

IR (CHCl_3 , cm^{-1}) : 3421, 3019, 2930, 1753, 1620, 1456, 1437, 1325, 1161, 1121, 1045, 928, 879.

$^1\text{H NMR}$: δ 1.36 (d, $J = 6.31$ Hz, 3H), 3.07–3.14 (m, 1H), 4.01–4.07 (m, 1H), 4.39 (q, $J = 6.3$ Hz, 1H), 4.65 (d, $J = 2.2$ Hz, 2H), 4.80–4.87 (m, 2H), 7.19–7.32 (m, 3H).
(200 MHz, CDCl_3)
(regiomeric mixture)

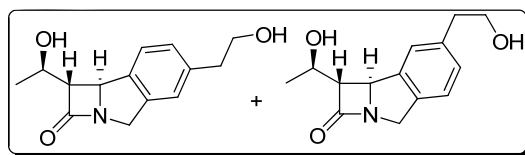
$^{13}\text{C NMR}$: δ 21.8 (q, 2C), 51.6 (t), 51.7 (t), 59.8 (d), 59.9 (d), 64.7 (t), 64.8 (t), 65.3 (d), 65.4 (d), 67.2 (d), 121.6 (d), 122.1 (d), 123.0 (d), 123.5 (d), 126.8 (d), 127.0 (d), 139.0 (s), 140.1 (s), 141.2 (s), 141.5 (s), 142.7 (s), 179.0 (s).
(100 MHz, CDCl_3)
(regiomeric mixture)

Elemental Analysis : Calcd: C, 66.94; H, 6.48; N, 6.00.

Found: C, 66.61; H, 6.49; N, 5.87.

ESI-MS m/z : 256.17 $[M+Na]^+$

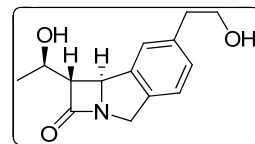
(1S)-1-((R)-1-hydroxyethyl)-6/7-(2-hydroxyethyl)-1,8b-dihydroazeto[2,1-a] isoindol-2(4H)-one (30) and (31):



Compound **25** (120 mg, 0.68 mmol) was taken in dry toluene and EtOH mixture (5:1, 5 mL). Homopropargyl alcohol (95 mg, 1.35 mmol) and Wilkinson's

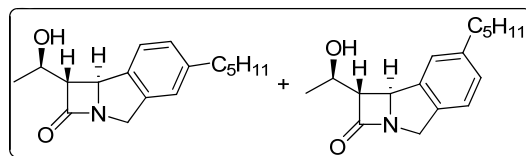
catalyst (31 mg, 34 μmol) were added to it and the reaction mixture was heated at 80 $^{\circ}\text{C}$ for 3 h. After completion of reaction, the reaction mixture was concentrated and the crude product was purified by column chromatography (80% ethyl acetate in light petroleum) to obtain **30** and **31** (100 mg, 60%) as a thick liquid. Flash chromatography resulted in pure regioisomer **31**.

(1S)-1-((R)-1-hydroxyethyl)-7-(2-hydroxyethyl)-1,8b-dihydroazeto[2,1-a]isoindol-2(4H)-one (31):



Mol. Formula	: $\text{C}_{14}\text{H}_{17}\text{NO}_3$
Mol. Weight	: 247.29
$[\alpha]_{\text{D}}^{25}$: -26.2 (c 1, CHCl_3)
IR (CHCl_3, cm^{-1})	: 3422, 3018, 2932, 1752, 1457, 1330, 1044, 928.
$^1\text{H NMR}$ (400 MHz, CDCl_3)	: δ 1.42 (d, $J = 6.3$ Hz, 3H), 1.88 (br s, 2H), 2.89 (t, $J = 6.6$ Hz, 2H), 3.18 (dd, $J = 2.4, 6.0$ Hz, 1H), 3.87 (t, $J = 6.5$ Hz, 2H), 4.07 (dd, $J = 2.2, 14.2$ Hz, 1H), 4.34 (q, $J = 6.3$ Hz, 1H), 4.84–4.91 (m, 2H), 7.18 (s, 1H), 7.18 (s, 1H), 7.23 (s, 1H).
$^{13}\text{C NMR}$ (100 MHz, CDCl_3)	: δ 21.9 (q), 38.8 (t), 51.6 (t), 59.9 (d), 63.5 (t), 65.4 (d), 67.1 (d), 123.1 (d), 124.1 (d), 129.0 (d), 138.8 (s), 140.1 (s), 140.5 (s), 178.8 (s).
Elemental Analysis	: Calcd: C, 68.00; H, 6.93; N, 5.66. Found: C, 68.19; H, 6.67; N, 5.39.
ESI-MS m/z	: 269.99 $[\text{M}+\text{Na}]^+$

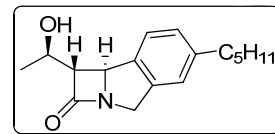
(1S)-1-((R)-1-hydroxyethyl)-6/7-pentyl-1,8b-dihydroazeto[2,1-a]isoindol-2(4H)-one (32) and (33):



Compound **25** (150 mg, 0.85 mmol) was taken in dry toluene and EtOH mixture (5:1, 6 mL). After the addition of 1-heptyne (162 mg, 1.7 mmol) and Wilkinson's catalyst (63 mg, 42 μmol), the reaction mixture was heated at 80 $^{\circ}\text{C}$ for 5 h. After completion of reaction, the reaction mixture was concentrated and the crude product was purified by column chromatography (30% ethyl acetate in light

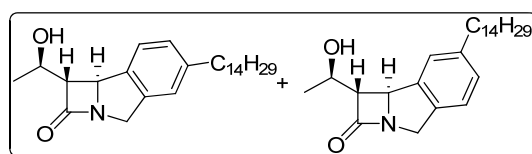
petroleum) to obtain **32** and **33** (127 mg, 55%) as a thick liquid. Compound **32** could be isolated and characterized.

(1S)-1-((R)-1-hydroxyethyl)-6-pentyl-1,8b-dihydroazeto[2,1-a]isoindol-2(4H)-one (32):

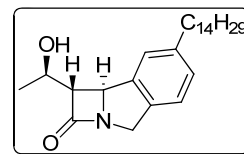


- Mol. Formula** : C₁₇H₂₃NO₂
- Mol. Weight** : 273.37
- [α]_D²⁵** : +28.5 (c 1, CHCl₃)
- IR (CHCl₃, cm⁻¹)** : 3404, 3019, 2960, 2859, 2400, 1752, 1618, 1457, 1332, 1160, 1135, 1045, 929, 881.
- ¹H NMR** (400 MHz, CDCl₃) : δ 0.89 (t, *J* = 6.9 Hz, 3H), 1.26–1.37 (m, 4H), 1.42 (d, *J* = 6.35 Hz, 3H), 1.6 (q, *J* = 7.9 Hz, 2H), 2.15 (br s, 1H), 2.61 (t, *J* = 7.6 Hz, 2H), 3.15 (dd, *J* = 2.4, 5.9 Hz, 1H), 4.08 (br d, *J* = 14.6 Hz, 1H), 4.34 (q, *J* = 6.3 Hz, 1H), 4.84–4.89 (m, 2H), 7.05 (s, 1H), 7.12 (br d, *J* = 7.8 Hz, 1H), 7.25 (d, *J* = 7.8 Hz, 1H).
- ¹³C NMR** (100 MHz, CDCl₃) : δ 14.0 (q), 21.8 (q), 22.5 (t), 31.3 (t), 31.4 (t), 35.7 (t), 51.8 (t), 59.7 (d), 65.4 (d), 67.1 (d), 122.9 (d), 123.2 (d), 128.3 (d), 136.9 (s), 142.5 (s), 143.3 (s), 179.0 (s).
- Elemental Analysis** : Calcd: C, 74.69; H, 8.48; N, 5.12.
Found: C, 74.48; H, 8.45; N, 5.23.
- ESI-MS *m/z*** : 296.16 [M+Na]⁺

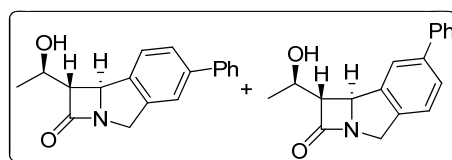
(1S)-1-((R)-1-hydroxyethyl)-6/7-tetradecyl-1,8b-dihydroazeto[2,1-a]isoindol-2(4H)-one (34) and (35):



Compound **25** (130 mg, 0.73 mmol) was taken in dry toluene and EtOH mixture (5:1, 6 mL). 1-hexadecayne (326 mg, 1.47 mmol) and Wilkinson's catalyst (34 mg, 37 μmol) were added to it. Reaction mixture was heated at 80 °C for 4.5 h. After completion of reaction, the reaction mixture was concentrated and the crude product was purified by column chromatography (35% ethyl acetate in pet ether) to obtain **34** and **35** (161 mg, 55%) as a thick liquid. Compound **35** was separated and characterized.

(1S)-1-((R)-1-hydroxyethyl)-7-tetradecyl-1,8b-dihydroazeto[2,1-a]isoindol-2(4H)-one (35):

Mol. Formula	: C ₂₆ H ₄₁ NO ₄
Mol. Weight	: 399.61
[α]_D²⁵	: -18.4 (c 1, CHCl ₃)
IR (CHCl₃, cm⁻¹)	: 3406, 3019, 2927, 1757, 1133.
¹H NMR (400 MHz, CDCl ₃)	: δ 0.87 (t, <i>J</i> = 6.8 Hz, 3H), 1.25–1.32 (m, 22H), 1.42 (d, <i>J</i> = 6.3 Hz, 3H), 1.59 (q, <i>J</i> = 7.2 Hz, 2H), 1.96 (br s, 1H), 2.60 (t, <i>J</i> = 7.8 Hz, 2H), 3.16 (dd, <i>J</i> = 2.5, 6.2 Hz, 1H), 4.07 (br d, <i>J</i> = 14.4 Hz, 1H), 4.34 (q, <i>J</i> = 6.2 Hz, 1H), 4.83–4.87 (m, 2H), 7.09–7.14 (m, 3H).
¹³C NMR (100 MHz, CDCl ₃)	: δ 14.1 (q), 22.0 (q), 22.7 (t), 29.4 (t, 2C), 29.5 (t), 29.6 (t), 29.7 (t, 5C), 31.7 (t), 31.9 (t), 35.8 (t), 51.7 (t), 59.9 (d), 65.5 (d), 67.1 (d), 122.8 (d), 123.3 (d), 128.4 (d), 139.6 (s), 139.8 (s), 143.2 (s), 178.8 (s).
Elemental Analysis	: Calcd: C, 78.15; H, 10.34; N, 3.51. Found: C, 78.28; H, 10.57; N, 3.34.
ESI-MS <i>m/z</i>	: 422.65 [M+Na] ⁺

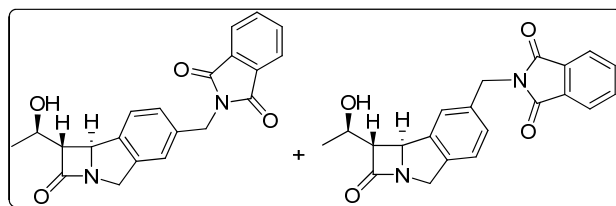
(1S)-1-((R)-1-hydroxyethyl)-6/7-phenyl-1,8b-dihydroazeto[2,1-a]isoindol-2(4H)-one (36) and (37):

Compound **25** (85 mg, 0.48 mmol) was taken in dry toluene and EtOH mixture (5:1, 5 mL). Phenyl acetylene (98 mg, 0.96 mmol) and Wilkinson's catalyst (22 mg, 24 μmol) were added to it. Reaction mixture was heated at 80 °C for 5 h. After completion of reaction, the reaction mixture was concentrated and the crude product was purified by column chromatography (30% ethyl acetate in light petroleum) to obtain **36** and **37** (85 mg, 64%) as a thick liquid.

Mol. Formula	: C ₁₈ H ₁₇ NO ₂
Mol. Weight	: 279.33

- IR** (CHCl_3 , cm^{-1}) : 3438, 3018, 2972, 2931, 2400, 1755, 1618, 1570, 1476, 1455, 1415, 1330, 1180, 1160, 1133, 1076, 1044, 969, 929, 884.
- ^1H NMR** : δ 1.43 (d, $J = 6.3$ Hz, 3H), 2.49 (br s, 1H), 3.20–3.26 (m, 1H), 4.11–4.19 (m, 1H), 4.37 (q, $J = 6.2$ Hz, 1H), 4.92–4.99 (m, 2H), 7.29–7.60 (m, 8H).
(200 MHz, CDCl_3)
(regiomer mixture)
- ^{13}C NMR** : δ 21.9 (q, 2C), 51.6 (t), 51.8 (t), 59.8 (d), 59.9 (d), 65.3 (d), 65.4 (d), 67.2 (d), 67.3 (d), 121.8 (d), 122.2 (d), 123.3 (d), 123.8 (d), 127.2 (d, 2C), 127.3 (d), 127.5 (d), 128.8 (d), 138.7 (s), 140.4 (s), 140.5 (s), 141.3 (s), 141.5 (s), 141.6 (s), 143.1 (s), 178.9 (s, 2C).
(125 MHz, CDCl_3)
(regiomer mixture)
- Elemental Analysis** : Calcd: C, 77.40; H, 6.13; N, 5.01.
Found: C, 77.63; H, 6.35; N, 5.46.
- ESI-MS** m/z : 302.23 $[\text{M}+\text{Na}]^+$

2-(((1*S*)-1-((*R*)-1-hydroxyethyl)-2-oxo-1,2,4,8b-tetrahydroazeto[2,1-*a*]isoindol-6/7-yl)methyl)isoindoline-1,3-dione (38) and (39):



Compound **25** (100 mg, 0.56 mmol) was taken in a mixture of dry toluene and EtOH (5:1, 5 mL). *N*-propargyl -phthalimide (209 mg, 1.13 mmol) and Wilkinson's catalyst (26 mg, 28 μmol) were added to it. Reaction mixture was heated at 80 $^{\circ}\text{C}$ for 5 h. After completion of reaction, the reaction mixture was concentrated and the crude product was purified by column chromatography (50% ethyl acetate in light petroleum) to obtain **38** and **39** (90 mg, 48%) as a thick liquid.

- Mol. Formula** : $\text{C}_{21}\text{H}_{18}\text{N}_2\text{O}_4$
- Mol. Weight** : 362.38
- IR** (CHCl_3 , cm^{-1}) : 3412, 3019, 2930, 1764, 1713, 1615, 1468, 1456, 1432, 1395, 1332, 1187, 1102, 1044, 928, 878.
- ^1H NMR** : δ 1.40, 1.43 (2d, $J = 6.3$ Hz, 3H), 2.26 (br s, 1H), 3.13 (dd, $J = 2.4, 6.1$ Hz, 0.5H), 3.18 (dd, $J = 2.4, 6.0$ Hz, 0.5H), 4.05 (dt, $J = 2.2, 15.3$ Hz, 1H), 4.33 (q, $J = 6.2$ Hz, 1H), 4.83–4.90 (m, 4H), 7.17–7.43 (m, 3H), 7.70–7.74

(m, 2H), 7.83–7.87 (m, 2H).

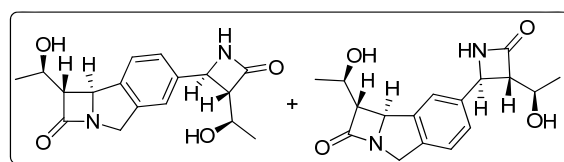
¹³C NMR : δ 21.9 (q), 41.3 (t, 2C), 51.6 (t), 51.7 (t), 59.7 (t), 59.9 (d),
(100 MHz, CDCl₃) 65.3 (d), 65.5 (d), 67.1 (d), 67.2 (d), 123.3 (d, 2C), 123.4
(regiomeric mixture) (d), 123.7 (d), 123.9 (d), 128.6 (d), 128.8 (d), 132.0 (s),
134.1 (d), 136.5 (s), 136.6 (s), 139.4 (s), 140.3 (s), 142.1
(s), 143.0 (s), 168.0 (s), 178.6 (s), 178.7 (s).

Elemental Analysis : Calcd: C, 69.60; H, 5.01; N, 7.73.

Found: C, 69.45; H, 5.30; N, 7.81.

ESI-MS *m/z* : 384.93 [M+Na]⁺

(1*S*)-1-((*R*)-1-hydroxyethyl)-6/7-(3-((*S*)-1-hydroxyethyl)-4-oxoazetid-2-yl)-1,8b-dihydroazeto[2,1-*a*]isoindol-2(4*H*)-one (40) and (41):



Compound **25** (95 mg, 0.54 mmol) was taken in dry toluene and EtOH mixture (5:1, 5 mL). (3*S*,4*R*)-4-ethynyl-3-((*R*)-1-hydroxyethyl)azetid-2-one (149 mg, 1.07 mmol) and Wilkinson's catalyst (25 mg, 27 μmol) were added to it. Reaction mixture was heated at 80 °C for 5 h. After completion of reaction, the reaction mixture was concentrated and the crude product was purified by column chromatography (ethyl acetate) to obtain **40** and **41** (88 mg, 52%) as a thick liquid.

Mol. Formula : C₁₇H₂₀N₂O₄

Mol. Weight : 316.35

IR (nujol, cm⁻¹) : 3430, 3376, 3273, 2924, 2854, 1752, 1613, 1460, 1376, 1305, 1262, 1159, 1133, 1047, 883, 789.

¹H NMR : δ 1.26 (d, *J* = 6.3 Hz, 3H), 1.32 (dd, *J* = 1.1, 6.3 Hz, 3H),
(200 MHz, CDCl₃ + 2.84 (dd, *J* = 1.7, 6.7 Hz, 1H), 3.03 (dd, *J* = 2.4, 6.4 Hz,
DMSO-*d*₆) 0.5H), 3.04 (dd, *J* = 2.4, 6.9 Hz, 0.5H), 4.02–4.24 (m,
(regiomeric mixture) 3H), 4.71–4.85 (m, 3H), 5.14 (t, *J* = 5.2 Hz, 1H), 7.22–
7.45 (m, 3H), 8.14 (br s, 1H).

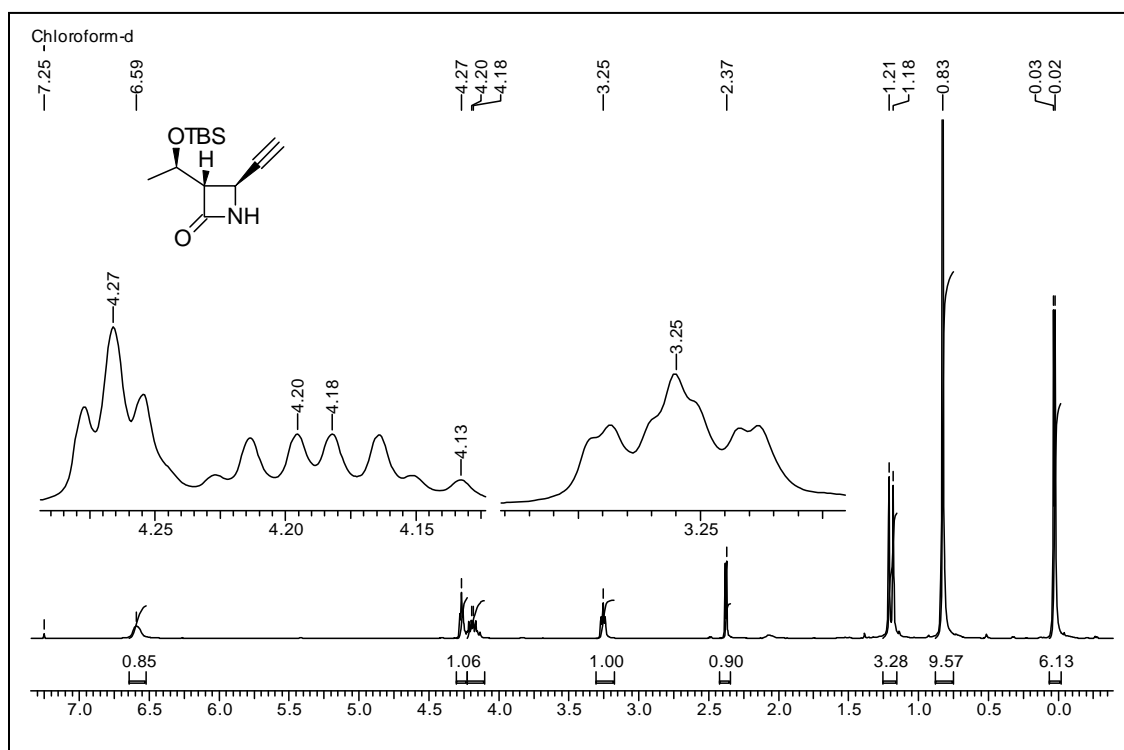
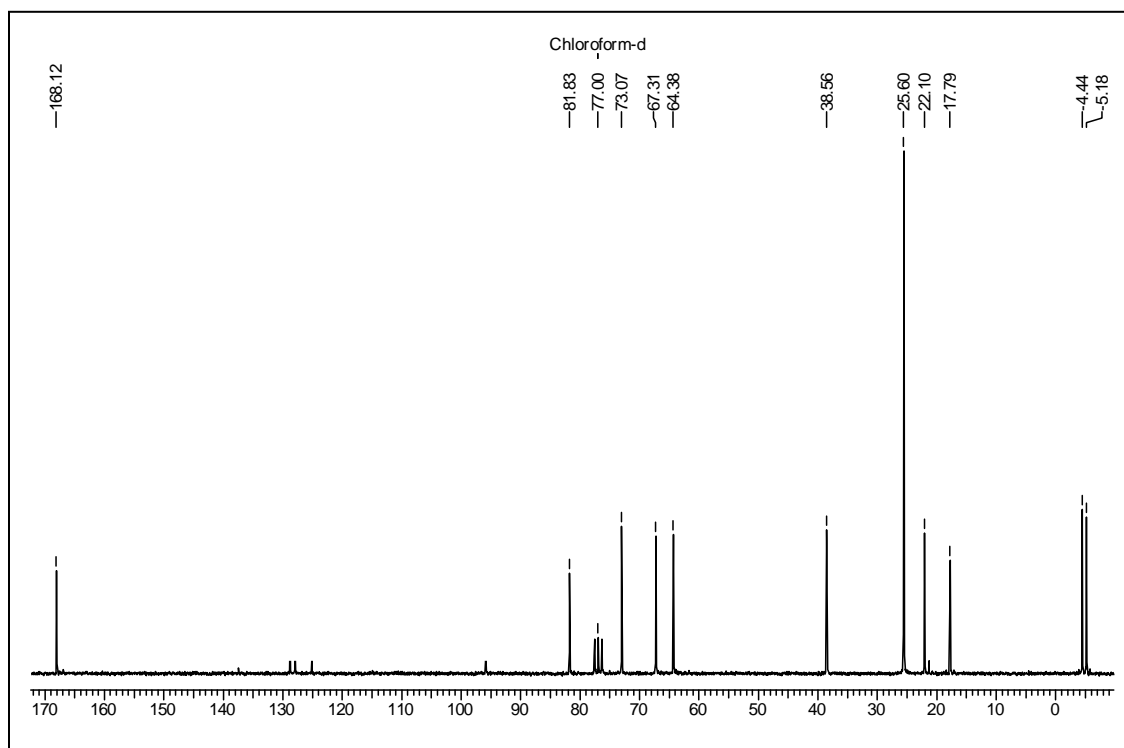
¹³C NMR : δ 20.7 (q), 20.8 (q), 50.0 (t), 50.2 (t), 51.8 (d), 51.9 (d),
(100 MHz, CDCl₃ + 58.5 (d), 58.9 (d), 63.2 (d), 63.5 (d), 63.6 (d, 2C),
DMSO-*d*₆) 66.41 (d), 66.5 (d), 67.1 (d), 67.2 (d), 119.1 (d), 119.6
(regiomeric mixture) (d), 121.7 (d), 122.4 (d), 124.3 (d), 124.5 (d), 138.1

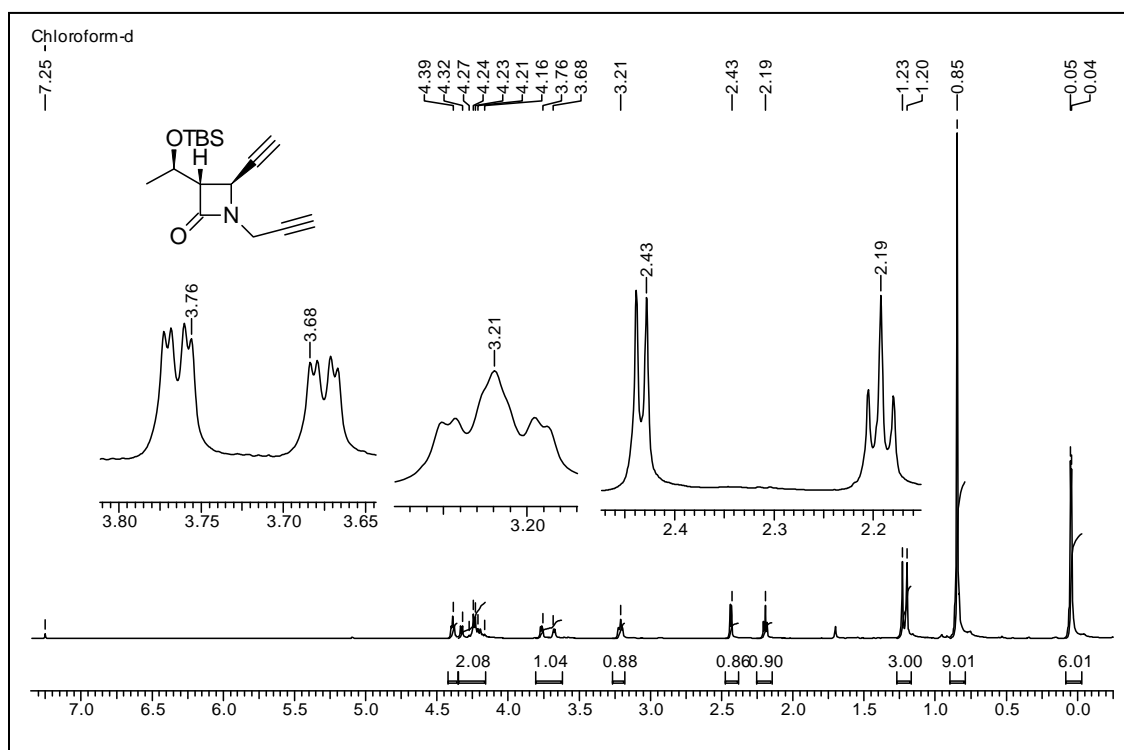
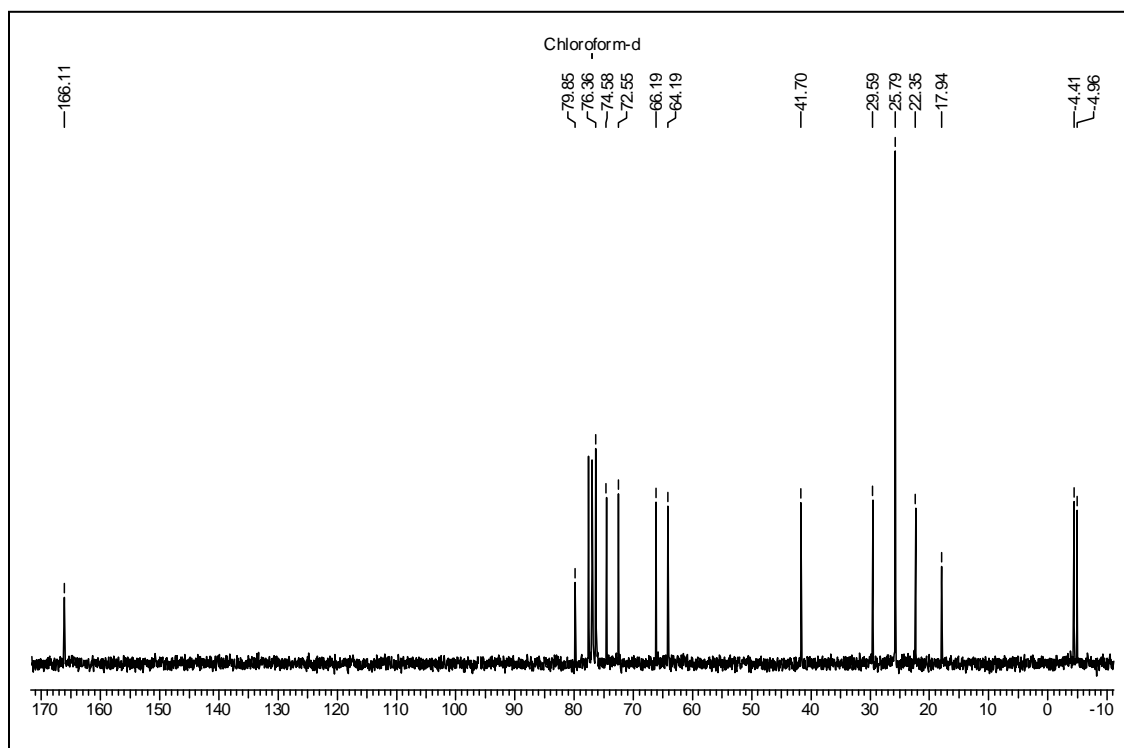
(s), 139.3 (s), 140.1 (s), 140.3 (s), 141.3 (s), 167.4 (s, 2C), 177.8 (s), 177.9 (s).

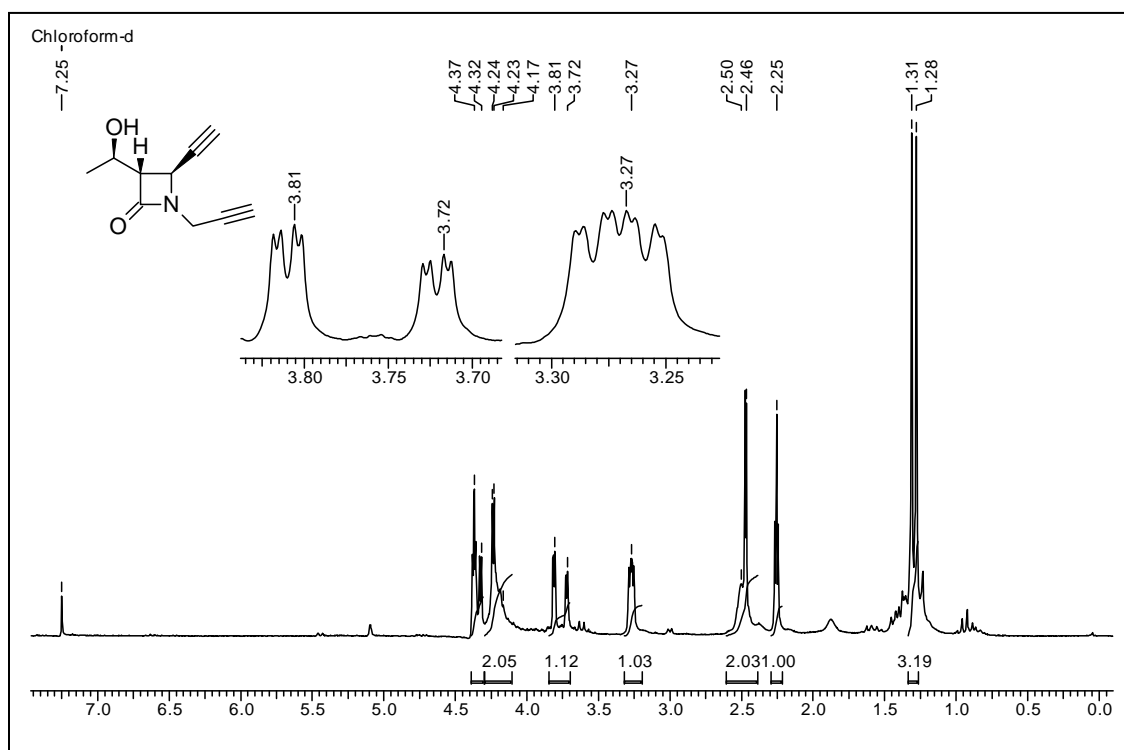
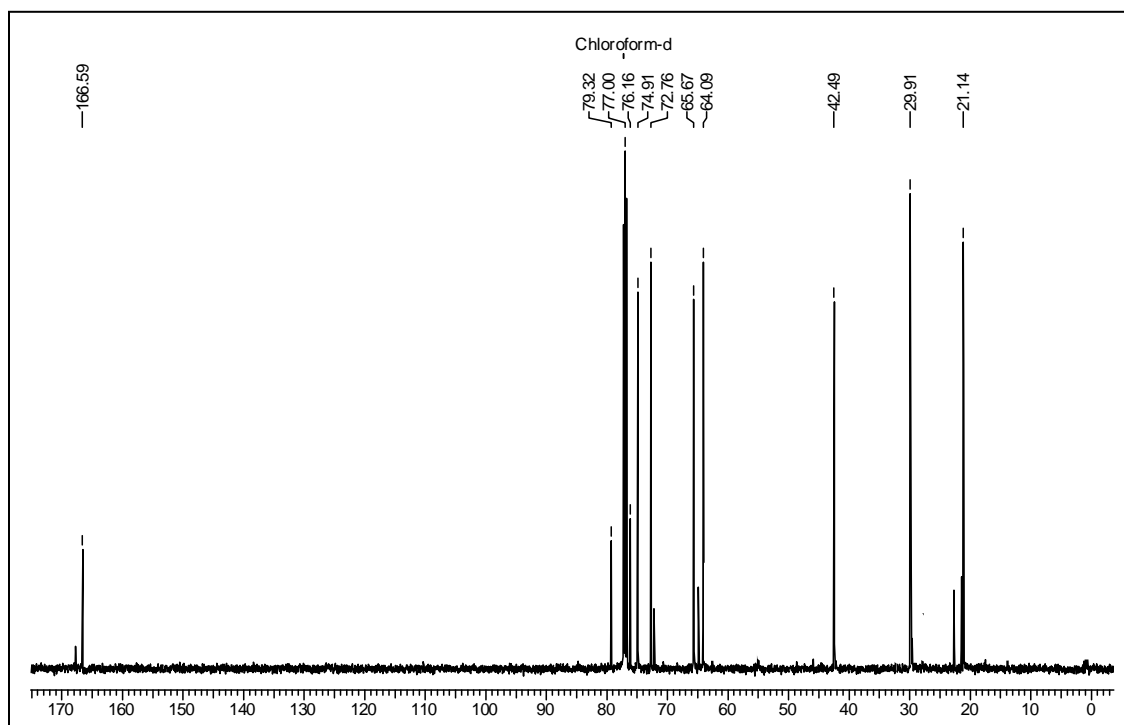
Elemental Analysis : Calcd: C, 64.54; H, 6.37; N, 8.86.

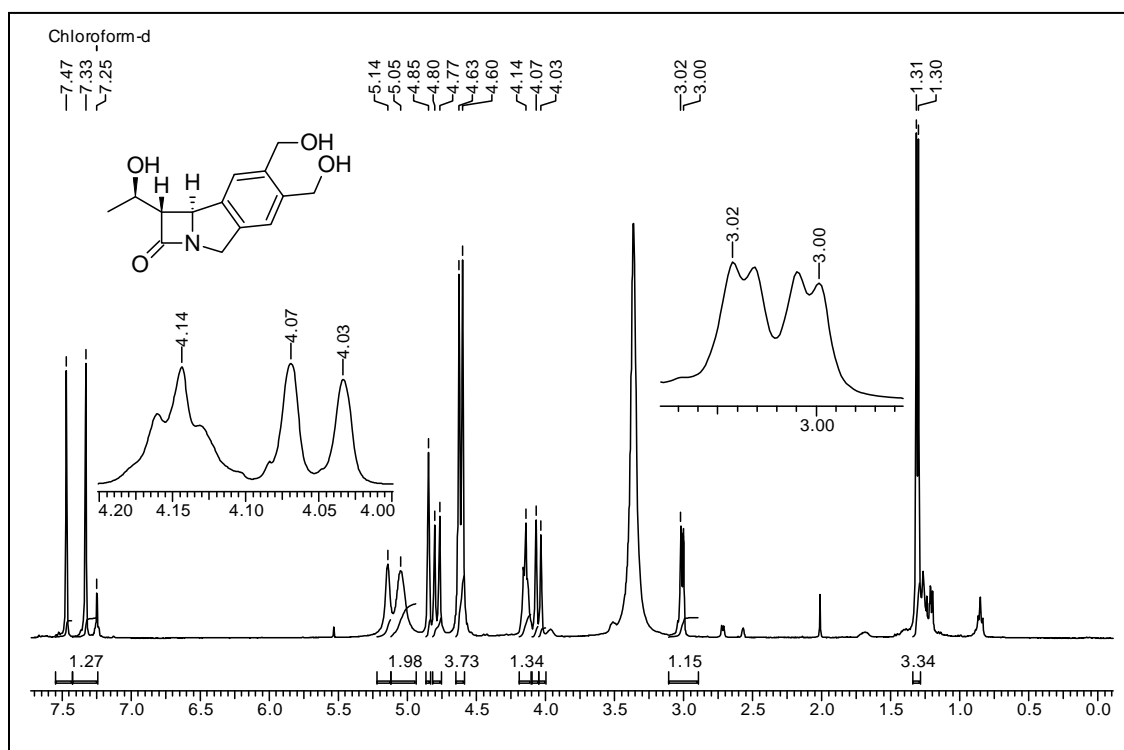
Found: C, 64.88; H, 6.15; N, 8.67.

ESI-MS m/z : 339.10 $[M+Na]^+$

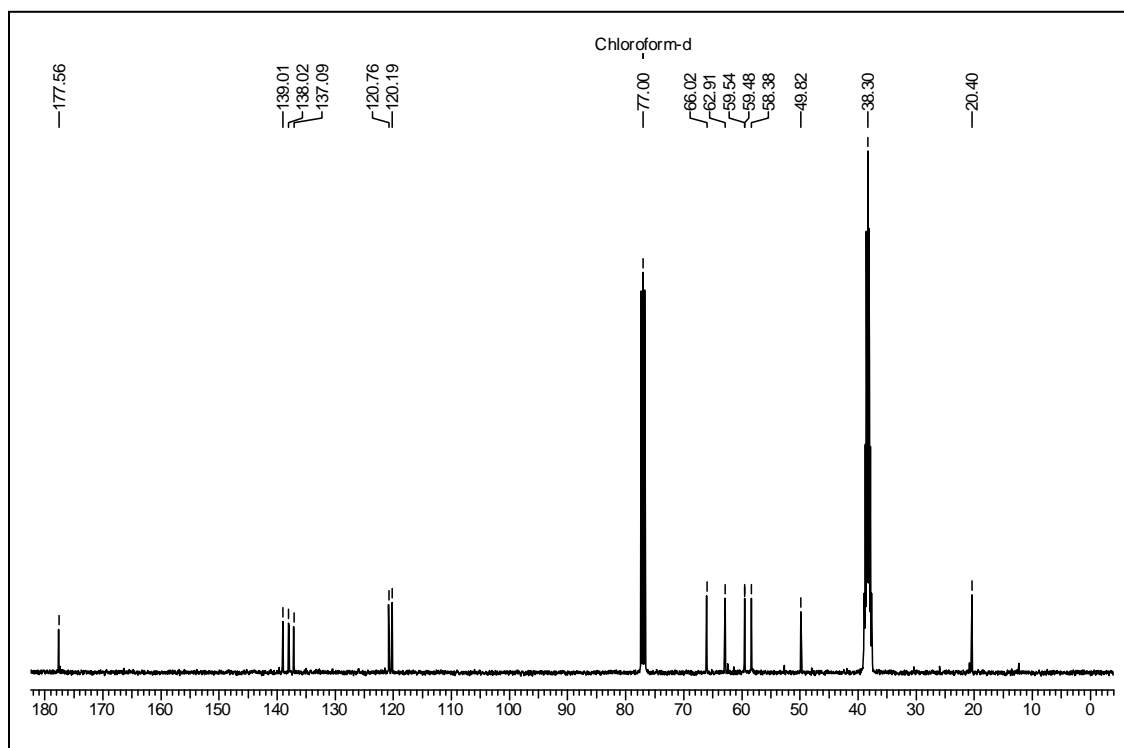
 ^1H NMR Spectrum of 23 in CDCl_3  ^{13}C NMR Spectrum of 23 in CDCl_3

 ^1H NMR Spectrum of 24 in CDCl_3  ^{13}C NMR Spectrum of 24 in CDCl_3

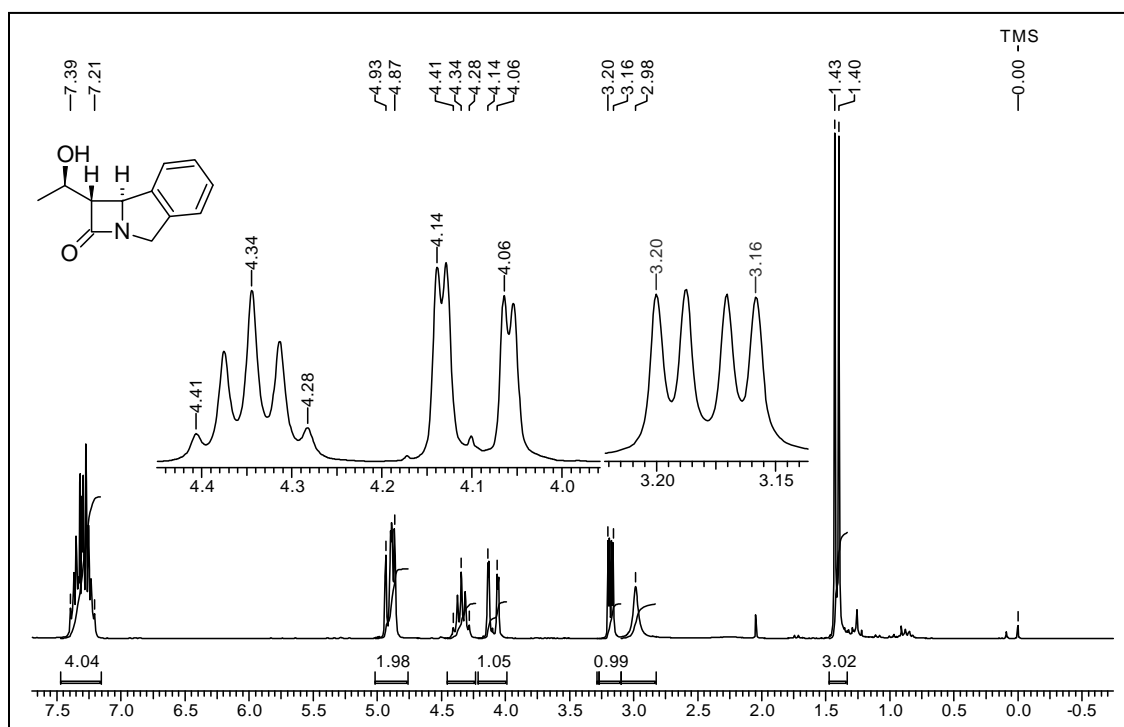
 ^1H NMR Spectrum of 25 in CDCl_3  ^{13}C NMR Spectrum of 25 in CDCl_3



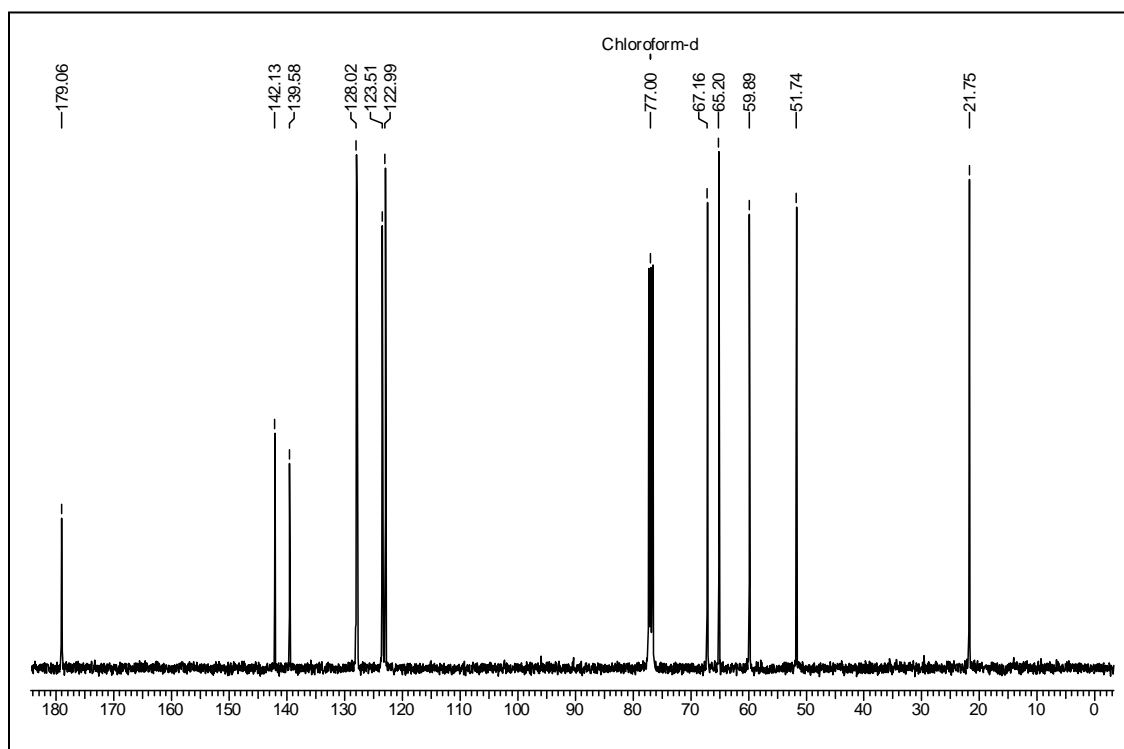
^1H NMR Spectrum of 26 in $\text{CDCl}_3 + \text{DMSO}-d_6$



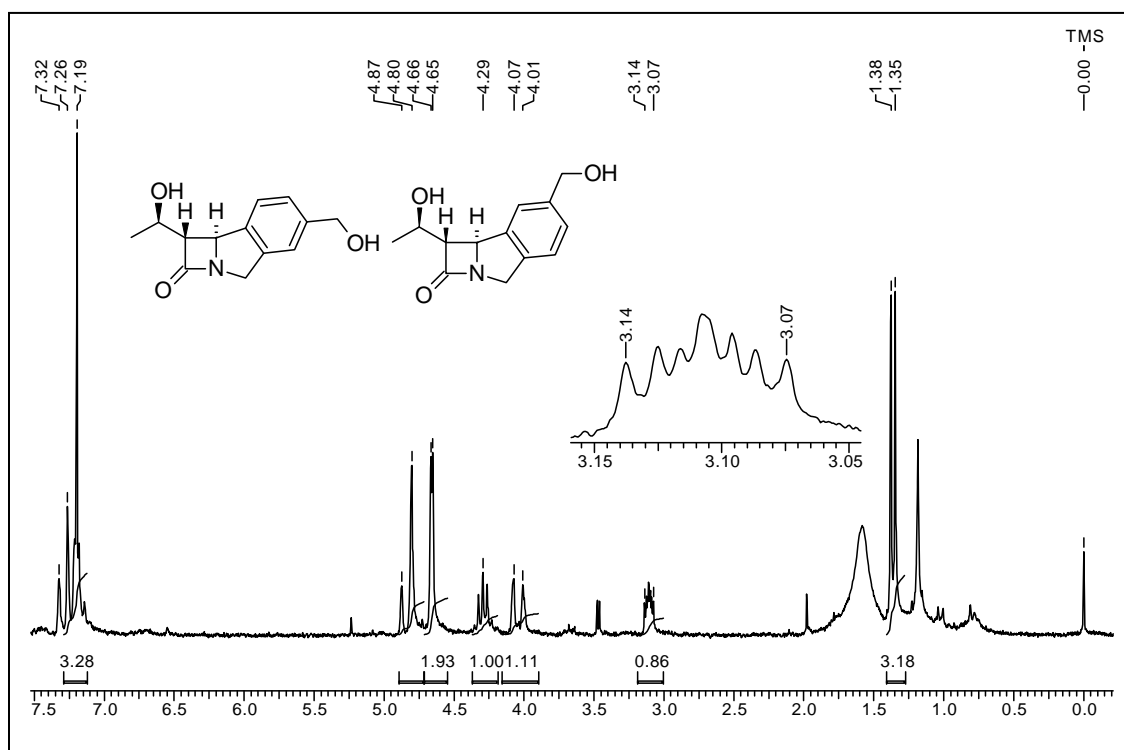
^{13}C NMR Spectrum of 26 in $\text{CDCl}_3 + \text{DMSO}-d_6$



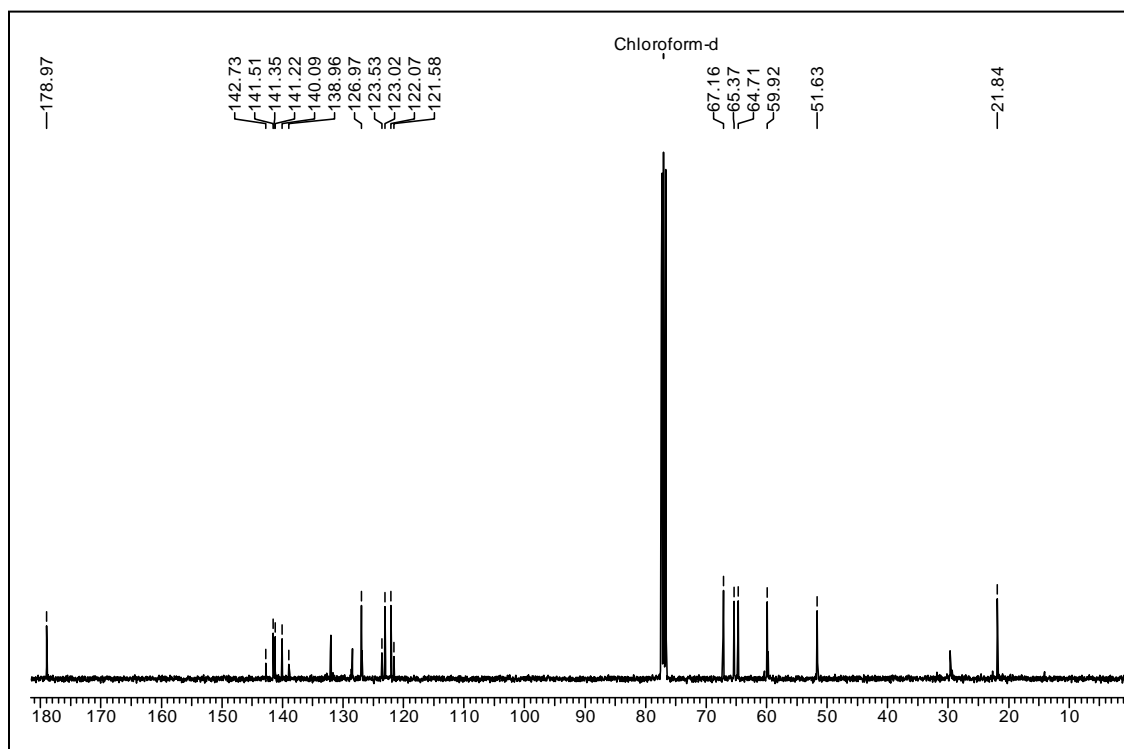
¹H NMR Spectrum of 27 in CDCl₃



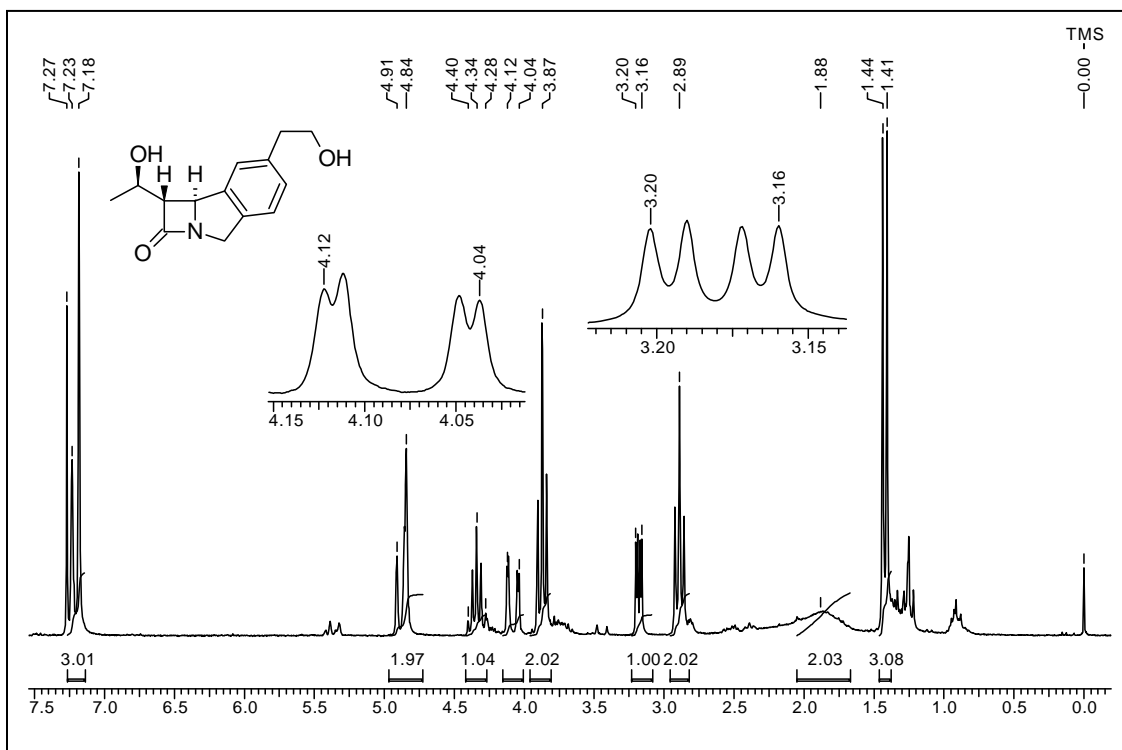
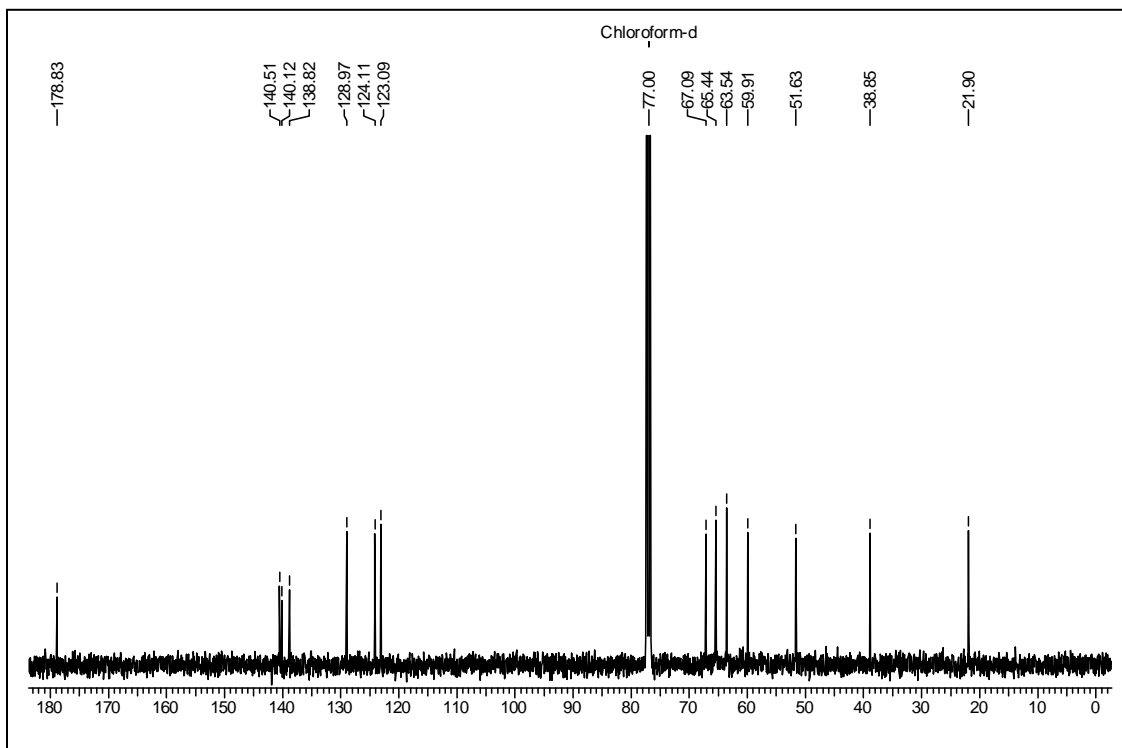
¹³C NMR Spectrum of 27 in CDCl₃

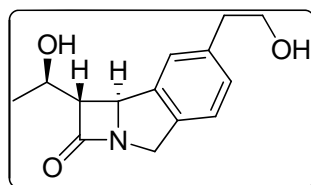
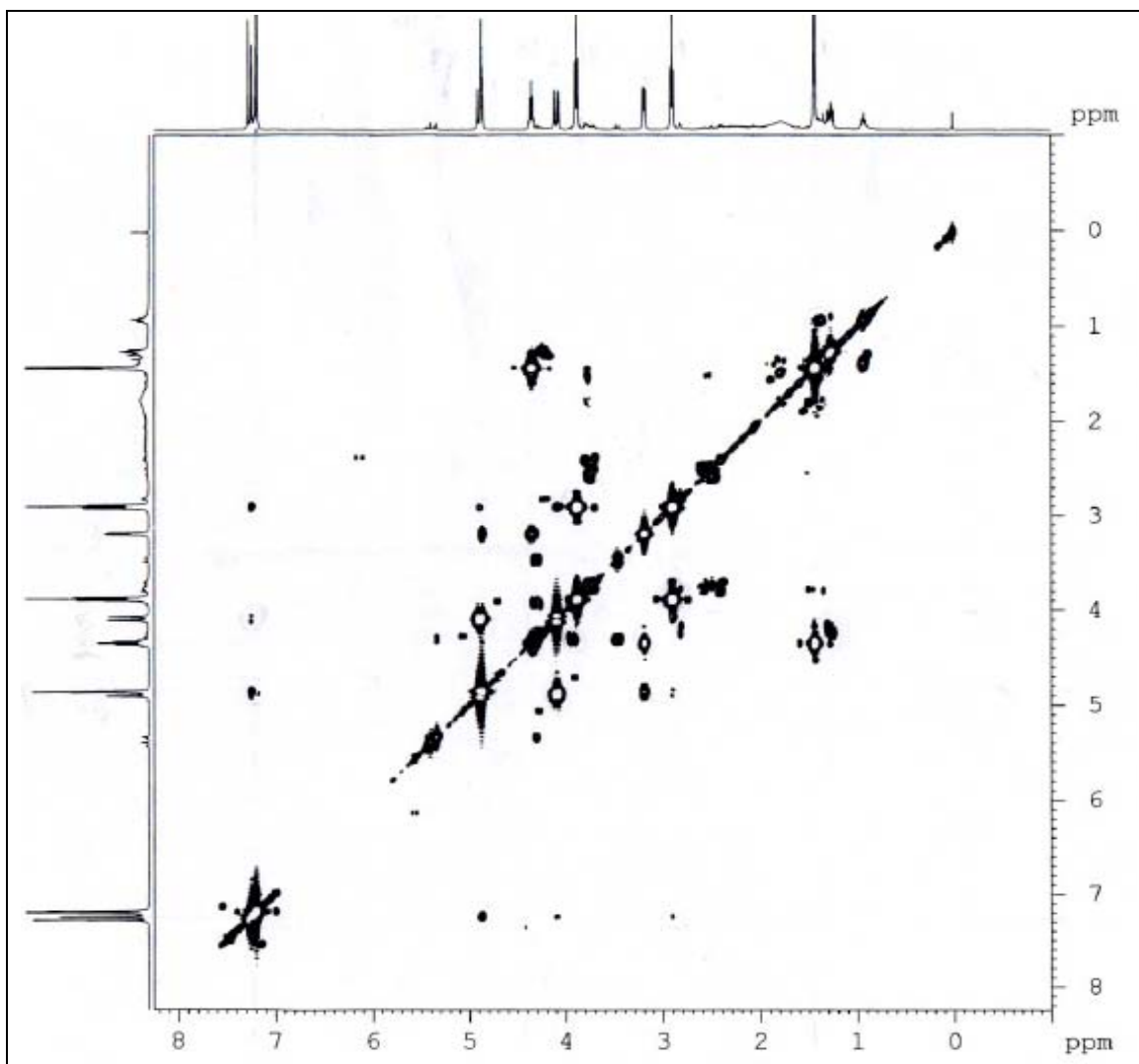


^1H NMR Spectrum of 28 and 29 in CDCl_3

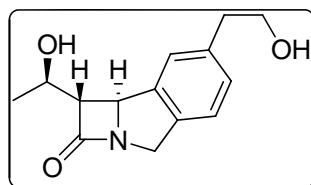
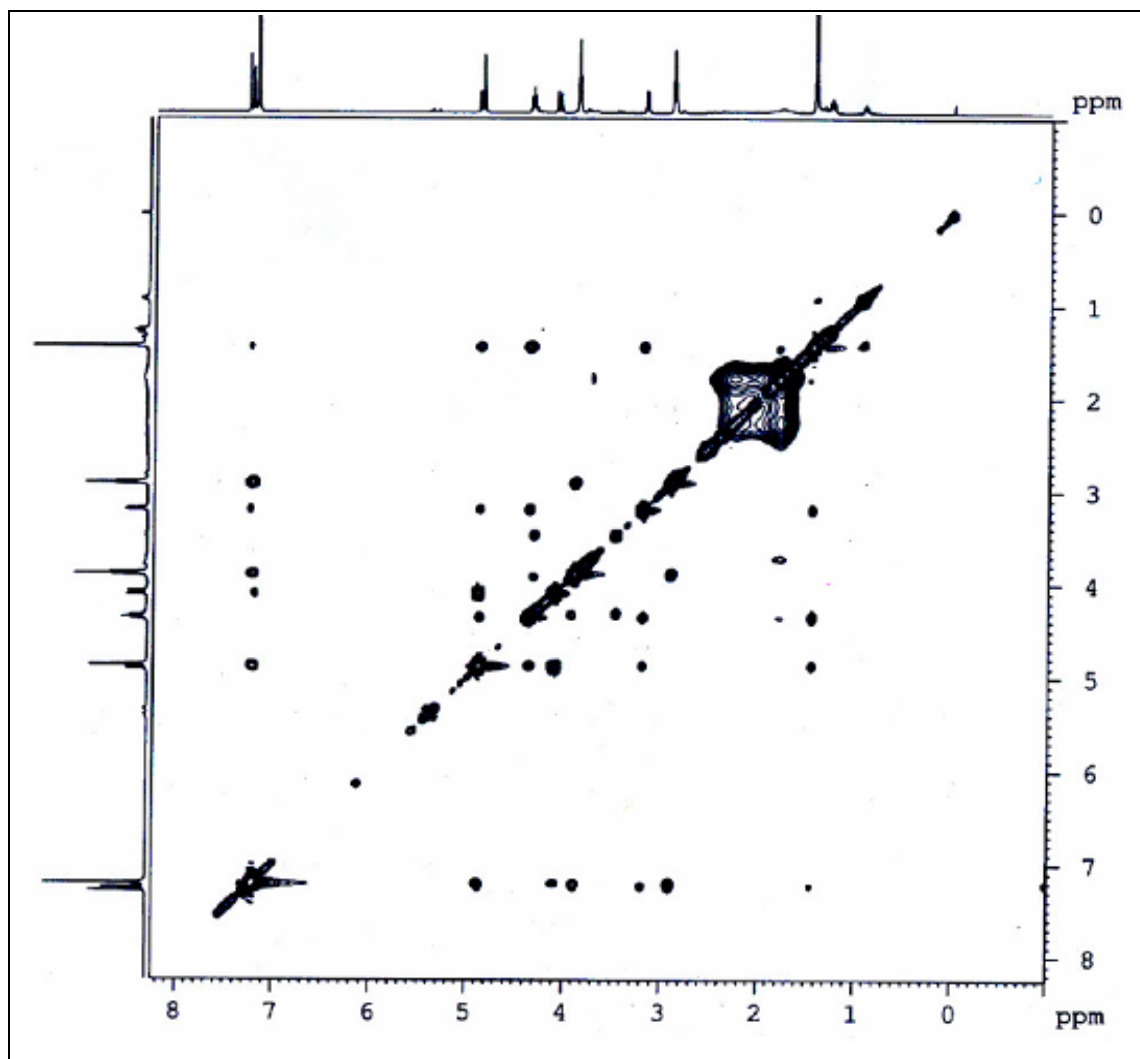


^{13}C NMR Spectrum of 28 and 29 in CDCl_3

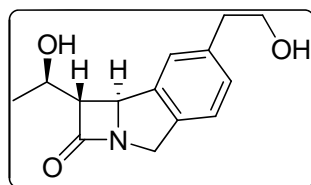
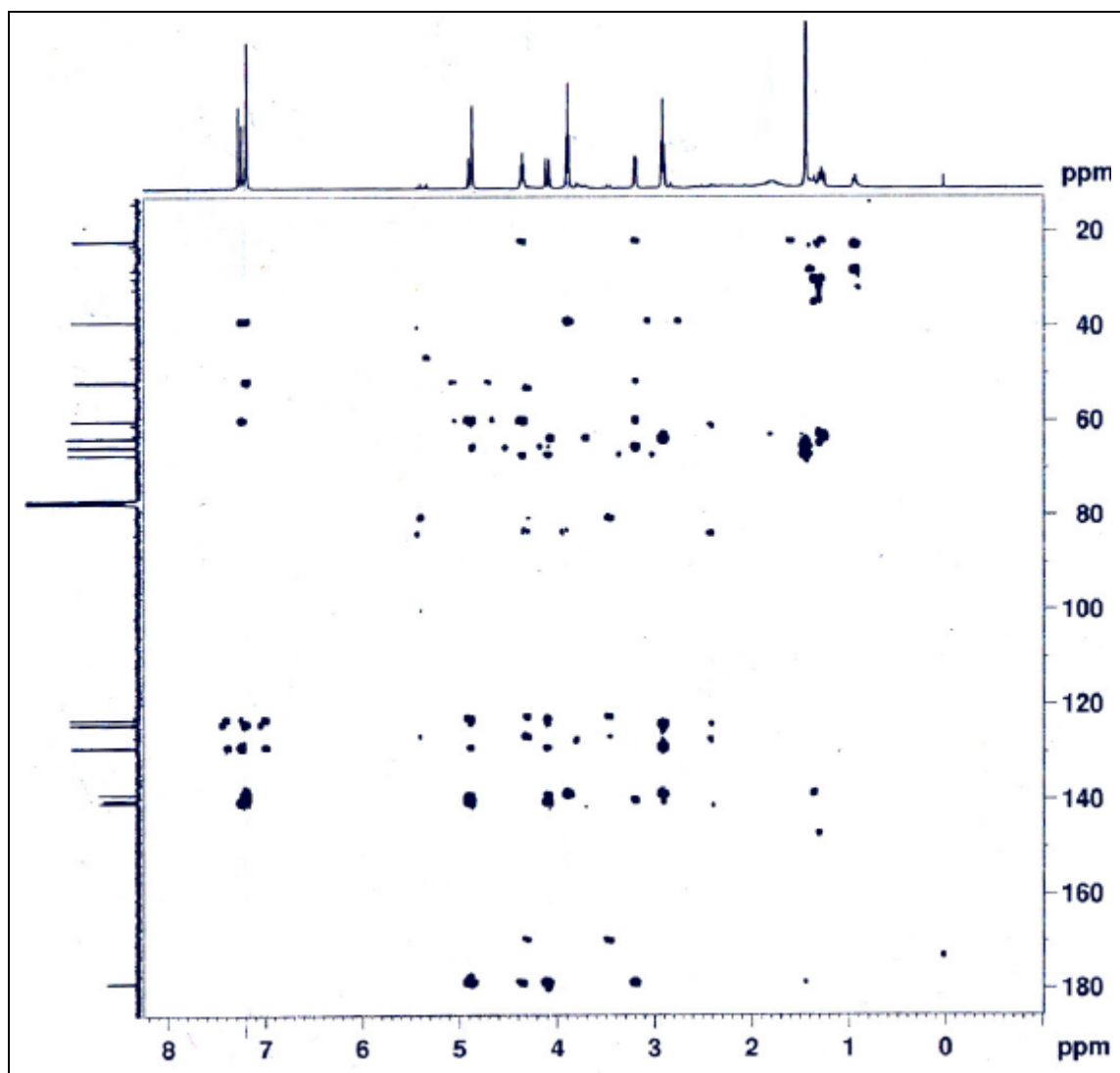
**¹H NMR Spectrum of 31 in CDCl₃****¹³C NMR Spectrum of 31 in CDCl₃**



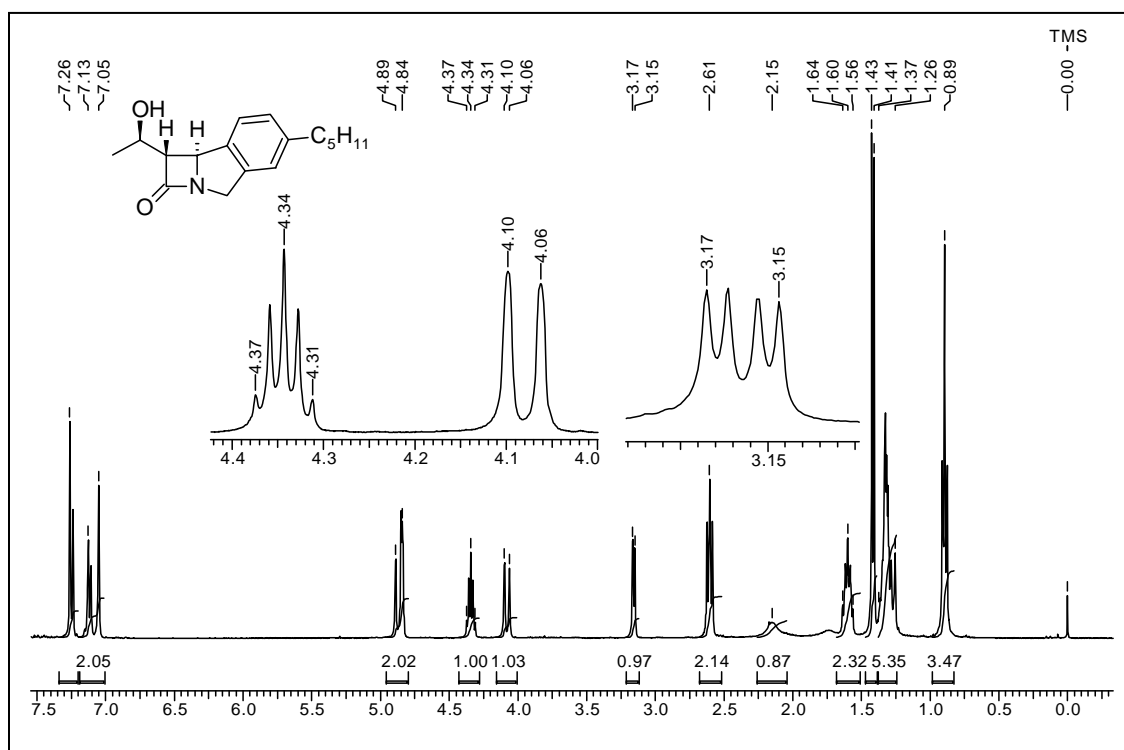
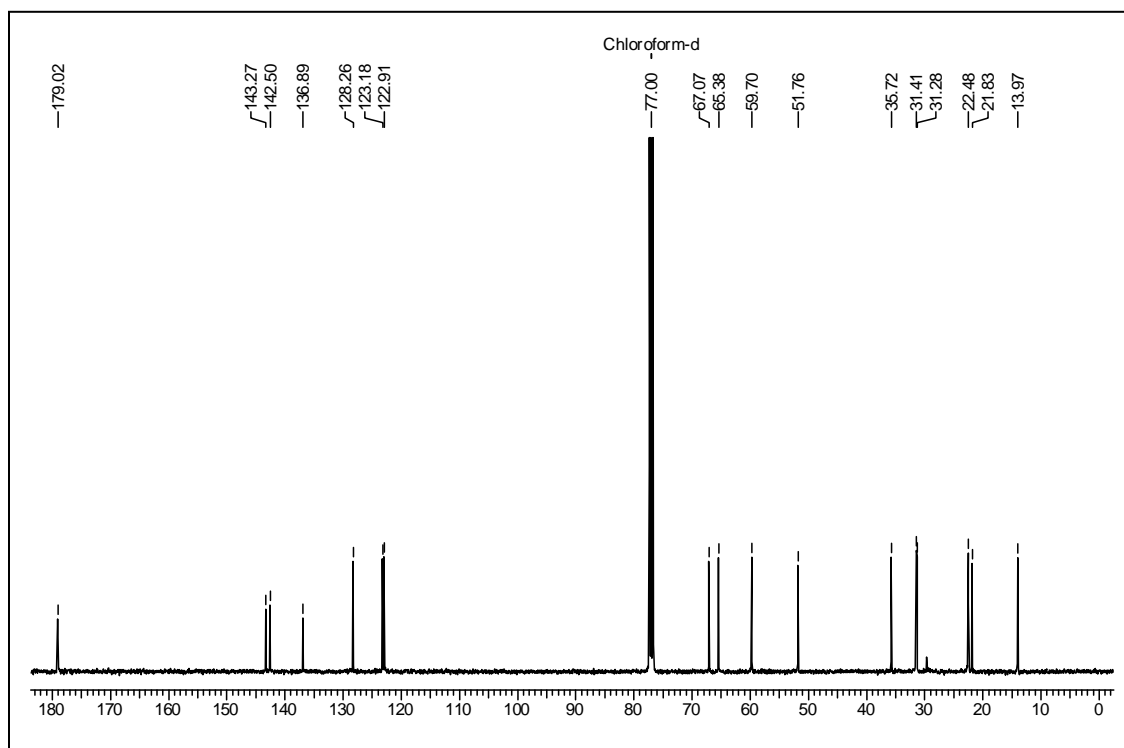
COSY Spectrum of Compound 31

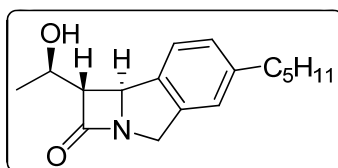
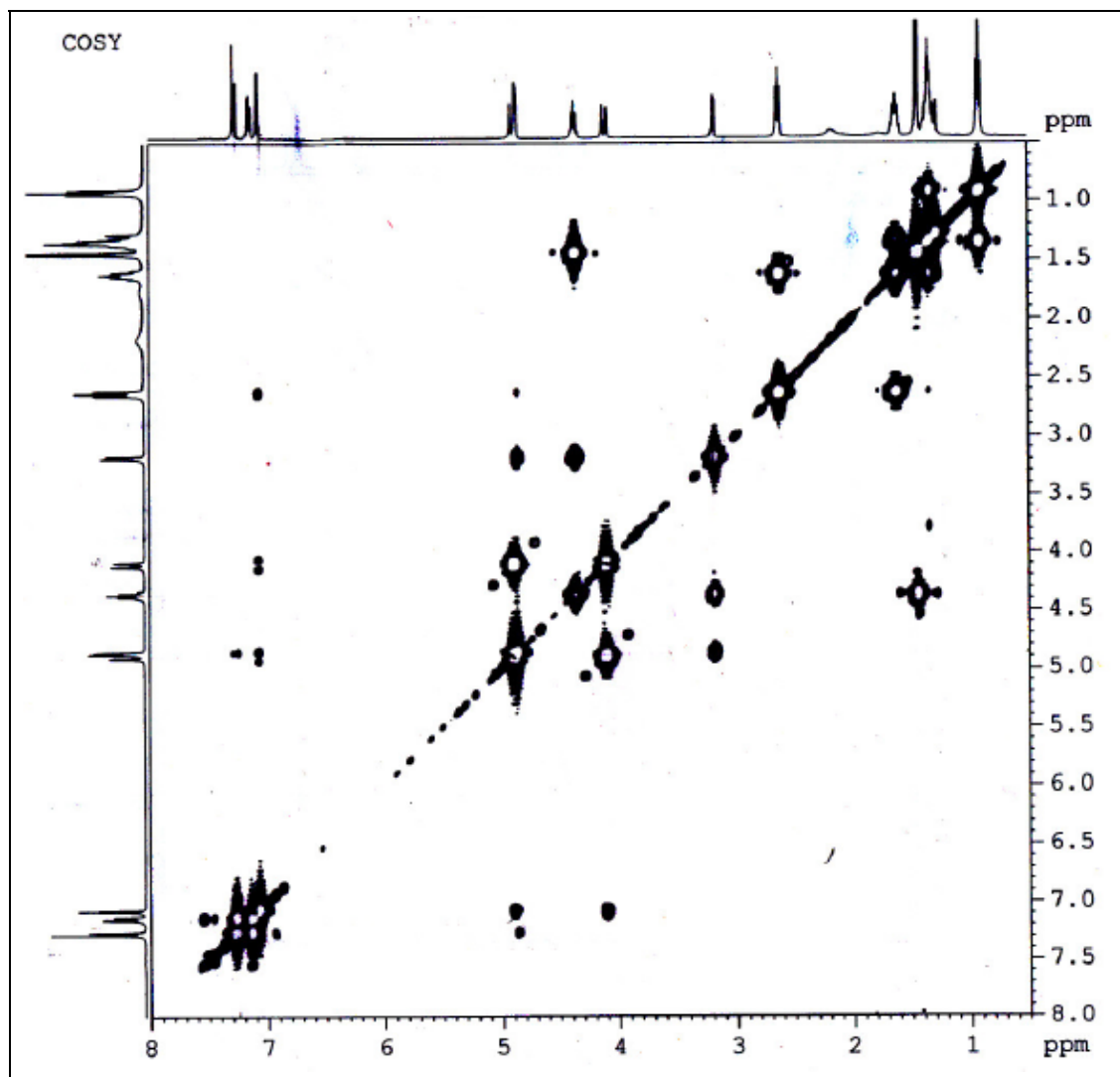


NOESY Spectrum of Compound 31

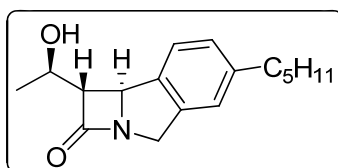
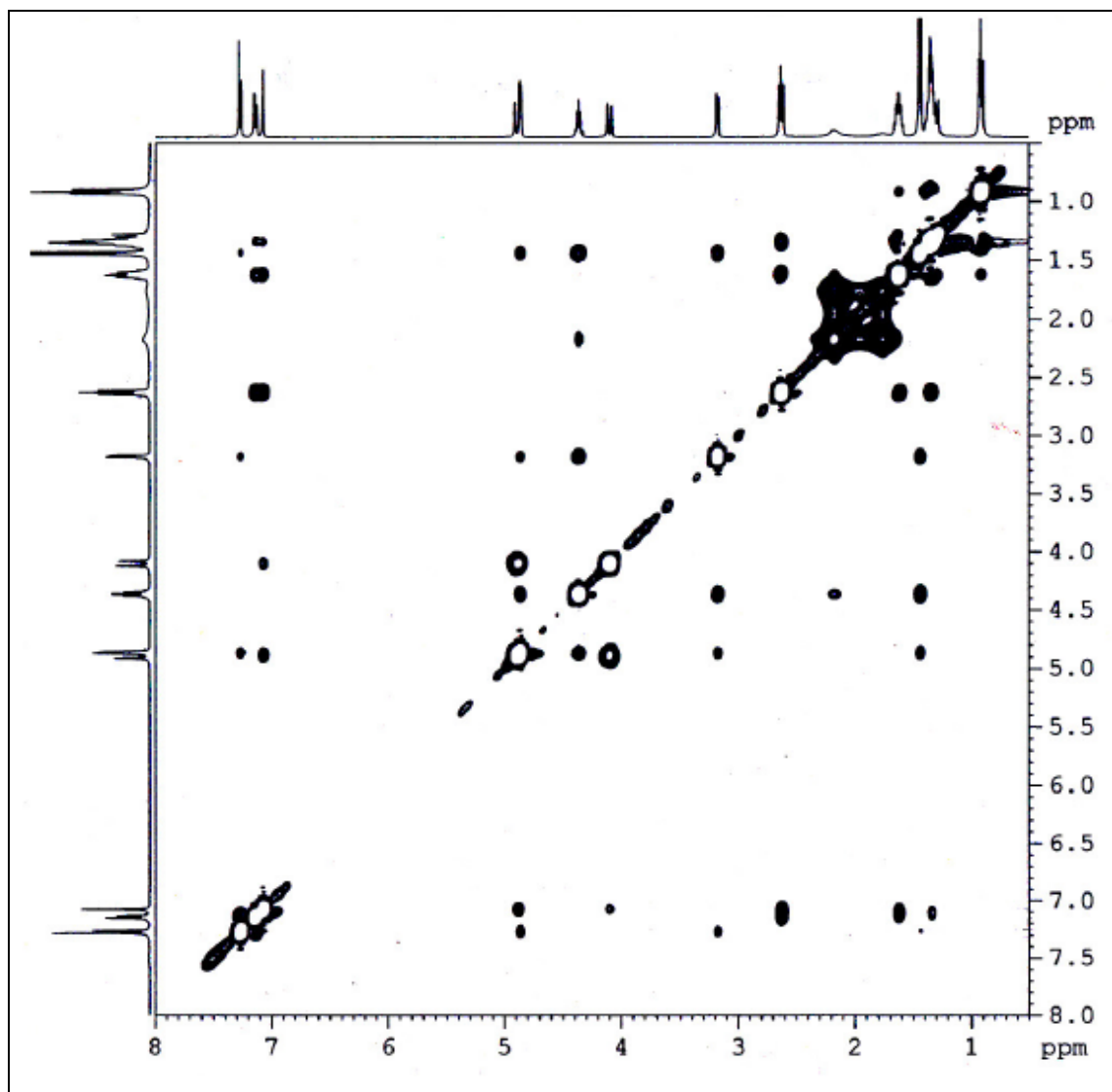


HMBC Spectrum of Compound 31

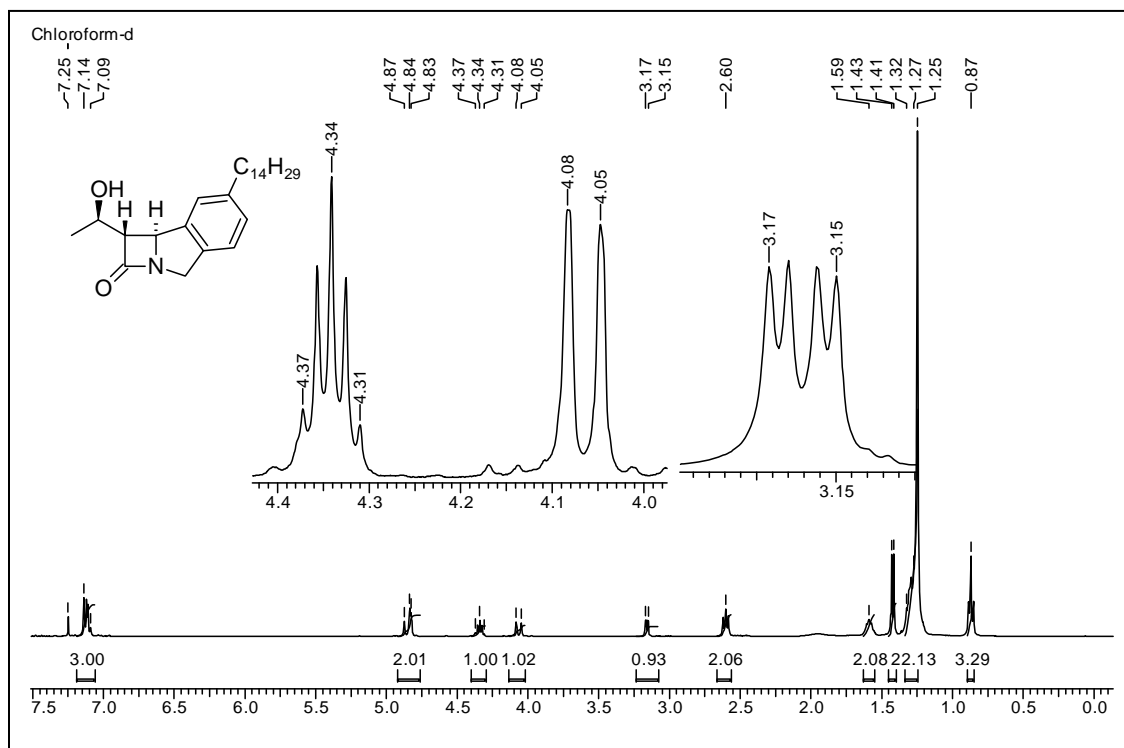
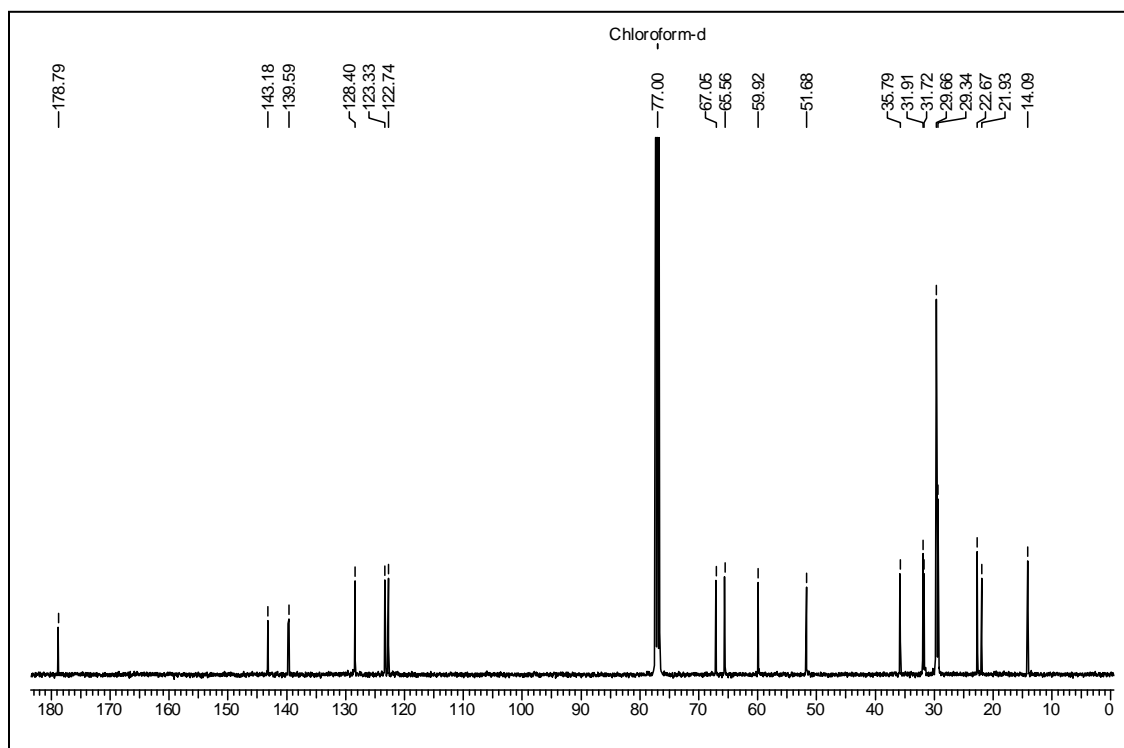
**¹H NMR Spectrum of 32 in CDCl₃****¹³C NMR Spectrum of 32 in CDCl₃**

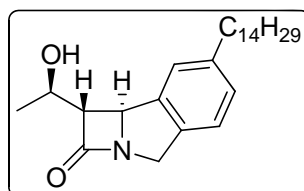
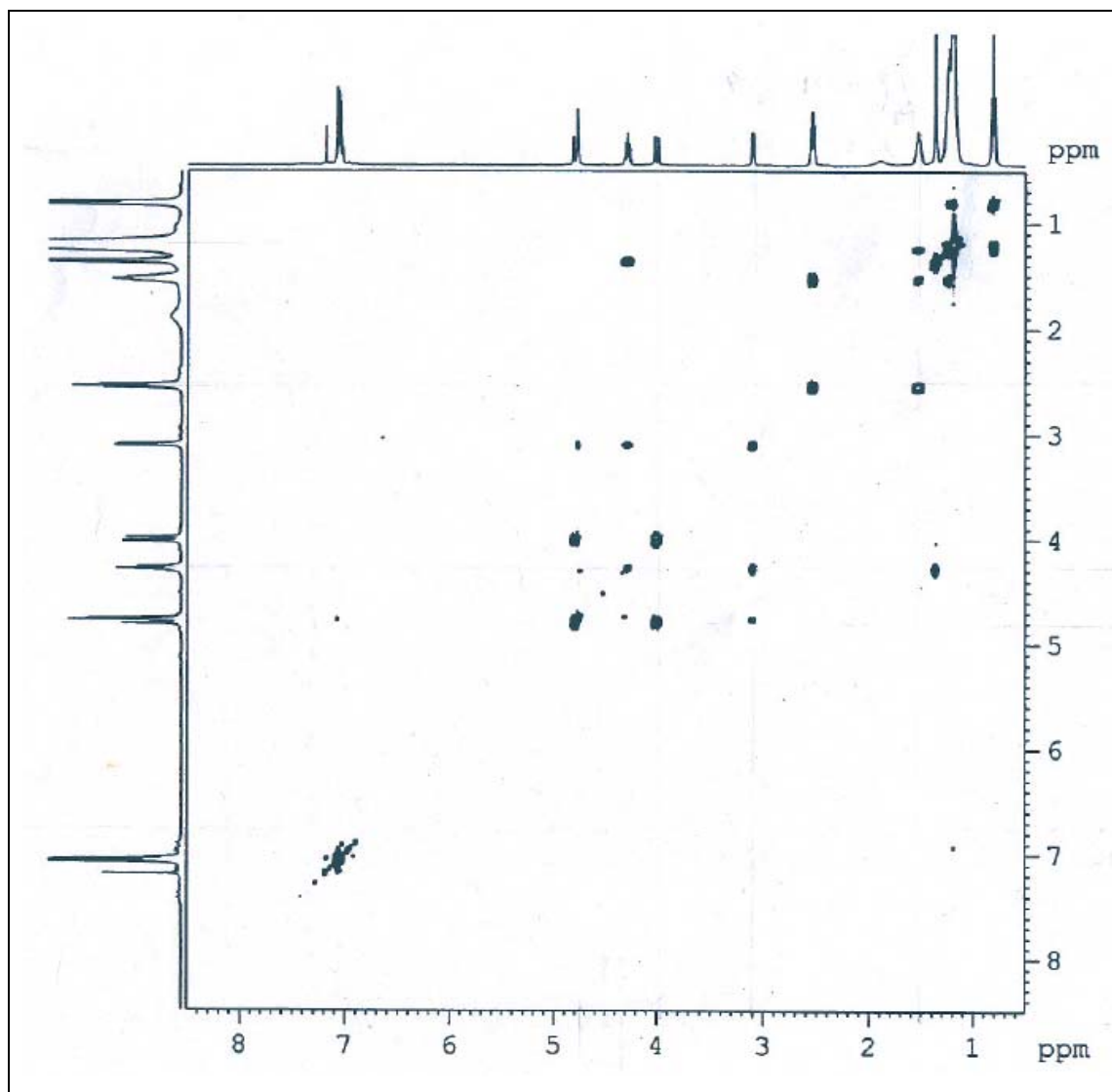


COSY Spectrum of Compound 32

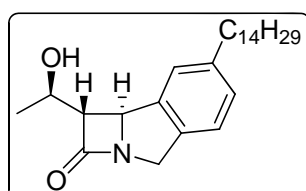
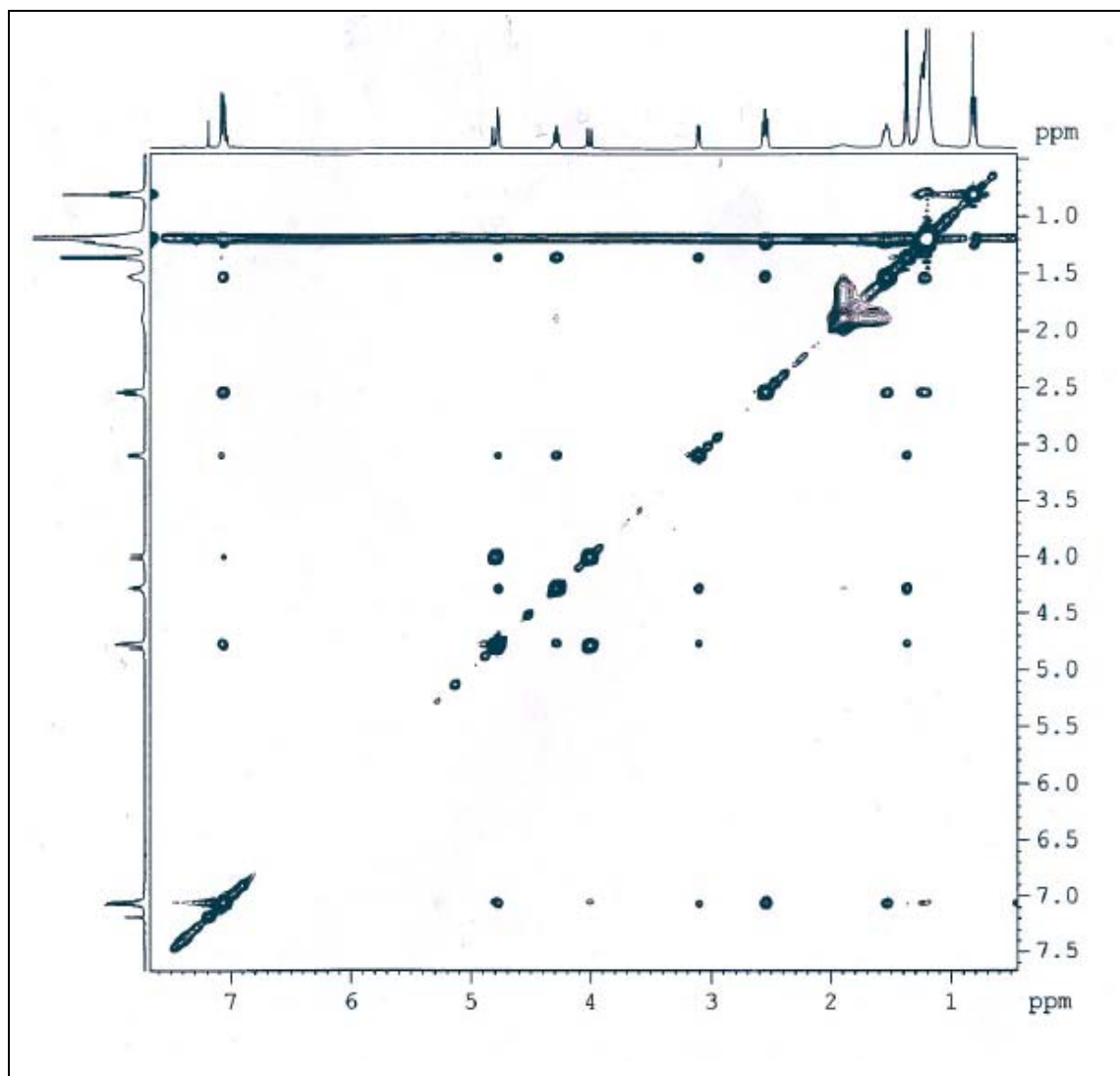


NOESY Spectrum of Compound 32

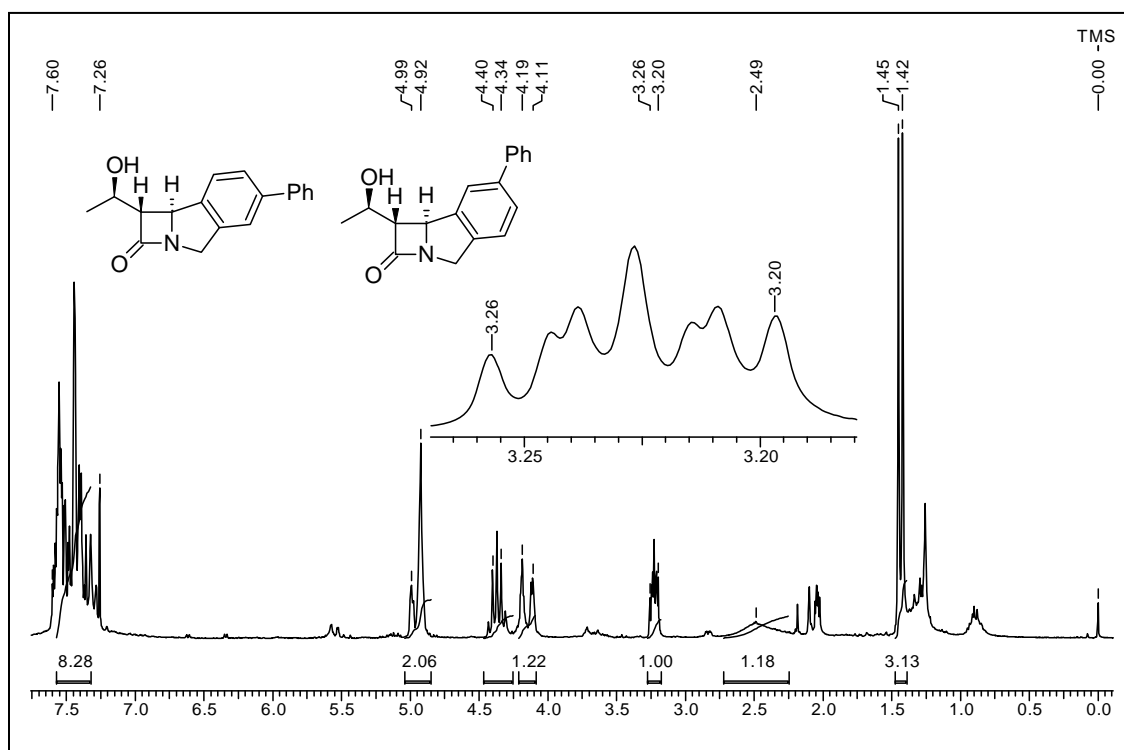
 ^1H NMR Spectrum of 35 in CDCl_3  ^{13}C NMR Spectrum of 35 in CDCl_3



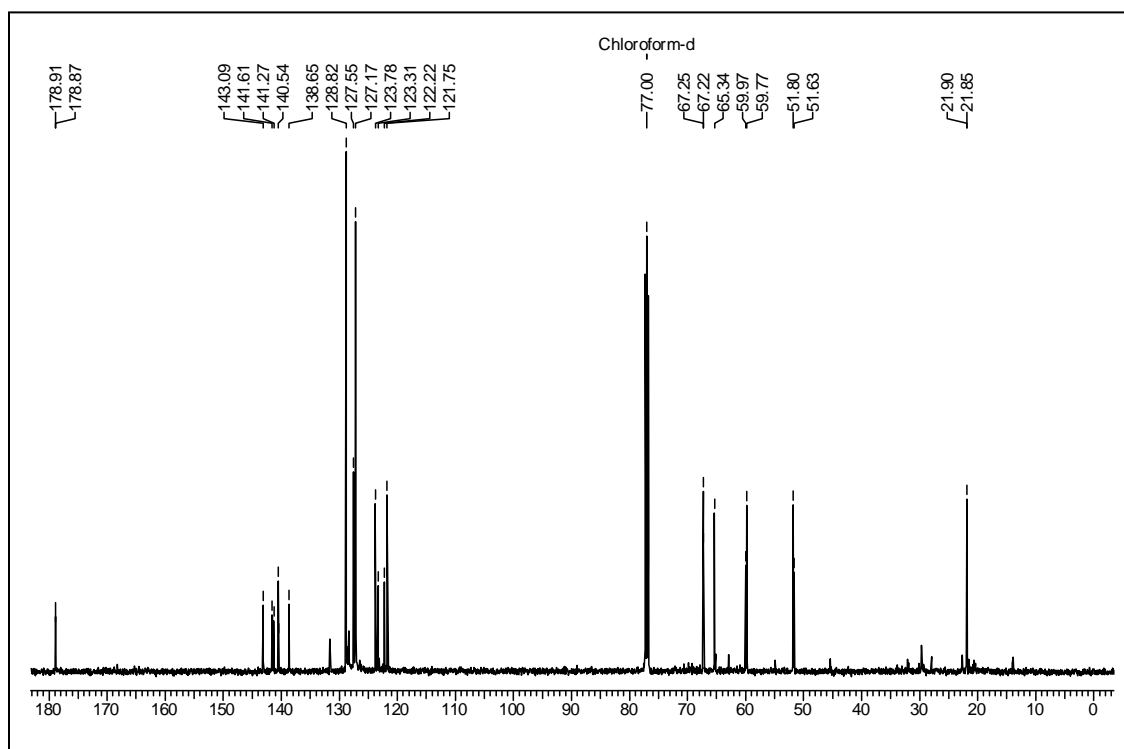
COSY Spectrum of Compound 35



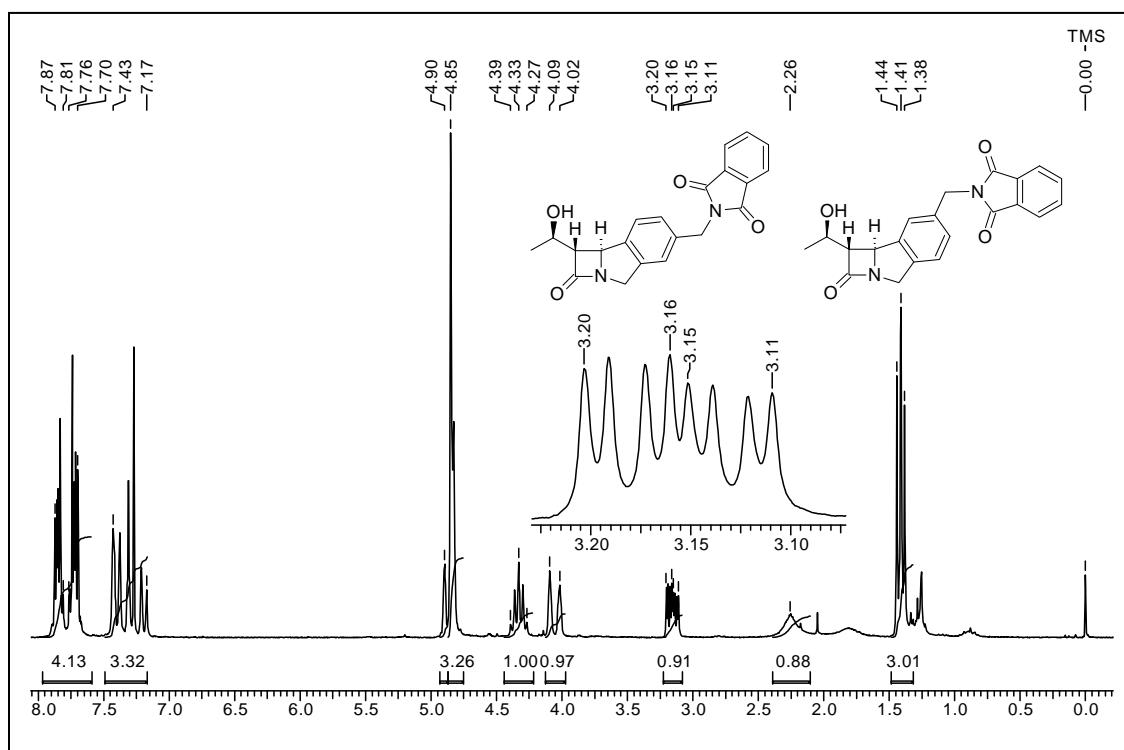
NOESY Spectrum of Compound 35



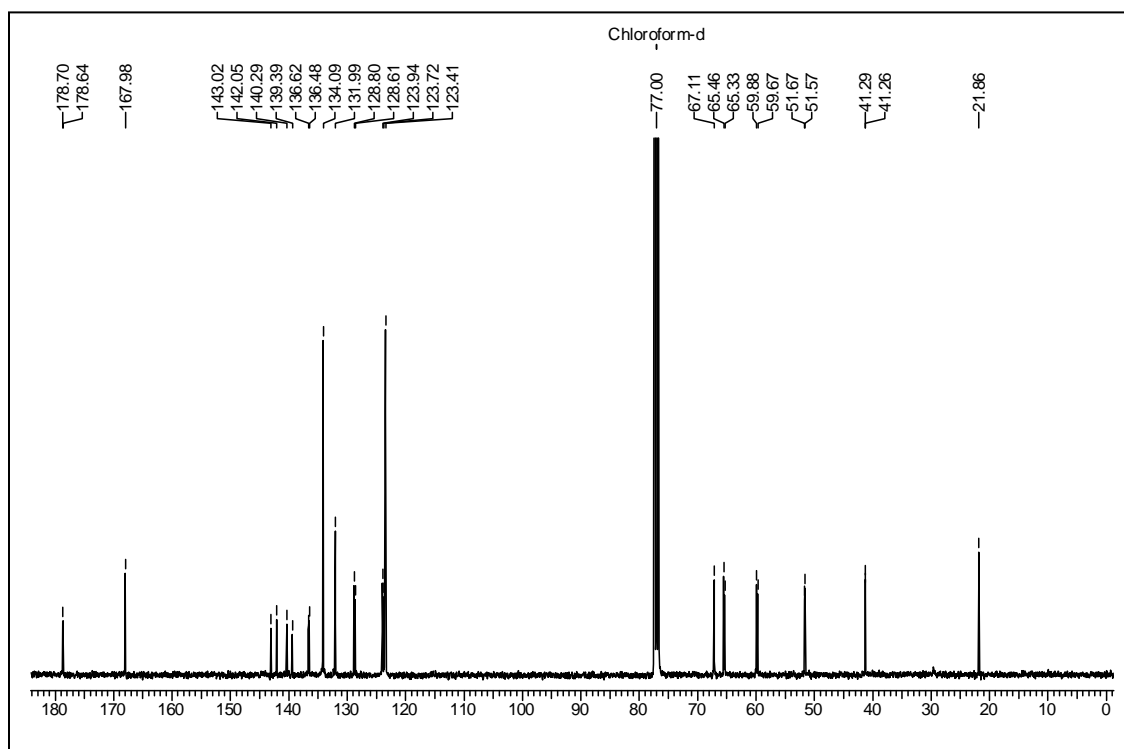
¹H NMR Spectrum of 36 and 37 in CDCl₃



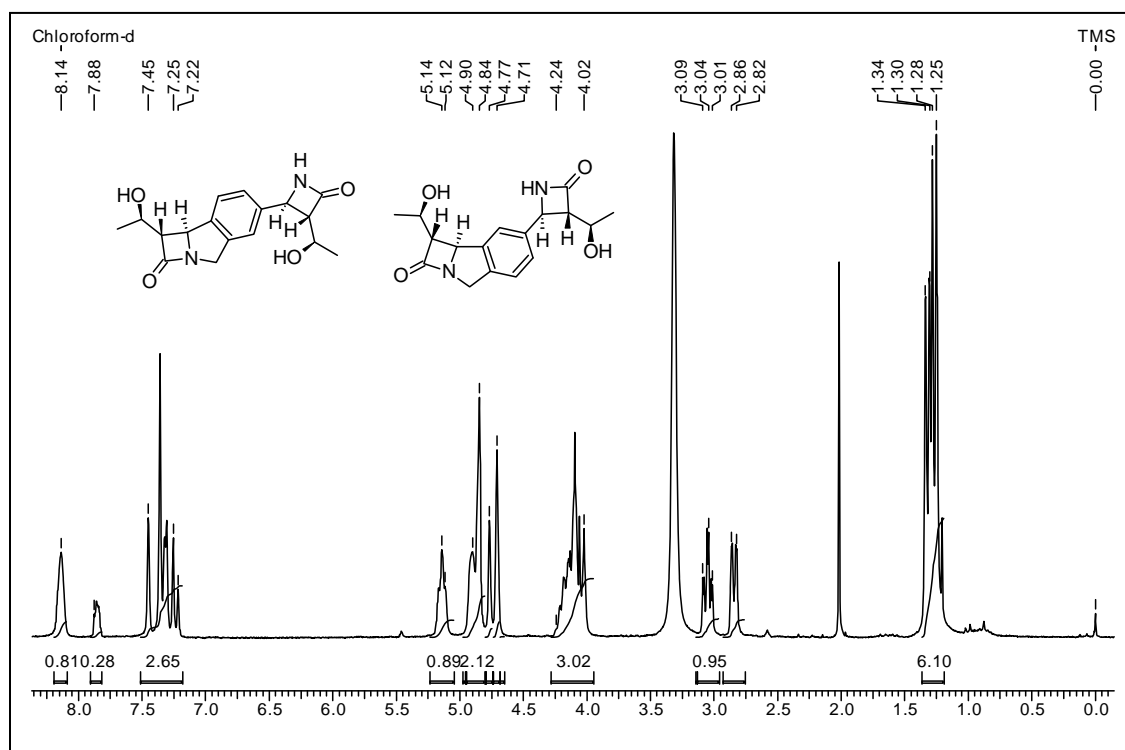
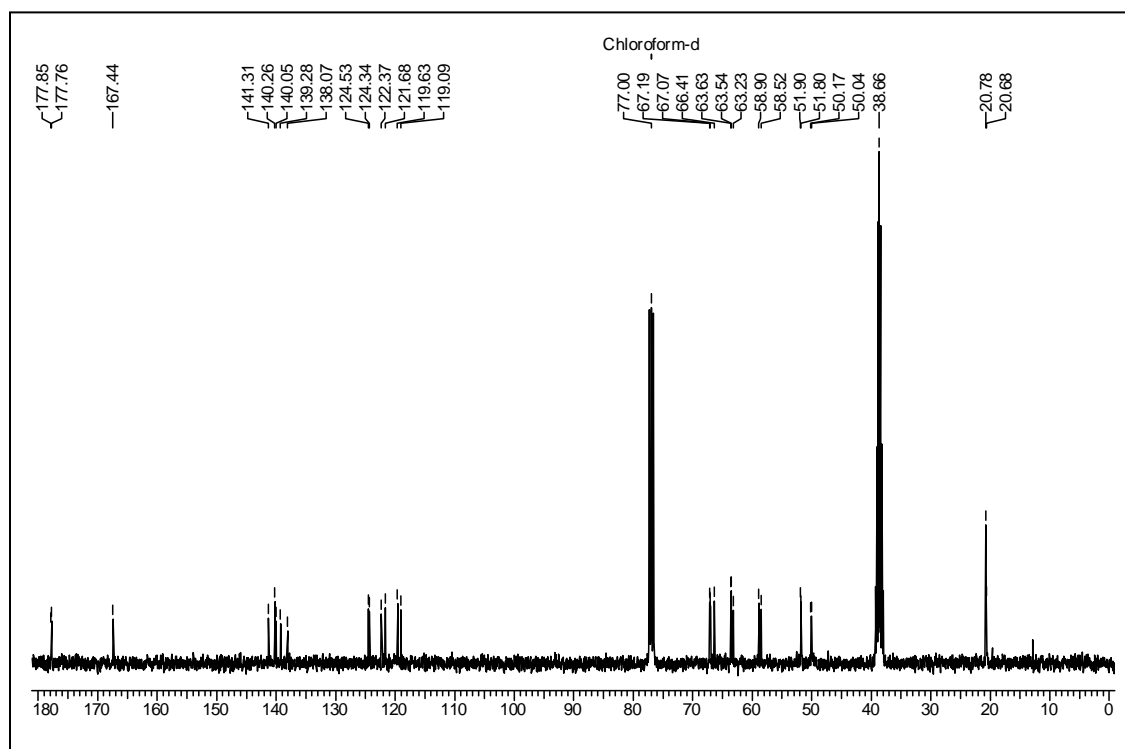
¹³C NMR Spectrum of 36 and 37 in CDCl₃



¹H NMR Spectrum of 38 and 39 in CDCl₃



¹³C NMR Spectrum of 38 and 39 in CDCl₃

 **^1H NMR Spectrum of 40 and 41 in CDCl_3**  **^{13}C NMR Spectrum of 40 and 41 in CDCl_3**

3.5 REFERENCES

1. (a) Dfirckheimer, W.; Blumbach, J.; Lattrell, R. and Scheunemann, K. H. *Angew. Chem.; Int. Ed. Engl.* **1985**, *24*, 180. (b) Fernandez-Lafuente R.; Mateo C.; Abian O.; Fernandez-Lorente, G.; Palomo, J. M.; Fuentes M.; Guisan, J. M. *Current Medicinal Chemistry - Anti-Infective Agents*, **2002**, *1*, 375. (c) Birnbaum, J.; Kahan, F. M.; Kropp, H.; MacDonald, J. S. *Am. J. Med.* **1985**, *78*, 3. (d) Blaszcak, L. C.; Eid, C. N.; Flokowitsch, J.; Gregory, G. S.; Hitchcock, S. A.; Huffman, G. W.; Mayhuhg, D. R.; Nesler, M. J.; Preston, D. A.; Zia-Ebrahimi, M. *Bioorg. Med. Chem. Lett.*, **1997**, *7*, 2261. (e) Uchida, K.; Matsubara, T.; Hirauchi, K. *Japan. J. Pharmacol.* **1989**, *50*, 283. (f) Milazzo, I.; Blandino, G.; Caccamo, F.; Musumeci, R.; Nicoletti, G. *J Antimicrob Chemother* **2003**, *51*, 721.
2. Nikaido, H. *Science* **1994**, *264*, 382.
3. (a) Venkatesan, A. M.; Agarwal, A. T.; Abe, H.; Ushiroguchi, I.; Yamamura, T.; Kumagai, P. J.; Petersen, W. J.; Weiss, E.; Lenoy, Y.; Yang, D. M.; Shlaes, J. L.; Ryan, Mansour, T. S. *Bioorg. Med. Chem.* **2004**, *12*, 5807. (b) Temime, L.; Boëlle, P.Y.; Courvalin, P.; and Guillemot, D. *Emerging Infectious Diseases* **2003**, *9*, 411.
4. Livermore, D. M.; Williams, J. D. *Antibiotics in Laboratory Medicine*, 4th edn, (Lorian, V., Ed), 502-578. Williams & Wilkins, Baltimore, MD.
5. Kahan, J.S.; Kahan, F. M.; Goegelman, R.; Currie, S. A.; Jackson, M.; Stapley, E. O.; Miller, T. W.; Miller, A. K.; Hendlin, D.; Mochales, S.; Hernandez, S.; Woodruff, H. B.; Birnbaum, J. *J. Antibiot. (Tokyo)* **1979**, *32*, 1.
6. Yamamura, N.; Imura-Miyoshi, K.; Naganuma, H.; Nishimura, K. *Drug Metab. Dispos.* **1999**, *27*, 724.
7. Edwards, J. R.; Turner, P. J. *J Antimicrob Chemother Suppl. A.* **1995**, *36*, 1.
8. Huber, J.; Dorso, K. L.; Kohler, J.; Kropp, H.; Rosen, H.; Silver, L. L. In *Program and Abstracts of the Thirty-Eighth Annual Interscience Conference on Antimicrobial Agents and Chemotherapy, San Diego, CA*, **1998**. Abstract 48-F, F-30, 240.
9. Woodcock, J. M.; Andrews, J. M.; Brenwald, N. P.; Ashby, J. P.; Wise, R. *J Antimicrob Chemother* **1997**, *39*, 35.

10. Tamura, S.; Miyazaki, S.; Tateda, K.; Ohno, A.; Ishii, Y.; Matsumoto, T.; Furuya, N.; Yamaguchi, K. *Antimicrob Agents Chemother.* **1998**, *42*, 1858.
11. (a) Copar, A.; Solmajer, T.; Anzic, B.; Kuzman, T.; Mesar, T.; Kocjan, D. *U. S. Patent 6,489,318 B1*, **2002**. (b) Vilar, M.; Galleni, M.; Solmajer, T.; Turk, B.; Frere, J. M.; Matagne, A. *Antimicrob. Agents chemother.* **2001**, *45*, 2215.
12. Hubschwerlen, C.; Charnas, R.; Heinze, I.; Gubernator, K. *U. S. Patent 5,712,268*, **1998**.
13. Christensen, B. G.; Heck, J. V.; Szymonifka, M. J. *U. S. Patent 4,374,848*, **1983**.
14. Fasoli, H. J.; Frau, J.; Fenollar-Ferrer, C.; Muñoz, F.; Donoso, J. J. *Phys. Chem. B* **2005**, *109*, 9780 and references therein.
15. Gaviraghi, G. *Eur. J. Med. Chem.*, **1995**, *30* (suppl.), 467s.
16. (a) Jackson, P. M.; Roberts, S. M.; Davalli, S.; Donati, D.; Marchioro, C.; Perboni, A.; Proviera, S.; Rossi, T. *J. Chem. Soc., Perkin Trans. 1*, **1996**, 2029. (b) Marchioro, C.; Pentassuglia, G.; Perboni, A.; Donati, D. *J. Chem. Soc., Perkin Trans. 1*, **1997**, 463.
17. Hanessian, S.; Griffin, A. M.; Rozema, M. J. *Bioorg. Med. Chem. Lett.*, **1997**, *7*, 1857.
18. Kinugasa, M.; Hashimoto, S. *J. Chem. Soc. Chem. Comm.*, **1972**, 466.
19. Shintani, R.; Fu, G. C. *Angew. Chem.; Int. Ed. Engl.* **2003**, *42*, 4082.
20. Desdoy, N.; Robert-Peillard, F.; Toueg, J.; Duboc, R.; Hénaut, C.; Rager, M. N.; Savignac, M.; Genêt, J. -P. *Eur. J. Org. Chem.* **2004**, 4840.
21. Odenholt, I.; Gustafsson, I.; Löwdin, E.; Cars, O. *Antimicrob Agents Chemother* **2003**, *47*, 518.
22. (a) Ramana, C.V.; Salian S.R.; Gonnade, R.G. *Eur. J. Org. Chem.* **2007**, 5483. (b) Ramana, C.V.; Suryawanshi, S.B. *Tetrahedron Lett.* **2008**, *49*, 445.
23. Reppe, W.; Schweckendiek, W. J. *Justus Liebigs Ann. Chem.* **1948**, *560*, 104.
24. Mori, S.; Iwakura, H.; Takechi, S. *Tetrahedron Lett.* **1988**, *29*, 5391 and references therein.

LIST OF PUBLICATIONS

1. "Palladium mediated cycloisomerization of sugar alkynols: synthesis of cyclic enol-ethers and spiroketals" C. V. Ramana, **Rosy Mallik**, Rajesh G. Gonnade and Mukund K. Gurjar *Tetrahedron Letters* **2006**, *47*, 3649–3652.
2. "The influence of electronic factors on palladium-mediated cycloisomerization: a systematic investigation of competitive 5-exo-dig versus 6-endo-dig cyclizations of sugar alkynols" C.V. Ramana, **Rosy Mallik**, Rajesh G. Gonnade *Tetrahedron* **2008**, *64*, 213–233.
3. *A Pd-mediated alkynediol cycloisomerization approach to the central [3,2,1]-bicyclicetal core of cyclodidemniserinol trisulfate* C. V. Ramana, **Rosy Mallik** (to be communicated).
4. *A [2+2+2] cyclotrimerization approach for the flexible synthesis of trinems.* C. V. Ramana, **Rosy Mallik**, Sradhanjali Mohapatra, Rajesh G. Gonnade (to be communicated).

Erratum
