SYNTHESIS OF THIAMBUTOSINE ANALOGUES

COMPUTERISED

TH-579

547.496.3
DEV

A THESIS
SUBMITTED TO
THE UNIVERSITY OF BOMBAY
FOR THE DEGREE OF
DOCTOR OF PHILOSOPHY
IN CHEMISTRY

BY **S. V. DEVASTHALE**

NATIONAL CHEMICAL LABORATORY POONA-411 008

**DEDICATED TO
MY PARENTS**

STATEMENT

No part of this work has been submitted for a degree or diploma or other academic work. The literature concerning the problem investigated has been surveyed and all the necessary references are given. The experimental work has been carried out entirely by me. In accordance with the usual practice, due acknowledgement has been made wherever the work presented is based on the results of the other workers.

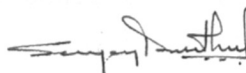

DEVASTHALE S.V.
Candidate



DR. S.N. KULKARNI
Research Guide

Date: 6-3-88

National Chemical Laboratory
Pune 411 008.

ACKNOWLEDGEMENT

The work presented in this thesis has been carried out under the valuable guidance of Dr. S.N. Kulkarni, Scientist E-II, Division of Organic Chemistry, National Chemical Laboratory, Pune. I take this opportunity to express my deepest sense of gratitude to him for his inspiring guidance throughout the work.

I record my sincere thanks to Dr. Malcolm Hooper, Professor of Medicinal Chemistry, Sunderland Polytechnic, U.K., whose interest and articulate thinking in the realm of Drug Design has formed the major basis for the investigation, described in this thesis.

I acknowledge with pleasure, the genuine help rendered by my friends and the personnel from Administrative and Analytical Departments of NCL, during the course of this work.

Finally, I wish to thank the Director, NCL, Pune for allowing me to conduct the work and to the CSIR (Delhi) for their financial assistance.

S. V. DEVASTHALE

NOTES

1. All solvents were distilled before use.
2. a) Infra-red spectra were recorded in Nujol on SP3-300-PYE-UNICAM spectrometer and the absorption values are reported in cm^{-1} .
b) PMR spectra were recorded in CDCl_3 (unless otherwise stated) on T-60 (Varian), FT-80A (Varian) and WH-90 (Bruker) spectrometers.
The chemical shift values (δ) are expressed down-field from TMS-used as an internal standard.
c) Mass spectra were recorded on AEI MS 30 and Finnigan MAT 1020-C double focussing spectrometer using a direct inlet system.
d) Melting points were recorded on Buchi Schmelzpunktbestimmungs apparatus.
3. Boiling points and melting points are uncorrected and refer to the oil bath temperature [in ($^{\circ}\text{C}$)].
4. a) The references are given at the end of each Section.
b) While discussing reviews and work in the thesis due credit has been given to the authors and their references have been appropriately noted whenever warranted. However any information if taken for granted and no accreditation is made, it is requested to view the same as completely unintentional.

CONTENTS

	<u>Page No.</u>
1.0-0 GENERAL INTRODUCTION	1
1.1-0 Antituberculosis Compounds Containing Sulfur	9
1.2-0 Thioureas as Antituberculosis Compounds	12
1.3-0 QSAR and Hansch Analysis	21
1.4-0 Present Investigation	30
1.5-0 References	33
 SYNTHESIS OF THIOUREAS WITH SUBSTITUTED AMINO ACIDS AROMATIC AND HETEROCYCLIC AMINO COMPOUNDS WITH OR WITHOUT CARBOXYLIC ACID GROUPS 	
2.0-0 INTRODUCTION	39
2.1-0 Preparation of p-Alkoxy Anilines	43
2.2-0 Preparation of Substituted Phenyl Isothiocyanates from Various Substituted Anilines	49
2.3-0 Condensation of Substituted Phenyl Isothiocyanates with Various Amino Acid, Aromatic/Heterocyclic Amino Compounds with or without Carboxylic Acid Group	62
2.4-0 Mass Spectral Studies of p-(n) – Butoxy Phenyl N’-Substituted Acid, Thioureas	78
2.5-0 Experimental	89
2.6-0 References	113
 SYNTHESIS OF THIOUREAS WITH ACETYLINIC SIDE CHAIN 	
3.0-0 INTRODUCTION	118
3.1-0 Preparation of p-Substituted Anilines	127
3.1-1 Synthesis of methyl-4-(p-amino- phenyloxy)-but-2-ynoate	128
3.2-0 Preparation of p-Substituted Isothio- cyanates	146
3.3-0 Condensation of Various p-Substituted Phenyl Isothiocyanates with Methyl- 4-(p-Aminophenyloxy)-but-2-yne-oate	148

	<u>Page No.</u>
3.4-0 Experimental	158
3.5-0 References	176
 SYNTHESIS OF THIOUREAS WITH 3-DIALKYL AMINO- 2-HYDROXY PROPOXY SIDE CHAIN	
4.0-0 INTRODUCTION	179
4.1-0 Preparation of Various Substituted Amino	182
4.2-0 Preparation of Substituted Phenyl Isothiocyanates	
4.2-1 Preparation of p-n-butoxy- Phenyl isothiocyanate and p-N,N-dimethylamino phenyl isothiocyanate	184
4.2-1 Synthesis of 4-[2-acetoxy-3- N,N-dimethylamino propyloxy]- phenyl isothiocyanate	192
4.3-0 Condensation of 4-(2-acetoxy-3- diethylamino -1-propoxy) aniline with Various p-Substituted Phenyl Isothiocyanates	192
4.3-1 Condensation of 4-(2-acetoxy- 3-diethylamino-1-propoxy) phenyl isothiocyanate with various amines	192
4.4-0 Experimental	215
4.5-0 References	237
5.0-0 TESTING FOR ANTITUBERCULAR ACTIVITY	239

1-0.0 GENERAL INTRODUCTION

The compounds synthesised in the present work may possibly serve as a new class of compounds having antitubercular activity. Hence it is the purpose of this introduction to describe the nature and chemotherapy of tuberculosis.

Even today tuberculosis ranks high among the causes of death. According to Soper¹, tuberculosis is "the most widespread of human ills, persistent with the longest period of infectivity". It is number one killer of mankind in the world as a whole. The symptoms of the disease are the formation of tubercles in the tissues and is manifested symptomatically in the pulmonary form by fever, cough and progressive loss of weight. The causative agent, first isolated by Koch² in 1882 is a fungus like bacterium known as Mycobacterium tuberculosis. This organism is having the ability of infecting practically any tissue or organ of the body. In India, tuberculosis is a leading problem. About 10 million people are suffering from tuberculosis of which 2.5 million are active cases. In addition 2.5 million fresh cases are reported every year in which half a million die every year.

The treatment of tuberculosis is complex in nature because of the underlying pathological anatomy and physiology of the disease, persistence of the causative organism

and the variable and often inadequate defence mechanism of the host. The disease is characterised by the formation in the tissues of nodular bodies or tubercles (hence tuberculosis) and is manifested symptomatically in the pulmonary system or by fever, cough and progressive loss of weight. The organism has the unhappy ability to infect any tissue of the body, since it can enter the body of the host through inhalation or ingestion so that in addition to common pulmonary tuberculosis, there is tuberculosis laryngitis, osteomyelitis, meningitis and host of others including the rapidly fatal form known as miliary tuberculosis.

The mycobacterial diseases are the most protracted of all infections and require a long therapy (3-6 days for bacterial pneumonia and 540-730 days or more for tuberculosis and leprosy). The notable difference between mycobacterial and common bacterial infection is that in common bacterial infection, the invading organisms multiply rapidly and induce a sharp defensive reaction on the part of the host. The process is very acute, fulminating and usually of short duration. If the invading organisms overwhelm the host's defences, the host dies. The outcome is thus determined quickly. The tubercle bacillus on the other hand is a slow growing organism which does not elicit a sharp and massive reaction from the host. Upon gaining

entrance in an uninfected host, it multiplies until sufficient resistance is developed to bring the infection to a halt. The organisms then lie dormant and the clinical symptoms of tuberculosis may not appear again unless the organisms are reactivated.

Considering the factors that have made tuberculosis one of the most difficult of the bacterial diseases to treat chemotherapeutically, has led to the search for new potential tuberculostats. The drug to be effective as tuberculostat, should have the usual attributes of high toxicity for the tissues and organisms of the host. Moreover, it should be able to penetrate the barriers interposed between the tubercle bacilli and the host including the cell walls of macrophage, spitheloid and giant cells. Finally, because even under the most propitious circumstances, the drug would have to be used for a long time, it should be slow in producing resistant strains.

The ideal chemotherapeutic agent should be able to eradicate the tubercle bacilli completely, or inhibit the bacteria for a period sufficiently long to allow the patients defences to eliminate them and should be free from undesirable side effects.³

Chemotherapy of tuberculosis is being practised since last 2000 years. However the therapy was based more on desperation than on scientific data. Upto 1936,

inorganic salts viz. copper, manganese and gold salts; organic compounds like camphor, cinnamic acid, ethyl stearate and natural products like quinine, codliver oil, chaulomogra oil were commonly used for the treatment. The older drugs have been reviewed by Long.³

The chemotherapy of human infectious diseases first became a practicality in 1909 with Ehrlich's discovery of arsphenamine. Rich and Follis⁴ observed that large doses of sulphanilamide are effective against tuberculosis in rabbit. Rist et al.⁵ showed that 4,4'-diamino diphenyl sulphone (DDS) was better than sulphonamides.

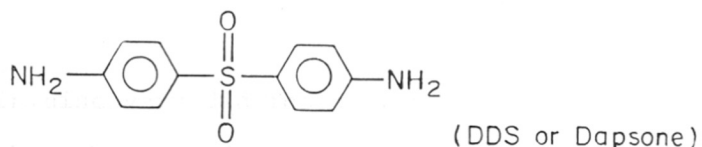

The fact that DDS was later found to be toxic, marked for the beginning of the intensive efforts to prepare the derivatives of DDS with reduced toxicity, but in which the activity would be retained. Impetus was given to this search by independent announcements in 1939 and 1940 of the tubercular therapeutic effect of DDS⁶⁻⁸ and its glucose bisulfite derivative "Promin"⁹

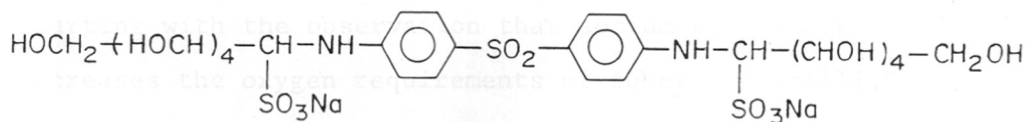

PROMIN

The sulphones are at present the most effective drugs known for the treatment of leprosy and DDS may be alternative drug in tuberculosis.

With the advent of streptomycin by Waksman¹⁰ in 1944 with its greater effectiveness both in experimental and clinical tuberculosis, attention rapidly turned away from sulfones. However equivocal the effect of sulfones in clinical tuberculosis may be, interest in these compounds led to their application in the related disease leprosy. Demonstration that Promin brought about increase survival of rats infected with murine leprosy was followed quickly by investigating in human with distinct success and today the sulfone drugs are a recommended treatment of this disease.

Streptomycin discovery did indeed represent a major advance in the chemotherapy of tuberculosis since the drug is effective in a variety of tuberculosis conditions but also reasonably safe. However, side effects were frequently observed on continued usage which soon became apparent that streptomycin could produce toxic effects. Dihydrostreptomycin, a derivative of streptomycin was suggested as an alternative, which ultimately proved to be more toxic.

In 1944, on the culmination of about six years work, starting with the observation that sodium salicylate increases the oxygen requirements of tubercle bacilli,¹¹

it was announced by Lehmann¹² that the synthetic compound PAS (p-amino salicylic acid) was effective against tuberculosis. It has now been widely accepted as a clinically

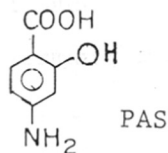

useful tuberculostat. Though its activity is moderate, it is more acceptable because of its low toxicity even at high dosage levels. The major disadvantage with PAS is its rapid absorption in the body and excretion so that to maintain adequate blood levels, larger doses at frequent intervals are recommended. The drug is orally administered in the form of its sodium or calcium salt.

The spectacular advance in the chemotherapy of tuberculosis can be attributed to the discovery of INH (isonicotinic acid hydrazide) in early 1951 by three separate groups of investigators simultaneously at three different centres.^{13,14}

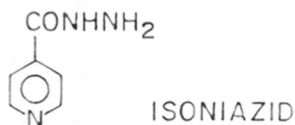

After considerable documentation, this momentous discovery was made public in February 1951. INH is now a drug of choice as it is found to be more potent than any other drug discovered so far. At first INH was administered as such because of its high potency against tuberculosis, but soon it became obvious that it was undesirable because of

development of resistant strains. It is therefore given generally in combination with PAS or streptomycin. Domagk¹⁵ showed that thio semicarbazones were active in experimental tuberculosis, out of which thioacetazone (T.B.1) was extensively investigated in Germany and U.S. but was found to be relatively toxic. Hence, there is need for continued search for new chemotherapeutic agents.

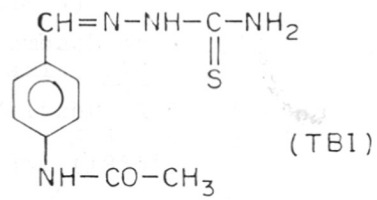

Reserve drugs for treatment of tuberculosis:

Reserve drugs are used for the treatment of patients whose previous chemotherapy has failed or whose organisms are known or suspected of being resistant to the standard drugs (INH, PAS and streptomycin). In addition they may be used to replace standard drugs which cannot be continued because of toxicity or hypersensitivity.

A brief list of such drugs is given below:-

Sr.No.	Name of drugs	References
1.	Neomycin	Waksman, S.A. and Lechevalier, H.A. Science, <u>109</u> , 305 (1949).
2.	Macrocydon	Cornforth, J.W., Hart P.D'Arcy; Rees, R.J. and Stock, J.A. Nature(Lond), <u>168</u> , 150 (1951).
3.	Pyrazinamide	Kushner, S. et al. J. Am. Chem. Soc., <u>74</u> , 3617 (1952).

Sr.No.	Name of drugs	References
4.	N-N' Phthalyl-hydrazine	Jouin, J. and Buu-Hoi, N.P., Ann. Inst. Pasteur., <u>72</u> , 580 (1954).
5.	Oxytetracyclin	Rothstein, E. and Johnson, M., Am. Rev. Tuberc., <u>69</u> , 65 (1954).
6.	Ethionamide	Gardner, T.S., Wenis, E. and Lee J., J. Org. Chem., <u>19</u> , 753-57 (1954). Gumbach et al., C.R. Acad. Sci. Paris, <u>242</u> , 2187 (1956). Meltzer, R.I., Lewis, A.P. and King J.A., J. Am. Chem. Soc., <u>77</u> 4062 (1955).
7.	Cycloserine	Stammer, C.H. et al., J. Am. Chem. Soc., <u>77</u> (Part-II), 2345-46(1955).
8.	Viomycin	Barts, etl al., Farmaco. Ed. Sci., <u>16</u> , 165 (1961). Antibiotics Annual, 262-70 (1959-1960). Phillips, S. and Larkin, J.C. Am. Rev. Tuberc., <u>72</u> , 834 (1955).
9.	Streptovaricin	Rhuland, L.E., Stern, K.F. and Reames, H.R., Am. Rev. Tuberc. <u>75</u> , 588 (1957).
10.	Phenazines (B. 663 and B. 770)	Brown and Hoquerzeil, Leprosy, <u>33</u> , 6-10 (1962).

Ethambutol and its analogues

During screening of the compounds at random against experimental tuberculosis in mice, N,N'-diisopropyl ethylene diamine¹⁶ was found to be antimycobacterial in vitro and in vivo but its comparatively high toxicity and low activity prevented its use as a tuberculostat.



Further research work on the structural modification of this compound led to the discovery of one of the most potent and currently widely used antituberculosis compound viz. N,N'-bis (1-hydroxy-2-butyl)ethylene diamine dihydrochloride (Ethambutol, Myambutol).¹⁷

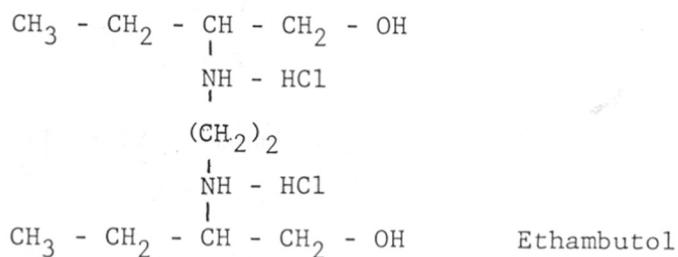

The activity of ethambutol is characterized by its remarkable structure and stereospecificity. It has been shown to be effective against strains of M. tuberculosis resistant to other antimycobacterial agents used for initial treatment. It is also indicated for patients where toxicity or hypersensitivity prevents the use of standard drugs.

1-1.0 ANTITUBERCULOSIS COMPOUNDS CONTAINING SULFUR

(a) Domagk¹⁵ had investigated a number of sulfonamides and related compounds during the second world war, devised in Germany a number of thiosemicarbazones of benzaldehyde prominent amongst which were:

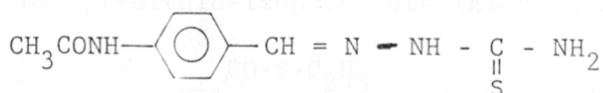

Thiacetazone [TB 1/698, Domagk]

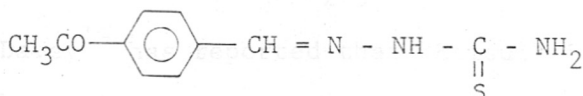

[TB 2/242, Schmidt]

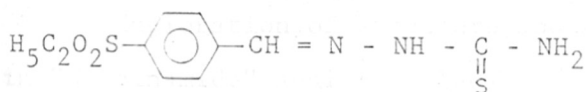

[TB 3/1347, Behmisch]

Ethiadone

Thiacetazone [TB 1] was investigated extensively in Germany and later in the United States but it was found to be relatively toxic. More recently, the need for drugs other than PAS for use in combined therapy with INH has revived interest in thiacetazone. This may also be partly due to its simple constitution, relative ease and cheapness of manufacture.

(b) Mercaptans and their derivatives

The antituberculosis activity of the member of this series in vitro has been reported by Meyer¹⁸ and most active compounds were mercaptothiazoles. Davey and Driver¹⁹ established the fact that any compound capable of releasing ethyl mercaptan in vivo has antituberculosis activity and the most suitable for human therapy being

diethyl-dithio-isophthalate (ETIP, Etisul)

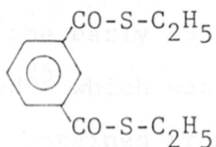

Davey¹⁹ has reported that "Etisul" is also active in human leprosy.

(c) Thio acid amides

Exploration of structure and activity relationship in "Niacinamide" analogues led to the discovery of "thioisonicotinamide" as a potential tuberculostat by three groups of research workers.²⁰⁻²² It is reported to be active against both isoniazid resistant and isoniazid susceptible bacilli.²³ Its toxicity is relatively low in animals but not suitable for human therapy. The 2-ethyl and 2-n propyl derivatives of thioisonicotinamide are reported to be more active than the parent compound.²⁴

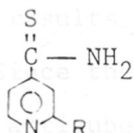

R = H (Thioisonicotinamide)

= C₂H₅ (Ethionamide)

= n-C₃H₇ (Prothionamide)

1-2.0 THIOUREAS AS ANTITUBERCULOSIS COMPOUNDS

In the early 1920's, a remedy for tuberculosis was patented²⁵ which was described as the gold salt of the product obtained from the reaction of an alkali or alkaline earth hydroxide with an amino acid or an ester of an amino acid, i.e. a salt such as $(\text{KOOOC}-\text{CH}_2-\text{NHCS}_2)_3\text{Au}$. This followed considerable work with gold compounds as chemotherapeutic agents for tuberculosis. However it was not until many years later that thioureas, which can also be prepared from carbon disulphide and an amine in presence of alkali, were considered for the treatment of this disease.

In 1944 a patent²⁶ was issued for copper compounds made from thioureido benzoic acids which were said to be active in tuberculosis. Since tubercle bacilli contain large amount of lipid oil tissues, long chain, alkyl thioureas which are lipid soluble, were suggested by Massie²⁷ as therapeutic agents. Chilian workers^{28,29} have reported some favourable results using thioureas itself for tuberculosis. Since then many thiourea derivatives have been tested for antitubercular activity and some of them did look promising in vitro studies.³⁰⁻³⁵

The antimicrobial activity of thiourea was described by Mayer in 1941. This activity of thiourea is enhanced by appropriate substitution as in alkyl thiourea and especially in para-amino benzene sulfonyl thiourea.³⁶

Thiocarbanilides

In 1952, a number of thiocarbamido derivatives of PAS in vitro tests were found to be equal or more than the PAS itself³⁷⁻³⁹. Maximum activity was achieved in the compound of the following type where R was aromatic.

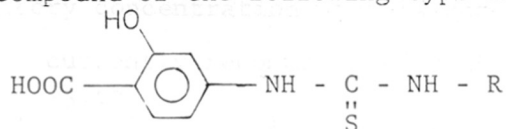

If R was aliphatic, the activity dropped or it completely disappeared. This compound with -R being a benzene ring found to prolong life in animal studies, but it did not produce a complete cure.

In a group of new thioureas viz. p-p'-disubstituted thioureas, the thiocarbanilides were found to be more potent antitubercular agents⁴⁰ amongst which 4,4'-diethoxy thiocarbanilide found to possess high activity in mice infected with bacillus H₃₇Rv⁴¹ strain. This observation led to considerable work on thioureas and over 300 thiocarbanilides were prepared and tested in vitro and in vivo in experimentally infected mice. Some of the more active compounds were subject to tests in guinea pigs⁴² and 4-ethoxy-4'-isobutoxythiocarbanilide and 4-butoxy-4'-dimethylaminothiocarbanilide (Thiambutosine) exceeded the activity of PAS and streptomycin and approached that of isoniazid. Mayer and co-workers⁴³ of the Division of Microbiology (CIBA Pharmaceutical Products Inc., N.Y.)

further screened in vivo large number of compounds and confirmed that 4-4'-diethoxythiocarbanilide [Ethoxyd] had high antituberculosis activity in mice infected with H₃₇Rv strain. Fuji et al.⁴⁴ confirmed that minimum inhibitory concentration of this compound was 0.4 mcg/ml. This is currently recommended for use in the treatment of leprosy.⁴⁵⁻⁴⁷

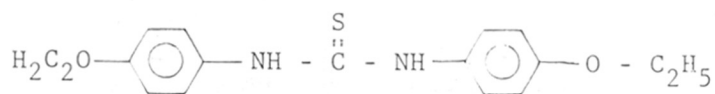

Ethoxyd

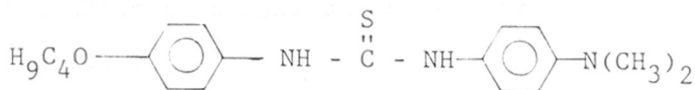
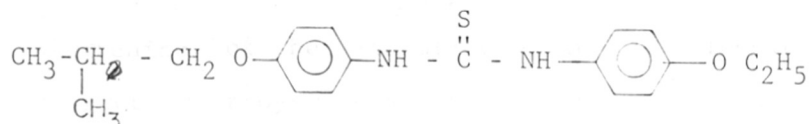

Thiambutosine

One striking correlation between the activity of these compounds in vitro and in vivo is emphasizing the importance of the latter types of tests in search of new chemotherapeutic agents.

Buu Hoi and associates claim that antituberculosis activity of thiocarbanilides is due to their ability to form stable complexes with heavy metal and the thiourea portion is responsible to achieve this activity. The compound also must have such physical characteristics that

or the activity.

the coefficients of partition between aqueous and fatty phases are favourable to the penetration of the compound into the tissues of the host and into the bacilli themselves.

Huebner et al.⁴⁰ on the basis of a number of compounds synthesised and tested, drew the following conclusions on the structural features necessary for the activity.

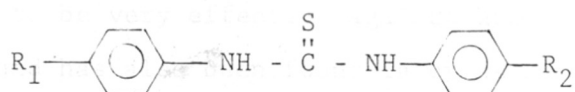

1. Shortening of the 4-substituent in the molecule to methoxy group destroys the activity, whereas lengthening of the chain to a maximum of 3-4 carbon atoms increases the activity.
2. Further increase in the chain length causes decrease in the activity until it completely disappears at R_1 or $R_2 = -\text{O}-\text{C}_8\text{H}_{17}$.
3. Replacement of an alkoxy group by an alkyl group of the equivalent length retains similar activity.
4. One of the alkoxy groups (at positions 4 or 4') may be replaced by halogen or dialkyl amino group with the retention of the activity and removal of one of the alkoxy groups also results in loss of activity.
5. The 4-substituents on both the benzene rings is necessary for the activity.

6. Introduction of a second substituent like methyl, halogen and amino in the ring destroys activity as does substitution of methyl on the ureido nitrogen.

7. The thiocarbanilide moiety is necessary since the corresponding thioureas viz. guanidine, guanylthioureas, cyclohexylthioureas etc. are inactive.

4,4'-Diisoamyloxythiocarbanilide (Isoxyl) has been found to be very effective against human leprosy.⁴⁹ This compound has also been found later as an effective tuberculostat^{50,51} and is used in place of PAS in conjunction with INH. Urbancik et al.⁵² studied antibacterial effect of isoxyl and ethoxyd on a typical photochromogenic mycobacteria in vitro and in vivo and found that these were active in the concentration of 1 mcg/ml.

Youman et al.^{53,54} prepared and tested 4- α -pyridyl 4'-n-butoxy thiocarbanilide (thiocarbanidin) and found its activity to be 12 times as active as PAS. The anti-tuberculosis activity of this compound was also enhanced by substitution of high negative groups in the 4-position.

Wagner and Winkelmann^{55,56} have prepared a series of N-N' diaryl thioureas carrying heterocyclic or condensed heterocyclic substituent and found that the thiourea

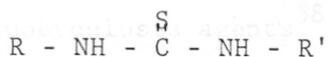

containing [R = p-butoxyphenyl or p-isobutoxyphenyl and R' = p-[2-(2-pyridyl vinyl) phenyl] were the most active

tuberculostats and pyridyl residues in general conferred high antitubercular activity. Pyridyl group could be replaced by quinonyl group without loss of activity, but replacement by other heterocycles caused loss of activity. The sulfur atom is also essential for antitubercular activity. Out of 180 compounds tested in vitro and in infected mice, p-n-butoxy-p'-n-butoxythiocarbanilide had the greatest activity (0.1 to 0.2 mcg/ml in vitro and 250 mgm/kg body weight when given orally).

The following survey on thiocarbanilides confirm the earlier findings as potential tuberculostats. Moreau et al.⁵⁷ prepared and tested compounds of this type and

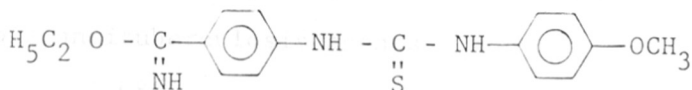
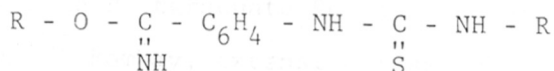

found that they inhibited the growth of bacillus strain H₃₇Rv in Youman's medium at 5 mcg/ml on the 14th day and 10 mcg/ml on the 21st day.

These interesting findings have considerably revived the interest in the field of thiocarbanilides as possible antituberculosis agents⁵⁸⁻⁶³ and various types of thiourea derivatives have been prepared and tested. Recent studies on the screening of thioureas have revealed that they might be effective for other infections.

547-496-3
DEV

TH-579

Spaun et al.⁶⁴ have tested thioureas containing diphenyl ether, diphenyl amine, diphenyl sulfide and sulfone moieties and have reported to be effective anthelmentics.

A patent granted to G.D. Searle and Co.⁶⁵ describes 1-benzyl-3-[-2-phenoxy-5(N-ethyl-N-phenyl sulfamoyl)phenyl]-2-thioureas, some of which are reported to be useful for their anti-ulcer activity.

Antiviral activity of some N-(2-hydroxyphenyl)-thiourea derivatives have also been described in a British Patent.⁶⁶ Recently the structure activity relationship of diphenyl thioureas as antivirals has been reported.⁹⁰

In the Postgraduate Research Laboratories of Parle College,⁶⁷ Bombay, extensive research on the synthesis and screening of a variety of thioureas has been carried out as possible antituberculosis agents.

Bavaskar⁶⁸ has prepared 3-chloro-4-alkoxy-4'-substituted thiocarbanilides and many compounds were found to inhibit the growth of bacilli in the concentration 0.1 mcg/ml and concluded that the introduction of an additional group (chlorine) in 4,4'-alkoxythiocarbanilide did not decrease the activity of the parent compound. Kadle⁶⁹ prepared and tested a number of 4,4'-substituted thiocarbanilides and introduced a carboxy, carbethoxy and hydroxy methyl group

in one of the phenyl rings to study their influence towards the antitubercular activity. It was concluded that the introduction of a carboxy group retained the activity of the parent compound. Replacement of the carboxy group by the carbethoxy group also did not alter the activity appreciably. However, the cyclic modification of the thiocarbanilides (viz. 2-thiohydantoin) decreased the activity.

Padsalgikar⁷⁰ prepared thiourea derivatives of p-substituted diphenylether carboxylic acids and their cyclic modifications (viz. xanthone) and some of them have been reported to have good activity in vitro.

Thiourea derivatives of 2-aminooxazoles have been reported to have potential antibacterial and antifungal activity.⁷¹

The fact that quinolyl thioureas are active against tubercle bacilli, Kale⁷² prepared p-substituted quinolyl-thioureas and their cyclic modifications (viz. 2-thiohydantoin) and some of them showed activity to the extent of 0.2 mcg/ml in vitro. However, the cyclic modifications like thiazolidinones and 2-thiohydantoin derivatives showed low activity.

To improve the therapeutic index of p-p'-diamino diphenyl sulfone (DDS) in drugs such as Diasone⁷³ and Promin,

J.R. Iyengar et al.⁷⁵ prepared a number of thiocarbamido derivatives of diaryl sulfides and sulfones of the following type and some of these compounds showed marked tuberculostatic properties in vitro.

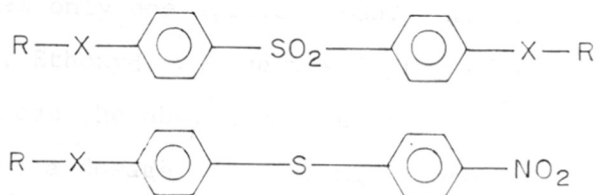

Amongst the compounds screened in vitro on D₃-strain of m-Tuberculosis, Bis (4-p-iodophenyl thiocarbamidophenyl) sulfone exhibited markedly increased activity almost comparable to the inhibitory action of PAS.⁷⁶ Since 4,4'-diethoxy thiocarbanilide (Ethoxyd) was superior in antibacterial activity over DDS, Elema Budeanu⁷⁷ prepared a series of bis thioureido derivatives of DDS and their activity in vitro was found to be 10-100 times that of DDS.

Sah⁷⁸ and co-workers while evaluating the various derivatives of DDS in vitro and in vivo observed that bis (4-p-ethoxyphenylthiocarbamido phenyl)sulfone showed in vitro activity at a concentration of as low as 0.0002 mg/10 cm³ and complete inhibition during a period of observation of three weeks.

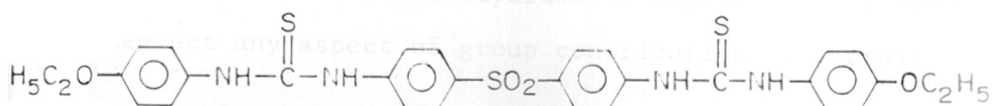

This compound when tested in mice and guinea pigs, the activity was found to be atleast 5 times that of Ethoxyd or Dialid. This high activity was expected, since the molecule contains three active groupings whereas Ethoxyd has only one active group. Against paratuberculosis, in animals, Ethoxyd was very slightly effective even at toxic dosage whereas the above sulfone derivative was perceptibly effective at a dosage of 20-25 mg/kg orally. Against human leprosy, this derivative produced an onset of reaction. However, relapses of the disease were observed, hence this derivative may find a place only as an alternative or adjunct drug to bis (4-L ascarbamidophenyl)-sulfone in the chemotherapy of human leprosy.

Arur⁷⁹ has synthesised compounds belonging to 2-carboxy-4-[substituted phenylthiocarbamido]4'-substituted-diphenyl sulfide series, and a considerable number of compounds showed good activity.

1-3.0 QSAR & HANSCH ANALYSIS

In recent years, various quantitative structure activity relationship (QSAR) procedures have been developed covering diverse fields of biologically active compounds including drugs and pesticides. Among them the Hansch approach has been most widely and effectively used. The Hansch approach⁸⁰ is a multiparameter approach which does not neglect any aspect of group contribution to overall

activity. The parameters are fundamental ones and are all able to be fitted to linear free-energy relationships, describing various electronic effects as well as hydrophobic and steric effects. The work of Lippert on the toxic action of various sets of compounds to bacteria is of much importance in chemotherapy.

$$\text{Log } \frac{1}{c} = k_1\Pi - k_2\Pi + k_3\sigma + k_4$$

where c = concentration of compound

Π = partition coefficient

σ = free energy related parameter.

Although much work remains to be done on relationships between lipophilicity and drug transport, the value of thinking in terms of $\log P$ is now apparent.

In the problem of finding a novel orally active antitubercular drug the $\log P$ values of known antituberculars may be listed according to their $\log P$ values.⁹²

Orally effective antitubercular drugs

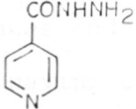
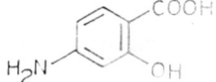
Name	Structure	Log P estimate
Isonicotinic acid hydrazide (INH)		- 0.50
Para-Amino salicylic acid (PAS)		0.97

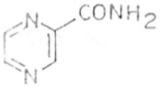
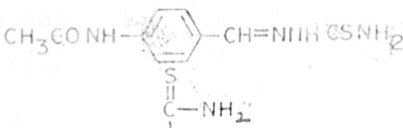
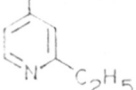
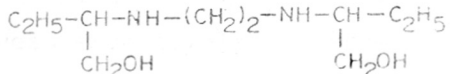
Name	Structure	Log P estimate
Pyrazinamide		- 2.32
Thiacetazone		- 1.31
Ethionamide		+ 0.59
Ethambutol		- 0.06

The log P estimates only refer to the unionized form, which is that form which will be positively transported by partitioning. Thus PAS and ethambutol can be ignored from consideration because these molecules will be largely ionized under physiological conditions.

The nature of tuberculosis in man is such that the infecting organism is protected from the action of drugs by existing within cavities surrounded by much necrotic and fibrous tissues and far away from any blood vessels. In addition to having the attributes of high activity and low toxicity, the drug must be able to penetrate an unusually large number of barriers before it can be effective in vivo and so factors governing transport will be very important. Thus in setting up

a programme of work aimed at the discovery of novel orally effective antitubercular agents one may give priority to the preparation of molecules for which log P is within -1.0 to 1.0.

Thiambutosine and thiocarlide have been generally accepted as second line drugs. However, it is poorly and erratically absorbed from the gut over 75% of the dose being excreted unchanged in the faeces and only 10% being absorbed.⁸¹ Effective therapy requires high dosage which even then, only gives serum levels in excess of the MIC for about 24 h. An extensive study showed that 14% of patients developed resistance when thiambutosin was used as a second line drug. The mode of action of the thiourea derivatives⁸² probably involves inhibition of mycolic acid and general lipid synthesis which has been observed within *M. tuberculosis*. Both thiambutosine and thiocarlide are generally well tolerated but a number of side effects have been reported, including an antithyroid action, skin eruptions, hepatitis and various blood disorders. Despite all these limitations, thiambutosine is a candidate drug for use in combination therapy and is still being used as a second choice drug. It remains however the least promising of the second line drugs.

Substituted diaryl thioureas are being synthesised and tested and QSAR study⁸⁴ has confirmed that the bulk

of the activity is associated with 4-alkoxy phenyl ring, with the optimum size of the alkyl group being n-butoxy-n-pentyloxy or n-hexyloxy.

Hansch Analysis:

The most significant contributions regarding Linear Free Energy Relationship model was that of Hansch and co-workers. It was Hansch et al.⁸⁸ who first derived the mathematical model which suggested that biological activity in many cases depends parabolically rather than linearly on the partition co-efficient. Hansch and Fujita⁸⁸ have defined a hydrophobicity constant π which is analogous to the Hammett constant σ which is obtained by measuring logarithmic changes in partition coefficient.

$\pi = \log P_x / P_h$ where P_h is the partition coefficient of a parent compound and P_x is the value for a derivative.

By applying π constant, Hansch obtained remarkable correlation between structure and activity; thus giving insight into drug action and drug design. The technique is called Hansch analysis. This analysis is based mainly on three parameters: the steric factors, the electronic interaction and the hydrophobic factors. Based on Hansch analysis, Fuller et al.⁸⁹ have successfully practiced the inhibitory potency of two n-(phenoxy ethyl) cyclopropylamine derivatives against monoamine oxidase.

This is the first example of predicting the activity using the Linear Free Energy Relationship model. Since the Hansch analysis is based on a variety of parameters, it is of great potential in the elucidation of the mechanism of drug action and drug design.⁹³ (Table 3).

Table 3

Comp. No.	Antituberculosis drug	Mechanism of action
1	Rifampicin	Inhibition of RNA synthesis
2	Streptomycin	Inhibition of Protein synthesis
3	Neomycin & Kanamycin	-do-
4	Viomycin & Capreomycin	-do-
5	Isoniazid	Inhibition of Mycolic Acid synthesis
6	Ethionamide	-do-
7	Thiocarlide	-do-
8	Thiosemicarbazone	No definite mechanism proposed
9	Ethambutol	-do-
10	Cycloserine	Inhibition of Peptidoglycan synthesis
11	PAS	Interference in the function of salicylic acid
12	Pyrazinamide	No definite mechanism proposed

The constants associated with it gives an indication about the nature of the transport of drug to the site of action.

The additive character of π or $\log P$ is of considerable help in modifying the structure of biologically active compounds, to have more active or more selective drugs and also in deciding when to terminate a series. The only problem in utilization of the standard Hansch method is that one has to involve with lot of mathematics, statistical procedures and computers.

Hansch method is also applied non-mathematically. In the problem of maximizing the biological activity of a series of aromatic derivatives, by first synthesising and screening the unsubstituted compound, an operational scheme for aromatic substitution was tentatively devised by Topliss⁸⁵ which is based on the assumptions of the Hansch type analysis (Table 4). The idea is based on a qualitative selection of the combination of physiochemical properties (π, σ, ϵ_s) of the particular substituent in order to maximise the pharmacological activity. Topliss⁸⁶ has modified his earlier non-mathematical approach and suggested that instead of synthesising compounds from parent compound one by one, and analysing the biological data before going to the next, it is better to synthesize the parent compound with the following set of substituents and analyze them for biological activity. The aromatic substituents suggested in the first such set are: -H, -Cl, -CH₃, -OCH₃, and 3,4-dichloro. These are then arranged

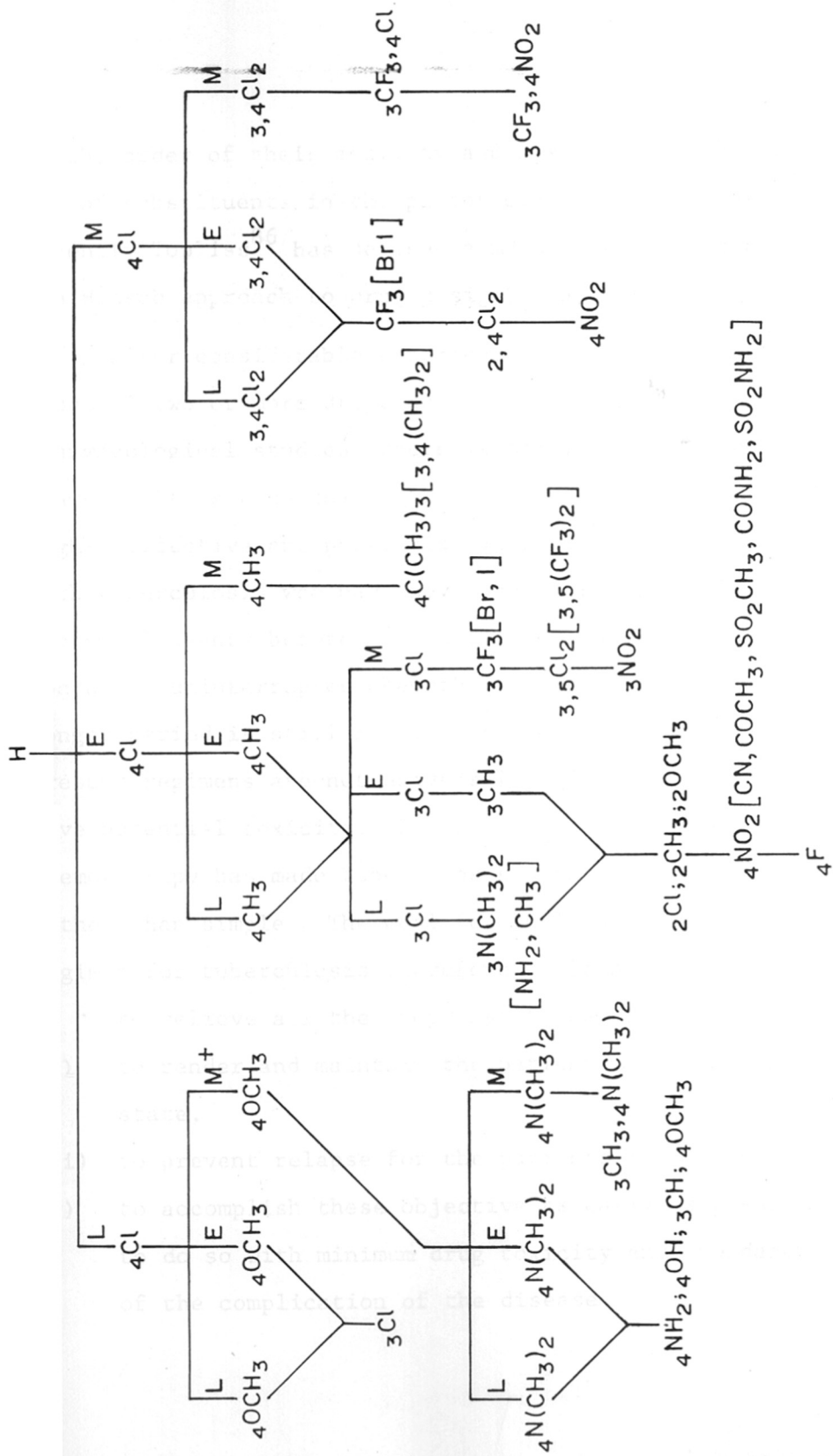

TABLE 4. OPERATIONAL SCHEME FOR AROMATIC SUBSTITUTION.

in the order of their activity and based on this a new set of substituents in the parent compound is suggested. Recently Topliss⁸⁶ has devised a manual method for applying the Hansch approach to drug design, (Table 4).

After considerable experience with numerous combinations of two or more drugs and exhaustive animal and pharmacological studies, there is still a great deal to be learnt. It is true that we have a number of regimens highly effective and particularly applicable to patients with tuberculosis who have never been treated with antimicrobial agents before. On the other hand, at least 12 months of uninterrupted chemotherapy and often a much longer period is still required to achieve more benefits. Present regimens are not universally effective and still have potential toxicity. Despite greatly improved results chemotherapy has made tuberculosis treatment more complex rather than simple. The goal for an ideal chemotherapy regimen for tuberculosis therefore would be:

- i) to relieve all the symptoms of the disease,
- ii) to render and maintain the patient in a non-infectious state,
- iii) to prevent relapse for the patients' life time
- iv) to accomplish these objective as early as possible
- v) to do so with minimum drug toxicity and avoidance of the complication of the disease.

In order to corroborate the above theories and also to have good Hansch equation, a series of compounds having substituents as per Cluster analysis⁸⁷ are chosen.

Accordingly, novel systems incorporating thiocarbani- lides having log P values consistent with the requisite values were synthesised.

1-4.0 PRESENT INVESTIGATION

The structure-activity relationship of a series of diaryl thioureas in our laboratory showed that it was only necessary for one aryl group bearing a 4-alkoxy substituent to be present with the side chain having a C₆-C₈ chain length for optimal activity.⁹¹ This suggested that it might be possible to design thioureas with greater activity and more favourable pharmacokinetic properties by modification of the side chains of these molecules. In order to achieve this first, the side chain(s) attached to the aryl ring(s) could be modified to introduce more hydrophilic substituents such as hydroxy, carboxy and/or aliphatic amino groups. The latter with Pka values ~8-10 would be substantially ionised at physiological pH 7.2. Second, since only one alkoxy aryl group is required⁹¹ other more hydrophilic groups could be introduced on the second nitrogen atom of the thiourea moiety, e.g. carboxyalkyl, aminoalkyl or the more complex penicillamyl and cephalosporanyl groups. Third, these compounds, which

may act by inhibiting mycolic acid synthesis, could have modified side chains introduced which would allow them to act as irreversible enzyme inhibitors. Four, if the thiourea moiety could be replaced by a less toxic structural unit then a new series of novel antituberculosis and anti-leprosy drugs would become available.

In the present investigation, the first three questions raised above have been addressed as follows:

- i) Since one aryloxy group is essential for activity,⁹¹ the other aryloxy group is replaced by more water soluble groups e.g. salt forming groups in order to have a more favourable pharmacokinetic profile especially in terms of the hydrophilicity. The introduction of amino acids, penicillanic acids, cephalosporanic acids and uracil moieties in the thioureas renders these compounds water soluble. Synthesis of the thioureas with an aryloxy side chain coupled with the above mentioned groups constitutes the first chapter.
- ii) The replacement of one of the aryloxy groups with an acetylenic side chain was carried out to see whether the activity of the diaryl thioureas were retained. These groups may act irreversibly by inhibiting the enzymes through a binding mechanism. Also, both the aryloxy groups in the thiourea were replaced by this acetylinic side chain to give a symmetrical thiourea. The second chapter deals with the

synthesis of such thioureas having the combination of substituents selected on the basis of Topliss analysis and the acetylinic side chain.

iii) The alkoxy side chain being more lipophilic in character, renders the thioureas less water soluble. To improve the hydrophilicity of this chain, i.e. reducing the log P value of the compounds by more or less maintaining the optimum chain length (9.26 \AA°) for activity, the alkoxy group was replaced by 3-diethyl-amino-2-hydroxy propoxy group. The thioureas thus synthesised have been described in the third Section.

1-5.0 REFERENCES

1. F.L. Soper, Am. J. Public Health, 52, 734 (1962)
2. R. Koch Berlin, Klin, Wochschr., 19 221 (1882)
3. E.R. Long "Chemistry and Chemotherapy of Tuberculosis" 3rd Ed. William and Wilkins Co., Baltimore (1958).
4. A.R. Rich and R.H. Follis, Bull. Johns. Hosp., 62, 77 (1933).
5. N. Rist, F. Bloch and V. Hamon Ann. Inst. Pastuer, 44, 203-237 (1940).
6. Rist, Compt. rend. Soc. Biol., 130, 972 (1939).
7. Rist, *ibid*, 130, 976 (1939).
8. Rist, Bloch and Hamon, Ann. Inst. Pastuer, 44, 203-237 (1940).
9. Feldman, Hinshaw and Moses, Proc. Staff Meetings, Mayo Clinic, 16, 187 (1941).
10. D. Jones, H.J. Metzger, A. Schatz and S.A. Waksman, Science, 100, 103-5 (1944).
11. Bernhein F, Science, 92, 204 (1940).
12. J. Lehmann, Lancet, 1, 15 (1946).
13. J. Bernstein, W.A. Lott, B.A. Steinberg and H.A. Yale, Am. Rev. Tuberc., 65, 357-64 (1952).
14. H.H. Fox, Science, 116, 129-32 (1954).
15. G. Domagk, Am. Rev. Tuberc. 61, 8-19 (1950).
16. J.P. Thomas, C.O. Baughu, R.G. Wilkinson and R.S. Shepherd, Am. Rev. Res. Dis, 83, 891 (1961).
17. R.G. Wilkinson, R.S. Shepherd, J.P. Thomas and C. Baughu, J. Am. Chem. Soc., 83, 2212 (1961).
18. R.L. Meyer, P.C. Eisman and E.A. Konopka, Proc. Soc. Exptl. Biol. Med., 82, 769 (1953).

19. T.F. Davey, *Leprosy Rev.*, 30, 141 (1959).
20. Gardner, Wenis and Lee, *J. Org. Chem.*, 19, 753 (1954).
21. Grumbach et al., *C.R. Acad Sci. (Paris)*, 242, 2187 (1956).
22. Meltzer, Lewis and King, *J. Am. Chem. Soc.*, 77, 4062 (1955).
23. D. Libermann, N. Rist and F. Grumbach, *Bull Soc. Chim. Biol.*, 38, 231 (1956).
24. T. Grumbach et al., *Compt. Rend*, 242, 2187 (1956).
25. K. Yamagachi
Japan Pat. 44,253; *C.A.* 18, 1180 (1924).
26. M. Bochmahl and W. Persch,
U.S. Pat. 2,323,445; *C.A.* 38, 220 (1944)
27. S.P. Massie, Iowa State College,
J. Sci., 21, 41 (1946); *C.A.* 41, 3044 (1947).
28. C.G. Bueno DeLa, M. Rivas and J. Barrios
Rev. Oufon Farm (Santiago Chile), 2, No.2, (1944).
29. H. Viveros, J. Barnos and M. Rivas
Aparato Respirat Y. Tuberc. (Santiago Chile)
11, 210-19 (1948); *C.A.* 42, 4275 (1948).
30. J.D. Brooks, P.T. Charlton, P.E. Macey, D.A. Peak
and W.F. Short, *J. Chem. Soc.*, 452 (1950).
31. J. Buchi, R. Liberherr and M. Flurry,
Helv. Chim. Acta, 34, 2076-83 (1951).
32. G. Hagellock and K. Liebermeister,
Z. Natur. forschung, 6B, 147-55 (1951);
c.a. 46, 4047 (1952).
33. M. Shimotani, *J. Pharm. Soc. Japan*, 72, 440 (1952).
34. W.H. Wagner and H. Vanderban,
Zr. Ges. Exptl. Med., 115, 66-81 (1949);
C.A. 44, 9070 (1950).
35. P.C. Shroder, *Chem. Rev.*, 55, 181 (1955).
36. J. Touin and N.P. Buu-Hoi,
Ann. Inst. Pasteur, 72, 580 (1954).

37. W. Aumuller, L. Harner, J. Kimming, Meyer Rohn J, E. Junghanns and Pohl H, Ber. 85, 760 (1952).
38. M. Kajimoto, J. Pharm and Chem., 24, 443 (1952)
C.A. 47, 6885 (1953).
39. A.G. Schering
Ger. Pat. 833,040, C.A. 47, 3348 (1953).
40. C.F. Huebner, J.L. Marsh, R.H. Mizzoni, R.P. Mull, P.C. Schnoder, H.A. Troxell and C.R. Scholz, J. Am. Chem. Soc., 75, 2274 (1953).
41. P.C. Eisman, E.A. Konopka, R.L. Mayer, Am. Rev. Tuberc., 70, 121 (1954).
42. P.C. Eisman, E.A. Konopka, R.L. Mayer, Am. Rev. Tuberc., 70, 130 (1954).
43. E.A. Konopka, P.C. Eisman, T. Gisi and R.L. Mayer, Proc. Soc. Exptl. Biol. N.Y., 89, 388-391 (1955).
44. K. Fujii, J. Arito, H. Hakemi and H. Watanabe (Tanabe Res. Lab. Osaka), Tanabe Sayaka Kenkyu Nempo, 2, 9-13 (1957).
45. N.P. Buu-Hoi, N.D. Xuong, N.B. Khuyen, Bull. Acad. Natl. Med., 275, 15 (1955).
46. T.F. Davey and G. Curri, Leprosy Rev., 27, 94 (1956).
47. N.P. Buu-Hoi, N.D. Xuong, T.T. Mong-Don and T.V. Bang, Chemotherapia, 2, 122 (1961).
48. N.P. Buu-Hoi et al. Compt. Rend., 237, 498 (1953).
49. N.P. Buu-Hoi Inst. of Leprosy, 22, 16 (1954).
50. G. Farez and Z. Schweis, Tuberculose, 18, 6 (1961).
51. G. Fegiz, Gazz. Intern. Med. Chim., 24 (1961).

52. B.R. Urbancik and V. Dornetzhuber
[Utsav Tuberk. Brutislava (Zech) Rozheldy Tuberk]
27(2), 111-16 (1967).
53. G.P. Youmans, A.S. Youmans and L. Doub.
Am. Rev. Tuberc., 77, 301 (1958).
54. L. Doub et al.
J. Am. Chem. Soc., 80, 2205 (1958).
55. Wagner Wolf Helmut, Winckelmann Erhardt
(Farbwerke Hoechst, Germany)
Arzheim Forsh, 19(5), 719-30 (1969).
56. Wagner and Winckelmann,
Arzneim Forsh, 19(4), 543-548 (1969).
57. V.I. Cohen, Pierre Reynand and R.C. Moreau,
Bull. Soc. Chim. France (8), 2314-17(Fr.) (1965);
C.A. 62, 7677b.
58. Fujikawa, Fukujivo, Hirai, Kunio, Hirayama,
and Ternhisa
(Kiyoto Coll. Pharmacy, Kyoto, Japan)
Yukugaku Zusshi, 91(2), 159-165 (Japan) (1971).
C.A. 74, 141216q (1971).
59. Chough, Yunsung, Rhee, Myung Gull.
Yorkhak Hoeji, 14(1-2), 1-14 (Korean)
C.A. 75, 5772m (1971).
60. V. Grinsteins, K. Medne and O. Petersons,
Khim. Pharm. Zh., 6(2), 2025 (Russ.) (1972);
C.A. 77, 436846k (1972).
61. N.B. Gulstukova and M.N. Shchukina,
Khim. Pharm. Zh., 6(7), 19-23, Russian (1972).
62. Fujikawa, Fukujivo et al.
Yakagaku Zasshi, 92(10), 1275-1284 (1972), Japan.
C.A. 78, 3911h (1973).
63. T. Khavizanova, V. Simova, et. al.
Kongr. Microbiol. Mater. Kongr. Mikrobiol.
Bulg. 2nd 1969 (Pub 1971), 141-47 (Bulg);
C.A. 78, 67449g (1973).
64. Spaun et al. (S.A. Agripat)
Swiss Pat. 540 236; C.A. 80, 14764r (1974).

65. G.D. Searle and Co.
U.S. Pat. 3,798,768 (March, 1974).
C.A. 80, 133088h (1974).
66. Meditsinska, Akademiya, Brit. Pat.1,350,710
(April 1974); C.A. 81, 63366s (1974).
67. K.S. Nargund (Private communication).
68. P.A. Bavaskar, Ph.D. Thesis (University of Bombay),
1971.
69. P.R. Kadle, Ph.D. Thesis (University of Bombay),
1973.
70. K.D. Padsalgikar, Ph.D. Thesis (University of Bombay),
1974.
71. G. Crank, M. Neville and R. Ryden,
J. Med. Chem., 76, 1402 (1973).
72. K.V. Kale, Ph.D. Thesis (University of Bombay),
1977.
Raiziss et al., J. Am. Pharm. Assn., 33, 43 (1944).
73. Bauer.
J. Am. Chem. Soc., 617 (1939).
74. Gray et al.
J. Chem. Soc., 617 (1939).
75. J.R. Iyengar, S.C. Bhattacharya and P.C. Guha,
Current Science, 20(7), 184 (1951).
76. M. Sirsi, R.N. Jayasinha and J.R. Iyengar,
Current Science, 20(9), 237 (1951).
77. Elema Budeany,
Analele Stiint Univ. "Al I Cruza" Iasi
Sect. 14, 169-82 (1958); C.A. 55, 23420a (1961).
78. Sah, P.T. Peter, s.a. Peoples, S.T. Kwan and
Sah, J. Hamilton,
Arzneim Frosch, 17(4), 425-31 (1967).
79. P.V. Arur, Ph.D. Thesis (University of Bombay),
1978.
80. C. Hansch, E.J. Lien and F. Helmer,
Arch. Biochem. Biophys., 128, 319 (1968).

81. G.A. Ellard,
Lepr. Rev., 46, 41 (1975).
82. L.P. Sensi and G. Gialdroni-Grassi in:
Burgers Medicinal Chemistry, 4th Edn.,
ed. M.E. Wolff (Wiley, New York), Part II,
(1979), 297.
83. M. Harachap,
Depr. Rev., 52 155 (1981).
84. M. Hooper and S.N. Kulkarni,
Br. J. Pharmacol., 77, 574 (1982).
85. J. Topliss,
J. Med. Chem., 15, 1006 (1972).
86. J. Topliss,
J. Med. Chem., 20, 463 (1977).
87. C. Hansch and A. Lea;
Substituent constants for correlation analysis
in chemistry and biology, New York, Wiley (1979).
88. C. Hansch and T. Fujita,
J. Am. Chem. Soc., 86, 1616 (1964).
89. R.W. Fuller, M.M. Marsch and J. Mills,
J. Med. Chem., 11, 397 (1968).
90. R.S. Galabov, B.S. Galabov and Nadejd A. Neykova,
J. Med. Chem., 23, 1048-1051 (1980).
91. K.V. Kale and S.N. Kulkarni
Indian J. Chem., 17B, 530 (1979).
92. Micheal Tute,
Advances in Drug Research, Vo.6, p.1-67.
93. Colin Ratledge and John Starford
The Biology of the Mycobacteria, Vol. 1,
F.G. Winder, p. 354-438, A.P. (1982).

SYNTHESIS OF THIOUREAS WITH SUBSTITUTED AMINO ACIDS, AROMATIC AND HETEROCYCLIC AMINO COMPOUNDS WITH OR WITHOUT CARBOXYLIC ACID GROUPS

2.0-0 INTRODUCTION

QSAR studies¹ in diarylthioureas have confirmed that the bulk of the activity is associated with the 4-alkoxy phenyl ring, the optimum length for the alkyl group being n-butoxy to n-hexyloxy having 9.6 A°. However to have a better pharmacokinetic profile, it is desirable to reduce the log P values of these compounds which would increase their solubility in the aqueous phase. Since one aryloxy group is essential for activity,¹ the replacement of the other aryloxy substituent in the thiourea moiety by more water soluble groups, i.e. by substituents having lower log P values will render these compounds hydrophilic. Such salt forming groups have an effect on the absorption characteristics of the compounds in the gastro-intestinal tract and can reach the site of action quickly. It is known that substituents such as amino acids, penicillanic acids, cephalosporanic acids and uracils are substantially ionised at the physiological pH 7.2. Hence these groups which when incorporated in the thiourea moiety along with the indispensable aryloxy side chain would lead to compounds having lower log P values and as a consequence, favourable pharmacokinetic properties.

The above hypothesis has been substantiated by synthesising unsymmetrical thioureas having an aryloxy substituent on one nitrogen atom and more hydrophilic

substituents such as carboxy alkyl, amino alkyl, penicillamyl, cephalosporanyl, and uracil on the second nitrogen atom of the thiourea.

In this chapter, the following thioureas have been prepared.

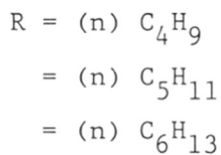
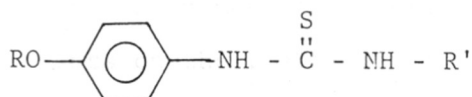

While R' is chosen in such a way as to render the thio-carbanilide more water soluble. The following R' have been chosen.

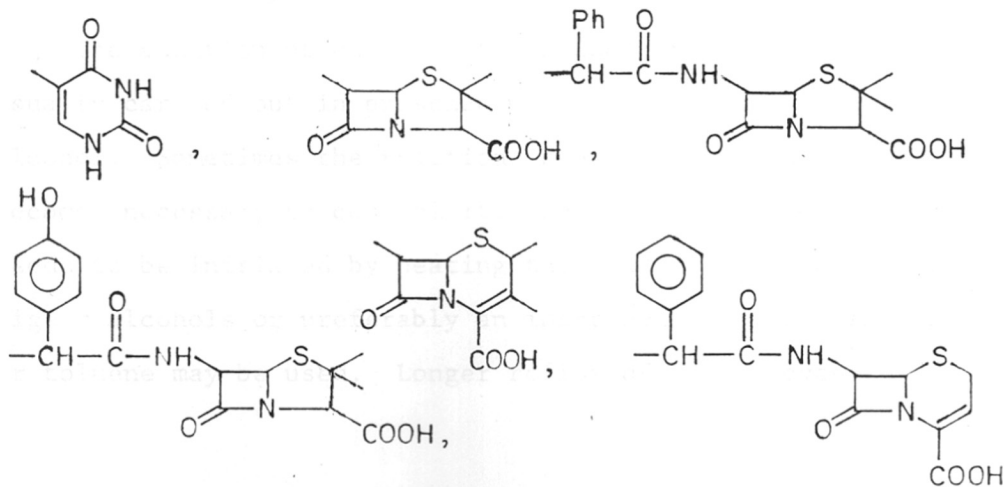
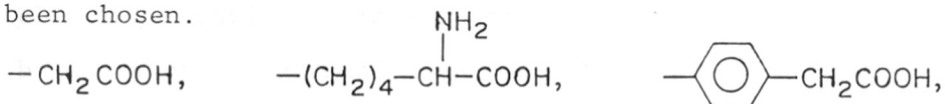

The most common method of preparing unsymmetrical thioureas is the condensation of an alkyl or aryl isothiocyanate with an amine (in case of amino acid, the sodium salt is used).

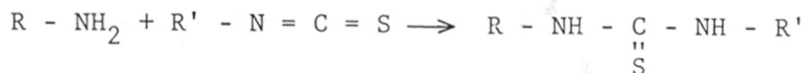

Studies have been made to determine the effect of nuclear substituents on the reactivity of aryl isothiocyanates.² It was found that halogens, nitro, m-methoxy groups accelerate the rate of reaction. Since the reactivity of the isothiocyanate group towards nucleophilic agents increases with decreasing density of the π electrons on the carbon atom, the electron withdrawing substituents increase the reactivity as compared to the electron releasing substituent (alkoxy groups). Also the nucleophilicity of the attacking species affects the rate of reaction in a linear relationship.

The addition of an amine to an isothiocyanate is usually carried out in presence of a solvent such as alcohol. Sometimes the reaction is exothermic and cooling becomes necessary to control it. In some cases the reaction needs to be initiated by heating the mixture. In such cases, higher alcohols or preferably an inert solvent like benzene or toluene may be used. Longer reflux of isothiocyanate-

alcohol - amine mixture may result in side reaction of isothiocyanate and alcohol to yield thiourethane. Hence reaction requiring longer hours of reflux, use of alcohol as a solvent is not recommended. Pyridine has also been used successfully as a solvent.³ The thiourea often precipitates out of the cooled reaction mixture. Sometimes the precipitates appear in the hot solution also, since in most cases, the thioureas are less soluble than the starting materials.

The reaction of amino acids with aryl isothiocyanates have been studied thoroughly by L. Drobica and co-workers.⁴ He concluded that reactivity of selected amino acids towards aryl isothiocyanates obeys the Taft equation and decreases with decreasing basicity of the amino groups of the corresponding amino acids. P. Edman⁵ has prepared a number of phenylthiocarbamylamino acids for mass spectral studies. The reactions were carried out in essentially basic medium in a solvent like pyridine. After the removal of pyridine the reaction mixture was carefully acidified with 1N HCl so as to avoid the formation of thiohydantoin.

During the present investigation, a number of thio-carbamido derivatives of various amino acids were prepared by condensing with different aryl isothiocyanates having p-butoxy, p-amyloxy and p-hexyloxy substituents in the aryl nucleus.

The steps involved are:

1. Preparation of various substituted p-alkoxy anilines;
2. p-Alkoxyphenyl isothiocyanates; and
3. Condensation of substituted p-alkoxyphenyl isothiocyanate with various amino acids, aromatic/heterocyclic amino compounds with or without carboxylic acid group.

2-1.0 PREPARATION OF P-ALKOXYANILINES

The p-alkoxyanilines were prepared from p-alkoxy-nitrobenzene by reduction with hydrazine hydrate and Raney-Nickel. The starting material, p-alkoxynitrobenzene can be prepared by the following general method.

(a) Alkylation of alkali salt of p-nitrophenol using alkyl halides:

Several p-nitrophenyl alkyl ethers were prepared and described by Spiegel and Sabbath.⁶ They prepared nitrophenyl alkyl ethers by autoclaving a mixture of potassium salt of p-nitrophenol and alkyl bromide or iodide using alcohol as a solvent for 6 h at 170-180°C. Since then, a number of modifications have been made to obtain higher yields. Gutekunst and Gray⁷ obtained p-nitrophenyl n-butyl ether in 56% yield by employing n-butyl alcohol as a solvent besides using 50% alcohol as recommended by Spiegel and Sabbath. However, the yields of this compound were further increased to 68.5% by employing butyl alcohol alone as a solvent by Steck, Buck and

Fletcher.⁸ Monique and Cleve-bory⁹ employed a large quantity of ethyl alcohol for condensation of potassium salt of o-nitrophenol and benzyl chloride and reported 65% yield of o-benzyloxy nitrobenzene. Bromine and crystals of iodine were used as catalysts. Probably the action of bromine and iodine is to convert benzylchloride to benzyl iodide in situ and facilitate the condensation. Claisen and Eislb¹⁰ developed a new and convenient method which avoids the preparation of salts of phenols. In general, it consists in refluxing any phenol with an alkyl halide and anhydrous potassium carbonate in acetone for several hours. This method was modified in case of nitrophenyl alkyl ethers by Allen and Gates¹¹ who refluxed the mixture of o-nitrophenol (1 mole), potassium carbonate (1 mole), butylbromide (1.1 mole) and acetone for 48 h getting 75-80% yield of o-nitrobutoxybenzene. However, they have pointed out that this yield could be further increased to 80-90% by increasing the quantity of butylbromide to two moles. Ketones of higher boiling points like, methyl ethyl ketone, cyclopentenone, cyclohexanone, have been recommended by Weygond and Gabler¹² in place of acetone to improve the yields. The lower alkyl halides condense more easily with p-nitrophenol and higher alkyl halides require longer time and the yields are poor. Para-substituted n-butoxy, n-amylloxy and n-hexyloxy nitrobenzenes were prepared by alkylation of

p-nitrophenol with corresponding alkyl halides in ethanol using potassium hydroxide as a base in 50-60% yields.

The alkoxy anilines can be prepared by one of the following methods reported in the literature.

- i) By hydrolysis of acetamidophenyl alkyl ethers obtained by alkylation of acetamido phenols;
- ii) By the reduction of nitrophenyl alkyl ethers.

(i) Hydrolysis of acetamidophenyl alkyl ethers obtained by alkylation of acetamidophenols

Alkylation of acetamidophenol is carried out either by alkyl halides or anhydrides.¹³⁻¹⁵ The yields vary from 60 to 90%. Buu-Hoi et al. recommended the use of formamido phenols in place of acetamidophenols. Kulkarni¹⁶ has carried out the alkylation of p-acetamidophenols with alkyl bromide at reflux for 6 h and the average yields of alkoxy anilines was 80-85%. Hydrolysis of p-alkoxyacetamidophenols gave the corresponding alkoxy anilines.

(ii) Reduction of p-nitrophenyl alkyl ethers

Reduction of p-nitrophenyl alkyl ethers is carried out by employing any one of the following methods:

- a) Iron and hydrochloric acid
- b) Catalytic hydrogenation
- c) Stannous chloride and hydrochloric acid
- d) Cyclohexene and palladium charcoal
- e) Sodium borohydride and tin chloride

- f) Isopropanol and Raney-Nickel
- g) Hydrazine hydrate and Raney-Nickel

(a) Iron and hydrochloric acid:

Reduction with iron or granulated iron in water using small quantity of hydrochloric acid is shown to be the best combination to get good yields of amine from nitro compounds as described by West¹⁷ as well as by Hazlet and Dornfield¹⁸ who prepared a number of aromatic amines by this method. Li and Adams¹⁹ showed that 54-83% yields of alkoxyanilines could be obtained by this method. Clement de Traz²⁰ who employed alcohol as a solvent besides using very dilute hydrochloric acid obtained 3:5 dichloro-4-methoxy aniline in 96% yield.

(b) Catalytic hydrogenation

This is performed by hydrogenation in alcohol over Raney-nickel at 25-100°C at 3 atm.²¹ or over platinum oxide at room temperature and at 1-2 atm.²² The reaction is highly exothermic,²¹ hence precautions should be taken against higher reaction temperatures, Monique Clerc-Bory⁹ obtained 77% yield of *o*-benzyloxyaniline. Excellent yield as high as 92.5% was reported by Steck, Buck and Fletcher,⁸ in the reduction of *p*-butoxynitrobenzene using Raney-nickel at 25° and hydrogen at 80 atm. Tsatsas and Delaby²³ prepared isopropoxy aniline in 100% yield by hydrogenation of nitro-compound in alcohol at room temperature using Pd/C

(c) Stannous chloride and hydrochloric acid:

Gutekunst and Gray⁷ employed this method for reduction of o-butoxy nitrobenzene and obtained 96% yield by taking the nitro-compound, stannous chloride and hydrochloric acid in the ratio of 1:4:5.

(d) Cyclohexene and palladium:

Braude, Linstead and Wooldridge²⁴ have discovered a convenient general method for the conversion of aliphatic and aromatic nitro-compounds into primary amines. Moreover, in the presence of more than one functional group, transfer hydrogenation is often remarkably selective and affords higher yields than catalytic hydrogenation or other methods of reduction. The method consists of refluxing the nitro-compound with cyclohexene in presence of palladium catalyst water miscible solvents such as methanol, ethanol, etc. are favoured. Para-nitroanisole has been reduced by this method to get p-anisidine in 83% yield. The hydrogen for reduction is supplied by the cyclohexene which is dehydrogenated to benzene.

(e) Sodium borohydride and tin chloride:

Aromatic nitro-compounds can be selectively reduced using sodium borohydride and tin chloride to their respective amines.²⁵ The optimum conditions for the reaction were 0.5 eq. of sodium borohydride and 5 eq. of tin chloride and the reaction was carried out in ethanol. Para-nitro ethyl

benzoate was reduced to the p-amino compound in 70-80% yields. The reactions are also carried out using nickel chloride as catalyst.

(f) Isopropanol and Raney-nickel²⁶

About 100% conversion was obtained when a p-nitro anisole was stirred with isopropanol and Raney-nickel at 50° to yield p-anisidine. Noble et al. exploited this procedure to reduce aromatic nitro-compounds in presence of other reducible groups such as keto, ester, cyano, oxime, etc. No other byproducts were observed.

(g) Hydrazine hydrate and Raney-nickel

The selective reduction of aromatic nitro-compounds can be effected by using hydrazine and Raney-nickel catalyst. In a general procedure,²⁷ to the nitro compound in methanol and Raney-nickel is added a solution of 5 mole equivalents of hydrazine hydrate and refluxed for 2-3 h. 60-70% yields of the amine were obtained. The procedure holds good for selectively reducing nitro-compounds in presence of benzyl ethers.²⁸

In the present investigation, hydrazine hydrate and Raney-nickel method was used to reduce the p-alkoxy nitro-benzenes to corresponding anilines, the details of which have been mentioned in the Experimental Section.

2-2.0 PREPARATION OF SUBSTITUTED PHENYL ISOTHIOCYANATES
FROM VARIOUS SUBSTITUTED ANILINES

There are several methods of preparation of isothiocyanates. From primary amines, isothiocyanates can be obtained either directly by action of some sulphur compounds (e.g. thiophosgene, dithiocarbamoyl chloride, trichloromethyl sulphide, etc.) or by converting them into suitable intermediates (dithiocarbamates, dithiocarbazates thioureas, etc.) which are then decomposed to isothiocyanates by reaction with various agents.

The substituted isothiocyanates were prepared by the following general methods.

(a) Thiophosgene

The most generally used method for the preparation of isothiocyanate is based on direct treatment of the primary amine²⁹ with thiophosgene.



The first product of the reaction is an unstable thiocarbamoyl chloride which splits off hydrogen chloride easily yielding isothiocyanate.³⁰ The course of the reaction can be illustrated by the following addition-elimination mechanics.

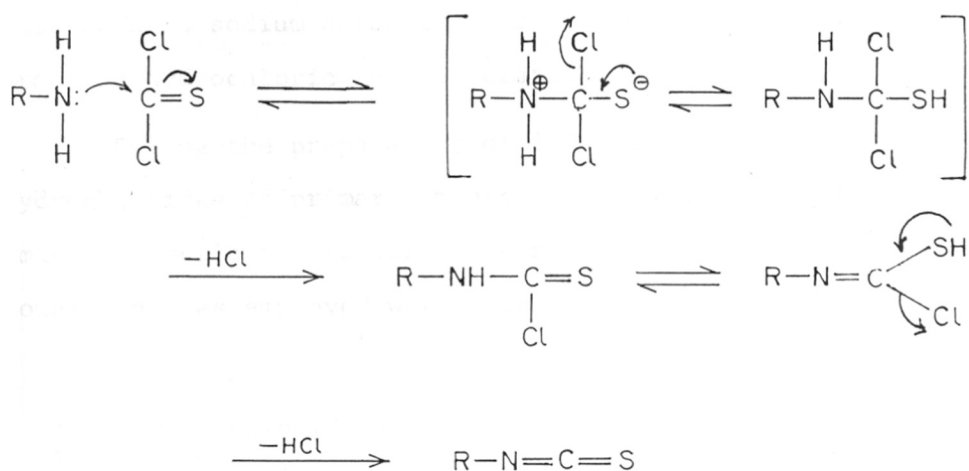

In the case of aromatic amines, especially with electron accepting substituent, N,N'-disubstituted thioureas may be formed as byproducts.³⁰

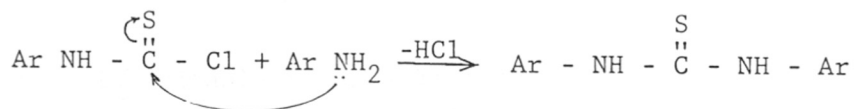

The formation of thioureas can be prevented by the use of a small excess of thiophosgene. Since isothiocyanates as well as thiophosgene are relatively insensitive to water, they can also be prepared in an aqueous medium.³¹ (Not only free amines but also their salts, particularly hydrochlorides, react with thiophosgene to produce isothiocyanates.³²

Reaction with free amine is most frequently performed in such a way that chloroform or toluene solution of amine is added to the water emulsion of thiophosgene.³³ A mild



base such as sodium carbonate, or triethylamine is used to trap the hydrochloric acid liberated in the reaction.³⁴

During the preparation of isothiocyanates from the hydrochlorides of primary amines, an aqueous solution of amine hydrochloride is used preserving similar reaction conditions as employed with free amines.³¹

Sayigh and co-workers³⁵ have proposed N,N-diethylthiocarbamoyl chloride as a new reagent which could replace the toxic thiophosgene.

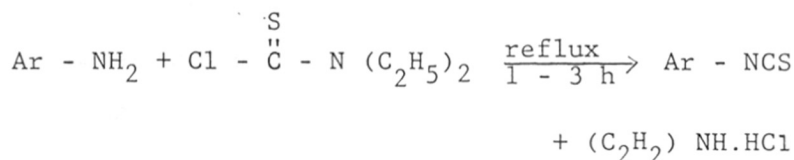

This method is suitable for preparation of aromatic isothiocyanates with electron-withdrawing substituents.

(b) Decomposition of dithiocarbamic acid and its salt or esters

The salts of dithiocarbamic acid are prepared^{36,37} by the action of carbon disulphide and alkali or ammonia³⁸ on the aqueous or organic (alcohol, methylene chloride, toluene etc.) solution of the primary amines.

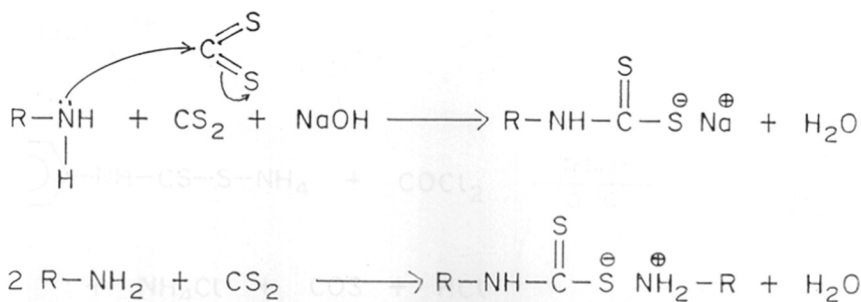

The amines whose basicity is so low that they do not form dithiocarbamates cannot be used (e.g. nitranilines).

In the second step, treating these dithiocarbamate salts with various reagents leads to the formation of isothiocyanates.

Many reagents have been used to decompose dithiocarbamates.

(i) Decomposition with metal salts:

Heating of alkaline dithiocarbamates with heavy metal salts in an aqueous medium produces unstable heavy metal dithiocarbamates which decompose easily into isothiocyanates and metal sulphides.

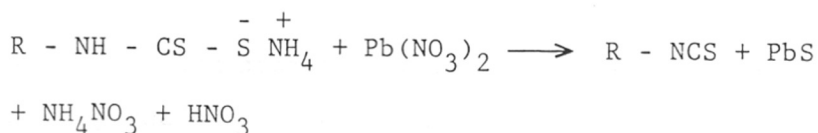

For the decomposition of dithiocarbamates mercury salts,³⁹ lead nitrates,⁴⁰ cupric sulphate,³⁹ ferric chloride,⁴¹ etc. were used.

(ii) Decomposition by chlorine-containing compounds:

Some aromatic isothiocyanates are advantageously prepared by the decomposition of dithiocarbamates with phosgene.⁴²

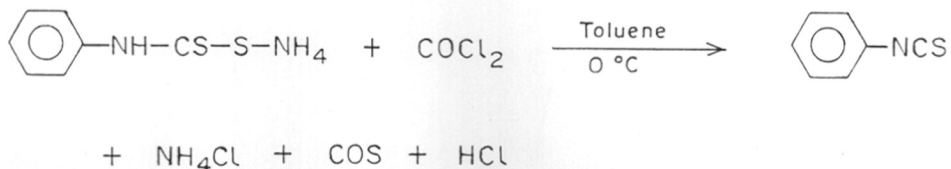

However, this method fails with 4-substituted electron-withdrawing substituents.

The decomposition of dithiocarbamates with ethyl³⁹⁻⁴² chloroformate produces aliphatic isothiocyanates in very good yields. Reaction takes place via the unstable carbethoxy dithiocarbamate which decomposes into isothiocyanate, carbonylsulphide and ethanol.

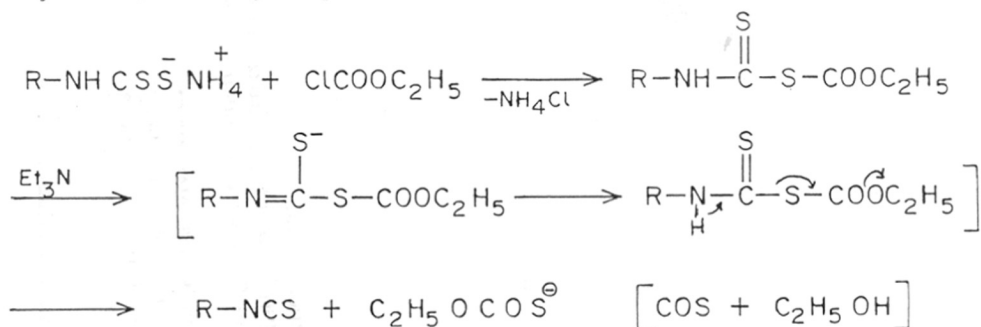

Aliphatic and aromatic isothiocyanates can also be prepared by the oxidative decomposition of dithiocarbamates by sodium hypochlorite in an alkaline medium.⁴³

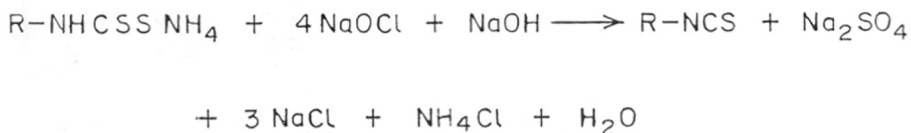

Van den Kerk and co-workers⁴⁴ used this method for the preparation of aromatic isothiocyanates by decomposition of dithiocarbamate with the salts of halogen fatty acids. The reaction took place in two steps. In the first step,

NOTE

The activity results of the compounds synthesised in Sections 2 & 3 are expected shortly, and the conclusions thus drawn will be sent to the referees before the viva-voce.

In Section 4, it could be seen that when the butoxy side chain is replaced by the 3-diethylamino, 2-hydroxy, propoxy side chain; the activity remained almost same.

ammonium (S-carboxy alkyl) phenyl dithiocarbamate was formed which decomposed to isothiocyanate in a weakly basic medium in the presence of $ZnCl_2$.

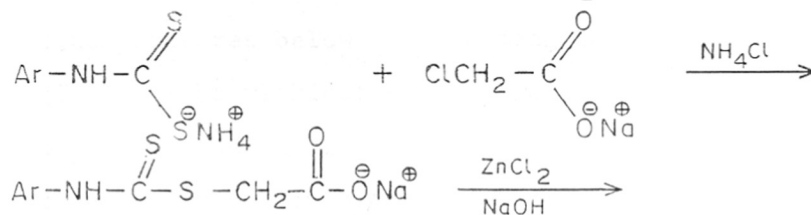

Dithiocarbamates can also be decomposed by means of phosphorousoxychloride or *o*-phenylenedioxitrichloride.^{45,46}

(iii) Decomposition by hydrogenperoxide

Treatment of a mixture of primary amine and carbon disulphide with hydrogen peroxide in presence of secondary aliphatic amine produces a rapid exothermic reaction which gives isothiocyanates.⁴⁷

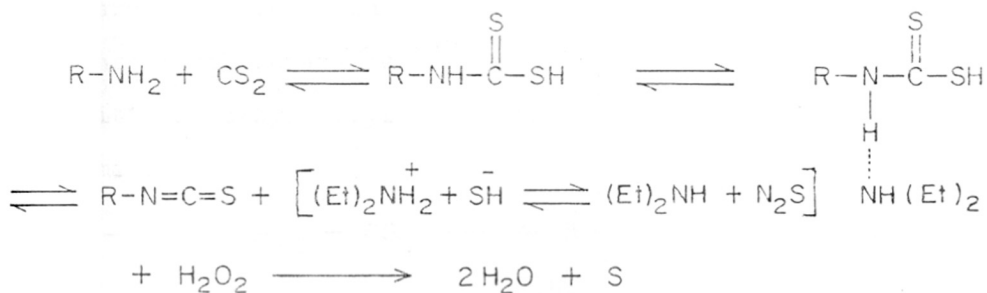

This one step reaction is suitable only for the preparation of aliphatic isothiocyanates. Thioureas are produced as byproducts.

(iv) Decompositions involving carbodiimides

Primary amines react with carbondisulphide and dicyclohexyl carbodiimides in a suitable organic solvent at temperatures below 0°C, forming isothiocyanate and 1,3-dicyclohexylthioureas. Aromatic amines react under identical conditions only with a one-half molar equivalent of carbodiimide, in presence of molar equivalent of triethyl amine to give isothiocyanates in very good yields.⁴⁸

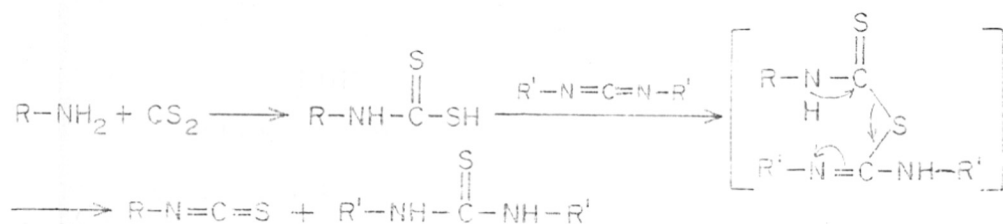
(v) Decompositions involving organosilicon compounds

N-Silylated primary aliphatic amines react with carbon disulphide giving rise to silyl esters of dithiocarbamic acid which are unstable above 0°C and decompose into isothiocyanates.⁴⁹ The decomposition is carried out with trimethyl silyl chloride in the presence of triethylamine.

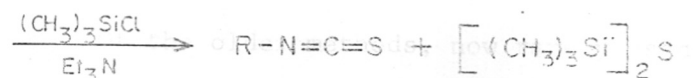
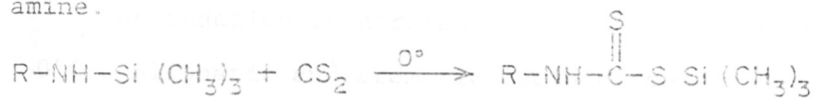

(vi) Other methods of decomposition

Recently two new modification of the dithiocarbamate method were published. Fujita and co-workers⁵⁰ obtained isothiocyanates in good yields under mild conditions by decomposing triethylammonium N-substituted dithiocarbamates with N,N'-disubstituted propiolamines.

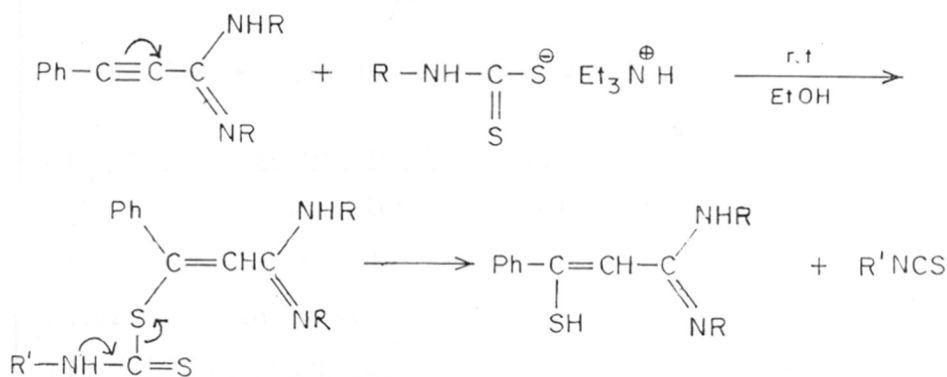

The second modification published by Sakai and co-workers⁵¹ is based on the reaction of lithium-dithiocarbamate with butyllithium and carbon disulphide.

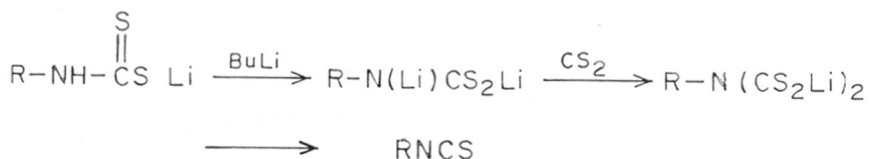

The reaction is carried out in DMF under nitrogen at 0°C. Aliphatic and aromatic isothiocyanates were prepared in high yields using this method.

Of the older methods, now rarely used, the decomposition of dithiocarbamate with iodine via thiuramdisulphide should be mentioned.⁵² Dithiocarbamate is first oxidized

with an alcoholic solution of iodine at a low temperature to thiuramdisulphide. Its sodium salt obtained in an alcoholic solution of sodium ethoxide is subsequently oxidized to the corresponding isothiocyanate.

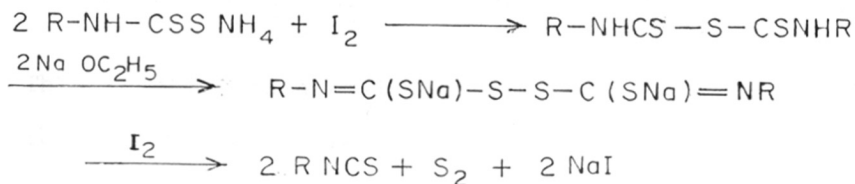

(c) Decomposition of Thioureas

Aromatic isothiocyanates can be prepared by the decomposition of sym diarylthioureas with acids or their anhydrides. The most frequently used acids are hydrochloric acid,⁵³⁻⁵⁶ sulphuric acid⁵⁷ and phosphoric acid. The salt of the corresponding arylamine is formed as byproduct.⁵³

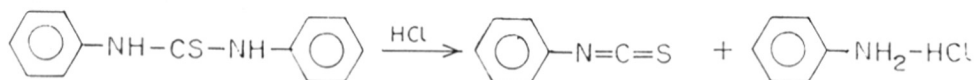

In addition to aromatic isothiocyanates, cyclohexyl isothiocyanate⁵⁴ was prepared by the treatment of dicyclohexylthiourea with phosphoric acid. Of carboxylic anhydrides, acetic anhydride is the best.⁵⁸

Isothiocyanates are obtained also by the decomposition of N-monoaryl thioureas during prolonged heating in chlorobenzene.⁵⁹

(d) Alkali Thiocyanate and Organic Halides

Sodium, potassium or ammonium thiocyanate reacts with an organic halide to give an organic thiocyanate which on heating is converted to the isothiocyanate.

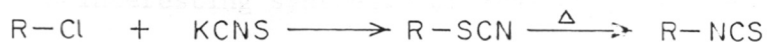

This reaction is normally carried out by heating the reactants in equimolecular proportion (sometimes a slight excess of thiocyanate is used) in an inert solvent like benzene.⁶⁰

(e) Sandmeyer Reaction

An aromatic amine is diazotised and the diazonium salt is treated with copper thiocyanate and subsequently heated to yield isothiocyanate.

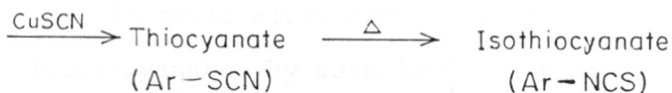
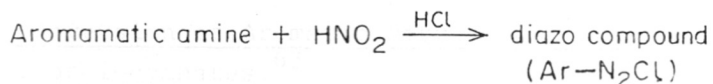
(f) Addition of Sulphur to Cyanides

In a recent patent,⁶¹ organic isothiocyanates have been prepared by heating an organic halide, an alkali metal cyanide and sulfur in presence of an oxygenated organic solvent such as aliphatic aldehyde or ketone.

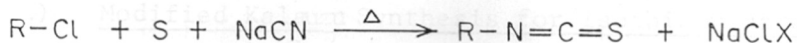

In view of the simplicity and availability of the starting material, this method is suitable for large scale production.

(g) An interesting synthesis of aryl and alkyl isothiocyanates has been recently reported by Shijuyoshi Sakai and co-workers.⁶² The method is essentially based on the thermal decomposition of bromo magnesium N-aryl or N-alkyl bromomagnesium dithiocarbamate prepared in situ from amines, carbondisulphide and Grignard reagent. High yield of isothiocyanates were obtained.

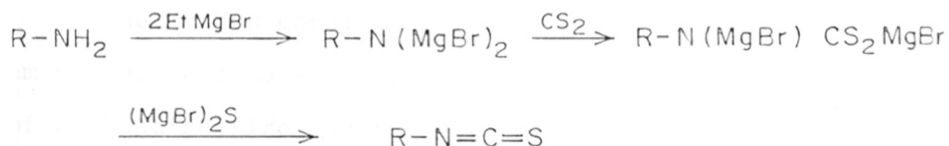

(h) Conversion of Aromatic Nitro Compounds to Isothiocyanates.⁶³

Aromatic nitro compounds are converted into their isothiocyanates by autoclaving a mixture of nitro compound, with carbon disulphide and an alkali metal phenoxide or an aryl sulphide at 150-170°C. About 71% conversion is obtained.

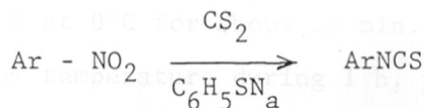

(i) Modified Kalauza Synthesis for Isothiocyanates⁶⁰

Joe E. Hodgkins et al.⁶⁴ have worked out an excellent

method for preparation of aryl isothiocyanates. This method is applicable to aromatic amines with: (a) Base strengthening groups, (b) Mild base weaking, and (c) No substituent. The method is not applicable to aromatic amines with strong electron-withdrawing groups. The synthesis is slower for phenyl isothiocyanates than generally accepted methods, but use of lead nitrate and steam distillation is avoided. The method is more generally applicable than decomposition of thiourea derivatives; does not employ phosgene or thiophosgene and overall gives better yields.

The method consists of dissolving amine in minimum amount of benzene and treated with equimolecular quantity of carbondisulfide and triethylamine and the solution is cooled to 0°C. The triethylammoniumdithiocarbamate salt precipitates out. After completion of the precipitation of the salts, the solids are filtered, washed with anhydrous ether and the solid air dried for about 10 min.

The salt is then dissolved in calculated quantity of chloroform and ethyl chloro carbonate is added dropwise during 15 min. with agitation. The resulting solution is stirred at 0°C for about 10 min. and then allowed to warm to room temperature during 1 h. period. The chloroform solution is then washed with 3N HCl and twice with water and dried over sodium sulfate. The chloroform is distilled

off under reduced pressure and aryl isothiocyanate is either distilled or crystallized from ethanol, depending upon the state of the compound.

In the present investigation various substituted phenyl isothiocyanates were prepared using modified Kaluza's synthesis.

One serious limitation of the above synthesis is that in many cases the isolation of the dithiocarbamate salt is difficult. To circumvent this problem another modification was incorporated by me so as to avoid the isolation procedure. The procedure involves the use of carbondisulfide itself as a reactant and a solvent.

The amine was refrigerated with one equivalent of triethylamine and carbondisulfide overnight. CS_2 was removed under vacuo and the reaction mixture was treated with ethyl chloroformate in chloroform at $0^\circ C$ and was worked up as usual. The yields obtained were comparable to those observed in the Hodgkin's method.

The following substituted phenyl isocyanates were prepared.

1. p-n-Butoxy phenyl isothiocyanate
2. p-n-Amyloxy phenyl isothiocyanate
3. p-n-Hexyloxy phenyl isothiocyanate

2-3.0 CONDENSATION OF SUBSTITUTED PHENYL ISOTHIOCYANATES WITH VARIOUS AMINO ACIDS, AROMATIC/HETEROCYCLIC AMINO COMPOUNDS WITH OR WITHOUT CARBOXYLIC ACID GROUP

A number of phenyl thiocarbamoyl amines were synthesized by reacting the amino group of various amino acids as alkali salts with p-alkoxyphenyl isothiocyanates. The sodium salts of the corresponding amino acids were prepared by neutralizing an alcoholic solution of the amino acid with 10% sodium hydroxide solution using phenolphthalein as an indicator. The thiocarbomyl derivative thus formed either separated as its sodium salt or an acidification, the desired thiourea precipitated out of the reaction mixture.

The p-alkoxy (butoxy, amyloxy, and hexyloxy) phenyl isothiocyanates were condensed with following amino acids.

1) Glycine

The reactions of glycine with phenyl isothiocyanates has served as the basis for the method of preparation of substituted 2-thiohydantoins.⁶⁵

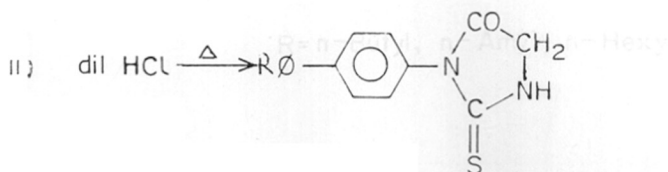
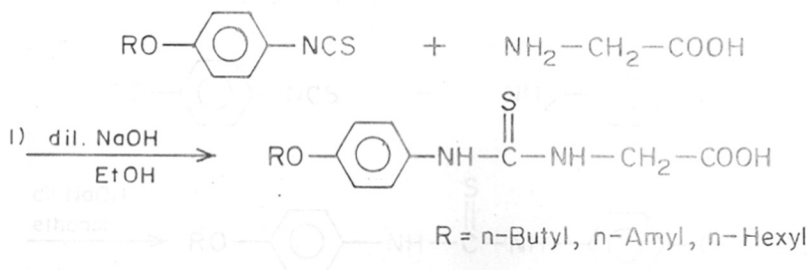

In the first step reaction conditions ensure the formation of the addition product, i.e. the thiourea and in the second step, i.e. cyclisation is achieved by boiling the thiourea in hydrochloric acid solution. In the present investigation glycine was neutralized by 10% sodium hydroxide in ethanol using phenolphthalein indicator and then refluxed with the substituted phenyl isothiocyanate which yielded the desired 1-[acetic]-3-[p-n - alkoxy phenyl]-2-thiourea.

The presence of carboxylic acid group ($3200, 1780 \text{ cm}^{-1}$) and the thiourea moiety ($1470, 1350 \text{ cm}^{-1}$) in IR confirmed the structure of the compound. PMR showed a downfield methylene doublet ($\delta 4.5$) as a characteristic of the glycylyl group. For a typical IR and PMR, see Figs. I(a) & I(b).

2) p-Aminophenylacetic acid (PAPA)

p-Aminophenylacetic acid was reacted in the same way as glycine with the corresponding substituted phenyl isothiocyanates to yield the required 1-[4' phenyl acetic]-3-[p-n-alkoxy phenyl]-2-thiourea.

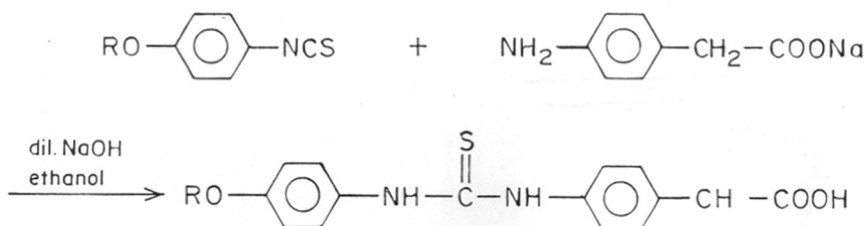

R = n-Butyl, n-Amyl, n-Hexyl

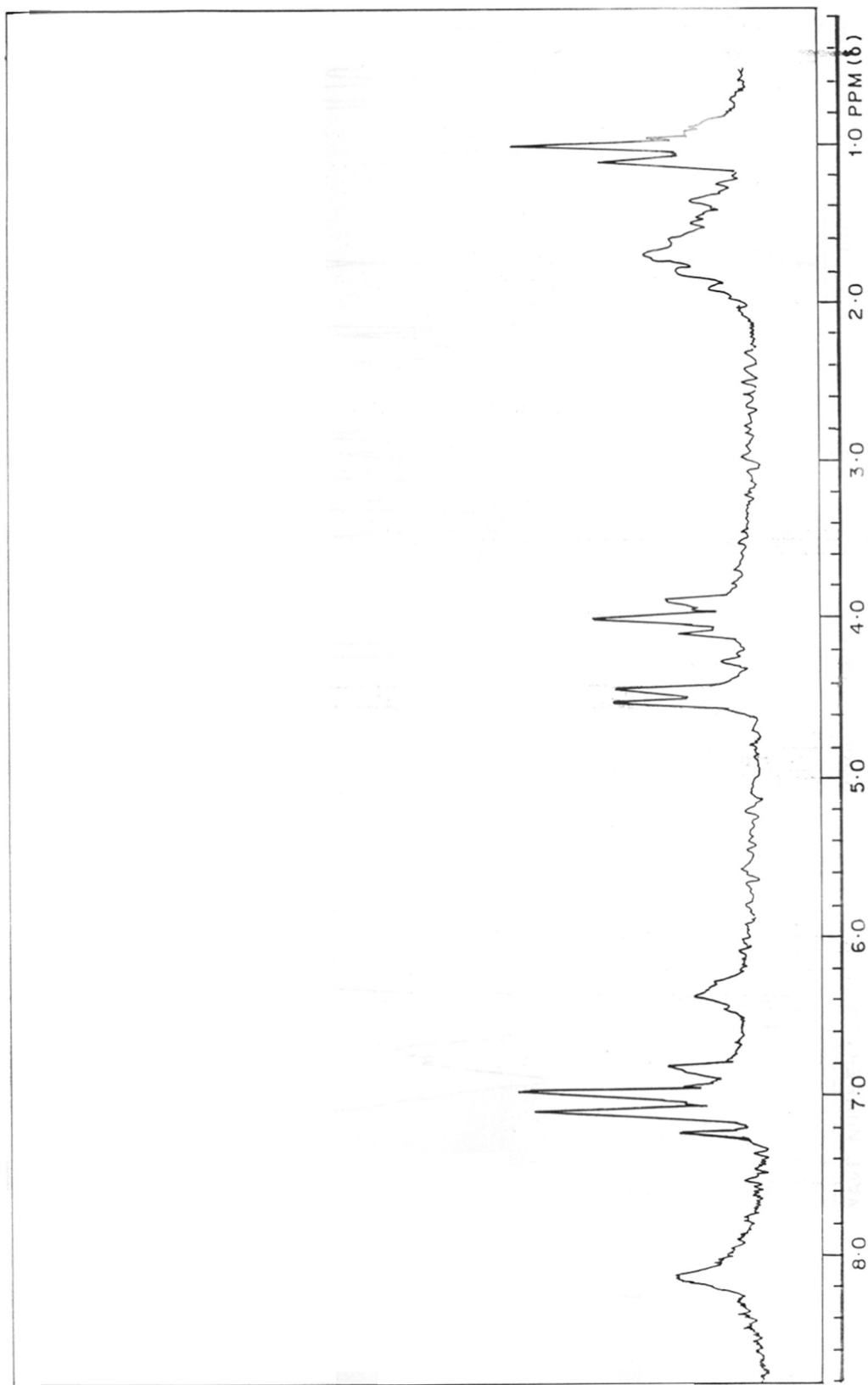

FIG. 1(a). PMR SPECTRUM OF COMPOUND 2

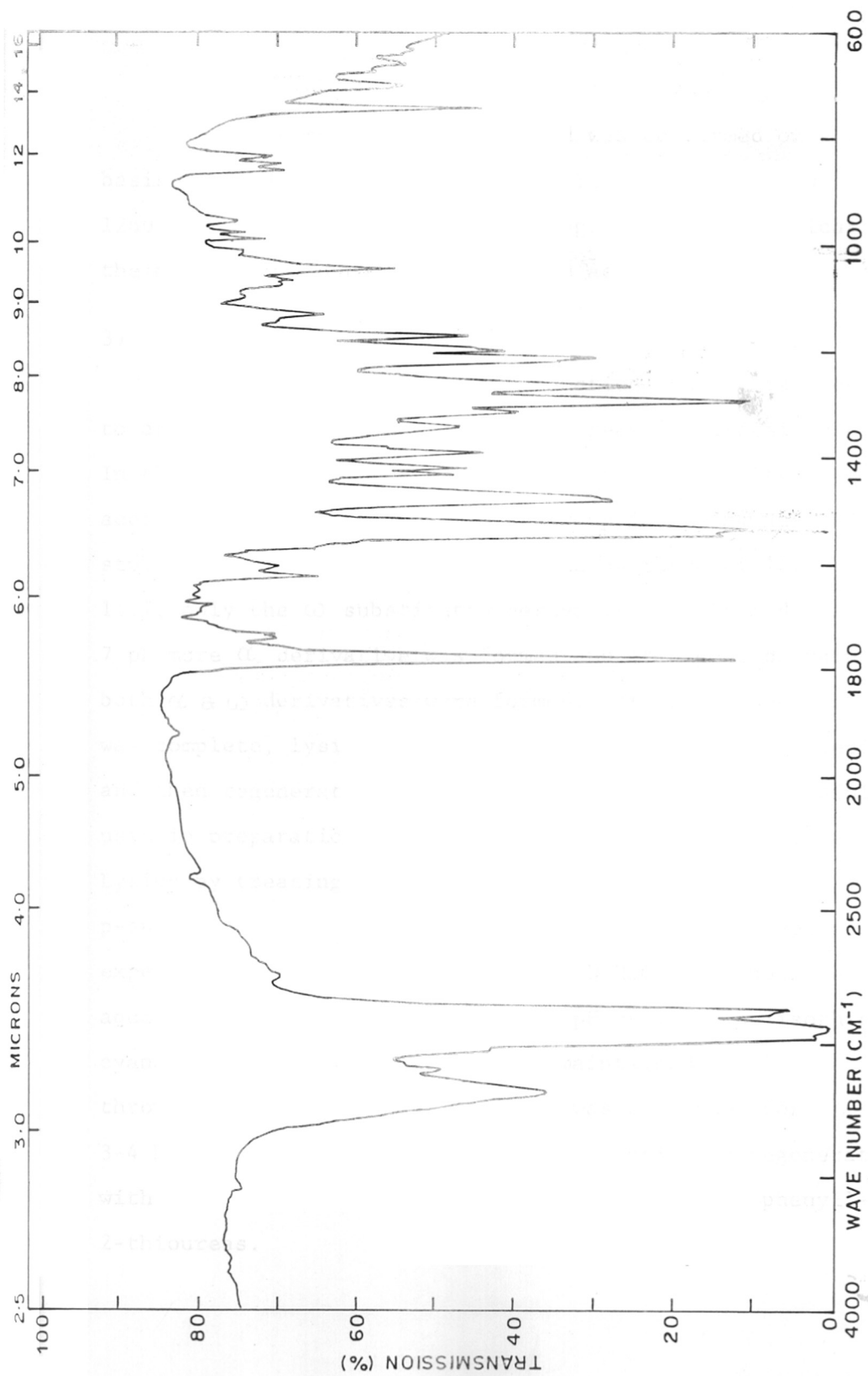

FIG. I (b). IR SPECTRUM OF COMPOUND 1

The structure of the compound was confirmed on the basis of IR [-COOH (3210, 1720 cm^{-1}), -NH-C(=S)-NH- (1390, 1260) and PMR which exhibited a singlet at 4 ppm indicating the methylene group attached to the acid.

3) Condensation with Lysine

Lysine contains two amino functions and it is necessary to ascertain which amino group will react in isothiocyanate. In this connection, the effect of pH on selectivity of acetylation of the end amino group in Lysine has been studied.⁶⁶ It was found that in the pH range of 10.6 to 11.7, only the ω substituted derivative was formed. At 7 pH more α derivative was formed and at higher pH values both α & ω derivatives were formed. After the acetylation was complete, lysine was absorbed on an ion exchange resin and then regenerated. The above principle was successfully used in preparation of the thio carbamido derivative of Lysine by treating Lysine monohydrochloride with the p-substituted phenyl isothiocyanates. Thus in a typical experiment Lysine was treated with 2N NaOH in a buffered aqueous solution so as to attain a pH of 11. The isothiocyanate was added dropwise and pH maintained at 11 throughout addition. The reaction was continued for 3-4 h, absorbed on Dowex 50 (H^+ form) resin and regenerated with ammonia to yield 1-[ω lysyl]-3-[p-n-alkoxy phenyl]-2-thioureas.

p-n-alkoxy phenyl]-2-thioureas.

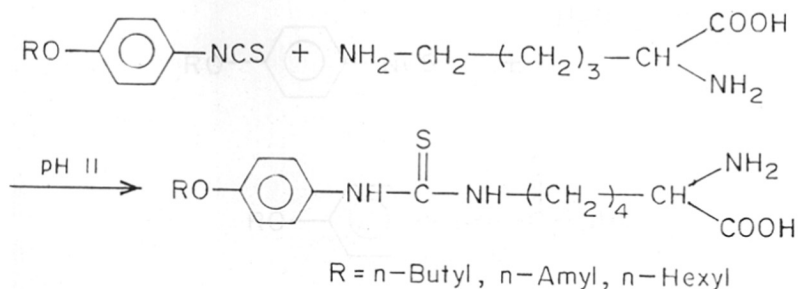

It was also reported that protection of the α amino group in Lysine can be made using a copper complex thus leaving the amino group free for reactions. However, in this case, the reaction with isothiocyanates failed.

4) 5-Amino-uracil

5-Amino-uracil is known⁶⁷ to react with isothiocyanates to give thiourea. However the same reaction does not apply to 6-amino uracil. A C-alkylation is observed in case of 6-amino uracil due to the nucleophilicity of that carbon atom. However in 5-amino uracil as the anion cannot be

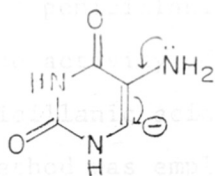

5-Amino uracil

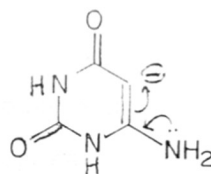

6-Amino uracil

stabilized by the carbonyl group only the amino group reacts with the isothiocyanates.

5-Amino uracil was prepared by known procedures^{68,69} and then reacted with corresponding p-substituted phenyl isothiocyanates to give the desired 1-[5'-uracil]-3-[p-n-alkoxy phenyl]-2-thioureas.

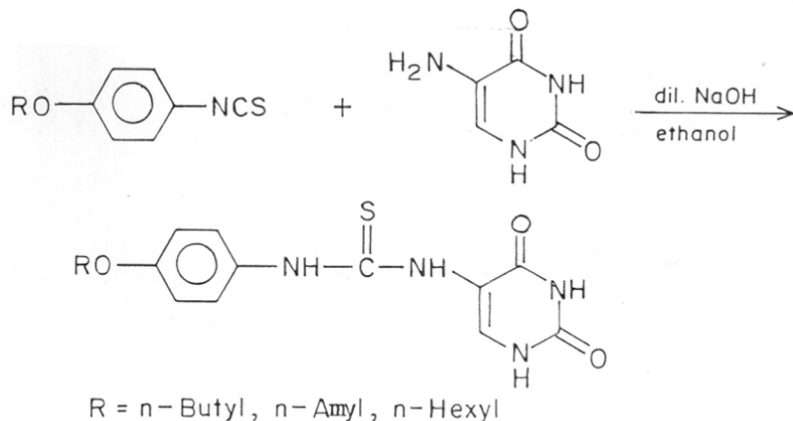

PMR spectrum showed the uracil protons in the downfield region (8-12 ppm) along with the butoxyl and aromatic protons [Fig. II (a)]. The bands for the (C=O 1710 cm^{-1} , 1690 cm^{-1}) and thiourea (1470 cm^{-1}) were observed in the IR spectra.

5) 6-Aminopenicillanic acid (6-APA)

Ermolaeva et al.⁷⁰ synthesized various thiocarbamides by condensation⁷¹ of substituted phenyl isothiocyanates with 6-amino penicillanic acid. However they have not reported the activity of the triethylamine salt of 1'-[6'-penicillanic acid]-3-[p(n)-butoxy phenyl]-2-thiourea. The same method was employed in preparation of thiocarbamides.

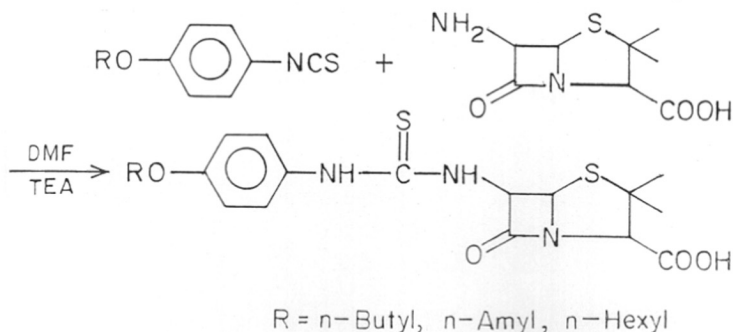

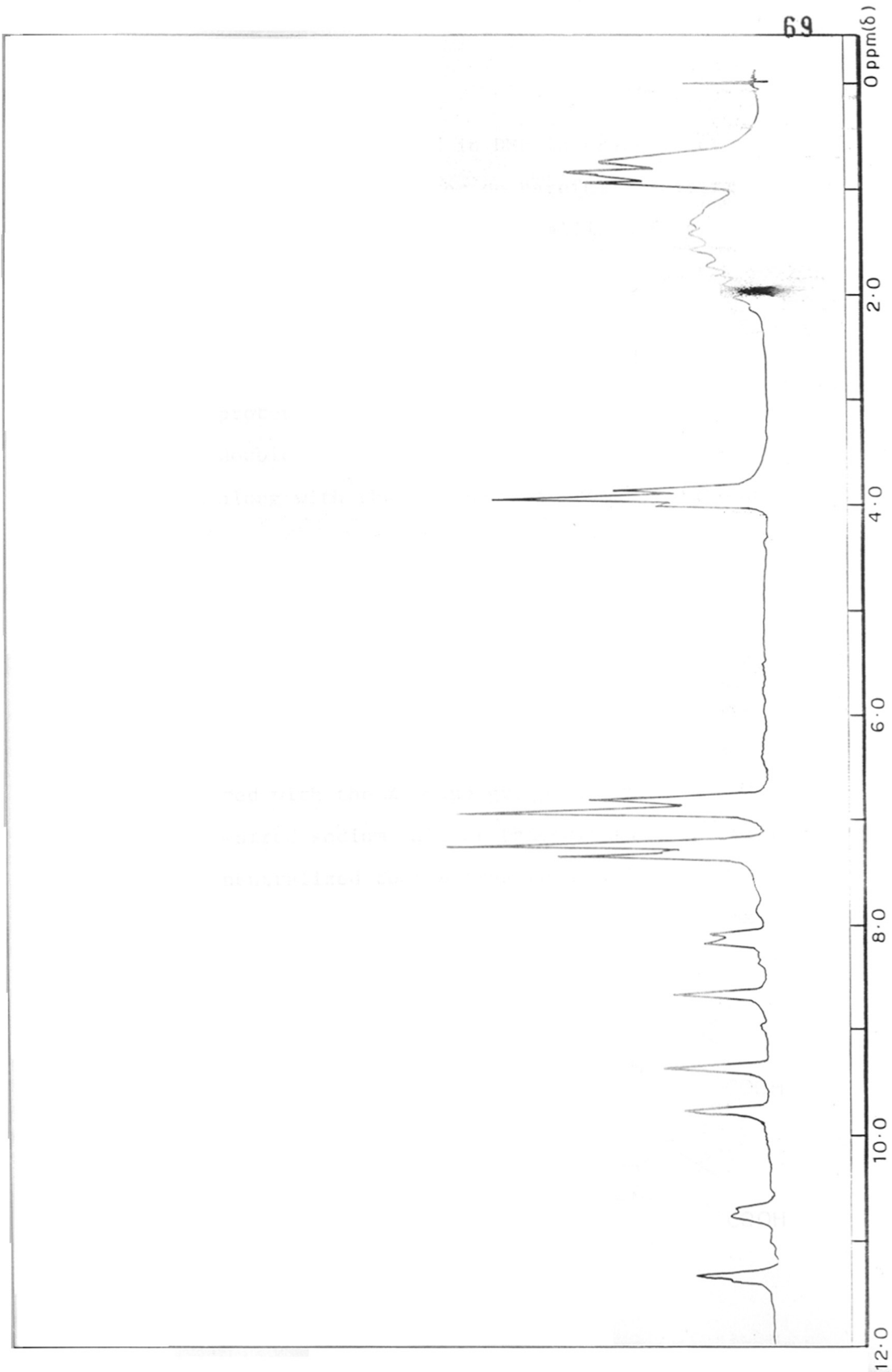

FIG. II (a). PMR SPECTRUM OF COMPOUND 4

The reaction was carried out in DMF in presence of triethylamine at 0°C and later on carefully acidified to give the free acid which was recrystallized from benzene: pet. ether.

The IR spectra of the above compounds showed a band at 1730 cm^{-1} signifying the presence of β -lactam ring. The α protons of the β lactam ring appearing as downfield doublets which further supported the structure along with the presence of aromatic nucleus.

6) Ampicillin (6-[α amino phenyl acetamido] penicillanic acid)

The sodium salt of ampicillin was prepared by carefully neutralizing its ethanolic solution with dil. sodium hydroxide using phenolphthalein indicator. To this was added p-substituted phenyl isothiocyanates which reacted with the α amino group of ampicillin to give the desired sodium salt of thiocarbamido derivative which was neutralized to the free acid to get 1-[α -(6'-[phenylacetamido] penicillanic acid)]-3 [p-(n)-alkoxy phenyl]-2 thioureas.

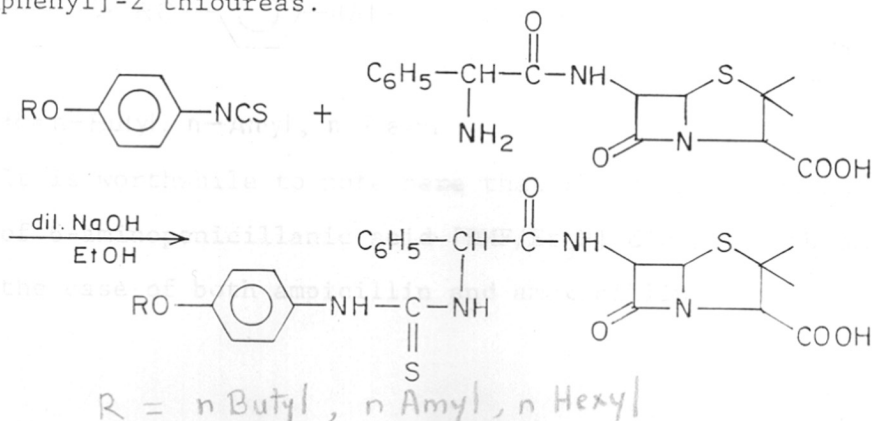

The IR spectrum showed the carbonyl stretching for the cyclic amide [1730 cm^{-1}] and phenylacetamido group (1660 cm^{-1}) along with the carboxylic acid. The presence of the p-alkoxy side chain attached along with the ampicillin moiety was confirmed by PMR. A typical PMR is depicted in Fig.III.(a) (Hexyl) and (b).

7) Amoxicillin: 6-[α -amino-p-hydroxy phenylacetamido]-penicillanic acid

Amoxicillin was condensed with p-substituted alkoxy phenyl substituted isothiocyanates in the same way as in ampicillin by neutralizing it with 2 equivalents of dil. sodium hydroxide and reacting with the desired phenyl isothiocyanate to obtain 1-[α -(6'-[p-hydroxy phenylacetamido] penicillanic acid)]-3 [p-(n)-alkoxy phenyl]-2 thioureas.

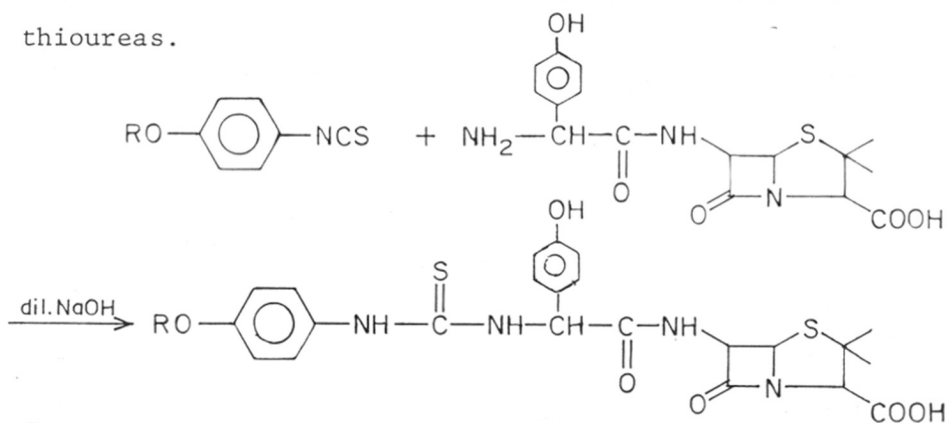

R = n-Butyl, n-Amyl, n-Hexyl

It is worthwhile to note here that the method used in case of 6-aminopenicillanic acid [DMF/ Et_3N] did not work out in the case of both ampicillin and amoxicillin.

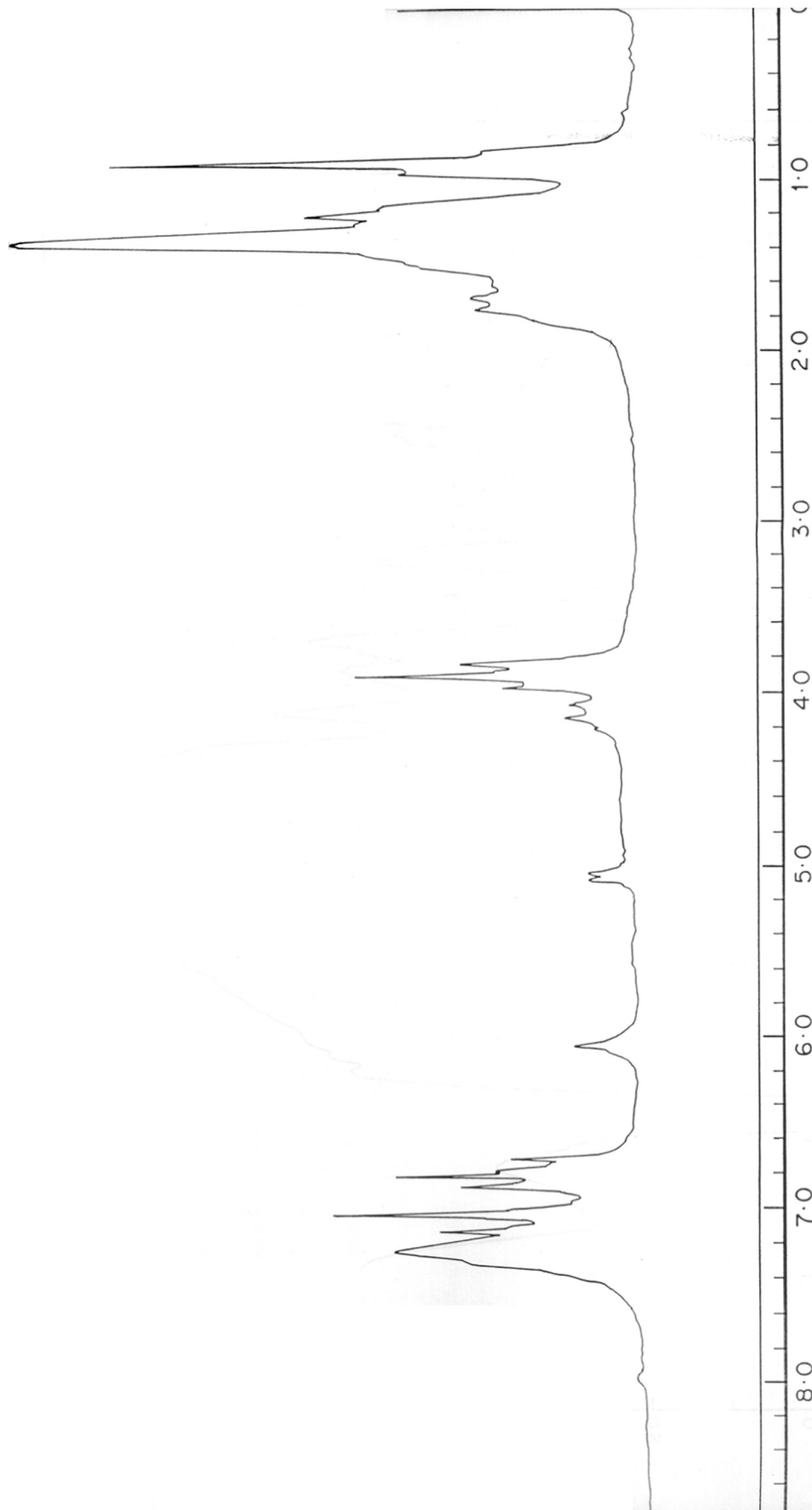

FIG. 11 (a). PMR SPECTRUM OF COMPOUND 6

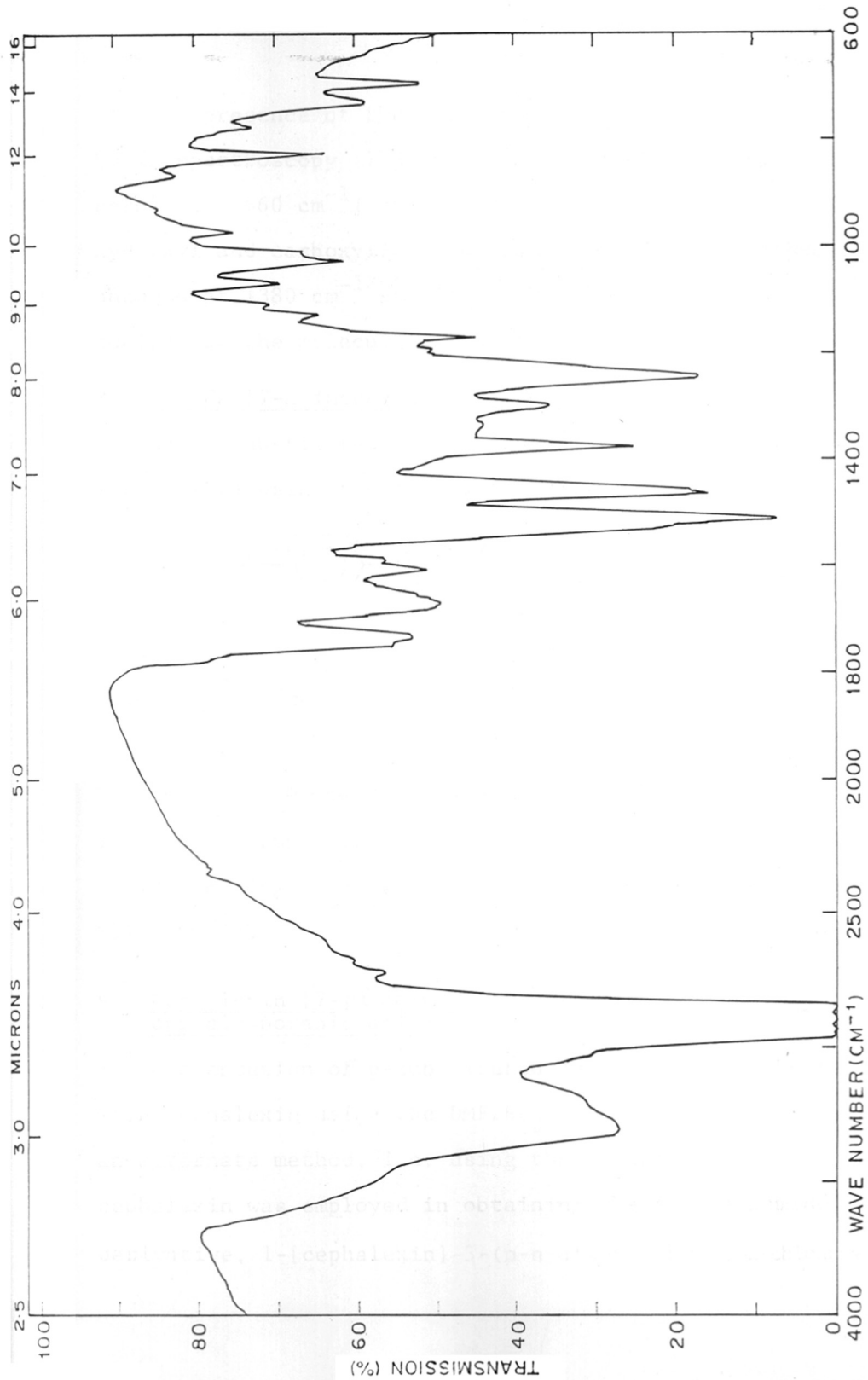
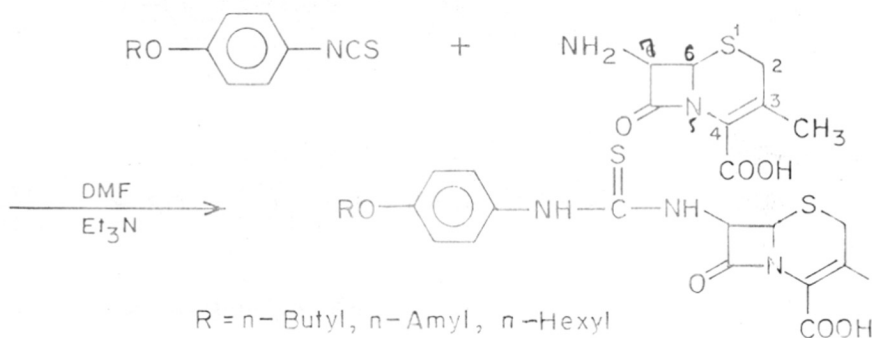

FIG. III (b). IR SPECTRUM OF COMPOUND 6

The presence of the β lactam ring was again confirmed by IR spectroscopy [1730 cm^{-1}] coupled with phenyl acetamido carbonyl [1660 cm^{-1}] and broad -OH stretching of phenolic hydroxyl and carboxylic acid group. ~~the C=O bending of~~ phenols at 1380 cm^{-1} signified the presence of a phenolic nucleus in the molecule.

8) 7-ADCA [7-aminodesacetoxycephalosporanic acid]

The p-substituted phenyl isothiocyanates were condensed with 7-ADCA using the method described by Ermolaeva et.al.⁷⁰



The IR spectrum showed the presence of -COOH group (1700 cm^{-1}), β lactam ring (1650 cm^{-1}) and the thiourea NH-C=S stretching (1470 cm^{-1}).

9) Cephalexin [7-(α aminophenylacetamido)des acetoxy cephalosporanic acid]

Condensation of p-substituted phenyl isothiocyanates with cephalexin using the DMF/ Et_3N method failed, hence an alternate method, i.e. using the sodium salt of cephalexin was employed in obtaining the thiocarbamido derivative, 1-[cephalexin]-3-(p-n-alkoxy phenyl)-2-thioureas.

Cephalexin i.e. 7-(α amino phenylacetamido)des acetoxyccephalosporanic acid] was neutralized using dil. sodium hydroxide solution and phenolphthalein indicator. An ethanolic solution of the isothiocyanate was stirred with this sodium salt to yield the desired 1-[α (7'-[phenyl acetamido] des acetoxyccephalosporanic acids)]-3-[p(n)-alkoxy phenyl]-2 thioureas.

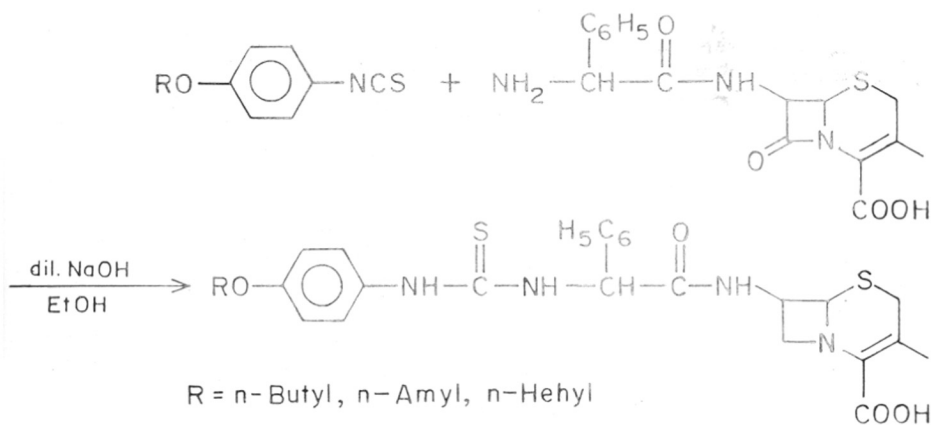

The NH-C=S (1475 cm^{-1}) indicated the presence of thiourea group along with the carbonyl stretching of the acid (1770 cm^{-1}) and the amido groups ($1680\text{-}1720\text{ cm}^{-1}$) signifying the β lactam ring. A typical IR and PMR have been given in Figs. IV(a) and IV(b).

All the above compounds mentioned in this part gave satisfactory micro analysis and thus were characterized by complementary structural determinations.

A detailed mass spectral study of the above compounds has been made which is described in the following part.

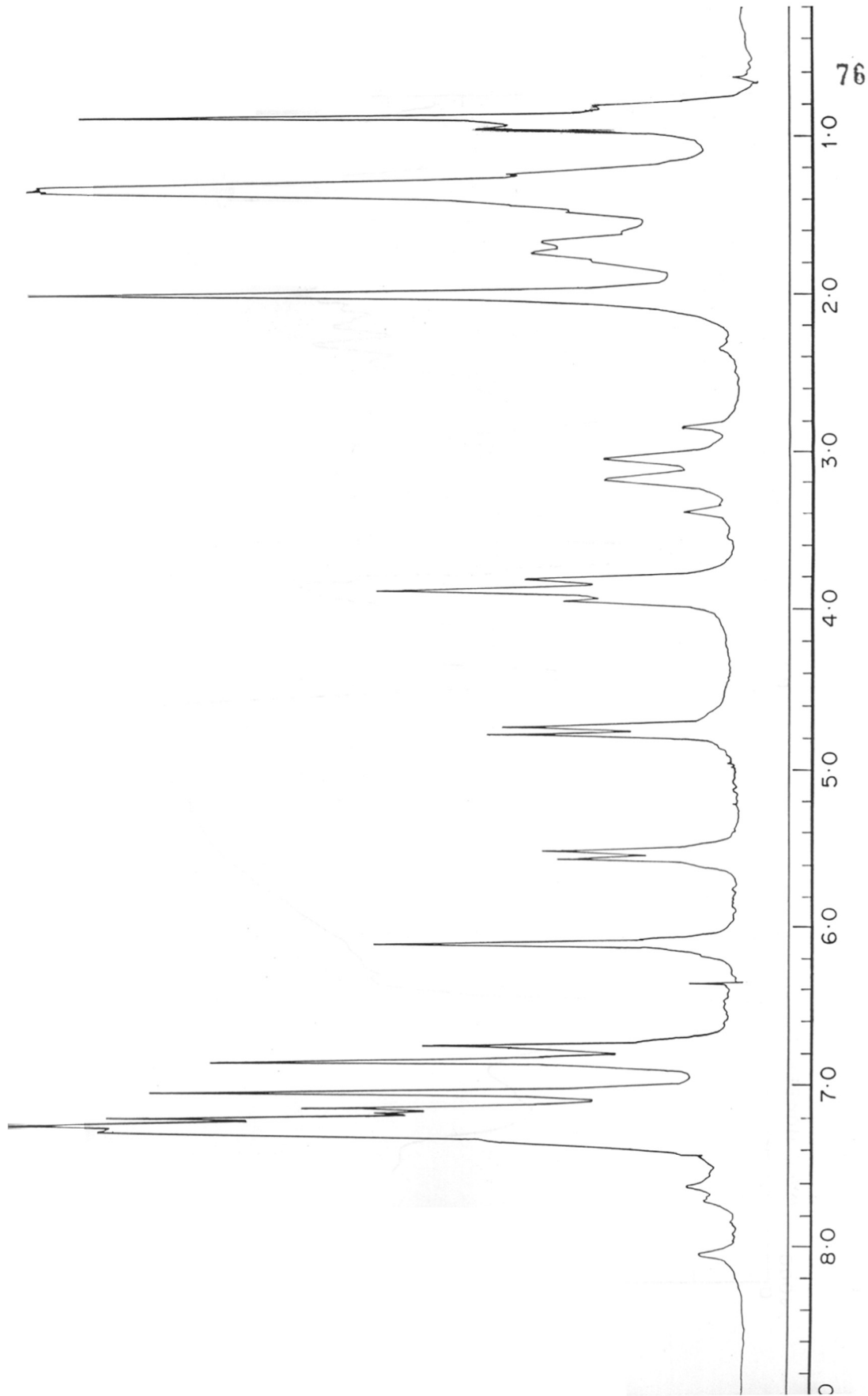
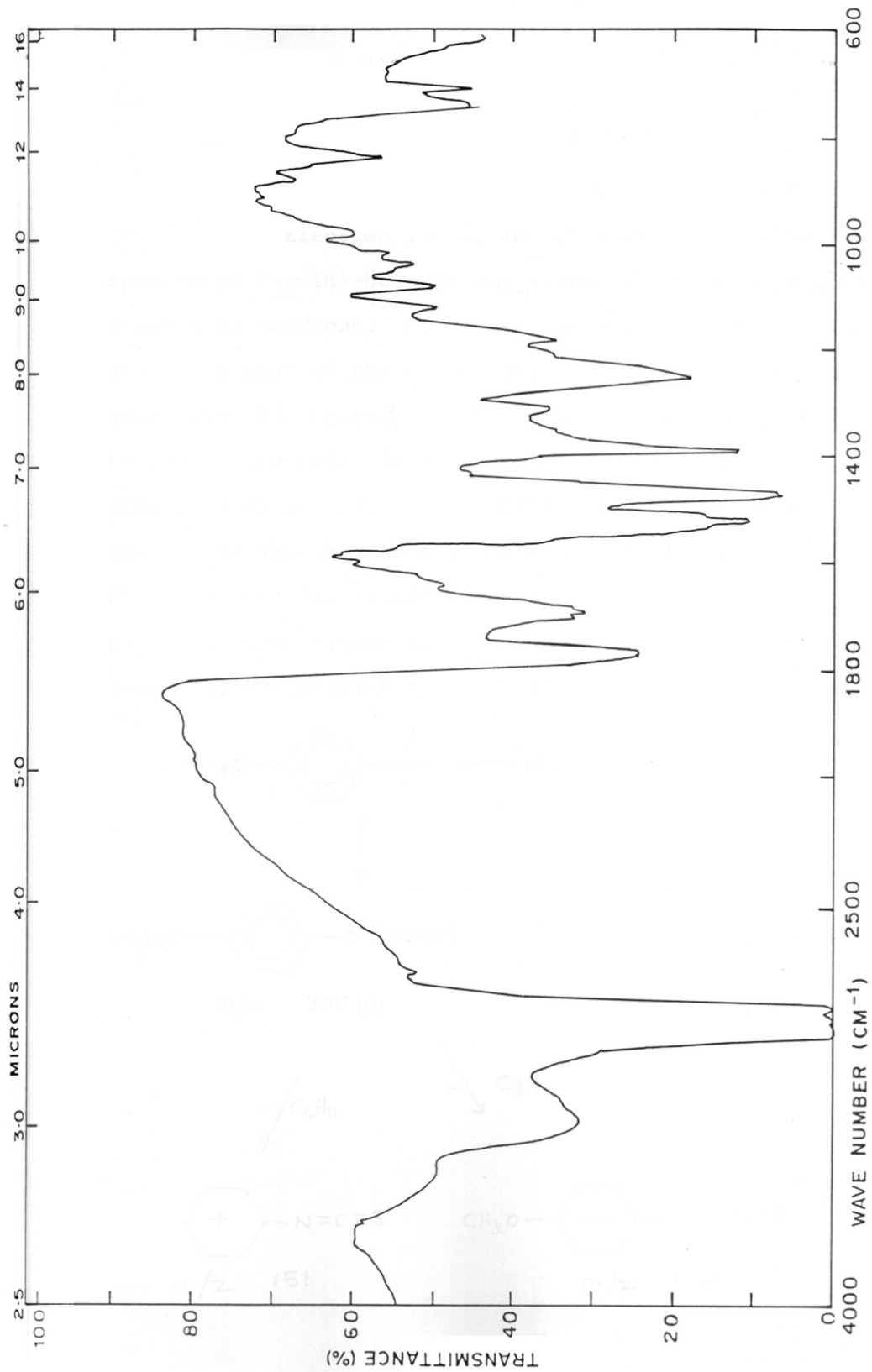

FIG. 14 (a): PMR SPECTRUM OF COMPOUND 9

FIG. IV (b). IR SPECTRUM OF COMPOUND 9



2.4-0 MASS SPECTRAL STUDIES OF N-p-(n)-BUTOXYPHENYL,
N'-SUBSTITUTED ACIDS AND THIOUREAS

Mass spectra of thioureas showed characteristic peaks.^{72,73} Electron impact and chemical ionization mass spectra of 1-p-(n)-butoxyphenyl-3-substituted acids 2-thioureas were examined. Molecular ions were insignificant or absent in most of the compounds. The cleavage α to the $-\overset{\text{S}}{\text{C}}-$ group with N-H hydrogen transfer was the characteristic fragmentation modes in most of the compounds. A characteristic peak at m/e 207 is present in all the compounds. Its genesis is ascribed to the cleavage of C=S group with hydrogen transfer resulting in the formation of p-(n)-butoxyphenyl isothiocyanate as shown below in the mass spectra of 1-[acetic]-3-[p-(n)-butoxyphenyl]-2-thiourea, Fig.V(BuGly).

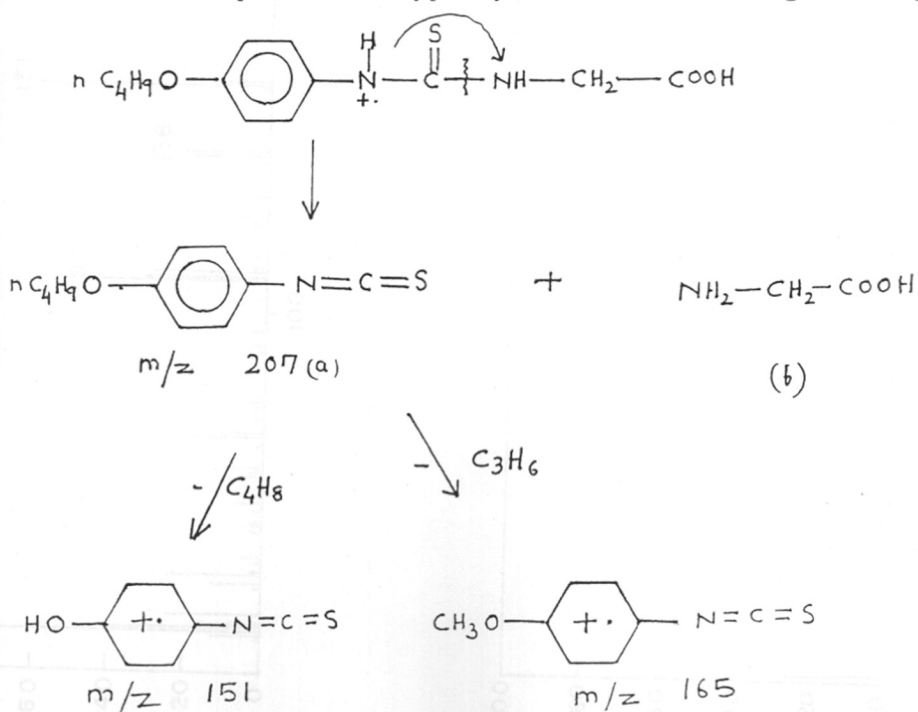

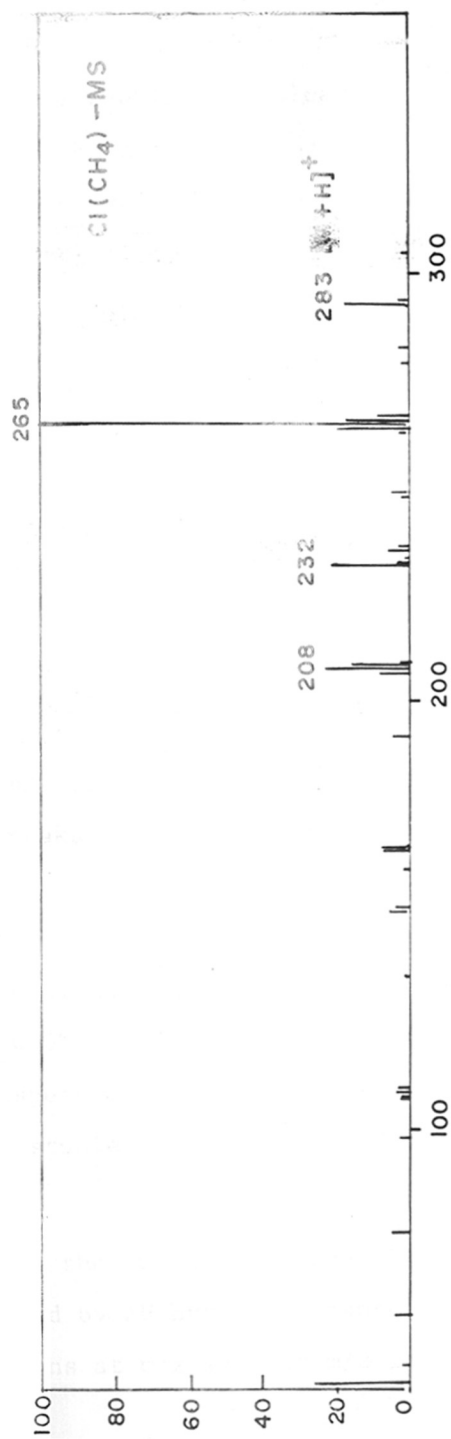
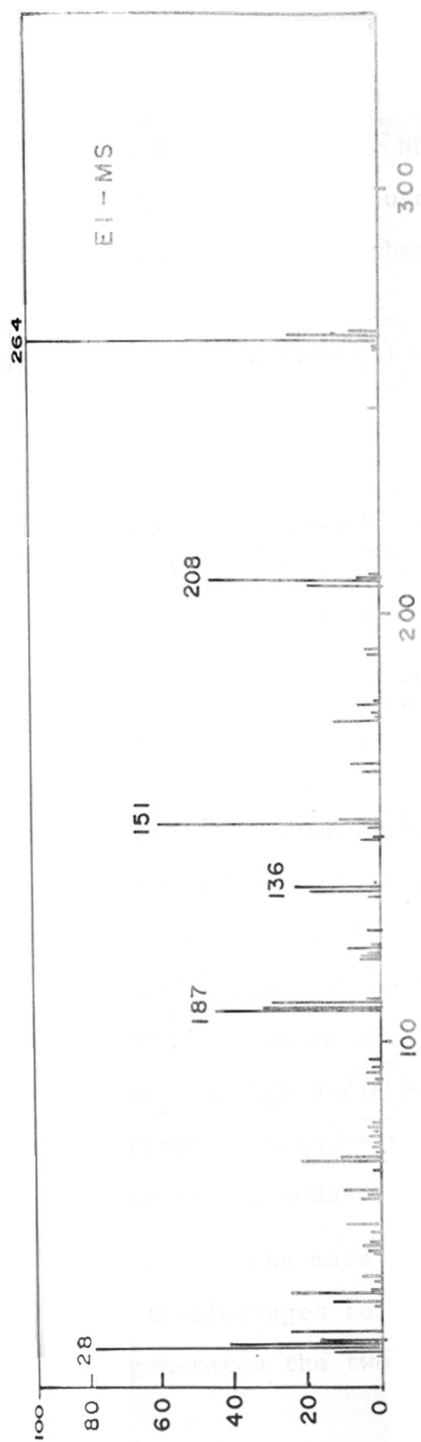

Bu-GLY FIG. V

The peak of m/z 165 could be a doublet. Cleavage of $C=S$ followed by NH hydrogen to the nitrogen atom attached to $p(n)$ -butoxyphenyl group could generate m/z 165 with $p(n)$ -butoxy phenyl amine structure as illustrated below.

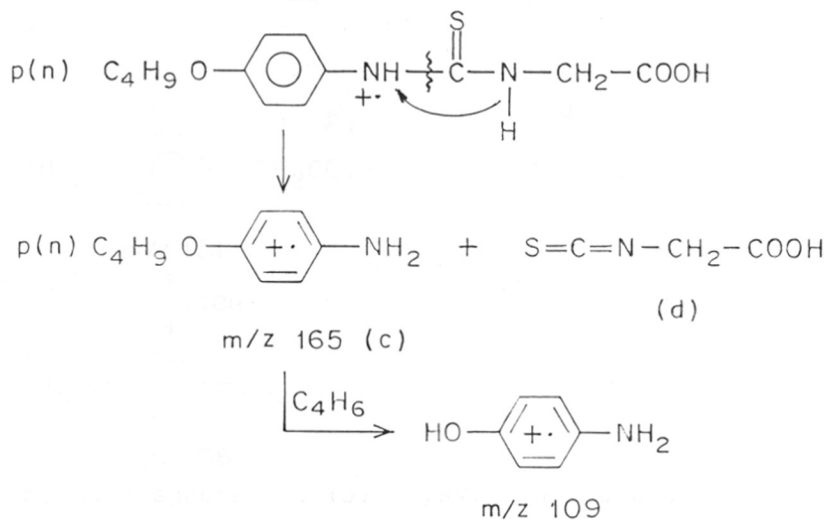

These characteristic group of peaks at m/z 207, 165, 151, 109 are present in all the spectra. The driving force for the reactions (1) and (2) is formation of substituted phenyl isothiocyanate ion in (1) and elimination of substituted isothiocyanate acid ($\text{S}=\text{C}=\text{N}-\text{CH}_2\text{COOH}$) leading to the formation of $p(n) \text{ C}_4\text{H}_9\text{O}-\text{C}_6\text{H}_4-\text{NH}_2^+$ ion respectively. The mass spectral fragmentation of the compounds studied reveals these fragmentation modes.

In the mass spectrum of (2) the two alternative α -cleavages to the $C=S$ followed by NH hydrogen transfer generates the two significant ions at m/z 193 and m/z 151

respectively along with m/z 207 of the *p*-*n*-butoxy phenyl isothiocyanate ion.

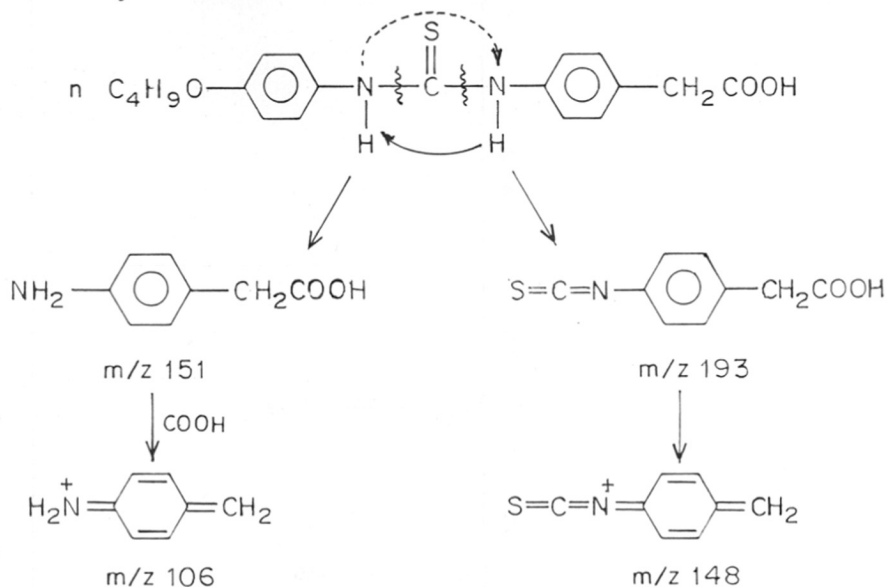

The mass spectra of (3) (Lysyl) did not show molecular ion and the peaks due to *p*-(*n*) butoxy phenyl isothiocyanate and its fragments were abundant in the spectrum with *p*-*n*-butoxy phenyl pseudo thiourea at m/z 224.

In the mass spectrum of (4) viz. 1-[5' uracil]-3-[*p*-*n*-butoxy phenyl]-2 thiourea, a weak molecular ion peak at 334 was shown along with the α -cleavage of C=S with N-H hydrogen transfer resulting in two significant peaks at m/z 165 and 169 respectively as shown below. (Fig. VI).

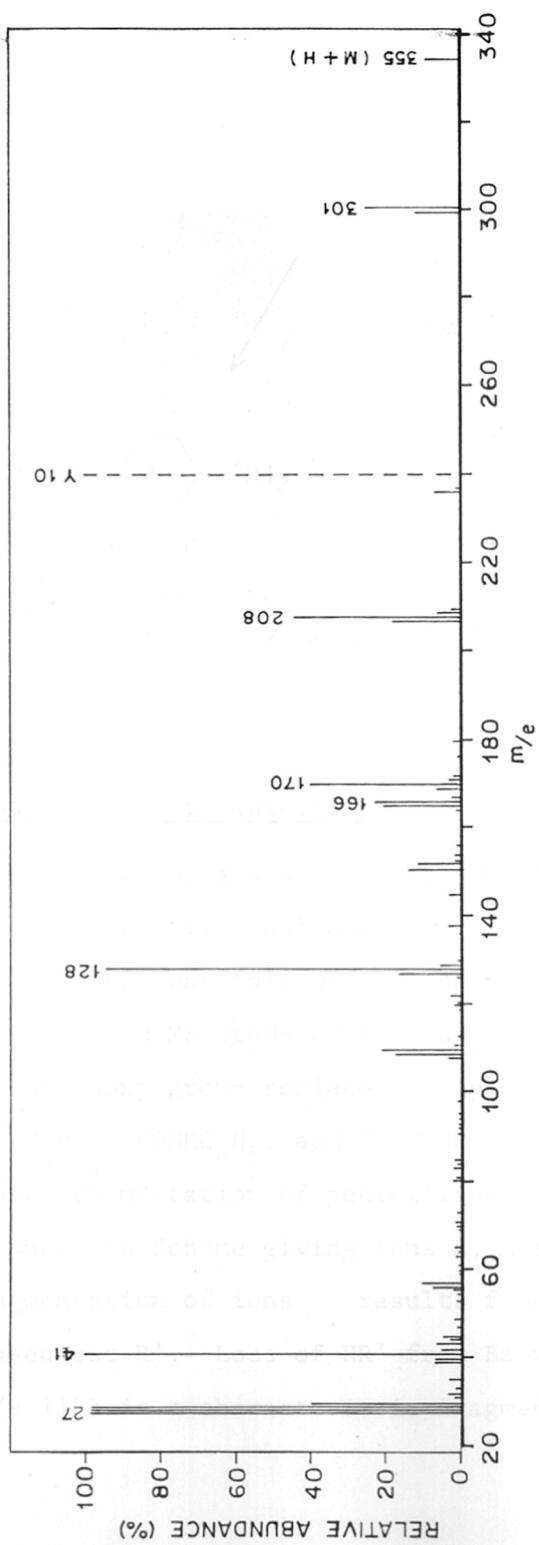

Bu URA FIG. VI

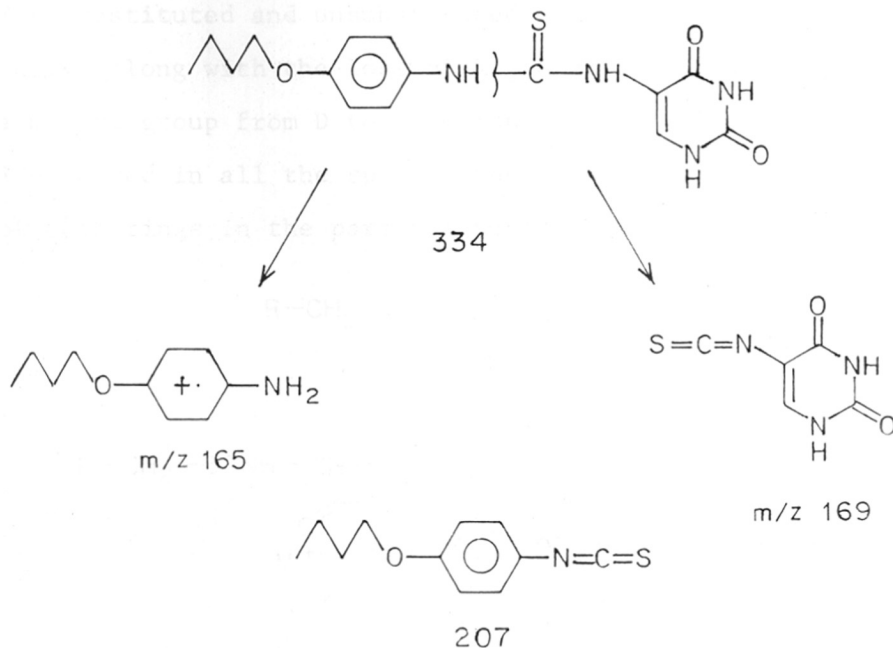

Mass Spectra of Penicillins

W. Richter and K. Biemann (Monatsh Chem. 95, 766 1964) reported detailed analysis of mass spectra of Penicillins G and V. This was followed by analysis of Bochkarev et al. who reported MS study of various penicillins in which carbomethoxy group replaced by cyano, CONH_2 , CONHC_4H_9 , $\text{CONHC}_6\text{H}_{11}$, CONHC_6H_5 , and $\text{CH}_2\text{CONHC}_6\text{H}_5$ groups. The most basic fragmentation of penicillins is cleavage of the ring as shown in Scheme giving ions A, B and C. Subsequent fragmentation of ions results from loss of the subsequent R'. Loss of HR' from Bz with formation of ion (m/e 114) is a characteristic fragmentation where $\text{R}' = \text{COOCH}_3$.

For substituted and unsubstituted amides this process occurs along with the loss of R' to give (m/e 115) and a methyl group from D to give ion E (m/e 100). Ions F occurred in all the spectra and is a result of scission of both rings in the parent ion.

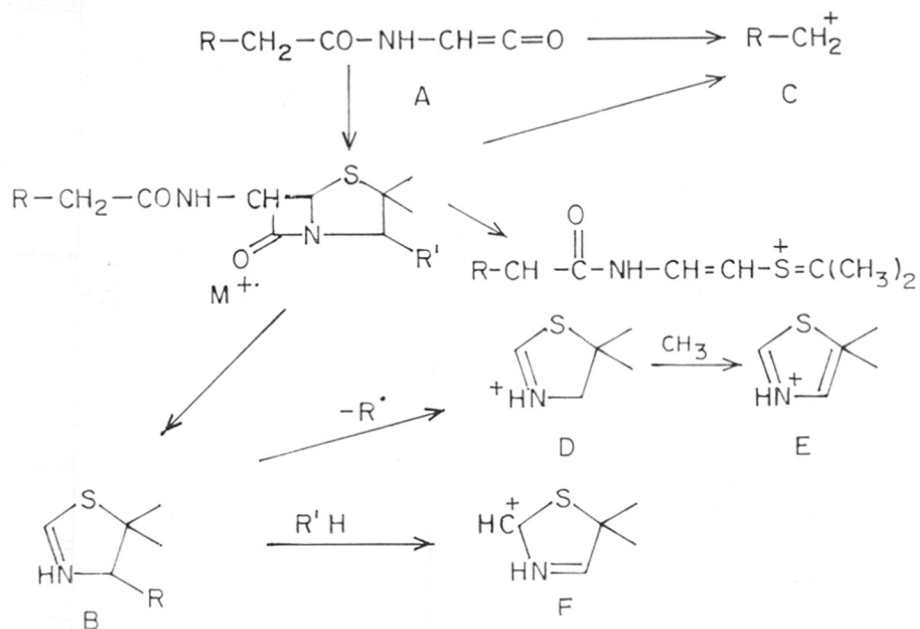

The mass spectrum of the compound 1-[6'-penicillanic acid]-3 [p(n) butoxy phenyl]-2 thiourea shows base peak at m/e 264 which is attributed to the fragment resulting from the cleavage of the ring along with the usual p-butoxy phenyl isothiocyanate ion m/e 207, (Fig.VII)

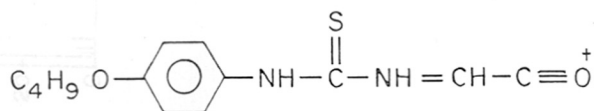

m/z 264

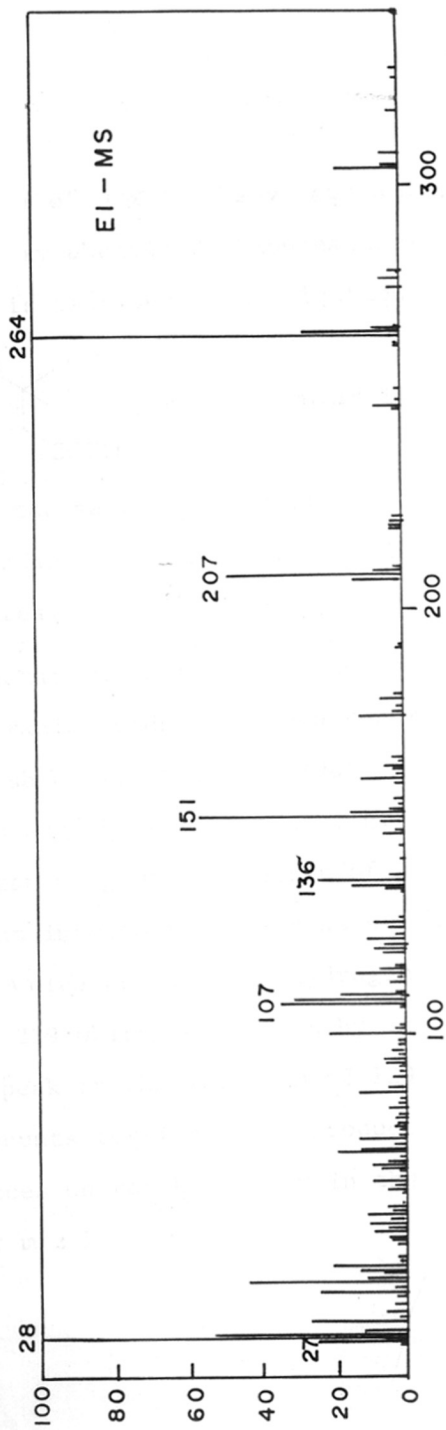
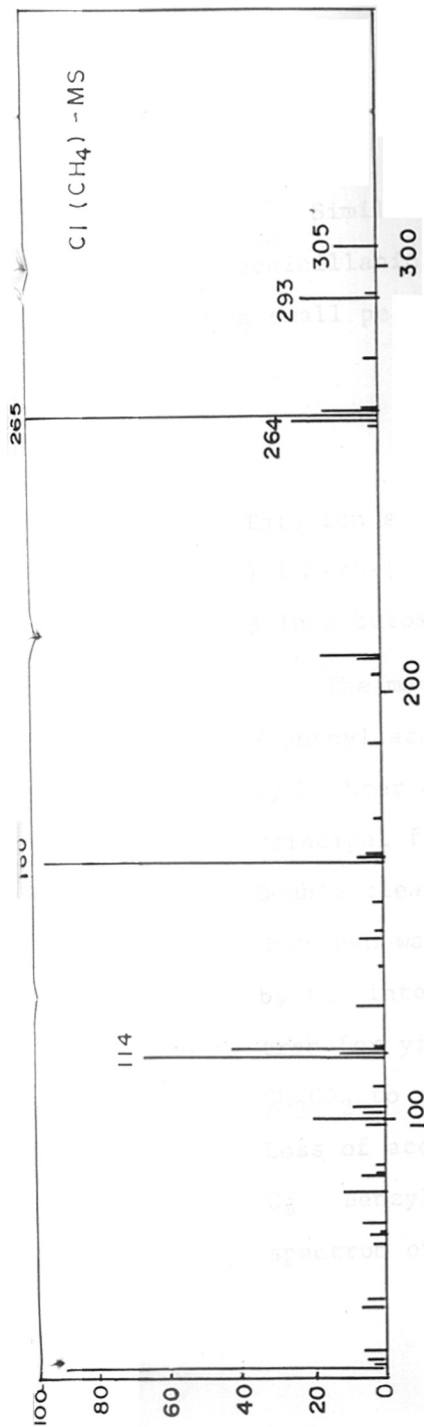

Similarly the mass spectrum of 1[α -(6'-phenyl acetamido) penicillanic acid]-3 [p-n-butoxy phenyl]-2 thiourea shows a small peak at m/e 340 which is ascribed to elimination of

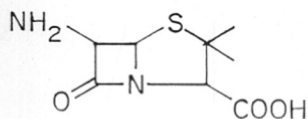

from molecular ion.

This ion shifts to m/z 356 in the mass spectrum of 1 [α -(6-[p-hydroxy phenyl acetamido] penicillanic acid)]-3 [p-n-butoxy phenyl]-2 thiourea.

The mass spectral fragmentation of methyl esters of 7-phenyl acetamido cephalosporanic acids have been reported by Richter and Biemann (Monatsh Chem., 96, 484, 1985). Principal fragmentation modes are shown in the scheme. Double cleavage of the β lactam ring with transfer of a hydrogen was observed to be an important process as evidenced by the intensity of the ion. A cleavage without hydrogen transfer yields ion B at m/z 229 which decomposes by loss of CH_3CO_2 to give C (the base peak in the spectrum of 129). Loss of acetoxyl radical accounts for ion Cf to produce Cg. Benzylic cleavage produces Ch the base peak in the spectrum of 1 at m/z 91 or m/z 107.

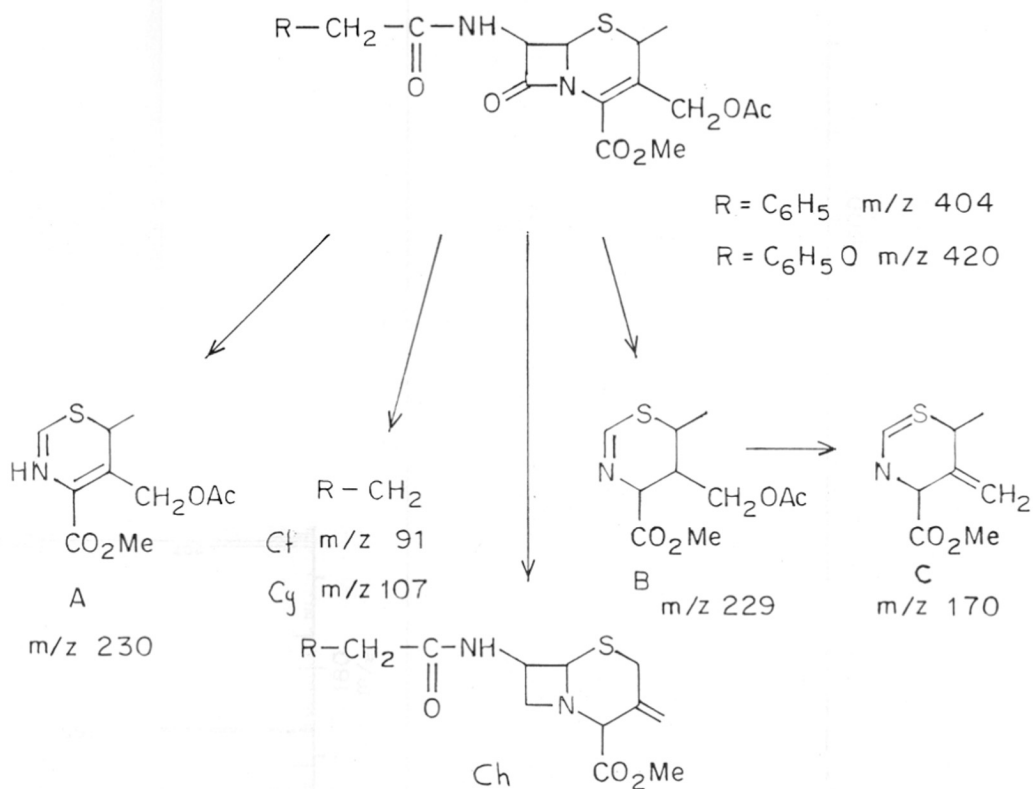

The mass spectrum of 1-[α -(7'-[phenyl acetamido] des acetoxy cephalosporanic acid)]-3-[p(n)-butoxy phenyl]-2 thiourea and 1-[7'-des acetoxy cephalosporanic acid]-3-[p-n-butoxy phenyl]-2 thiourea were studied. The p-(n)-butoxy phenyl isothiocyanate ion (m/e 207) was common to both the spectra accompanied by the usual fragmentation pattern. The former compound showed a significant molecular ion and peaks containing des acetoxy cephalosporanic acid moiety. C-H hydrogen transfer with elimination of 7-amino des acetoxy cephalosporanic acid was evident. (Fig. VIII, BuCeP).

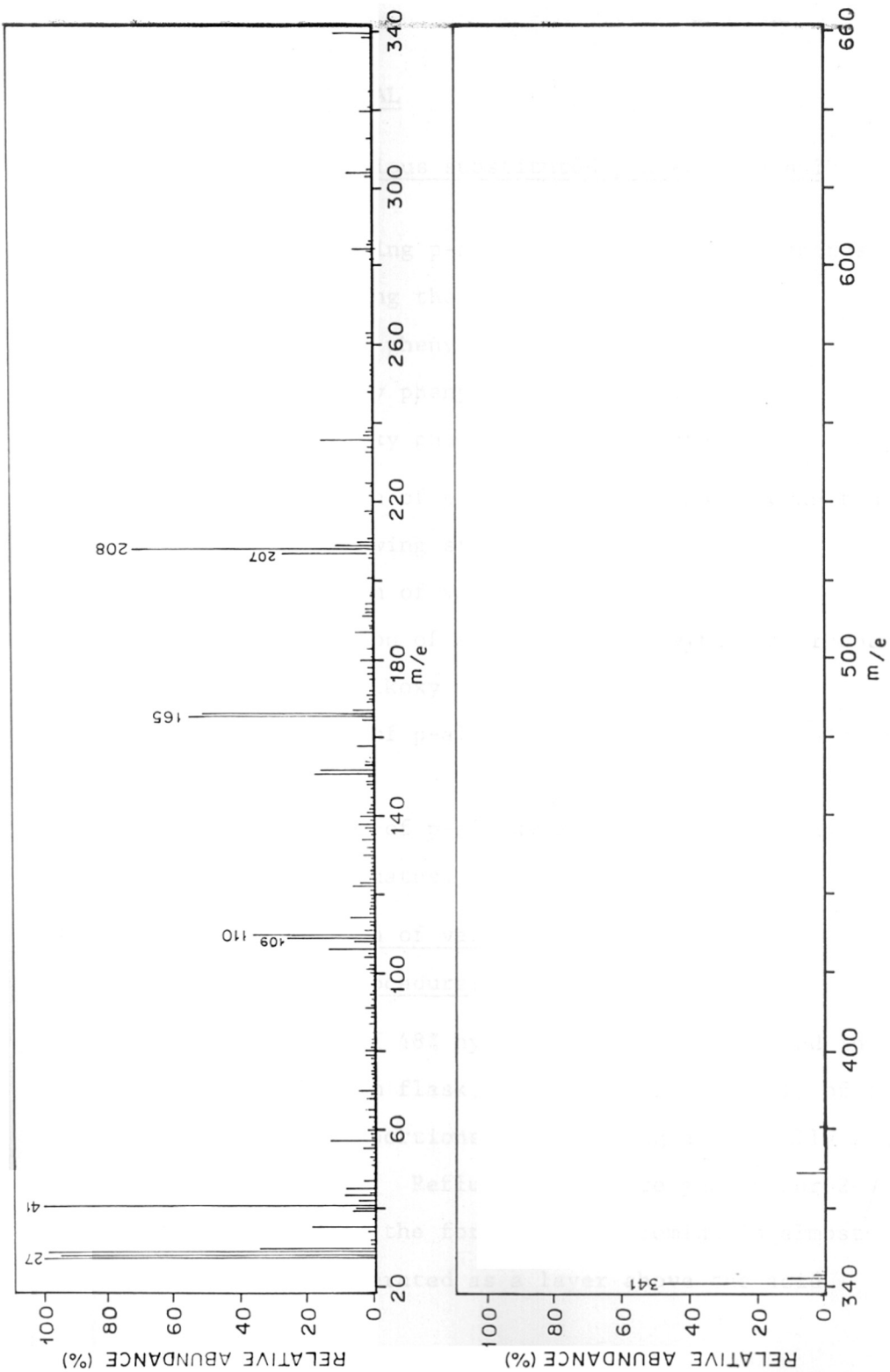

Bu CEP FIG. VIII

2-5.0 EXPERIMENTALPreparation of various substituted p-alkoxy phenyl isothiocyanates

The following p-alkoxy phenyl isothiocyanates were prepared during the present work.

1. p-n-Butoxy phenyl isothiocyanate
2. p-n-Amyloxy phenyl isothiocyanate
3. p-n-Hexyloxy phenyl isothiocyanate

Preparation of p-alkoxy phenyl isothiocyanates involved the following steps.

- (a) Preparation of various alkyl bromides
- (b) Condensation of alkyl bromides with p-nitrophenol to get p-alkoxy nitrobenzenes.
- (c) Reduction of p-alkoxy nitrobenzenes to p-alkoxy anilines.
- (d) Conversion of p-alkoxy anilines to p-alkoxy phenyl isothiocyanates.

- (a) Preparation of various alkyl bromides

General Procedure: [HBr-H₂SO₄ Method]⁷⁴

To 250 g of 48% hydrobromic acid contained in a 500 ml round bottom flask, was added 75 g (41 ml) of conc. sulphuric acid in portions with shaking and finally a few chips of porcelein. Reflux the mixture gently for 2-3 h, during this period the formation of bromide is almost complete which separated as a layer above the acid.

The contents of the flask were cooled and extracted with ether, washed successively with water, dilute hydrochloric acid, water, sodium bicarbonate solution and water and finally dried over anhydrous calcium chloride. It was then distilled under vacuum.

Using this general procedure, the following alkyl bromides were prepared:

	<u>Name</u>	<u>Yield %</u>	<u>B.P. (°C)</u>
1.	1-Bromo butane	85	100 (Lit. ⁷⁴ 100-103)
2.	1-Bromo pentane	75	125-28 (Lit. ⁷⁴ 107-30)
3.	1-Bromo hexane	70	153-55 (Lit. ⁷⁴ 154-56).

(b) Condensation of alkylbromides with p-nitrophenol to obtain p-alkoxy nitrobenzenes

General Procedure⁷⁵: A mixture of 0.01 mol of p-nitrophenol, 0.02 mol of alkyl bromide; 0.02 mol of potassium hydroxide in 150 ml of absolute alcohol was taken in a 250 ml round bottom flask, and refluxed on a steam bath for 12 h. After completion of the reaction, alcohol was removed under vacuo and water was added to the reaction mixture and product was extracted with ether (3 x 50 ml). The combined ethereal extracts were washed several times with 10% sodium hydroxide solution (sodium hydroxide layer should be colourless with last wash); and then with water. It was then dried over anhydrous sodium sulphate, ether removed and product distilled under

reduced pressure. Using the above general procedure, the following p-alkoxy^{nitro}benzenes were prepared:

	<u>Name</u>	<u>Yield(%)</u>	<u>B.P./M.P. (°C)</u>
1.	p-n-Butoxy nitrobenzene	50	30 (Lit. ⁷⁶ 32)
2.	p-n-Amyloxy nitrobenzene	55	165/5 mm (Lit. ⁷⁷ 162-63/5 mm)
3.	p-n-Hexyloxy nitrobenzene	40	175/5mm (Lit. ⁷⁸ 172-74/5mm)

(c) Reduction of p-alkoxy nitrobenzenes to p-alkoxy aniline⁶

General Method: To a solution of p-alkoxy nitrobenzene (10 mmol) in ethanol was added 160 mg of Raney-nickel and was refluxed on steam bath. To the refluxing solution hydrazine hydrate (2-2.5 g) was added dropwise over a period of 2-3 h. After the addition was complete the mixture was refluxed for 1 h more; then the catalyst was removed by filtration. Evaporation of the solvent afforded the alkoxy anilines which were purified by distillation under reduced pressure.

The following p-alkoxy anilines were obtained by the reduction of corresponding p-alkoxy nitrobenzenes using the above general procedure.

	<u>Name</u>	<u>Yield (%)</u>	<u>B.P. (°C)</u>
1.	p-n-Butoxyaniline	65	130/10 mm (Lit. ⁷⁹ 143-44/12 mm)
2.	p-n-Amyloxy aniline	70	180/17 mm (Lit. ⁷⁶ 175-76/17 mm)
3.	p-n-Hexyloxy aniline	60	44 (Lit. ⁷⁸ 43-45)

Preparation of p-alkoxy anilines by condensation of alkyl bromides with paracetamol.⁸⁰

General Procedure: p-Alkoxy acetanilide was prepared by boiling under reflux for 6 h, a solution of 1 mole of paracetamol, 1 mole of an alkylbromide and 1 mole of potassium hydroxide in 1 litre of alcohol and 1 litre of water. The alcohol was removed on water bath and residue was extracted with ether. The ether extracts were washed with dilute sodium hydroxide solution to remove unchanged paracetamol, and dried over solid potassium hydroxide. Ether was removed under vacuo and the white solid obtained was recrystallized from benzene - pet. ether. Using this general procedure, p-alkoxy acetanilides were prepared.

One gram of p-alkoxy acetanilide was mixed with 5 ml of 1:1 hydrochloric acid and heated gently to boil till a clear solution was obtained. Then it was filtered and the filtrate was made alkaline with 20% sodium hydroxide solution. The layer of p-alkoxy aniline which separated was extracted with ether. The ether extract dried over potassium hydroxide and ether was distilled off. The pure p-alkoxy anilines were obtained by vacuum distillation.

The following p-alkoxy anilines were prepared by this method:

	<u>Name</u>	<u>Yield (%)</u>	<u>B.P./M.P. (°C)</u>
1.	p-n Butoxy aniline	65	130/10 mm (Lit. ⁸⁰ 143-44/ 12 mm)
2.	p-n Amyloxy aniline	75	177/17 mm (Lit. ⁷⁶ 175-76/ 17 mm)
3.	p-n Hexyloxy aniline	65	44 (Lit. ⁷⁸ m.p. 43-45)

(d) Preparation of p-alkoxy phenyl isothiocyanates

General Procedure:⁸¹ The amine (0.1 mole) was dissolved in minimum amount of benzene and treated with 6.6 ml (0.1 mole) of carbon disulphide and 14 ml of (0.01 mole) of triethylamine and the solution was cooled to 0°C. After complete precipitation of triethyl ammonium dithiocarbamate salt the solution was filtered and washed with anhydrous ether. The salt was then dissolved in 75 ml of chloroform, treated with 14 ml of triethylamine and ethylchloroformate (0.1 mole) 10 ml was added dropwise over a period of 15 min. The resulting solution was cooled to 0°C for 10 min. and allowed to warm to room temperature. The chloroform layer was washed with 3M hydrochloric acid and water and finally dried over anhydrous sodium sulphate. Chloroform was evaporated under vacuum and the aryl isothiocyanates were distilled.

Modified procedure for preparation of aryl isothiocyanates:

The above procedure was modified by using carbon-disulphide in excess (as a solvent) instead of benzene, and without isolating the dithiocarbamate salt, the mixture was taken in CHCl_3 and ethyl chloroformate was added.

The following aryloxy isothiocyanates were prepared:

	<u>Name</u>	<u>Yield %</u>	<u>B.P./M.P. (°C)</u>
1.	p-n Butoxy phenyl isothiocyanate	52	192/16 mm (Lit. ⁸² bp 190-91/16 mm)
2.	p-n Amyloxy phenyl isothiocyanate	58	200/16 mm (Lit. ⁸² bp 202-4/16 mm)
3.	p-n Hexyloxy phenyl isothiocyanate.	60	178/7 mm (Lit. ⁸² bp 180/7 mm)

CONDENSATION OF p-ALKOXY PHENYL ISOTHIOCYANATES WITH VARIOUS AMINO ACIDS.

1. Condensation of p-alkoxy phenyl isothiocyanates with Glycine

General Procedure: (13 mmol) of p-alkoxy phenyl isothiocyanate was added to a solution of (0.1 mol) of glycine and (13 mmol) of sodium hydroxide in ethanol : water (1:1) and the reaction mixture was refluxed for 4 h, cooled and acidified carefully with dilute hydrochloric acid. The solid obtained was filtered and recrystallized from dilute ethanol.

The following 1-[acetic]-3-[substituted phenyl]-2-thioureas were prepared by the above general method:

(a) 1-[Acetic]-3-[p-n-butoxy phenyl]-2-thiourea:

M.P. 213°C (dil. ethanol)

Yield 60%

IR (Nujol): 3200, 3050, 1770, 1600, 1520, 1470, 1350, 1290 and 1250 cm^{-1} .

PMR (Acetone- d_6): δ 1.0 (t, 3H, CH_3), 1.7 (m, 4H, $-\text{CH}_2\text{CH}_2$), 3.9 (t, 2H, OCH_2), 4.5 (d, 2H, $\text{NH}-\text{CH}_2-\text{COOH}$), (bs, 1H, COOH), 7.0 (2d, 4H, aromatic), 8.1 (bs, 2H, $\text{NH} - \overset{\text{S}}{\underset{\text{H}}{\text{C}}} - \text{NH}$).

Anal. Calcd. for $\text{C}_{13}\text{H}_{18}\text{N}_2\text{O}_3\text{S}$: C, 55.3; H, 6.3; N, 10.1.

Found: C, 55.2; H, 6.7; N, 10.4

(b) 1-[Acetic]-3-[p-n-amyloxy phenyl]-2 thiourea

M.P. 219°C (dil. ethanol)

Yield 58%

IR (Nujol): 3300, 3200, 1770, 1600, 1470, 1350, 1250 and 1210 cm^{-1} .PMR (CDCl_3 : Acetone- d_6): δ 1.0 (t, 3H, CH_3), 1.8 (m, 6H, $\text{CH}_2, \text{CH}_2\text{-CH}_2$), 4.0 (t, 2H, OCH_2), 4.2 (d, 2H, CH_2 COOH), 7.0 (2d, 4H, Aromatic), 7.5 (s, 1H, COOH), 8.6 (bs, 2H, $\text{NH}-\overset{\text{S}}{\underset{\text{H}}{\text{C}}}-\text{NH}$)Anal. Calcd. for $\text{C}_{14}\text{H}_{20}\text{N}_2\text{O}_3\text{S}$: C, 56.7; H, 6.7; N, 9.4.
Found C, 57; H, 7.0; N, 10.3.(c) 1-[Acetic]-3-[p-n-hexyloxy phenyl]-2 thiourea:

M.P. 216°C (dil. ethanol)

Yield 57%

IR (Nujol): 3100, 3000, 1780, 1620, 1540, 1480, 1290, 1260 and 1210 cm^{-1} .PMR (CDCl_3 :Acetone d_6): δ 0.8 (t, 3H, CH_3), 1.3 (m, 8H, $-\text{CH}_2-$), 4.0 (t, 2H, OCH_2), 4.2 (s, 2H, CH_2 COOH), 7.1 (q, 4H, Aromatic), 7.8 (bs, 2H, $\text{NH}-\overset{\text{S}}{\underset{\text{H}}{\text{C}}}-\text{NH}$).

Anal. Calcd. for: C, 58; H, 70; N, 90.

Found C, 57.7; H, 7.3; N, 8.8.

2. Condensation of p-alkoxy phenyl isothiocyanate with p-amino phenyl acetic acidi. Preparation of p-amino phenyl acetic acid

p-Amino phenyl acetic acid was prepared in two steps as follows:

a) Reduction of p-nitro phenyl acetic acid

b) Preparation of p-nitro phenyl acetic acid⁸³

(a) To a solution of p-nitro phenyl acetic acid (0.1 mole, 18 g) in ethanol:water (1:2) was added 1.4 g of NaOH and 1 g of Raney-nickel and was refluxed on steam bath. To the refluxing solution, hydrazine hydrate (10 ml) was added dropwise over a period of 2-3 h. After the addition was complete, the mixture was refluxed for 1 h. Catalyst is removed by filtration and the filtrate acidified to afford p-amino phenyl acetic acid. It was recrystallized from dil. ethanol to yield (9 g, 60%) p-amino phenyl acetic acid; m.p. 153°C (Lit.⁸⁴ m.p. 150°C.)

(b) p-Nitro phenyl acetic acid was prepared by the hydrolysis of p-nitro benzylcyanide.

A mixture of 27.5 ml of concentrated nitric acid with an equal volume of concentrated sulphuric acid was placed in a 1 litre, 3 necked flask. The mixture was cooled to 10°C and 10 g (9.8 ml, 0.085 mol) of benzylcyanide was added over a period of 1 h, maintaining the temperature below 20°C. The mixture was stirred for 1 h and poured over crushed ice. The precipitate was filtered and the solid recrystallized from rectified spirit. The yield of p-nitrobenzylcyanide (m.p. 115°C) was 7 g (52%).

The p-nitrobenzylcyanide (7 g) was hydrolyzed by 50% sulphuric acid (50 ml) by refluxing the mixture for 15 min.

50 ml of cold water was added and cooled to 0°C. The solid was filtered, charcolised and recrystallized from water. The yield of p-nitrophenyl acetic acid was (7 g, 92%); m.p. 150°C (Lit. m.p. 151-52°C).

Condensation of p-alkoxy phenyl isothiocyanate with p-amino phenyl acetic acid

General Method: p-Amino phenyl acetic acid (0.01 mole) was neutralized with equimolecular amount of sodium hydroxide in water (6 ml) and the substituted phenyl isothiocyanate (0.01 mole) in 25 ml ethanol was added to it. The reaction mixture was gently boiled for two hours. After the completion of the reaction, the mixture was allowed to cool and acidified carefully with dilute hydrochloric acid. The solid formed was filtered and recrystallized to afford the desired thiourea.

The following 1-[4'-phenyl acetic)-3-[p-n-alkoxy phenyl]-2-thioureas were prepared by the above general method.

(a) 1-[4'-phenyl acetic]-3-[p-n-butoxyphenyl]-2-thiourea

M.P. 197°C (abs. ethanol)

Yield 50%

IR (Nujol): 3220, 1710, 1620, 1600, 1470, 1390, 1360, and 1180 cm^{-1} .

PMR (TFA): δ 1.1 (t, 3H, CH_3), 1.5-2 (m, 4H, CH_2), 3.9 (s, 2H, CH_2 COOH), 4.2 (t, 2H, OCH_2), 7.3-7.5 (m, 8H, Aromatic).

Anal. Calcd. for $\text{C}_{19}\text{H}_{22}\text{N}_2\text{O}_3\text{S}$: C, 63.6; H, 6.1; N, 7.8
Found: C, 63.3; H, 6.5; N, 7.5.

(b) 1-[4'-Phenyl acetic]-3-[p-n-amyloxy phenyl]-2-thiourea

M.P. 243°C (abs. ethanol)

Yield 67.5%

IR (nujol): 3210, 2700, 1720, 1620, 1600, 1470, 1390, 1260 and 1180 cm^{-1} .PMR (TFA): δ 1.0 (t, 3H, CH_3), 1.2-2 (m, 6H, $(\text{CH}_2)_3$), 3.9 (s, 2H, CH_2 COOH), 4.2 (t, 2H, OCH_2), 7.1-7.5 (m, 8H, Aromatic).Anal. Calcd. for $\text{C}_{20}\text{H}_{24}\text{N}_2\text{O}_3\text{S}$: C, 64.5; H, 6.4; N, 7.6
Found: C, 64.4; H, 6.0; N, 7.2.(c) 1-[4'-Phenyl acetic]-3-[p-n-hexyloxy phenyl]-2-thiourea

M.P. 210°C (abs. ethanol).

Yield 50%

IR (Nujol): 3220, 1710, 1620, 1600, 1475, 1390, 1260, 1210 and 1180 cm^{-1} .PMR (TFA) δ 1.0 (t, 3H, CH_3), 1.2-2 (m, 8H, $(\text{CH}_2)_4$), 3.9 (s, 2H, CH_2 COOH), 4.1 (t, 2H, $-\text{OCH}_2$), 7.1-7.5 (m, 8H, Aromatic).Anal. Calcd. for $\text{C}_{21}\text{H}_{26}\text{N}_2\text{O}_3\text{S}$: C, 65.3; H, 6.8; N, 7.3.
Found: C, 65.6; H, 7.16; N, 7.8Condensation of p-n-alkoxy phenyl isothiocyanate with lysineGeneral Method: A mixture of lysine monohydrochloride (1.83 g, 0.01 mole) and substituted phenyl isothiocyanate (1 g, 0.05 mole) was stirred for 3 h. at pH 11 obtained by

2N sodium hydroxide solution [A pH meter was used to maintain the exact pH]. The solution was removed from the pH stat and absorbed on 80 ml Dowex-50 resin (H^+ form). The resin was filtered, washed several times with distilled water and then stirred with 3N ammonium hydroxide solution. The resin was removed by filtration and the filtrate was concentrated under vacuum to 50% of the original volume and cooled. The solid separated was filtered and recrystallized from ethanol.

The following 1- $[\omega$ -lysyl]-3-[p-n-alkoxy phenyl]-2-thioureas were prepared by the above general method.

(a) 1- $[\omega$ -lysyl]-3-[p-n-butoxy phenyl]-2-thiourea

M.P. 132°C (Rectified spirit)

Yield 55%

IR (Nujol): 3400, 3250, 3150, 1760, 1620, 1600, 1480 and 1270 cm^{-1} .

PMR ($CDCl_3$): δ 1.0 (t, 3H, CH_3), 1.1-2.0 (m, 10H, $(CH_2)_5$), 3.8 (m, 1H, CH), 3.9 (t, 2H, OCH_2), 4.2 (t, 2H, CH_2), 7.1 (2d, 4H, Aromatic), 8.2 (2s, 2H, $NH-C-NH$, D_2O exchangeable), 6.0 (bs, 1H, $COOH$).

Anal. Calcd. for $C_{17}H_{27}N_3O_3S$: C, 57.7; H, 7.6; N, 11.8.

Found: C, 58.0; H, 7.9; N, 10.9.

(b) 1- $[\omega$ -Lysyl]-3-[p-n-amyloxy phenyl]-2-thiourea

M.P. 121°C (Rectified spirit)

Yield 60%

IR (Nujol): 3390 (b), 3250, 3150, 1760, 1620, 1600, 1480 and 1280 cm^{-1} .

PMR (CDCl_3): δ 1 (t, 3H, CH_3), 1.4 (m, 6H, $(\text{CH}_2)_3$), 1.8 (m, 6H, $(\text{CH}_2)_3$), 3.8 (m, 1H, CH-NH_2), 3.9 (t, 2H, OCH_2), 4.2 (t, 2H, CH_2), 7.0 (2d, 4H, Aromatic), 8.0 (b(s), 2H, $\text{NH}-\overset{\text{S}}{\underset{\text{H}}{\text{C}}}-\text{NH}$, D_2O exchangeable).

Anal. Calcd. for $\text{C}_{18}\text{H}_{29}\text{N}_3\text{O}_3\text{S}$: C, 58.8; H, 7.9; N, 11.4
Found: C, 59; H, 8.1; N, 11.0.

(c) 1-[α -Lysyl]-3-[p-n-hexyloxy phenyl]-2-thiourea

M.P. 100°C (dilute ethanol)

Yield 48%

IR (Nujol): 3400, 3250, 3150, 1760, 1620, 1590, 1480 and 1265 cm^{-1} .

PMR (CDCl_3) δ 1.1 (t, 3H, CH_3), 1.6 (m, 8H, O-alkyl), 1.9 (m, 8H, alkyl), 3.8 (m, 1H, $-\text{CH-NH}_2$), 3.9 (t, H, OCH_2), 4.2 (t, 2H, CH_2), 7.1 (2d, 4H, Aromatic), 8.2 (b(s), 2H, $\text{NH}-\overset{\text{S}}{\underset{\text{H}}{\text{C}}}-\text{OH}$).

Anal. Calcd. for $\text{C}_{19}\text{H}_{31}\text{N}_3\text{O}_3\text{S}$: C, 59.8; H, 8.1; N, 11.0
Found: C, 59.5; H, 7.9; N, 10.03.

Condensation of p-n-alkoxy phenyl isothiocyanate with 5-amino uracil

(i) Preparation of 5-amino uracil⁸⁵ from 5-nitro uracil.

(ii) Preparation of 5-nitro uracil.⁸⁶

(i) Sodium dithionate (20 g) was added in one lot to a stirred suspension of 5-nitro uracil (4.2 g) in water (70 cc) and liquor ammonia (3 cc). The mixture developed heat and the

salt slowly dissolved. More liquor ammonia was added from time to time to maintain a pH of 8.5. When the reaction was over, as shown by constancy of pH, the mixture was set aside. The precipitate was ~~collected~~ in cold water and 2N HCl (15 cc) was added. The solution was filtered and basified with ammonia and the precipitate of 5-amino uracil was collected (3 g, 91%) and dried at 40°C. M.P. 30°C (Lit. M.P. > 300°C); PMR [8.0(s), 5.6(s) broad]; IR [3400 cm^{-1} (NH_2), 1800-1700 cm^{-1} (b); 1300-1200 cm^{-1} (sharp peaks)].

(ii) Uracil (5.7 g) was added batchwise to a nitrating mixture of nitric acid (15 ml) and sulphuric acid (5 ml). The reaction mixture was heated at 75°C for 3 h. After the completion of reaction, it was poured in ice cold water and refrigerated overnight. The solid separated was recrystallised from hot water to yield 6.5 g (80%); M.P. 300°C; IR [1750, 1700, 1540 (NO_2) and 1330 cm^{-1} (NO_2)].

General Method for the condensation of p-n-alkoxy phenyl isothiocyanates with 5-amino uracil:

5-Amino uracil (10 mmol) was taken in water (20 ml) and to it was added sodium hydroxide 1 equiv. (10 mmol) and stirred for 15 min. The appropriate p-n-alkoxy substituted phenyl isothiocyanate (10 mmol) was added and the reaction mixture was stirred overnight (15 h). It was acidified with dil. hydrochloric acid and the solid thus obtained was washed

thoroughly with hot petroleum ether and dilute hydrochloric acid. The thiourea was dried at 50°C and characterized.

The following 1-[5'-uracil]-3-[p-n-alkoxyphenyl]-2-thioureas were prepared by the above general method.

(a) 1-[5'-uracil]-3-[p-n-butoxyphenyl]-2-thiourea

M.P. 290°C

Yield 48%

IR (Nujol): 3250, 3150, 1770, 1690, 1600, 1490, 1480, 1260 and 1180 cm^{-1} .

PMR (DMSO- D_6) δ 1.0 (t, 3H, CH_3), 1.4 (m, 4H, $(\text{CH}_2)_2$), 3.7 (t, 2H, OCH_2), 7.0-7.2 (2d, 4H, Aromatic), 8.2 (s, 1H, $\text{C}=\text{CH}$), 8.5, 9.4, 9.7 and 10.8 (4s, 4H, 4NH , D_2O exchangeable).

Anal. Calcd. for $\text{C}_{15}\text{H}_{18}\text{N}_4\text{O}_3\text{S}$: C, 53.9; H, 5.38; N, 16.7
Found: C, 54.3; H, 5.5; N, 16.2

(b) 1-[5'-Uracil]-3-[pn-n-amyloxyphenyl]-2-thiourea

M.P. 298°C

Yield 54%

IR (Nujol): 3300, 1760, 1670, 1600, 1460, 1290 and 1270 cm^{-1} .

PMR (DMSO- D_6) δ 1.1 (t, 3H, CH_3), 1.4-2 (m, 6H, $-\text{CH}_2$), 3.8 (t, 2H, OCH_2), 7.0-7.2 (2d, 4H, Aromatic), 8.2 (d, 1H, $\text{C}=\text{CH}$), 8.5, 9.4, 9.7, 10.8 (4s, 4H, 4NH , D_2O exchangeable).

Anal. Calcd. for $\text{C}_{16}\text{H}_{20}\text{N}_4\text{O}_3\text{S}$: C, 55.1; H, 5.7; N, 16.09.
Found: C, 54.8; H, 5.5; N, 15.6

(c) 1-[5'Uracil]-3-[p-n-hexyloxyphenyl]-2-thiourea

M.P. 300°C

Yield 50%

IR (Nujol): 3300, 1760, 1670; ~~1600, 1480, 1320~~
1270 cm^{-1} .PMR (DMSO- D_6) δ 1.1 (t, 3H, CH_3), 1.4-2.1 (m, 8H, CH_2),
4.0 (t, 2H, OCH_2), 7-7.2 (2d, 4H, Aromatic), 8.2 (d, 1H,
 $\text{C}=\text{CH}$), 8.6, 9.5, 9.4, 10.8, (4s, 4H, 4NH, D_2O exchangeable).Anal. Calcd. for $\text{C}_{17}\text{H}_{22}\text{N}_4\text{O}_3\text{S}$: C: 56.3; H, 6.0; N, 15.4.

Found: C, 56.0; H, 5.8; N, 15.0

Condensation of p-n-alkoxyphenyl isothiocyanate with
6-aminopenicillanic acid

87

General Method: To a stirred suspension of 6-amino-
penicillanic acid (8 mmol) in DMF (5.7 ml) was added triethyl-
amine (3.75 g) and p-n-alkoxyphenyl isothiocyanate (8 mmol)
at 0°C. After 30 min. the solution was stirred at room
temperature for 3 h. and acidified with dilute hydrochloric
acid (5%) carefully and cooled. The solid separated was
filtered and recrystallized from benzene : pet. ether mixture.

The following 1-[6'-penicillanic acid]-3-[p-n-alkoxy-
phenyl]-2-thioureas were prepared by the above general method.

(a) 1-(6'-Penicillanic acid)-3-[p-n-butoxyphenyl]-2-thiourea

M.P. 140°C (Benzene : pet. ether)

Yield 40%

IR (Nujol): 3600 - 2500 cm^{-1} (b); 1740 (b); 1650 (b);
1540, 1480, 1400, 1320, 1270 and 1190 cm^{-1} .

PMR (Acetone- d_6) δ 1-2 (m, 13H, O-alkyl, 2CH₃), 3.7 (s, 1H, CH COOH), 4.0 (t, 2H, OCH₂), 4.2 (d, 1H), 5.5 (d, 1H), 7.2 (4H, Aromatic)

Anal. Calcd. for C₁₉H₂₅N₃O₄S₂: C, 53.8; H, 6.4; N, 9.3.
Found: C, 53.1; H, 6.5; N, 8.9.

(b) 1-[6'-Penicillanic acid]-3-[p-tolamylbenzophenyl]-2-thiourea

M.P. 119-122°C (Benzene : pet. ether)

Yield 40%

IR (Nujol): 3600-2500 (b); 1740, 1660 (b); 1530, 1480, 1320, 1270, 1230 and 1180 cm⁻¹.

PMR (Acetone- d_6) δ 1-2 (m, 15H, O-alkyl, 2CH₃), 3.75 (s, 1H, CH COOH), 4.0 (t, 2H, OCH₂), 4.2 (d, 1H), 5.1 (d, 1H), 7.2 (4H, Aromatic).

Anal. Calcd. for C₂₀H₂₇N₃O₄S₂: C, 54.9; H, 6.18; N, 9.6
Found: C, 54.5; H, 6.07; N, 9.6.

(c) 1-[6'-Penicillanic acid]-3-[p-n-hexyloxyphenyl]-2-thiourea

M.P. 117-119°C

Yield 38%

IR (Nujol): 3600-2500 (b); 1740, 1670 (b); 1525, 1490, 1395, 1320, 1270, 1230 and 1180 cm⁻¹.

PMR (Acetone- d_6): δ 1-2 (m, 17H, alkyl, 2CH₃), 3.7 (s, 1H), 4.0 (d, 2H, OCH₂), 4.2 (d, 1H), 5.5 (d, 1H), 7.2 (m, 4H, Aromatic).

Anal. Calcd. for C₂₁H₂₉N₃O₄S₂: C, 55.8; H, 6.4; N, 9.3.
Found: C, 56.1; H, 6.5; N, 8.9.

Condensation of p-n-alkoxyphenyl isothiocyanates with ampicillin

General Method: To a stirred solution of ampicillin (10 mmol) in ethanol and water (2:1) (10 ml) was added one drop of phenolphthalein indicator and the reaction mixture was neutralised with 10% sodium hydroxide solution (colourless to pink). (10 mmol) of p-n-alkoxyphenyl isothiocyanate was added at 10°C and the solution was stirred at room temperature for 6-8 h. The reaction mixture was cooled and acidified with dilute hydrochloric acid (10%). The solid separated was filtered and recrystallized with dilute ethanol to yield the desired thiourea.

The following 1-[(6'-phenylacetamido]penicillanic acid)]-3-[p-n-alkoxyphenyl]-2-thioureas were prepared by the above method.

(a) 1-[(6'-[phenylacetamido]penicillanic acid)]-3-[p-n-butoxyphenyl]-2-thiourea

M.P. (152°C) (Dil. ethanol)

Yield 51%

IR (Nujol): 3300, 1740 (d); 1670 (b); 1600, 1510, 1460, 1380, 1300, 1240 and 1120 cm^{-1} .

PMR (CDCl_3): 1.0 (t, 3H, CH_3), 1.2-2 (m, 10H, CH_2 , 2 CH_3), 3.9 (s, 1H, CH COOH), 4.0 (t, 2H, OCH_2), 4.1 (d, 1H, 5.1 (d, 1H, 6.1 (s, H Ar CH-CONH), 6.8-7.8 (m, 9H, Aromatic), 8.0 [b(s), 2H, NH-C-NH].

Anal. Calcd. for $\text{C}_{27}\text{H}_{32}\text{N}_4\text{O}_5\text{S}_2$: C, 58.2; H, 5.8; N, 10.0

Found: C, 58.0; H, 5.93; N, 9.8.

(b) 1-[α -(6'-[phenylacetamido]penicillanic acid)]-3-[p-n-amyloxyphenyl]-2-thiourea

M.P. (128°C) (Dil. ethanol)

Yield 45%

IR (Nujol): 3300, 2700, 1730, 1660, 1610, 1510, 1460, 1380, 1300, 1250, 1180 and 1030 cm^{-1} PMR (CDCl_3) δ 0.9 (t, 3H, CH_3), 1.0 - 2 (m, 12H, $-\text{CH}_2-$, 2CH_3), 3.9 (s, $\text{CH}-\text{COOH}$), 4.0 (t, 2H, OCH_2), 4.1 (d, 1H), 5.2 (d, 1H), 6.1 (s, H, $\text{Ar}-\text{CH}-\text{CONH}-$), 6.6-7.8 (m, 9H, Aromatic), 8.0 (b(s), 2H, $\text{NH}-\overset{\text{S}}{\text{C}}-\text{NH}$)Anal. Calcd. for $\text{C}_{28}\text{H}_{34}\text{N}_4\text{O}_5\text{S}_2$: C, 59.0; H, 6.1; N, 9.2.

Found: C, 59.2; H, 6.27; N, 8.8.

(c) 1-[α -(6'-[phenylacetamido]penicillanic acid)]-3-[p-n-hexyloxyphenyl]-2-thiourea

M.P. (160°C) (Dil. ethanol).

Yield 50%

IR (Nujol): 3300, 2700, 1740, 1660, 1600, 1510, 1450, 1380, 1250, 1180 and 1030 cm^{-1} .PMR (CDCl_3) δ 1.0 (t, 3H, CH_3), 1.1-2 (m, 14H, $(\text{CH}_2)_4$, 2CH_3), 3.9 (s, 1H, $\text{CH}-\text{COOH}$), 4.0 (t, 2H, OCH_2), 4.1 (d, 1H), 5.1 (d, 1H), 6.1 (b(s), H, $\text{Ar}-\text{CH}-\text{CONH}$), 6.8-7.6 (m, 9H, Aromatic), 8.1 (d, 2H, $\text{NH}-\overset{\text{S}}{\text{C}}-\text{NH}$).Anal. Calcd. for $\text{C}_{29}\text{H}_{36}\text{N}_4\text{O}_5\text{S}_2$: C, 59.5; H, 6.1; N, 9.5.

Found: C, 59.2; H, 6.5; N, 9.2.

(b) Condensation of p-n-alkoxyphenyl isothiocyanates with amoxicillin

General Method: To a stirred solution of amoxicillin (10 mmol) in 10 ml of ethanol and water (2:1) was added 1 drop of phenolphthalein indicator and the reaction mixture was neutralized with 10% sodium hydroxide solution (colourless to pink). (10 mmol) of p-n-alkoxyphenyl isothiocyanate was added at 0°C and the solution was then allowed to stir at room temperature for 3 h. The reaction mixture was cooled and acidified with dilute hydrochloric acid (10%). The solid separated was filtered and recrystallised with dilute ethanol to yield the desired thiourea.

The following 1-[α -(6'-[p-hydroxyphenylacetamido penicillanic acid]-3-[p-n-alkoxyphenyl]-2-thioureas were prepared by the above general method.

(a) 1-[α -(6'-[p-hydroxyphenylacetamido penicillanic acid]-3-[p-n-butoxyphenyl]-2-thiourea

M.P. (170-73°C) (Dil. ethanol).

Yield 50%

IR (Nujol): 3500, 3200 (b); 2700, 1710, 1730 (b); 1670, 1610, 1510, 1460, 1380, 1250, 1180 and 1130 cm^{-1} .

PMR (Acetone- d_6 + CDCl_3): δ 1.0 (t, 3H, CH_3), 1.2-2 (m, 10H, $-\text{CH}_2-$ 2 x CH_3), 3.9 (s, 1H, $\text{CH}-\text{COOH}$), 4.0 (t, 2H, OCH_2), 4.5 (bs, 1H, OH, D_2O exchangeable), 4.6 (d, 1H), 5.1 (d, 1H), 6.1 (s, 1H, Ph- $\text{CH}-\text{CONH}$), 8.4 (d, 2H, $\text{NH}-\overset{\text{S}}{\text{C}}-\text{NH}$)

Anal. Calcd. for $\text{C}_{27}\text{H}_{32}\text{N}_4\text{O}_6\text{S}_2$: C, 56.6; H, 5.6; N, 9.8
Found: C, 56.5; H, 5.9; N, 9.5

(b) 1-[α -(6'-[p-hydroxyphenylacetamido]penicillanic acid)-3-[p-n-amyloxyphenyl]-2-thiourea

M.P. (151°C) (Dil. ethanol)

Yield 55%

IR (Nujol): 3300 (b); 2700, 1740, 1670, 1610, 1510, 1460, 1370, 1240, 1170, 1130 and 1020 cm^{-1} .PMR (CDCl_3 + Acetone- d_6): δ 0.9 (t, 3H, CH_3), 1-2 (m, 12H, $-\text{CH}_2-$ 2 x CH_3), 3.9 (s, 1H, CH COOH), 4.0 (t, 2H, OCH_2), 4.6 (d, 1H), 4.5 (bs, OH), 5.1 (d, 1H), 6.1 (s, 1H, Ph- CH CONH), 6.9 (m, 4H, Aromatic), 7.2 (m, 4H, Aromatic), 8.4 (d, 2H, $\text{NH}-\overset{\text{S}}{\text{C}}-\text{NH}$)Anal. Calcd. for $\text{C}_{28}\text{H}_{34}\text{N}_4\text{O}_6\text{S}_2$: C, 57.3; H, 5.8; N, 9.5.
Found: C, 57.3; H, 6.0; N, 9.2.(c) 1-[α -(6'-[p-hydroxyphenylacetamido]penicillanic acid)-3-[p-n-hexyloxyphenyl]-2-thiourea

M.P. (132°) (Pet. ether : ethyl acetate)

Yield 58%

IR (Nujol): 3250 (b); 1730, 1660, 1600, 1510, 1460, 1380, 1250, 1170, 1120 and 1020 cm^{-1} .PMR (CDCl_3 + Acetone- d_6): δ 0.8 (t, 3H, CH_3), 1-2 (m, 14H, $-\text{CH}_2-$, 2 x CH_3), 3.8 (t, 2H, OCH_2), 3.9 (s, 1H, CH -COOH), 4.4 (d, 1H), 5.0 (d, 1H), 6.1 (s, 1H, Ar- CH CONH), 6.9 & 7.2 (m, 8H, Aromatic), 8.8 (d, 2H, $\text{NH}-\overset{\text{S}}{\text{C}}-\text{NH}$)Anal. Calcd. for $\text{C}_{29}\text{H}_{36}\text{N}_4\text{O}_6\text{S}_2$: C, 58.0; H, 6.0; N, 9.36

Found: C, 57.8; H, 6.3; N, 8.9.

Condensation of p-n-alkoxyphenyl isothiocyanate with 7-ADCA (7-amino des acetoxy cephalosporanic acid)

General Method:⁸⁷ To a stirred solution of 7-amino des acetoxy cephalosporanic acid (7.5 mmol) ~~in DMF (5 ml)~~ was added triethylamine (3 ml) and p-n-alkoxyphenyl isothiocyanate (7.5 mmol) at 0°C. After 30 min. the reaction mixture was stirred for 3 h. at room temperature and then acidified with dilute hydrochloric acid (5%) and cooled. The solid separated was filtered and recrystallized from benzene - pet. ether to obtain the desired thiourea.

The following 1-[7'-des acetoxy cephalosporanic acid]-3-[p-n-alkoxyphenyl]-2-thioureas were prepared by the above general method.

(a) 1-[7'-Des acetoxy cephalosporanic acid]-3-[p-n-butoxy phenyl]-2-thiourea

M.P. (128-32°C) (Benzene : pet. ether)

Yield 50%

IR (Nujol): 3200 (b); 1750, 1700 (b); 1520, 1650 (b); 1460, 1380, 1300, 1250 and 1170 cm^{-1} .

PMR (CDCl_3): 0.9 (t, 3H, CH_3), 1.2 (m, 10H), (CH_2)₂, 2x CH_3 , 3.1 (dd, 2H, CH_2), 3.9 (d, 1H), 4.0 (t, 2H, OCH_2), 5.2 (d, 1H), 7.2 (m, 4H, Aromatic). 7.9 (2d, NH - $\overset{\text{H}}{\text{C}}$ - NH)

Anal. Calcd. for $\text{C}_{19}\text{H}_{23}\text{N}_3\text{O}_4\text{S}_2$: C, 54.1; H, 5.4;

N, 9.97.

Found: C, 54.4; H, 5.5; N, 9.58.

(b) 1-[7'-Des acetoxy cephalosporanic acid]-3-[p-n-amyloxyphenyl]-2-thiourea

M.P. (128-32°C)

Yield 55%

IR (Nujol): 3200, 1750, 1700, 1650, 1510, 1460, 1380, 1250, 1210 and 1170 cm^{-1} .PMR (CDCl_3): 1-2 (m, 12H, $(\text{CH}_2)_3$, 2 x CH_3), 3.1 (dd, 2H, CH_2), 3.9 (d, 1H), 4.0 (t, 2H, OCH_2), 5.2 (d, 1H), 7.2 (m, 4H, Aromatic), 8.0 [b(s), $\text{NH} - \overset{\text{S}}{\underset{\text{H}}{\text{C}}} - \text{NH}$]Anal. Calcd. for $\text{C}_{20}\text{H}_{25}\text{N}_3\text{O}_4\text{S}_4$: C, 55.1; H, 5.7; N, 9.6

Found: C, 54.8; H, 5.4; N, 9.2

(c) 1-[7'-Des acetoxy cephalosporanic acid]-3-[p-n-hexyloxyphenyl]-2-thiourea

M.P. (134-37°C) (Benzene - pet. ether)

Yield 52%

IR (Nujol): 3200 (b); 2700, 1750, 1700, 1650, 1510, 1460, 1410, 1380, 1300, 1250, 1200, 1170 and 1100 cm^{-1} .PMR (CDCl_3): 1-2 (m, 14H, $(\text{CH}_2)_4$, 2 x CH_3), 3.1 (dd, 2H, CH_2), 3.9 (d, 1H), 4.0 (t, 2H, OCH_2), 5.2 (d, 1H), 7.2 (m, 4H, Aromatic) 7.9 (d, $\text{NH} - \overset{\text{S}}{\underset{\text{H}}{\text{C}}} - \text{NH}$).Anal. Calcd. for $\text{C}_{21}\text{H}_{27}\text{N}_3\text{O}_4\text{S}_2$: C, 56.1; H, 6.0; N, 9.3.

Found: C, 56.3; H, 6.2; N, 9.0

Condensation of p-n-alkoxyphenyl isothiocyanate with cephalixinGeneral Method: To a stirred solution of cephalixin (10 mmol) in ethanol (10 ml) was added 1 drop of phenolphthalein indicator and the reaction mixture was neutralized

10% sodium hydroxide solution (colourless to pink). 10 mmol of p-n-alkoxyphenyl isothiocyanate was added at 0°C and the solution was then allowed to stir at room temperature for 3 h. The reaction mixture was ~~moderately acidified~~ with dilute hydrochloric acid (10%). The solid separated was filtered and recrystallised from benzene to yield the desired thiourea.

The following 1-[α -(7'-[phenylacetamido] des acetoxy cephalosporanic acid)-3-[p-n-alkoxyphenyl]-2-thioureas were prepared by the above general method.

(a) 1-[α -(7'-[phenylacetamido] des acetoxy cephalosporanic acid)-3-[p-n-butoxyphenyl]-2-thiourea

M.P. (138-42°C) (Benzene)

Yield 40%

IR (Nujol): 3500, 3300, 1780 (b); 1700, 1570, 1480, 1400, 1310, 1260 and 1180 cm^{-1} .

PMR (CDCl_3): 1.0 (t, 3H, CH_3), 1.2 - 2 (m, 4H, $-\text{CH}_2$), 2.1 (s, 3H, CH_3), 3.1 (d, 2H, CH_2), 4.0 (t, 2H, OCH_2), 4.8 (d, 1H), 5.6 (d, 1H), 6.1 (d, 1H, Ar- CH_2 -CONH), 6.9 - 7.2 (m, 9H, Aromatic), 8.0 (d, 2H, NH- $\overset{\text{S}}{\underset{\text{H}}{\text{C}}}$ -NH)

Anal. Calcd. for: $\text{C}_{27}\text{H}_{30}\text{N}_4\text{O}_5\text{S}_2$: C, 58.5; H, 5.4; N, 10.1

Found: C, 58.8; H, 5.0; N, 9.8.

(b) 1-[α -(7'-[phenylacetamido] des acetoxy cephalosporanic acid)-3-[p-n-amyloxyphenyl]-2-thiourea

M.P. (146-47°C) (Benzene)

Yield 53%

IR (Nujol): 3500, 3300, 1790(b); 1680(b); 1540, 1480, 1390 and 1180 cm^{-1} .

PMR (CDCl_3): 1.0 (t, 3H, CH_3), 1.2 - 2 (m, 6H- CH_2 -), 2.1 (s, 3H, CH_3), 3.2 (d, 2H, CH_2), 4.0 (t, 2H, OCH_2), 4.8 (d, 1H), 5.6 (d, 1H), 6.1 (s, 1H, Ar- CH -CONH), 7.0 (m, 9H, Aromatic), 7.7 & 8.1 (2s, 2H, $\text{NH}-\overset{\text{S}}{\underset{\text{H}}{\text{C}}}-\text{NH}$)

Anal. Calcd. for $\text{C}_{28}\text{H}_{32}\text{N}_4\text{O}_5\text{S}_2$: C, 59.1; H, 5.6; N, 9.6.

Found: C, 58.8; H, 5.4; N, 9.9

(c) 1-[\alpha-(7'-[phenylacetamido] des acetoxy cephalosporanic acid)]-3-[p-n-butoxyphenyl]-2-thiourea

M.P. (134-36°C) (Benzene)

Yield 50%

IR (Nujol): 3500, 3300, 1780(b); 1690(b); 1535, 1480, 1390, 1250, 1180, 1120 and 1080 cm^{-1}

PMR (CDCl_3): 1.0 (t, 3H, CH_3), 1.2 - 1.9 (m, 8H, CH_2), 2.1 (s, 3H, CH_3), 3.2 (dd, 2H, CH_2), 4.0 (t, 2H, OCH_2), 4.8 (d, 1H), 5.6 (d, 1H), 6.1 (s, H, Ar- CH -CONH-), 7.0 (m, 9H, Aromatic), 7.8 & 8.2 (2s, 2H, $\text{NH}-\overset{\text{S}}{\underset{\text{H}}{\text{C}}}-\text{NH}$)

Anal. Calcd. for $\text{C}_{29}\text{H}_{34}\text{N}_4\text{O}_5\text{S}_2$: C, 59.7; H, 5.8; N, 9.6

Found: C, 59.9; H, 5.7; N, 9.2

2-6.0 REFERENCES

1. M. Hooper and S.N. Kulkarni,
Brit. J. Pharmac., 77, 574, 1982.
2. D.W. Browne and C. Dyson,
J. Chem. Soc., 3285, 1931.
3. A.M. Cook and G.H. Thomas,
J. Chem. Soc., 1884, 1950.
4. L. Drobnica and J. Augustin,
Coll. Czech. Chem. Comm., 30, 1221, 1965.
5. P. Edman,
Acta Chem. Scand., 4, 283, 1950.
6. S. Piegel and Sabbath
Ber. 34, 1935, (1901).
7. G. Gutekunst and Gray,
J. Am. Chem. Soc., 44, 1741, 1922.
8. Steck, Buck and Fletscher,
J. Am. Chem. Soc., 79, 4414, 1957.
9. Monique Clerc-Bory,
Bull. Soc. Chim. France, 337, 1954.
10. Claisen and Eiselb,
Ann. 401, 79, 1913.
11. Allen and Gates,
Org. Synthesis, 25, 9, 1945.
12. Weygand and J. Gabler
J. Prakt. Chem., 155, 332, 1940
13. Buu-Hoi, Xuong and Nam,
J. Chem. Soc., 1579, 1955.
14. Morton and Slaun White,
J. Biol. Chem., 179, 259, 1949.
15. J.A. Strung,
U.S. Patent 2,629,658 (1953); CA: 47, 8567, 1953.
16. B.S. Kulkarni,
J. Sci. Ind. Res. (Ind), 20C, 205-7, 1961.
17. R.W. West,
J. Chem. Soc., 66, 1781, 1944. 127, 494, 1925

18. (Dornfield and Hazlet,
J. Am. Chem. Soc., 66, 1781, 1944.
19. Li and Adams,
J. Am. Chem. Soc., 69, 1565, 1947.
20. Clement de Traz,
Helv. Chim. Acta, 30, 232, 1947.
21. Adkins,
Reactions of Hydrogen, University of Wisconsin Press,
Madison (1937).
22. Adams, Cohen and Rees,
J. Am. Chem. Soc., 49, 1093, 1927.
23. Tsatsas and Delaby,
Ann. Pharm. France, 14, 607, 1956.
24. E.A. Braude, R.P. Linstead and K.R.H. Wooldrige
J. Chem. Soc., 3586-3595, 1954.
25. Toshio Satoh, Naoki Mitsuo, Mayumi Nishiki,
Yasuguki Inoue and Yasuhiro Ooi,
Chem. Pharm. Bull., 29 1443, 1981.
26. W.J. le Noble, C.K. Cheung, Elaine Kuo and S.Srivastava,
Synth. Commun., 15(7), 599-602, 1985.
27. A Furgt,
Chem. Rev. 65, 51, 1965.
28. Fransisco Yuste, Manuel Saldana, Fernindo Walls,
Tetrahedron Lett., 23, 147, 1982.
29. A. Rathke,
Chem. Ber., 5, 799, 1872.
30. G.M. Dyson and H.J. George,
J. Chem. Soc., 436, 1927.
31. R.L. McKee and R.W. Bost,
J. Am. Chem. Soc., 68, 2506, 1946.
32. W. Siefken,
Ann. Chem., 562 75, 1947.
33. D.J. Beaver, D.O. Roman and L.J. Stoffet,
J. Am. Chem. Soc., 79, 1236, 1957.
34. D. Friis,
Acta. Chem. Scand., 19, 766, 1965.

35. A.A.R. Sayigh, H. Ulrich and J.S. Potts,
J. Org. Chem., 30, 2405, 1965.
36. W.L. Yale,
J. Am. Chem. Soc., 75, 675, 1953.
37. P. Saccardi,
Gazz. Chim. Ital., 75, 87, 1945.
38. S.M. Losanitsch.,
Chem. Ber., 24, 3021, 1891.
39. G. Loose and H. Weddige,
Liebigs. Ann. Chem., 636 144, 1960.
40. A.W. Hoffmann,
Ann. Chem., 373, 201, 1909.
41. S. Goldschmidt and K. Martin,
Ger. Patent 700,436 (1936). Houbem-Weyl, Vol. IX,
George Thieme, Verlag Stuttgart 1955, p.869.
42. K. Hartke,
Arch. Pharm., 299, 174, 1966.
43. E. Schmidt, E. Kammerl, D. Ross and F. Zaller,
Ann. Chem., 594 235, 1955.
44. G.I.M. Van der Kerk, G.W. Pluggers and G. de Vries,
Rec. Trav. Chem., 74, 1268, 1955.
45. D. Martin, E. Beyer and H. Gross,
Ger. Patent 43996, 1965; CA: 63, 3746, 1965.
46. D. Martin, E. Beyer and H. Gross,
Chem. Ber., 98, 2425, 1965.
47. G.S. Jadhav, U. Agarwala and P.B. Rao,
Indian J. Chem., 8, 759, 1970.
48. J.C. Jochims,
Chem. Ber., 101, 11746, 1968.
49. H.R. Kricheldorf,
Synthesis, 539, 1970.
50. H. Fujita, R. Endo and K. Murayama,
Chem. Lett., 883, 1973.
51. S. Sakai, T. Aizawa and T. Fujinami,
J. Org. Chem., 39, 1970, 1974.

52. J. Von Braun and H. Deutsch,
Chem. Ber., 45, 2188, 1912.
53. W. Menz and W. Weith,
Zh. Chem., 589, 1869.
54. J.N. Leconte and L.H. Chance,
J. Am. Chem. Soc., 71, 2240, 1949.
55. N.I. Volinkin,
Zn. Obshch. Khim., 37, 483, 1957.
56. C. Liebermann and S. Natanson,
Chem. Ber., 13, 1576, 1880.
57. A. Skita,
Chem. Ber., 53, 1242, 1920.
58. G.B. Crippa and R. Caracci,
Gazz. Chim. Ital., 70, 384, 1940.
59. J.N. Baxter, J. Cymerman-Craig, M. Moyle and
R.A. White,
Chem. and Ind., 785, 1954; J. Chem. Soc., 659, 1956.
60. A.W. Hoffmann,
Ber. 2, 452, 1869.
61. N.E. Searle,
U.S. Patent: 2,462,423; CA: 43 3843, 1949.
62. Sakai Shijukoshi et al.,
Bull. Chem. Soc. (Japan), 48, 2981, 1975.
63. Ottmann and Kober,
Angew Chem. Int. Ed. Engl. 8, 760, 1969.
64. Hodgkins, E. Joe et al.
J. Org. Chem., 29, 10, 3098, 1964
65. Dash B, S.K. Mahapatra,
J. Indian. Chem. Soc., 50(11), 738-39, 1973.
66. Jean Leclerc and Leo Benoifon,
Can. J. Chem., 1049, 1968.
67. Yoshiyasu Furukawa, Shunsuke Shima,
Chem. Pharm. Bull., 24(5), 979-86, 1976.
68. D.J. Brown,
J. Appl. Chem. Lond., 2, 239-41, 1952.

69. D.M. Besly and A.A. Goldberg,
J. Chem. Soc., 4997-5001, 1957.
70. V.G. Ermolaeva, Zykova,
Khim. Farm. Zhik., 1, 19, 1967.
71. Y.G. Perron, W.F. Minor and L.B. Crast,
J. Org. Chem., 26, 3365, 1961.
72. ~~Robert Shapiro et. al.~~ *A.Kjoer, C. Djerassi*
~~J. Org. Chem., 33, 243, 1968.~~ *Acta Chem Scand. 17, 2143, 1963*
73. Robert Shapiro, J.W. Serum and A.M. Duffield,
J. Org. Chem., 33, 1, p.243, 1968.
74. A.I. Vogel,
"Practical Organic Chemistry" p.387-390.
75. S.P. Acharya and K.S. Nargund,
J. Sci. Ind. Res., 21B, 487-90, 1962.
76. G.O. Gutekunst and H.L. Gray,
J. Am. Chem. Soc. 44, 1742 (1922).
77. G. Weygand,
Ber. 71, 2399, 1938.
78. Org. Synth. Coll. Vol. 3, p.140, 1955.
79. B.M. Adger and R.G. Young,
Tetrahedron Lett., 25, No.45, 5219-29, 1984.
80. R.D. Dabholkar,
Ph.D. Thesis, University of Bombay, 1978.
81. Hodgkins E. Joe et. al.
J. Org. Chem., 29, 3098, 1964.
82. J.P. Trivedi and J.J. Trivedi
J. Ind. Chem. Soc., 35, 657, 1958.
83. Org. Synth. Coll. Vol. I, p. 396 & 406.
84. Schwenk E. and D. Papa,
J. Org. Chem., 11, 798, 1946.
85. *T. Ukai, Yamamoto*
J. Pharm. Soc. Japan, 74, 674, 1954.
86. F. Shigeo Okumura, Hiroshi Kusaki and Telsuji Takematsu,
Bull. Chem. Soc., Japan, 33, 1471, 1960.
87. V.G. Ermolaeva Zykova
Khim Farm Zh., 1, 19, 1967.

SYNTHESIS OF THIOUREAS WITH ACETYLINIC SIDE CHAIN3.0-0 INTRODUCTION

In the previous Section we described diarylthioureas containing o-butyl, o-benzyl^{am} and o-hexyl side chains in one of the aryl nucleus. In this Section we are describing diarylthiourea containing o-side chain having conjugated acetylene carboxylic esters. The idea of introducing this is to synthesize compounds having such a side chain with the hope that this will bind irreversibly with the target enzyme and thus acting as inhibitor of the enzyme. Many instances are in literature of the use of acetylene as enzyme inhibitor and thus helped in the design of new drugs. It is known that enzymes catalyse the reaction of their substrates by initial formation of a complex between the enzyme and the substrate(s) at the active site of the enzyme. The complex will then break down either indirectly or directly or through intermediate stages to give the products of reaction with the regeneration of enzyme. The body contains several thousand different enzymes each catalysing a reaction of a single substrate or a group of substrates. An array of enzymes is involved in a metabolic pathway, each catalysing a specific step in the pathway. These actions are integrated and controlled in various ways to produce a coherent pattern governed by the requirement of the cell. There is evidence that a number of drugs in clinical use exert their action in the body by inhibiting a target enzyme which is either normally present

in the mammalian tissue or has been produced by an infection. Many of the drug introduced into therapy on a rational base as enzyme inhibitors are later proved to exert their action in this manner.

In a clinical condition an inhibitor might be used to decrease the activity of an enzyme to decrease production of a metabolite. Inhibition of the enzyme is a pathway which governs the rate controlling step in the series of reaction is most effective.

In an infection, intense enzyme activity occurs with production of nuclear material for cell division followed by the spread of the infection. Inhibition of enzyme activity is helpful in removing the infection.

The basic concept of the use of enzyme inhibitors as drugs requires in practice that the inhibitor has several acceptable features before it can be considered as a suitable candidate for clinical use. These are:

- i) It must have a structural resemblance to the normal substrate/metabolite so that it may fit and bind to the enzyme in a similar fashion. This structural similarity is generally reflected in a molecular dimension and also in electron distribution, since most enzyme active sites are highly polar. Thus one can substitute one electron attracting or repellent group by another.

- ii) The inhibitor must reach its site of action, the target enzyme and persist there. This depends on factors like the rates of excretion and metabolism as well as correct log P values for transport to the target.
- iii) The action must be restricted to the target enzyme so that it shows specificity of action. In case if it affects the other enzymes essential for well being of the cell, it will upset the cellular balance which will manifest in toxic side effects.

Designing of such an inhibitor with absolute specificity for a target enzyme seems to be difficult, but the object was to limit the spectrum of the inhibitors to other targets and the relative potency. But with the invent of K_{cat} inhibitors the development of more specific agents is now possible.

The inhibitors may be of two types. They may be reversible inhibitors or irreversible inhibitors. Some reversible inhibitors used clinically are given below:

Drug	Enzyme inhibited	Clinical use
Allopurinol	Xanthine oxidase	Treatment of gout
Acetazolamide, Dichlorophenamide	Carbonic anhydrase	Diuretic
Trimethoprim, Pyrimethamine, Paludrine, Methotrexate	Dihydrofolate reductase	Antibacterial, Antimalarial Anticancer agent
Aspirin	Prostaglandin synthetase	Anti-inflammatory

contd....

Drug	Enzyme inhibited	Clinical use
Cardiac glycosides	Na, K ⁺ -ATPase	Heart ailments
Amphenone, Metyrapone	11 -Hydroxylase	Test for pituitary function
6-Mercaptopurine, Azathioprine	Riboxyl amidotransferase	Anticancer agent
5-Fluorouracil, Floxuridine	Thymidylate synthetase	Anticancer agent
Captopril	Angiotensin-converting enzyme	Hypotensive agent
Sulthiame	Carbonic anhydrase	Treatment of epilepsy
Sodium valproate	GABA transaminase(?)	Treatment of epilepsy
Idoxuridine	Thymidine kinase and thymidylate kinase	Antiviral agent
Cytosine arabinoside (Ara-C) 5-Fluoro-2,5'-anhydro-cytosine arabinoside	DNA and RNA polymerases	Antiviral and anticancer agents

Majority of the drugs in the category are of the competitive type on a wide range of mammalian enzymes. They are mostly active in vitro and do not produce the required pharmacological effect when test in vivo. This is mostly due to the correct log P value which is essential to penetrate the many cellular membranes it has to pass through before reaching the target enzyme. The other explanation advanced is that: a) the inhibitor reaches the target enzyme and exert a brief inhibitory effect on the enzyme before built up of the substrate reverses the inhibition to a steady state inhibition level which is below the threshold level necessary

to produce the pharmacological response, (b) the target enzyme does not catalyse the rate controlling step in a metabolic chain and operates below its maximum efficiency so that the inhibition has little effect on the overall pathway. Reversible inhibitors have relatively short duration of action when used as drugs and the administration of drug at frequent intervals is required to maintain the clinical response, and also the plasma level of the drug falls due to metabolism and excretion, the compartmental concentrations of the drug decrease and the enzyme is left to obey the requirements of the changing equilibrium.

Reactive functional groups present in active site-directed irreversible inhibitors and enzymes

FUNCTIONAL GROUPS ON INHIBITOR

(1) Alkylating functions:

-Halogenoketone

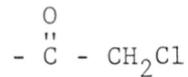

Diazoketone



Maleamide

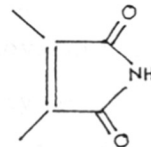
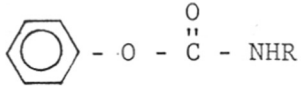



Table contd...

(2) Acylating function:

Phenylurethane	
Sulphonyl halide	- SO ₂ Cl
Reactive ester	- COO - 

FUNCTIONAL GROUPS ON ENZYME

Imidazole nitrogen (histidine residue)	- COOH
Carboxylate (aspartate, glutamate)	
Amino - -amino (terminal)	- HN - $\overset{\text{O}}{\parallel}{\text{C}}$ - $\overset{\text{R}}{\parallel}{\text{CH}}$ - NH ₂
- -amino (lysine)	- NH ₂
Methyl mercapto (methionine)	- S - CH ₃
Hydroxyl (serine)	- CH ₂ OH

Irreversible inhibitors form a covalent bond with a functional group in the enzyme, usually at the active site or just outside depending on the molecular dimension of the inhibitor.

There are two classes of irreversible inhibitors; the active site-directed inhibitors where the reactive function

is already present and the K_{cat} inhibitors where this function is generated by the enzyme.

Irreversible inhibitors render the enzyme inactive to its substrate by blocking access to the active site and also, in certain instances, by removing the catalytic activity of the enzyme should reaction occurs with a catalytic group within the active site.

This type of inhibitor either contains or develops a reactive functional group which may be either an alkylating or an acylating (phosphorylating) function. A list of functional groups normally used in active site directed irreversible inhibitors is given in the preceding table:

Some Irreversible Inhibitors used clinically

Drug	Enzyme inhibited	Clinical use
Sulphonamides	Dihydropteroate synthetase	Antibacterials
Hydrazine derivatives	Monoamine oxidase	Antidepressants
Serazide, carbidopa	Dopa decarboxylase	In conjunction with L-dopa in Parkinson's disease
Neostigmine, Eserine, Pyridostigmine, Benzpyrinium, Dyflos, Ecothiopate	Acetylcholinesterase	Glaucoma, myasthenia gravis.
Penicillins, Cephalosporins	Transpeptidase	Antibiotics
Organoarsenicals	Pyruvate dehydrogenase	Antiprotozoal agents
O-Carbamyl-D-serine	Alanine racemase	Antibiotic

Table contd...

Table contd.

Drug	Enzyme inhibited	Clinical use
D-Cycloserine	Alanine racemase and other enzymes	Antibiotic
Azaserine	Formylglycinamide ribotide amido transferase	Anticancer agent
-Vinyl GABA	GABA transaminase	Anti-convulsant
Clavulanic acid	-Lactamase	Adjuvant to penicillin antibiotics
-Mono(di)fluoro-methyl-dopa	Dopa decarboxylase (A.A.A.D.) (peripheral)	Hypotensive

In the present investigation, it is hoped that the compounds synthesised may act as irreversible inhibitors. It is to be noted that acetylenes react slowly with primary anions (Kruse and Klein Schmidt, JACS, 83, 213, 1961) and that very great increase in rate can be obtained by converting a bimolecular to a unimolecular reaction, (Bruice, A. Rev. Biochem., 45, 331, 1976; Page and Jenecks, Proc. Natl. Acad. Sci., USA, 68, 1678, 1971). It is assumed that the irreversible steps of the inactivation process in our type of work will probably be a Michael type reaction in which an enzyme as a nucleophile adds to an unsaturated carbon made electrophilic by conjugation. A detailed discussion is deferred at this stage. However if these acetylinic compounds show good activity, then we can investigate further mechanism of action. It is presumed at this stage that the thiourea moiety may act by the inhibition of mycolic acid synthesis in the cell wall and the acetylinic group may further enhance the activity of these compounds.

In the present investigation, the following type of compounds were prepared.



where R = O C₄H₁₁, OCH₃, Cl, 3,4(Cl)₂, CH₃, H, SO₂Me, NO₂, NHSO₂Me, CN, CONHMe, CH₂OMe, COCH₃, and O-CH₂-C≡C-COOMe.

This section is divided into three parts; viz.

- A) Preparation of some p-substituted anilines and methyl-4-(p-aminophenyloxy)-but-2-ynoate
- B) Preparation of p-substituted phenyl isothiocyanates
- C) Condensation of p-substituted phenyl isothiocyanates with methyl-4-(p-aminophenyloxy)-but-2-ynoate.

3.1-0 PREPARATION OF p-SUBSTITUTED ANILINES

The p-substituted anilines were prepared by the reduction¹ of their respective nitro compounds using Raney-Ni-hydrazine hydrate as shown in the following table.

Sr.No.	Nitro Compound	Reducing Agent	Amino Compound	Yield (%)	B.P./ M.P.	Lit. Ref.
1.	p-Butoxy nitrobenzene	Hydrazine hydrate/ Raney-Ni	p-Butoxy aniline	75	130/ 10 mm	2
2.	3,4-Dichloro nitrobenzene	-do-	3,4-Dichloro aniline	50	71	3
3.	4-Nitrophenyl-4'-methyl sulphonate	-do-	4-Aminophenyl 4'-methyl sulphonate	90	135	4
4.	4-Nitro benzyl methyl ether	-do-	4-Amino benzyl methyl ether	80	165/ 50 mm	5
5.	N-Methyl-p-nitro benzamide	-do-	N-Methyl-p-amino benzamide	61	180	6
6.	p-Nitro ethyl benzene	-do-	4-Ethyl aniline	75	212	7
7.	p-Nitro acetanilide	-do-	N-Acetyl 1,4-diamino benzene	55	165	8
8.	N-Methyl p-nitro sulphonamide	-do-	N-Methyl sulfonyl 1,4-diamino benzene	70	115	9

The remaining amines, viz. p-cyano aniline, aniline, p-anisidine, p-chloro aniline and p-amino acetophenone were obtained from commercial sources (Aldrich Chem.).

3.1-1 Synthesis of Methyl-4-(p-aminophenoxy)-but-2-ynoate

The preparation of the above amine involves:

(1) Preparation of methyl-4-(p-nitrophenoxy)-but-2-ynoate and (2) Reduction to the corresponding amino derivative.

(1) Preparation of methyl-4-(p-nitrophenoxy)-but-2-ynoate

A number of schemes were tried to get the title compound in good yields. In designing the strategy for the synthesis of this nitro compound, the number of steps, availability of raw materials and overall yields had to be taken into consideration.

The carbonylation of 1-p-nitrophenoxy-prop-2-yne seemed to be an attractive scheme as it is a one step conversion to the desired ester (Scheme I).

p-Nitrophenol was alkylated with propargyl boramide in acetone and potassium carbonate to yield 1-p-nitrophenoxy-prop-2-yne; m.p. 145-47°C. IR: 3250 (s) (C-H str.) and 2110 cm^{-1} ($\equiv\text{C}$) for terminal acetylene. The p-disubstituted pattern in the aromatic region and the methylene protons at 3.8 confirmed the structure. In a report¹⁰ the carbonylation of 1-phenoxy-prop-2-yne was done with PdCl_2 in methanol. Applying the same procedure i.e. palladium chloride, cuprous chloride and sodium acetate were taken in dry methanol along with 1-p-nitrophenoxy prop-2-yne and stirred with a rubber balloon filled with carbon monoxide for 2 h. The product isolated after filtration was found to be identical with

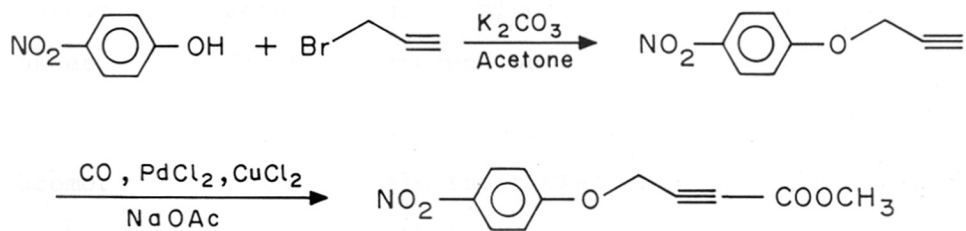
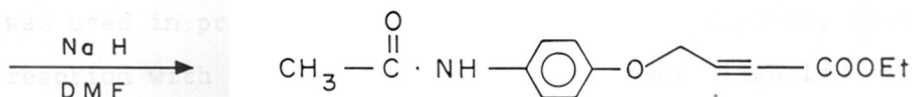
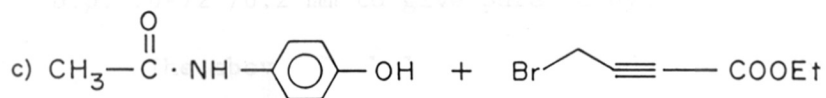
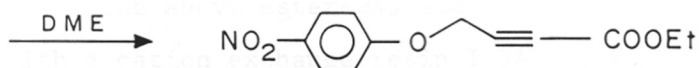
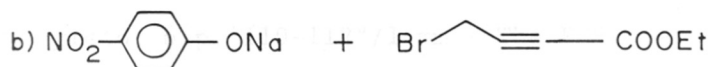
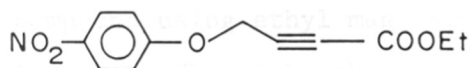
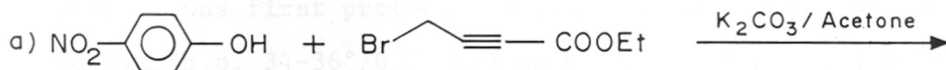
SCHEME (I)SCHEME (II)

the starting material. Hence it was concluded that the carbomethoxylation on this compound was not possible. Thus other routes for this compound were explored.

The direct condensation of p-nitrophenol with ethyl- γ -bromotetrolate would yield the target compound. Thus the task of preparation of ethyl γ -bromotetrolate was pursued.

The above compound was prepared by reported procedures^{11,12} starting with propargyl alcohol. Propargyl alcohol was first protected as its tetrahydropyranyl derivative (b.p. 34-36°/0.25 mm) using dihydropyran and PTSA. The acetylenic Grignard reaction was carried out on this compound using ethyl magnesium bromide and ethyl chloroformate. The carboethoxylation of the free acetylenic side of protected propargyl alcohol took place in a facile manner to give ethyl (tetrahydropyran-2'-yloxy)tetrolate in 40-45% yield; b.p. 110-112°/1 mm. The PMR spectrum was also identical to that reported in the literature¹² (Scheme III).

The above ester was added to dry ethanol and stirred with a cation exchange resin I RA 180 for 2 h. to yield a clean product. The alcohol obtained was further distilled b.p. 70-72°/0.2 mm to give pure ethyl γ -hydroxytetrolate.

The above alcohol was converted into its bromide by two methods. In the first method, phosphorous tribromide was used in presence of pyridine in ether. However, with reaction with PBr_3 gave a product which was slightly

contaminated with an isomeric impurity, not easily separable by fractional distillation. Hence the conversion of alcohol to bromide was carried out in neutral conditions, viz. triphenylphosphonium bromide.¹³ In a typical reaction, the acetylinic alcohol was taken in acetonitrile and half equivalent of triphenylphosphine was added to it. The solution was cooled and bromine was further added in a dropwise manner. The reaction on work up yielded the bromo ester with high purity; b.p. 60-67°/0.5 mm. The IR spectrum showed the characteristic $C \equiv C$ stretching at 2240 cm^{-1} and the PMR data corroborated with that reported in the literature. Further condensations were carried out on the bromo ester, Scheme II(a).

The reaction of p-nitrophenyl with γ -bromo ethyl tetrolate in acetone and potassium carbonate gave on work up a compound with a m/e peak at 388. The microanalysis of this compound showed that it has 2 nitrogen atoms (N 7%). The absence of the acetylinic group was also shown in IR. However, an $\alpha\beta$ unsaturated double bond was evident from the 1600 cm^{-1} signal. The PMR spectrum of this compound confirmed the presence of a vinylic α -proton (6.05 τ) attached to an electron withdrawing group ($C = \overset{H}{C} - COOEt$) along with the triplet (1.1) and quartet (4.0) of the ($COO\text{CH}_2\text{CH}_3$) carboethoxy moiety. A signal at 4.8 τ having an integration of 2 protons was assigned to a ($Ar-OCH_2$) methylene group ($R-O-\text{CH}_2-\overset{R}{C}=\overset{H}{C}-CO_2Et$).

The typical aromatic pattern showed o-coupled doublets at 8.2 and 7.2 δ and a multiplet at 7.0 δ thus indicating the fact that different substituents were present on the oxygen atom of the p-nitrophenyloxy group. This led to the structure $p\text{NO}_2\text{-Ph-O-CH}_2\text{-C}(\text{O-Ph-NO}_2\text{)=C-CO}_2\text{Et}$ which shows both alkylation and also Michael addition product of phenolate ion.

This was confirmed by ^{13}C NMR as shown below:

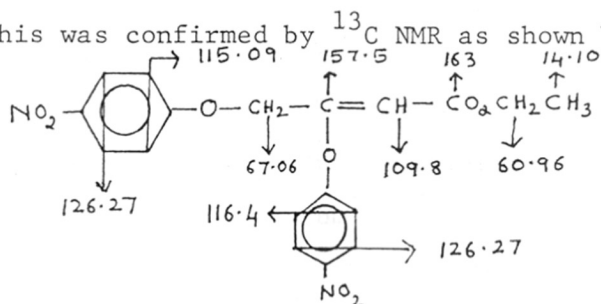

Modifications in the above condensation conditions were thus employed to ensure a mono-alkylation product. The sodium salt of phenol was prepared and isolated. The sodium phenate thus obtained was reacted with ethyl α -bromotetrolate under neutral conditions, i.e. it was stirred under nitrogen in dimethoxy ethane (DME) as a (IIb) solvent. The product formed in the reaction could not be characterized; hence this method of condensation was abandoned. The condensation of p-nitrophenol and ethyl-bromotetrolate in DMF and potassium carbonate yielded the same compounds as obtained in the earlier reactions.

From the above observations, it was concluded that the bromo ester was too reactive for condensations, hence a less reactive chloro-ester was envisaged.

Ethyl γ -chlorotetrolate was prepared from its hydroxy derivative through its mesylate. Ethyl- γ -hydroxy tetrolate was treated with methane sulphonyl chloride in triethylamine and dichloromethane and stirred at 0°C to yield the mesylate which was converted to the chloro derivative by treating it with lithium chloride and acetone. On work up a good yield of ethyl- γ -chlorotetrolate was obtained.¹⁴

When the condensation of p-nitrophenol with the chloro ester was carried out, a complex mixture of product was observed on TLC (benzene : acetone, 9:1). The same reaction was also tried on sodium phenolate but the condensation did not take place. Hence this scheme was also abandoned.

The reaction of p-acetaminophenol (p-acetamol) with the bromo ester in acetone, potassium carbonate was tried. However, the desired condensed product was not obtained, (IIc). Changing the reaction conditions, i.e. sodium hydride, DMF also did not work out. The same reaction was tried on the chloro ester but again a complex mixture of products was observed on TLC.

Looking at the complexity of the above condensations a circuitous route had to be planned in designing the synthesis of methyl-4-(p-nitrophenoxy)-but-2-yne-oate. The introduction of an acetylenic group by bromination and dehydrobromination has been well documented in the literature.¹⁵ The same procedures were applied using easily available 4-chloro-butene-2-ol, (Scheme IV).

SCHEME (III)

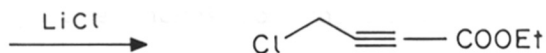
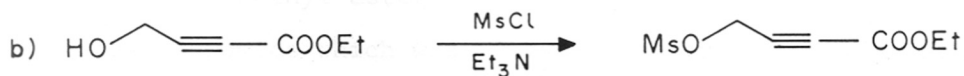
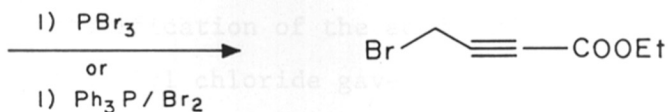
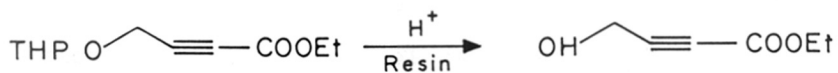

SCHEME (IV)

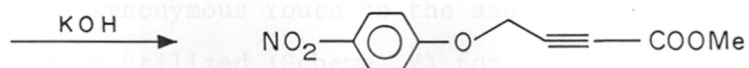
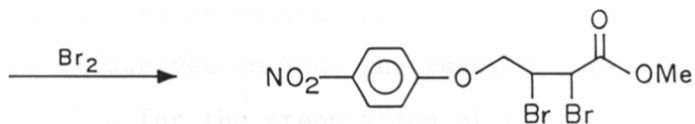
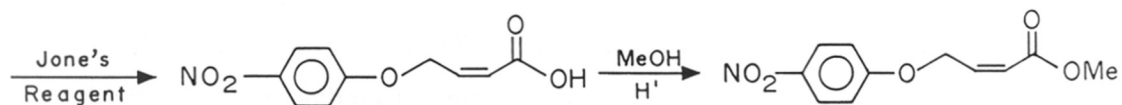
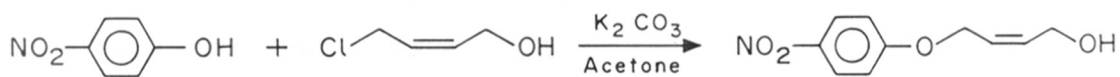

4-Chloro-butene-2-ol was prepared from butenediol and thionyl chloride.¹⁶ Condensation of p-nitrophenol yielded 4-(p-nitrophenoxy)-butene-2-ol in good yields. The alkylation was done in ethanol using sodium hydroxide. The alcohol was oxidized to the acid by Jones's reagent in acetone. Esterification of the acid with MeOH using catalytic amount of acetyl chloride gave methyl-4-(p-nitrophenoxy)-but-2-ene-oate.

This methyl ester was brominated in chloroform to give the dibromide which was isolated and purified. The absence of the vinylic protons in PMR and the (C = C) stretching in IR gave evidence for the structure. Dehydrobromination of the dibromide was carried out according to a literature procedure.¹⁵

When an ester is normally refluxed with a base, the hydrolysis of the same takes place to yield an acid. Thus the dibromo ester was expected to give the acetylinic acid which on re-esterification would yield the desired acetylinic ester. However, when the dibromide was refluxed with potassium hydroxide in ethanol, gave a complex mixture of products accompanied by polymerization. However, due to a number of spots observed on TLC, the reaction was not found to be feasible for the preparation of the title compound.

A synonymous route to the above set of reactions was finally utilized (Scheme V) for effecting the preparation

SCHEME V

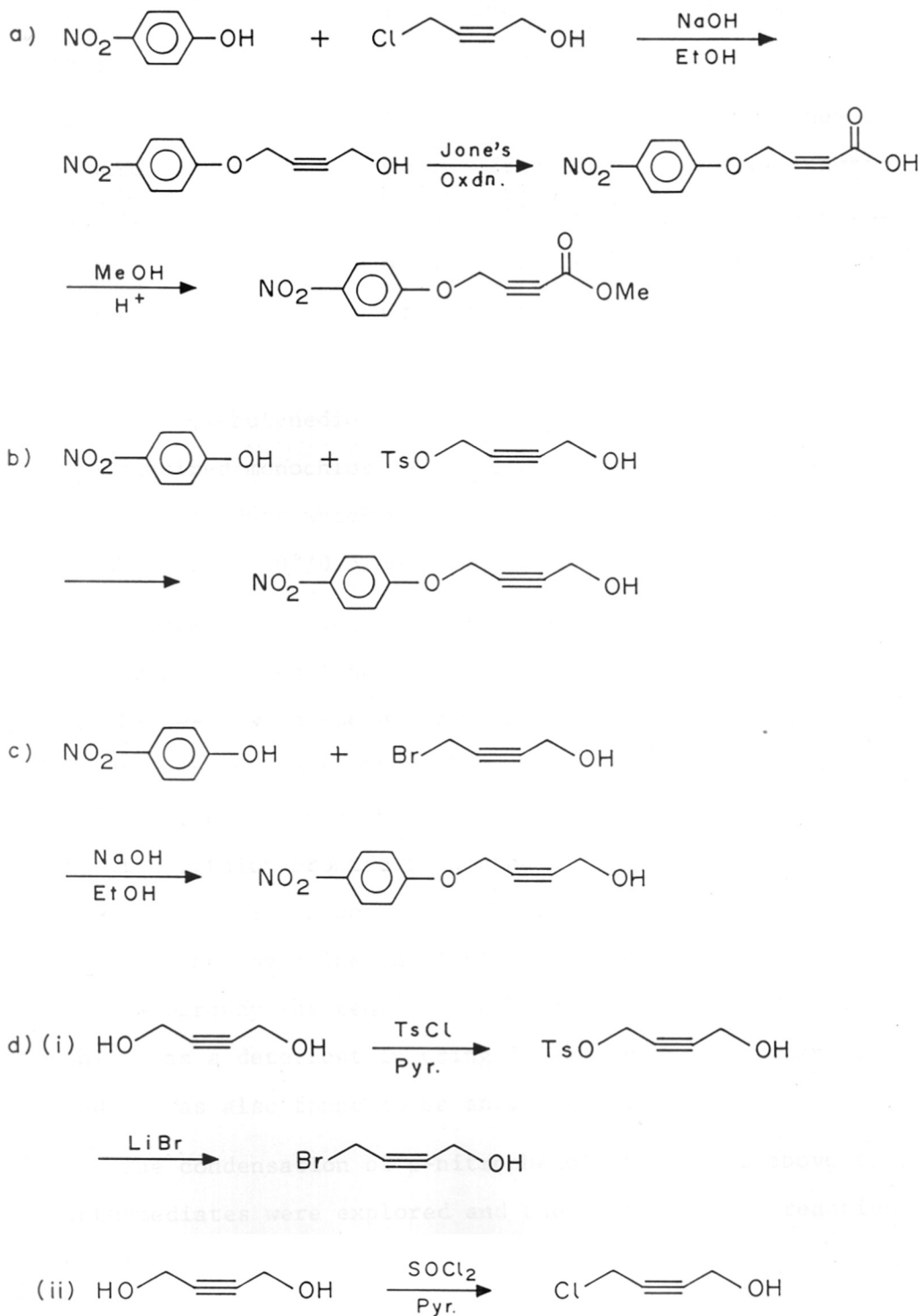

of methyl-4-(p-nitrophenoxy)-but-2-yne-oate in gram quantities.

A mention about the toxicity of 4-chloro-but-2-yne-ol should however be made as it affected in ppm levels causing unlocalized irritations. As depicted in the scheme, 4-chloro-2-yne-ol were prepared by different reported procedures and their condensation with p-nitrophenol was studied.

4-Chloro-but-2-yne-ol was prepared by the monochlorination of 1,4-butyne diol by thionyl chloride in pyridine.¹⁷ The required monochloro alcohol was fractionated from the dichloro product which was low boiling. The monochloro alcohol, b.p. 50°/0.5 mm was obtained in approx. 50% yield.

4-Bromo-but-2-yne-ol could be either obtained from 4-chloro or 4-tosyl-but-2-yne-ol. Treatment of 4-chloro-but-2-yne-ol with sodium bromide in methanol yielded the bromo compound, b.p. 46°/0.1 mm. This could be also accomplished by treating 4-p-toluene sulphonate of but-2-yne-ol with lithium bromide in acetone. 1,4-Butyne-diol was converted to its monotosylate by reacting it with tosyl chloride and pyridine in dichloromethane. However, column chromatography was required to obtain the pure monotosylate which was a deterrent in using it as a starting material and it was also found to be an irritant.

The condensation of p-nitrophenol on all the above three intermediates were explored and the best possible reaction was standardized.

Acetone/potassium carbonate alkylation of the bromo compound as well as the chloro alcohol on p-nitrophenol was studied, and it was observed that there was no significant difference in the yields of the alkylated product. Similarly alkylation using sodium hydroxide and ethanol on both the bromo and chloro but-2-yne-ol gave almost same yields. But the overall yield of the latter, using the chloro derivative was better than the one starting from bromo derivative and hence it was taken as the reaction of choice in the preparation of 4-p-nitrophenoxy-but-2-yne-ol. Oxidation of the alcoholic group to the acid was carried out using Jone's method which gave the desired 4-p-nitrophenoxy-but-2-yne-oic acid in quantitative yields.

The acid was purified as its sodium salt and regeneration with dilute hydrochloric acid. Esterification of the above acid with dry methanol and catalytic amount of acetyl chloride which decomposed in presence of methanol to give in situ hydrochloric acid which further catalysed the reaction to give methyl ester. Thus finally methyl-4-(p-nitrophenoxy)-but-2-yne-oate was obtained by the above procedure in good overall yield.

Characterization of the above ester was made on the basis of PMR which showed a singlet at 3.5 (COOCH_3), and 4.5 (Ar-O-CH_2) along with p-disubstituted pattern in the aromatic region. A $\text{C} \equiv \text{C}$ stretching at 2220 cm^{-1} and $\text{C} = \text{O}$ at 1710 cm^{-1} further confirmed the structure along with the

molecular ion peak at M^+ 235 corresponding to its molecular weight.

(2) Synthesis of methyl-4-(p-aminophenyl)-but-2-ynoate

The p-amino functionality in methyl-4-(p-aminophenyl)-but-2-ynoate was introduced by the reduction of the corresponding nitro compound, i.e. methyl-4-(p-nitrophenyl)-but-2-ynoate.

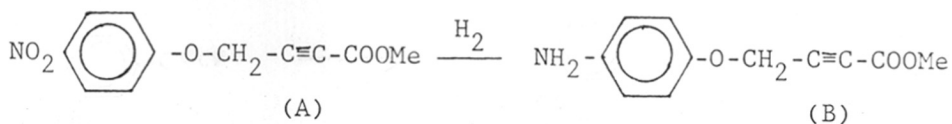

A search in the chemical literature showed that only chemical reducing agents such as ferrous sulphate,¹⁸ sodium hydrosulfide¹⁹ or zinc in ammonium hydroxide²⁰ have been used to reduce aromatic nitro groups in phenyl acetylenes. However, many difficulties such as high dilution, large excess of reagent might affect the course of the reaction. With this view in mind, a good selective catalytic hydrogenation method would best fit the desired combination of cleanly reducing the nitro group in presence of other reducible groups i.e. the acetylinic group in our case.

It has been reported that in molecules containing both acetylinic and nitro functions, both may be reduced by catalytic hydrogenation. Preferential reduction of acetylinic function is achieved by palladium.²¹ Ruthenium on the other hand favours selective reduction of aromatic nitro function.

Onopchemko²² and co-workers have studied the reduction of 3-nitrophenyl acetylenes using various catalysts. In one method, 2-meta nitro acetylene was protected with acetone and then reduced with Ruthenium on carbon (5%) in a Parr hydrogen shaker for 21 h. at 30-60 psi. They obtained the amino compound in 99% conversion and 95% selectivity with 5% Ru. on Al_2O_3 . He got a selectivity of 100% after stoichiometric amount of hydrogen was absorbed.

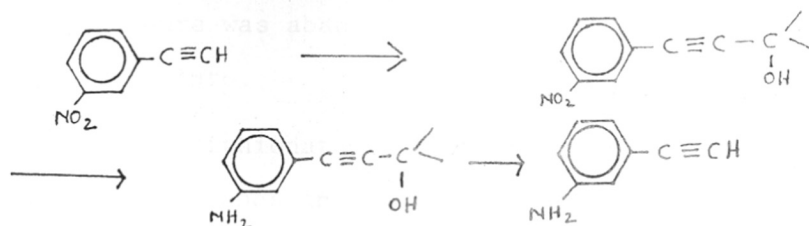

To avoid the protection step of acetylenes, the same co-workers²² used a homogeneous catalyst system, i.e. cobalt polysulfide and ruthenium polysulfide for hydrogenation of nitro to amine. However, the conditions for this reaction were too drastic i.e. pressures up to 25-70 atmospheres were used at 100°C .

This hydrogenation method was used to reduce the nitro compound to methyl-4-(p-aminophenoxy)-but-2-yne-oate. In a typical procedure 0.01 mole of the nitro compound was taken in isopropanol (25 ml) and shaken on a Parr hydrogenater at 50-60 psi with 0.5 g of 5% Ru/C for 24 h.

The product obtained was a mixture of compounds on TLC (benzene : acetone, 9:1) and the infrared spectra showed a

disappearance of the acetylinic band at 2210 cm^{-1} . This signifies that the reduction of the acetylinic group has taken place. The partial reduction to olefin or complete saturation of the acetylene may have resulted in the mixture of product.

Since the reaction did not give a clean product and also looking at the cost and availability of ruthenium/carbon, this procedure was abandoned and other homogeneous reactions were looked into.

Sodium dithionate is known to reduce nitro groups in presence of alkenes and alkynes.²³ However, when methyl-4-(p-nitrophenoxy)-but-2-yne-oate was refluxed with excess of sodium dithionate in MeOH and water mixture for 1 - 2 h, 50% of the starting material was recovered and other unidentifiable mixture of products.

Reduction²⁴ of nitro to amine has been demonstrated in presence of stannous chloride and ethanol. The authors have reported that the reduction can be carried out for substrates with other sensitive groups like ester group. For example, they reduced p-nitrophenyl acetate to p-aminophenyl acetate. This method when tried on ~~was~~ gave undesired products, hence the use of this reagent was ruled out.

A very reliable reagent for reduction of aromatic nitro group in presence of sensitive function is iron which does not affect the acetylene functionality.²⁵ The presence of iron

salts in the reaction medium is a must hence, ferric chloride or ferrous sulphate is generally used in the reaction. The salts are used in catalytic amount. Thus, the nitro compound on refluxing with iron powder in presence of 10% w/w ferrous sulphate in water gave a product identical to the desired amine. The procedure²⁶ applied was similar to that used in the reduction of 1:5 dinitronaphthalene to 1:5 diamino-naphthalene. However, the yields of the amine after column chromatography were not good enough for this procedure to be implemented in the preparation of methyl-4-(p-aminophenoxy)-2-but-2-yne-oate.

The failure of above reagents left the option open for zinc dust to be used as a reducing reagent. Zinc reduces nitro group in different ways depending on pH. Since it was seen that as far as possible neutral conditions will be favourable for treating the nitro compound with a reducing agent, the first choice available was that of zinc and calcium chloride combination. An Organic Synthesis procedure uses a mixture of zinc and calcium chloride in aqueous ethanol to reduce the nitro group to amine.²⁷

Thus nitro compound was refluxed for 3-4 h under the above conditions, but on work up, only starting material was obtained. However, on refluxion for longer periods, a decomposition of the product occurred and thus the reaction had to be abandoned.

Zinc dust was used to reduce p-nitro acetylene to p-amino acetylene in presence of ammonium hydroxide. The amine was obtained in good yields.²⁸ The same procedure was emulated in the reduction. The nitro compound was stirred at room temperature with zinc dust in 2% ammonia solution and the reaction monitored for 24 h. A mixture of starting material and the amine was obtained even after stirring for longer hours. Since the separation of the above two would have been difficult as the amine decomposed on silica gel on keeping for longer time, this procedure was also abandoned.

Thus, a need for a reagent, which would give a clean reaction, i.e. devoid of starting material and other side products, was indispensable. The use of acetic acid as a adjunct to zinc dust was envisaged for reducing the nitro compound to the desired amine.

The reaction was carried out in dichloromethane and acetic acid using activated zinc dust. In a typical procedure 2.35 g (0.01 mol) of methyl 4-(p-nitrophenoxy)-but-2-yne-oate was stirred with 20 ml acetic acid and 20 ml dichloromethane in presence of 1 g of activated zinc dust for 12 h. The reaction mixture was filtered through a plug of silica gel and basified with ammonia. The mixture was immediately extracted with dichloromethane which on drying over anhydrous sodium sulphate and evaporation gave methyl-4-(p-aminophenoxy)-but-2-yne-oate in 75% yield as an oil.

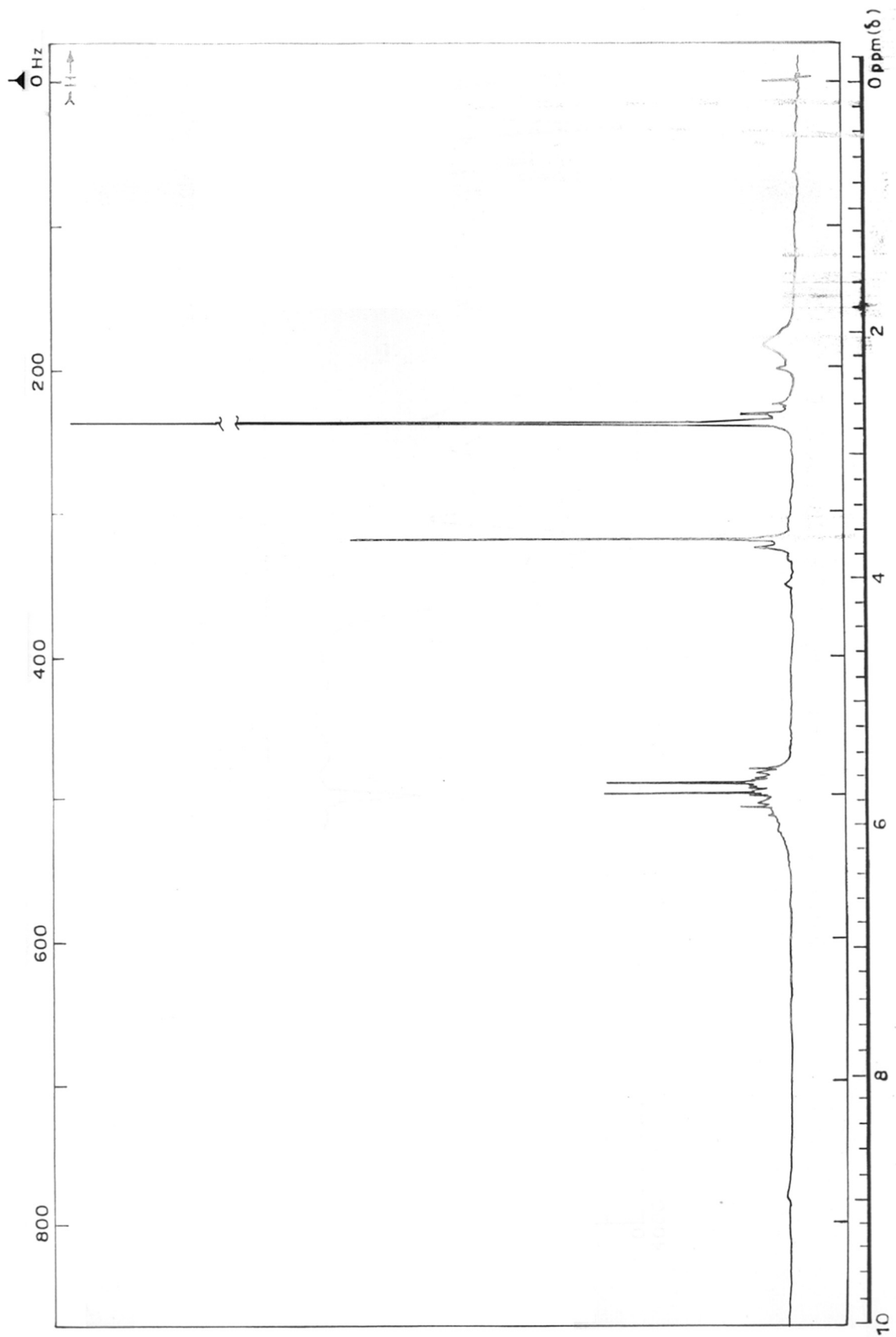

144

FIG. IX (a). PMR SPECTRUM OF COMPOUND B

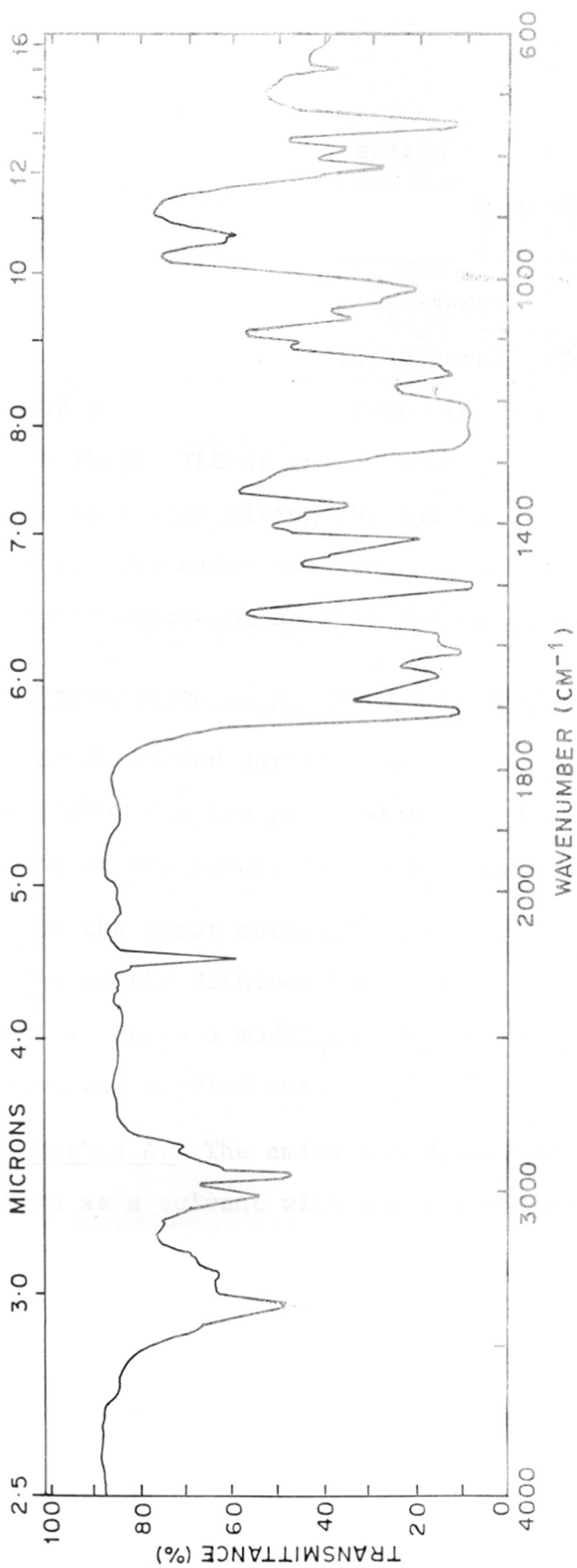

FIG. IX (b). IR SPECTRUM OF COMPOUND B

The amine was characterized by PMR which showed the absence of a p-disubstituted pattern of the nitro compound in aromatic region (a multiplet at 6.9 was observed). The characteristic peaks for amine (3400 cm^{-1}), the substituted acetylene (2220 cm^{-1}) and the carbonyl stretching (1720 cm^{-1}) in the IR spectra also confirmed the structure [Figure - IX (a) & (b)]. TLC of amine (benzene : acetone, 9:1) showed a single spot thus giving the evidence for the purity of the amine. The amine was used as such without purification for further condensation reactions with isothiocyanates.

3.2-0 Preparation of p-substituted isothiocyanates

As discussed earlier (Section 2) two general methods were employed for the preparation of the isothiocyanates depending on the functionality in para-position of the amines.

In the first method,²⁹ i.e. (CS_2 , triethylamine), the isolation of the dithiocarbamate salt sometimes becomes difficult. Hence a modification to avoid the isolation of this salt was carried out.

Method A: The amine was dissolved in carbondisulphide, used also as a solvent with one equivalent of triethylamine and it was refrigerated overnight. Carbondisulphide was removed and the reaction mixture was treated with ethylchloroformate in chloroform to give the desired isothiocyanates which were purified either by column chromatography or distillation.

Method B:^{30,31} The compounds containing electron withdrawing groups were prepared by this method.

Thiophosgene reacts with the amines to give unstable thiocarbamyl chloride which splits off hydrogen chloride easily to give the isothiocyanate.

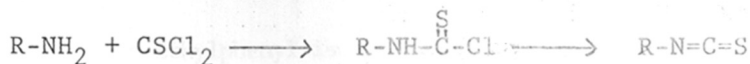

The reaction is performed in aqueous medium using the hydrochloride of the amine.

In a general method, the amine is dissolved in 1:1 HCl and one mole equivalent of thiophosgene was added and the solution stirred overnight. The isothiocyanate was isolated by filtration and then purified by crystallisation.

The isothiocyanates thus prepared by the above methods were characterised by mass spectral analysis and their infra-red absorption ($2050-2150 \text{ cm}^{-1}$ of N=C=S).

The following isothiocyanates (Table I) were prepared:

TABLE I

Sr.No.	Compound	Method	Yield (%)	M.P./B.P.	Lit.Ref.
1.	p-n-Butoxyphenyl isothiocyanate	A	52	190°/ 16 mm	32
2.	p-n-Methylphenyl isothiocyanate	A	60	140°/ 10 mm	33
3.	p-Chlorophenyl isothiocyanate	A	60	44-45°	34
4.	3,4-Dichlorophenyl isothiocyanate	A	65	134°/ 7 mm	35

TABLE I (contd..)

Sr.No.	Compound	Method	Yield (%)	M.P./ B.P.	Lit.Ref.
5.	p-Methyphenyl isothiocyanate	A	65	110 ^o / 10 mm	36
6.	Phenyl isothiocyanate	A	70	118 ^o / 35 mm	37
7.	p-Ethylphenyl isothiocyanate	A	48	113 ^o / 5 mm	38
8.	p-Methoxymethylene phenyl isothiocyanate	A	80	oil	
9.	p-Cyanophenyl isothiocyanate	B	75	119 ^o	39
10.	p-Nitrophenyl isothiocyanate	B	80	112	40
11.	p-N-Acetamidophenyl isothiocyanate	B	60	191	41
12.	p-N-Methylbenzamido isothiocyanate	B	50	180 ^o	
13.	p-Methyl sulfonyl phenyl isothiocyanate	B	62	136 ^o	47
14.	p-Methyl sulfamoyl phenyl isothiocyanate	B	90	153 ^o	
15.	p-(1-Carbomethoxy-prop-lyne-3-oxy)phenyl isothiocyanate	B	66	132 ^o	

3.3-0 Condensation of various p-substituted phenyl isothiocyanates with methyl-4-(p-aminophenyl)-but-2-yne-oate

The methyl-4-(p-aminophenyl)but-2-yne-oate was used as such without purification, since it decomposed on silica gel during chromatography. Also the PMR spectrum satisfactorily indicated the purity of the compound. The condensation of this amine with p-n-butoxyphenyl isothiocyanate was studied

When the two substrates were refluxed in acetone, a complex mixture of products was seen on TLC. On refluxing in benzene for 4-5 h gave a mixture which could not be identified. From the above two reactions it could be seen that the decomposition of the amine was faster than the formation of thiourea in refluxing conditions. Another reaction was tried in a solvent like tetrahydrofuran, but it resulted in undesired side products. Finally, one equivalent each of the amine and the isothiocyanate were stirred in THF at room temperature to get the desired thiourea in fair yields.

The thiocarbanilides were characterized on the basis of complementary data. IR showed the $C \equiv C$ stretching in the region $2250 - 2150 \text{ cm}^{-1}$; the ester carbonyl at $1710 - 1720 \text{ cm}^{-1}$ and $NH - C = S$ at $1500 - 1470 \text{ cm}^{-1}$ & $1200 - 1050 \text{ cm}^{-1}$ for thiourea. The PMR spectrum also showed characteristic peaks of the methyl ester (3.8δ) and the methylene protons of $Ar-OCH_2$ ($4.5 - 4.7 \delta$) along with aromatic protons and those of the thiourea which exchanged with D_2O ($7 - 9 \delta$). In the mass spectra, even though the molecular ion peak was very weak, a significant fragment of $R-NCS$ was observed, thus giving evidence for $R-N=C=S$

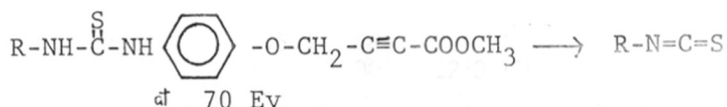

All the compounds obtained gave satisfactory microanalysis for C, H and N. The compounds along with their melting points, yields and some salient features in IR and PMR are listed in Table II.

The following 1-[p-substituted phenyl]-3-[p-(1'-carbomethoxy-prop-1'-yne-3'-oxy)phenyl]-2-thioureas were prepared:

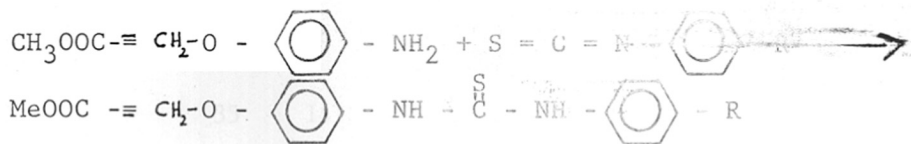

R = OBu, OMe, Cl, 3,4(Cl₂), CH₃, H, SO₂Me, NO₂, NHCOCH₃, NHSO₂CH₃, CN, CONHCH₃, CH₂OCH₃, -CH₂CH₃, O-CH₂-C=C-COOCH₃.

TABLE II

Sr.No.	R	Yield %	M.P. °C	I.R. cm ⁻¹	P.M.R. in	Mass fragmentation R-NCS
1.	O-Butyl	40	102	2260,1710, 1250-1180	1-2(m), 3.7(s), 3.85(s), 4.6(gd)	207
2.	O-Methyl	32	90	2250,1710, 1250-1180	3.72(s), 3.76(s), 4.6(gd)	165
3.	-Cl	35	95	2210,1710, 1240-1180	3.7(s), 4.6(gd)	169
4.	3,4(diCl)	50	106	2210,1700, 1230-1170	3.7(s), 4.6(gd)	203
5.	-CH ₃	36	82	2210,1700, 1250-1170	2.2(s), 3.7(s), 4.6(gd)	149
6.	-H	45.5	88-90	2210,1710, 1260-1180	3.76(s), 4.6(gd)	135
7.	-C ₂ H ₅	30	105	2220,1710, 1260-1180	1.2(t), 2.6(q), 3.75(s), 4.6(gd)	163
8.	-CH ₂ O-CH ₃	32	87	2220,1715, 1260-1180	3.4(s), 3.75(s), 4.65(gd)	179

Table contd.....

Table contd..

Sr.No.	R	Yield %	M.P. °C	I.R. cm ⁻¹	P.M.R. in	Mass frag- mentation R-NCS
9.	-CN	42	96	2210,1710, 1250-1200	3.75(s), 4.65(gd)	160
10.	-NO ₂	35	141	2240,1690, 1270-1250	3.75(s), 5.0(s)	180
11.	-NHCOCH ₃	34	110	2210,1710, 1630-1260	2.05(s), 3.7(s), 4.6(gd)	192
12.	-CONHCH ₃	50	120	2120,1710, 1250	2.9(s), 3.7(s), 4.7(gd)	192
13.	-SO ₂ CH ₃	40	110	2220,1710, 1250,1090	2.9(s), 3.6(s), 4.6(gd)	213
14.	-NHSO ₂ CH ₃	48	125	2220,1720, 1260-1210, 1100	2.3(s), 3.75(s), 4.6(gd)	228
15.	O-CH ₂ -C=C- COOMe	47	100	2220,1710, 1260,1180	3.75(s), 4.75(gd)	-

The following figures depict typical PMR & IR spectra of some of the compounds, Figs. X - XII.

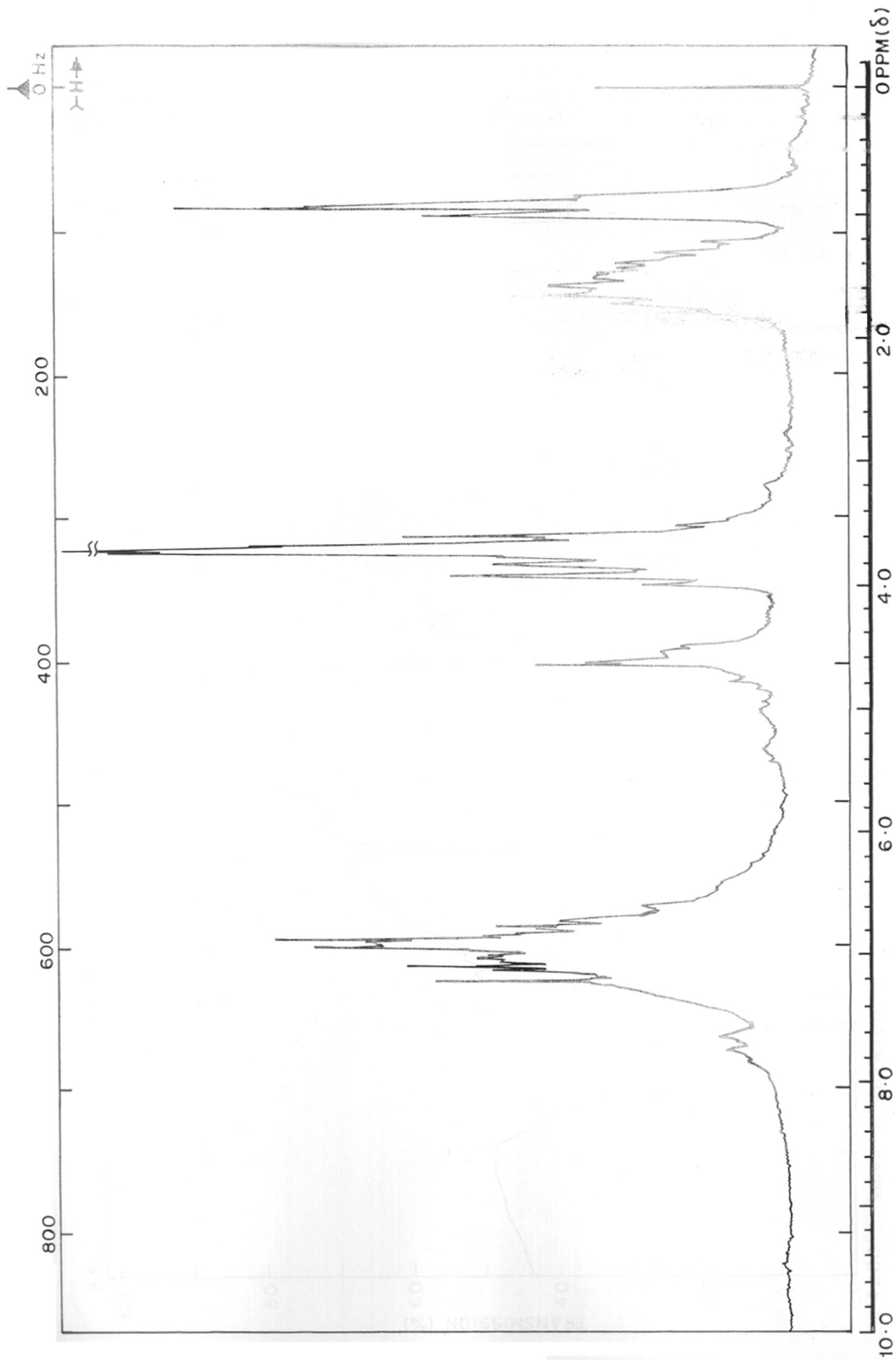

FIG. X (a) PMR SPECTRUM OF COMPOUND 1

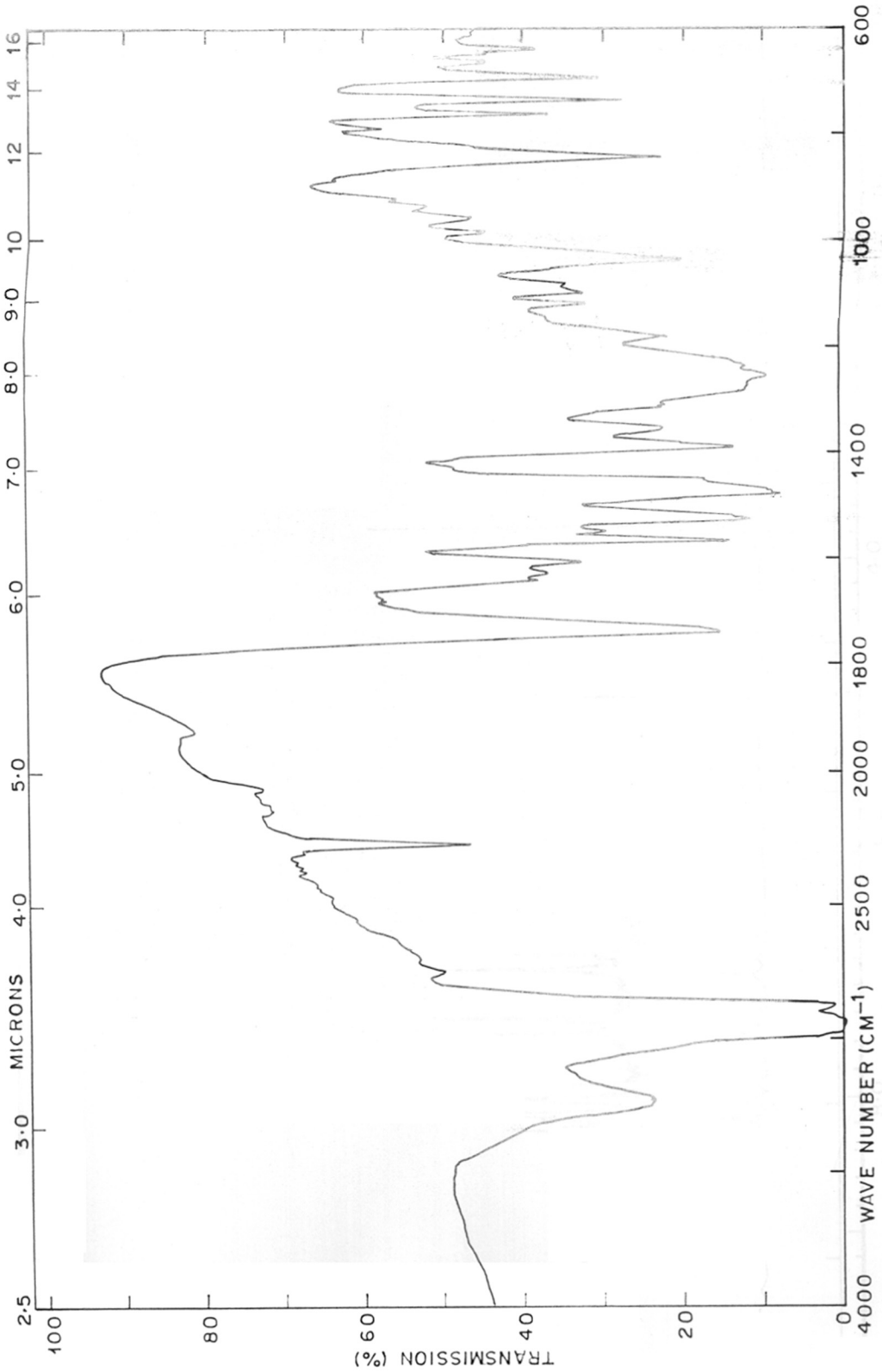

FIG. X (b). IR SPECTRUM OF COMPOUND 1

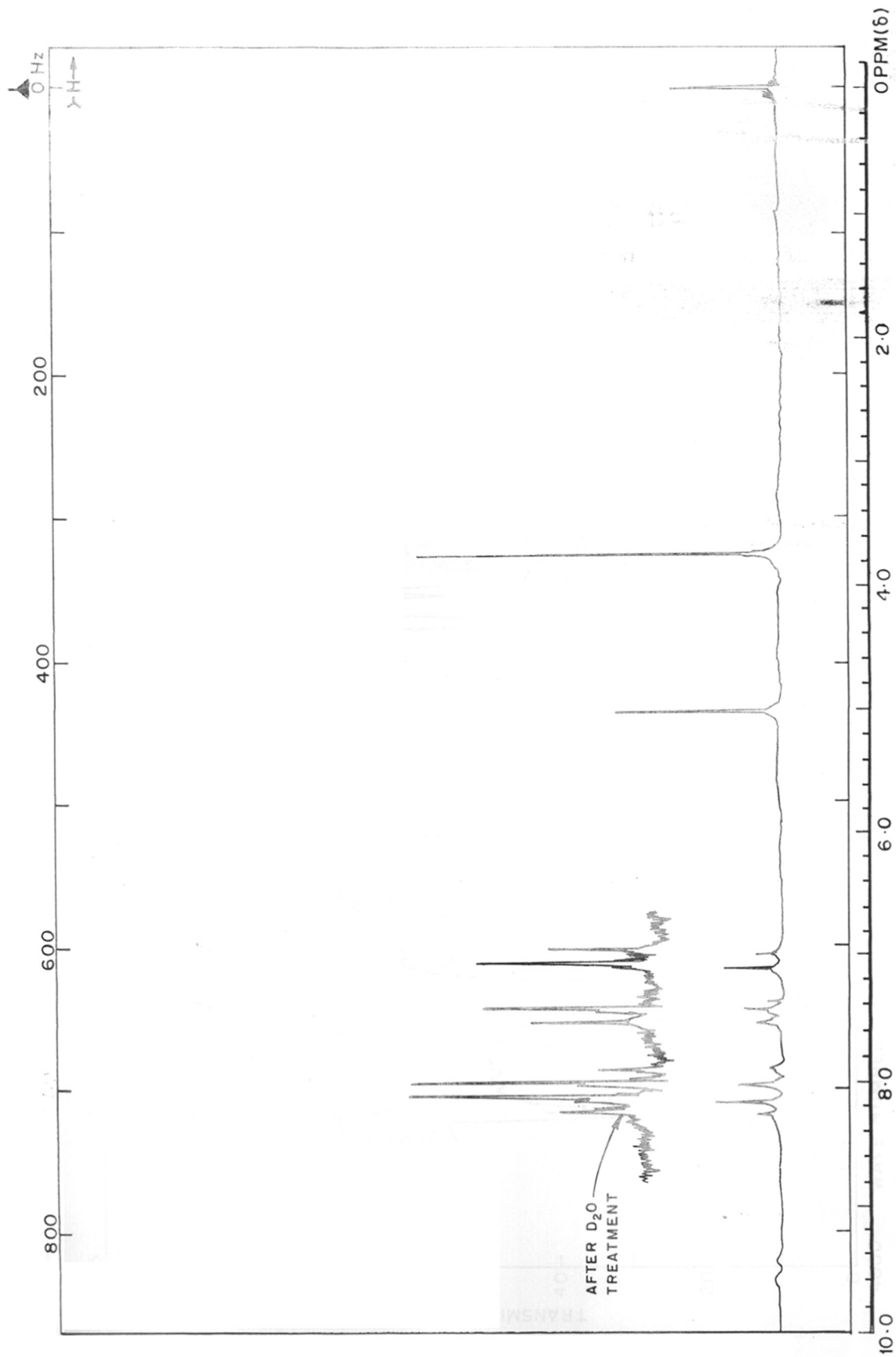
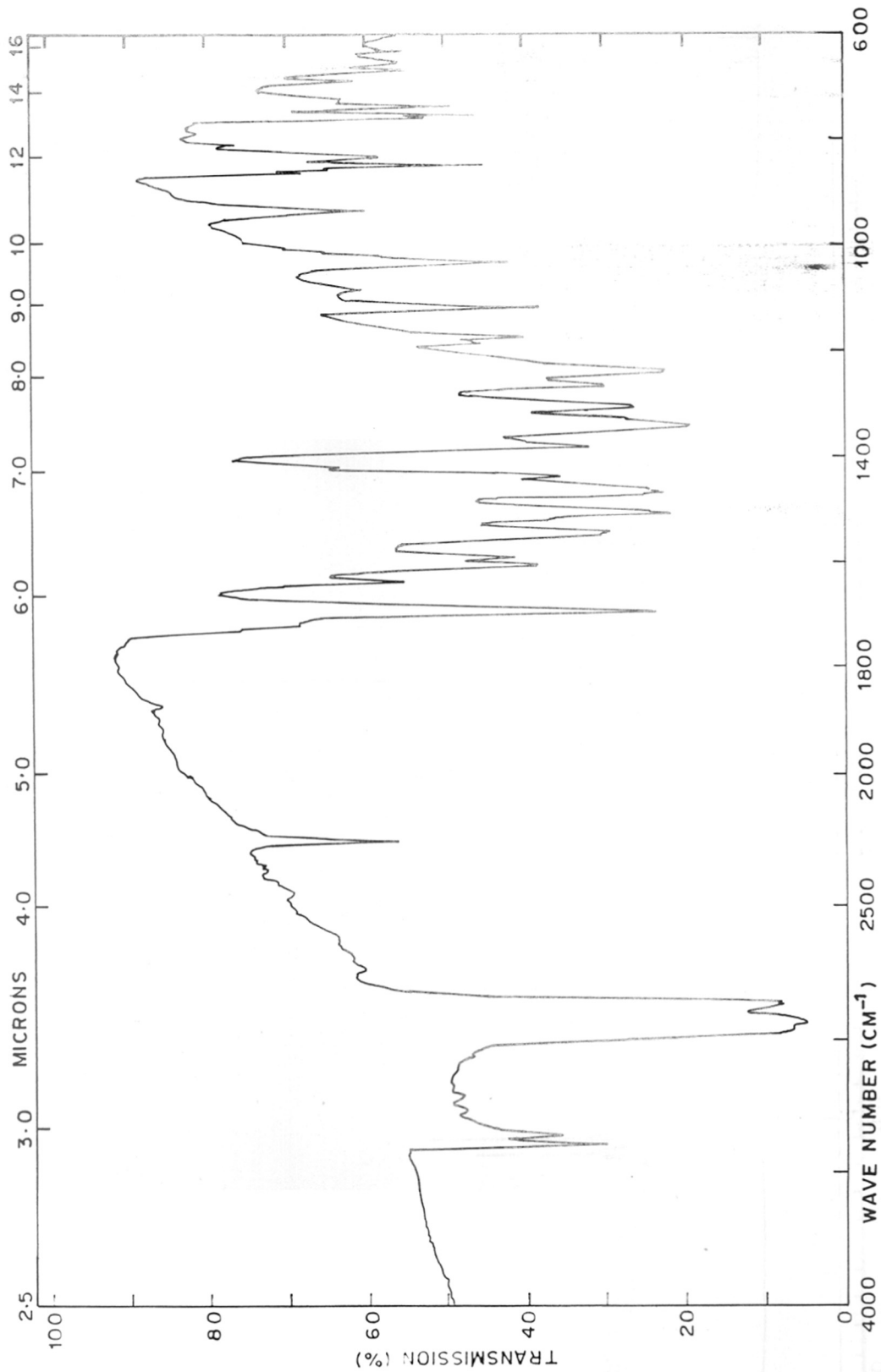

FIG. XI (a). PMR SPECTRUM OF COMPOUND 10

FIG. XI (b). IR SPECTRUM OF COMPOUND 10



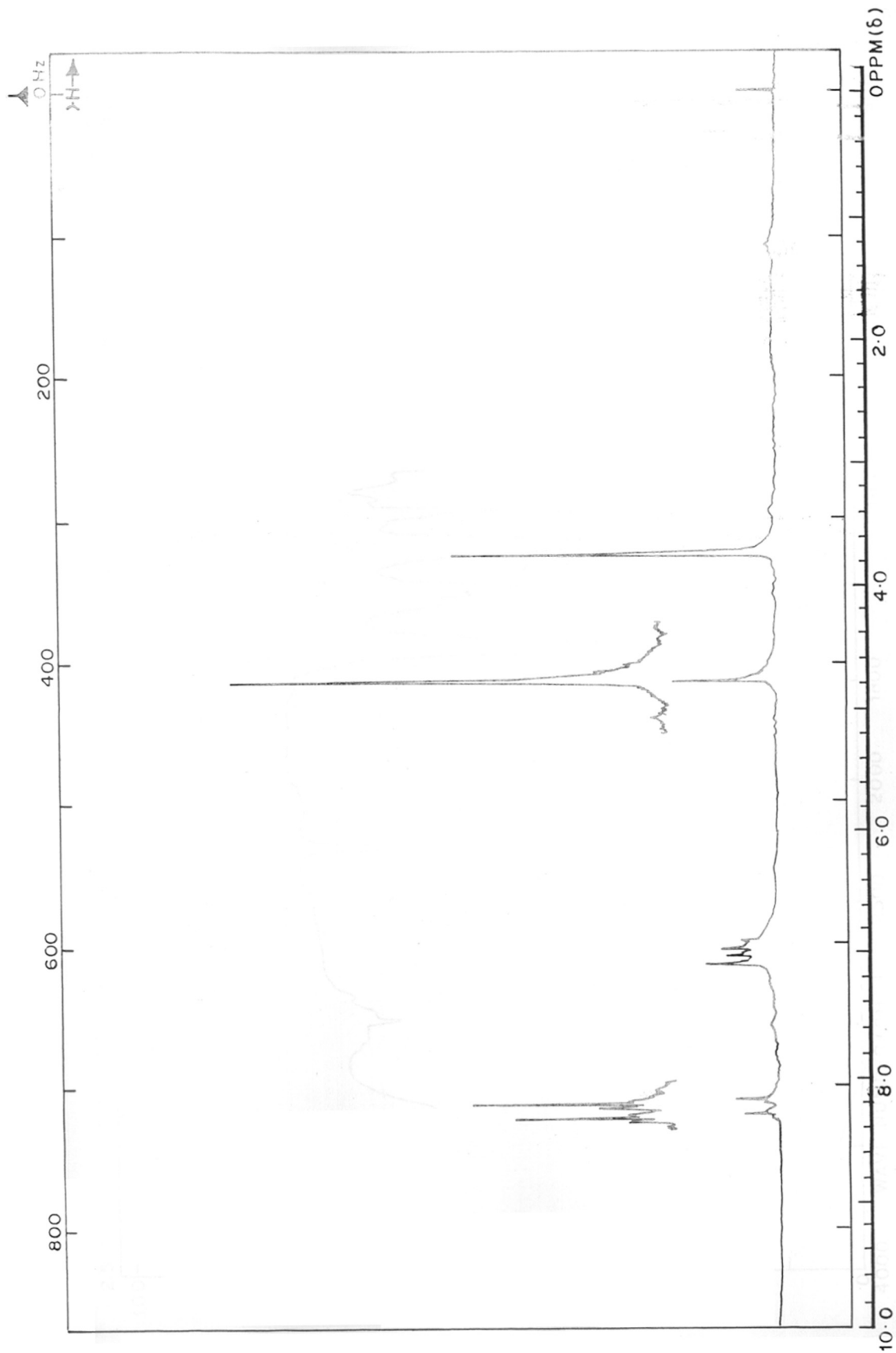
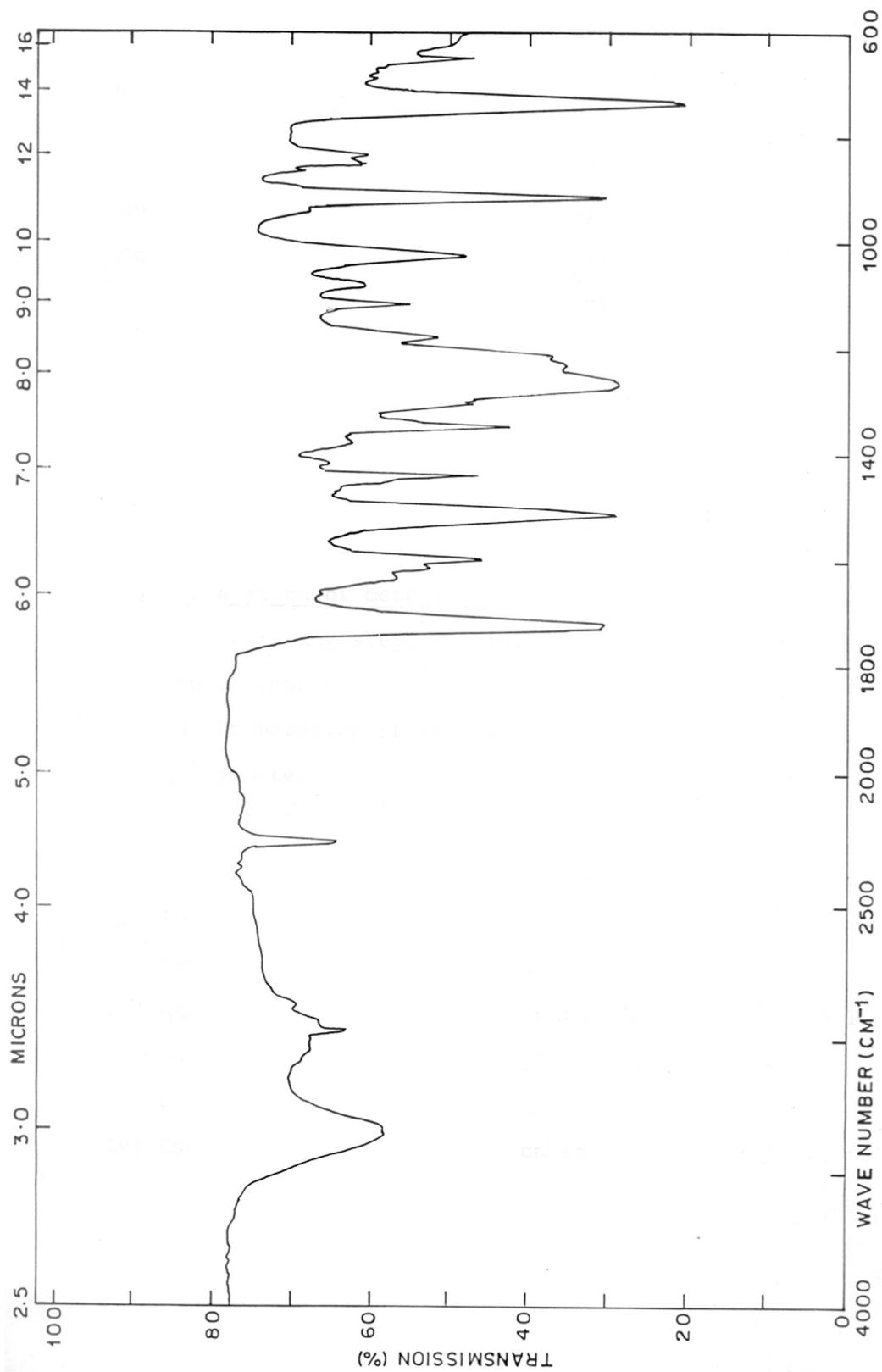

FIG. XII (a). PMR SPECTRUM OF COMPOUND 15

FIG. XII (b). IR SPECTRUM OF COMPOUND 15



3.4-0 EXPERIMENTAL

This part deals with the preparation of 1-[p-substituted phenyl]-3-[p-(1'-carbomethoxy-prop-1'-yne-3'-oxy) phenyl]-2-thioureas. The steps involved are:

- A. Preparation of methyl-4-(p-aminophenyl)-but-2-ynoate.
- B. (1) Preparation of some p substituted anilines
(2) Preparation of p-substituted phenyl isothiocyanates
- C. Condensation of p-substituted phenyl isothiocyanates with methyl-4-(p-aminophenyl)-but-2-ynoate.

(A) Preparation of methyl-4-(p-aminophenyl)-but-2-ynoate

The following steps are involved in the preparation of the above compound.

- (a) Preparation of methyl-4-(p-nitrophenyl)-but-2-ynoate.
 - (b) Reduction of methyl-4-(p-nitrophenyl)-but-2-ynoate.
- (a) Preparation of methyl-4-(p-nitrophenyl)-but-2-ynoate involves the following sequences.
- i) Preparation of 4-chloro-but-2-ynol and 4-bromo-but-2-ynol.
 - ii) Alkylation of p-nitrophenol with 4-chloro-but-2-ynol
 - iii) Oxidation of 4-(p-nitrophenyl)-but-2-ynol to the corresponding acid; and
 - iv) Esterification of 4-(p-nitrophenyl)-but-2-ynoic acid.

i) Preparation of 4-chloro-but-2-ynol and 4-bromo-but-2-ynol

To a solution of 2-butyne-1,4-diol (86 g, 1 mol) in dry benzene (1 litre) and dry pyridine (86.9 g, 1.1 mol) was added purified thionyl chloride (131 g, 1.1 mol) over a period of 6 h. at 10-20°C. The reaction mixture was allowed to stand overnight at room temperature. The mixture was then poured in ice water (250 ml) and the benzene layer was separated. The aqueous layer was extracted with ether and the ether extracts mixed with benzene. The solvents were removed and residues fractionated to give 50 g (50%) of 4-chloro-2-butynol; (b.p. 48° / 0.5 mm) (lit. b.p. 50° / 20 mm) and 10 g of 1,4-dichloro-2-butyne; (b.p. 70° / 20 mm) was also obtained. PMR (CDCl₃): 4.0 (q, 2H CH₂OH), 4.25 (q, 2H, CH₂Cl), 3.5 (s, 1H, OH, D₂O exchangeable).

A solution of sodium bromide (31 g) and 4-chloro-2-butyne ol (26 g, 0.25 mol) in anhydrous methanol (200 ml) was refluxed for 12 h, cooled and filtered. The filtrate was concentrated to 100 ml and then diluted with water. The organic layer was separated, dried over anhydrous sodium sulphate and distilled to give 22.5 g (62%) of 4-bromo-but-2-ynol (b.p. 46°/0.1 mm) which corresponded with the lit. b.p.

ii) Alkylation of p-nitrophenol with 4-chloro-but-2-ynol

A mixture of p-nitrophenol (0.01 mol), 4-chloro-but-2-ynol (0.01 mol), and sodium hydroxide (0.01 mol) in

absolute ethanol (150 ml) was refluxed on a steam bath for 8 h. After completion of the reaction, alcohol was removed under vacuum and water was added to the reaction mixture. This was then extracted with ether (3 x 50 ml) which was washed several times with 10% sodium hydroxide solution (alkaline layer should be colourless with the last wash) and then with water. The etherial extracts were dried over anhydrous sodium sulphate and evaporated to yield a solid which was crystallized from dil. ethanol to afford 4-(p-nitrophenyl)-but-2-ynol; yield (70%); m.p. 130°C; IR (Nujol): 3500, 2210 and 1600 cm^{-1} . PMR (CDCl_3), 4.2 (bs, 4H, $\text{OCH}_2\text{-C}\equiv\text{C-CH}_2\text{OH}$), 6.9 (d, 2H, Aromatic), 8.0 (d, 2H, Aromatic). Mass m/z: 207.

Anal. Calcd. for $\text{C}_{10}\text{H}_9\text{NO}_4$: C, 57.9; H, 4.3; N, 6.7
Found: C, 58.2; H, 4.0; N, 7.0

iii) Oxidation of 4-(p-nitrophenoxy)-but-2-ynol

Jone's reagents (15 ml) was added to a cooled solution of alcohol (1 mmol) in acetone (100 ml) over a period of 15 min. and then the reaction mixture was stirred for 4 h. at room temperature. Acetone was removed under vacuo and the residue was extracted with ethylacetate. The ethylacetate layer was washed several times with water to remove the chromium salts. The organic layer was dried over anhydrous sodium sulphate and evaporated to yield a solid to which sodium bicarbonate solution was added. The aqueous layer

was further extracted with ethylacetate to remove the unreacted alcohol and then acidified with 1:1 HCl to precipitate the required acid. The solid was collected and crystallized from dilute ethanol to afford the acid. Yield 75%; m.p. 150°C; IR (Nujol): 3500(b), 2220, 1730, and 1600 cm^{-1} .

Anal. Calcd. for $\text{C}_{10}\text{H}_7\text{NO}_5$: C, 56.8; H, 3.3; N, 6.6.

Found: C, 57.0; H, 3.0; N, 7.0

(iv) Esterification of 4-(p-nitrophenyloxy)-but-2-ynoic acid

4-(p-Nitrophenyloxy)-but-2-ynoic acid (10 mmol) was taken in dry methanol (50 ml) and acetyl chloride (0.5 ml) was added to it. The reaction mixture was stirred overnight when the solid separated. The solid was collected and washed to afford the methyl ester. Yield 90%; m.p. 132°C; IR (CHCl_3): 2220, 1720 and 1600 cm^{-1} . PMR (CDCl_3): 3.45 (s, 3H, $-\text{COOCH}_3$), 4.5 (s, 2H, $\text{OCH}_2 \text{C}\equiv\text{C}$), 7.3 (d, 2H, Aromatic), 8.1 (d, 2H, Aromatic). Mass m/z 235.

Anal. Calcd. for $\text{C}_{11}\text{H}_9\text{NO}_5$: C, 56.1; H, 3.8; N, 5.9.

Found: C, 56.0; H, 4.0; N, 6.0.

(b) Reduction of methyl-4-(p-nitrophenyloxy)-but-2-ynoate to methyl-4-(p-aminophenyloxy)-but-2-ynoate

Methyl-4-(p-nitrophenyloxy)-but-2-ynoate (10 mmol, 2.34 g) was taken in dichloromethane (20 ml) and acetic acid (20 ml) was added. The solution was cooled to 0°C and zinc dust (1 g) was added in small portions and stirred

for 6 - 8 h. at room temperature. The reaction mixture was filtered through a plug of silica, cooled and neutralized with ammonia solution. The amine was extracted with dichloromethane and washed with several portions of water. The solvent was evaporated to yield a black oil which was purified through silica gel column chromatography (CHCl_3 : MeOH; 9:1) to afford the amine (75%, 1.5 g). IR (CHCl_3): 3400, 2220, 1720 and 1600 cm^{-1} . PMR (CDCl_3): 3.25, (bs, 2H, NH_2 , D_2O exchangeable), 3.7 (s, 3H, COOCH_3), 4.9 (dd, gem, 2H, OCH_2), 6.9 (m, 4H, Aromatic).

(B) (1) Preparation of some p-substituted anilines

This involves the following steps:

- (i) Preparation of some p-substituted nitrobenzene derivatives;
 - (ii) Reduction to the corresponding p-substituted anilines.
- (i) The following p-substituted nitrobenzene derivatives were prepared.

p-n-Butoxy nitrobenzene: It was prepared by the alkylation of p-nitrophenol as described in Sect.2.5 (p.89).

3,4-Dichloronitrobenzene:⁴² Orthodichlorobenzene (ODCB) (12.5 ml) was added to the nitrating mixture of conc. sulphuric acid (20 ml) and conc. nitric acid (17.5 ml). The reaction mixture was refluxed for 2 h. and then poured over ice, when solid separated. It was collected by filtration, washed free of acid and then crystallized from ethanol. Yield 80%; m.p. 42°C.

4-Nitrophenyl 4'-methylsulphonate:⁴³ Oxidation of p-nitrophenylthiomethyl ether by reported procedures using hydrogen peroxide to yield the desired sulphone quantitatively; m.p. 47-48°C.

p-Nitrobenzyl alcohol methyl ether:⁴⁴ Sodium (0.85 g, 37 mmol) was dissolved in methanol (20 ml) and cooled to 0°C. p-Nitrobenzyl bromide (35 mmol, 7.35 g) was added and the mixture was refluxed for 1 h. Water (30 ml) was added to the cooled solution which was extracted with ether. Etherial layer was dried over sodium sulphate and removed under vacuo. The residue was distilled to give pure p-nitrobenzyl alcohol methyl ether (70%, 5.6 g); (b.p. 150°C/18 mm).

N-Methyl -nitrobenzamide:⁴⁵ p-Nitrobenzoyl chloride (0.05 mol) was allowed to react with methylamine (0.055 mol) in water containing 0.075 equivalents of sodium carbonate at 50-60°. The solution was cooled, the solid washed with water and crystallized to give N-methylbenzamide (100%); m.p. 217°C.

4-Nitroacetanilide:⁴⁶ Glacial acetic acid (25 ml) was added to finely powdered dry acetanilide (25 g) and to the reaction mixture was added cold conc. sulphuric acid (50 ml). The mixture was cooled to 0°C and to it was added a nitrating mixture containing (15.5 g, 11 ml) of conc. nitric acid and (12.5 g, 7 ml) of conc. sulphuric acid. It was allowed to stand for 1 h. at room temperature and then poured over

crushed ice. The solid was collected by filtration and crystallized from ethanol to afford p-nitroacetanilide; m.p. 214°C, yield 60%.

ii) Reduction to the corresponding p-substituted anilines

General Method: To a solution of nitro compound (0.1 mol) in ethanol was added Raney-nickel (1 g) and refluxed. To the refluxing solution was added dropwise hydrazine hydrate (20 ml) and the solution was boiled for 3 - 4 h. The catalyst was removed by filtration and the solvent evaporated to afford the amine which was purified (if liquid) by distillation or (if solid) by crystallization.

The following amines were prepared by the above general method.

- a) p-Butoxyaniline
Yield 65%, b.p. 130°/10 mm (lit. b.p. 143°/12 mm)
- b) 3,4-Dichloroaniline
Yield 50%, m.p. 71° (lit. m.p. 70-72.5°)
- c) 4-Aminophenyl methyl sulphonate
Yield 90%, m.p. 135° (lit. m.p. 134-35°)
- d) 4-Amino benzylalcohol methyl ether
Yield 80%, b.p. 165°/40 mm (lit. b.p. 164-67°/40 mm).
- e) 4-Ethylaniline
Yield 75%, b.p. 212° (lit. b.p. 213-14°)
- f) N-Acetyl-1,4-diaminobenzene
Yield 55%, m.p. 165° (lit. m.p. 165°)
- g) 4-Amino-N-methyl benzamide
Yield 60%, m.p. 180° (lit. m.p. 180°)
- h) N-methylsulfonyl-1,4-diaminobenzene
Yield 70%, m.p. 115° (lit. m.p. 116-117.5°)
- i) Methyl-4-(p-aminophenyloxy)-but-2-ynoate.

This was prepared by the procedure described in (A).

(B) (2) Preparation of various p-substituted phenyl isothiocyanate

General Methods:

Method A: The amine (0.1 mol) was dissolved in minimum amount of benzene and treated with carbondisulphide (6.6 ml, 0.1 mol) and triethylamine (14 ml, 0.1 mol) and the solution was cooled to 0°C. After complete precipitation of the triethyl ammonium dithiocarbamate salt, it was collected by filtration and washed with anhydrous ether. The salt was then dissolved in chloroform (75 ml), treated with triethylamine (14 ml) and ethyl chloroformate (10 ml, 0.1 mol) was added dropwise over a period of 15 min. The resulting solution was cooled to 0°C for 10 min. and allowed to warm to room temperature. The chloroform layer was washed with 3M hydrochloric acid, water and finally dried over anhydrous sodium sulphate. Chloroform was evaporated and the aryl isothiocyanates were distilled.

Method B: The amine (0.01 mol) was taken in 10% hydrochloric acid and the solution was filtered. To the filtrate containing the amine hydrochloride was added thiocarbonyl chloride (thiophosgene) (0.01 mol). It was kept for two days in a stoppered conical flask, shaken from time to time. The solid separated was collected and crystallized to afford the isothiocyanates in good yield. (In case of liquid it was extracted with ether to give the desired isothiocyanate which was purified by distillation).

The following p-n-substituted phenyl isothiocyanates were prepared by the above general methods.

1. p-n-Butoxyphenyl isothiocyanate: (Method A)
Yield 52%; b.p. 191°/16 mm (lit. b.p. 190°/16 mm)
IR (CHCl₃): 2100 cm⁻¹; Mass m/z: 207
2. p-n-Methoxyphenyl isothiocyanate: (Method A)
Yield 60%; b.p. 140°/10 mm (lit. b.p. 280-81°)
IR (CHCl₃): 2100 cm⁻¹; Mass m/z: 165
3. p-Chlorophenyl isothiocyanate: (Method A)
Yield 60%; m.p. 44° (lit. m.p. 44-45°)
IR (CHCl₃): 2110 cm⁻¹; Mass m/z: 169
4. 3,4-Dichlorophenyl isothiocyanate: (Method A)
Yield 65%; b.p. 134°/12 mm (lit. b.p. 134.8 - 135.9/12 mm)
IR (CHCl₃): 2110 cm⁻¹; Mass m/z: 203
5. p-Methylphenyl isothiocyanate: (Method A)
Yield 65%; b.p. 235° (lit. b.p. 234°)
IR (CHCl₃): 2105 cm⁻¹; Mass m/z: 149
6. Phenyl isothiocyanate: (Method A)
Yield 70%; b.p. 118°/35 mm (lit. b.p. 118°/35 mm)
IR (CHCl₃): 2100 cm⁻¹; Mass m/z: 135
7. p-Ethylphenyl isothiocyanate: (Method A)
Yield 48%; b.p. 110°/4 mm (lit. b.p. 113°/4-5 mm)
IR (CHCl₃): 2100 cm⁻¹; Mass m/z: 163
8. p-Methoxymethylenephanyl isothiocyanate: (Method A)
Yield 80%; purified by column chromatography

- (Pet. ether : Ethyl acetate, 9:1) [oil].
IR (CHCl₃): 2100 cm⁻¹; Mass m/z: 179
9. p-Cyanophenyl isothiocyanate: (Method B)
Yield 75%; m.p. 119° (lit. m.p. 119-20°)
IR (CHCl₃): 2100 cm⁻¹, 2210 cm⁻¹; Mass m/z: 160
10. p-Nitrophenyl isothiocyanate: (Method B)
Yield 80%; m.p. 113° (lit. m.p. 112-113°)
11. p-n-Acetamidophenyl isothiocyanate: (Method B)
Yield 60%; m.p. 191° (lit. m.p. 192-93°)
IR (CHCl₃): 3300, 2100, 1670 cm⁻¹; Mass m/z: 192
12. p-n-Methyl benzamido isothiocyanate: (Method B)
Yield 50%; m.p. 180°
IR (Nujol): 3350, 2100, 1640 cm⁻¹; Mass m/z: 192
13. p-Methyl sulfamoylphenyl isothiocyanate: (Method B)
Yield 90%; m.p. 153°;
IR (Nujol): 3290, 2120, 1150 cm⁻¹; Mass m/z: 228
14. p-Methyl sulfonylphenyl isothiocyanate: (Method B)
Yield 62%; m.p. 136° (lit. m.p. 136-37°)
IR (Nujol): 2100, 1150 cm⁻¹; Mass m/z: 213.
15. p-(1-Carbomethoxy-prop-1-yne-3-oxy)phenyl isothiocyanate
Methyl-4-(p-aminophenyl)-but-2-ynoate (10 mmol) was stirred with triethylamine (10 mmol) in dichloromethane (25 ml) and cooled. Thiocarbonyl chloride (10 mmol) was added and the reaction mixture stirred for 2 h. After completion of

the reaction, the solvent was evaporated in vacuum and the residue was purified by column chromatography over silica gel (benzene : acetone, 9:1) to give a brown solid; yield 66%; m.p. 132°; IR (CHCl₃): 2220, 2100, 1710, 1600 and 1350 cm⁻¹(b); PMR (CDCl₃): 3.9 (s, 3H, COOCH₃), 4.9 (d(gem), 2H, -OCH₂-C≡C), 7.1 and 8.2 (dd, 4H, Aromatic); Mass m/z: 241.

Anal. Calcd. for C₁₂H₉NO₃S: C, 58.2; H, 3.6; N, 5.6

Found: C, 58.0; H, 3.0; N, 6.

(C) Condensation of p-substituted phenyl isothiocyanates with methyl-4-(p-aminophenyloxy)-but-2-ynoate

General Procedure: Methyl-4-(p-aminophenyloxy)-but-2-ynoate (5 mmol) and p-substituted phenyl isothiocyanate (5 mmol) were stirred at room temperature for 4-5 h. in tetrahydrofuran (25 ml). After completion of the reaction, THF is removed under vacuum, the reaction mixture was taken in ethylacetate and washed with 10% dilute hydrochloric acid and water. The ethylacetate layer was dried over anhydrous sodium sulphate. After removal of the solvent, the residue was purified by column chromatography or crystallization to afford the desired 1-[p-substituted phenyl]-3-[p-(1'-carbo-methoxy-prop-1'-yne-3'-oxy)phenyl]-2-thioureas.

The following thioureas were prepared using the above general method.

1. 1-[p-n-butoxyphenyl]-3-[p(1'-carbomethoxyprop-1'-yne-3'-oxy)phenyl]-2-thiourea

Yield 40%

M.P. 102° (Crystallized from benzene : pet. ether)

IR (Nujol): 3210, 2260, 1730, 1620, 1480 and 1280-1220 cm^{-1} (b).

PMR (CDCl_3): 0.9 (t, 3H, $\text{CH}_2\text{-CH}_3$), 1.1 - 2 (m, 4H, $\text{O-CH}_2\text{-CH}_2\text{-CH}_2\text{-CH}_3$), 3.7 (s, 3H, $-\text{COOCH}_3$), 3.85 (t, 2H, $-\text{OCH}_2\text{CH}_3$), 4.6 [d(gem), 2H, $\text{OCH}_2\text{-C}\equiv\text{C}$], 6.3-7.5 (m, 8H, Aromatic), 7.7 and 7.8 (2s, 2H, NH-C-NH , D_2O exchangeable).

Anal. Calcd. for $\text{C}_{22}\text{H}_{24}\text{N}_2\text{O}_4\text{S}$: C, 63; H, 5.9; N, 6.79

Found C, 62.7; H, 5.7; N, 6.8

Mass: M^+ 412 (very weak).

2. 1-[p-n-Methoxyphenyl]-3-[p-(1'-carbomethoxyprop-1'-yne-3'-oxy)phenyl]-2-thiourea

Yield 32%

M.P. 90°C (benzene : pet. ether)

IR (CHCl_3): 3400, 3350, 2250, 1710, 1610, 1500, and 1250 - 1180 cm^{-1} (b).

PMR (CDCl_3): 3.72 (s, 3H, COOCH_3), 3.76 (s, 3H, ArOCH_3), 4.6 (d, (gem), 2H, $\text{OCH}_2\text{-C}\equiv\text{C}$ -), 6.4-7.6 (m, 10H, Aromatic, NH-C-NH , D_2O exchangeable)).

Anal. Calcd. for $\text{C}_{19}\text{H}_{18}\text{N}_2\text{O}_4\text{S}$: C, 61.6; H, 4.8; N, 7.5

Found: C, 62; H, 5.4; N, 7.0

Mass: m/z 165 (NCS).

3. 1-[p-n-Chlorophenyl]-3-[p-(1'-carbomethoxyprop-1'-yne-3'-oxy)phenyl]-2-thiourea

Yield 35%

M.P. 95° (Column chromatographed using silica gel, benzene as solvent).

IR (CHCl₃): 3400-330(b); 2210, 1710, 1600, 1490-1540(b);
and 1280-1240 cm⁻¹(b).

PMR (CDCl₃): 3.7 (s, 3H, COOCH₃), 4.6 [d(gem), 2H,
OCH₂, C≡C], 6.8-7.3 (m, 8H, Aromatic).

Anal. Calcd. for C₁₈H₁₅N₂O₃S Cl : C, 57.6; H, 4.0; N, 7.4
Found: C, 58.2; H, 4.6; N, 7.0.

Mass: m/e 169 (RNCS)

4. 1-[3'',4''-Dichlorophenyl]-3-[p-(1'-carbomethoxy prop-1'-yne-3'-oxy)phenyl]-2-thiourea

Yield 50%

M.P. 106° (benzene : pet. ether)

IR (CHCl₃): 3300, 2210, 1700, 1620, 1450, and
1230 - 1170 cm⁻¹.

PMR (CDCl₃): 3.7 (s, 3H, COOCH₃), 4.6 [d(gem), 2H,
OCH₂, C≡C], 6.4-7.6 (m, 7H, Aromatic), 7.9 (d, 2H,
NH - C-NH, D₂O exchangeable).

Anal. Calcd. for C₁₈H₁₄N₂O₃Cl₂S: C, 52.9; H, 3.4; N, 6.8.
Found: C, 53.4; H, 4.0; N, 7.

Mass: m/e 203 (R-NCS).

5. 1-[p-Methyl phenyl]-3-[p-(1'-carbomethoxy prop-1'-yne-3'-oxy)phenyl]-2-thiourea

Yield 36%

M.P. 82°C (benzene : pet. ether)

IR (CHCl₃): 3300, 3210, 2210, 1700, 1610, 1590, 1490 and
1250 - 1170 cm⁻¹.

PMR (CDCl₃): 2.2 (s, 3H, CH₃), 3.7 (s, 3H, COOCH₃),
4.6 [d(gem), 2H, OCH₂ C≡C], 6.5-7.5 (m, 10H, Aromatic).

Anal. Calcd. for $C_{19}H_{18}N_2O_3S$: C, 65; H, 4.2; N, 7.97

Found: C, 65.7; H, 4.5; N, 8.6.

Mass: m/e 149 (R-NCS)

6. 1-[Phenyl]-3-[p-(1'-carbomethoxy prop-1'-yne-3'-oxy)phenyl]-2-thiourea

Yield 45.5%

M.P. 88 - 90° (benzene : pet. ether)

IR (CHCl₃): 3300, 2210, 1710, 1630, 1590, 1460 and 1260 - 1180 cm⁻¹(b).

PMR (CDCl₃): 3.76 (s, 3H, COOCH₃), 4.6 [d, (gem), 2H, OCH₂-C≡C], 6.6-7.5 (m, 9H, Aromatic).

Anal. Calcd. for $C_{18}H_{16}N_2O_3S$: C, 63.5; H, 4.7; N, 8.2

Found: C, 64.4; H, 5.3; N, 8.5

Mass: m/e 135 (R-NCS).

7. 1-[p-Ethyl phenyl]-3-[p-(1'-carbomethoxy prop-1'-yne-3'-oxy)phenyl]-2-thiourea

Yield 30%

M.P. 105°C (benzene : pet. ether).

I.R (CHCl₃): 3350, 2220, 1710, 1635, 1600, 1440 and 1270 - 1190 cm⁻¹(b).

PMR (CDCl₃): 1.2 (t, 3H, CH₂CH₃), 2.6 (q, 2H, CH₂CH₃), 3.75 (s, 3H, COOCH₃), 5.6 [d(gem), 2H, OCH₂-C≡C], 6.9 - 8.0 (m, 8H, Aromatic), 8.2 (d, 2H, NH-C-NH-, D₂O exchangeable).

Anal. Calcd. for $C_{20}H_{20}N_2O_3S$: C, 65.2; H, 5.4; N, 7.6

Found: C, 64.8; N, 5.9; N, 7.0

Mass: m/e 163 (R-NCS).

8. 1-[p-Methoxymethylenephenyl]-3-[p-(1'-carbomethoxy prop-1'-yne-3'-oxy)phenyl]-2-thiourea

Yield 32%

M.P. 87° (Purified by column chromatography using
pet. ether : ethyl acetate 9:1)

IR (CHCl₃): 3350, 2220, 1715, 1640, 1600, 1510, 1450
and 1260 - 1180 cm⁻¹(b).

PMR (CDCl₃): (s, 3H, CH₂OCH₃), 3.75 (s, 3H, COOCH₃),
4.5 (s, 2H, Ph-CH₂ OCH₃), 4.65 [d(gem), 2H, OCH₂-C≡C],
6.5 - 7.5 (m, 8H, Aromatic)

Anal. Calcd. for C₂₀H₂₀N₂O₄S: C, 62.5; H, 5.2; N, 7.3

Found: C, 62.4; H, 5.4; N, 7.0

Mass: m/e 179 (R-NCS).

9. 1-[p-Cyanophenyl]-3-[p-(1'carbomethoxy prop-1'-yne-3'-oxy) phenyl]-2-thiourea

Yield 42%

M.P. 96° (Purified by column chromatography;
benzene : ethyl acetate, 9:1).

IR (CHCl₃): 3400-3300 (b); 2220, 2210, 1710, 1630,
1590, 1440 and 1250 - 1200 cm⁻¹(b).

PMR (CDCl₃): 3.75 (s, 3H, COOCH₃), 4.65 (d, 2H, OCH₂
C≡C), 6.7 - 7.7 (m, 8H, Aromatic), 8.2 (d, 2H,
NH-C-NH, ^HD₂O exchangeable).

Anal. Calcd. for C₁₉H₁₅N₂O₃S: C, 62.4; H, 4.1; N, 11.5

Found: C, 62; H, 4.5; N, 12.0

Mass m/e: 160 (R-NCS).

10. 1-[p-Nitrophenyl]-3-[p-(1'-carbomethoxy prop-1'yne-3'-oxy)phenyl]-2-thiourea

Yield 35%

M.P. 141°C (Column chromatography; benzene)

IR (Nujol): 3390, 3340, 2220, 1690, 1630, 1600, 1470, 1450, 1270 and 1250 cm^{-1}

PMR (CDCl_3): 3.7 (s, 3H, COOCH_3), 5.0 (s, 2H, $\text{OCH}_2\text{C}\equiv\text{C}$), 7.0 and 7.4 (2d, 4H, Aromatic), 8.0 (q, 4H, Aromatic), 9.5 (d, 2H, $\text{NH}-\overset{\text{S}}{\underset{\text{H}}{\text{C}}}-\text{NH}$, D_2O exchangeable).

Anal. Calcd. for $\text{C}_{18}\text{H}_{15}\text{N}_3\text{O}_5\text{S}$: C, 56.1; H, 3.9; N, 10.9.

Found: C, 55.9; H, 4.46; N, 11.0.

Mass m/e: 180 (R-NCS).

11. 1-[p-N-Acetamidophenyl]-3-[p-(1'-carbomethoxy prop-1'-yne-3'-oxy)phenyl]-2-thiourea

Yield 34%

M.P. 110°C (Column chromatography; pet.ether : acetone)

IR (CHCl_3): 3350, 2210, 1710, 1630, 1600, 1500, 1440, 1260 and 1210 cm^{-1}

PMR (CDCl_3): 2.05 (s, 3H, NHCOCH_3), 3.7 (s, 3H, COOCH_3), 4.6 [d, (gem), 2H, $\text{OCH}_2-\text{C}\equiv\text{C}$], 6.3 - 7.5 (m, 8H, Aromatic), 8 (m, 2H, $\text{NH}-\overset{\text{S}}{\underset{\text{H}}{\text{C}}}-\text{NH}$, D_2O , exchangeable).

Anal. Calcd. for $\text{C}_{20}\text{H}_{19}\text{N}_3\text{O}_4\text{S}$: C, 60.4; H, 4.7; N, 10.7

Found: C, 61; H, 4.5; N, 10.

Mass: m/e 192 (R-NCS).

12. 1-[p-n-Methyl benzamido]-3-[p-(1'-carbomethoxy prop-1'-yne-3'-oxy)phenyl]-2-thiourea

Yield 50%

M.P. 120°C (Column chromatography; chloroform : methanol, 9:1).

IR (CHCl₃): 3300, 2120, 1710, 1650, 1600, 1540, 1440, and 1250 cm⁻¹(b).

PMR (CDCl₃): 2.9 (d, 3H, CONHCH₃), 3.7 (s, 3H, COOCH₃), 4.7 (d, 2H, OCH₂-C≡C), 7.0 - 8.0 (m, 8H, Aromatic).

Anal. Calcd. for C₂₀H₁₉N₃O₄S: C, 60.4; H, 4.78; N, 10.5

Found: C, 61; H, 5.3; N, 11.

Mass: m/e 192 (R-NCS).

13. 1-[p-Methylsulfonyl phenyl]-3-[p-(1'-carbomethoxy prop-1'-yne-3'-oxy)phenyl]-2-thiourea

Yield 40%

M.P. 110°C (Column chromatography; benzene:ethyl acetate 9:1)

IR (CHCl₃): 3300, 2220, 1710, 1640, 1590, 1440, 1250, and 1090 cm⁻¹

PMR (CDCl₃): 2.9 (s, 3H, SO₂CH₃), 3.6 (s, 3H, COOCH₃), 4.6 [d,(gem), 2H, OCH₂-C≡C), 6.6-7.9 (m, 8H, Aromatic).

Anal. Calcd. for C₁₉H₁₈N₂S₂O₅: C, 54.5; H, 4.3; N, 6.7

Found: C, 55.1; H, 4.75; N, 6.0.

Mass: m/e 213

14. 1-[p-Methylsulfamoyl phenyl]-3-[p-(1'-carbomethoxy prop-1'-yne-3'-oxy)phenyl]-2-thiourea
 Yield 48%
 M.P. 125°C (Benzene : pet. ether)
 IR (CHCl₃): 3350, 3290, 2220, 1720, 1610, 1600, 1440, 1260 - 1210 cm⁻¹(b) and 1100 cm⁻¹.
 PMR (CDCl₃): 2.3 (s, 3H, NHSO₂CH₃), 3.75 (s, 3H, COOCH₃), 4.6 [bs, (gem), 2H, OCH₂-C≡C], 6.4-7.3 (m, 8H, Aromatic), 8 (bs, 2H, NH-C^S-NH, D₂O exchangeable).
 Anal. Calcd. for C₁₉H₁₉N₃O₅S₂: C, 52.6; H, 4.3; N, 9.7
 Found: C, 52.3; H, 4.1; N, 9.0
 Mass: m/e: 228 (R-NCS).
15. 1,3-bis-[p-(1'-Carbomethoxy-prop-1'-yne-3'-oxy)phenyl 2-thiourea
 Yield 47%
 M.P. 100°C (Crystallized from benzene : pet. ether)
 IR (CHCl₃): 3350, 2220, 1710, 1640, 1600, 1510, 1435, 1260(b), and 1180 cm⁻¹.
 PMR (CDCl₃): 3.75 (s, 6H, COOCH₃), 4.75 [bs(gem), 4H, OCH₂-C≡C], 7.0 (m, 8H, Aromatic), 8.2 (d, 2H, NH-C^S-NH, D₂O exchangeable).
 Anal. Calcd. for C₂₃H₂₀N₂O₆S: C, 61; H, 4.4; N, 6.1
 Found: C, 60.8; H, 4.8; N, 6.5.

3.6-0 REFERENCES

1. B.M. Adger and R.G. Young,
Tetrahedron Lett., 25, 45, 5219-29 (1984).
2. R.D. Dabholkar,
Ph.D. Thesis, University of Bombay (1978).
3. Hodgson H.H. et al.
J. Chem. Soc., 2917 (1929).
4. L.M. Yagupolski and M.S. Marenets,
Zhur Obscheikhim, 27, 1395 (1957).
5. Dictionary of Organic Compounds, Vol.I, p.154,
5th Edn., Chapman & Hall.
6. Henry Wenker,
J. Am. Chem. Soc., 60, 1081 (1938).
7. Willgererodt et al.
Justus Liebigs Ann Chem., 327, 286 (1903)
8. Maire Jean C. and Benett Johns,
J. Chem. Soc. B, 2, 309 (1971).
9. Arnold Weissberger,
US Pat. 2,66,37,32. CA 48: 5007e
10. Jiro Jsuji, Mitsuo Takahashi and Takashi Takahasi,
Tetrahedron Lett., 21(9), 849-50 (1980).
11. R.N. Warrener and E.N. Cain,
Aust. J. Chem., 24, 785 (1971).
12. H.B. Henbest, E.R.H. Jones and M.S. Walls,
J. Chem. Soc., 3646 (1950).
13. R. Machinek, W. Luttke,
Synthesis, 255 (1975).
14. Janine Tendil, Micheal Verny and Roger Vessiere,
Bull. Soc. Chem. Fr., 10, 4027 (1972)
15. *Vogel Text Book of Org Chem. pg. 347*
~~Bull. Chem. Soc. Japan, 59, 11 (1986).~~
16. Jean Colonge and George Poilane,
Bull. Soc. Chim. Fr., 953 (1955).

17. William J. Bailey and Edward Fujiwara,
J. Am. Chem. Soc., 77, 165 (1955).
18. N. Bilow, A.L. Landis and L.J. Miller,
US Pat. 3,845,018 (1974).
19. R.F. Kovar and F.E. Arnold,
US Pat. 3,975,444 (1976).
20. A. Buraway and Critchley,
Tetrahedron, 340 (1959).
21. G.F. Hennion and S.O. Barrett,
J. Am. Chem. Soc., 79, 2146 (1957).
22. A Onopchenko, E.T. Sabourin and C.M. Schwitz,
J. Org. Chem., 44, 3671 (1979)
23. R.F. Kovar and F.E. Arnold,
US Pat. 3,975,444 (1976).
24. F. Bellamy et al.
Tetrahedron Lett., Vol. 25 No.8, 339 (1983).
25. T. AahkoBa, J.H. BokuBu,
Zn. Obschei Khim., 21, 787 (1951).
26. Herbert Hodgson and John Whitehurst
J. Chem. Soc., 202 (1945).
27. W.E. Kuhn,
Org. Synth. Coll. Vol. 2, 448 (1943).
28. A. Buraway and Critchley,
Tetrahedron, 340 (1959).
29. Joe E. Hodgkins and W. Oreston Reeres,
J. Org. Chem., 29, 3098 (1964).
30. A. Rathke,
Chem. Ber., 5, 799 (1872).
31. W. Siefken,
Ann. Chem., 75, 562 (1947).
32. Buu Hoi Ng Ph, Xuong Ng D. and Nam Ng. H.,
J. Chem. Soc., 1573-81 (1955).
33. G.M. Dyson and H.J. George,
J. Chem. Soc., 1702 (1924).
G.M. Dyson
34. Org. Synth. Coll. Vol. 1, p.165.

35. David Beaver, Daniel Roman and Paul Stoffel,
J. Am. Chem. Soc., 79, 1236-45 (1957).
36. J.B. Johnson and E.R. Hemingway,
J. Am. Chem. Soc., 38, 1866 (1916).
37. ~~F.~~ F. Dains
Org. Synth. Coll. Vol. 1, p.447.
38. Lowell Weller, Charles Bull and Harold Sell,
J. Am. Chem. Soc., 74, 1104 (1952).
39. A. Sagigh, Henri Ulrich and John Potts,
J. Org. Chem., 30(7), 2465-66 (1965).
40. Eugene Lieber and J. Ramachandran,
Can. J. Chem., 37, 101-109 (1959).
41. L. Doub, L.M. Richardson et al.
J. Am. Chem. Soc., 80, 2205-17 (1958).
42. E. McMaster,
J. Am. Chem. Soc., 50, 3038 (1928).
43. Dict. of org. Chem. Vol 4 pg 4227
44. Ernst K. Leucker,
Ber. 55B, 1634-54 (1922).
45. Henry Wenker,
J. Am. Chem. Soc., 60, 1081 (1938).
46. Practical Organic Chemistry, IVth Ed., 76, p.686.
47. Micheal V her.
C. A. 67: 43495

SYNTHESIS OF THIOUREAS WITH 3-DIALKYL AMINO-2-HYDROXY-PROPOXY SIDE CHAIN

4-0.0 INTRODUCTION

The N,N'-diarylthiourea viz. thioambutosine (1a) and thiocarlide (1b) have been used in the treatment of leprosy and tuberculosis, respectively.¹ Their use today is no longer advocated for a number of reasons. Both compounds are poorly and erratically absorbed following oral administration and have poor pharmacokinetic properties; they also have undesirable side effects thought to be associated with the thiourea moiety.²

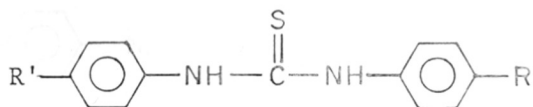

(a) = R = NMe₂ R' = O But

(b) = R = O(CH₂)₂-CHMe₂ = R'

Both molecules incorporate the polar but unionised thiourea moiety and highly lipophilic aryl groups bearing long alkoxy side chains. Their distribution in oil and water systems gives calculated log P values,³ (see Table) which are considerably higher than those of the known antimycobacterial drug (-1 to +1).⁴

The quantitative structure activity analysis⁵ of a series of diarylthioureas showed that one alkoxy group was necessary for activity having a chain length of 9.4 Å. This suggested that it might be possible to design thioureas with

greater activity and more favourable pharmacokinetic properties by modification of the side chain of these molecules.

The log P values of 1(a) and 1(b) (4.31 and 5.82 respectively) have to be reduced in order to fit into the parameters of known antimycobacterial drugs.⁴ This can be achieved by the introduction of 3-dialkylamino-2-hydroxy, propoxy side chain in place of the alkoxy group as illustrated in the table given below.

Calculated log P values

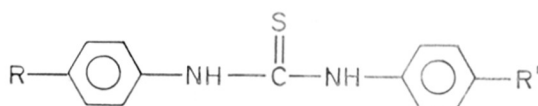



<u>Comp.</u>	<u>R</u>	<u>R¹</u>	<u>log P³</u>
1	O-n-C ₄ H ₉	NMe ₂	4.31
2	O(CH ₂) ₂ CHMe ₂	O(CH ₂) ₂ CHMe ₂	6.56
3	O-n-C ₄ H ₉	O-n-C ₄ H ₉	5.82
4	OCH ₂ CHOHCH ₂ NEt ₂	NMe ₂	1.54
5	-do-	OCH ₂ CHOHCH ₂ NEt ₂	0.28
6	-do-	O-n-C ₄ H ₉	3.05

The chain length of this side chain was found to be 9.4 (calculated by computer graphics) which complied with the required chain length.

In the present chapter attempt is made to replace the alkoxy chain with less lipophilic chain and at the same time reducing the log P values to have compounds having favourable log P values (between 1.0 to 1.5) and ~~to have~~ ~~more~~ or less the same activity as that of the corresponding derivative. All the selected compounds have an 3-dialkylamino-2-hydroxy, propoxy side chain.

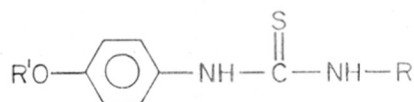
The compounds synthesised have been tabulated as follows:

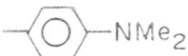
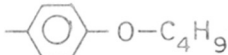
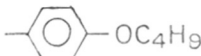
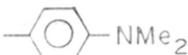
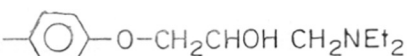

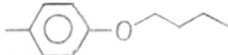
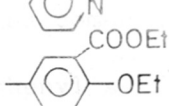
Comp.	R'	R
1	O-n-C ₄ H ₉	
2	O-n-C ₄ H ₉	
3	OCH ₂ CHOHCH ₂ NEt ₂	
4	OCH ₂ CHOHCH ₂ NEt ₂	
5	OCH ₂ CHOHCH ₂ NEt ₂	
6	OCH ₂ CHOHCH ₂ NEt ₂	
7	OCH ₂ CHOHCH ₂ NEt ₂	
8	OCH ₂ CHOHCH ₂ NEt ₂	

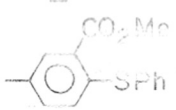
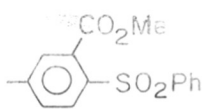
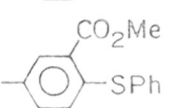
<u>Comp.</u>	<u>R¹</u>	<u>R</u>
9	$\text{OCH}_2\text{CHOHCH}_2\text{NEt}_2$	
10	$\text{OCH}_2\text{CHOHCH}_2\text{NEt}_2$	
11	$\text{O-n-C}_4\text{H}_9$	

This section consists of three parts, viz.

- A) Preparation of various substituted amines,
- B) Preparation of 4-(2'-acetoxy-3'-diethylamino-1'-propoxy) aniline and its corresponding isothiocyanate.
- C) Condensation of the above mentioned isothiocyanate with various substituted amines.

4.1.0 Preparation of various substituted amines

- i) p-n-Butoxyaniline.⁶

p-n-Butoxyaniline was prepared by the method described in Section 2.5, p. 89.

- ii) p-Aminodimethylaniline.⁷

The reduction of commercially available p-nitroso-N,N-dimethylaniline gave the required amino compound (m.p. 42-43°)

- iii) 2-Carbomethoxy-4-amino diphenyl sulfide

This was prepared by esterification of 2-carboxy-4-nitro diphenyl sulfide⁸ followed by reduction with Pd/C

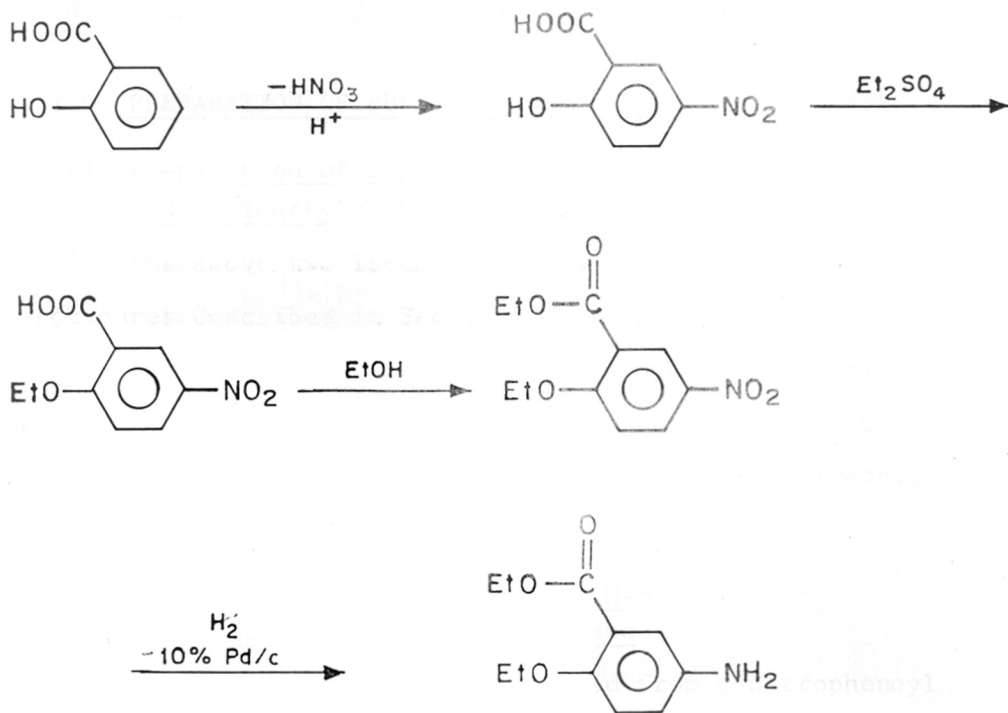
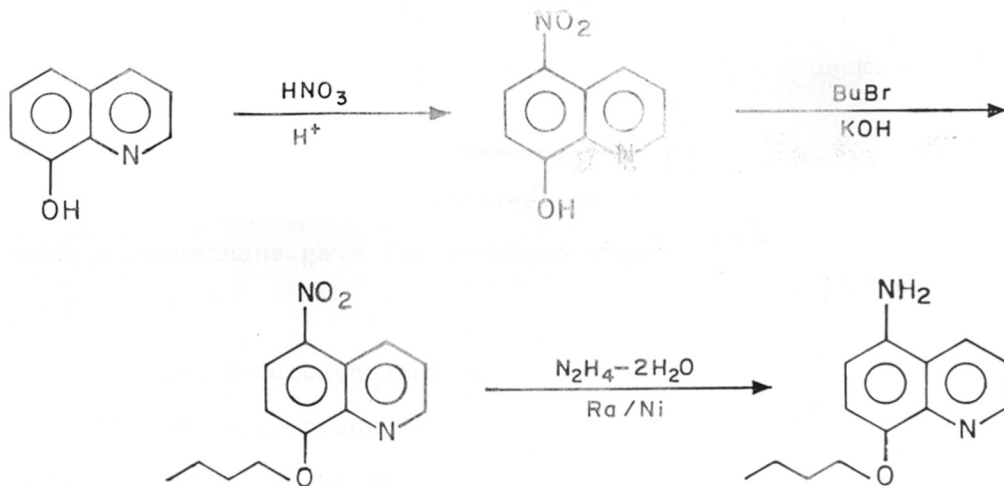

at 40 psi to give the desired amine; m/z M^+ 259 (Scheme VI).

iv) 2-Carbomethoxy-4-amino diphenylsulfone

Esterification of 2-carboxy-4-amino diphenylsulfone⁸ with diazomethane gave the required amino ester; m/z : M^+ 291 (Scheme VI)..

v) 5-Amino-8-butoxyquinoline

The above compound was prepared in three steps from 8-hydroxyquinoline by reported procedure.⁹ (Scheme I).

vi) Ethyl-2-ethoxy-5-aminobenzoate

This was prepared by reduction of ethyl 2-ethoxy-5-nitrobenzoate¹⁰ with Pd/C at 40 psi. The oil was purified by distillation (b.p./12 mm 210°)¹⁰ (Scheme II).

4.2-0 PREPARATION OF SUBSTITUTED PHENYL ISOTHIOCYANATES

4.2-1 Preparation of p-n-butoxyphenyl isothiocyanate and p-N,N-dimethylaminophenyl isothiocyanate

The above two isothiocyanates were prepared by the procedures described in Section 2, using carbondisulfide and triethylamine to form the dithiocarbamate salt which was decomposed by ethyl chloroformate, which on work up, gave p-n-butoxyphenyl isothiocyanate⁴¹ and p-N,N-dimethylaminophenyl isothiocyanate⁴² in good yields.

4.2-2 Synthesis of 4-[2-acetoxy-3-N,N-diethylamino propyloxy]-phenyl isothiocyanate

The above compound was prepared from p-nitrophenoyl by the following steps (Scheme IIIa).

i) Condensation of p-nitrophenol with 2-epichlorohydrin to give p-nitrophenoxy-2,3-epoxypropane.

In a general procedure¹¹ sodium hydroxide (1 mol) and p-nitrophenol were heated to 90-100°C in water and to it was added epichlorohydrin and the reaction mixture was stirred overnight. The solvent was removed and worked up with sodium hydroxide solution and ether. The oil was crystallised from melting between 63-67°C (lit.¹¹ m.p. 65°).

ii) Treatment of the above epoxide with diethylamine:-

p-Nitrophenoxy-2,3-epoxypropane was refluxed with an excess of diethylamine solution to yield 4-(3-diethylamino-2-hydroxypropoxy)-nitrobenzene. It was characterised by preparing its hydrochloride by ethereal hydrochloric acid whose melting point has been reported in the literature⁴³ (m.p. 162-63°C). The PMR spectrum of this compound exhibited a triplet at 1.0 (t, 6H, $-\text{N}-\text{CH}_2-\text{CH}_3$)₂ a multiplet at 2.5 (m, 6H [$-\text{CH}_2-\text{N}(\text{CH}_2\text{CH}_3)_2$], another multiplet at 4.0 (3H, [$\text{O}-\text{CH}_2-\text{CHOH}$]), along with a broad hydroxyl peak which exchanges with D₂O at 3.1. The p-disubstituted pattern of p-nitrophenoxy group was shown as two doublet at 7 & 8 respectively.

iii) Reduction of 4-(3-diethylamino-2-hydroxypropoxy)-nitrobenzene to 4-(3-diethylamino-2-hydroxypropoxy)aniline (Scheme I-b)

The nitro alcohol was reduced catalytically with 10% Pd/C under hydrogen pressure of 3 atm in ethanol to

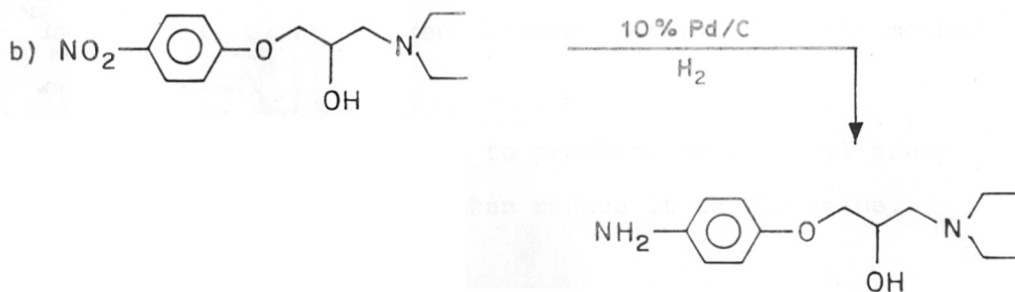
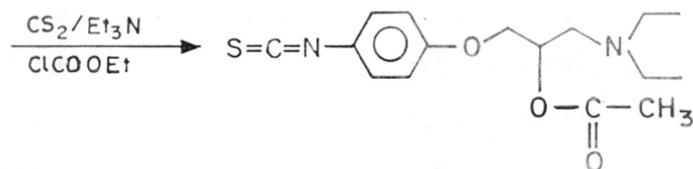
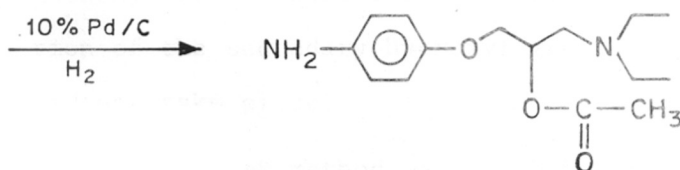
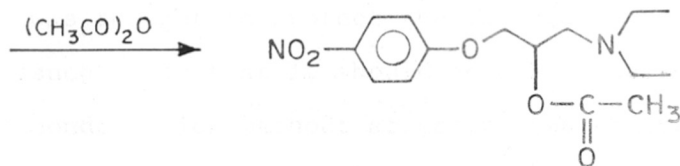
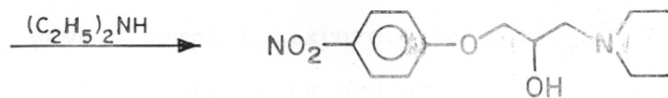

give the corresponding amine which was purified by distillation, b.p. 125°C/0.8 mm Scheme III(b).

The usual condensation of the above amino compound with aryl isothiocyanates to obtain ~~thiourea derivatives~~ gave a complex mixture. This was attributed to the fact that the secondary hydroxyl group might be interfering in the reaction to give undesired side products. Hence it was thought to protect the secondary hydroxyl group in such a way that it should be easily deprotected after the condensation without affecting the thiourea.

Many protective groups such as tetrahydropyranyl, methoxy methyl, were tried. However, the selective protection of the secondary hydroxyl group in presence of the amine did not take place.

Yet another method was tried by preparing the diacetate of the above amino hydroxy compound. The diacetate was prepared by refluxing the amine with acetic anhydride. No base was used as the tertiary nitrogen atom itself acted as a scavenger. However, on treatment with K_2CO_3 and methanol at 0°C only the O-acetate was deprotected without affecting the N-acetate. Since this compound was of no use in getting the desired thiourea derivatives, the method was abandoned.

Hence it was preferable to protect the hydroxyl group in the nitro compound and then reduce it to the amine.

Since acetates are stable under reducing conditions, the secondary hydroxy group was thus, protected as its acetate to give 4-[2-acetoxy-3-diethylamino-1-propoxy] nitrobenzene. Thus, the above compound was prepared by reacting 4-[3-diethylamino-2-hydroxy-1-propoxy] nitrobenzene with acetic anhydride. The reaction mixture was carefully neutralized by ammonia to give the acetate derivative in about 70% yield. It was preserved at 0°C due to its unstability. A downfield multiplet of ($-\underline{\text{C}}\text{H OAc}$) (PMR) in the acetyl derivative was the characteristic of this compound. The IR spectra also showed a C = O stretching of the acetyl group at 1740 cm^{-1} , further confirming the structure of the compound.

Reduction of the above nitroacetate had to be carried out under essentially neutral condition, due to the lability of the acetate moiety, which is augmented by anchimeric assistance offered by the β -tertiary nitrogen atom. Thus conventional methods of reducing the nitro group had to be done with, and hence catalytic hydrogenation was indispensable. When Raney-nickel as a catalyst for hydrogenation was used, longer times were required causing sufficient decomposition of the product. Therefore, the nitro acetate was reduced with freshly prepared 10% palladium over charcoal at 2 atmospheres in a Parr hydrogenator.

The product obtained was accompanied by some deacetylated products, hence it had to be purified by column chromatography.

Thus 4-[2-acetoxy-3-diethylamino-1-propoxy] aniline was obtained as an oil in about 25% yields. The IR spectra showed a doublet at 3400 cm^{-1} for the aromatic amine along with a band at 1740 cm^{-1} (C-COCH_3) for the acetyl group. A downfield multiplet ($\delta = 7.27$ of CH-OAc) in the NMR with a doublet of a doublet in the aromatic region at 6.75 further confirmed the structure of the compound.

Preparation of 4-[2-acetoxy-3-diethylamino-1-propoxy] phenyl isothiocyanate

The methods of preparation of aryl isothiocyanates have been reviewed in theoretical (Sect. 2.2-0). Of these different procedures, the one adopted by Kaluza and modified by me was found to be suitable in the synthesis of the above isothiocyanate.

The amine (1 mol) was dissolved in carbondisulphide and to it was added triethylamine (1 mol). The reaction mixture was refrigerated overnight and then decomposed with ethyl chloroformate. The crude oil was chromatographed on silica gel using chloroform:methanol (9:1) as a solvent system to afford 4-[2-acetoxy-3-diethylamino-1-propoxy] phenyl isothiocyanate in 70% yield. The $\text{N}=\text{C}=\text{S}$ stretching absorption at 2100 cm^{-1} (broad) in IR spectra gave ample evidence for the structure of this compound, Fig. XIII-a&b.

The above mentioned isothiocyanate was used to prepare the thiourea derivatives and after the condensation, the acetoxy group was deprotected by a base.

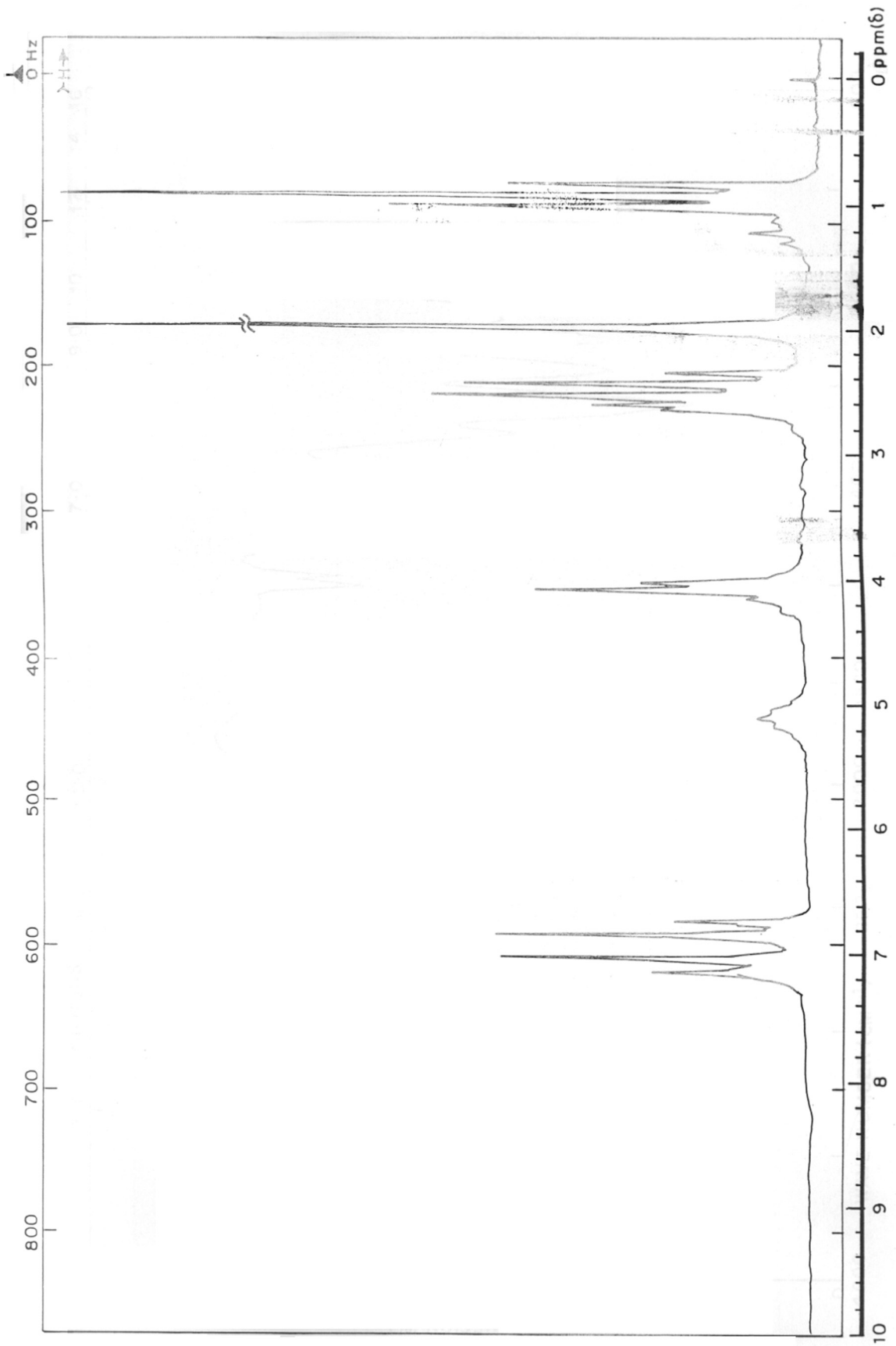

FIG. XIII (a) PMR SPECTRUM OF COMPOUND

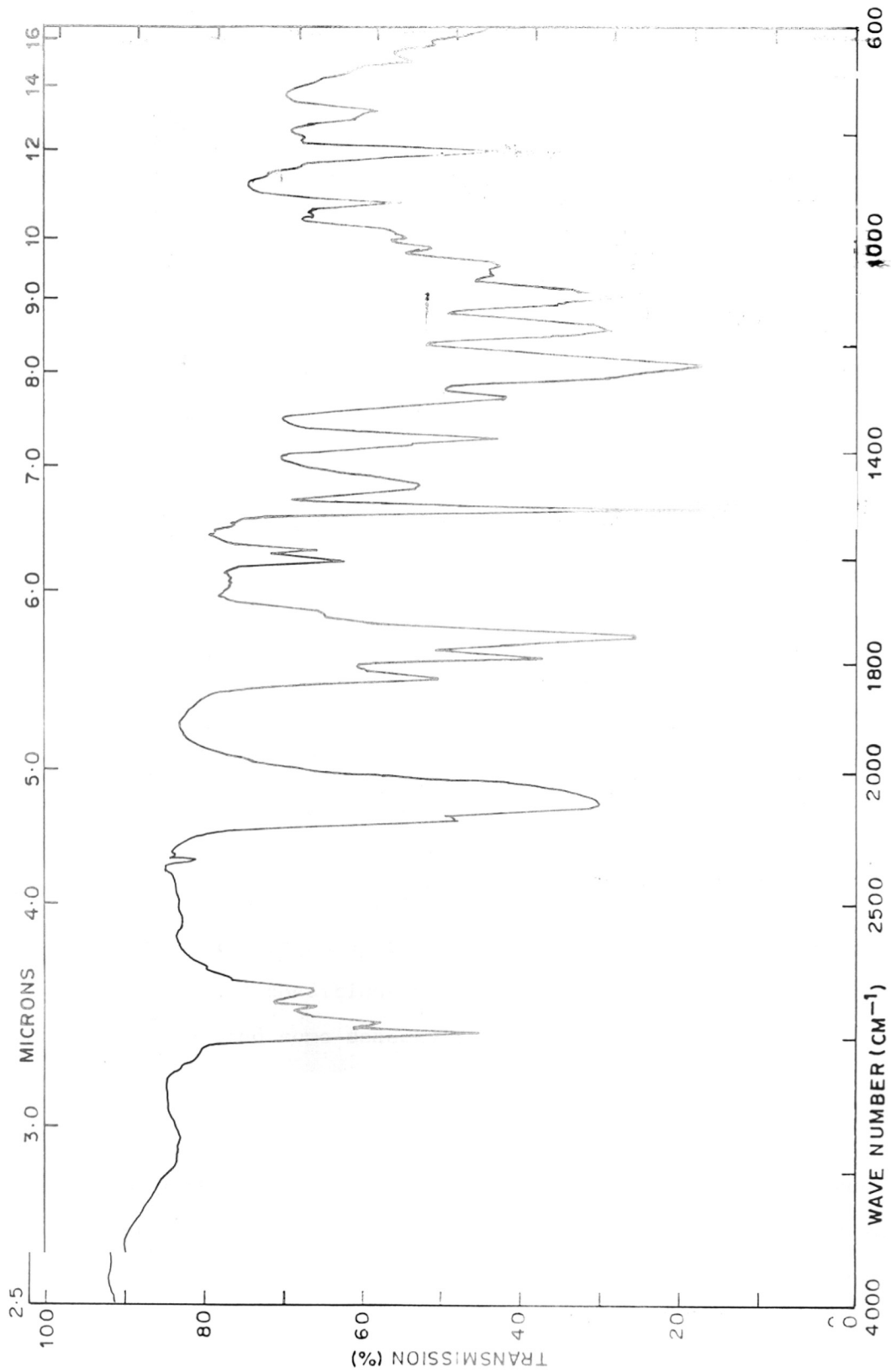

FIG. XIII (b). IR SPECTRUM OF COMPOUND

The preparation of the thiourea derivatives may be divided into two steps:

4.3-0 CONDENSATION OF 4-(2-ACETOXY-3-DIETHYLAMINO-1-PROPOXY)ANILINE WITH VARIOUS p-SUBSTITUTED PHENYL-ISOTHIOCYANATES

4.3-1 Condensation of 4-(2-acetoxy-3-diethylamino-1-propoxy)phenyl isothiocyanate with various amines

I) The reaction of amines with isothiocyanates to give thioureas is well documented in the literature. Generally, a solvent like ethanol is used and equimolar quantities of the amine and the isothiocyanates are refluxed in ethanol to yield the desired thioureas. The thiourea is precipitated on cooling the solution or on concentration. Different solvents like benzene, dimethylformamide, pyridine etc. have been used for this reaction.

In the case of the acetoxy isothiocyanate, the use of a polar solvent like ethanol had to be avoided because it initiated the deacetylation process to a much greater extent as judged by the reaction products, hence the use of aprotic conditions were desirable. Refluxing conditions also caused some deacetylation and therefore the reaction had to be carried out at room temperature.

The condensation of 4-(2-acetoxy-3-diethylamino-1-propoxy)amine with aromatic aryl isothiocyanate was studied under different conditions and solvents. Acetonitrile was found to be an ideal solvent for carrying out the above

SCHEME - IV

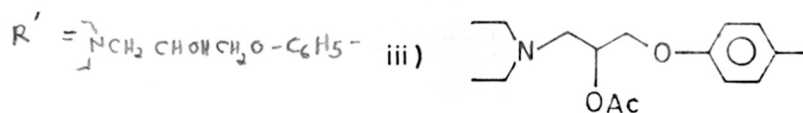
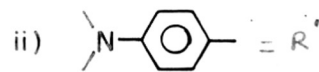
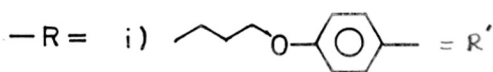
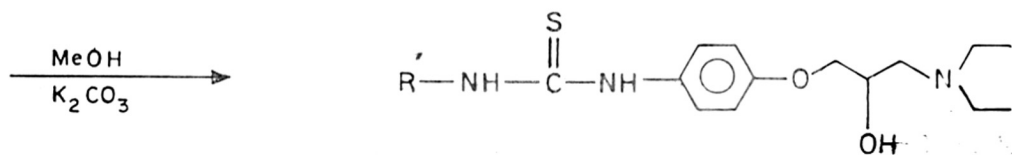
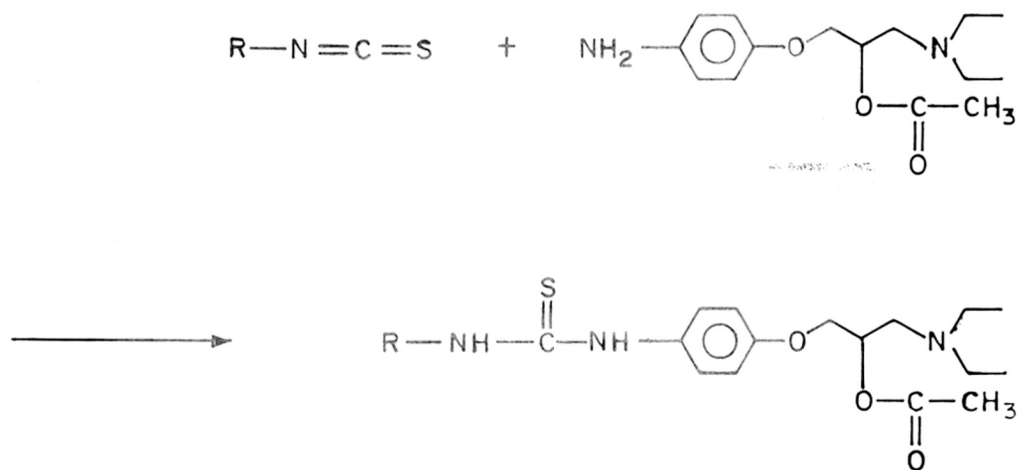

condensations to yield the desired thiourea. After the usual formation of thiourea, it was deacetylated by stirring with 1 equivalent of potassium carbonate in methanol to give the free secondary hydroxyl group.

The following thioureas were prepared by the above general method (Scheme IV).

i) 1'-[p-n-Butoxyphenyl]-3'-[4-(2''-hydroxy-3''-diethylamino-1''-propoxy)phenyl]-2'-thiourea was prepared by stirring 1 mole of p-n-butoxyphenyl isothiocyanate with 4-(2'-acetoxy-3'-diethylamino-1'-propoxy) aniline in dry acetonitrile, which on concentration and column chromatography over silica gel yielded the thiourea acetate in 50% yield. IR showed a C=O band for the acetoxy group at 1740 and NH-C=S at 1470 cm^{-1} and the PMR (δ) exhibited a characteristic one proton multiplet of CHOAc at 5.2 and the alkyl protons between 1 & 2 [Fig. XIV (a)]. The acetate on stirring with potassium carbonate and on work up gave the desired hydroxyl thiourea. The reaction was followed by the disappearance of the acetoxy group in IR, [Fig. XIV (b)]. The PMR values for this compounds are given in the experimental part.

ii) 1'-[p-Dimethylaminophenyl]-3'-[4-(2''-hydroxy-3''-diethylamino-1''-propoxy)phenyl]-2'-thiourea was prepared by the same method as described above and the product column chromatographed on silica gel to yield the desired thiourea acetate which was again characterised in the C=O stretch of

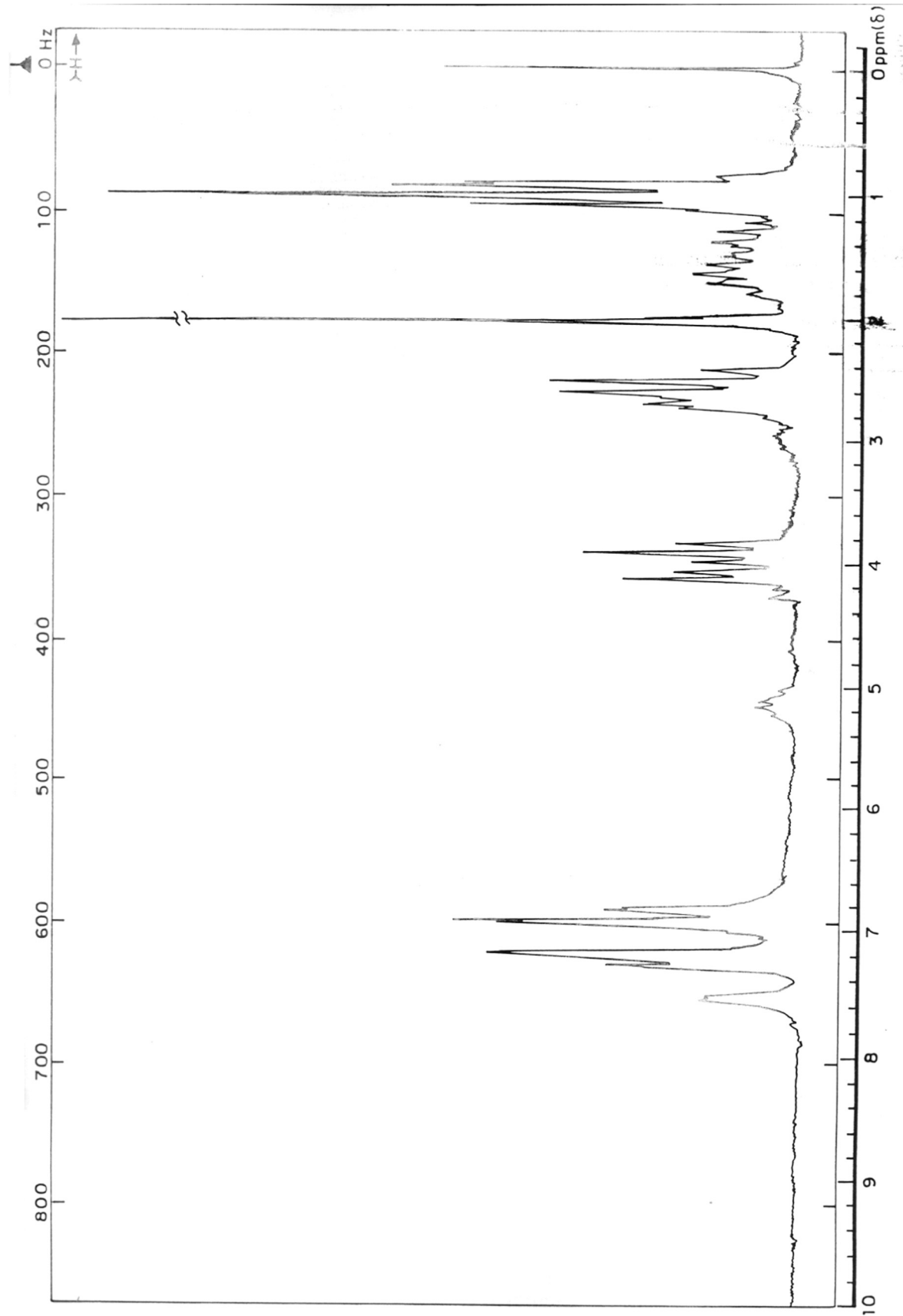

FIG. XIV (a). PMR SPECTRUM OF COMPOUND

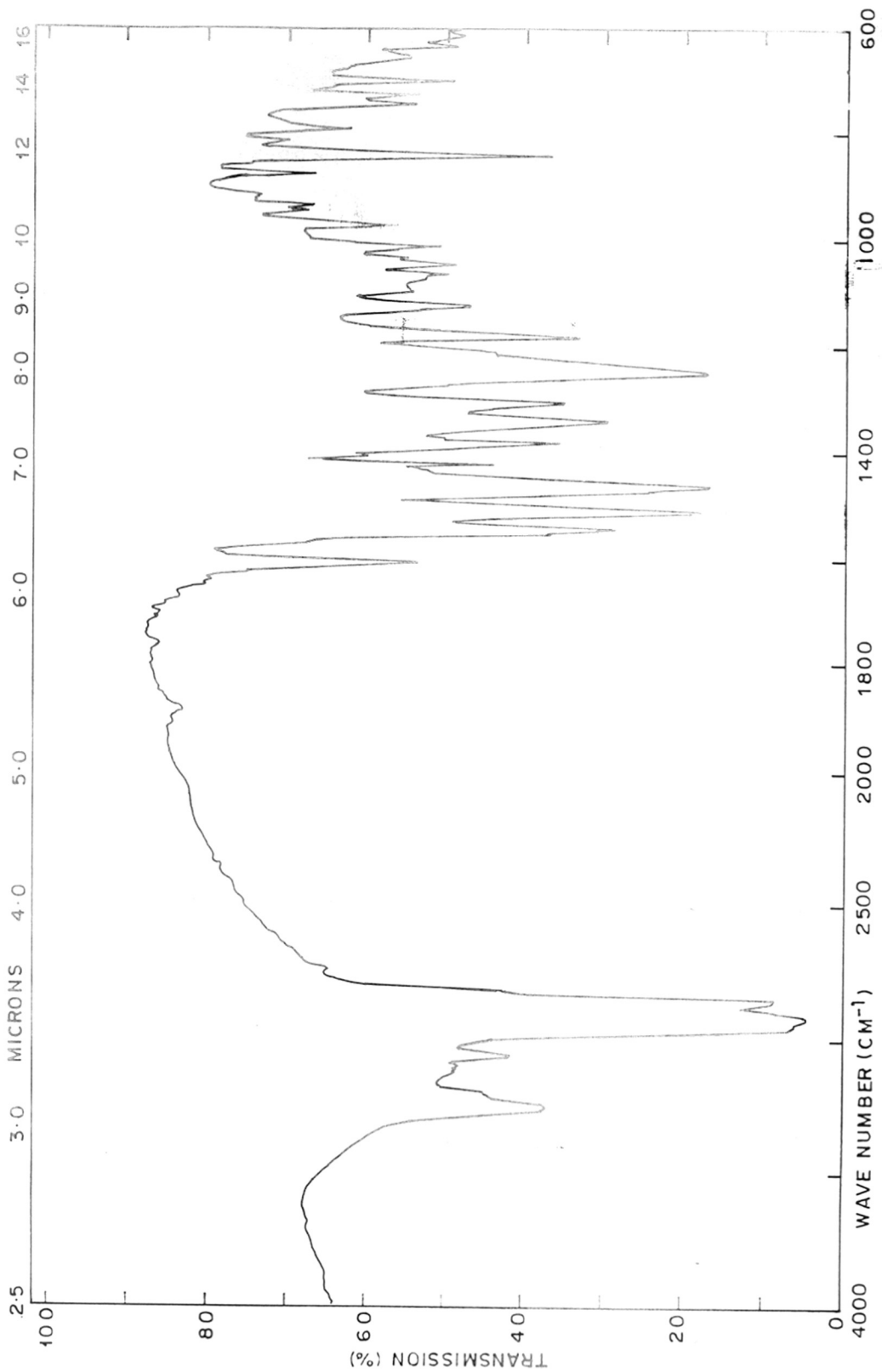

FIG. XIV (b). IR SPECTRUM OF COMPOUND

acetoxo group and the $\text{NH} - \text{C} = \text{S}$ stretching; PMR showed a sharp singlet at 3 for N,N-dimethyl grouping along with usual protons of the 2-acetoxy-N,N-diethylamino propoxy side chain. The deprotection of the acetate gave the desired thiourea in quantitative yields as oil. The compound thus formed has the requisite spectral data (Experimental).

iii) 1'-3'-bis[4-(2''-hydroxy-3''-diethylamino-1''-propoxy diphenyl]thiourea. In the preparation of this symmetrical thiourea, 4-[2'-acetoxy-3'-diethylamino-1'-propoxy]aniline and its corresponding isothiocyanate were condensed in dry acetonitrile to give the bis thiourea diacetate. The diacetate thiourea was characterised on the basis of $\text{NH} - \text{C} = \text{S}$ stretching absorption in IR indicating the presence of the thiourea and PMR spectrum showing the propoxy side chain. The bis thiourea diacetate was later deacetylated by using potassium carbonate and chromatographed to give an oil which showed the disappearance of the acetoxo group ($\text{C} = \text{O}$ stretch at 1740) in IR. Other spectra data (PMR and microanalysis) further confirmed the structure of this compound [Fig. XV (a) & (b)]

In this way the o-acetyl group in the amine was successfully employed in obtaining the desired thioureas without much side products and in good yields.

The amino of the o-acetyl propoxy compound was further converted into its corresponding isothiocyanate.

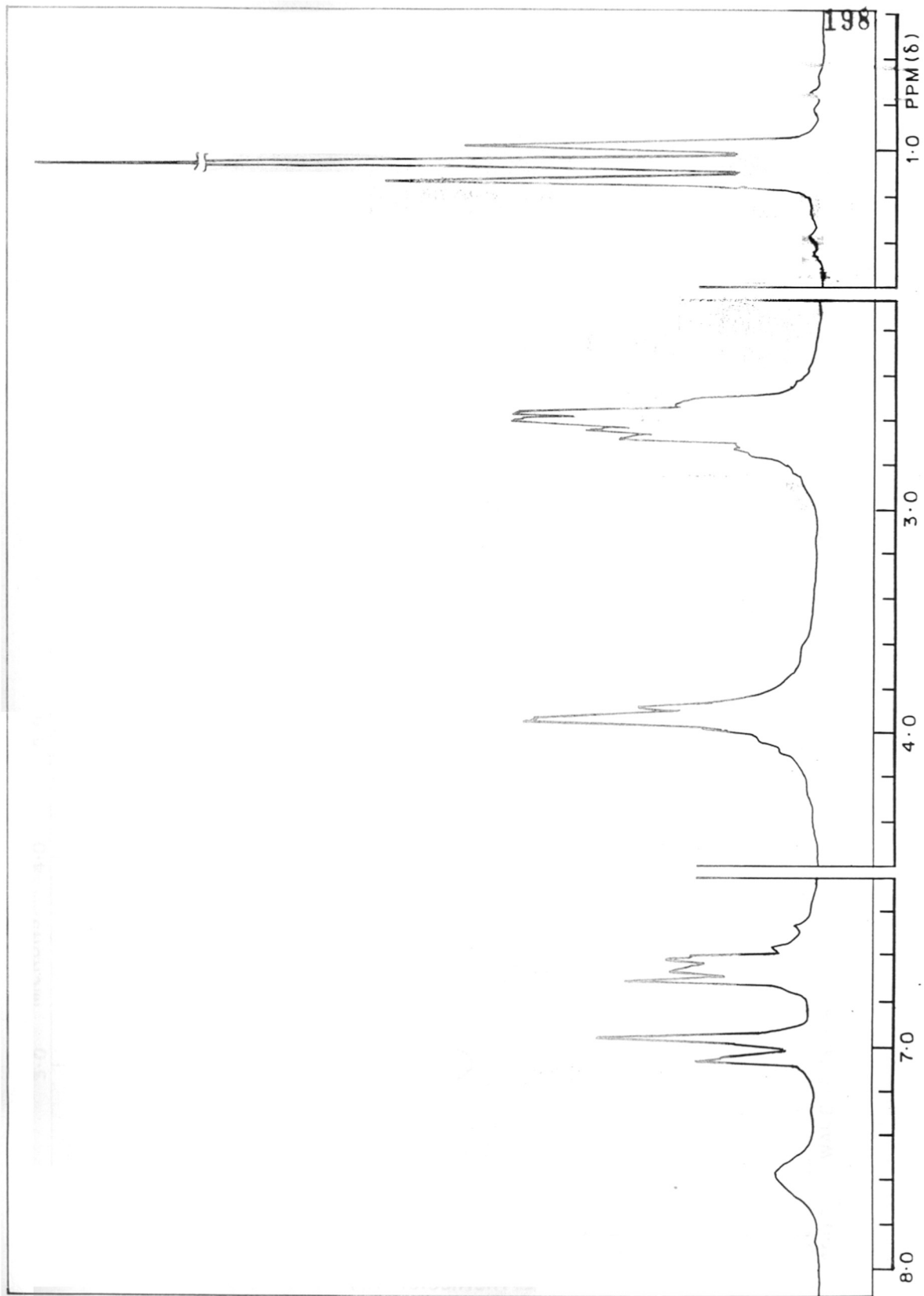
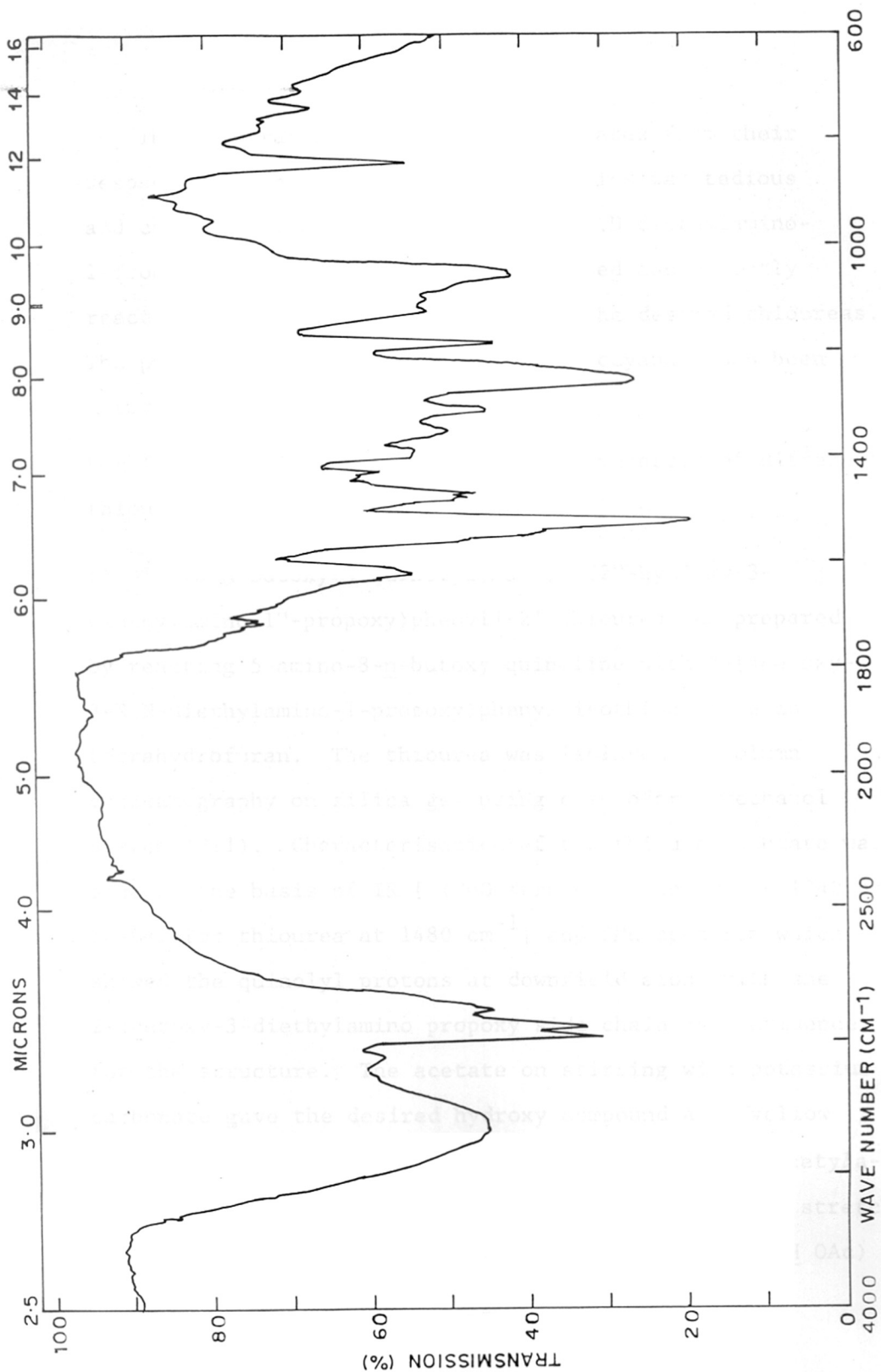

FIG. XV (a). PMR SPECTRUM OF COMPOUND

FIG. XV (b). IR SPECTRUM OF COMPOUND



The preparation of the isothiocyanates from their respective amines in the following series was tedious and cumbersome, hence 4-[2-acetoxy-3-N,N-diethylamino-1-propoxy]phenyl isothiocyanate was used and directly reacted with various amines to yield the desired thioureas. The preparation of this aryloxy isothiocyanate has been described in the experimental section.

(2) The following part describes the synthesis of different thioureas (Scheme V).

i) 1'-[8-n-Butoxy-5-quinolyl]-3'-[4-(2''-hydroxy-3-diethylamino-1''-propoxy)phenyl]-2'-thiourea was prepared by reacting 5-amino-8-n-butoxy quinoline with 4-[acetoxy-3-N,N-diethylamino-1-propoxy)phenyl isothiocyanate in tetrahydrofuran. The thiourea was isolated by column chromatography on silica gel using chloroform : methanol system (9:1). Characterisation of the thiourea acetate was done on the basis of IR [(C=O stretch of acetyl at 1740 cm^{-1} , NH-C=S for thiourea at 1480 cm^{-1}] and PMR spectrum which showed the quinolyl protons at downfield along with the 2-acetoxy-3-diethylamino propoxy side chain gave evidence for the structure. The acetate on stirring with potassium carbonate gave the desired hydroxy compound as a yellow solid which was recrystallised from benzene. The deacetylation was confirmed by the disappearance of the C = O stretch at 1740 cm^{-1} in IR and the downfield multiplet of (CH OAc) [Fig. XVI (a) & (b)].

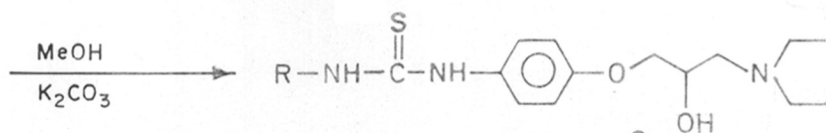
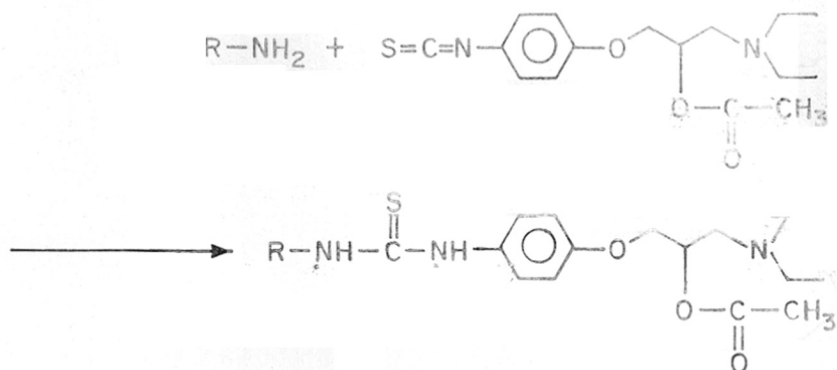

R =

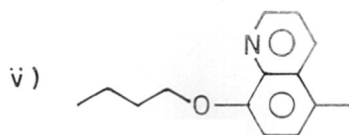
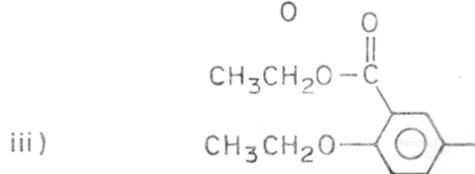
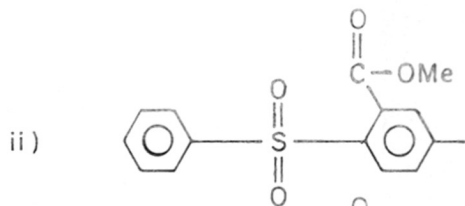

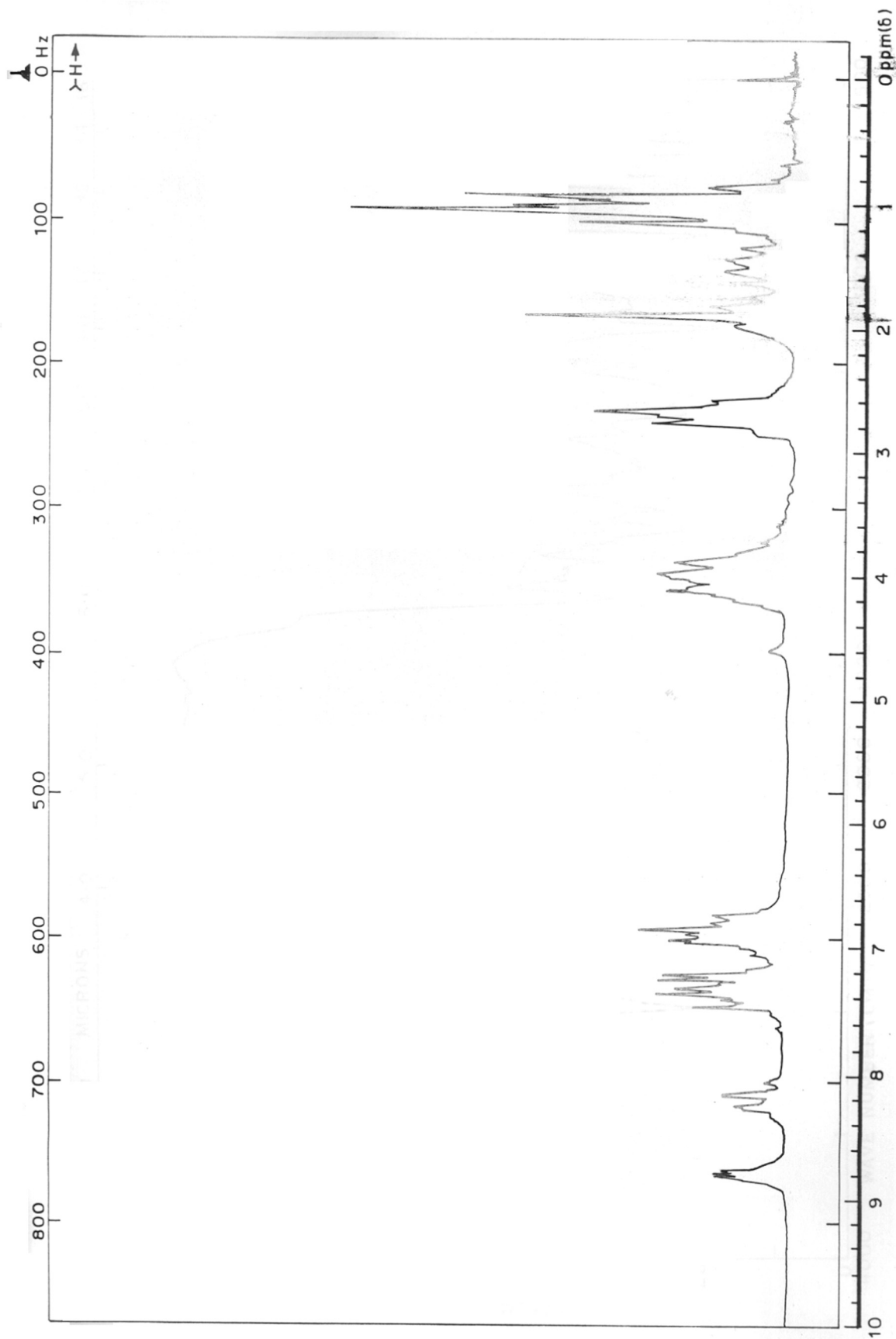
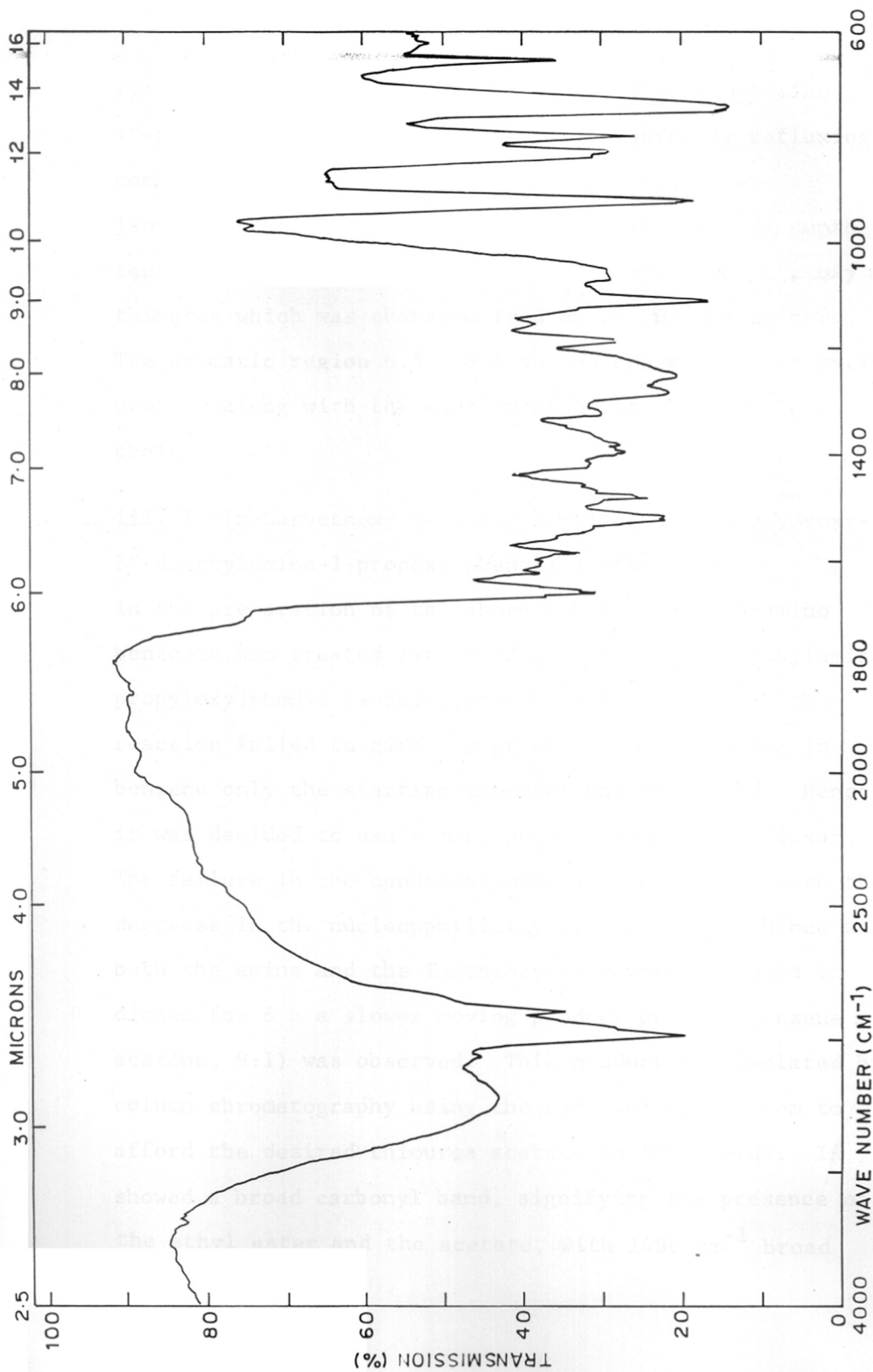

FIG. XVI (a). PMR SPECTRUM OF COMPOUND

FIG. XVI (b). IR SPECTRUM OF COMPOUND



ii) 1'-[2-Pyridyl]-3'-[4-(2''-hydroxy-3''-diethylamino-1''-propoxy)phenyl]-2'-thiourea was prepared by refluxing commercially available 2-acetylpyridine with the isothiocyanate in THF. The acetyl derivative was deprotected by the usual method to yield the desired hydroxy thiourea which was characterised by IR and PMR spectra. The aromatic region 6.5 - 8.6 showed characteristic pyridyl protons along with the usual protons of the propoxy side chain.

iii) 1'-[m-Carbethoxy-p-ethoxyphenyl]-3'-[4-(2''-hydroxy-3''-diethylamino-1-propoxy phenyl)-2'-thiourea.

In the preparation of the above ethyl-2-ethoxy-5-amino benzoate was treated with 4-[2-acetoxy-3-N,N-diethylamino propoxy]phenyl isothiocyanate in THF. However, the reaction failed to give any product. On refluxing in benzene only the starting material was recovered. Hence it was decided to use a more polar solvent like dioxan. The failure in the condensations may be attributed to the decrease in the nucleophilicity of the amine. Hence when both the amine and the isothiocyanate were refluxed in dioxan for 6 h a slower moving product on TLC (benzene : acetone, 9:1) was observed. This product was isolated by column chromatography using the same solvent system to afford the desired thiourea acetate in 50% yields. IR showed a broad carbonyl band, signifying the presence of the ethyl ester and the acetate, with 1480 cm^{-1} broad

band (NH-C=S) confirming the presence of thiourea. The PMR spectrum of the thiourea derivative gave complex multiplets in the aliphatic region, a characteristic amide proton multiplet of CHOAc signifying the presence of an amide group.

The acetate was then deprotected to its hydroxyl compound by stirring it with potassium carbonate in methanol, which on work up afforded the desired thiourea in quantitative yields. The disappearance of the typical multiplet at 5.2 δ for the (CH-OAc) [Fig. XVII (a) & (b)] provided ample evidence for the success of deacetylation. It is worthwhile to mention here that the above reaction was done in cold condition so as to prevent the hydrolysis of the ethyl ester.

iv) 2'-Carbomethoxy-4'-[4-(2''-hydroxy-3''-diethylamino-1''-propoxy)phenyl thiocarbamido]diphenylsulfide. In the preparation of the above thiocarbamide 2-carbomethoxy-4-aminodiphenylsulfide was refluxed with the acetoxy isothiocyanate in tetrahydrofuran to afford the thiourea acetate in poor yields. It was observed that the reaction could not be driven to completion as stringent conditions yielded decomposed products; mainly the deacylation product. Hence the reaction was taken to a stage wherein maximum product is formed (observed by TLC in benzene:acetone, 9:1 solvent system) and then the starting materials were recovered by using column chromatography. Thus the yields based on recovery were satisfactory; i.e. about 75-80%, but the actual conversion was only 20% (Scheme VII).

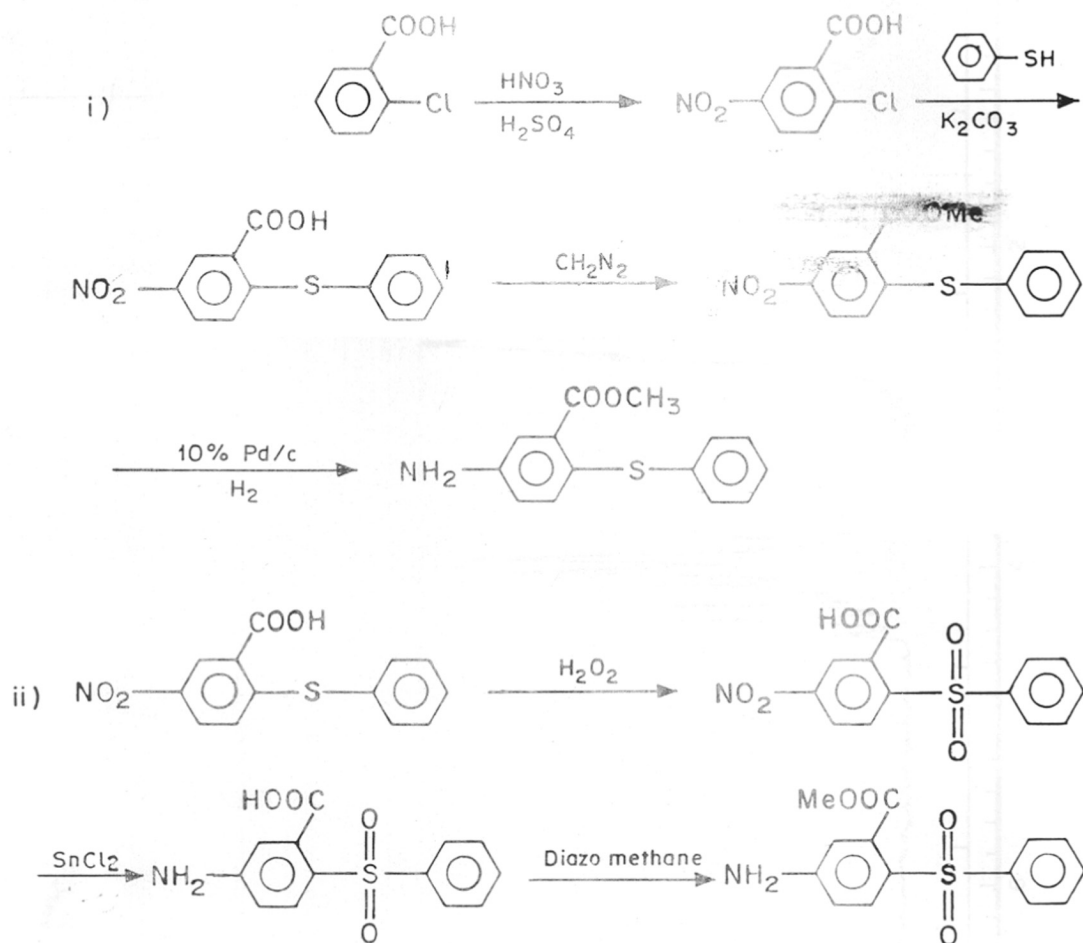

SCHEME-VII

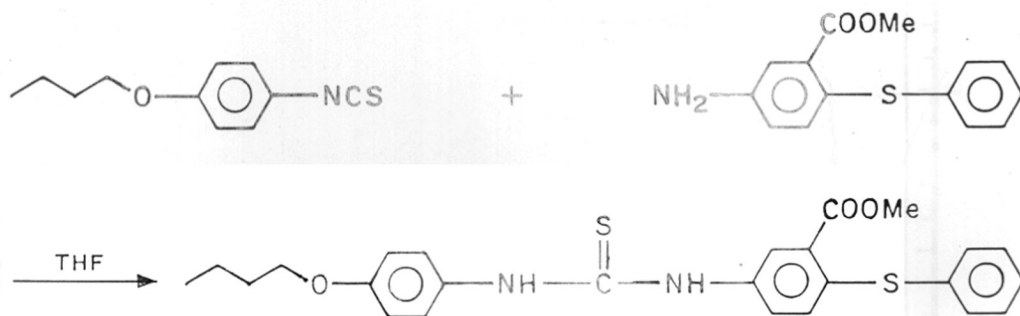

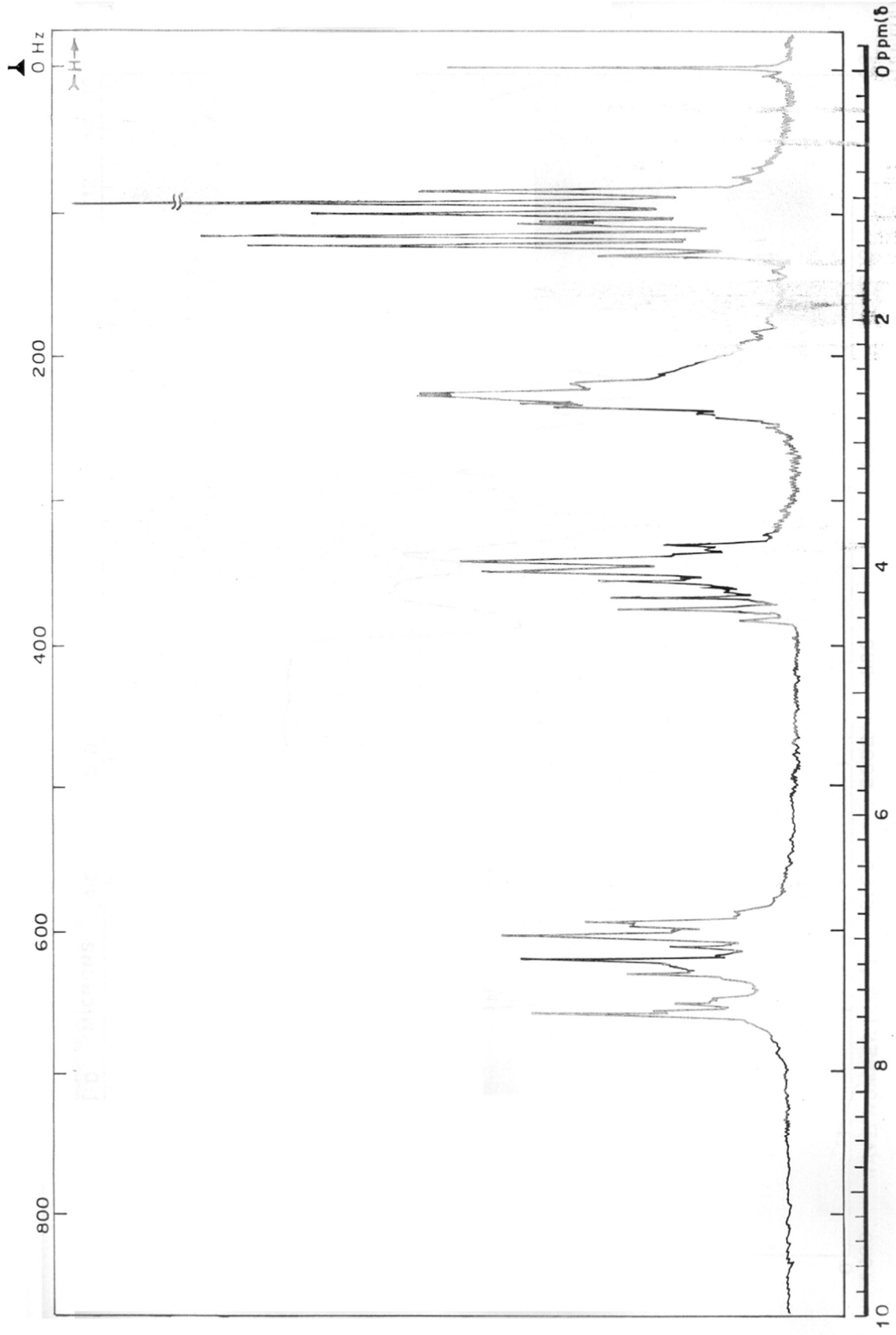
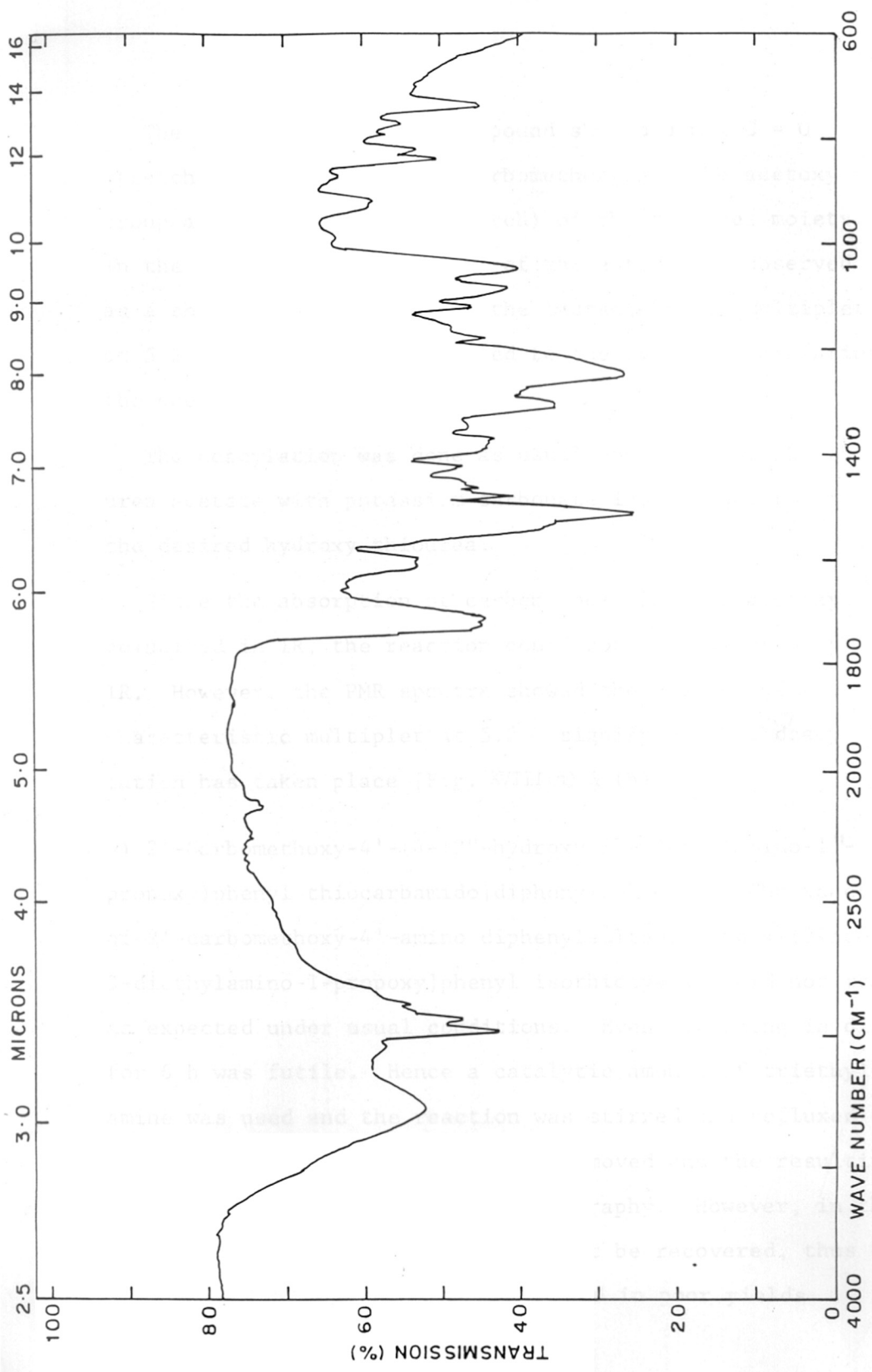

FIG. XVII(a). PMR SPECTRUM OF COMPOUND

FIG. XVII(b) IR SPECTRUM OF COMPOUND



The IR spectrum of the compound showed usual C = O stretch absorption for the carbomethoxy and the acetoxy group along with (NH-C=S stretch) of the thiourea moiety. In the PMR the methyl protons of the ester were observed as a sharp singlet at 3.9 and the characteristic multiplet at 5.2 δ of the proton attached to the carbon atom bearing the acetoxy group.

The deacylation was done as usual, by treating the thiourea acetate with potassium carbonate in methanol to give the desired hydroxy-thiourea.

Since the absorption of carbomethoxy and the acetoxy coincided in IR, the reaction could not be monitored by IR. However, the PMR spectra showed the absence of the characteristic multiplet at 5.2 signifying that deacylation has taken place [Fig. XVIII(a) & (b)].

v) 2'-Carbomethoxy-4'-[4-(2''-hydroxy-3''-diethylamino-1''-propoxy)phenyl thiocarbamido]diphenylsulfone. The reaction of 2'-carbomethoxy-4'-amino diphenylsulfone with 4-(2-acetoxy-3-diethylamino-1-propoxy]phenyl isothiocyanate did not proceed as expected under usual conditions. Even refluxing in dioxan for 6 h was futile. Hence a catalytic amount of triethylamine was used and the reaction was stirred and refluxed in dioxan for 24 h. The solvent was removed and the resulting oil was purified by column chromatography. However, in this case the starting materials could not be recovered, thus the desired thiourea acetate was obtained in poor yields.

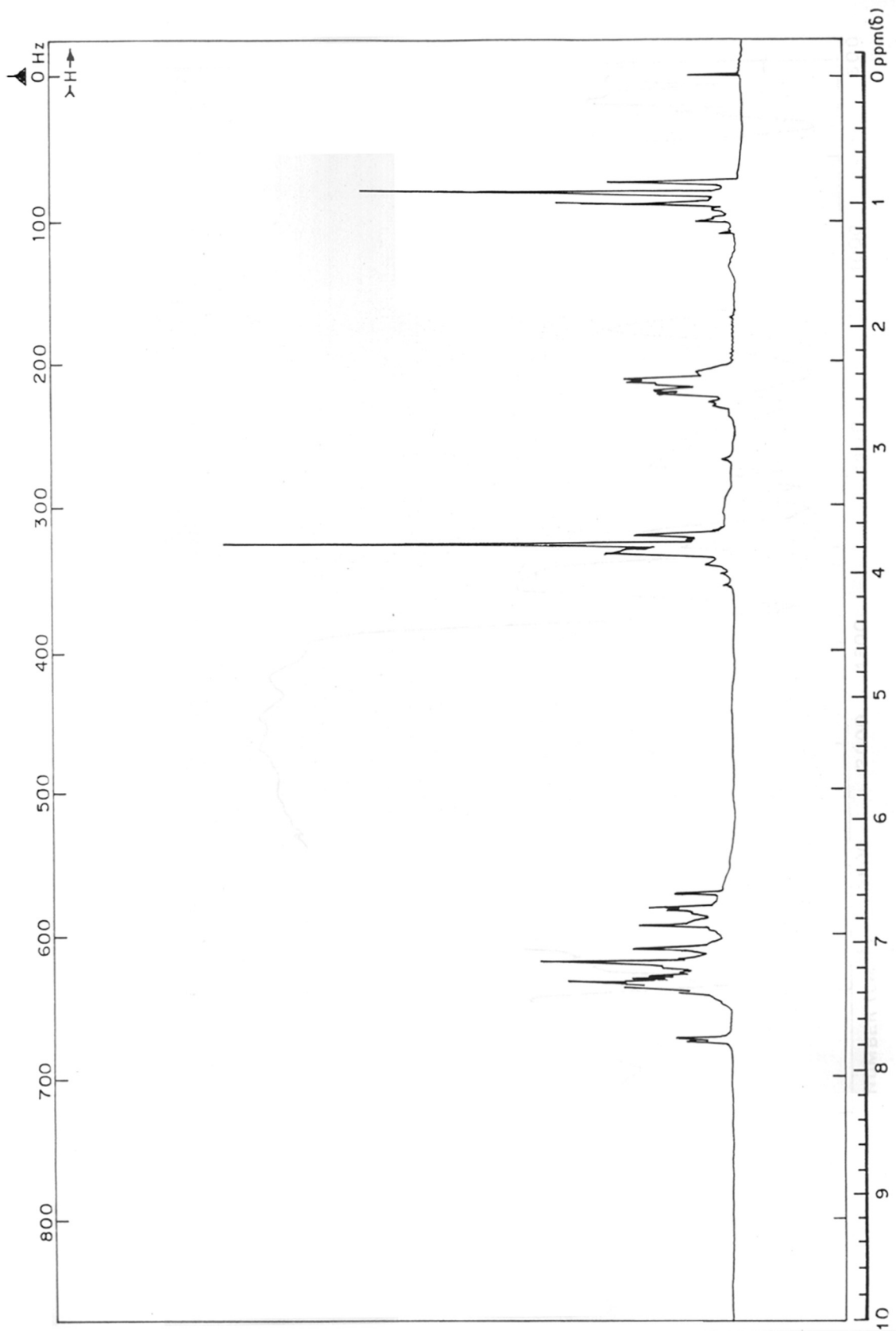
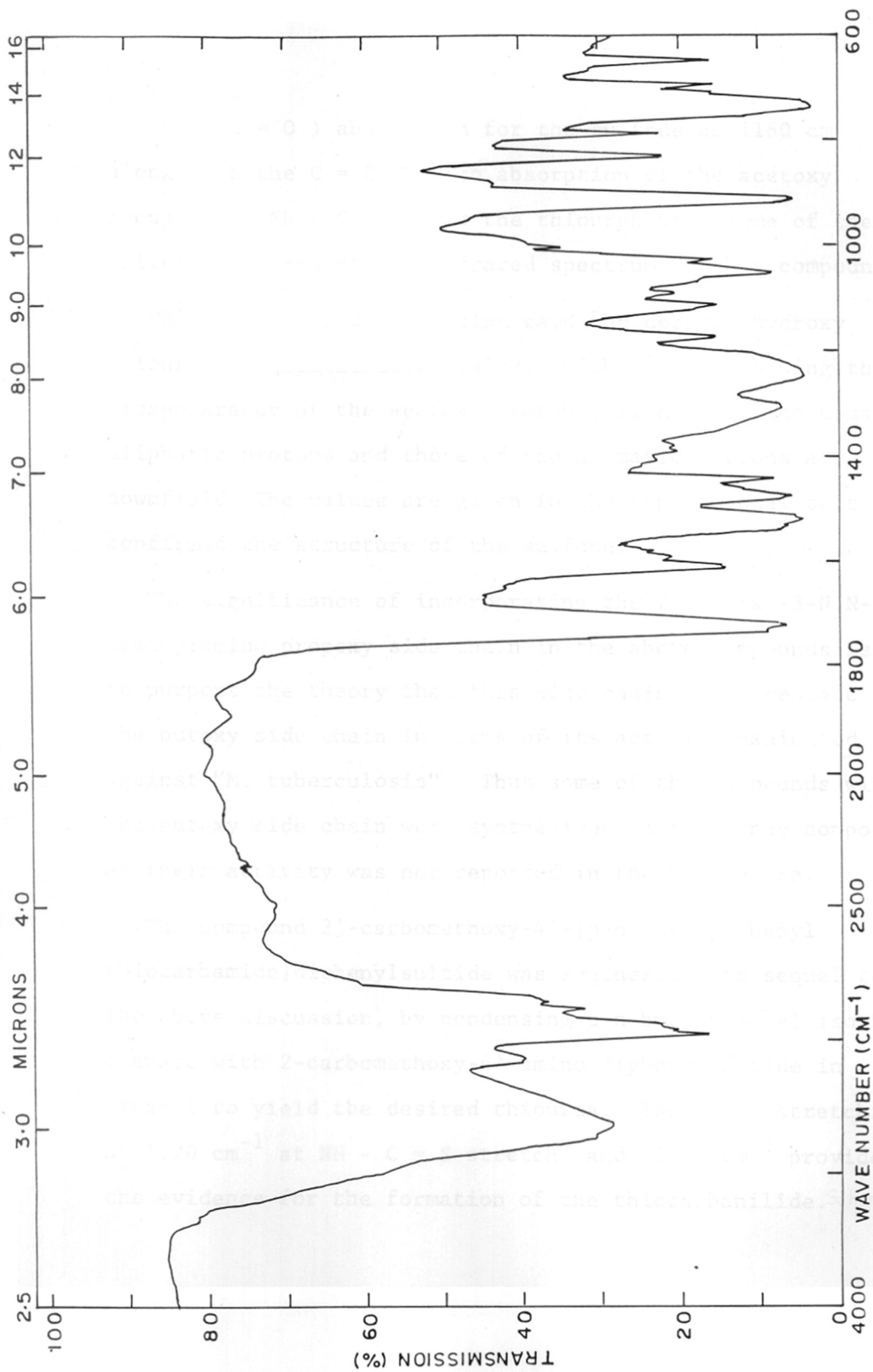

FIG. XVIII (a). PMR SPECTRUM OF COMPOUND

210

FIG. XVII(b) IR SPECTRUM OF COMPOUND



The ($\overset{\text{O}}{\parallel} \text{S} = \text{O}$) absorption for the sulfone at 1160 cm^{-1} along with the $\text{C} = \text{O}$ stretch absorption of the acetoxy group and ($\text{NH} - \text{C} = \text{S}$) for the thiourea were some of the salient features of the infrared spectrum of this compound.

The acetate on deprotection gave the desired hydroxy thiourea in quantitative yields, with the PMR showing the disappearance of the acetoxy protons, along with the usual aliphatic protons and those of the aromatic protons at downfield (The values are given in the experimental section) confirmed the structure of the sulfone.

The significance of incorporating the 2-hydroxy-3-N,N-diethylamino propoxy side chain in the above compounds is to purport the theory that this side chain could replace the butoxy side chain in terms of its activity exhibited against "M. tuberculosis". Thus some of the compounds with the butoxy side chain were synthesised as reference compounds as their activity was not reported in the literature.

The compound 2'-carbomethoxy-4'-[p-n-butoxy]phenyl thiocarbamido]diphenylsulfide was synthesised as sequel to the above discussion, by condensing p-n-butoxyphenyl isothiocyanate with 2-carbomethoxy-4'-amino diphenylsulfide in ethanol to yield the desired thiourea. The $\text{C} = \text{O}$ stretching at 1720 cm^{-1} at $\text{NH} - \text{C} = \text{S}$ stretch and 1470 cm^{-1} provided the evidence for the formation of the thiocarbamylide. Scheme VII

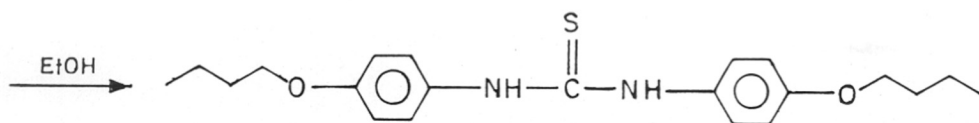
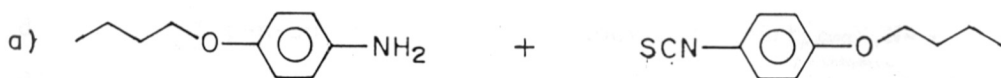
SCHEME - VII

4,4' BIS BUTOXY DIPHENYL THIOUREA

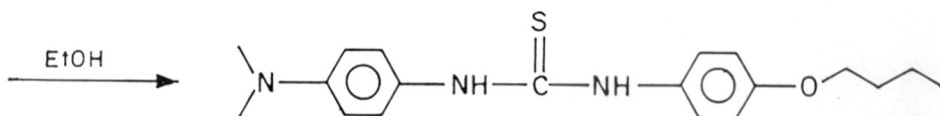
THIAMBUTOSINE

Thiambutosine and 4,4'-bis-butoxythiourea which were the standards used in comparing the activity of the above compounds were also prepared¹² by reported methods. Condensation of p-n-butoxyphenyl isothiocyanate with p-N,N-dimethylamino aniline and p-N-butoxy aniline respectively gave the desired thioureas (Scheme VIIIa&b). The melting points of these compounds corroborated with those given in the literature.¹²

4.4-0 EXPERIMENTAL

This section deals with the preparation of compounds with 2-hydroxy-3-diethylaminopropoxy side chain in the aryl nucleus of diarylthioureas.

The steps involved are as follows:

1. Preparation of substituted anilines
2. Preparation of aryl isothiocyanates
3. Condensation of aryl isothiocyanates with substituted anilines.

1. PREPARATION OF SUBSTITUTED ANILINES:

The following p-substituted anilines were prepared in the present investigation.

a) p-n-Butoxy aniline

This was prepared as described in Section 2.5; p.89.

b) p-N,N-dimethylaniline¹⁶

Stannous chloride (45 g, 0.2 mol) was dissolved in conc. hydrochloric acid (40 ml). The solution was heated up to 85°C on a water bath and p-nitrosodimethylaniline (BDH) sample (15 g, 0.1 mol) was added in portions over a period of 2 h. with constant stirring. After the addition was complete, the reaction mixture was boiled for a short time, whereby it became homogeneous. It was then cooled, diluted and made alkaline with sodium hydroxide (50%) and extracted with ether. The ether extract was dried over anhydrous sodium sulphate and ether was distilled off.

The residue was purified by vacuum distillation. Yield 6 g, b.p. 128-29° at 13 mm, m.p. 42-43°.

c) Preparation of 5-amino-8-n-butoxy quinoline

This involves the following steps:

- i) Preparation of 8-n-butoxy quinoline
 - ii) Nitration of 8-n-butoxy quinoline to 5-nitro-8-n-butoxy quinoline.
 - iii) Reduction of 5-nitro-8-n-butoxy quinoline to 5-amino-8-n-butoxy quinoline.
- i) Preparation of 8-n-butoxy quinoline¹⁸

14.5 g of 8-hydroxy quinoline and 5.6 g of KOH were dissolved in 60 ml of ethanol. Then 11 ml (13.7 g) n-butyl bromide was added to it slowly with shaking. The whole reaction mixture was refluxed on a water bath for 6 h. Next day, all the alcohol was removed by distillation and water was added to the residual solution. An oily layer was separated. Both the oily layer and the aqueous layer were extracted with ether. Ether extract was dried over anhydrous sodium sulphate. Ether was distilled off and the viscous red liquid was carefully vacuum distilled. The pale yellow liquid obtained on distillation soon solidified to give pale yellow crystalline solid of 8-n-butoxy quinoline. Yield 14 g, b.p. 140°C at 2 mm, m.p. 48°C.

- ii) Nitration of 8-n-butoxy quinoline¹⁸

8 g of 8-n-butoxy quinoline was added in small lots

to 24 ml of 95% fuming nitric acid at room temperature with mechanical stirring. Throughout the addition, the temperature was not allowed to rise. After all the addition was over, the mixture was kept at room temperature for 1 h. It was then heated on a water bath at 70°C for 3 h. with mechanical stirring. The mixture was finally cooled and poured into ice-cold water. It was basified with sodium carbonate. The crude product was filtered and crystallized from ethanol to give pure 5-nitro-8-n-butoxy quinoline. Yield 6 g, m.p. 106° (Lit.¹⁸ m.p. 107-108°).

iii) Reduction of 5-nitro-8-n-butoxy quinolines.¹⁹

30 g of 5-nitro-8-n-butoxy quinoline was dissolved in 25 cc of ethanol and to it was added 6 ml of water and 6 g of iron powder. The mixture was refluxed on a water bath with mechanical stirring. A solution of 4.5 ml of conc. HCl in 30 ml water was added over a period of 2 h. The reaction mixture was further heated for 2 h. Then it was basified with sodium carbonate and filtered hot. The filtrate and the washings were collected and ethanol was completely removed and the solid was filtered washed thoroughly with water. It was crystallized from benzene to give 5-amino-8-n-butoxy quinoline. Yield 20 g, m.p. 91°C (Lit.¹⁸ m.p. 91°C).

d) Ethyl-2-ethoxy-5-aminobenzoate:

This involves the following steps:

- i) Nitration of salicylic acid to 5-nitro salicylic acid,
- ii) Esterification of 5-nitro salicylic acid
- iii) Preparation of ethyl-2-ethoxy-5-nitro benzoate
- iv) Reduction of ethyl-2-ethoxy-5-nitro benzoate to ethyl-2-ethoxy-5-amino benzoate.

i) Nitration of salicylic acid.²⁰

Salicylic acid (10 g) was mixed with 20 cc of HNO_3 (50%). The mixture was stirred for 24 h. and the solid product filtered. The solid was dissolved in hot conc. solution of potassium carbonate so that the solution neutral to litmus contained mono-potassium salts. The less soluble salt of 3-nitro acid separated as pale yellow needles. The mother liquor was rendered alkaline by strong potassium hydroxide solution so that the dipotassium salts separated from it.

The salts were filtered, acidified and recrystallized from water to give 5-nitro salicylic acid; 4 g (40%), m.p. 228°C .

ii) Esterification of 5-nitro salicylate²⁰

5-Nitro salicylate (4 g) was dissolved in absolute alcohol (20 ml) and dry hydrochloric acid gas was passed for 2 h. and the solution was refluxed for a period of 5 h. On cooling, the ester separated as long slender needles; m.p. 102°C , yield, quantitative.

iii) Preparation of ethyl-2-ethoxy-5-nitro benzoate.²¹

0.01 mol (2.1 g) of ethyl-5-nitro salicylate, 0.01 mol (1.6 g) of diethyl sulphate, 0.2 mol (2.7 g) of potassium carbonate and 25 ml of dry acetone were refluxed in water bath for 30 h. Acetone was then removed by distillation and the residue filtered, washed with 5% sodium hydroxide and then with water. Solid was dried and crystallized from ethanol. Yield 85%, m.p. 88-89°C.

iv) Preparation of ethyl-2-ethoxy-5-aminobenzoate

0.01 mol of ethyl-2-ethoxy-5-nitro benzoate was reduced under hydrogen pressure (45 psi) in presence of 10% Pd/C for 4 h, the catalyst was filtered, solvent evaporated and the crude was distilled to give ethyl-2-ethoxy-5-aminobenzoate in 50% yield, b.p.₁₂ 210-212°C.²¹

e) 2-Carbomethoxy-4-amino-diphenylsulfide

i) Preparation of 2-chloro-5-nitrobenzoic acid

ii) Condensation of 2-chloro-5-nitrobenzoic acid with

thiophenol to obtain 2-carboxy-4-nitro diphenylsulfide

iii) Esterification of the acid

iv) Preparation of 2-carbomethoxy-4-amino diphenylsulfide

i) Preparation of 2-chloro-5-nitrobenzoic acid²²

Dry o-chlorobenzoic acid (15.6 g) was dissolved in conc. sulfuric acid (65 ml) with stirring and a mixed acid containing fuming nitric acid (5 ml) and concentrated sulfuric acid (10 ml) was added in portions with stirring. The temperature

was maintained below 50°C . The reaction mixture was then allowed to stand for about 15 min. and then warmed to $90\text{-}95^{\circ}\text{C}$ in an oil bath. The reaction mixture was maintained at this temperature with occasional stirring for 15 min. It was then cooled to room temperature and poured onto about 250g of ice. The pale yellow granular precipitates obtained was collected under suction, washed thoroughly with chilled water and sucked dry. The product was recrystallized from a mixture of 60 ml alcohol and 225 ml water. Yield: 15.8 g (78.5%), m.p. $164\text{-}65^{\circ}\text{C}$.

ii) Preparation of 2-carboxy-4-nitro-diphenylsulfide²⁴

To a stirred solution of potassium carbonate (anhyd.) (60 g) in 120 ml water was added thiophenol (24.8 g, 0.225 mol) and 80 ml methanol. The mixture was heated to reflux and a solution of 2-chloro-5-nitrobenzoic acid (40.2 g, 0.2 mol) in methanol (100 ml) was added dropwise during 10-15 min. The reaction mixture was then refluxed for 9-10 h. The methanol was then distilled off. The aqueous layer was diluted to about 600 ml with water and clarified with activated carbon in hot and filtered. The clear filtrate was gradually acidified to Congo red in hot with conc. hydrochloric acid and the pale yellow granular precipitate was allowed to settle. It was cooled to room temperature, collected, washed with water and dried; m.p. $224\text{-}25^{\circ}\text{C}$; yield 50 g (90%).

iii) 2-Carbomethoxy-4-nitro diphenylsulfide

The acid was esterified using diazomethane in ether: methanol (1:1) to get the methyl ester which was recrystallized from ethanol to give 2-carbomethoxy-4-nitro diphenylsulfide in quantitative yield, m.p. 156-58°C, IR (Nujol): 1720, 1600, and 1575 cm^{-1} ; PMR (CDCl_3): 4.0 (s, 3H, COOCH_3), 6.7 (d, 1H, Aromatic), 7.7 (s, 5H, SPh), 8.0 (dd, 1H, Aromatic), 9.0 (d, 1H, Aromatic).

iv) Preparation of 2-carbomethoxy-4-amino diphenylsulfide

The nitro compound (0.01 mol) was reduced under hydrogen pressure (45 psi) in presence of 10% Pd/C (5%) in 25 ml ethanol for 3-4 h. The catalyst filtered, solvent evaporated to give the amine in 80% yield as oil; IR (Nujol): 3420, 3340, 3220, 1740, 1640 and 1600 cm^{-1} ; PMR (CDCl_3): 4.0 (s, 3H, COOCH_3), 6.9 (d, 1H, Ar), 8 (dd, 1H, Ar), 8.9 (d, 1H, Ar), 7.6 (s, 5H, S-Ph).

f) 2-Carbomethoxy-4-amino-diphenylsulfone

This involves the following steps:

- i) Oxidation of 2-carboxy-4-nitro diphenylsulfide to sulfone
 - ii) Reduction to 2-carboxy-4-amino diphenylsulfone
 - iii) Esterification to 2-carbomethoxy-4-amino diphenylsulfone.
- i) Oxidation of 2-carboxy-4-nitro diphenylsulfide to sulfone:
2-Carboxy-4-nitro diphenylsulfide (0.01 mol) (prepared

by earlier method) was dissolved in minimum quantity of glacial acetic acid in hot, and excess of 30% hydrogen peroxide was added so as to maintain a gentle reflux. The reaction mixture was occasionally stirred till the reaction subsided. The initial orange colour of the solution gradually disappeared as the oxidation progressed and at the end of the reaction, the reaction mixture became almost colourless or very faint yellow. It was then refluxed for further 10-15 min. and left overnight at room temperature. The reaction mixture was poured in chilled water. The solution became milky on stirring. It was kept aside in refrigerator for crystallization. The diphenylsulfone was obtained as colourless needles. The product was recrystallized from dilute acetic acid. Yield of 2-carboxy-4-nitro diphenylsulfone was 24.0 g (80% of theory) [dil. acetic acid]; m.p. 157°C. Anal. Calcd. for C, 50.8; H, 2.93; N, 4.56
Found: C, 50.8; H, 2.8; N, 4.65.

ii) Reduction with zinc dust

7.0 g of 2-carboxy-4-nitro diphenylsulfone was neutralized with 1.4 g of sodium carbonate in 20 ml water. The excess alkali was neutralized with 2.5 ml of 40% acetic acid. This was then added dropwise to a well stirred suspension of activated zinc dust in 75 ml of water and 1 ml of 40% acetic acid. The addition was completed in 1.5 h. and stirring and boiling continued for further 2 h. The mixture was then made alkaline by addition of 1.4 g of

sodium carbonate. The slurry was filtered hot and the cake was washed with hot water. The combined filtrate was then clarified with activated carbon, filtered and concentrated to about 50 ml. The title compound precipitated out by acidification with dil. HCl or acetic acid to pH 3.4 under chilling. The precipitates (initially pasty) became granular on stirring. It was recrystallized from aq. methanol. Yield 72%; m.p.⁸ 189-90°C.

iii) Esterification to 2-carbomethoxy-4-amino diphenylsulfone
 2-Carboxy-4-amino diphenylsulfone was esterified using diazomethane by the general method as was used for the 2-carbomethoxy-4-nitro diphenylsulfide; yield 80%; m.p. 142°C; IR: 3420, 1720, 1630, 1600 and 1160 cm^{-1} ; PMR (CDCl_3) 3.7 (s, 3H, COOCH_3), 2.8 [b(s), 2H, NH_2 , D_2O exchangeable], 6.6, 7.3-8.0 (m, 8H, Aromatic).

g) Preparation of 4-[2-acetoxy-3-diethylaminopropoxy]-aniline

This involves the following steps:

- i) Preparation of 1,2-epoxy-3-(p-nitro phenoxy) propane¹³
- ii) Reaction of N,N'-diethylamine with 1,2-epoxy-3 (p-nitrophenoxy) propane¹⁴
- iii) Acetylation of 4-[2-hydroxy-3-diethylamino propoxy]-nitrobenzene.
- iv) Reduction of the nitro compound to the corresponding amine.

i) Preparation of 1,2-epoxy-3-(p-nitrophenoxy) propane¹³

1 mol of p-nitrophenol was dissolved in 5% (1.2 mol) of sodium hydroxide solution and was treated with 1-chloro-2,3-propylene oxide (1.5 mol) at 20°C and the reaction mixture was stirred for 20-24 h. The solution was concentrated and the product was taken in ethylacetate and washed with 10% sodium hydroxide solution and then with water. The solvent was dried over anhydrous sodium sulphate, evaporated and recrystallized from isopropanol to afford the epoxy compound in 80% yield; m.p. 68°C (Reported m.p. 65-70°C).

ii) Reaction of N,N'-diethylamine with 1,2-epoxy-3-(p-nitrophenoxy) propane¹⁴

5 mmol of the epoxy compound was refluxed with N,N-diethylamine (5.5 mmol) for 2 h. and the reaction mixture was taken in ethylacetate and washed several times with water. Solvent dried over anhydrous sodium sulphate and evaporated to yield 4-[2-hydroxy, 3-N,N-diethylamino propoxy]-nitrobenzene in quantitative yields.

IR (CHCl₃): 3400, 1600 cm⁻¹; PMR (CDCl₃): 1.0 (t, 6H, N-(CH₂ CH₃)₂), 2.6 [m, 6H, CH₂-N(CH₂CH₃)₂], 3.5 [b(s), 1H, OH, D₂O, exchangeable], 4.2 (m, 3H, OCH₂, CHOH), 6.9 & 8.1 (2d, 4H, Aromatic).

iii) Acetylation of 4-[2-hydroxy-3-diethylaminopropoxy] nitrobenzene

10 mmol of 4-[2-hydroxy-3-N,N-diethylaminopropoxy]-nitrobenzene was refluxed with acetic anhydride (15 mmol) for 2 h. The reaction mixture was cooled and neutralized

with ammonia solution and extracted with ether. The solvent on drying and evaporating gave the acetate derivative

4-[2-acetoxy-3-N,N-diethylaminopropoxy]-nitrobenzene in 80% yield. IR (CHCl₃): 1740 and 1600 cm⁻¹. PMR (CDCl₃):

1.0 (t, 6H, N-CH₂-CH₃), 2.0 (s, 3H, COCH₃), 2.5 (m, 6H, CH₂-N(CH₂-CH₃)₂), 4.2 (dd, 2H, OCH₂), 5.1 (m, 1H, CH-O-C(=O)-CH₃), 7.0 & 8.0 (2d, 4H, Aromatic).

iv) Reduction of the nitro compound to the corresponding amine

4-[2-Acetoxy-3-diethylaminopropoxy] aniline was prepared by the reduction of 4-[2-acetoxy-3-diethylaminopropoxy]nitrobenzene with 10% Pd/C in ethanol at 40 psi for 4 h. The solution filtered, solvent evaporated under vacuum and column chromatographed over silica gel (chloroform : methanol, 9:1) to afford the amine in 40% yield.

IR (CHCl₃): 3200, 1740, and 1600 cm⁻¹. PMR (CDCl₃) 1.05 (t, 6H, NCH₂CH₃), 2.1 (s, 3H, C(=O)-CH₃), 2.7 (m, 6H, CH₂-N(CH₂)₂), 3.3 [b(s), 2H, NH₂, D₂O exchangeable], 5.2 (m, 1H, -CH-O-C(=O)-CH₃), 6.75 (m, 4H, Aromatic).

h) 4-[2-Hydroxy-3-diethylaminopropoxy] aniline

This was prepared in the same manner as described above by the reduction of 4-[2-hydroxy-3-diethylaminopropoxy]-nitrobenzene in 90% yield; b.p. 125°/0.8 mm. IR (CHCl₃): 3400 and 1605 cm⁻¹; PMR (CDCl₃): 1.0 (t, 6H, (CH₂CH₃)₂), 2.3 (m, 6H, CH₂-N(CH₂-CH₃)₂), 3.5 [b(s), 3H, NH₂, OH, D₂O exchangeable], 3.9 (m, 3H, O-CH₂-CH-OH), 6.6 (m, 4H, Aromatic).

2. PREPARATION OF ARYL ISOTHIOCYANATES:

a) p-n-Butoxyphenyl isothiocyanate

This is described in the Experimental Section 2.

b) p-N,N-Dimethylaminophenyl isothiocyanate

To p-aminodimethylaniline (0.1 mol) in 25 ml of carbondisulphide was added triethylamine (0.1 mol) and refrigerated overnight. Carbondisulphide was removed under vacuo and the reaction mixture was taken in 25 ml chloroform and triethylamine (0.1 mol) was added. It was cooled to 0°C and ethyl chloroformate (0.1 mol) was added over a period of 2 h. with stirring. The chloroform extract was washed several times with water, dried over anhydrous sodium sulphate and evaporated to give the isothiocyanate in 60% yield, m.p. 68-70°.

c) 4-[2-Acetoxy,3-diethylaminopropoxy]phenyl isothiocyanate

To a solution of 4-(2-acetoxy,3-diethylaminopropoxy) aniline (10 mmol) in 25 ml carbondisulphide was added triethylamine (10 mmol) and the reaction mixture was refrigerated overnight. The solvent was removed under vacuum, and the solution was taken in 25 ml of chloroform and to it was added 10 mmol of triethylamine. It was cooled to 0°C and ethyl chloroformate (10 mmol) was added dropwise to the stirred solution. The reaction mixture was allowed to attain room temperature and was stirred for a period of 3 h, washed several times with water and the

solvent evaporated. The crude oil was column chromatographed on silica gel (chloroform : MeOH, 9:1) to afford the isothiocyanate in 75% yield. IR (CHCl₃): 2100, 1740, 1600, 1585 and 1470 cm⁻¹. PMR (CDCl₃), 1.0 (t, 6H, NCH₂CH₃), 2.0 (s, 3H, O-CO-CH₃), 2.6 (m, 6H, CH₂-N(CH₂)₂), 4.0 (dd, 2H, OCH₂), 5.1 (m, 1H, CH OAc), 7.0 (q, 4H, Aromatic).

Anal. Calcd. for C₁₆H₂₂N₂O₃S: C, 60.7; H, 6.9; N, 8.8

Found: C, 60.5; H, 7.2; N, 9.0.

3. CONDENSATION OF ARYL ISOTHIOCYANATES WITH SUBSTITUTED ANILINES

a) Preparation of 1'-[p-n-butoxyphenyl]-3'-[4-(2''-hydroxy-3''-diethylamino-1''-propoxy)phenyl]-2''-thiourea

10 mmol of p-n-butoxyphenyl isothiocyanate was stirred with 10 mmol of 4-(2-acetoxy-3-diethylaminopropoxy)aniline in 10 ml of dry acetonitrile for 3 h. Solvent was evaporated and the mixture was column chromatographed on silica gel (chloroform : acetone, 9:1) to give the desired acetoxy thiourea. Yield 50%; m.p. 119°C; IR (Nujol): 3270, 1740, 1600, 1470, 1250 and 1180 cm⁻¹; PMR (CDCl₃): 1.0 (t, 9H, CH₂CH₃), 1.1 - 2 (m, 4H, OCH₂CH₂), 2.1 (s, 3H, COCH₃), 2.8 (m, 6H, CH₂N(CH₂)₂CH₃)₂), 3.9 (t, 2H, OCH₂Pr), 4.11 (dd, 2H, OCH₂-CH-OAc), 5.1 (m, 1H, CH OAc), 6.9 & 7.2 (2 dd, 8H, Aromatic), 7.7 [b(s), 2H, NH-C^S-NH, D₂O exchangeable]

The acetate was stirred with 1 equivalent of potassium carbonate in 10 ml methanol for 30 min., filtered, solvent evaporated and mixture poured over water. The solid separated

was crystallized from benzene : pet ether to afford 1'-[p-n-butoxyphenyl]-3'-[4-(2''-hydroxy-3''-diethylamino-1''-propoxy)-2'-thiourea in quantitative yields; m.p. 109°; IR (Nujol): 3280, 1610, 1550, 1470, 1250 and 1190 cm^{-1} ; PMR (CDCl_3): 1.05 (t, 9H, CH_2CH_3), 1.2-1.9 (m, 4H, OBU), 3.6 (m, 7H, $\text{CH}_2\text{N}(\text{CH}_2\text{CH}_3)_2$, OH, D_2O exchangeable), 3.95 (m, 5H, OCH_2Pr , OCH_2CHOH , CH-OH), 6.75 - 7.35 (m, 8H, Aromatic), 7.5 [b(s), 2H, $\text{NH}-\overset{\text{S}}{\text{C}}-\text{NH}$].

Anal. Calcd. for $\text{C}_{24}\text{H}_{35}\text{N}_3\text{O}_3\text{S}$: C, 64.7; H, 7.8; N, 7.52.
 Found: C, 65.1; H, 8.04; N, 7.85.

b) Preparation of 1'-[p-N,N-dimethylaminophenyl]-3'-[4-(2''-hydroxy-3''-diethylamino-1''-propoxy)phenyl]-2'-thiourea

3 mmol of p-N,N-dimethylaminophenyl isothiocyanate was stirred with 3 mmol of 4-(2'-acetoxy,3'-N,N-diethylamino propoxy) aniline in 5 ml of dry acetonitrile for 3 h. Solvent was evaporated and the mixture was column chromatographed on silica gel (chloroform : acetone, 8:2) to give the 1'-[p-N,N-dimethylaminophenyl]-3'-[4-(2''-acetoxy-3''-diethylamino-1''-propoxy) phenyl]-2'-thiourea; m.p. 110°C; yield 40%; IR (Nujol): 1740, 1620, 1530, 1350 and 1250 cm^{-1} . PMR (CDCl_3): 1.0 (t, 6H, CH_2CH_3), 2.1 (s, 3H, O-CO CH_3), 2.6 (m, 6H, $\text{CH}_2-\text{N}(\text{CH}_2\text{CH}_3)_2$), 3.0 (s, 6H, $\text{N}(\text{CH}_3)_2$), 4.1 (dd, 2H, OCH_2), 5.1 (m, 1H, CHOAc), 6.6 - 7.3 (m, 8H, Aromatic), 7.4 (d, 2H, $\text{NH}-\overset{\text{S}}{\text{C}}-\text{NH}$, D_2O exchangeable).

The acetate was stirred with 1 equivalent of potassium carbonate in 10 ml methanol for 1 hr. The solution was filtered, solvent evaporated and reaction mixture was poured in water. The oil was extracted with ethyl acetate, dried over anhydrous sodium sulphate and solvent was evaporated to give 1'-[p-N,N-dimethylaminophenyl]-3'-[4-(2''-hydroxy-3''-diethylamino-1''-propoxy) phenyl-2'-thiourea in quantitative yields. IR (CHCl₃): 3300(b), 1620, 1520, 1350, 1250 and 1180 cm⁻¹. PMR (CDCl₃): 1.2 (t, 6H, CH₂CH₃), 2.85 (m, 6H, CH₂N-(CH₂CH₃)₂), 3.0 (s, 6H, N(CH₃)₂), 3.2 [b(s), 1H, OH, D₂O exchangeable], 4.0 (m, 3H, OCH₂, CHOH), 6.6 - 7.3 (m, 8H, Aromatic), 7.4 (d, 2H, NH-C^S-NH, D₂O exchangeable).
 Anal. Calcd. for C₂₂H₃₂N₄O₂S: C, 63.4; H, 7.7; N, 13.4.
 Found: C, 62.7; H, 8.0; N, 13.0.

c) 1'-3'-bis[4-(2''-hydroxy-3''-diethylamino-1''-propoxy) diphenyl]-thiourea

10 mmol of p-(2-acetoxy-3-N,N-diethylaminopropoxy) aniline was stirred with 10 mmol of p-(2-acetoxy-3-N,N-diethylaminopropoxy) phenyl isothiocyanate in 10 ml acetonitrile for 4 h. Solvent evaporated and the mixture was column chromatographed on silica gel (chloroform: methanol, 9:1) to give 1'-3'-bis[4-(2''-acetoxy-3''-diethylamino-1''-propoxy) diphenyl] thiourea. Yield 45%; IR (CHCl₃): 1730, 1600, 1510, 1470, 1400 and 1250 cm⁻¹; PMR (CDCl₃): 1.0 (t, 12H, CH₂CH₃), 2 (s, 6H, COCH₃), 2.6 (m, 12H, CH₂-N(CH₂CH₃)₂), 4.1 (m, 4H, OCH₂), 5.1 (m, 2H, CHOH), 6.9 (d, 4H, Aromatic), 7.6 [b(s), 4H, NH-C^S-NH, D₂O exchangeable].

The acetate was stirred with 1 equivalent of potassium carbonate in 10 ml methanol for 1 h. The solution was filtered, solvent evaporated and reaction mixture was poured in water. The oil was extracted with ethyl acetate, dried over anhydrous sodium sulphate and solvent evaporated to give 1'-3'-bis[4-(2''-hydroxy-3''-diethylamino-1''-propoxy) diphenyl] thiourea in 80% yield. IR (CHCl₃): 3320(b), 1620, 1520, 1460, 1390, 1350, 1250, and 1180 cm⁻¹.

PMR (CDCl₃): 1.1 (t, 6H, CH₂-CH₃), 2.6 (m, 12H, CH₂ N(CH₂CH₃)₂), 2.2 [b(s), 1H, OH], 4.0 (m, 6H, OCH₂, CHOH), 6.9 & 7.2 (2d, 8H, Aromatic), 7.75 [b(s), 4H, NH-C-NH, D₂O exchangeable].

Anal. Calcd. for C₂₇H₄₂N₄O₄S: C, 62.5; H, 8.1; N, 10.8.

Found: C, 61.9; H, 7.8; N, 11.5.

d) 1'-[8-n-Butoxy-5-quinoly]l-3'-[4-(2''-hydroxy-3''-diethylamino-1''-propoxy)phenyl]-2'-thiourea

3 mmols of 5-amino-8-n-butoxyquinoline was stirred with 3 mmol of p-(2-acetoxy-3-N,N-diethylaminopropoxy) phenyl isothiocyanate in 10 ml tetrahydrofuran at room temperature for 1 h. and then refluxed for one more hour. The solvent evaporated and column chromatographed on silica gel (chloroform:methanol, 9:1) to give 1'-[8-n-butoxy-5-quinoly]l-3'-[4-(2''-acetoxy-3''-diethylamino-1''-propoxy)phenyl]-2'-thiourea as an oil in 30% yield. IR (CHCl₃): 3220(b), 1740, 1610(d), 1520, 1480, 1380, 1240 and 1190 cm⁻¹. PMR (CDCl₃): 1.0 (t, 9H, CH₂CH₃), 1.2-1.9 (m, 4H, OCH₂CH₂), 2.0 (s, 3H, COCH₃) 2.6 (m, 6H, CH₂ N(CH₂CH₃)₂), 4.1 (m, 4H, OCH₂, OCH₂), 5.1

(s, 1H, $\underline{\text{CH}}$ OAc), 6.9 - 7.6 (m, 6H, Aromatic), 8.1 (dd, 2H, quinolylyl), 8.9 (m, 1H, quinolylyl).

The acetate was stirred with 1 equivalent of potassium carbonate in 10 ml methanol for 1 h. The solution was filtered, solvent evaporated and the reaction mixture poured in water. The oil was extracted with ethyl acetate, dried over anhydrous sodium sulphate and solvent evaporated to give 1'-[8-n-butoxy-5-quinolylyl]-3'-[4-(2''-hydroxy-3''-diethyl-amino-1''-propoxy)phenyl]-2'-thiourea in quantitative yield. M.P. 76-78°C; IR (Nujol): 3200(b), 1650, 1600, 1520, 1740, 1400, 1280, 1250 and 1180 cm^{-1} . PMR (CDCl_3): 1.0 (m, 9H, CH_2CH_3), 1.2 - 2.0 (m, 4H, OCH_2 , OCH_2), 2.6 (m, 6H, $\text{CH}_2\text{NCH}_2\text{CH}_3$), 4.0 (m, 5H, OCH_2 , OCH_2 , CHOH), 6.6 - 7.5 (m, 6H, Aromatic), 8.1 (d, 2H, quinolylyl), 8.9 (m, 1H, quinolylyl).

Anal. Calcd. for $\text{C}_{27}\text{H}_{36}\text{N}_4\text{O}_3\text{S}$: C, 65.3; H, 7.2; N, 11.2
Found: C, 65.1; H, 7.8; N, 11.0

e) 1'-[2-Pyridyl]-3'-[4-2''-hydroxy-3''-diethylamino-1''-propoxy)phenyl]-2'-thiourea

1.5 mmol of 2-aminopyridine was refluxed with 1.5 mmol of p-(2-acetoxy-3-N,N-diethylaminopropoxy)phenyl isothiocyanate in 10 ml tetrahydrofuran for 5 h. The solvent was evaporated and the mixture column chromatographed on silica gel to afford 1'-[2-pyridyl]-3'-[4-(2''-acetoxy-3''-diethyl-amino-1''-propoxy)phenyl]-2'-thiourea in 30% yield.

IR (CHCl_3): 1740, 1650, 1600, 1440, 1390 and 1220 cm^{-1} .

PMR (CDCl_3): 1.0 (t, 6H, CH_2CH_3), 2.1 (s, 3H, COCH_3), 2.6 (m, 6H,

$\text{CH}_2 \text{N}(\text{CH}_2\text{CH}_3)_2$), 4.0 (m, 2H, OCH_2), 5.1 (m, 1H, CH OAc), 6.5 - 8.5 (m, 8H, Aromatic), 8.9 [b(s), 2H, $\text{NH}-\overset{\text{S}}{\underset{\text{H}}{\text{C}}}-\text{NH}$, D_2O exchangeable).

The acetate was stirred with 1 equivalent of potassium carbonate in 10 ml methanol for 1 h. The solution was filtered, solvent evaporated and extracted with ethyl acetate which on drying over anhydrous sodium sulphate and evaporation gave 1'-[2-pyridyl]-3'-[4-(2''-hydroxy-3''-diethylamino-1''-propoxy)phenyl]-2'-thiourea in 90% yield. IR (CHCl_3):

3300(b), 1650, 1600, 1440, 1390 and 1220 cm^{-1} . PMR (CDCl_3):

1.1 (t, 6H, CH_2CH_3), 2.5 (bs, 1H, OH, D_2O exchangeable), 2.8 (m, 6H, $\text{CH}_2\text{N}(\text{CH}_2\text{CH}_3)_2$), 4.1 (m, 3H, OCH_2 , CHOH), 6.5-8.6 (m, 8H, Aromatic).

Anal. Calcd. for $\text{C}_{19}\text{H}_{26}\text{N}_4\text{O}_2\text{S}$: C, 60.9; H, 6.9; N, 14.9

Found: C, 61.2; H, 7.0; N, 14.0

f) 1'-[m-Carbethoxy-p-ethoxyphenyl]-3'-[4-(2''-hydroxy-3''-diethylamino-1''-propoxy)phenyl]-2'-thiourea

5 mmol of ethyl-2-ethoxy-5-aminobenzoate was stirred with 5 mmol of p-(2-acetoxy-3-N,N-diethylaminopropoxy)phenyl isothiocyanate in 25 ml dioxan at 60°C for 6 h. The solvent was removed under vacuo and the mixture column chromatographed on silica gel (benzene : acetone, 9:1) to afford 1'-(m-carbethoxy-p-ethoxyphenyl)-3'-[4-(2''-acetoxy-3''-diethylamino-1''-propoxy)phenyl]-2'-thiourea in 50% yield as an oil. IR (CHCl_3): 3300(b), 1740, 1600, 1510, 1480, 1430, 1370, 1300 and 1250 cm^{-1} . PMR (CDCl_3): 1.0 (t, 6H,

NCH₂-CH₃), 1.2 (tt, 6H, COOCH₂CH₃, O-CH₂-CH₃), 2.0 (s, 3H, COCH₃), 2.6 (m, 6H, CH₂ N(CH₂CH₃)₂), 4.0 (m, 6H, COOCH₂CH₃, OCH₂CH₃, OCH₂-), 5.1 (s, 1H, CH OAc), 6.8-7.8 (m, 7H, Aromatic), 7.9 [b(s), 2H, NH-C-NH, D₂O exchangeable].

The acetate was stirred with 1 equivalent of potassium carbonate in 15 ml methanol for 30 min. at 10°C. The solution was filtered, solvent was evaporated and the reaction mixture was poured in water. The oil was extracted with ethyl acetate, dried over anhydrous sodium sulphate and evaporated to afford 1'-[m-carbethoxy-p-ethoxyphenyl]-3'-[4-(2''-hydroxy-3''-diethylamino-1''-propoxy)phenyl]-2'-thiourea as an oil in 85% yield. IR (CHCl₃): 3250(b), 1720, 1600, 1510, 1480, 1390, 1300 and 1250 cm⁻¹. PMR (CDCl₃): 1.0 (t, 6H, NCH₂CH₃), 1.2 (tt, 6H, COOCH₂CH₃, OCH₂CH₃), 2.6 [m, 7H, CH₂ N(CH₂CH₃), OH, D₂O exchangeable], 4.0 (m, 6H, COOCH₂CH₃, OCH₂CH₃, OCH₂-), 6.8-7.8 (m, 7H, Aromatic). Anal. Calcd. for C₂₅H₃₅N₃O₅S: C, 61.3; H, 7.1; N, 8.5 Found: C, 60.9; H, 7.4; N, 9.0.

g) 2'-Carbomethoxy-4'-[4-(2''-hydroxy-3''-diethylamino-1''-propoxy)phenyl thiocarbamido] diphenylsulfide

3.5 mmol of 2-carbomethoxy-4-amino diphenylsulfide was refluxed with 4-(2'-acetoxy-3'-diethylamino-1'-propoxy)phenyl isothiocyanate (1 eq.) in 25 ml THF for 6 h. The mixture was column chromatographed on silica gel (benzene : acetone, 9:1) to afford 2'-carbomethoxy-4'-[4-(2''-acetoxy-3''-diethylamino-1''-propoxy)phenyl thiocarbamido]-diphenylsulfide in 20% yield

as an oil. IR (CHCl₃): 3300, 1740(b); 1600, 1520, 1480, 1450 and 1250 cm⁻¹. PMR (CDCl₃): 1.0 (t, 6H, NCH₂CH₃), 2.0 (s, 3H, COCH₃), 2.6 (m, 6H, CH₂ N(CH₂CH₃)₂), 3.9 (s, 3H, COOCH₃), 4.1 (dd, 2H, OCH₂), 5.1 (m, 1H, $\frac{S}{H}$ COAc), 6.6 - 8 (m, 12H, Aromatic), 8.0 [b(s), 2H, NH-C $\frac{S}{H}$ -NH- D₂O exchangeable).

The acetate was stirred with 1 equivalent of potassium carbonate in 10 ml methanol for 1 h. The solution was filtered, solvent evaporated, extracted with ethyl acetate, washed with water and on drying over anhydrous sodium sulphate and evaporation gave the 2'-carbomethoxy-4'-[4-(2''-hydroxy-3''-diethylamino-1''-propoxy)phenyl thiocarbamido]diphenyl sulphide in quantitative yields. IR (CHCl₃): 3300(b), 1720, 1600, 1510, 1470, 1440, 1300, and 1250 cm⁻¹. PMR (CDCl₃): 1.0 (t, 6H, NCH₂CH₃), 2.6 (m, 6H, CH₂-N-(CH₂CH₃)₂), 3.9 (m, 6H, OCH₂, CH OH, COOCH₃), 6.6 - 7.8 (m, 12H, Aromatic), 8.0 [b(s), 2H, NH-C $\frac{S}{H}$ -NH].

Anal. Calcd. for C₂₈H₃₃N₃O₄S₂: C, 62.3; H, 6.1; N, 7.8
Found: C, 61.9; H, 5.8; N, 7.6.

h) 4-4'-Dibutoxy thiocarbanilide²⁴

10 mmol of p-n-butoxyphenyl isothiocyanate was refluxed with 10 mmol of p-n-butoxy aniline in ethanol (25 ml) for 3 h. The solution was cooled, and the thiourea separated as white solid; m.p. 165°C (lit.²⁴ m.p. 166-67°C); Yield 90%.

i) 4-Butoxy-4'-dimethylamino thiocarbanilide²⁴

10 mmol of p-n-butoxyphenyl isothiocyanate was refluxed

with 10 mmol of p-aminodiemthyl aniline⁵ in ethanol (25 ml) for 4 h. The solution was cooled and the thiourea which separated was filtered and recrystallised from ethanol to afford thiambutasine in 50% yield; m.p. 120°C (lit.²⁴ m.p. 119-21°C).

j) 2'-Carbomethoxy-4'-[p-butoxyphenyl thiocarbamido] diphenyl sulphide

2 mmols of p-n-butoxyphenyl isothiocyanate was refluxed with 2 mmol of 2-carbomethoxy-4-amino diphenylsulfide in 25 ml of ethanol for 3 h. The solvent was removed and the product purified by column chromatography on silica gel (benzene : acetone, 9:1) to give the desired thiourea in 25% yield; m.p. 135-40°C (Dec.); IR (Nujol): 3200, 1710, 1600, 1550, 1510, 1480, 1350, 1300, 1250 and 1180 cm^{-1} . PMR (CDCl_3): 1.0 (t, 3H, $-\text{CH}_3$), 1.1 - 2.5 (m, 4H, $-\text{CH}_2\text{CH}_2-$), 4.0 (m, 5H, $-\text{OCH}_2-$, COOCH_3), 6.5 - 9 (m, 12H, Aromatic).
 Anal. Calcd. for $\text{C}_{25}\text{H}_{26}\text{N}_2\text{O}_3\text{S}_2$: C, 65.2; H, 5.6; N, 6.0
 Found: C, 64.8; H, 5.84; N, 6.2.

k) 2'-Carbomethoxy-4'-[-4-(2''-hydroxy-3''-diethylamino-1''-propoxy)phenyl thiocarbamido] diphenylsulfone

2.18 mmol of 2'-carbomethoxy-4'-amino diphenylsulfone was refluxed with 1 equivalent of p-(2-acetoxy-3-N,N-diethylaminopropoxy)phenyl isothiocyanate in 10 ml dioxan with triethylamine as a catalyst for 18 h. The mixture was column chromatographed on silica gel [benzene : acetone, 9:1) to afford 2'-carbomethoxy-4'-[-4-(2''-acetoxy-3''-diethylamino-

1''-propoxy)phenyl thiocarbamido]-diphenylsulfone in 20% yield as an oil. IR (CHCl₃): 3300, 1740(b), 1600, 1520, 1460, and , 1160 cm⁻¹. PMR (CDCl₃): 1.0 (t, 6H, N-CH₂-CH₃), 1.9 (s, 3H, OCOCH₃), 2.6 (m, 6H, CH₂ N(CH₂CH₃)₂), 3.8 (s, 3H, COOCH₃), 4.0 (dd, 2H, OCH₂), 5.1 (m, 1H, CH OAc), 6.6 - 8 (m, 12H, Aromatic), 8.1]b(s), 2H, NH-C^S-NH, D₂O exchangeable)

The acetate was stirred with 1 equivalent of potassium carbonate in 10 ml methanol for 1 h. The solution was filtered, solvent evaporated, extracted with ethyl acetate, washed with water and on drying over anhydrous sodium sulphate and evaporation gave the 2'-carbomethoxy-4'-[4-(2''-hydroxy-3''-diethylamino-1''-propoxy)phenyl thiocarbamido]diphenylsulfone in quantitative yields. IR (CHCl₃): 3300(b), 1730, 1640, 1600, 1500, 1740, 1300, 1250 and 1160 cm⁻¹. PMR (CDCl₃): 1.1 (t, 6H, NCH₂CH₃), 2.6 (m, 6H, CH₂ N(CH₂CH₃)₂), 3.9 (s, 3H, COOCH₃), 4 (m, 3H, CHOH, OCH₂), 6.6 - 8 (m, 12H, Aromatic).

Anal. Calcd. for C, 58.8; H, 5.7; N, 7.3

Found: C, 58.5; H, 6.0; N, 7.0

4.4.0 REFERENCES

1. Martindale Extra Pharmacopoeia, 28th Edn., p. 1493 and 1584, Pharmaceutical Society of Great Britain Press (London), 1982.
2. M. Hooper and P.G. Purohit
Chemotherapy of Leprosy in "Progr. Med. Chem."
Ed. Ellis G.P. and West G.B., Vol. 20, p.1-81,
Elsevier - North Holland, Amsterdam (1983)
3. R.F. Rekker
The hydrophobic fragmental constant,
Elsevier, Amsterdam (1977).
4. Micheal S. Tule
Principles and Practice of Hansch Analysis in
Advances in Drug Research, Vol. 6, p. 21.
5. M. Hooper and S.N. Kulkarni
Brit. J. Pharmac. 77, 574 (1982).
6. R.D. Dabholkar
Ph.D. Thesis, University of Bombay (1978).
7. David G. Jones and Geo R. Fulton
Brit. Pat. 727,247, March 30, 1955.
8. P.V. Arur
Ph.D. Thesis, University of Poona (1978).
9. K.V. Kale, Ph.D. Thesis, University of Poona (1977).
10. K.S. Nargund, S.G. Nemlekar and P.R. Kadle
Indian Drugs, 23(5), (1986). pg. 253
11. Chizheveskaya II, Idel'chik ZB, Yakimovicin LA
and Shadurshi KS,
Vestsi Akad. Navuk. Belarus, SSR. Ser. Fir. Tekh.
Navuk (1957), 115, CA: 52:90106 (1956).
12. C.F. Huebner, J.L. Marsh, R.H. Mizsoni, R.P. Mull,
P.C. Schroder and H.A. Troxell,
J. Am. Chem. Soc., 75, 2274-5 (1953).
13. Chizhereskaya II, Idel'chick ZB, Yakimovicin LA
and Shaduri KS,
Vestsi Akad. Navuk Belarus, SSR. Ser. Fir Teckh.
Navuk (1957), 115. CA: 52:90106 (1956).

14. Chizheveskaya and V.I. Pansevich-Kolyada,
J. Gen. Chem. USSR, 27, 1305 (1957).
15. J.P. Trivedi and J.J. Trivedi,
J. Ind. Chem. Soc., 35, 657-60 (1958).
16. A.E.S. Fairfull and D.A. Peak,
J. Chem. Soc., 796-802 (1955).
17. David G. Jones and Geo R. Fulton,
Brit. Pat. 727,247; March 30, 1955.
18. M.N. Shchukina and N.V. Savitskaya,
J. Gen. Chem., 22, 1263-69 (1952).
19. G. Tsatsas et al.
Ann. Pharm. Fr., 25(6), 487-92 (1967)
CA 69:2843 (1967).
20. Meldrum A.N. and Hirve N.W.
J. Ind. Chem. Soc., 5, 95-101 (1928).
21. K.S. Nargund, S.G. Nemlekar and P.R. Kadle
Indian Drugs, 23(5) (1986).
22. Lehenstedt
Ber. 64, 2384 (1931).
23. Amstutz and Neumoyer
J. Am. Chem. Soc., 69, 1925 (1947).
24. G.F. Haebner, J.L. Marsh, R.H. Mizzoni, R.P. Mull,
P.C. Schroder, and H.A. Tooxell
J. Am. Chem. Soc., 75, 2274-5 (1953).
25. C.W. Ferry, J.S. Buck and R. Battzly,
Org. Synth. Coll. Vol. 3, p.240.

SECTION 5.0

TESTING FOR ANTITUBERCULOSIS ACTIVITY

This part deals with the in vitro screening of the compounds prepared during the present investigation for antituberculosis activity. Two methods have been used for determining the activity using i) liquid medium, and ii) Agar medium.

(1) In vitro antituberculosis testing can be carried out either in solid or liquid medium. However, the liquid medium is generally preferred because of the ease in observing the presence or absence of growth in the same. Amongst the several liquid media used so far, the one that is universally accepted is Youman's liquid medium [American Review of Tuberculosis, Vol. 55, 529, (1947)].

In the present investigation, the compounds were tested in Youman's liquid medium in the presence of 10% horse serum [Amer. Rev. Tuberc. 61, 407 (1950)].

The purpose of addition of horse serum is to match conditions identical to the in vivo screening of the compounds. The activity of the compound is reported to be drastically reduced in presence of horse serum.

Methods & Materials

Youman's liquid medium has the following composition:

Asparagine (Analar)	0.50 g
KH_2PO_4	0.5 g
K_2SO_4	0.05 g
Glycerol (Reagent grade)	2.00 ml
Magnesium citrate (distilled)	0.15 g

The above constituents were weighed accurately and all constituents except magnesium citrate were dissolved in minimum quantity of distilled water and the pH adjusted to 7.0 with caustic soda. Magnesium citrate was then dissolved in the medium. The volume was then made up to 100 ml with distilled water and filtered through the filter paper. The medium was sterilized by autoclaving at 15 lbs pressure for 10 min. To the sterile medium was added aseptically a sterile normal horse serum inactivated by heating at 56°C for 30 min. to make the final concentration of 10%. The sterile Youman's basal medium containing horse serum (3.9 ml - 4.35 ml to give a final volume of 5 ml) was dispensed in borosilicate test tubes (150 x 20 mm).

Drug Dilution

20 mg of each compound under test was weighed accurately and dissolved in minimum amount of alcohol. The solution/suspension thus prepared was sterilized by autoclaving at 15 lbs pressure for 20 min. Further dilutions were prepared and added to the sterile test medium. The inoculum which was added afterwards consisted of 0.1 ml of standardised

suspension of mycobacterium tuberculosis ($H_{37}Rv$) containing 10^6 viable bacteria/ml.

The highly virulent $H_{37}Rv$ strain of mycobacterium tuberculosis Var-hominis was employed as the test organism, in the present study. The culture was maintained on Lowenstein-Jenson egg medium by subculturing it every month on a new slabt. The strain was also animal passaged in order to retain its virulence. An eight days old culture of the test organism in Youman's liquid medium was used for the inoculation of the test drug solution. Before inoculation, the culture suspension was adjusted to Brown's opacity tube (10^6 bacilli per ml) and 0.1 ml of the standardised solution was surface inoculated to the drug dilution aseptically.

Incubation

The test tubes were incubated without shaking at 37° in an incubator. Pellicular growth usually begins to appear on the surface of the medium after 7 days of inoculation. The tubes were incubated for 21 days. For each experiment, a control tube with the diluent and without any drug was similarly tested to see that it did not affect the growth at the concentration used. The tubes were examined for the presence or absence of growth of organism. This was done by comparing with the control tube which shows good pellicular growth. The absence of growth indicates the

inhibition. The drug that completely inhibited the growth of the test organism at minimal concentrations (0.5 mg/ml) was further tested at lower concentration. Control tubes with (INH) isonicotinic acid hydrazide paraaminosalicylic acid (PAS) and streptomycin were kept for comparison. Under these experimental conditions, INH, PAS and streptomycin inhibited the growth at concentration of 0.04 mg, 0.4 mg, and 1 mcg/ml, respectively.

The results are presented on the minimum inhibitory concentration in mcg/ml of compounds described in Section 4 in Tables I & II below. Activity when the above side chain is replaced by O-Bu is given in parenthesis.

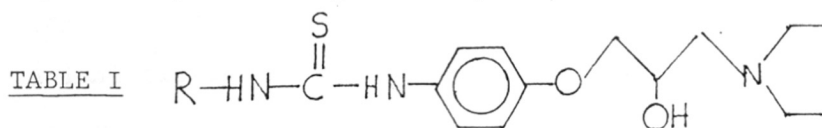

1'-[4 (2''-Hydroxy-3''-diethylamino-1''-propoxy)phenyl-3'-substituted-2'-thioureas.

Sr.No.	R	Minimum inhibitory concentration (mcg/ml)	
1.	p-n-Butoxyphenyl	3.125	(0.78)
2.	p-N,N-Dimethylaminophenyl	25	(6.25) (3.125)
3.	4-(2'-Hydroxy-3'-diethylamino-1'-propoxy)phenyl - -	3.125	(3.125)
4.	2-Pyridyl	12.5	(0.02)
5.	8-n-Butoxy-5-quinolyl	25	(0.2)
6.	3-Carboethoxy,4-ethoxyphenyl	50	(1)
7.	(3-Carbomethoxy-4-thio phenyl) phenyl	3.12	(3.12)
8.	(3-Carbomethoxy-4-sulfonylphenyl) phenyl	3.12	(3.12)

submitted for activity

TABLE II

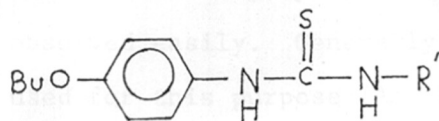

4',4'-Disubstituted thioureas

Sr.No.	R	R	Minimum Inhibitory Concentration
1.	o-Butoxy	o-p-(n)-Butoxyphenyl	0.78
2.	o-Butoxy	p-N,N,-Dimethylamino-phenyl	3.12
3.	o-Butoxy	(3-Carbomethoxy-4-thiophenyl)phenyl	3.12

(2) Each compound, synthesised is a foreign body for animal tissues so that these may develop an acute and chronic toxicity in the body and the patient may divert from the cure. To avoid it, an optimum quantity of the drug in the form of dosages will be given, which is not toxic, or some other groups are substituted in the compound synthesised which may reduce its toxicity to a greater extent and human body will easily accept it.

In vitro Screening

This involves the determination of the minimum inhibitory concentration (MIC) of the compound synthesised which is effective against a particular mycobacterium. The species to be used for this will be *M. tuberculosis* H₃₇Rv which is a pathogenic mycobacterium. In vitro testing can be carried out either in solid or liquid medium. If liquid medium is

used for testing, presence or absence of growth can be observed easily. Generally Youman's liquid medium is used for this purpose [Am. Rev. Tuberc., 55, 529 (1947)].

In the present investigation, the compounds synthesised in Sections 2 & 3 have been sent for testing for antitubercular activity through Prof. M. Hooper, Sunderland Polytechnic, U.K. to Mr. M. Yates, Regional Tuberculosis Unit, East Dulwich Hospital, Melbourne Grove, London.

In the present investigation, the compounds were tested by using the following test method:

Middle Brook's 7H-11 Agar

Ammonium sulphate	0.5 g
L-Glutamic acid (sodium salt)	0.5 g
Sodium citrate Na_3 citrate $2\text{H}_2\text{O}$	0.4 g
Disodium phosphate Na_2HPO_4	1.5 g
Potassium dihydrogen phosphate $\text{K H}_2\text{PO}_4$	1.5 g
Glycerol	5.0 ml
Ferric ammonium citrate	0.04 g
Magnesium sulphate $\text{MgSO}_4 \cdot 7\text{H}_2\text{O}$	0.05 g
Pyroidoxine hydrochloride	0.001 g
Biotin	0.0005 g
Malachite green	0.001 g
Agar powder (Difco)	15.0 g

The trace substances were conveniently prepared as stock solutions. First, dissolve the chemicals and then add and dissolve the agar powder; the medium can then be distributed in 90 ml volumes and autoclaved at 121°C for 15 min. For use, the agar is melted and cooled to 50°C before adding 10 ml of

oleic acid-albumin-dextrose complex and 0.3 ml catalase solution. The poured plates should be kept away from daylight as much as possible as it has a deleterious effect on the medium and may prevent growth of mycobacteria.

Oleic Acid-Albumin-Dextrose Complex

Oleic acid	0.5 g
Bovine albumin fraction V	50.0 g
Dextrose	20.0 g
Sodium chloride	8.5 g
Distilled water	1000 ml

Dissolve the dextrose and bovine in saline. Add the oleic acid to N/20 NaOH and then mix both solutions together. Filter through a Seitz filter and store at 4°C. In 7H-10 medium used for capreomycin sensitivity testing, 10% sterile horse serum can be substituted for the oleic acid dextrose complex.

Catalase Solution

Crude catalase (beef liver)	1.0 g
Distilled water	1000 ml

Dissolve and filter through a membrane filter, bottle and store at 4°C.

Solutions of the drugs in either weak alkali, methanol or DMSO and after dilution to the stated concentration (ug/ml) 1 ml was added to 9 ml of the enriched medium and

and dispensed in 2 ml quantities into bottle which were then capped set at an angle to solidify.

Innoculation was by the method developed in the Department at Dulwich by Yates, Grange and Collins. 5-10 ul of fine suspension of mycobacteria was used. The plates were ready after 1,2,3 week for fast growing organisms and 2,3 weeks for slow growing microorganisms.

SLOW GROWERS: M. tuberculosis; M. bovis; M. xenopi;
M. avium-intracellulare; M. kansasii;
M. malmoensi

FAST GROWERS: M. fortuitum; M. chelonae; Nocardia spp.

Testing

A method has been developed at Dulwich Laboratory for screening many bacterias at a time. The method consists of preparing the agar medium of a particular concentration in petridishes. Several such dishes can be made with different concentrations. A fine suspension of different bacterias are put on this petri dishes, just like TLC spots and allowed to grow. The amount of bacteria injection is generally done by automatic injector and is well adjusted by the person who knows the art.

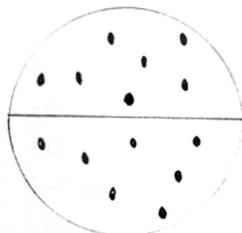

The growth is visually observed after 1-2 weeks for fast growing bacterias and 2,3 or 4 weeks for slow growing bacterias. The concentration generally used are 0.1, 1, 10, 25, 50 and 100 g/ml. Later MICs are determined. This is a very fast method compared to the broth method and allows to test large number of bacterias at a time for a particular concentration.

The activities of the compounds have been tabulated in the Tables III & IV below:

TABLE III

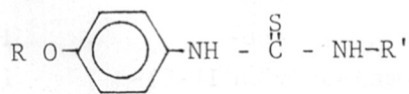

<u>Sr.No.</u>	<u>R</u>	<u>R'</u>	<u>Activity</u> <i>ug/ml</i>
1.	Butyl	Acetic acid	~ 10
2.	Amyl	-do-	1-10
3.	Hexyl	-do-	1-10
4.	Butyl	4-Phenyl acetic acid	10 - 100
5.	Amyl	-do-	~ 10
6.	Hexyl	-do-	~ 10
7.	Butyl	Lysyl	~ 10
8.	Amyl	-do-	1-10
9.	Hexyl	-do-	1-10
10.	Butyl	5-Uracil	
11.	Amyl	-do-	
12.	Hexyl	-do-	
13.	Butyl	6-Penicillanic acid	~ 10
14.	Amyl	-do-	1-10
15.	Hexyl	-do-	1-10

TABLE III (contd...)

<u>Sr.No.</u>	<u>R</u>	<u>R'</u>	<u>Acitivity</u>
16.	Butyl	-(6-[Phenylacetamido]) penicillanic acid	
17.	Amyl	-do-	
18.	Hexyl	-do-	
19.	Butyl	-(6-[p-Hydroxyphenyl acetamido])pencillanic acid.	
20.	Amyl	-do-	
21.	Hexyl	-do-	
22.	Butyl	7-Desacetoxy cephalo- sporic acid	
23.	Amyl	-do-	
24.	Hexyl	-do-	
25.	Butyl	-(7-[Phenylacetamido]) des acetoxy cephalo- sporic acid	
26.	Amyl	-do-	
27.	Hexyl	-do-	

TABLE IV

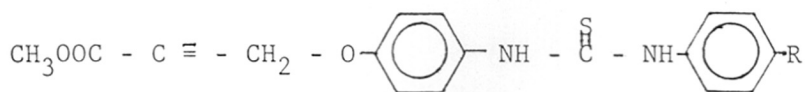

<u>Sr.No.</u>	<u>R</u>	<u>Activity</u>
1.	H	} <i>Inactive.</i>
2.	CH ₃	
3.	OCH ₃	
4.	Cl	
5.	3,4 Cl ₂	

TABLE IV (contd...)

<u>Sr.No.</u>	<u>R</u>	<u>Activity</u>
6.	NO ₂	} <u>Inactive</u>
7.	CH ₂ CH ₃	
8.	CN	
9.	O-C ₄ H ₉	<u>Active</u> against <u>M. bovis</u> below 10 <u>ug/ml</u>
10.	SO ₂ Me	} <u>Inactive</u>
11.	NH COCH ₃	
12.	NH SO ₂ Me	
13.	CONHCH ₃	
14.	CH ₂ OMe	
15.	O-CH ₂ -C=C-COOMe	

DISCUSSION OF THE RESULTS

SECTION II- These are tested in agar medium and given the activity in four different concentrations of 0.1, 1.0, 10 and 100 $\mu\text{g/ml}$. These are therefore expressed as a range between the above concentration. A separate study will be made for the actual MIC later. Out of 27 compounds, 12 compounds' results are available at the moment and 15 are still awaited. The results are very promising and compare very well with the known drugs in agar medium, according to Mr. M. Yates of Dulwich Hospital, London. A complete analysis will be made when all the results are available. In vivo studies will be undertaken for selected few. In general the results are very promising.

SECTION III: In all 15 compounds are screened for activity in agar medium. None of them are active which is unfortunate since we have planned the synthesis of these compounds for QSAR analysis. The reason advanced is that these compounds react with the medium and therefore reduces the effective concentration of the drug. It is now advised that side chain should be prepared containing skipped acetylenes $-\text{O}-\text{CH}_2-\text{C}\equiv\text{C}-\text{CH}_2-\text{COOMe}$. This work is now in progress.

SECTION IV: These compounds have been tested at Haffkine Institute, Bombay.

Before the discussion of the results it must be mentioned that the antituberculosis activity reported here are not done in one lot and some of the results reported are from the literature. However the activity reported here and also that from the literature depends on the particular strains used at that time. Nevertheless it gives some idea about activity in regard to the introduction of 3-diethylamino-2-hydroxypropoxy chain in place of n-butoxy chain.

Compounds 1,3,7 and (Table 1) shows good activity (3.12 $\mu\text{g}/\text{ml}$) compared to thiambutisine which has also the same activity. Compound 1 table 2 which contains butoxy group in both the phenyl ring has activity of 0.78 $\mu\text{g}/\text{ml}$. Replacement of one butoxy group of this compound by 3-diethylamino-2-hydroxypropoxy chain has reduced the activity to 3.125 $\mu\text{g}/\text{ml}$ but nevertheless is equal to that of thiambutisine. Compound 2 where butoxy of thiambutisine is replaced by the present chain showed considerable reduced in activity. This data requires further checking. In case of compound 5 and 6 having heterocyclic moiety, the introduction of the present chain in place of butoxy has reduced the activity considerably. Although our results indicate mixed trend, compound 3 (table 1) having the present chain in both the phenyl nucleus and having the same activity as that of thiambutisine is a compound of choice (3.125 $\mu\text{g}/\text{ml}$). A further study on the calculated log P value is ^{found to be} very favourable as seen from the following table.

Table-

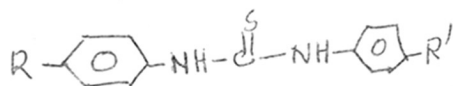

R	R ¹	log P (Calc)	MIC ($\mu\text{g}/\text{ml}$)
$-\text{OC}_4\text{H}_9$ (n)	$-\text{N}(\text{CH}_3)_2$	4.31	3.125
$-\text{OC}_4\text{H}_9$ (n)	$-\text{OC}_4\text{H}_9$ (n)	5.82	0.78
$-\text{O}-\text{CH}_2-\overset{\text{OH}}{\text{CH}}-\text{CH}_2-\text{N}-(\text{C}_2\text{H}_5)_2$	$-\text{N}(\text{CH}_3)_2$	1.54	25
$-\text{O}-\text{CH}_2-\overset{\text{OH}}{\text{CH}}-\text{CH}_2-\text{N}-(\text{C}_2\text{H}_5)_2$	$-\text{O}-\text{CH}_2-\overset{\text{OH}}{\text{CH}}-\text{CH}_2-\text{N}-(\text{C}_2\text{H}_5)_2$	0.28	3.125
$-\text{O}-\text{C}_4\text{H}_9$ (n)	$-\text{O}-\text{CH}_2-\overset{\text{OH}}{\text{CH}}-\text{CH}_2-\text{N}(\text{C}_2\text{H}_5)_2$	3.05	3.125

If one compares the log P values with that of known antituberculosis compounds given on page 22 and the comments made, the compound 3 has favourable log p value (between -1 to +1) and the activity is equal to that of thiambutisine. Our QSAR analysis on thiourea derivatives as regards the length of the chain (Lo 8.67) suggests that it should lie between n-pentyloxy and n-hexyloxy group (8.11 A⁰ to 9 A⁰). Recently this analysis has been refined to give Lo, 9.06A⁰, which comes to n-hexyloxy. The present chain introduced by us has the chain length of 9.6 A⁰ when put on computographics. This length is near to the one obtained by QSAR analysis. We are now in a process of replacing the thiourea moiety by other moieties so that the toxic nature of thiourea moiety is eliminated.