

**EXPLOITING CHIRAL 7-AZABICYCLO[2.2.1]HEPTANE
SKELETON AS A TEMPLATE FOR THE
STEREOSELECTIVE SYNTHESIS OF BIOLOGICALLY
ACTIVE ALKALOIDS**

THESIS SUBMITTED TO THE

UNIVERSITY OF PUNE

**FOR THE DEGREE OF
DOCTOR OF PHILOSOPHY**

(IN CHEMISTRY)

BY

DEBASIS DEY

RESEARCH SUPERVISOR

DR. GANESH PANDEY

**ORGANIC CHEMISTRY DIVISION
NATIONAL CHEMICAL LABORATORY
PUNE 411 008**

NOVEMBER 2013

DEDICATED TO...

"MY GUIDE, MY PARENTS AND COLY"
(WHO NEVER STOPS BELIEVING IN ME)

CERTIFICATE

This is to certify that the work incorporated in the thesis entitled "Exploiting chiral 7-azabicyclo[2.2.1]heptane skeleton as a template for the stereoselective synthesis of biologically active alkaloids" which is being submitted to the University of Pune for the award of Doctor of Philosophy in Chemistry by Mr. Debasis Dey was carried out by him under my supervision at the National Chemical Laboratory, Pune. A material that has been obtained from other sources has been duly acknowledged in the thesis.

Date:

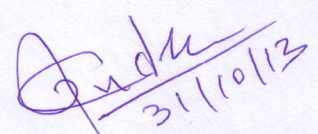

Dr. Ganesh Pandey
(Research Guide)

DECLARATION

I hereby declare that the work presented in the thesis entitled “**Exploiting chiral 7-azabicyclo[2.2.1]heptane skeleton as a template for the stereoselective synthesis of biologically active alkaloids**” submitted for Ph. D. Degree to the **University of Pune**, has been carried out by me at the **National Chemical Laboratory, Pune**, under the supervision of **Dr. Ganesh Pandey**. The work is original and has not been submitted in part or full by me for any degree or diploma to this or any other University /Institute.

Date:

Debasis Dey

Acknowledgement

The completion of this long and eventful journey would not have been possible without the generous help and constant encouragement of a number of people. I would like to thank every one of them for the support they have rendered for the accomplishment of the work presented in this dissertation.

First of all, I would like to convey my feelings of gratitude to my supervisor Professor Ganesh Pandey for accepting me as a PhD student and for his invaluable guidance, endless patience and everything he taught me throughout my association with the GP Lab. It will be impossible for me to describe in words the contribution of him in my life.

I am thankful to Dr. (Mrs.) Gadre for her motherly love and concern always.

I am thankful to Dr. P.K.Tripathi, Dr. Dethé, Dr. Biju, Dr. Reddy, Dr. Gumaste, Dr. S. Sengupta, Dr. R. Banerjee for their helpful suggestions....

NCL organic office staff Mrs. Catherine, Mrs. Puja, Mr. Pawar, Mr. Babus, Mr. Iyer for their kind help....

I thank my present (Atishji, Bhawna madam, Deepak, Mantu, Navnath, Binoy, Animesh, Durga, Sahani, Jankiram, Alokji, Rajesh, Divya, Prachi, Pushpendra, Shiva, Ajay, Jagadish, Pulak, Pradeep, Akash, Sandeep, Rushil, Ramkrishna) and past lab members (Prabald, Srinivasji, Kishor bhaiya, Balaji, Keshrji, Nishant bhaiya, Ravi bhaiya, Prasannaaji, Amrut Gaikwad, Swaroop, Rajender ji {roommate}, Debashis ji, Sanjayji, Priyanka, Sujitda, Dharmendraji, Asha Madam, Tukaram, Nitesh, Gumasteji, Pawarji) for making GP Lab, the most desirable place to work; a warm and very cheerful and cooperative atmosphere in the lab helped me a lot.

Help from the Spectroscopy and CMC group is gratefully acknowledged. Special thanks are due to Dr. P. R. Rajmohanam, and Mrs. V. G. Puranik, Mr. Rupesh who went out of their way in helping me out whenever I needed an urgent analysis.

I am also grateful to my teachers Mr. Dilip Pradhan, Mr. Shaktipada Pradhan, Mr. Chittaranjan Khanra, Dr. Tridib Tripathy, Dr. Mahadeb Maity for their excellent guidance and motivations..

I thank CSIR New Delhi, for the award of Research Fellowship and Director, N. C. L., for the infra-structural facilities.

I want to thank all my friends for their maximum possible support; I cannot even imagine myself without them. Prabal da, Debu da, Kartik da, Prabhas da, soumitra da, Senapoti da, Bibhas da, somnath da, Sujatadi and chotto Diya, Boudimoni, Susmita didi, Roopa di, Anirbanda, Nimuda, Ramuda, Pradip da, Choto Debuda, Anamitrada, Mukulda, Bhaskar da, Rahmanda, Alanda, Chinmay da , Rita di, Dhananjayda ,Chaitali di, Majorda,.....

I don't have any elder brother but Prabalda and Debuda never allowed me to feel like that.

Then comes, Debasis Pati, Sujitda, Sugatada, Mama, Kaushik, arjitda, rahulda, Maitridi, Kishor,Mrityunjay, rahul, Partha, sumantra, Anal Ganai , dos, arjit, saumen, krisanu, ramkrishna, jagadish, animesh, shyam, chini, mishraji, Sridhar, Subhadeep, Prithvi , Sankho, Ani, Anupam (Motu), Deepa, gouri, pinki, manu di, Manisha, Shrikant ji (nmr), Mayur, achinta, saikat, Manna, Arup, Pitambar, Ashokda, Dhaka, Janada, Sanjib..... and many more
My college friends Chanchal, Rajkumar, Abhishek, Ladenda, palash, Asit, Rajada.....and many more

M.Sc friends Aka, Habu, neeladri, basab babu, Arindam, chandi, samad, N.Patida, sudiptada, saumenda, amit, ashok kuma, ved bhaiya, reshmi, puja, jayashri, shweta, rubel..... and many more

Among all Debasis pati,Rajkumar, Aka, Habu, Neelardri, Rahul, Kishor, Anal, prithvi, motu, Krisanu, sujitda, Pradipda....are very very special.....they are real jems....

I lost three friends during my stay here...Agnimitra (Alizee crazy, messi crazy, cricket crazy, CPM crazy....), Srikantji, Atanu and my elder brother Shibsankarda.....hope God will be with them in heaven.

My parents and family members (chotodidi,jamaida,borodidi,borojamaida, chandanda, mam, mumu, trina, deep, mejomama, debuda...)for their infinite patience.....and lastly a special friend COLY who.....

CONTENTS

Exploiting chiral 7-azabicyclo[2.2.1] heptane skeleton as a template for the stereoselective synthesis of biologically active alkaloids

	Page No	
Abstract	i-viii	
Chapter 1	Introduction to 7-azabicyclo [2.2.1] heptane skeleton and approaches towards total synthesis of pancratistatin	1
Section 1A.1	An introduction to 7-azabicyclo[2.2.1]heptane skeleton ; synthetic routes and importance	2
Section 1A.2	Various approaches for the construction of 7-azabicyclic system	5
Section 1A.3	Our lab contribution	10
Section 1A.4	References.	14
SECTION B	Synthetic studies towards pancratistatin and related natural products	16
Section 1B. 1a	Introduction.	16
Section 1B.1b	Synthetic approaches toward Pancratistatin	17
Section 1B. 1c	Approaches towards (+)-7-deoxypancratistatin	23
Section 1B.1d	Background and our group contribution:	27
Section 1B.1e	Intention of present study	29
Section 1B.2	Retrosynthetic analysis	30
Section 1B.3	Results and discussions	32
Section 1B.4	Alternative approach	41
Section 1B.5	Results and discussion	42
Section 1B.6	Conclusion and outlook	52
Section 1B.7	References	54
Section 1B.8	Experimental	58
Section 1B.9	Spectras	78
Chapter 2	Synthesis of <i>exo</i> -7-Azabicyclo[2.2.1]heptan-2-amine and <i>cis</i> -1,2 diamino cyclohexene	116
Section 2.1	Introduction, Concept, Results and Discussions	117
Section 2.2	Conclusion	126
Section 2.3	References	127
Section 2.4	Experimental Section	130
Section 2.5	Spectras	142
Chapter 3	Synthesis of aminocyclitols utilizing 7-azabicyclo [2.2.1]hepta-2-one as a chiral template	174
Section 3.1	Introduction	175
Section 3.2.	Hypothesis	177
Section 3.3	Results and discussion	178
Section 3.4	Conclusion	184
Section 3.5	References	185
Section 3.6	Experimental Section	186
Section 3.7	Spectras	197
Erratum		

Abbreviations

aq.	aqueous	NMR	Nuclear magnetic resonance
bp	boiling point	NOE	Nuclear Overhauser effect/enhancement
Bn	Benzyl	NOESY	Nuclear Overhauser Enhancement Spectroscopy
Boc	<i>t</i> -Butoxycarbonyl	ORTEP	Orthogonal thermal ellipsoid plots
DCM	Dichloromethane	PDC	Pyridinium dichromate
DEPT	Distortionless enhancement by polarization transfer	<i>p</i> -TSA	<i>p</i> -Toluenesulfonic acid
DMF	N, N-dimethyl formamide	py	Pyridine
DMSO	dimethylsulfoxide	rt	Room temperature
COSY	correlated spectroscopy	TBS	<i>t</i> -Butyldimethylsilyl
g	gram	TEA	Triethyl amine
GC	Gas Chromatography	TFA	Trifluoroacetic acid
h	hour	THF	Tetrahydrofuran
Hz	Hertz	TLC	Thin layer chromatography
<i>K</i> _i	Inhibition constant	TMS	Trimethylsilyl
M	Molarity (molar)	α -Glu	α -Glucosidase
Mg	Milligram	β -Glu	β -Glucosidase
Min	Minute(s)	α -Man	α -Mannosidase
mL	Milliliter	β -Man	β -Mannosidase
mmol	Millimole		
mp	Melting Point		
N	Normality		
MS	Mass Spectrum		
MsCl	Methanesulfonyl chloride		

General Remarks

- All the solvents were purified according to literature procedure.¹
- Petroleum ether used in the experiments was of 60-80 °C boiling range.
- Column chromatographic separations were carried out by gradient elution with suitable combination of two solvents and silica gel (60-120 mesh/ 100-200 mesh/ 230-400 mesh).
- Reaction progress was monitored by TLC. TLC was performed on Merck pre-coated 60 F₂₅₄ plates and the spots were rendered visible by exposing to UV light, Iodine, phosphomolibdic acid, o-Anisol, KMNO₄, ninhydrin solutions.
- IR spectra were recorded on FTIR instrument, for solid either as nujol mull, neat in case of liquid compounds or their solution in chloroform.
- NMR spectra were recorded on Bruker AC 200 (200 MHz ¹H NMR and 50 MHz ¹³C NMR), Bruker AV 400 (400 MHz ¹H NMR and 100 MHz ¹³C NMR), Bruker DRX 500 (500 MHz ¹H NMR and 125 MHz ¹³C NMR) and Bruker ultra shield 800(800 MHz ¹H NMR and 200 MHz ¹³C NMR) ¹³C peak multiplicity assignments were made based on DEPT data.
- Mass spectra were recorded on PE SCIEX API QSTAR pulser (LC-MS), Agilent Accurate mass and Thermofischer QEXACTIVE and Shimadzu QP 5000 GC/MS coupled to Shimadzu 17A GC using a DBI column.
- Microanalysis data were obtained using a Carlo-Erba CHNS-O EA 1108 Elemental Analyser. Elemental analyses observed for all the newly synthesized compounds were within the limit of accuracy (± 0.4 %).
- All the melting points recorded are uncorrected and were recorded using electrothermal melting point apparatus(BUCHI, MODEL NO. B540)
- Starting materials were obtained from commercial sources.
- **Numbering of compounds, schemes, tables, referencing and figures for each chapter and in abstract are independent.**

1) Perrin, D. D.; Armarego, W. L. F. Purification of Laboratory Chemicals, 4th ed., Butterworth Heinemann, 1999

Research student Debasis Dey
Research Guide Dr. Ganesh Pandey
Title of Thesis Exploiting chiral 7-azabicyclo[2.2.1] heptane skeleton as a template for the stereoselective synthesis of biologically active alkaloids

Registration no. EI/287/Ph.D/2008 JUNE 16, 2008
Date of 05.09.2007
Registration
Place of work Lab. No. 182, Division of Organic Chemistry, National Chemical Laboratory, Pune-411008, INDIA.

Thesis Abstract

The present dissertation is divided into three chapters.

Chapter 1: Introduction to 7-azabicyclo [2.2.1] heptane skeleton and approaches towards total synthesis of pancratistatin

This chapter is divided into two sections.

Section A : An introduction to 7-azabicyclo[2.2.1]heptane skeleton: synthetic routes and importance

The 7-azabicyclo[2.2.1]heptane system (**1a**, **1b**, **1c**) has been the subject of numerous synthetic studies which have resulted in the development of several methods for the construction of these novel structures initially for pure academic interest, which changed after the isolation of epibatidine (**2**) and many structurally related natural products by Prof. Daly. Epibatidine is a non opiod analgesic 1000 times more effective than morphine.

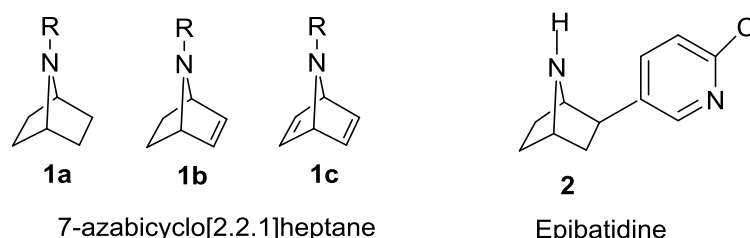

Figure 1.

We got interested in 7-azabicyclo[2.2.1]heptanes skeleton by vizualizing immense potential of this structural framework for developing various important structural motifs like aminocyclitols, amarylidaceae alkaloids, substituted pyrrolidines, preussin and related natural products.

An overview of enantioselective synthetic routes towards this novel skeleton **1** is presented in a concise manner.

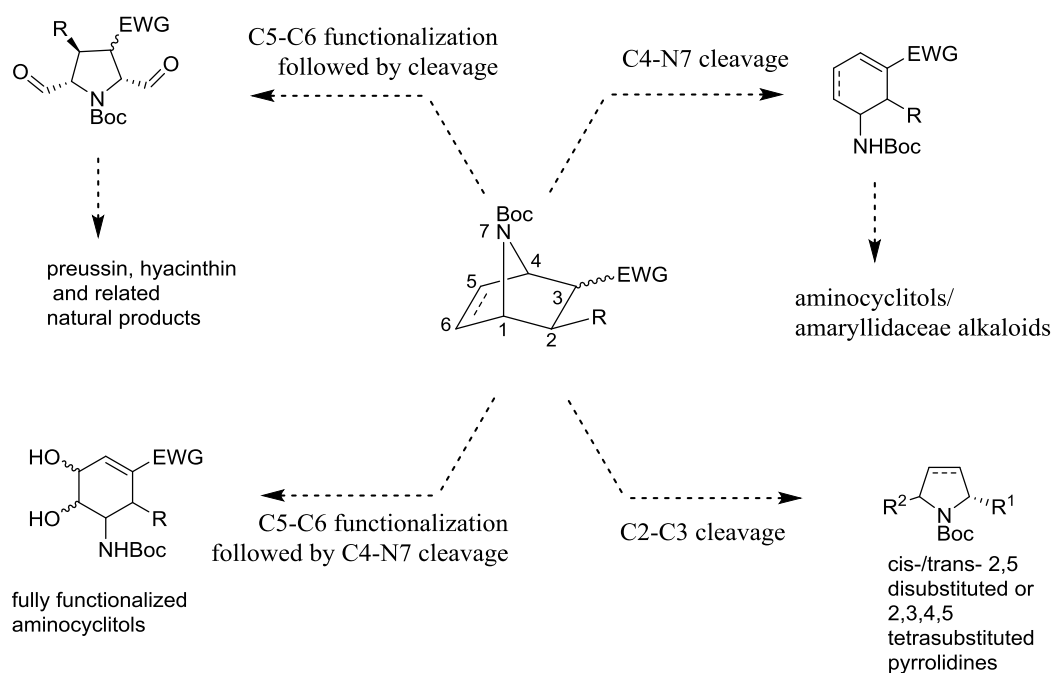

Figure 2.

SECTION B: Synthetic studies towards pancratistatin and related natural products

This chapter describes a brief overview of synthetic approaches developed towards pancratistatin and its congeners including our group contribution. In the later part of this section, a detailed account of our present efforts regarding achieving the synthesis of pancratistatins is depicted.

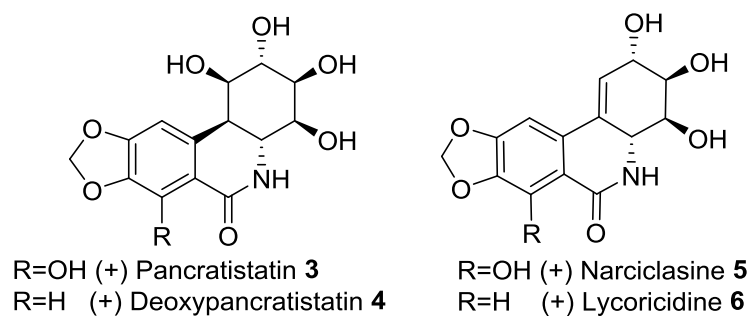
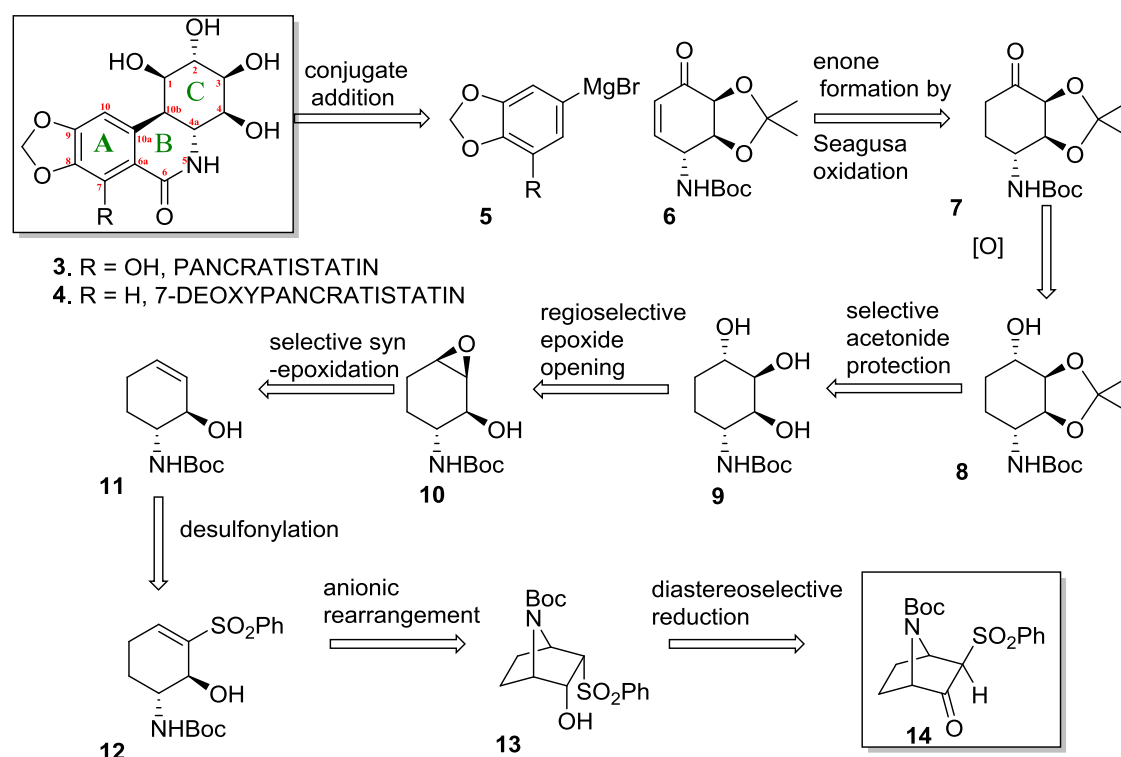

Figure 3.

(+)- Pancratistatin (**3**), was first isolated by Pettit and co-workers in 1984 from the plant *Pancreatum littorale*. It showed most promising anti-cancer and antiviral activities. It was found to be active against murine P-5076 ovarian sarcoma as well as against P-388 lymphocytic leukemia. Five years later, Ghosal and co-workers isolated 7-deoxypancratistatin (**4**) from the bulbs of *Haemanthus kalbreyeri* which also showed similar biological activities with better therapeutic index due to decreased toxicity. Although Narciclasine (**5**) and Lycoricidine (**6**) were isolated from *Lycoris radiate* by Okamoto and co-workers in 1968, their activity in inhibiting the binding of tRNA to the peptide transferase centre of ribosomal subunit and thereby disrupting the protein biosynthesis in eukaryotic cells, was unveiled much later.

Our initial plan towards its synthesis was based on conjugate addition of aryl Grignard reagent to a reconstructed enone **6**, however undesired *cis*-stereochemistry for B C ring fusion emerged.



Scheme 1.

Since *trans* B C ring fusion is a must for bio-activity of these molecules, it was decided to address this issue at the premature stage of the synthetic sequence itself. Therefore, it was envisioned that a basic unit **15** will be sufficient to fulfill the requirement of crucial *trans*- B C ring junction and also for the complete C ring functionalization.

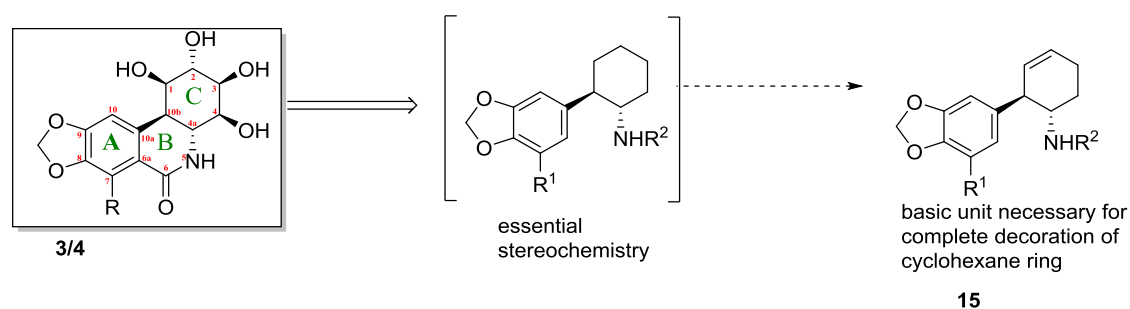

Scheme 2.

The synthesis of **15** was achieved from **16** via **18** through anionic rearrangement followed by desulfonylation as shown in Scheme-3.

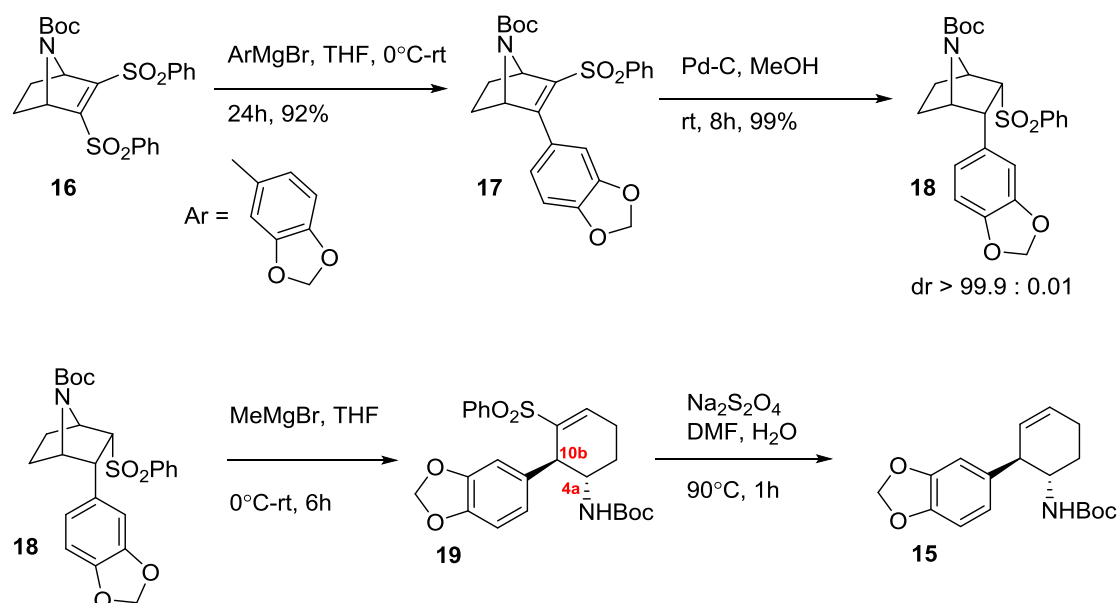

Scheme 3.

C-Ring functionalization was initiated with epoxidation of **15** followed by its conversion to **27**. Modified Bischler–Napieralskii reaction from **27** provided **28** which after acetyl group deprotection furnished 7-deoxy pancratistatin.

Detailed synthetic challenges and tactical nuances are discussed in this section.

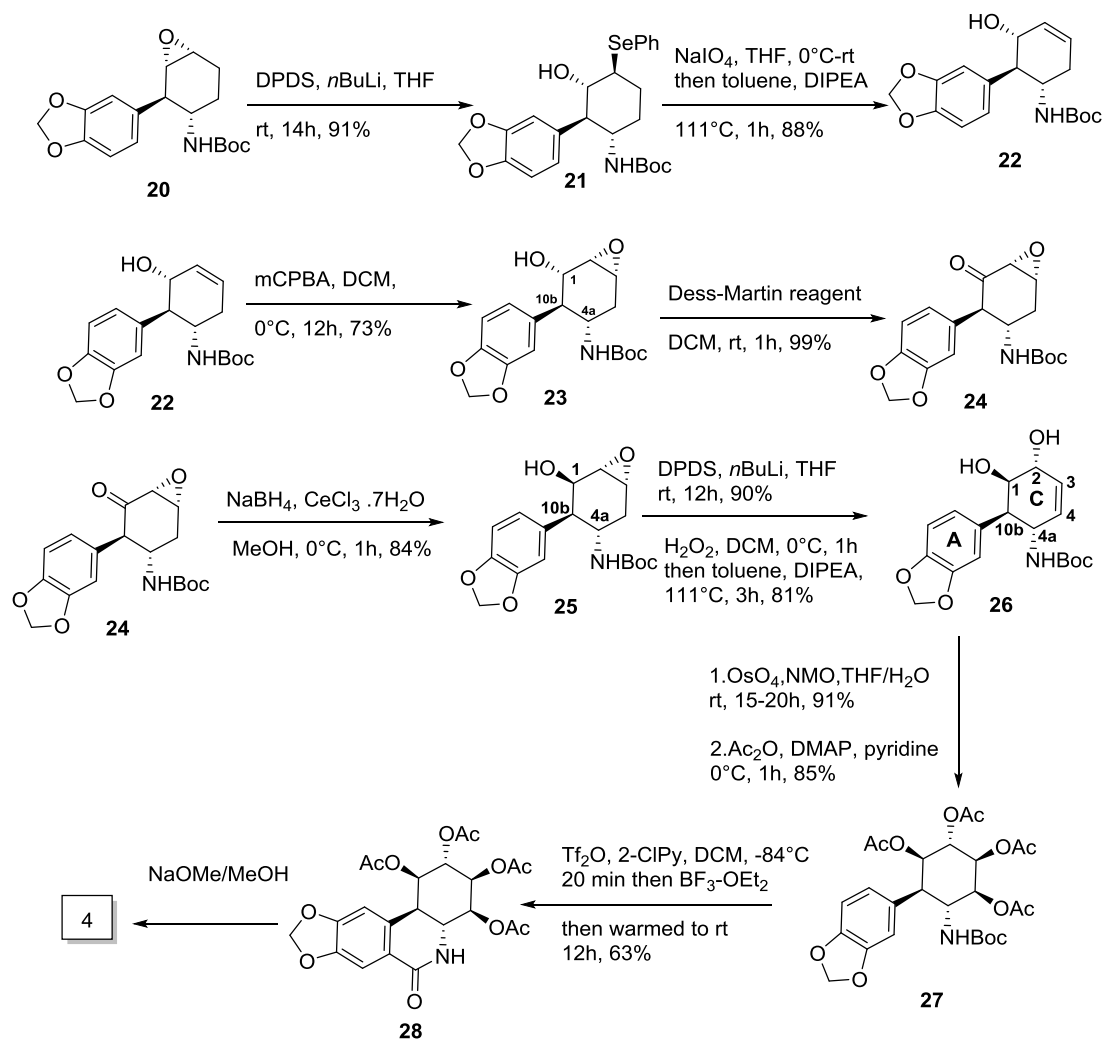

Scheme 4.

Chapter 2: Synthesis of *exo*-7-Azabicyclo[2.2.1]heptan-2-amine and *cis*-1,2 diamino cyclohexene.

Cyclohexane-1, 2-diamines have diverse application in many areas of organic chemistry such as ligands in metal-catalyzed asymmetric reaction and as an organocatalysts. This Chapter presents our efforts in achieving a scalable, practical synthesis of *cis*-1,2-diaminocyclohexene derivatives and 7-azabicyclo[2.2.1]hept-2-amines utilizing **14** as a synthetic precursor.

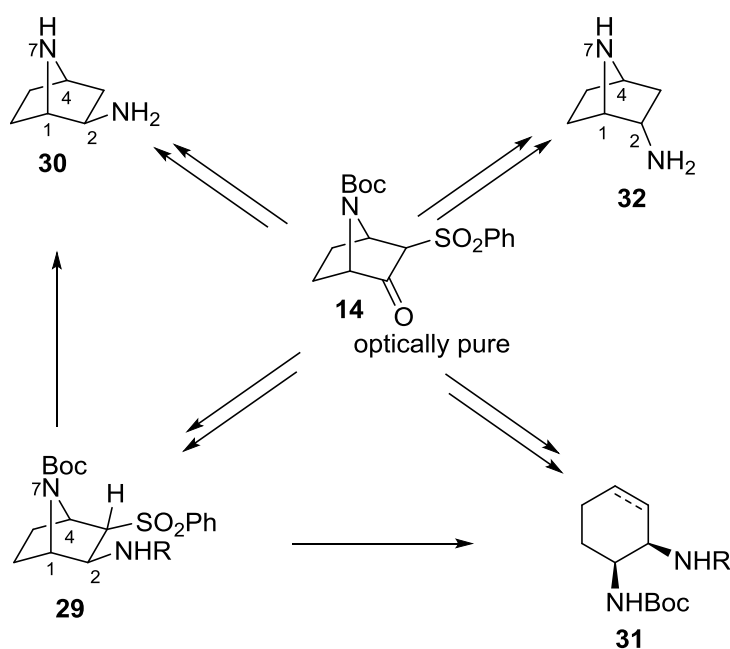

Scheme 5.

Chapter 3 : Synthesis of aminocyclitols utilizing 7-azabicyclo [2.2.1]hepta-2-one as a chiral template:

Aminocyclitols/ conduramines are cyclic polyhydroxylated amines with wide variety of biological activities. These compounds can target pivotal RNA sites which make them candidates for drug discovery. Particularly, conduramines have been used as intermediates for the preparation of some alkaloids, azasugars and aminosugars. Since, we are actively involved in the synthesis of

aminocyclitols, two common basic intermediates **11** and **33** were envisioned. This chapter describes in detail the synthetic sequences pertaining to various conduramines utilizing **11** and **33** as precursors.

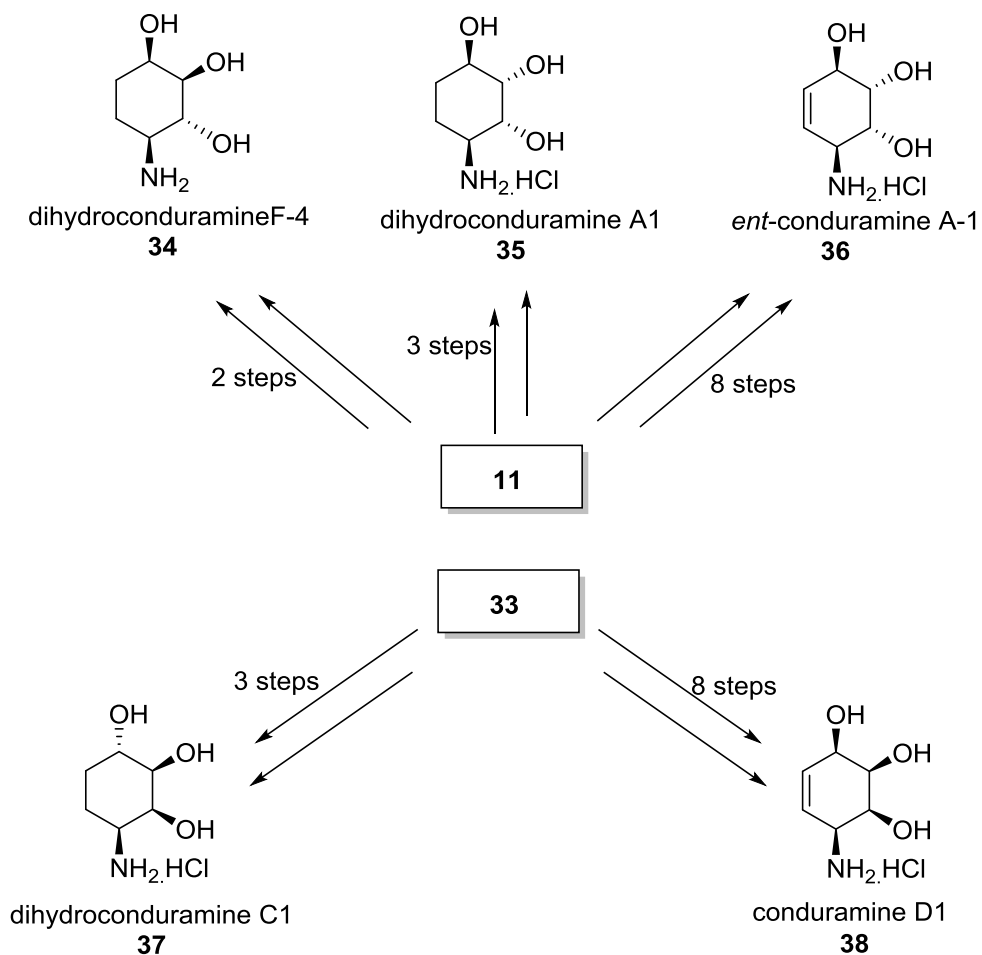

Scheme 6.

CHAPTER 1:
INTRODUCTION TO 7-AZABICYCLO [2.2.1] HEPTANE
SKELETON AND APPROCHES TOWARDS TOTAL
SYNTHESIS OF PANCRATISTATIN

Section A**1A.1 : An introduction to 7-azabicyclo[2.2.1]heptane skeleton ; synthetic routes and importance**

Three different types of structures are possible for 7-azabicyclo[2.2.1]heptane skeleton (**1**); the fully saturated (**1a**), partially unsaturated (**1b**) and fully unsaturated (**1c**).^[1] A large number of synthetic sequences are known in literature towards the construction of these skeletons.^[2] For sometimes, the interest in the synthesis of these systems were only a matter of academic interest since no naturally occurring compound was known at that time which contained these ring systems. From 1990 onwards the scenario started changing after the isolation of large number of naturally occurring alkaloids from amphibian toad skin by Daly *et al.*^[3] The most notable and celebrated among the hundreds of isolated alkaloids was epibatidine (**2**). (-)-Epibatidine (**2**), a new alkaloid isolated from Ecuadorian poison frog, *Epipedobates tricolor*, featuring the 7-azabicyclo[2.2.1]heptane ring system with an *exo* oriented 5-(2-chloropyridyl) moiety (Figure 1) displayed strong analgesic property though it was not a member of *opioid class*. Due to the novel biological activity associated with **2** and its paucity in nature (1 mg isolated from 750 frogs), the total synthesis of **2** had aroused huge interest amongst organic chemists around the world.

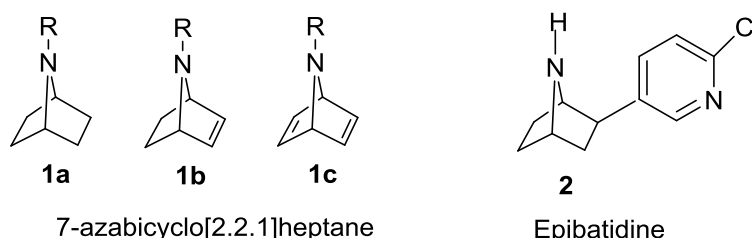

Figure 1.

The extraordinary pharmacology^[4] of **2** had indicated its potential for nicotinic acetylcholine receptor (nAChR) ligands for serving as a new therapeutic class of host of CNS disorders. Many of such ligands are natural products, or analogues thereof, which represent a significant challenge to the synthetic chemist.

The chance of **2** ever being used as a medicinal agent became quite low because of its high toxicity, however, in order to cope up with toxicity, several analogues of **2** have been deliberated and synthesized by altering the side chain as well as bicyclic skeleton. One of the interesting analogue is epiboxidine^[5] (**3**), a hybrid of epibatidine

and ABT-418 (**4**) which is an isosteric analogue of nicotine, where chloropyridine ring has been replaced by methylisoxazole (Figure 2). Although not as potent as epibatidine, epiboxidine (**3**) has higher affinity than nicotine and has been found 20 fold less toxic than **2**.

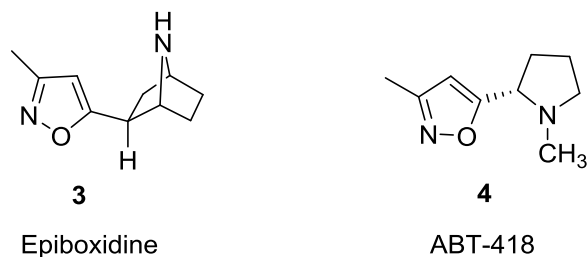

Figure 2.

Another class of the epibatidine analogues such as homoepibatidine (**5**), *bis* homoepibatidine^[6] (**6**) and diazabicyclopyrazine DBO-83^[7] (**7**) (Figure 3) in which the azabicycloheptane ring is altered has been synthesized and tested. However, none of these could be developed as a drug so far.

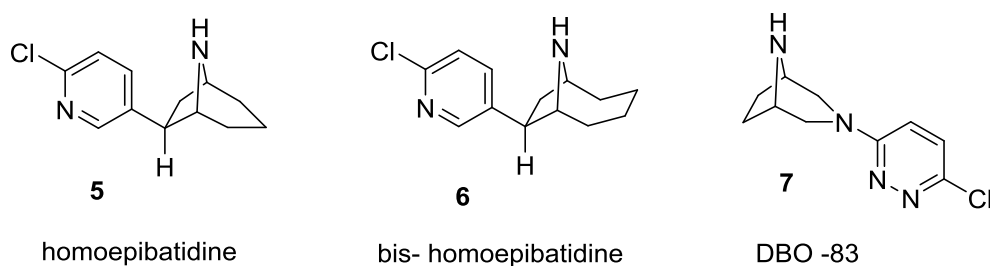

Figure 3.

In search of better selectivity, conformationally restricted analogue **8** as well as fused analogue **9** has also been synthesized^[8] and screened (Figure 4). Although, these analogues show low affinity and do not encompass the ideal conformation for the high affinity, they surely provide valuable information concerning the pharmacophore studies.

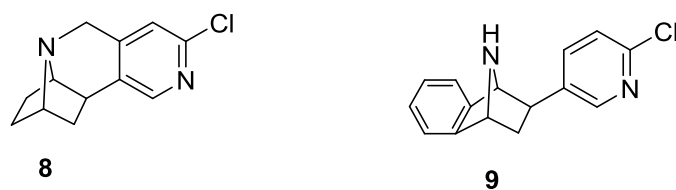

Figure 4.

Despite significant progress in the research dealing with the chemistry of 7-azabicyclo[2.2.1]heptane ring system, most of these important structures have been used in the synthesis of epibatidine and its analogues. We got interested in this particular ring system by visualizing its immense potential for the synthesis of various important structural motifs as shown in Fig. 5.

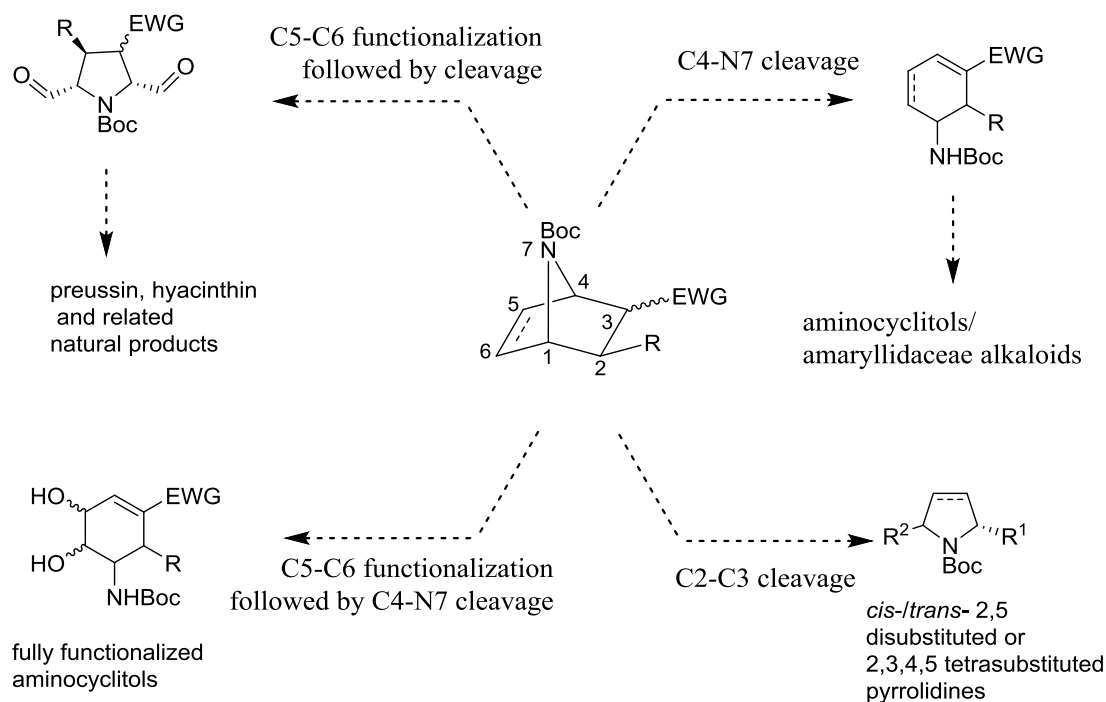

Figure 5.

Our previous experiences with 7-azabicyclo[2.2.1]heptane structural frameworks^[9] led us to understand well that C4-N7 cleavage of this skeleton will generate a cyclohexene skeleton from which depending on the nature and stereochemistry of R, various aminocyclitols, diaminocyclitols and *Amaryllidaceae* alkaloids could possibly be synthesized. Similarly, stereoselective C5-C6 functionalization followed by C4-N7 cleavage would in principle generate a fully substituted cyclohexene moiety; which can easily be manipulated to many all carbon substituted aminocyclitols. Synthesis of these aminocyclitols otherwise have proved to be difficult. Another important class of structures could be generated by first dihydroxylation of C5-C6 olefinic bond followed by cleavage leading to all substituted pyrrolidines skeleton; an essential requirement for the synthesis of Preussin and Hyacinthin class of compounds. Lastly another potential disconnection could be thought of between C2-C3 which could

generate *cis*- and/ *trans*- 2,5-dialkylated pyrrolidines; an ubiquitous structural features in many important naturally occurring alkaloids. Because of immense importance of 7-azabicyclic frame work, various groups have developed different approaches for its construction. Therefore, before dwelling upon our contribution in this field, it would be appropriate to describe some of the selected examples for the construction of 7-azabicyclo[2.2.1]heptane frame work from literature.

1A.2. Various approaches for the construction of 7-azabicyclic system

1A.2a *trans*-Annular cyclization

Trost *et al.*^[10] reported the first asymmetric synthesis of (-)-epibatidine (**2**) using Pd-catalyzed desymmetrization of *meso*-**10** to produce **11** which was later converted into a key precursor **12**. The intermediate **12** was subjected to *trans*-annular cyclization to construct 7-azabicyclic system producing (-)-**2** with 81% yield and >95% *ee* as depicted in Scheme 1.

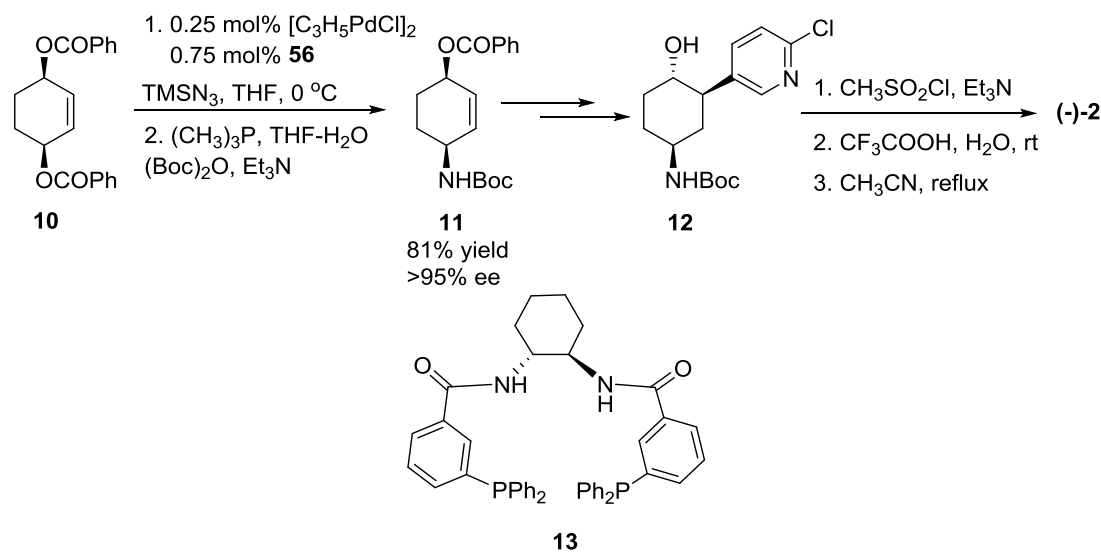

Scheme 1.

Lee *et al.*^[11] developed a short and concise procedure for gram-scale synthesis of **2** by intramolecular cyclization of **14** followed by the radical dehalogenation to provide **15** as a sole product which was further epimerized to (-)-**2** as shown in Scheme 2.

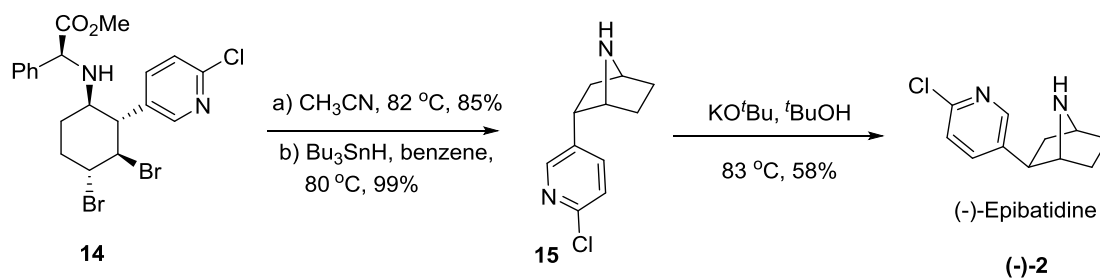

Scheme 2.

Sanchez and co-workers reported^[12] the NaH/DMF-promoted heterocyclization reaction of *N*-(3-*cis*,4-*trans*-dibromocyclohex-1-yl)-2,2,2-trifluoroacetamide (**16**) to afford 7-azabicyclo [2.2.1] heptane derivative **17** in good yield (81%) which on basic hydrolysis followed by acetylation gave **18** in 72% yield (Scheme 3).

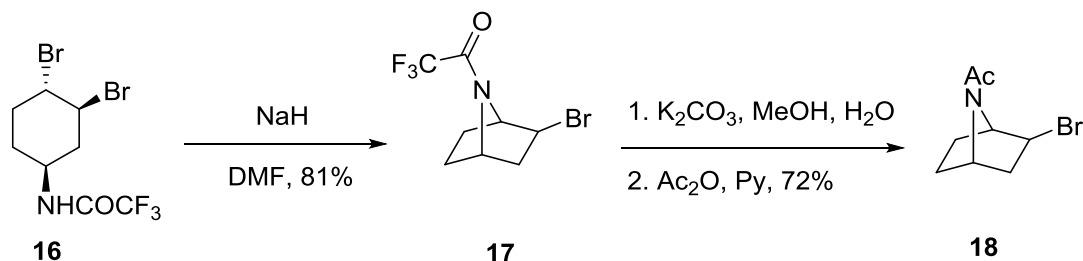

Scheme 3.

Another excellent example of transannular cyclization could be found in literature by Savoia *et al.*^[13] where synthesis of optically pure *endo*-7-azabicyclo[2.2.1]heptane **20** is reported by cyclization of **19** using Mitsunobu protocol. Subsequent removal of benzylic substituents by reductive hydrogenation in the presence of palladium hydroxide in methanol containing 2.5 eq. HCl/MeOH produced *endo*-7-azabicyclo[2.2.1]heptan-2-amine (**21**) as a single isomer in 97% yield (Scheme 4).

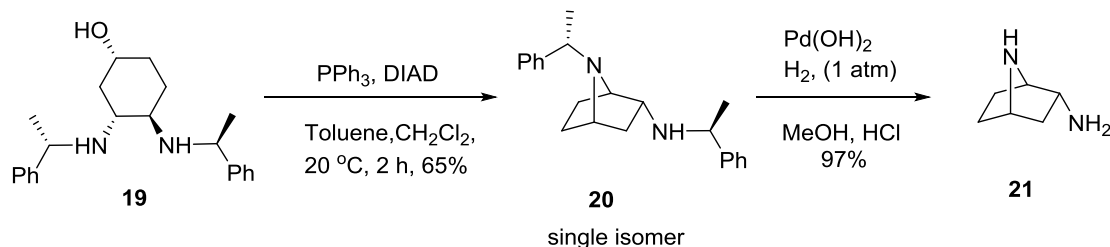

Scheme 4.

1A.2b Intramolecular cyclization

Albertini *et al.*^[14] have reported conceptually attractive strategy for the enantioselective construction of 7-azabicyclo[2.2.1]heptanes skeleton **24** in high yield (92%), employing a facial and regio-selective intramolecular nucleophilic ring opening of a chiral cyclic sulfate **23** derived from D-(-)-quinic acid **22** as shown in Scheme 5. Intermediate salt **24** was further transformed to 7-azabicyclic ketone **26** for the synthesis of (+)-**2**.

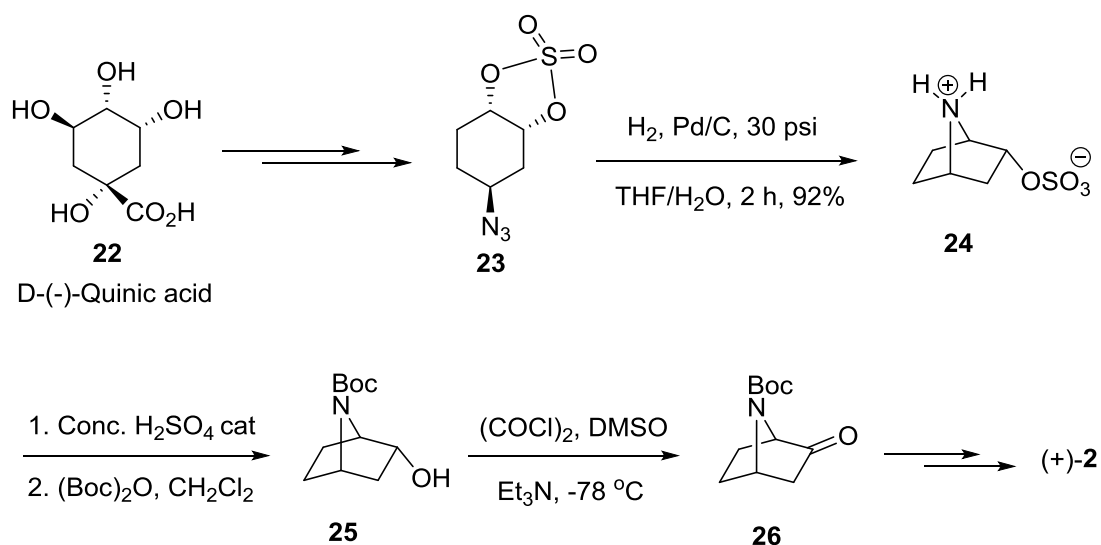

Scheme 5.

Synthesis of 7-azabicyclic ring system **28** is reported^[15] in excellent yield (96%) involving β -elimination of silyl ether of **27** followed by cyclization to afford **28**. Intermediate **28** was further converted into 2-substituted 7-azabicyclo[2.2.1]heptane glutamic acid analogue **29** employing simple transformations (Scheme 6).

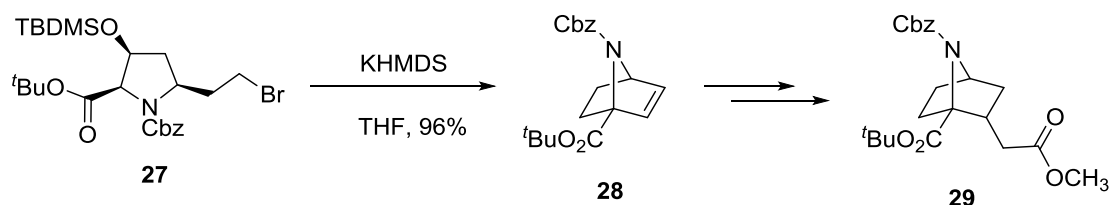

Scheme 6.

Asymmetric hetero Diels-Alder reaction as a key step have been utilized^[16] for the synthesis of (-)-epibatidine involving **32**, obtained in high yield and selectivity from

an asymmetric Diels-Alder cycloadduct **30**. The precursor **31** was further converted to (-)-**2** by intramolecular cyclization as shown in Scheme 7.

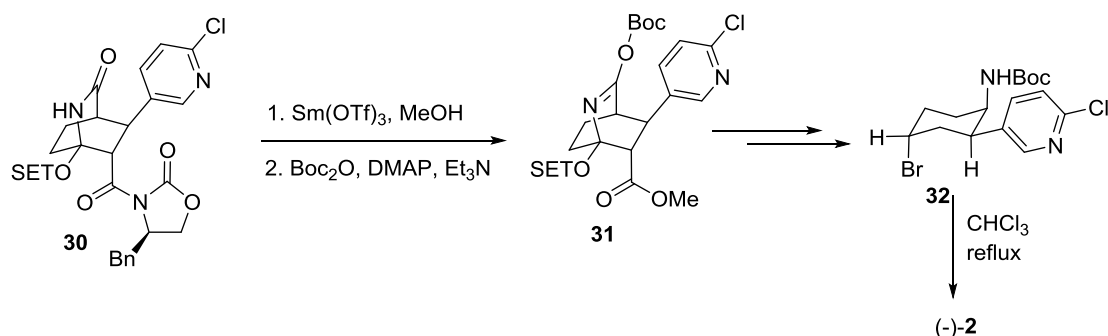

Scheme 7.

Elena and co-workers^[17] developed a protocol for the synthesis of 7-azabicyclic system **42** by intramolecular cyclization of a mixture of **40** and **41** which in turn was obtained by the cyclization of **35**. The key intermediate **35** was obtained by Diels-Alder reaction of (*Z*)-2-phenyl-4-[(*S*)-2,2-dimethyl-1,3-dioxolan-4-ylmethylene]-5-oxazolone **33** and Danishefsky's diene **34** (Scheme 8).

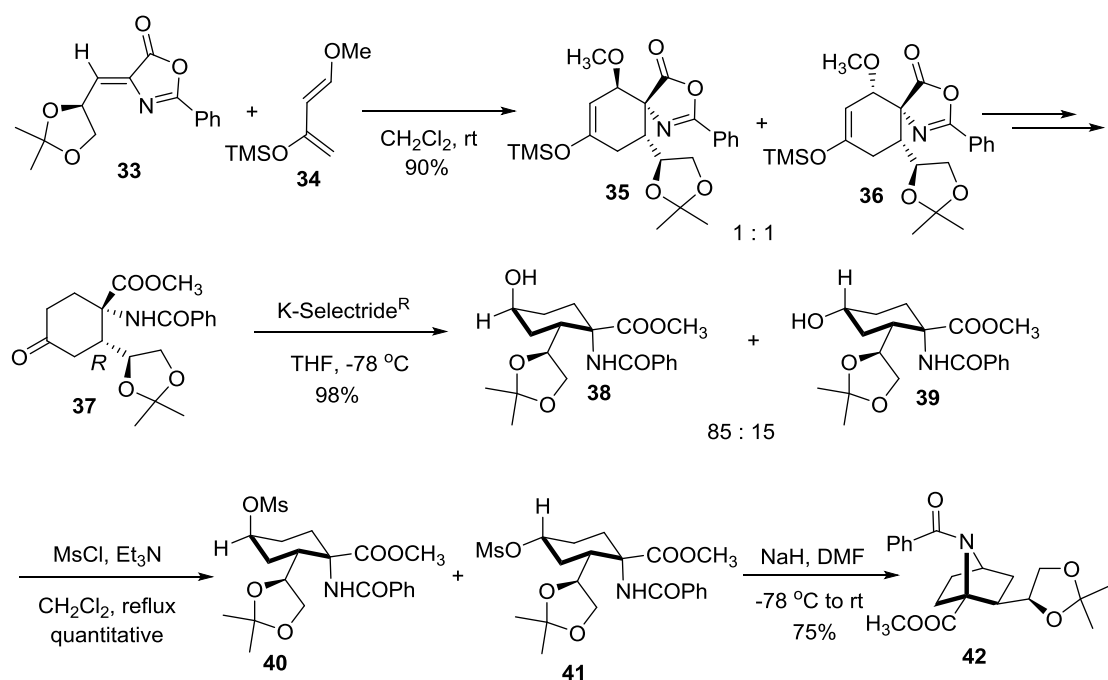

Scheme 8.

1A.2c Intramolecular iminium cyclization

Rapoport *et al.*^[18] have introduced a novel “Chiron” concept of decarbonylation/intramolecular iminium-ion cyclization of **43**, for the construction of

enantiopure *trans*-2,3-disubstituted-7-azabicyclo[2.2.1]heptanes (-)-**44** and (+)-**44** in 1:3 ratio, those were further converted in to (+)-**26** and (-)-**26** respectively, *via* single chemical manipulation as shown in Scheme 9.

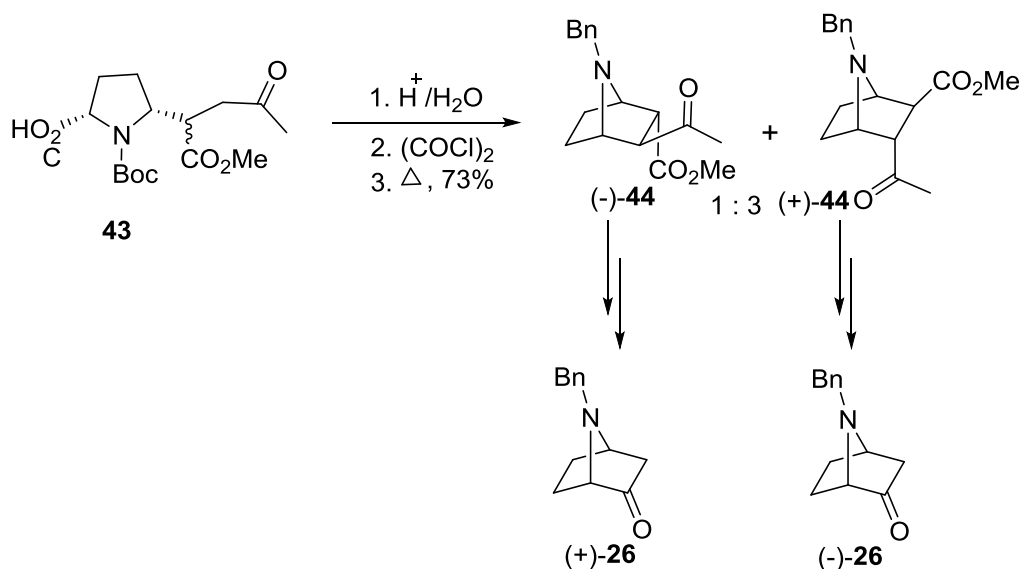

Scheme 9.

Karsten *et al.*^[19] developed a method for the construction of enantiopure 7-azabicyclo[2.2.1]heptanes skeleton **46** in 75% yield by intramolecular *N*-acyliminium ion cyclization of the *N*, *O*-acetal **45** and ozonolysis of **46** to produce a key precursor (-)-**26** for (+)-epibatidine (Scheme 10) synthesis.

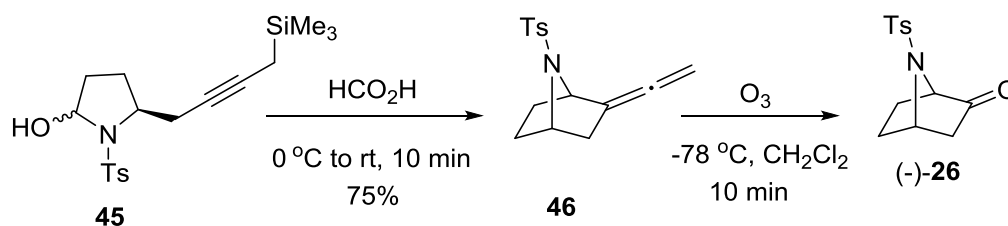

Scheme 10.

1A.2d Asymmetric elimination

Simpkins *et al.*^[20] have reported an unique approach for the total synthesis of (-)-epibatidine (**2**), utilizing asymmetric elimination of a sulfone group from a vicinal *bis*-sulfone having the 7-azabicyclo[2.2.1]heptanes skeleton **47** by the sodium alkoxide derivative of (*1R,2S*)-ephedrine (**50**). Key precursor **49** was further converted in to (-)-**2** by simple chemical transformation (Scheme 11).

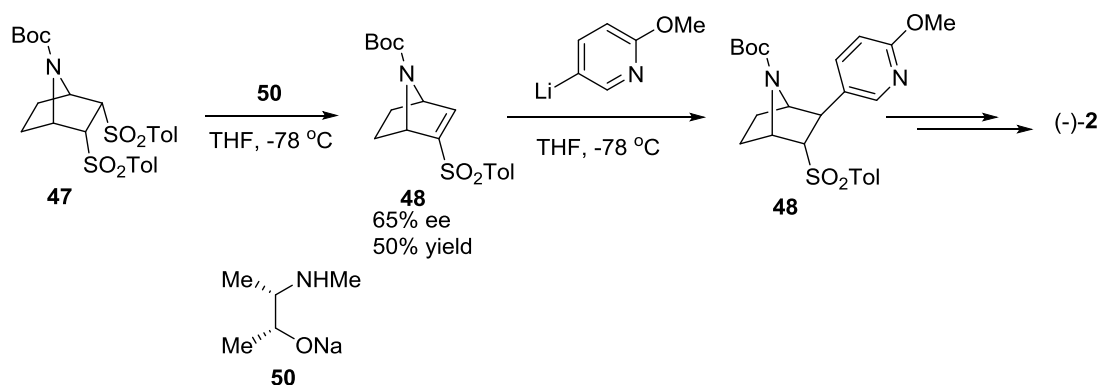

Scheme 11.

1A.2e Asymmetric Diels-Alder cycloaddition

A very interesting approach has been adopted by Node and co-workers^[21] for the construction of enantiopure 7-azabicyclo[2.2.1]heptanes system **53** (86 %) as a sole product utilizing asymmetric Diels-Alder reaction of di-L-(2)-menthyl allene-1,3-dicarboxylate (*R*)-**51** with *N*-Boc-pyrrole **52** in the presence of AlCl_3 in CH_2Cl_2 at -78 °C. Compound **53** was subsequently converted into a synthetic precursor **26** for the synthesis of (-)-epibatidine (Scheme 12).

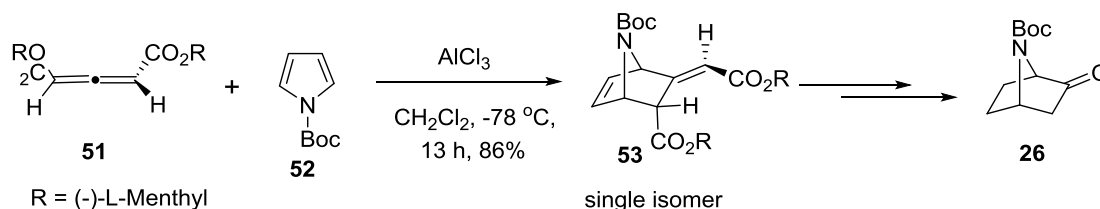

Scheme 12.

1A.3 Our lab contribution

Owing to its intriguing pharmacological activity, interesting structural features and scarcity in nature, our group also got attracted for synthesis of **2** and its analogues. The first racemic synthesis was reported by us using cycloaddition of non stabilized azomethine ylide, generated by the sequential double desilylation of *N*-alkyl- α, α' -di(trimethylsilyl) cyclic amines using Ag(I)F as one electron oxidant, with a variety of dipolarophiles (Scheme 13).^[22]

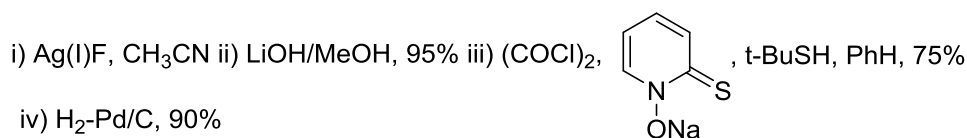
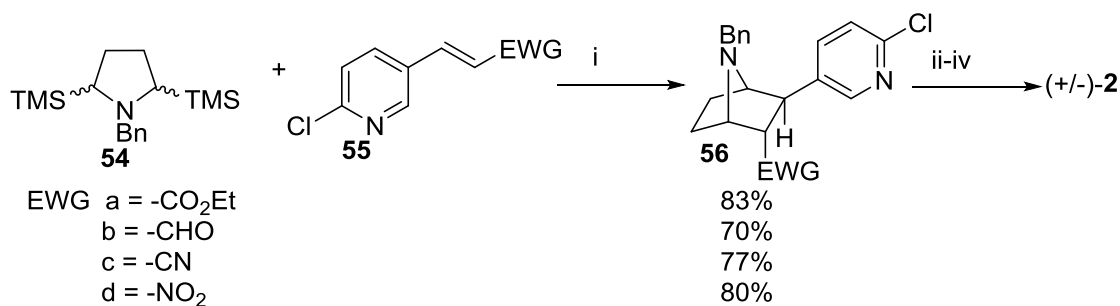

Scheme 13.

Our group had also reported less toxic racemic epibridine(+/-)- **3** synthesis using a similar Diels-Alder cycloaddition approach (Scheme 14).^[23]

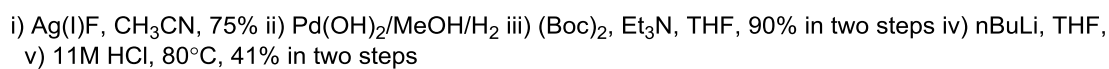
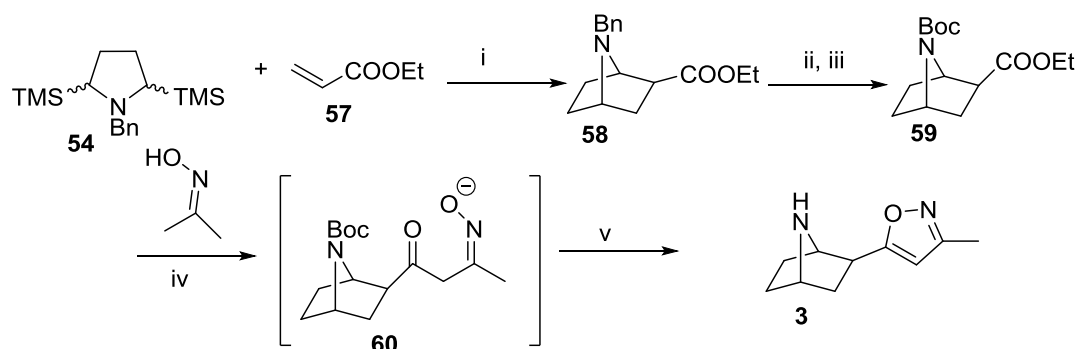

Scheme 14.

A short enantioselective synthesis of **2** was also reported by us employing a chiral auxiliary guided [3+2] cycloaddition of non stabilized azomethine ylide^[24](Scheme 15).

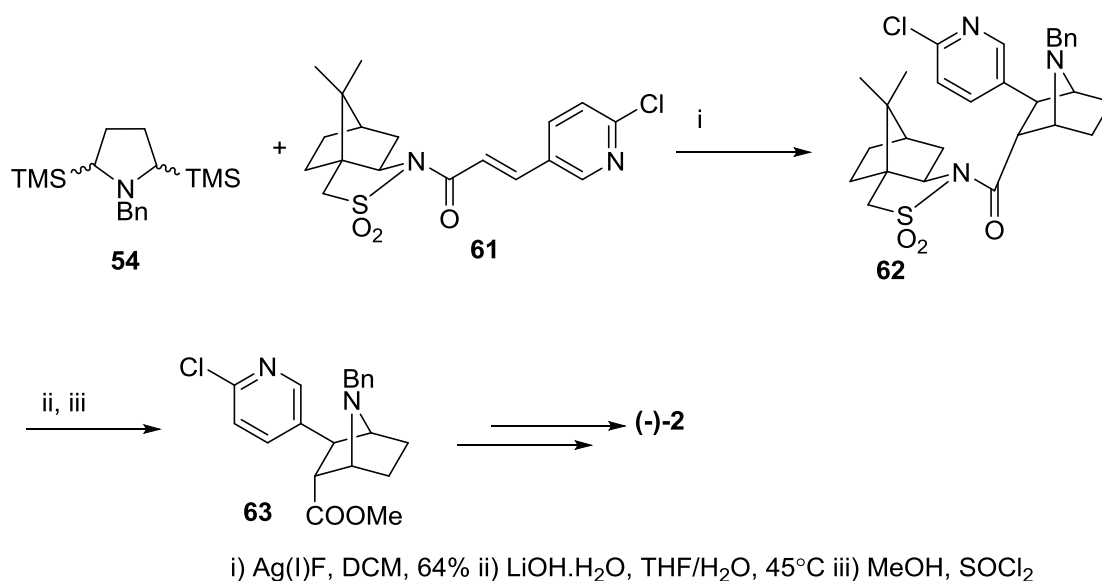

Scheme 15.

Although several different synthetic approaches have been described for the construction of 7-azabicyclic systems, the efficacy of desymmetrization of *meso*-7-azanorbornene for the synthesis of these kinds of frame works remained unexplored for so many years. Visualizing the importance of 7-azabicyclo[2.2.1]heptanes system, our continuing efforts directed towards the development of novel methodologies for the construction of enantiopure 7-azanorbornene frame works. Our group has developed a conceptually new and efficient route *via* asymmetric desymmetrization of *meso*-**64** using chiral diolate of **65** to produce optically pure 7-azabicyclic frame **66** with excellent diastereoselectivity and yield (99% de, 82% yield)^[9] as outlined in Scheme 16. The enantiopure ketone **67** was exploited for the total synthesis of various conduramines and substituted cyclohexane derivatives.

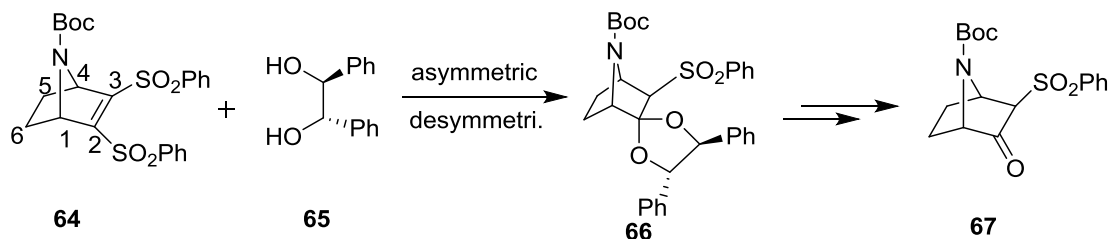

Scheme 16.

Mechanistically, the formation of product requires nucleophilic attack of alcoholate anion onto the vinylic carbon atom of **64**. The least encumbered trajectory is the one where phenyl group point upwards and alkyl to the side. The elimination of phenyl sulfinate anion generates vinylic sulfone moiety which is again being attacked by the second alcoholate anion to generate carbanion and finally protonation occurs according to *exo*-rule to give *endo* sulfone. However, this product seems to be a kinetic product as under basic condition it undergoes epimerization to give exclusively *exo* sulfone as a single diastereomer (Figure 5).

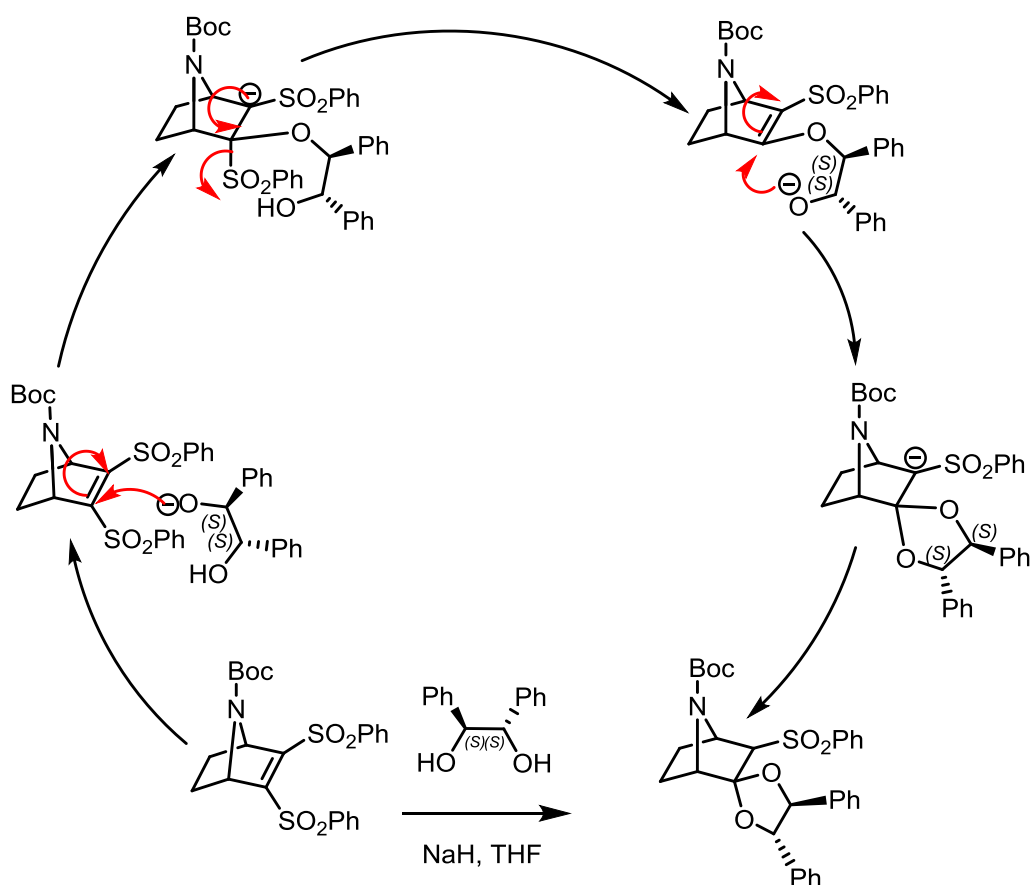

Figure 6. Mechanistic insight for desymmetrization.

1A.4. References.

- [1] Trudell, M.L.; Chen, Z. *Chem. Rev.* 1996, 96, 1179-1193.
- [2] Kricka, L. J.; Vernon, J. M. *Adv. Heterocycl. Chem.* 1974, 16, 87.
- [3] Spand, T. F.; Garraffo, H. M.; Edwards, M. W.; Daly, J. W. *J. Am. Chem. Soc.* 1992, 114, 3475
- [4] (a) Badio, B.; Daly, J. W. *Mol. Pharmacol.* 1994, 45, 563. (b) Qian, C.; Li, T.; Shen, T. Y. *Eur. J. Pharm.* 1993, 250, R13-R14. (c) Li, T.; Eckman, J.; Huang, D. F.; Shen, T. Y. *Bio-Org. Med. Chem. Lett.* 1993, 3, 2759.
- [5] Badio, B.; Garraffo, H. M.; Plummer, C. V.; Padgett, W. L.; Daly, J. W. *Eur. J. Pharm.* 1997, 321, 189.
- [6] (a) Xu, R.; Bai, D.; Chu, G.; Tao, J.; Zhu, X. *Bioorg. Med. Chem. Lett.* 1996, 6, 279. (b) Xu, R.; Chu, G.; Zhu, X. *J. Org. Chem.* 1996, 61, 4600. (c) Malpass, J. R.; Hemmings, D. A.; Wallis, A.L. *Tetrahedron Lett.* 1996, 37, 3911. (d) Zhang, C.; Gyermek, L.; Trudell, M. L. *Tetrahedron Lett.* 1997, 38, 5619.
- [7] Barlocco, D.; Cignarella, G.; Tondi, D.; Vianello, P.; Villa, S.; Bartolini, A.; Ghelardini, C.; Galeotti, N.; Anderson, J.; Kuntzweiler, T. A.; Colombo, D.; Toma, L. *J. Med. Chem.* 1998, 41, 674. (b) Ghelardini, C.; Galeotti, N.; Barlocco, D.; Bartolini, A. *Drug. Dev. Res.* 1997, 40, 251.
- [8] Brieady, L. E.; Mascarella, S. W.; Navarro, H. A.; Atkinson, R. N.; Damaj, M. I.; Martin, B. R.; Carroll, F. I. *Tetrahedron Lett.* 2001, 42, 3795.
- [9] (a) Pandey, G.; Tiwari, K. N.; Puranik V. G. *Org. Lett.* 2008, 10, 3611. (b) Pandey, G. S. K. Tiwari, R. S. Singh, R. S. Mali, *Tet. Lett.* 2001, 42, 3947-3949.
- [10] B. M. Trost, G. R. Cook, *Tet. Lett.* 1996, 37, 7485.
- [11] C. K. Lee, T. P. Loh, *Org. Lett.* 2005, 7, 2965-2967.
- [12] E. Gomez-Sanchez, E. Soriano, J. Marco-Contelles, *J. Org. Chem.* 2007, 72, 8656-8670.
- [13] D. Savoia, S. Grilli, A. Gualandi, *Org. Lett.* 2010, 12, 4964-4967.
- [14] (a) E. Albertini, A. Barco, S. Benetti, C. D. Risi, G. P. Pollini, V. Zanirato, *Tet. Lett.* 1997, 38, 681. (b) E. Albertini, A. Barco, S. Benetti, C. D. Risi, G. P. Pollini, V. Zanirato, *Tetrahedron.* 1997, 53, 17177.
- [15] B. P. Hart, H. Rapoport, *J. Org. Chem.* 1999, 64, 2050-2056.
- [16] D. A. Evans, K. A. Scheidt, C. W. Downey, *Org. Lett.* 2001, 3, 3009.

- [17] E. Bunuel, A. M. Gil, M. D. Villegas, C. Cativiela, *Tetrahedron*, 2001, 57, 6417-6427.
- [18] A. Hernandez, M. Marcos, H. Rapport, *J. Org. Chem.* 1995, 60, 2683.
- [19] W. F. J. Karstens, M. J. Moolenaar, F. P. J. T. Rutjes, U. Grabowska, W. N. Speckamp, H. Hiemstra, *Tet. Lett.* 1999, 40, 8629.
- [20] C. D. Jones, N. S. Simpkins, G. M. P. Giblin, *Tet. Lett.* 1998, 39, 1023.
- [21] M. Node, K. Nishide, T. Fujiwara, S. Ichihashi, *Chem. Commun.*, 1998, 2363–2364.
- [22] (a) Pandey, G.; Bagul, T. D.; Lakshmaiah, G. *Tetrahedron Lett.* 1994, 35, 7439. (b) Pandey, G.; Lakshmaiah, G.; Ghatak, A. *Tetrahedron Lett.* 1993, 34, 7301. (c) Pandey, G.; Laha, J. K.; Mohanakrishnan, A. K. *Tetrahedron Lett.* 1999, 40, 6065. (d) Pandey, G.; Bagul, T. D.; Sahoo, A. K. *J. Org. Chem.* 1998, 63, 760.
- [23] Pandey, G.; Sahoo, A. K.; Gadre, S. R.; Bagul, T. D.; Phalgune, U. D. *J. Org. Chem.* 1999, 64, 4990.
- [24] Pandey, G.; Laha, J. K.; Lakshmaiah, G. *Tetrahedron*, 2002 58, 3525-3534.

SECTION B: Synthetic studies towards pancratistatin and related natural products

1B. 1a Introduction.

Over the years, plants of the *Amaryllidaceae* family have long been known for their medicinal and toxic properties.^[1] These alkaloids have attracted considerable attention from the synthetic community because of their interesting structures and potent biological activities.^[1] Extremely low natural abundance, as well as practical complications in the separation of the desired compound from plant constituents had diminished the probability of reasonable supply by means of isolation. Therefore, significant efforts have been made in developing viable synthetic routes towards these important alkaloids (**68-71**).

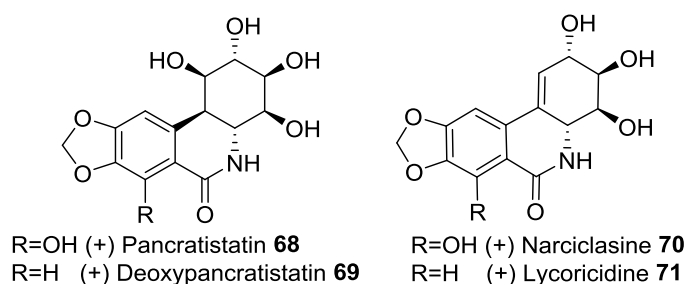

Figure 7: Structure's of isocarbostryl alkaloids.

The task has been addressed by various research groups in two different dimensions over two decades, one of the two has been dealing with the quest for short, high yielding synthesis of the naturally occurring isocarbostryl's which promoted the screening and development of great number of existing and new methodologies^[2-38] for their capabilities. The other dimension is looking for the potential and more bio-available derivatives to substitute them in all respects. This particular search resulted in the syntheses of various truncated and unnatural derivatives^[39-46] through which the scientific community has been enlightened with the substantial amount of this information regarding essential and variable pharmacophores of these molecules.

This section constitutes an update of the major developments in *Amaryllidaceae* isocarbostryls. Since the detailed discussion of all the literature reported syntheses have already been reviewed by many others^[47] and also it would be beyond the scope of this dissertation, the foregoing discussion would mainly focus on few of the important methodologies involved in the literature reported syntheses of Pancratistatin and related compounds (**68-71**).

1B.1b. Synthetic approaches toward Pancratistatin (**68**).

a) Danishefsky's approach

The first total synthesis^[18] of the racemic **68** was accomplished in 27 steps and in less than 1 % overall yield by employing iodolactonization on aryl cyclohexadiene **70** to obtain C₁-C_{10b} *cis*-relationship in **71**. The Overman rearrangement of **72** gave required C_{4a} amino group stereochemistry. Finally, vicinal *cis* oxygenation of C₃-C₄ double bond of **73** followed by lactamisation gave racemic **68** (Scheme-6).

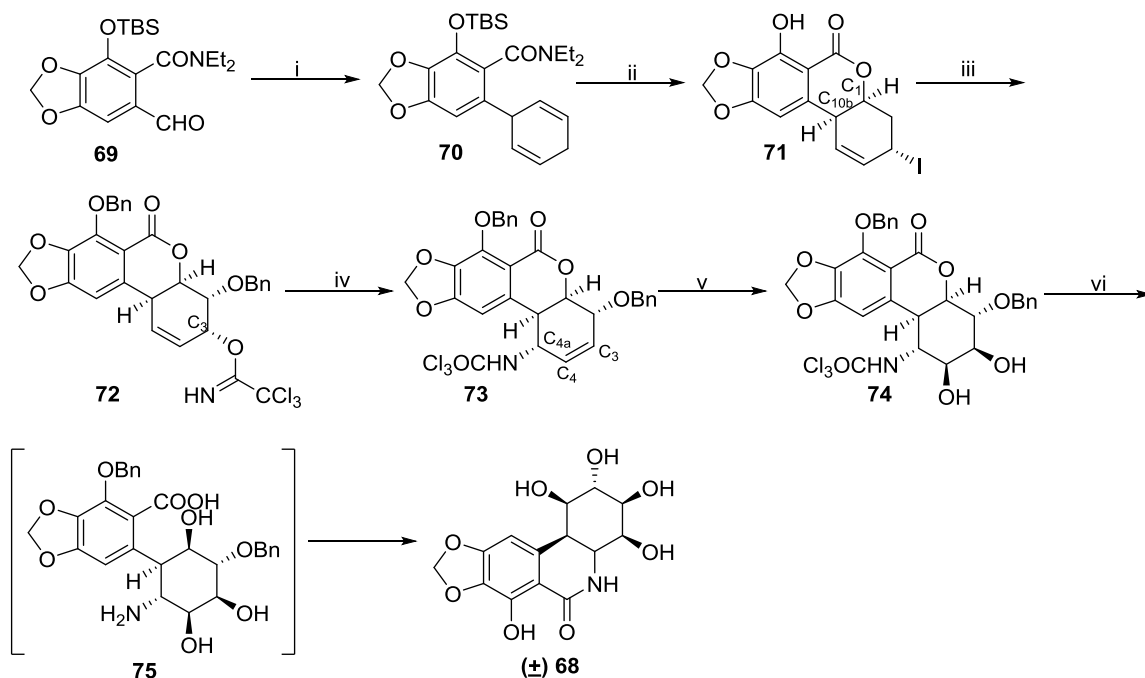

Scheme 17

Reagents and Conditions: i) a) *AllylMgBr*, Et₂O, -78 °C; b) *MsCl*, TEA, DBU, DCM; c) (*E*)-(2-nitrovinylsulfonyl) benzene, CHCl₃, reflux; d) *Bu*₃*SnH*, AIBN, PhCH₃,

reflux; ii) a) TBAF, THF, 0 °C; b) (Bu₂Sn)₂O, PhCH₃, 2h, I₂; iii) a) Ag₂O, DMF, BnBr, rt; b) OsO₄, NMO, DCM, THF, rt; c) DBU, toluene, reflux, 1.5 h; d) 2-acetoxyisobutyryl bromide, CH₃CN, 0 °C, 5min; e) OsO₄, NMO, THF, rt; f) (Bu₂Sn)₂O, PMBBBr, PhCH₃; Ag₂O, BnCl, DMF g) DDQ, DCM, H₂O; h) Zn, HOAc; iv) NaH, CCl₃CN, THF, 100 °C; v) OsO₄, NMO, THF, rt; vi) a) K₂CO₃, MeOH, DCM, reflux; b) H₂/Pd(OH)₂, 1 atm.

b) Hudlicky's approach

A concise enantioselective total synthesis^[19,20] of **68** was accomplished in 14 steps and in 2 % overall yield. This route involved the regioselective aziridine (derived from cyclohexadiene *cis*-diol **76**) ring opening of **77** using higher order cyano cuprate **78** to afford **79**. Finally, stereospecific opening of epoxide in **81** followed by lactamisation afforded **68** (Scheme-7).

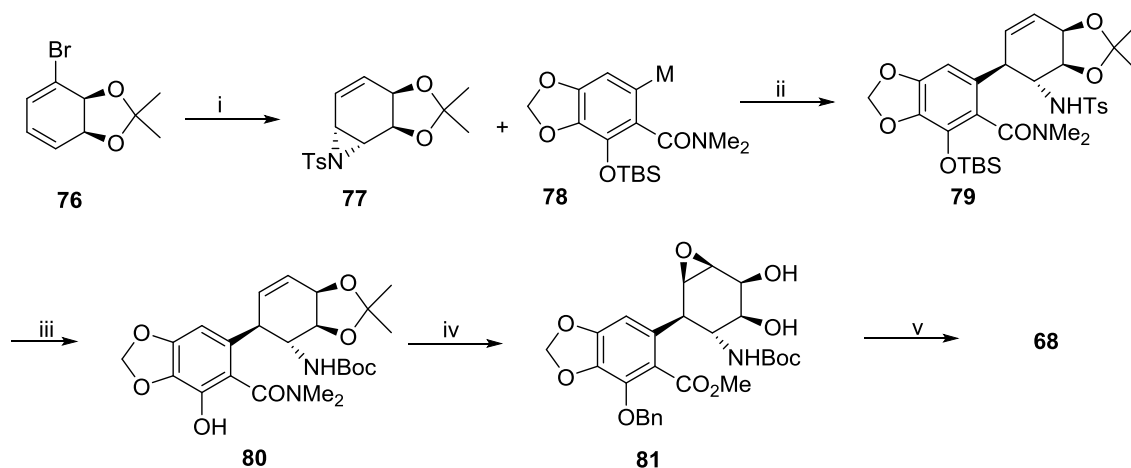

Scheme 18

Reagents and Conditions: a) $PhI=NTs$, $Cu(acac)_2$, CH_3CN ; b) $BuSnH$, AIBN, THF, ii) a) $s-BuLi$, TMEDA, THF, -90 °C; b) $CuCN$, -90 to -20 °C; c) Tosyl azide, -78 °C to rt; iii) a) $s-BuLi$, THF; b) (Boc)₂O; c) Na/antracene DME, 78 °C; d) TBAF, THF; iv) a) SMEAH/Morpholine, -45 °C, THF; b) BnBr, K₂CO₃, DMF; c) NaClO₂, KH₂PO₄, 2-methyl-2-butene, *t*-BuOH, H₂O; d) CH₂N₂; e) HOAc, THF, H₂O, 60 °C; f) *t*-BuOOH, VO(acac)₂, PhH, 60 °C; v) a) H₂O, BzONa (cat), 100 °C; b) H₂, Pd(OH)₂/C, EtOAc.

c) Trost's approach

An effective enantioselective total synthesis of **68** was developed^[21] in 19 steps and in 8 % overall yield by combining the palladium-catalyzed desymmetrization protocol^[21b] with a novel cyclization strategy (Scheme-8).

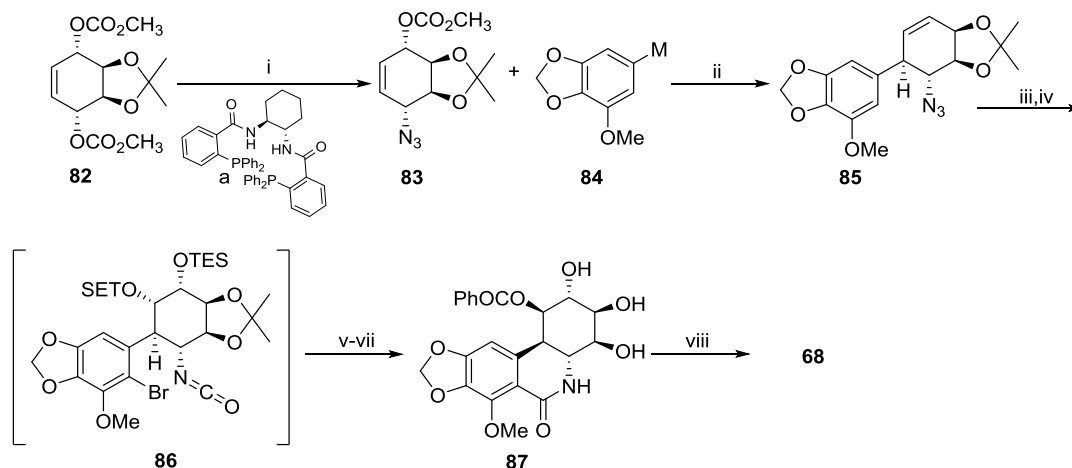

Scheme 19

Reagents and Conditions: i) 0.5 mol % (\square - C_3H_7PdCl)₂, **a**, 0.75 mol % , $TMSN_3$, CH_2Cl_2 , rt, (> 95% ee), 83 %; ii) **55**, $CuCN$, THF , ether, 0 °C; iii) a) *Cat*, OsO_4 , $NMO.H_2O$, DCM , rt, 62 % (two steps); b) $TESOTf$, 2,6-Lutidine, CH_2Cl_2 , quant; c) NBS , DMF , 75 %; iv) a) $(CH_3)_3P$, THF , H_2O ; b) $COCl_2$, THF , Et_3N ; c) $t-C_4H_9Li$, ether, -78 °C, 62 % (three steps); v) a) $TBAF$, THF , -78 °C; b) $SOCl_2$, Et_3N ; c) *cat.* $RuCl_3.H_2O$, $NaIO_4$, CCl_4 , CH_3CN , H_2O , rt, 72 %; vi) $PhCO_2Cs$, DMF , THF , H_2O , *cat.* H_2SO_4 , 75 %; viii) a) CH_3OH , K_2CO_3 , rt; b) LiI , DMF , 80 °C, 85 %.

d) Magnus's Approach.

An attractive synthesis of the antitumor alkaloid (+)-Pancratistatin was reported utilizing the β -azidonation reaction via prochiral 4-arylcyclohexanone (**91**).^[23]

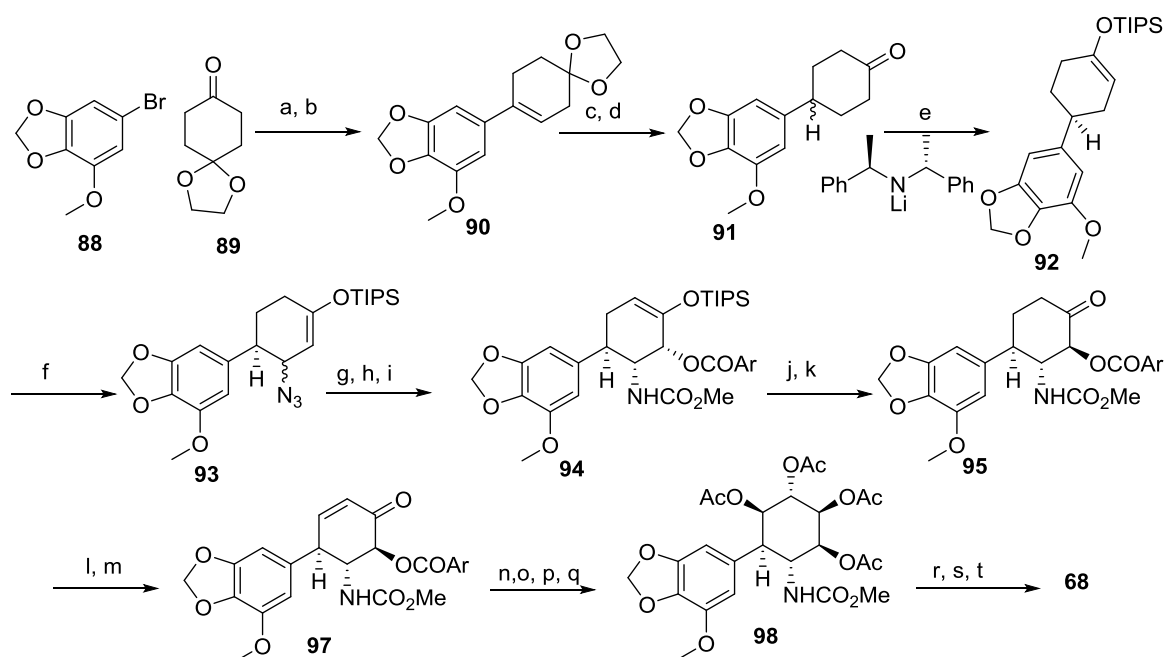

Scheme 20

Reagents and conditions: a) *n*-BuLi, THF, -78 °C; b) POCl₃, DBU, Py; c) H₂/Pd-C, EtOH; d) TsOH, MeOH; e) 48, LiCl, TIPSOTf, THF, -78 °C; f) (PhIO)_m, TMSN₃, DCM, -15 °C; g) LAH, Et₂O; h) MeOCOCl, Py; i) MCPBA; j) H₃O⁺; k) KOtBu, HMPA; l) TMSOTf, TEA; m) PhSeOCOCF₃ then H₂O₂; n) NaHCO₃, H₂O₂, MeOH; o) *L*-selectride, THF; p) PhCO₂Na, H₂O; q) Ac₂O, Py; r) Tf₂O, DMAP; s) BBr₃; t) NaOMe, MeOH.

e) Rigby's Approach.

Authors reported a new synthetic Scheme using a hydrogen bond guided aryl enamide photocyclization strategy for the synthesis of (+)-pancratistatin and (+)-narciclasine, its natural congener.^[12,13] In this approach, chemoenzymatic resolution was employed for the synthesis of optically active *syn*-epoxy alcohol **100**.

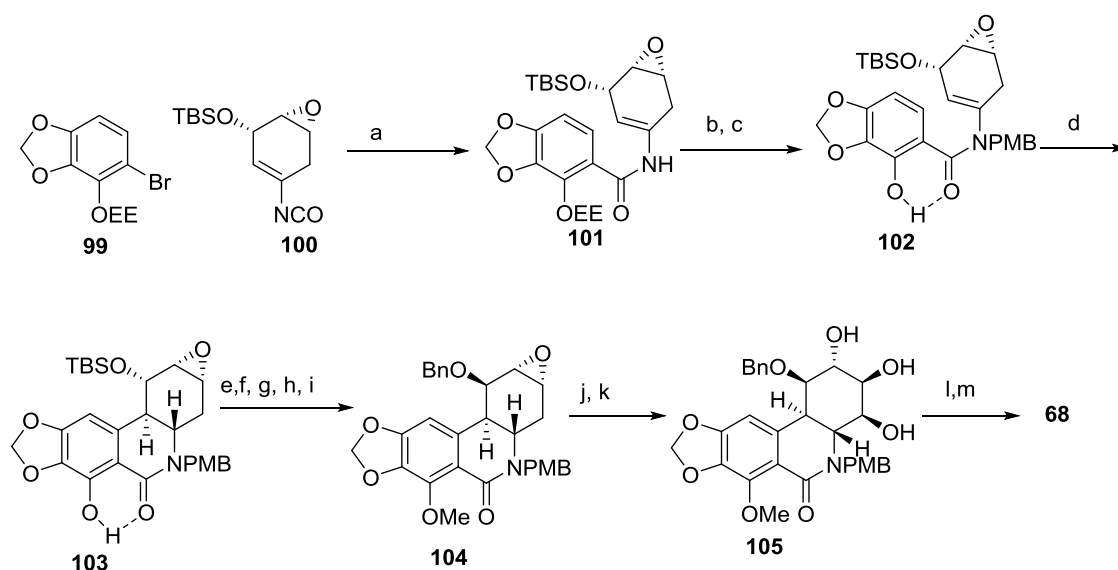

Scheme 21

Reagents and conditions: a) *n*BuLi, THF, $-70\text{ }^{\circ}\text{C}$; b) NaH, PMBBBr; c) PPTS, MeOH; d) *h*v, PhH; e) NaH, MeI, THF; f) TBAF, THF; g) Dess-Martin; h) NaBH₄, $-20\text{ }^{\circ}\text{C}$; i) NaH, BnBr; j) (PhSe)₂, NaBH₄, H₂O₂, reflux; k) OsO₄, NMO, *t*-BuOH; l) Pd(OH)₂/H₂; m) LiCl, DMF.

f) Kim's approach.

A new total synthesis of pancratistatin (**68**) was accomplished in 21 steps and 4 % overall yield by employing Claisen rearrangement of dihydropyranethylene **108** as a key step for the construction of A and C-ring in **110**, followed by stereo- and regio- controlled functional group interchange affording the final molecule (Scheme-9).^[25]

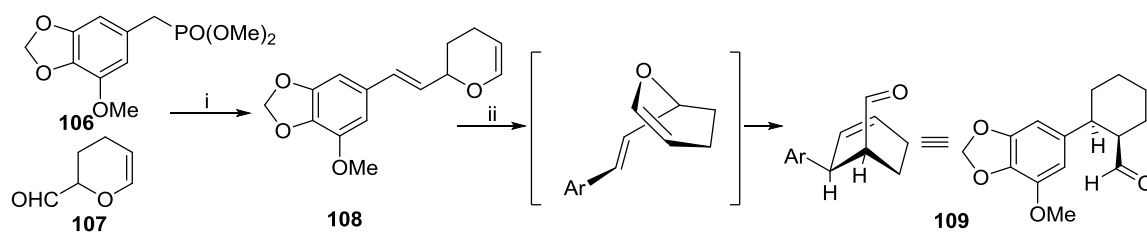

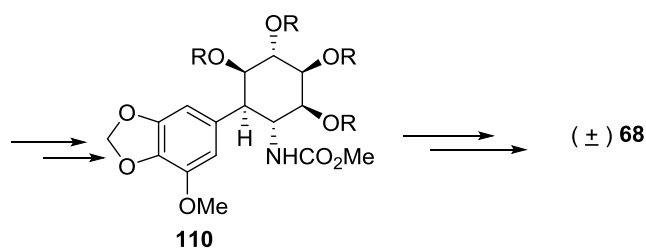

Scheme 22

Reagents and Conditions: i) LHMDS, THF, 0 °C to rt, 22 h, 60 %; ii) Toluene, sealed tube, 250 °C, 20 h, 78 %.

g) Li's Approach.

A concise approach towards (+)-pancratistatin (**68**) was developed in 13 steps and 9 % overall yield starting from pinitol by employing an ultrasound assisted arylcerium induced ring opening of cyclic sulfate **114** as a key step (Scheme-10).^[26a]

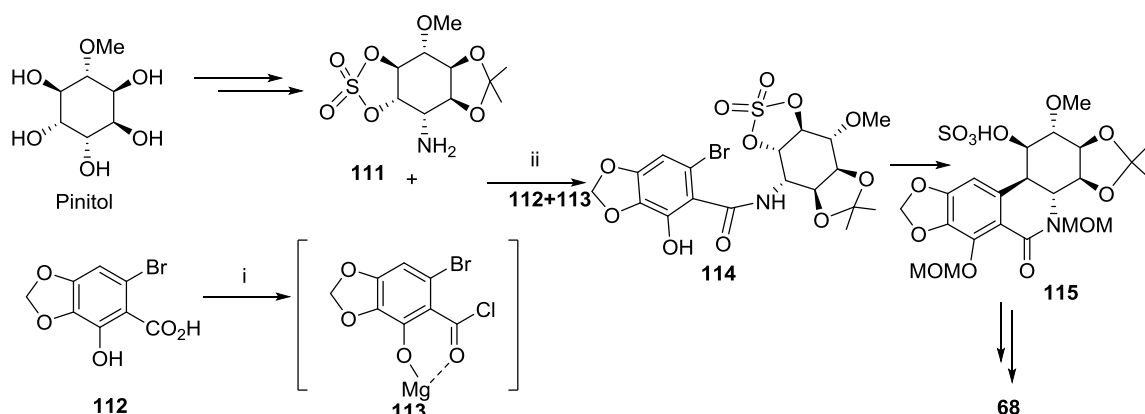

Scheme 23

Reagents and Conditions: i) MgBr₂ OEt₂, COCl₂, ether, 0 °C, 64, 64 %; ii) *t*-BuLi, CeCl₃, ultrasound, THF, -78 °C to rt, 72 %.

h) Alonso's approach.

An organocatalytic approach for the synthesis of racemic as well as (+)-pancratistatin was reported using 2-methoxymethylpyrrolidine as a catalyst to control the enantioselective [3+3] annulation of β-(hetero)aryl-α-nitro-α,β-enals with commercial 2,2-dimethyl-1,3-dioxan-5-one, a procedure that rendered highly oxygenated nitrocyclohexanes with five new stereocenters.^[26b]

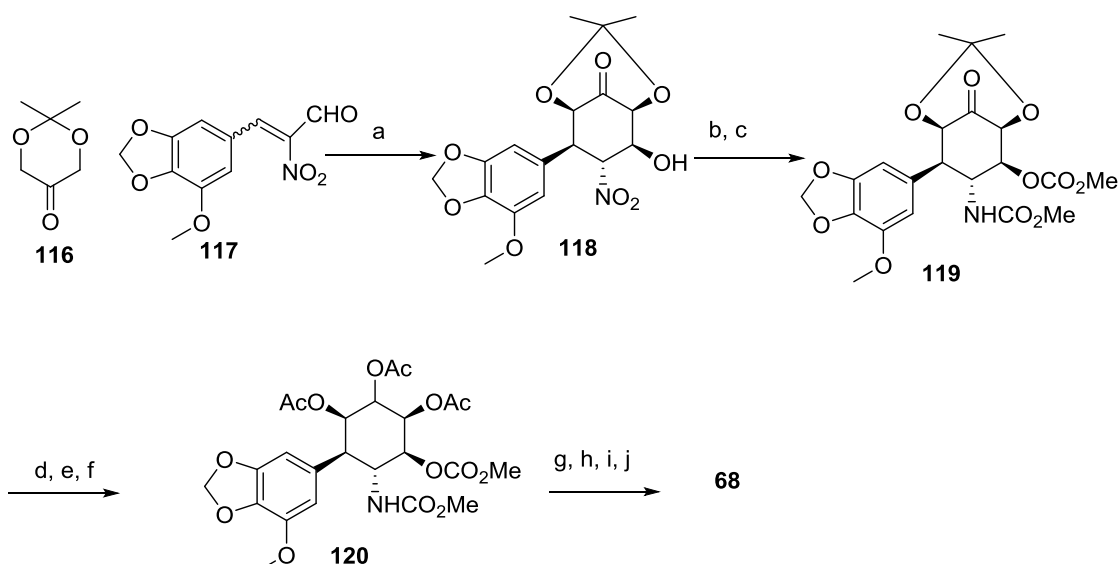

Scheme 24

Reagents and conditions: (a) *(R)*-2-(methoxymethyl)-pyrrolidine (b) H_4NCOOH , Pd-C, MeOH (c) $ClCO_2Me$, DMAP, CH_2Cl_2 (d) Dowex 50WX, MeOH (e) $NaBH(OAc)_3$, DCE/THF (f) Ac_2O , DMAP, Et_3N , CH_2Cl_2 (g) Tf_2O , DMAP, CH_2Cl_2 , $0^\circ C$ (h) HCl, Dioxane, rt (i) BBr_3 , CH_2Cl_2 , $-78^\circ C-0^\circ C$, 50% (j) NaOMe, MeOH/THF, 86%

1B. 1c. Approaches towards (+)-7-deoxypancratistatin (69).

a) Paulsen's approach

The first chiral synthesis of (+)-7-deoxypancratistatin (69) was accomplished by conjugate addition of 121 to nitroolefin 122 (derived from D-glucose) followed by lactamization to afford the final molecule in total 9 steps and 6.5 % overall yield (Scheme-11).^[3]

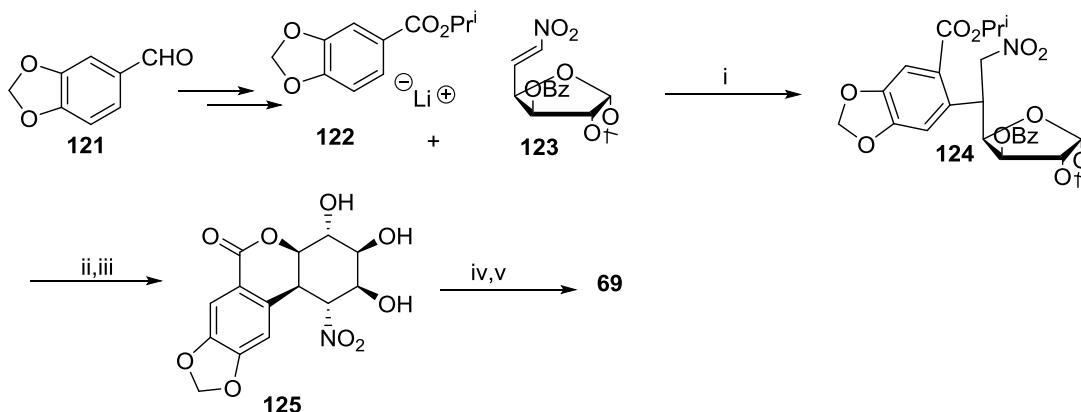

Scheme 25

Reagents and Conditions: i) THF, $-78^\circ C$; ii) HOAc; iii) K_2CO_3 , MeOH; iv) Pd/H₂, EtOH; v) K_2CO_3 , MeOH.

b) Keck's approach

An efficient total synthesis of **69** was accomplished in 13 steps and 21 % overall yield by employing a radical cascade strategy involving 6-*exo* radical cyclization of phenyl radical **131** as the key step (Scheme-12).^[7,8]

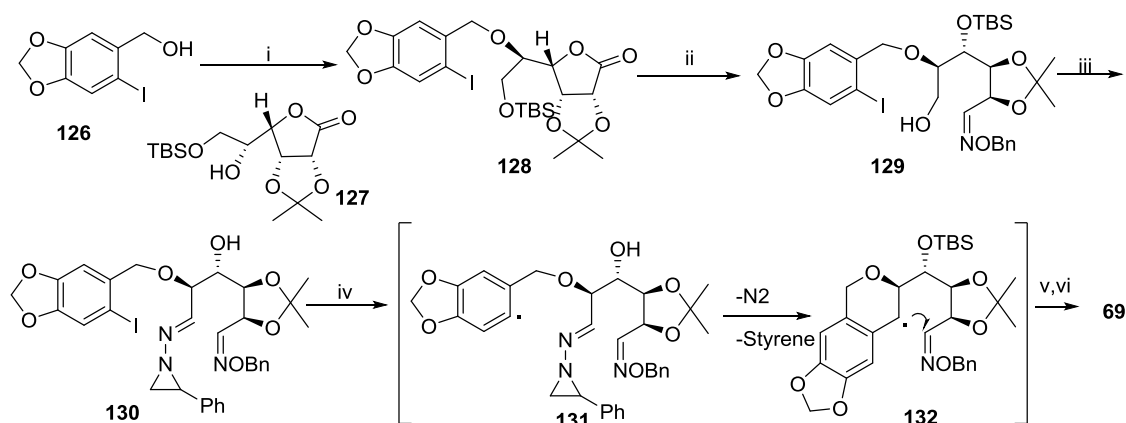

Scheme 26

Reagents and Conditions: i) a) NaH, Cl_3CCN , $0^\circ C$; b) TfOH, THF, $0^\circ C$, 75 % (two steps); ii) a) *L*- Selectride, DCM, $-78^\circ C$; b) HCl.H₂NOBn, Pyridine 96 %, (two steps); c) TBSOTf, 2,6-lutidine, DCM, $0^\circ C$; d) HF.Pyridine, THF; iii) a) TPAP, NMO, 4 Å MS; b) 1-amino-2-phenylaziridine, EtOH, $0^\circ C$. 83 % (two steps); iv) a) Ph_3SnH , AIBN, PhH, 78 %; v) SmI_2 , TFAA, 88 %; vi) a) PCC, 83 %; b) $BF_3.OEt_2$; b) K_2CO_3 , MeOH, 88 % (two steps).

c) Plumet's approach.

Total synthesis of **69** was accomplished in 21 steps with 3 % overall yield starting from readily available furan by following the sequence as shown in Scheme 13.^[31]

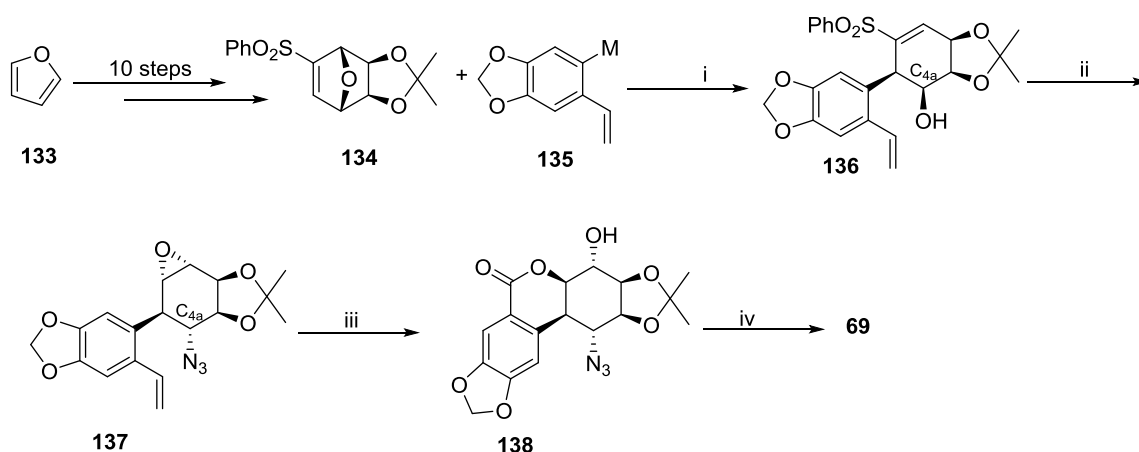

Scheme 27

Reagents and Conditions: i) a) $BuLi$, THF/Tol, $-78^\circ C$; ii) a) Bu^tOOH , $BuLi$, THF, $-78^\circ C$, 84 %; b) $Na-Hg$, MeOH/THF, $-23^\circ C$, 81 %; c) Tf_2O , pyr, CH_2Cl_2 , $0^\circ C$; d) Bu_4NN_3 , benzene, 82 %; iii) a) $NaIO_4/RuCl_3$, $CH_3CN/CCL_4/H_2O$; iv) a) H_2 , 40 psi, $Pd(C)$ 10 %, MeOH, 88 %; b) CF_3COOH , $0^\circ C$; c) K_2CO_3 , MeOH, reflux, 82 %.

d) Madsen's Approaches

Approach-1

The utility of olefin metathesis was explored in the elaboration of C-ring of 7-deoxypancratistatin (**69**) by Madsen *et al.* in total 13 steps and 1.4 % overall yield. (Scheme14). In their synthesis, the diene **142** was subjected to metathesis with Grubbs' first-generation catalyst to afford cyclohexene **143** which was oxygenated to complete the synthesis of the natural product.^[32a]

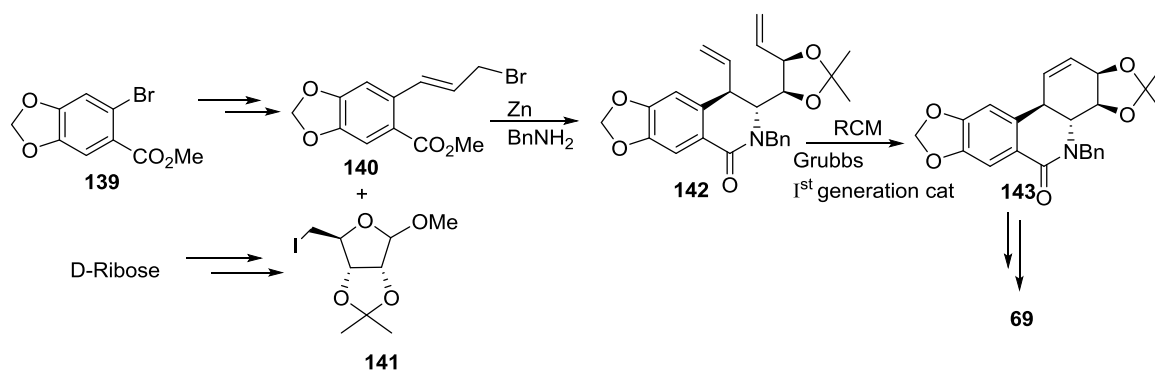

Scheme 28

Approach-2

In this strategy, reaction between ribofuranoside **144** (derived from D-Xylose) and **140** in the presence of zinc followed by ring-closing metathesis yielded **145:146** in 2:1 ratio. Subsequent Overman rearrangement^[32b] of **145**, dihydroxylation and deprotection afforded **69** in 23 steps with 4.3 % overall yield (Scheme-15).

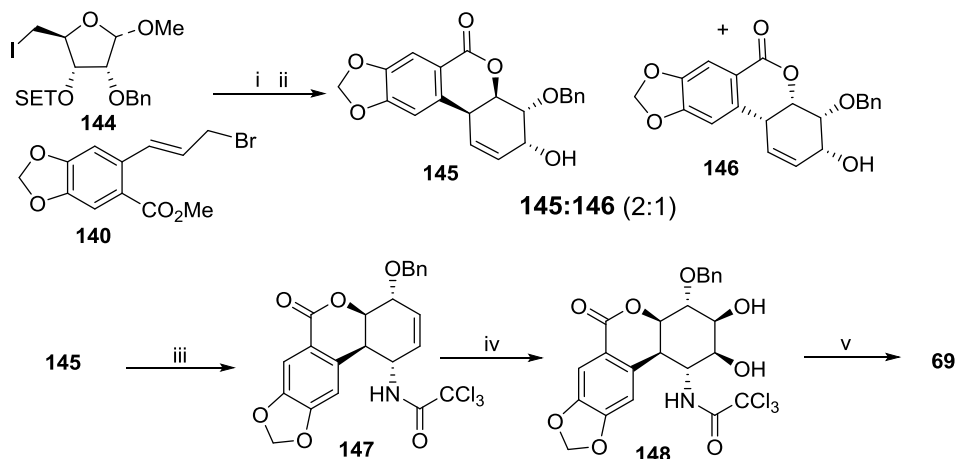

Scheme 29

Reagents and Conditions: i) a) Zn, THF, H₂O, 40 °C, ultrasound, then H⁺-resin, MeOH, 50 °C, b) Grubbs Ist generation catalyst, CH₂Cl₂, 40 °C; ii) CCl₃CN, DBU, CH₂Cl₂, -45 °C to -20 °C, then 1 mmHg, neat, 120 °C; iii) OsO₄, NMO, THF; iv) a) K₂CO₃, MeOH, 65 °C, b) H₂, Pd(OH)₂/C, EtOAc.

e) Padwa's approach.

A racemic synthesis was reported by Padwa *et al.* in 23 steps and 3 % overall yield. Key features of the synthetic strategy included 1) one-pot Stille/intramolecular Diels-Alder cycloaddition cascade to construct the core skeleton 2) conversion of the initially formed Diels-Alder adduct into an aldehyde intermediate **153** which undergoes a stereospecific decarbonylation reaction mediated by Wilkinson's catalyst to set the *trans*-B-C ring junction of **69**.^[33]

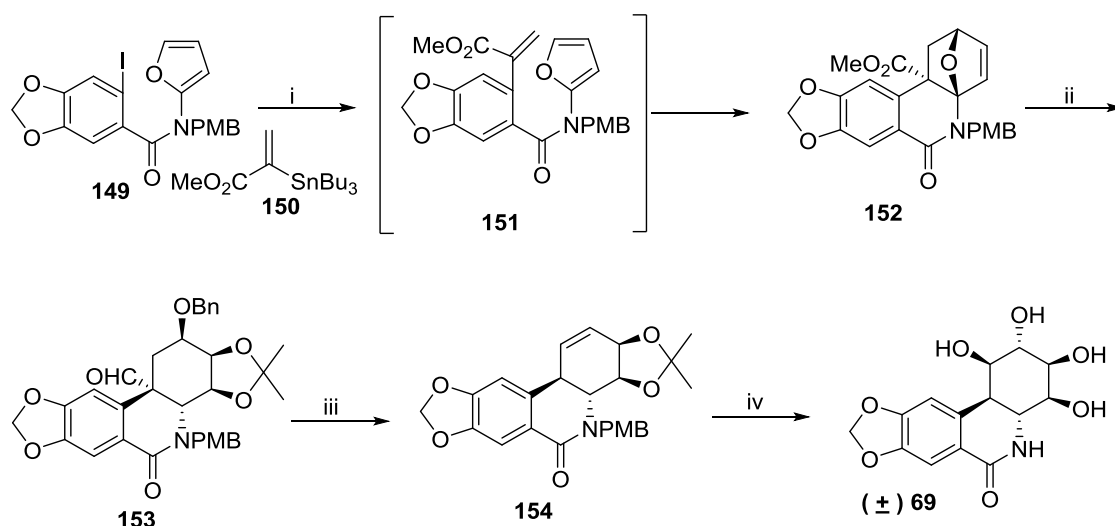

Scheme 30

Reagents and Conditions: i) Pd (0), 150, 82 %; ii) a) NaH, PhCH₂Br, b) LiOH, THF; c) (COCl)₂, ZnBH₄; c) TPAP, NMO, 70 %; iii) a) RhCl(PPh₃)₃, heat, 63 %, b) H₂, Pd(OH)₂, c) NaH, CS₂, MeI, heat, 85 %; iv) a) OsO₄/NMO, 68 %, b) SOCl₂, c) NaIO₄/RuCl₃, 82 %, d) PhCO₂Cs, e) H⁺, 75 %, f) LiOH, g) H₂, Pd(OH)₂, 80 %.

1B.1d. Background and our group contribution:

In the last decade our group was actively involved in the synthesis of different kinds of amaryllidaceae classes of alkaloids. Among many of these important alkaloids, synthesis of pancratistatin and its natural congeners were also targeted through various synthetic designs. We had developed an attractive approach^[48] for generation of arene radical cation through photoinduced electron transfer processes and its intramolecular cyclization with tethered silyl enol ether as a nucleophile for benzannulation reaction. The reaction was initiated through single electron transfer processes from excited state of electron rich arenes to the ground state of electron deficient 1, 4-dicyanonaphthalene (DCN) as represented in the Fig-8.

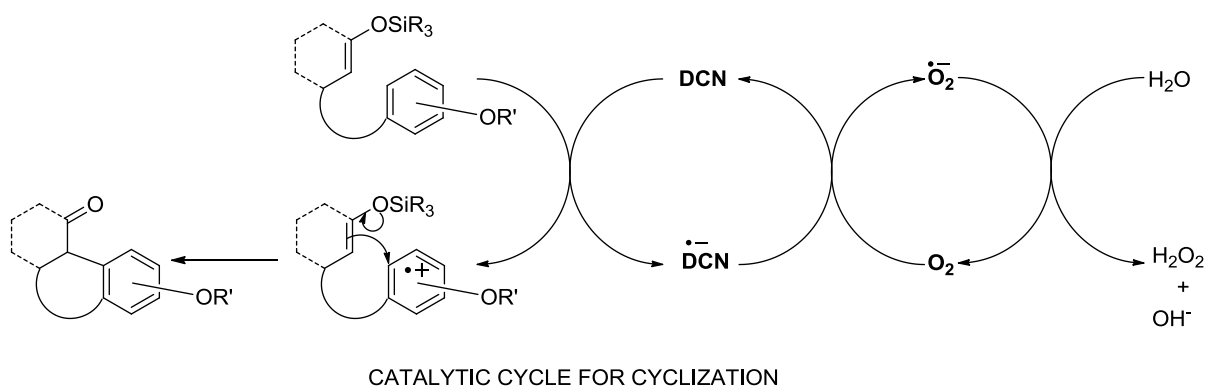
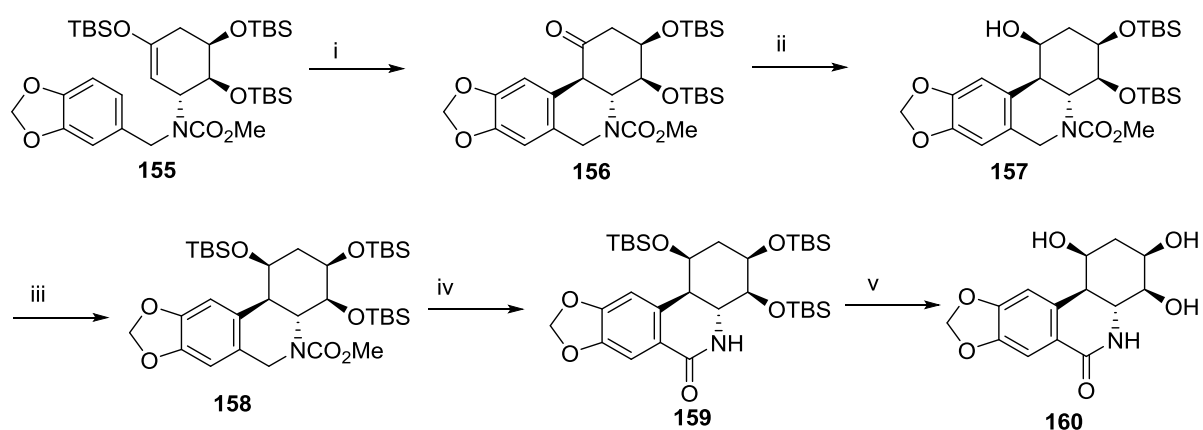

Figure 8: Mechanistic insight for benzannulation.

This methodology was applied for a successful synthesis of model compound (+)-**160**, 7-dideoxypancratistatin in a very concise manner^[49] as depicted in Scheme 31.



Reagents and conditions: (i) $h\nu$, DCN, CH_3CN , H_2O , 6h, 68% (ii) NaBH_4 , EtOH , 0°C -rt, 100% (iii) TBSCl, Im, DMAP, DCM, 85% (iv) (a) RuCl_3 , NaIO_4 , EtOAc , H_2O , 90% (b) NaOMe , MeOH , reflux (v) TBAF, THF, 95%

Scheme 31

Excited over this result, we evaluated the possibility of total synthesis of pancratistatin as shown in Scheme 32. However, unfortunately the optimized reaction condition failed to produce any cyclized product.

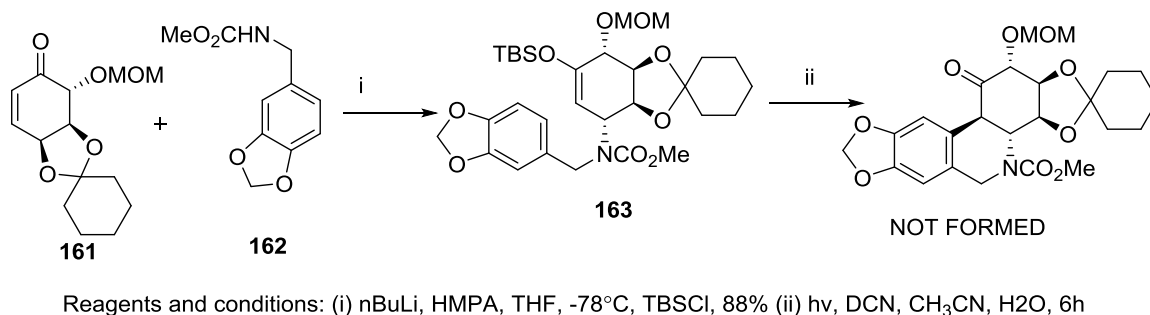

Scheme 32

Another interesting approach was also reported^[50] by us in recent past involving aza-Michael reaction for the crucial cyclization, unfortunately, the resultant BC-ring junction was observed to be 'cis' instead of desired 'trans' (Scheme-33).

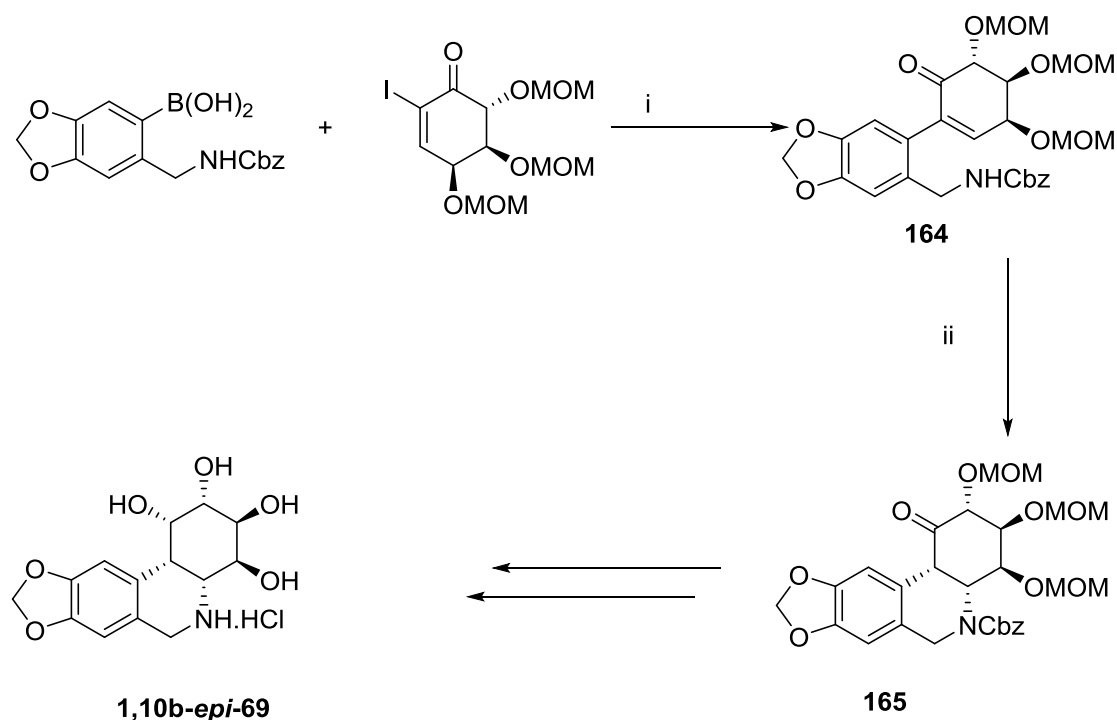

Scheme 33

Reagents and conditions: (i) $\text{Pd}(\text{PPh}_3)_4$, 5 mol%, 84% (ii) $n\text{BuLi}$, HMPA, THF, 83%

1B.1e. Intention of present study

The ideal and/dream cancer drug is a molecule which would selectively eliminate the cancerous cell without affecting normal human cells. Such a magic drug, though very much desirable, is still anonymous. A recent study^[51,52] involving pancratistatin and some related compounds invoked a rare sense of hope among scientists in this regard,

where it was shown that pancratistatin causes preferential apoptosis of tumor cells without affecting much to the healthy cells. Such a discovery is indeed very encouraging but biological studies involving pancratistatin and its derivatives suffer from a number of road blocks. One primary issue is the availability of sufficient amount for such studies where as the other concern is poor water solubility. That's why a number of creative new approaches^[53,54] to the syntheses of *Amaryllidaceae* constituents (**68-71**) continue to appear despite the fact that almost thirty years elapsed since the first synthesis of pancratistatin (**68**). Several groups around the globe are still in search of an ideal/ near ideal synthetic sequence which will solve at least its availability concern. Our group is also involved in this area for over a decade. Our present intention is to find out a synthetically viable route which will provide good amount of compound for preclinical studies. The following section will elaborate our success as well as failures and disappointments.

1B.2. Retrosynthetic analysis:

We viewed our synthetic approach for **68** and **69** through retrosynthetic path as outlined in the Scheme-34. The key step envisaged in our approach was the conjugate addition of aryl Grignard reagent to the fully functionalized **167** in presence of Cu(I) salt. We imagined the addition would undergo in a *trans* fashion to the protected β -amino group. The amino and aromatic group cyclization could be attained in later stage by employing Bischler-Napieralski reaction^[55]. The requisite **167**, crucial for this transformation could be obtained from **168** through Seagussa-Ito oxidation protocol.^[56] The **168** in turn could be synthesized from the acetonide protected **169** by simple oxidation which could arise from selective acetonide protection of **170** generated by regioselective opening of the epoxide **171**. The required *syn*-epoxide **171** could possibly be assembled from *trans*-aminocyclohexenol **172** via chelation controlled stereoselective epoxidation of the double bond. The *trans*-aminocyclohexenol synthesis has been achieved earlier in our laboratory starting with enantiomerically pure 7-azabicyclo[2.2.1]hept-2-one (**67**) via intermediacy of **174** through an anionic rearrangement involving C4-N7 bond rupture.

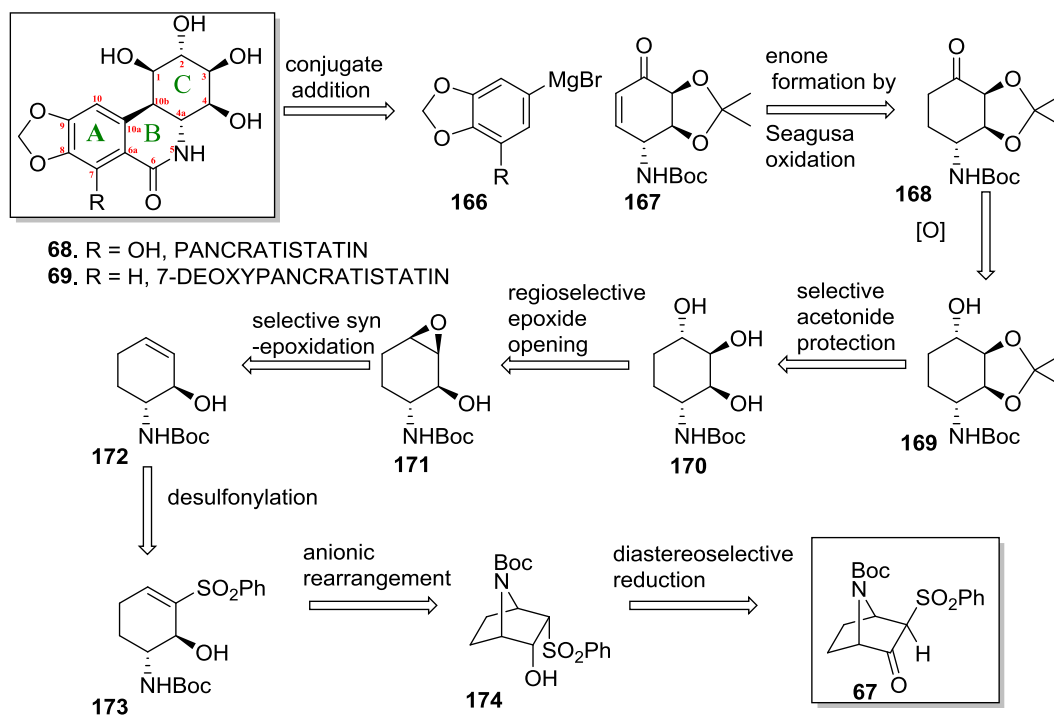

Scheme 34. Retrosynthesis of pancratistatin

1B.3. Results and discussions:

In order to test the feasibility of our hypothesis as depicted in above retrosynthetic analysis, we needed **172** in good amount. Therefore, we proceeded towards this molecule from **67** as described below:

1B.3a. Synthesis of 172:

After having required **67** in hand by following previously reported^[57] procedure by our group, we proceeded to reduce the carbonyl moiety in stereoselective manner. Interesting results were obtained when reduction with lithium borohydride was attempted at variable temperature. The results showed preference of *exo*-**175** at higher temperature and *endo*-**174** at lower temperature. Fortunately, both diastereomers were easily separable by silica gel column chromatography. The results are summarized in Table 1.

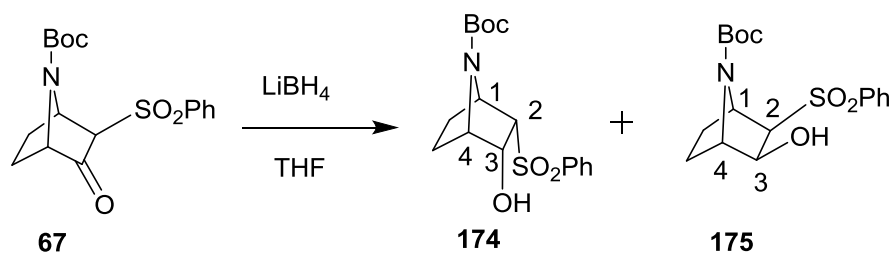

Scheme 35. Reuction of 67

The relative configurations of both the alcohols were unambiguously deduced from their ¹H NMR spectrum. For illustration, the H-2 proton in **174**, appeared as a doublet of doublet ($J = 9.3, 4.4$ Hz) coupling with bridgehead H-1 and H-3 whereas H-3 appeared as ddd ($J = 9.6, 9.3, 4.6$ Hz) coupling with H-2, bridgehead H-4 and O-H proton. The coupling with O-H (d, $J = 9.6$ Hz) was confirmed by D₂O exchange which simplified the coupling to dd ($J = 9.3, 4.6$ Hz). Similarly, in the case of **175**, the H-2 showed doublet ($J = 6.5$ Hz) coupling only with H-3 whereas H-3 appeared as dd ($J = 9.7, 6.5$ Hz) coupling with H-2 as well as O-H indicating the *endo*-orientation of proton. This result is in complete agreement with the observation reported previously by our group^[57] and others^[58] where no coupling occurs between bridgehead and the *endo*-hydrogen in 7-azabicyclo[2.2.1]heptane system.

Table 1. Yields and ratio of **174** and **175** during reduction of ketone.

Entry	Temperature (°C)	Ratio (174 / 175)	Time	Yield(%) (combined)
1	-78	7:3	30 min.	75
2	-90	7.5:2.5	45 min.	70
3	25	1:9	12 h	78

1B.3b. Anionic fragmentation

The ring opening of **175** by the addition of excess of methyl magnesium bromide^[57] in a THF solution at room temperature produced **176** in 80% yield as a crystalline solid $\{[\alpha]_D^{25} -69.0 (c 1.00, CHCl_3), m.p. 131\text{ }^\circ\text{C}\}$ (Scheme 36).

In the ^1H NMR of **176**, the proton signal appearing at $\delta 7.19$ (dd, $J = 4.9, 2.5$ Hz, 1H) was assigned to olefinic proton. The mass spectrum of **176** showed molecular ion peak at 354 ($M^+ + H$).

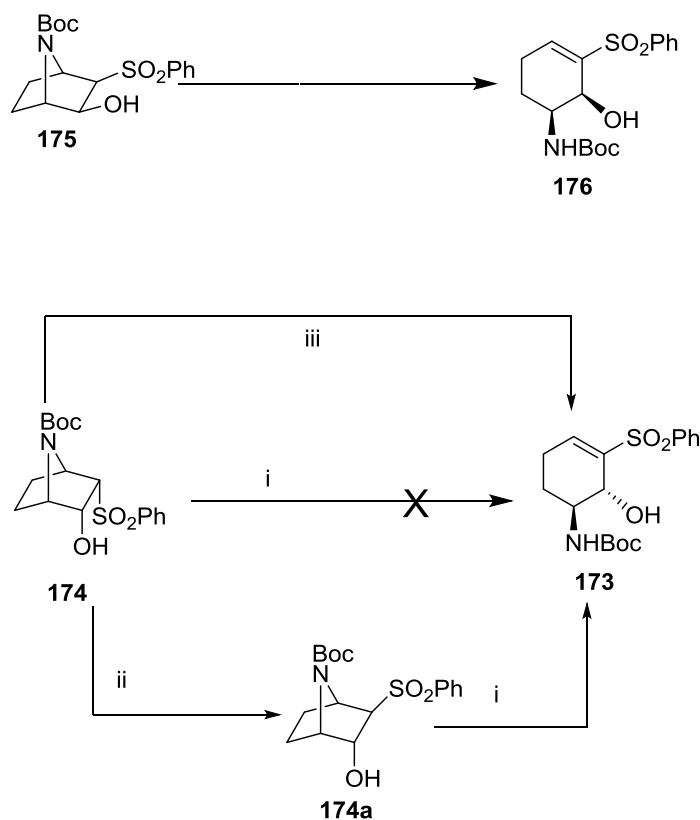
Scheme 36. Synthesis of **173**

Reagents and Conditions : (i) MeMgBr (6equiv.), THF, rt, 3 h, 80% (ii) KHMDS, THF, -78 °C, 4 h to rt, 70% (iii) MeMgBr (10 equiv.), THF, 0 °C- rt, 10 h, 88%

However, a similar reaction of **174** with methyl magnesium bromide failed to give any product (Scheme 36). A close look at the structure of **174** indicated that in this molecule, the orientation of sulfone moiety is *endo* which possibly do not allow the fragmentation due to lack of antiperiplanarity between the bonds to be cleaved. Fortunately, the sulfone group of **174** could be successfully epimerized using KHMDS to **174a** (70 %) which on subjecting to ring opening reaction under identical experimental protocol as described above for **175**, yielded **173** (Scheme 23) in 70% yield as a crystalline solid { mp 125 °C [α]_D²⁵ +14.6 (c 0.40, CHCl₃) }

In the ¹H NMR of **173**, the signal appearing at δ 7.19 (dd, *J* = 4.9, 2.5 Hz, 1H) was assigned to olefinic proton. The mass spectrum of **173** showed molecular ion peak at 354 (M⁺+H). Since we were interested to increase net yield of **173**, reaction of **174** with 10 equivalent of MeMgBr at 0^o C followed by stirring for additional 6-8 h at rt produced **173** in excellent yield (85 %). The sulfone moiety was removed selectively using 6% sodium amalgam in presence of NaHPO₄ as buffer in methanol to obtain **172** in over 83% isolated yield (Scheme 37).

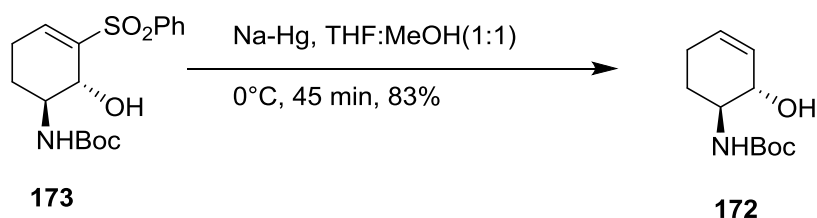

Scheme 37. Synthesis of 172

1B.3c. Synthesis of 167:

The **167**, central molecule in our synthetic planning, was achieved in multigram quantity by following the sequences as shown in Scheme-38

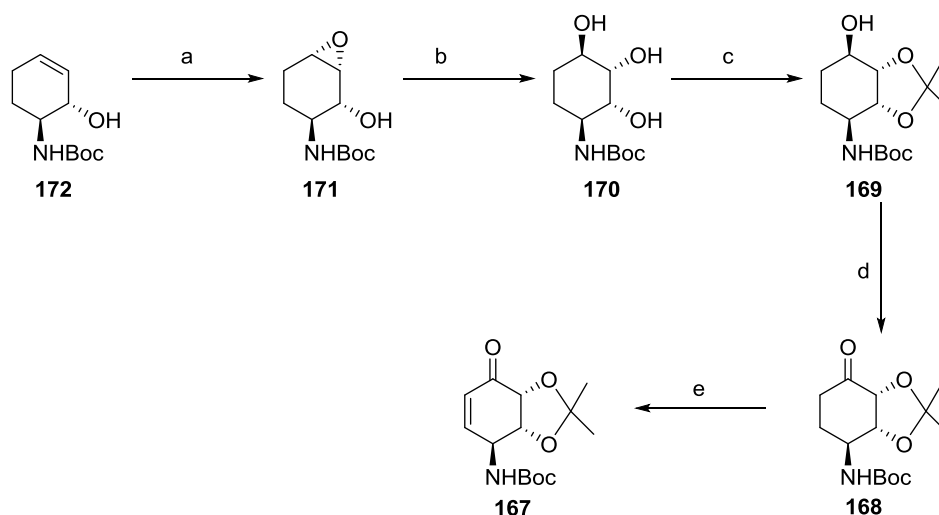

Reagents and conditions: (a) *m*-CPBA, DCM, 0°C to rt, 3h, 79%; (b) 0.5M H₂SO₄, THF:H₂O (1:1), 1h, 99%; (c) 2,2-DMP, pTSA, dry DMF, rt, 1h, 95%; (d) IBX, DMSO, rt, 12h, 94%; (e) LiHMDS, TMSCl, 0°C to rt, 4h then Pd(OAc)₂, acetonitrile, rt, 24h, 67%;

Scheme 38. Synthesis of 167

Compound **172** upon epoxidation using *m*-CPBA in dichloromethane produced **171** in 79 % yield as a single diastereomer. The ¹H NMR spectrum of **171** displayed two multiplets at δ 3.37 and δ 3.34-3.31, integrating for one proton each, which were assigned to two protons attached to epoxide ring. The coupling constant for the proton at δ 3.37 (dd, *J* = 2.0, 4.0 Hz, 1 H) indicated it to be a *syn* epoxide. The proton attached to the free hydroxyl group was assigned at δ 3.75 (dd, *J* = 2.3, 8.5 Hz, 1 H) and the proton attached to NHBoc group discerned at δ 3.59 (dd, *J* = 0.8, 8.8 Hz, 1 H). The N-H proton appeared at δ 4.53. The 9 proton of the *tert*-butyl carbamate group appeared at δ 1.46 as a singlet. The remaining four protons accounting for two methylene groups appeared at δ 2.02 - 1.96 (m, 2 H), 1.76 - 1.69 (m, 1 H), 1.36 - 1.28 (m, 1 H), respectively.

The ¹³C NMR spectrum of **171** displayed nine carbon signals at δ 156.7, 80.1, 73.2, 56.7, 54.6, 50.7, 28.3, 26.9 and 22.0. DEPT experiment revealed the presence of two quaternary carbon signals at δ 156.7 and 80.1 which could be assigned to the carbonyl group of carbamate and quaternary carbon of *tert* butyl group, respectively. The molecular ion peak was found at 252 (M⁺+Na⁺) in the mass spectrum of **171**.

We attempted epoxide ring opening using different Lewis acid and alcohols but all efforts remained unsuccessful. When **171** was treated with aq. HCl, the resultant reaction mixture turned out to be an inseparable mixture of diastereomers. Finally, we

succeeded in opening the epoxide ring by treating with 1M sulphuric acid solution in tetrahydrofuran at rt, which produced **170** in almost quantitative yield and in analytically pure form.

The ^1H NMR spectrum of **170** in deuterium oxide displayed multiplets between δ 3.83- 3.60, integrating for four protons, assignable to the protons attached to three OH groups and one NHBoc group. The nine proton of Boc group appeared as a singlet at δ 1.37 and the remaining four protons appeared in between δ 1.84 - δ 1.45 as two sets of multiplets. The ^{13}C NMR spectrum of **170** displayed nine carbon signals at δ 157.9, 81.0, 72.5, 71.1, 69.3, 50.4, 27.6, 25.9, 24.3. The molecular ion peak was found at 270 (M^+Na^+) in the mass spectrum of **170**.

The two *syn* hydroxyl group of **170** were preferentially protected as acetonide to get **169** (95% yield) by following literature procedure.^[59] The ^1H NMR spectrum of **169** displayed four multiplets integrating for five protons in low field region between δ 4.77 - 3.80 which were assigned to four protons of the cyclohexane ring and the N-H proton. The two methyl groups, characteristics of acetonide, appeared separately at δ 1.51 (s, 3 H) and δ 1.36 (s, 3 H). The ^{13}C NMR spectrum of **169** displayed twelve carbon signals at δ 155.3, 108.9, 79.6, 78.8, 77.34, 69.3, 49.8, 28.3, 28.0, 26.4, 26.1, 24.0. In DEPT spectrum three quaternary carbon signals were visible at δ 155.3, 108.9, 79.6 which corresponded to carbonyl group of Boc, quaternary carbon attached to acetonide and that of *tert*- butyl group of Boc. The four signals at δ 78.8, 77.34, 69.3, 49.8 were assigned to the cyclohexyl methine carbons attached to hetero atoms. The C5 and C6 methylenic carbon signals were observed at δ 26.1 and 24.0. The three *tert* butyl carbamate methyl group carbons appeared together at δ 28.0. The molecular ion peak was found at 310 (M^+Na^+) in the mass spectrum of **169**.

Compound **169** was oxidized to **168** (60%) with IBX (2-iodoxybenzoic acid) initially by refluxing in ethyl acetate. However, yield was improved to 94% by stirring in DMSO at rt. The two hydrogens attached to the 'O' atoms of acetonide group appeared together as multiplets at δ 4.51 - 4.38 (m, 2 H). The proton attached to NHBoc was visible at δ 4.01 - 3.88 (m, 1 H). The two protons α -to carbonyl moiety appeared at δ 2.56 - 2.42 (m, 2 H) as multiplets. Remaining two cyclohexyl protons appeared separately at δ 2.34 - 2.12 (m, 1 H) and 2.03 - 1.89 (m, 1 H) as multiplets.

Twelve protons appeared between δ 1.50 - 1.41 which was assigned to three methyl groups of Boc group and a methyl group of acetonide. The other methyl group protons of acetonide were visible at δ 1.38 (s, 3 H) as a singlet. The ^{13}C NMR spectrum of **168** displayed twelve carbon signals at δ 207.2, 155.4, 110.5, 80.3, 79.5, 77.9, 49.1, 34.8, 28.3, 27.0, 25.7, 25.3. In DEPT spectrum four quaternary carbon signals were easily detected at δ 207.2, 155.4, 110.5, 80.3 corresponding to carbonyl group attached to cyclohexane ring and Boc, quaternary carbon attached to acetonide and that of *tert*-butyl group of Boc. The molecular ion peak was found at 308 ($\text{M}^+ + \text{Na}^+$) in the mass spectrum of **168**.

The conversion of **168** to **167** proved to be troublesome initially. Direct method from ketone to enone as described^[60] by Nicolaou *et al.* proved unsuccessful as very miniscule amount of **167** was detected on TLC with no recovery of even starting material. Later, we explored the possibility of employing a two step protocol by first attaching the SePh group α to the ketone followed by oxidation using H_2O_2 . Though this method led to successful isolation of crucial enone **167** but it suffered from low isolation yield (only 20%). Disappointed by this, we attempted to perform Seagussa-Ito oxidation protocol^[56] of enol ethers. For this purpose, we first converted **168** to corresponding silyl enolether by reaction with LiHMDS and trimethylsilyl chloride at 0°C - rt. Usual work up followed by stirring of the crude with $\text{Pd}(\text{OAc})_2$ in anhydrous DMSO in the presence of oxygen for 24 h gave **167** up to 55% yield. Later it was found out that use of *p*-benzoquinone as an additive in this reaction improved the yield up to 67%.

The characteristic olefinic protons were easily characterised at δ 6.80 (tdd, $J = 0.6, 4.2, 10.2$ Hz, 1 H), 6.24 - 6.10 (m, 1 H) which are in good agreement with the characteristics of α,β -unsaturated carbonyl compound. The three methyl group protons of Boc appeared at δ 1.46 (s, 9 H) as a singlet and the two methyl groups of acetonide appeared separately at δ 1.41 (s, 3 H) and δ 1.40 (s, 3H) as two singlets. The ^{13}C NMR of **167** revealed twelve signals at δ 194.4, 154.9, 146.0, 128.9, 110.1, 80.7, 77.7, 74.4, 48.4, 28.3, 27.4, 25.9. From DEPT studies the presence of four quaternary carbons was confirmed. The signal at δ 194.4 was assigned to the carbonyl of enone moiety. The signal at δ 154.9 was assigned to carbonyl carbon of carbamate group and the signal at δ 110.1 was assigned to quaternary carbon of acetonide. The

quaternary carbon of *tert*-butyl group of Boc was traced to 80.7. The mass spectrum of **167** showed 306 ($M^+ + Na^+$) as molecular ion peak.

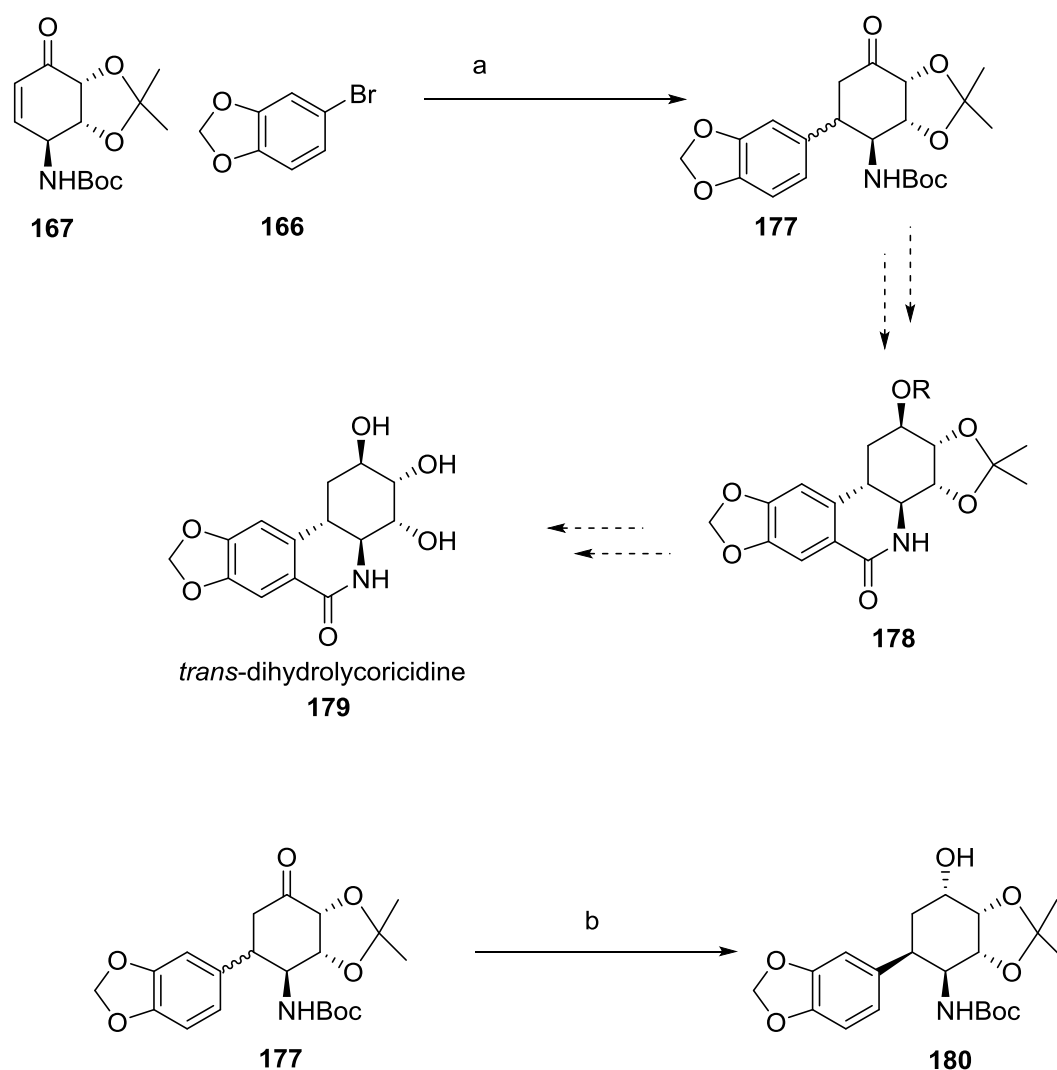

Reagents and conditions: (a) Mg, CuBr.SMe₂, THF, -15°C, 2h, 76%
 (b) NaBH₄, MeOH, 0°C, 1h, 97%,

Scheme39. Conjugate addition

1B.3d. Conjugate addition.

With the required **167** in hand, we next explored the possibility of performing conjugate addition with Grignard reagent derived from **166** in the presence of copper (I) catalysts such as CuCl, CuCN which ultimately proved futile. When we tried conjugate addition with freshly prepared Grignard reagent along with CuBr.SMe₂ the reaction proceeded smoothly at -15°C giving rise to only one diastereomer.

The IR spectrum of **177** showed strong absorption band at 1716 cm⁻¹ and 1695 cm⁻¹, the characteristic bands of a cyclohexanone carbonyl and carbamate, respectively. In the ¹H NMR spectra, aromatic protons were easily detected appearing at δ 6.82 -6.65 (m, 3 H). The two protons of methylene dioxy group appeared as a doublet at δ 5.96, 5.95. The benzylic proton (β proton with respect to the carbonyl group) was assigned to a multiplet at δ 2.86. Three cyclohexane ring protons which are attached to hetero atoms appeared at δ 3.62, 4.28, 4.56, respectively. Six protons of two methyl groups of acetonide moiety appeared as two singlets at δ 1.50 and δ 1.43. Nine protons of Boc group appeared relatively upfield at δ 1.25 as compared to the starting enone. This shift can be explained considering the proximity of aromatic group deshielding the protons due to ring current. The observed splitting pattern in the ¹H NMR and ¹³C NMR, due to restricted rotation about NCO bond (rotamers), did not allow to establish relative stereochemistry beyond doubt at this stage.

After succeeding in carrying out conjugate addition, we decided to convert **177** to *trans*-dihydro lycoricidine (**179**) via **178**, a known congener of pancratistatin. Dihydro congeners of pancratistatin are known to possess equally rich biological activities.^[1] Therefore, we needed to construct the crucial B ring with the hope that stereochemical assignments could also be established precisely. In this direction, first **177** was reduced by NaBH₄ to obtain **180**. The proton spectra of **180** surprisingly got simplified after simple chromatographic purification. After scrutinizing carefully the 2D NMR (COSY, NOESY, HETCOR), relative stereochemistry of H-10b, H-4a in **180** as *syn* was unravelled. This unfortunate outcome was disappointing and thus forced us to abandon the pursuit of pancratistatin and/ its congeners through this route.

The *syn* relationship between H-10b, H-4a in **180** implied that conjugate addition of ArMgX (**166**) actually proceeded from the same face of the NHBoc group, which was contrary to general perception.^[61] We could offer two imprecise/tentative explanations for this apparent anomaly. First, we reasoned that the alpha face of **167** is sterically congested due to the presence of acetonide group which completely covered it like an umbrella, which results a preferred beta face for the incoming nucleophile.

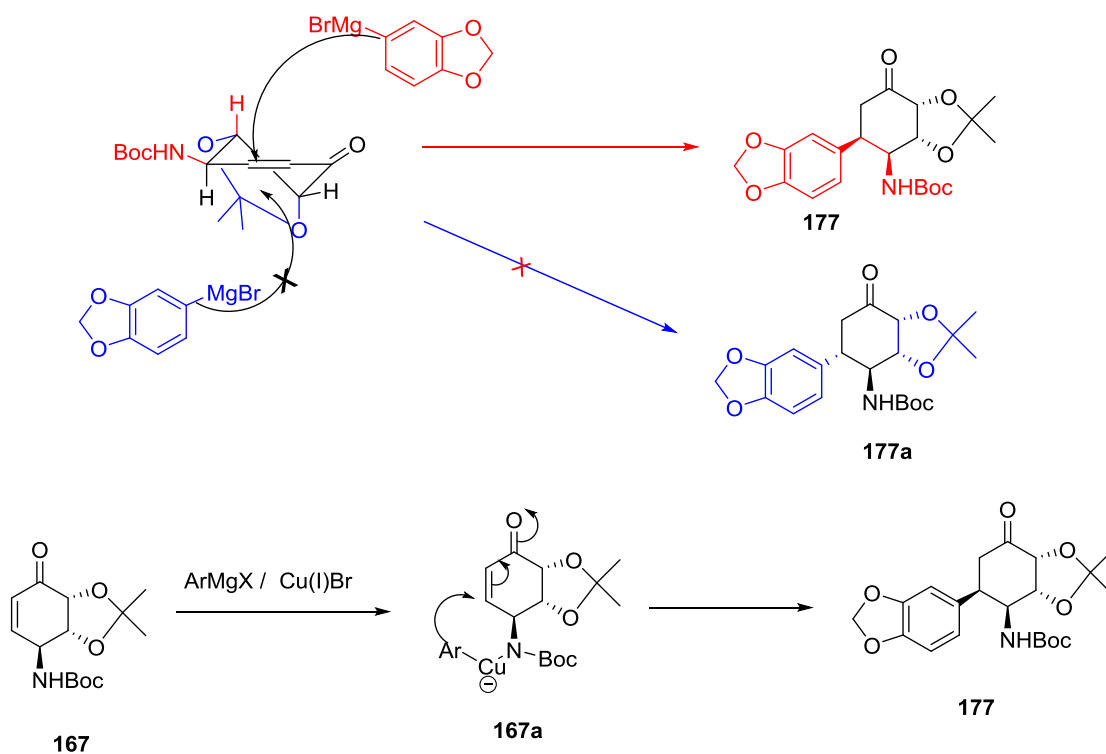

Figure 9.

Second alternative might be due to an internal delivery of the aryl group by virtue of a co-ordinating bond between NBoc and CuAr reagent as in **167a** (Fig.). The actual cause might be any one of these two factors or a combination of both. Opportunity to unravel the complete ambiguity does exist and active research is being performed in our laboratory in that direction. As it was apparent that the stereochemical outcome of conjugate addition will largely depend on the nature of the enone, syntheses of variety of enones (**181-184**) were targeted. The work is in progress in our laboratory.

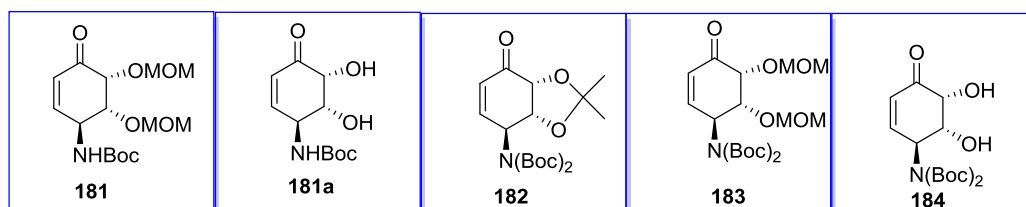
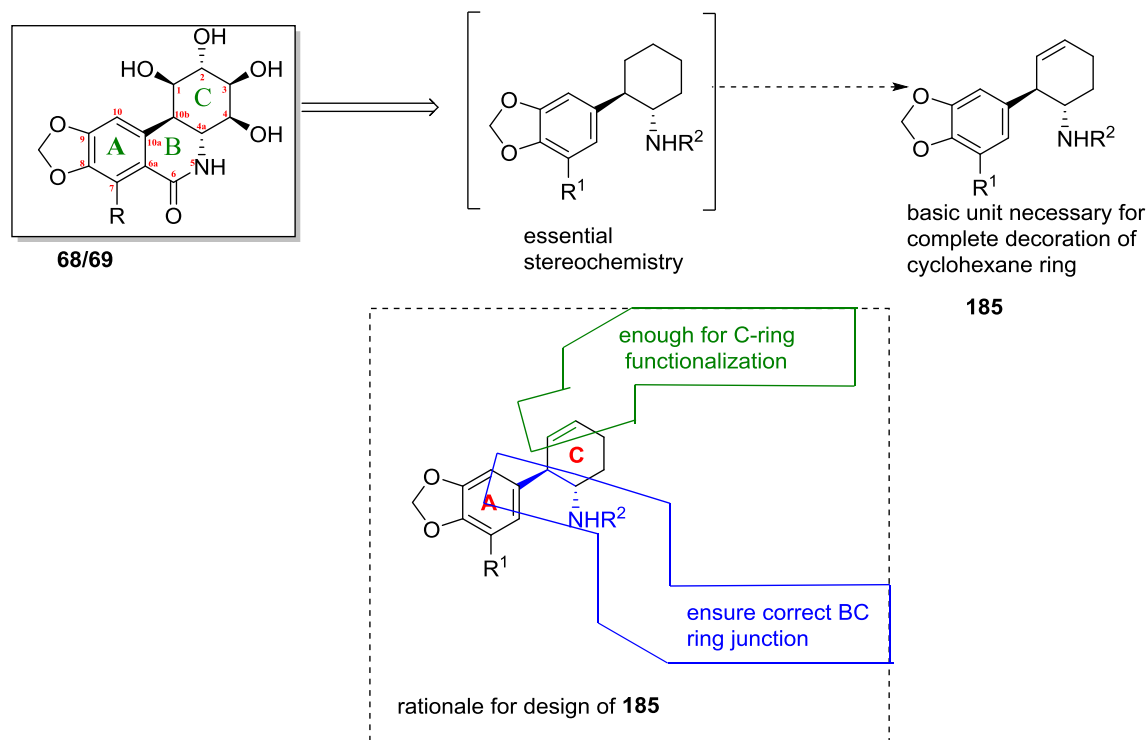

Figure 10.

1B.4. Alternative approach.

Since *trans* B C ring fusion is a must for bio-activity of these molecules^[53,54], it was decided to address this issue at the premature stage of the synthetic sequence. Furthermore, it was envisioned that only one double bond in the cyclohexane ring could be required to manipulate rest of the remaining four carbons with hydroxyl groups for the functionalization of C-ring of **68**, **69** and related compounds. Based on these thoughts, we planned an imaginary basic skeleton as shown in Scheme 1.



SCHEME 1

Figure 11.

As soon as we finalized the identification of basic unit **185** as an advanced precursor, we searched for an amicable method to construct the complete molecular skeleton. Towards this end, it was thought that **185** might simply be synthesized from α,β -unsaturated sulfone (**186**, **187**) via desulfonylation reaction. Now these structural frameworks (**186**, **187**), are well known to us barring the aromatic ring, where in place of aromatic group hydroxyl group was placed (**173**), a fact which prompted us to think a bicyclic structural framework (**188**, **189**) as precursors.

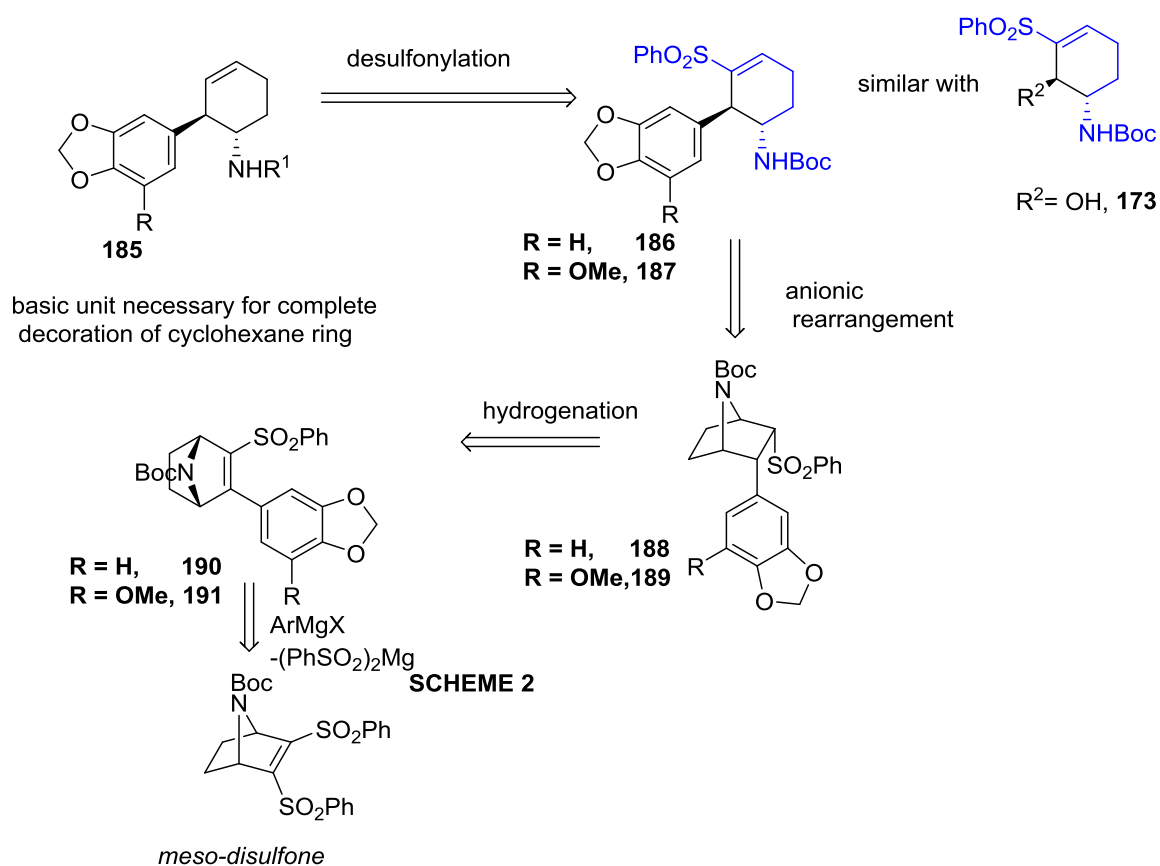

Scheme 40. Our planned sequence towards 185

To obtain the correct *trans* geometry in (**186,187**), the aromatic group should be *endo* in (**188,189**). Therefore, it was envisioned that construction of this moiety could be achieved through simple hydrogenation of the olefinic bond between SO_2Ph and Ar group of **190, 191**. Since, the bicyclic ring in **188, 189** is locked in a boat like conformation, it was expected that the hydrogen atoms would come selectively from *exo* face resulting into the aromatic as well as sulfone group to the *endo* position. Synthesis of **190, 191** were proposed to be obtained from the *meso*-disulfone via aromatic Grignard reagent addition.

1B.5. Results and discussion:

1B.5a. Synthesis of 190

The synthesis of **190** began by a simple addition of aryl Grignard reagent to vinyl disulfone **192** which approached preferentially from beta position of the sulfone group. The resultant carbanion pushed out the other sulfone group forming **190** in 92% yields.

The characterization of **190** was done with the help of ^1H NMR spectrum in which three protons of electron rich aromatic group appeared at δ 6.78- δ 7.11 as a multiplet along with methylenedioxy protons at δ 5.99 (s, 2H). The bridge head protons of **190** were found shifted upfield at δ 4.88 (brs, 1 H) and δ 4.95 – 4.93 (d, 1 H), respectively.

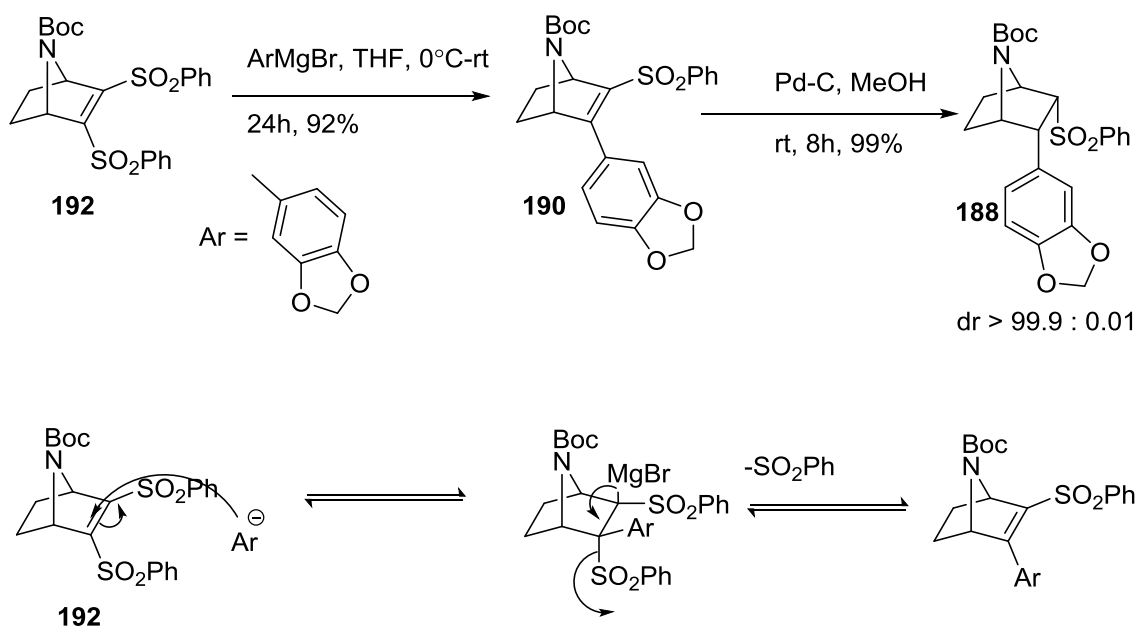

Scheme 41. Synthesis of **188**

The crucial hydrogenation reaction of **190** using 10% Pd-C catalyst in methanol at room temperature produced analytically pure **188** in 99% yield, which was characterized by the chemical shift values of bridge head protons H_1 , H_4 as well as H_2 and H_3 . For illustration, the bridge head proton H_1 appeared at δ 4.27 (br. s., 1 H) and H_4 at δ 4.38 (t, $J=4.28$ Hz, 1 H) whereas H_3 appeared at δ 3.64 (dd, $J=11.46, 3.65$ Hz, 1 H) and H_2 at δ 3.94 (d, $J=9.82$ Hz, 1 H), respectively.

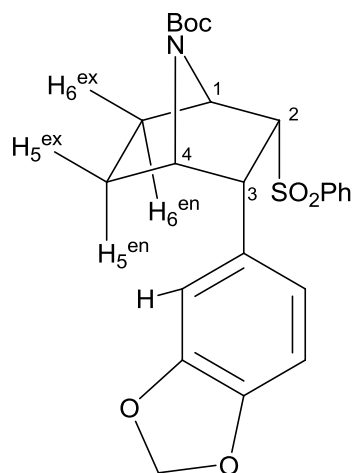

Figure 12.

In COSY spectrum, correlation between H^1 - H^2 - H^3 was visible indicating H-2 to be in an *exo* proton. Similarly, the other sets of correlation between H^{6ex} - H^1 - H^2 , H^{5ex} - H^4 - H^3 , H^4 - H^3 - H^2 , suggested H-2 and H-3 to be *exo* i.e the aromatic ring and phenyl sulfonyl groups both to be in *endo* orientation. These observations were in complete agreement with the literature reports where couplings are seen between bridge head proton and *exo* proton^[57,58]. The *endo* proton never coupled with the bridge head protons. This fact is further supported by NOESY where H^{5en} showed correlation with H^{ar1} .

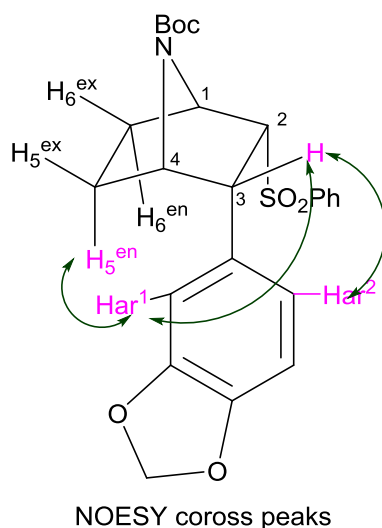
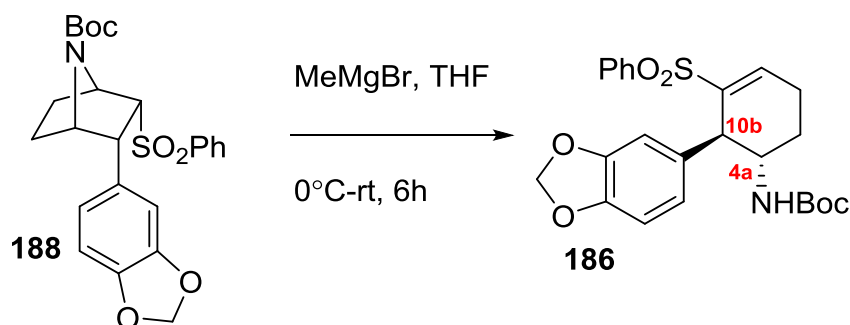

Figure 13.

With **188** in hand, we attempted anionic rearrangement utilizing strong base such as *n*BuLi, LiHMDS, KO^tBu, however, desired product could not be obtained. Finally,

reaction with excess of methylmagnesiumbromide produced **186** (87%) as a white crystalline solid (m.p.135°C).



Scheme 42. Synthesis of **186**

The presence of beta proton of vinyl sulfone at δ 7.46 - 7.40 (m, 1 H) along with five proton of phenyl sulfonyl group at δ 7.57 - 7.47 (m, 3 H), 7.37 (t, $J = 7.7$ Hz, 2 H), respectively, in ¹HNMR spectrum confirmed the formation of **186**. Further confirmation to the structure of **186** was indicated by observing molecular ion peak at 480 ($M^+ + Na^+$). Since **186** was crystalline solid, relative stereochemistry between H-10b and H-4a was determined by X-ray analysis which was found to be *trans*.

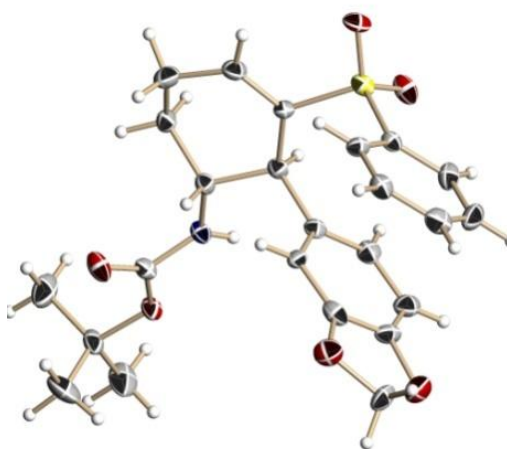
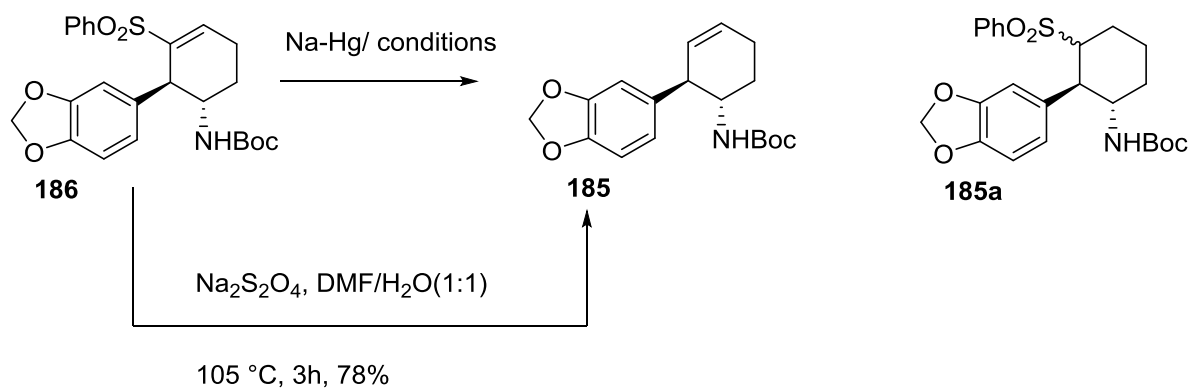

Figure 14: Crystal structure of **186**.

Initially our attempt of desulfonylation of **186** using either sodium amalgam or Birch reduction condition unfortunately, produced mixture of **185** (41%) and **185a** (47%). After a number of trials, fortunately reaction with sodium dithionite in a mixture of dimethyl formamide and water produced **185** in 78% yields.



Scheme 43. Synthesis of 185

Presence of two characteristics olefinic protons appearing at δ 5.89 - 5.82 (m, 1 H), 5.59 (d, $J = 7.6$ Hz, 1 H) confirmed the transformation.

1B.5b. Functionalization of Proposed C-ring:

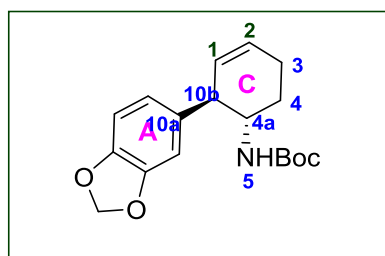
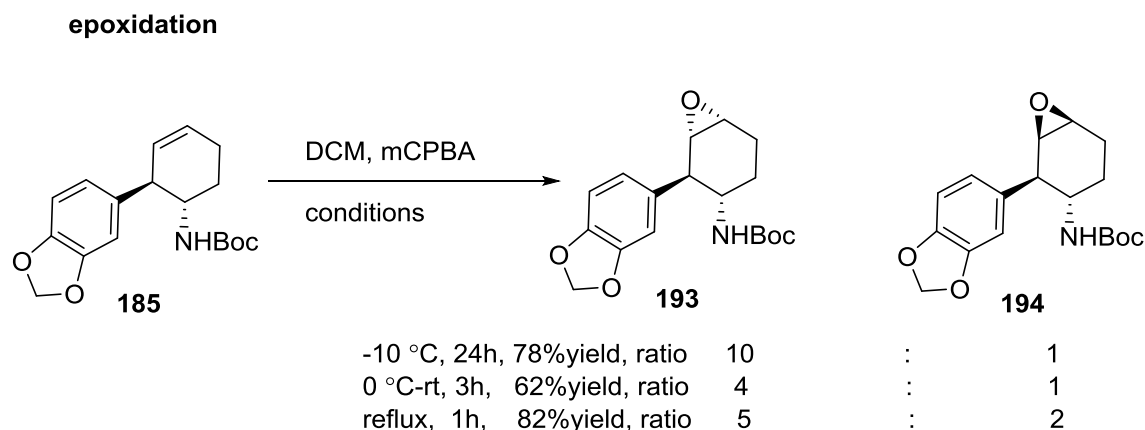

Figure 15:

Successful synthesis of **185** having a) correct proposed *trans*-BC ring junction stereochemistry b) an olefinic bond between C1-C2 set the stage to initiate the C-ring functionalization for crucial installation of four hydroxyl groups along the periphery of C-ring (C1, C2, C3 and C4) stereoselectively. Towards achieving this goal, first epoxidation of **185** was carried out using mCPBA in dichloromethane which resulted mixture of two diastereomeric epoxides **193** (49%) and **194** (13%), respectively. The ratios of these two epoxides (**193/194**) were found to be temperature dependent, e.g. at 0 °C = 4:1, 41 °C = 5:2 and at -10 °C it was 10:1 as measured by ^1H NMR.



Scheme 44. Synthesis of 193

Since it was known in the literature^[25] that direct transformation of **194** to **197** via **195** through epoxidation would be futile and would require longer reaction sequence involving dihydroxylation and subsequent opening of cyclic sulfate, an alternative pathway for the synthesis of **204** involving *anti* epoxide **193** was envisioned.

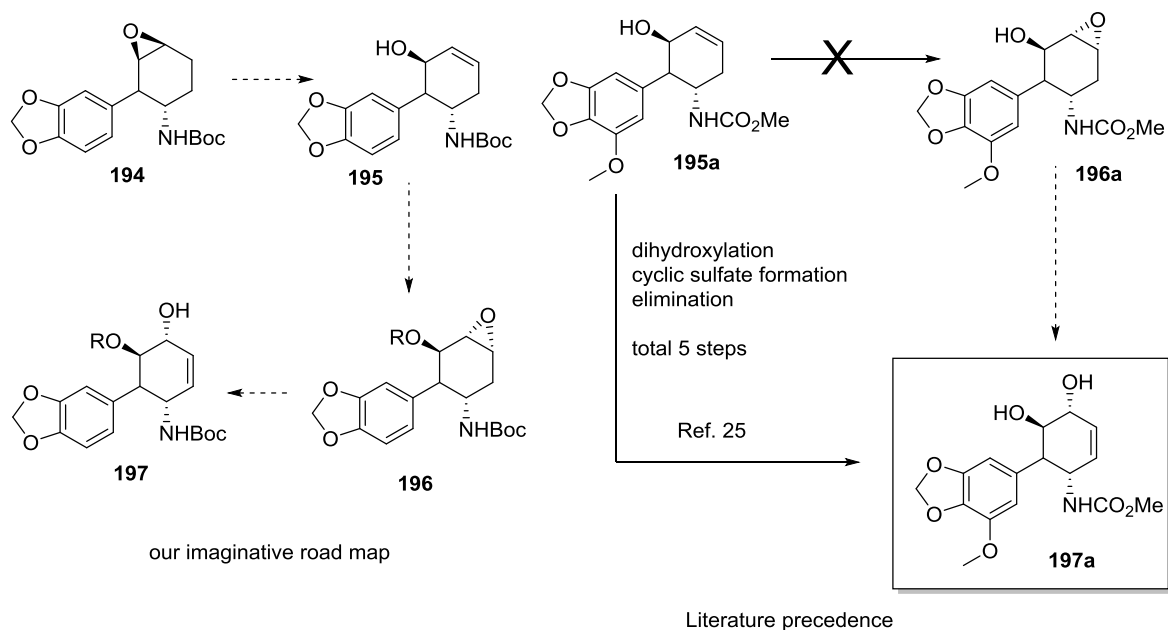

Scheme 45. Our planned sequence towards 204

We envisaged that **193** after opening with PhSeLi and subsequent selenoxide elimination would provide **199**, from which the C-2 stereochemistry of C-ring could be easily fixed by chelation controlled epoxidation using either mCPBA or VO(acac)₂. The C-1 hydroxy stereochemistry could be re-tuned to *syn* with respect to aromatic group via an oxidation reduction sequence involving **201**. Subsequent opening of epoxide **202** using PhSeLi followed by selenoxide elimination would

provide **204**. Since it was known^[12,13] that a similar structure as **201a** having ketone moiety at C-1 undergoes epimerization on standing due to presence of *trans* –BC ring junction, it was decided to proceed further along the proposed synthetic steps with **201** itself.

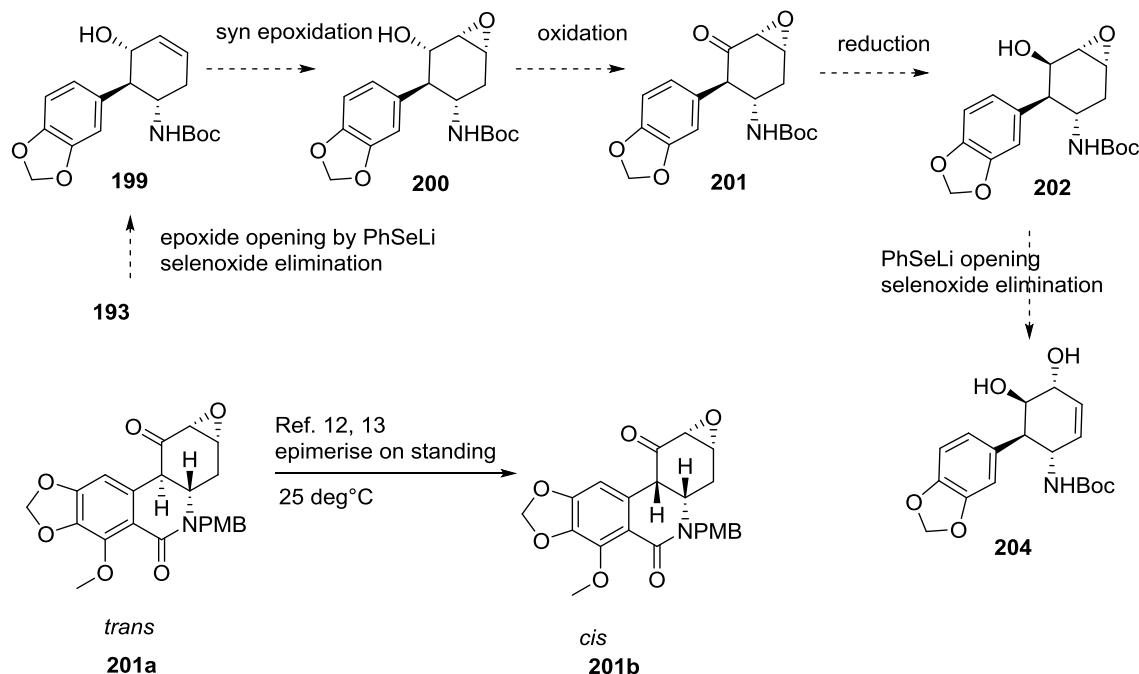

Scheme 46. Our planned sequence towards 204

Therefore, reaction of **193** with PhSeLi gave **198** in 90% isolated yield. The presence of two sets of aromatic protons at δ 7.61 (dd, $J = 1.3, 8.1$ Hz, 2 H), 7.41 - 7.25 (m, 3 H) confirmed the presence of SePh group in the product. Oxidation elimination of PhSe moiety

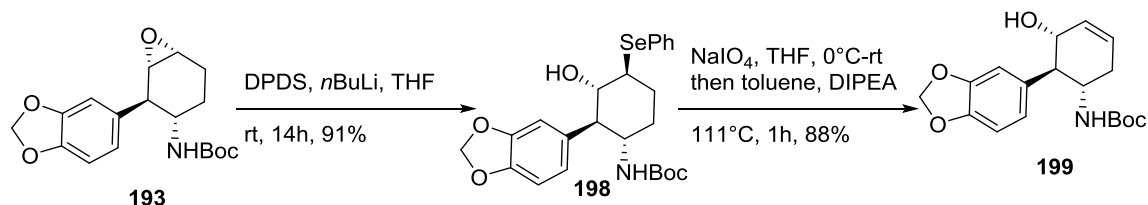

Scheme 47. Synthesis of 199

by treating with NaIO₄ in the presence of DIPEA produced **199** (88 %). The characteristic olefinic protons at δ 5.77 (brs, 2 H) in the ¹H NMR confirmed its formation.

Chelation controlled epoxidation of **199** with mCPBA gave **200** (70% yield) which was characterized by the presence of two multiplets at δ 3.47 - 3.44 (m, 1 H), 3.35 (t, $J = 4.8$ Hz, 1 H) in the ^1H NMR spectrum.

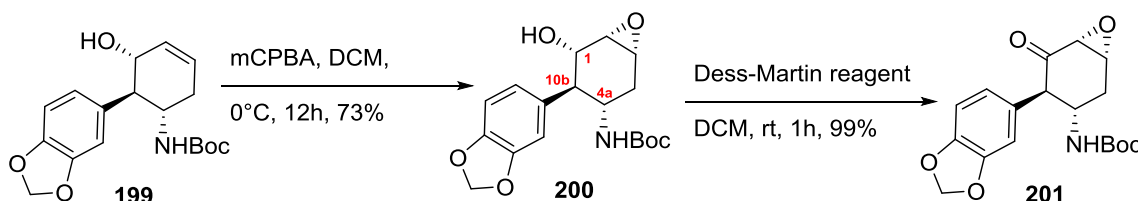

Scheme 48. Synthesis of 201

The crucial oxidation of **200** using Dess-Martin reagent^[62] produced **201** in 90% yields. Compound **201** was found stable at room temperature for several days! Reduction of **201** by NaBH_4 at 0°C produced mixture of two epoxy alcohol **200** and **202** (7:3). Although, it was possible to enrich **202** from **200** by the oxidation/reduction sequence, the efficacy of the synthetic route would have been compromised. Since the carbonyl moiety of epoxy ketones can selectively be reduced^[63] with $\text{NaBH}_4 / \text{CeCl}_3 \cdot 7\text{H}_2\text{O}$ or with ZnBH_4 ^[64], **201** was reduced by $\text{NaBH}_4 / \text{CeCl}_3 \cdot 7\text{H}_2\text{O}$ to obtain selectively only **202** (85%). In the ^1H NMR spectrum, H-10b which is now *cis* to H-1 and *trans* to H-4a appeared at δ 2.58 (td, $J = 5.2, 15.4$ Hz, 1 H) indicating a *cis-trans* relationship with adjoining protons H-1 and H-4a.

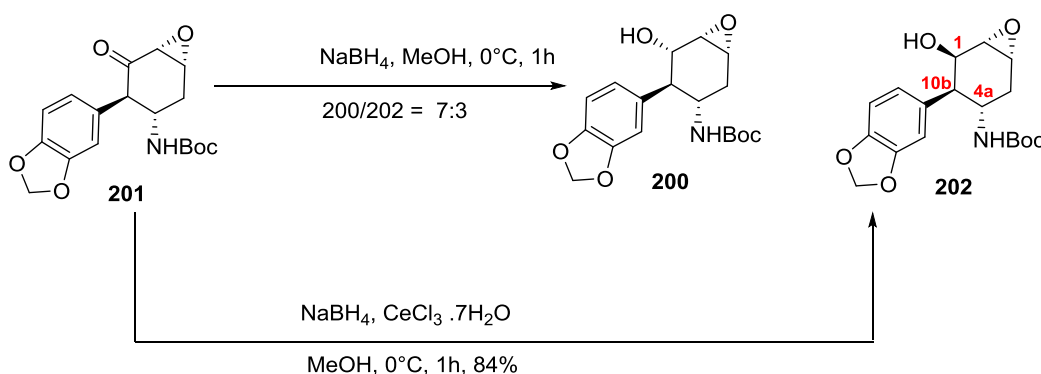

Scheme 49. Synthesis of 200

Reaction of **202** with PhSeLi by following identical reaction condition as described earlier for **198** produced **203** in 90% yields. The presence of five aromatic protons of PhSe group at δ 7.62 (d, $J = 5.8$ Hz, 2 H), 7.38 - 7.19 (m, 3 H) and H-2 at δ 4.26 (m, 1 H) in ^1H NMR spectrum confirmed the transformation. Oxidation of **203** with

aqueous H_2O_2 produced **204** in over 81% yield. The two characteristic olefinic protons H-3 and H-4 of this molecule were found merged with the two methylenedioxy protons at δ 6.00 – 5.84 (m, 4 H) in the ^1H NMR spectrum.

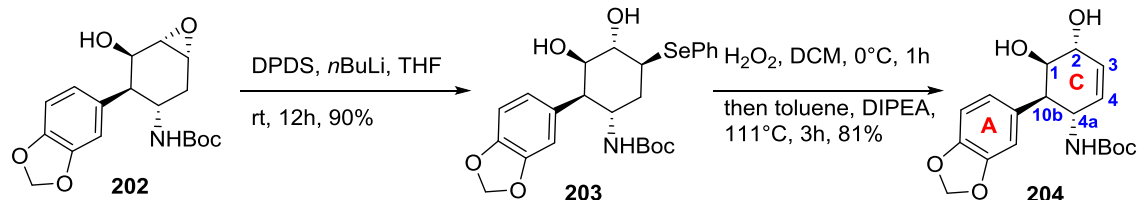

Scheme 50. Synthesis of 204

1B.5c. The end game.

Towards completing the synthesis of pancratistatin, remaining two hydroxyl groups at C-4 and C-3 were needed to be installed stereoselectively. Our previous experiences in the area of aminocyclitol synthesis^[57], led us to proceed with dihydroxylation step from **204** directly to install hydroxyl moieties at C-4 and C-3 stereoselectively, though, it was contrary to literature report^[12,13,25] where protection of hydroxyl group at C-1 and C-2 was required. Dihydroxylation of **204** under standard reaction conditions produced **205** in 91% yield. The structure of **205** was suggested based on the observation of six multiplets appearing at δ 4.27 (t, $J = 11.2$ Hz, 1 H), 4.05 - 4.03 (t, $J = 3.1$ Hz, 1 H), 4.01 (br. s., 1 H), 3.76 (br. s., 1 H), 3.76 - 3.73 (dd, $J = 3.1, 10.6$ Hz, 1 H), and at 3.11 (dd, $J = 1.6, 12.1$ Hz, 1 H) in ^1H NMR spectrum recorded in CD_3OD .

Successful synthesis of **205** having correct stereochemical dispositions of hydroxyl groups, set the stage for crucial B ring construction by modified^[65] Bischler-Napieralski reaction. Towards this end, all four hydroxyl groups were protected as O-acetate (**206** in 85% yields),

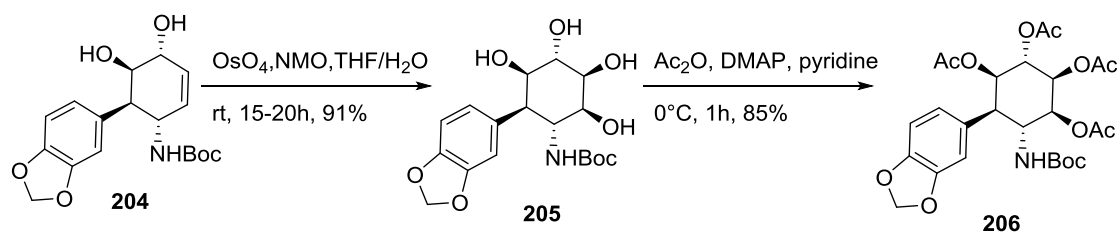

Scheme 51.

before being treated with freshly distilled trifluoromethane sulfonic anhydride (Tf₂O) and 2-chloropyridine in anhydrous dichloromethane at -84°C. The reaction occurred smoothly to deliver **207** in high yield (63%) which was characterized by NMR spectral data and compared with reported values^[20]. The details are presented in Table-2

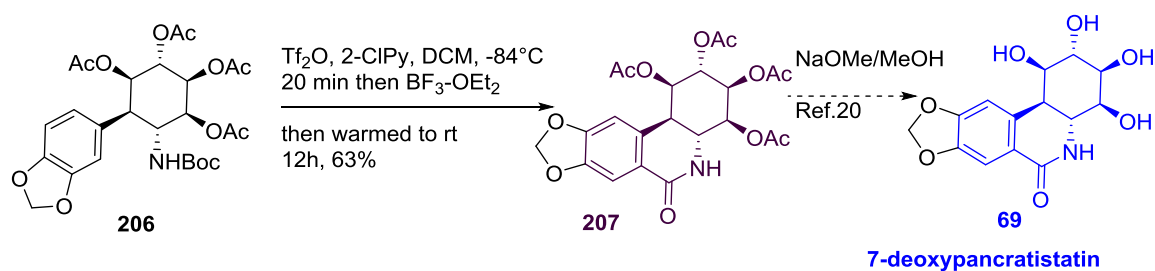

Scheme 52. Synthesis of 7-deoxypancratistatin

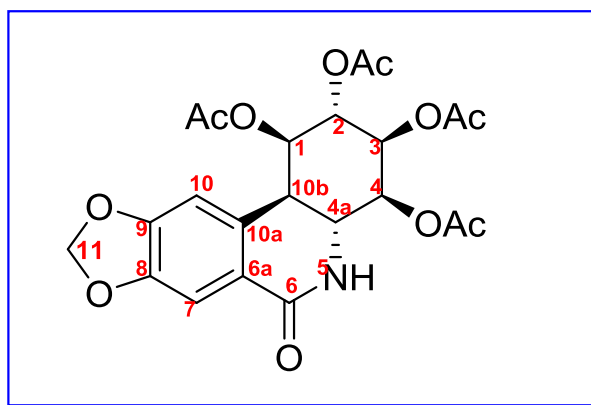

Figure 16.

Table 2.

Proton number	Observed value	Literature reported value
H1	5.24 (t, $J = 2.8$ Hz, 1 H)	5.23 (t, $J = 2.7$ Hz, 1H)
H2	5.48 (t, $J = 2.8$ Hz, 1 H)	5.47 (t, $J = 2.9$ Hz, 1H)
H3	5.60 (t, $J = 2.6$ Hz, 1 H)	5.58 (m, 1H)
H4	5.19 (dd, $J = 3.4, 10.9$ Hz, 1 H)	5.20 (dd, $J = 3.5, 10.8$ Hz, 1H)
H4a	4.31 (dd, $J = 10.9, 12.9$ Hz, 1 H)	4.30 (dd, $J = 12.8, 11.0$ Hz, 1H)
H5(N-H)	5.83 (s, 1 H)	6.56 (s, 1H)
H7	7.61 (s, 1 H)	7.56 (s, 1H),
H10	6.58 (s, 1 H)	6.59 (s, 1H)
H10b	3.47 (dd, $J = 2.7, 12.9$ Hz, 1 H)	3.46 (dd, $J = 13.0, 2.7$ Hz, 1H)
H11	6.04 (dd, $J = 1.3, 7.3$ Hz, 2 H)	6.03 (m, 2H)
Me1, Me2, Me3, Me4	2.18 (s, 3 H), 2.10 (s, 3 H), 2.09 (s, 3 H) 2.05 (s, 3 H)	2.16 (s, 3H), 2.11 (s, 3H), 2.09 (s, 3H), 2.04 (s, 3H)

Lastly, four acetyl groups of **207** were deprotected by reacting with NaOMe in methanol^[20] which produced **69** in 72% isolated yield. The total synthesis of 7-deoxypancratistatin (**69**) was achieved with only a single protecting group manipulation.

1B.6. Conclusion and outlook:

Two new approaches to pancratistatins utilizing racemic as well as enantiomerically pure 7-azabicyclo[2.2.1]heptenes derived from Diels-Alder reaction of pyrrole was discussed. The first generation approach was plagued with an unfortunate problem of undesired stereochemical outcome in crucial conjugate addition stage. Unfortunately, this step dismantled the need toward any further transformations. Active work is being pursued towards right direction in our group to solve this hurdle. Taking cue

from the first approach, we have put effort to tune the BC ring junction stereochemistry in the beginning of the planned sequence, which resulted in a successful 15 steps synthesis of racemic 7-deoxy-pancratistatin. The simplicity of the planning and operational ease in carrying out the transformations makes our strategy attractive. Minimal involvement of protecting group increases its efficacy. Still there are unfinished tasks ahead to project it as an alternative to existing protocols. Foremost is the synthesis in enantiomerically pure form, a challenge is being pursued in our laboratory actively and hopefully will find light in near future. But none the less the 15-step approach to 7-deoxypancratistatin (overall yield 6%) described in this chapter represent a solid basis for solving the supply problem for pancratistatin and its congeners upon further optimization.

1B.7. References:

- [1](a) Hartwell, J. L. *Lloydia*. 1967, 30, 379. (b) Fitzgerald, D. B.; Hartwell, J. L.; Leiter, J. *J. Nat. Cancer Inst.* 1958, 20, 763. (c) Pettit, G. R.; Gaddamidi, V.; Herald, D. L.; Singh, S. B.; Cragg, G. M.; Schmidt, J. M.; Boettner, F. E.; Williams, M.; Sagawa, Y. *J. Nat. Prod.* 1986, 49, 995. (d) Ceriotti, G. *Nature*. 1967, 213, 595. (e) Okamoto, T.; Torii, Y.; Isogai, Y. *Chem. Pharm. Bull.* 1968, 16, 1860.
- [2](a) Ohta, S.; Kimoto, S. *Tetrahedron Lett.* 1975, 16, 2279. (b) Ohta, S.; Kimoto, S. *Chem. Pharm. Bull.* 1976, 24, 2969. (c) Ohta, S.; Kimoto, S. *Chem. Pharm. Bull.* 1976, 24, 2977
- [3] (a) Paulsen, H.; Stubbe, M. *Tetrahedron Lett.* 1982, 23, 3171. (b) Paulsen, H.; Stubbe, M. *Liebigs Ann. Chem.* 1983, 535.
- [4] Ugarkar, B. G.; DaRe, J.; Schubert, E. M. *Synthesis*. 1987, 715.
- [5] (a) Chida, N.; Ohtsuka, M.; Ogawa, S. *Tetrahedron Lett.* 1991, 32, 4525. (b) Chida, N.; Ohtsuka, M.; Ogawa, S. *J. Org. Chem.* 1993, 58, 4441. (c) Ferrier, R.J., *J. Chem. Soc. Perkin. Trans.* 1979, 1, 1455. d) Blather, R.; Ferrier, R.J.; Hains, S. R. *Ibid.* 1988, 2413.
- Hudlicky, T.; Olivo, H. F. *J. Am. Chem. Soc.* 1992, 114, 9694. (b) Hudlicky, T.; Olivo, H. F.; McKibben, B. *J. Am. Chem. Soc.* 1994, 116, 5108
- [6] Martin, S. F.; Tso, H. H. *Heterocycles*. 1993, 35, 85.
- [7] Keck, G. E.; Wager, T. T. *J. Org. Chem.* 1996, 61, 8366.
- [8] Keck, G. E.; Wager, T. T.; Rodriguez, J. F. D. *J. Am. Chem. Soc.* 1999, 121, 5176.
- [9] Elango, S.; Yan, T. H. *Tetrahedron*. 2002, 58, 7335.
- [10] Zhang, H.; Padwa, A. *Org. Lett.* 2006, 8, 247.
- [11] Padwa, A.; Zhang, H. *J. Org. Chem.* 2007, 72, 2570.
- [12] Rigby, J. H.; Mateo, M. E. *J. Am. Chem. Soc.* 1997, 119, 12655.
- [13] Rigby, J. H.; Maharroof, U. S. M.; Mateo, M. E. *J. Am. Chem. Soc.* 2000, 122, 6624.
- [14] Hudlicky, T.; Rinner, U.; Gonzales, D.; Akgun, H.; Schilling, S.; Siengalewicz, P.; [15] Martinot, T. A.; Pettit, G. R. *J. Org. Chem.* 2002, 67, 8726.
- [16] Gonzalez, D.; Martinot, T.; Hudlicky, T. *Tetrahedron Lett.* 1999, 40, 3077.
- [17] Elango, S.; Yan, T.-H. *J. Org. Chem.* 2002, 67, 6954.
- [18] Danishefsky, S.; Lee, J. Y. *J. Am. Chem. Soc.* 1989, 111, 4829.
- [19] Tian, X.; Hudlicky, T.; Ko'nigsberger, K. *J. Am. Chem. Soc.* 1995, 117, 3643.

- [20]Hudlicky, T.; Tian, X.; Ko'nigsberger, K.; Maurya, R.; Rouden, J.; Fan, B. *J. Am. Chem. Soc.* 1996, *118*, 10752.
- [21] (a) Trost, B. M.; Pulley, S. R. *J. Am. Chem. Soc.* 1995, *117*, 10143. (b) Trost, B. M.; Van Vranken, D. L.; Bingel, C. *J. Am. Chem. Soc.* 1992, *114*, 9327.
- [22] Doyle, T. J.; Hendrix, M.; VanDerveer, D.; Javanmard, S.; Haseltine, J. *Tetrahedron.* 1997, *53*, 11153.
- [23] (a) Magnus, P.; Sebhat, I. K. *J. Am. Chem. Soc.* 1998, *120*, 5341. (b) Magnus, P.; Sebhat, I. K. *Tetrahedron.* 1998, *54*, 15509.
- [24]Pettit, G. R.; Melody, N.; Herald, D. L. *J. Org. Chem.* 2001, *66*, 2583.
- [25] (a) Kim, S.; Ko, H.; Kim, E.; Kim, D. *Org. Lett.* 2002, *44*, 1343. (b) Ko, H.; Kim, E.; Park, J. E.; Kim, D.; Kim, S. *J. Org. Chem.* 2004, *69*, 112.
- [26](a)Li, M.; Wu, A.; Zhou, P. *Tetrahedron Lett.* 2006, *47*, 3707. (b) Fernando, C.; Olaia, N.; Hugo, L.; Alonso, R. *J. Org. Chem.* 2012, *77*, 11377-11382
- [27] (a) Keck, G. E.; McHardy, S. F.; Murry, J. A. *J. Am. Chem. Soc.* 1995, *117*, 7289. (b) Keck, G. E.; McHardy, S. F.; Murry, J. A. *J. Org. Chem.* 1999, *64*, 4465.
- (c)Tian, X.; Maurya, R.; Ko'nigsberger, K.; Hudlicky, T. *Synlett.* 1995, 1125.
- [28]Chida, N.; Jitsuoka, M.; Yamamoto, Y.; Ohtsuka, M.; Ogawa, S. *Heterocycles.* 1996, *43*, 1385.
- [29]Keck, G. E.; Wager, T. T.; McHardy, S. F. *J. Org. Chem.* 1998, *63*, 9164.
- [30]Akgu'n, H.; Hudlicky, T. *Tetrahedron Lett.* 1999, *40*, 3081.
- [31]Acena, J. L.; Arjona, O.; Leo'n, M. L.; Plumet, J. *Org. Lett.* 2000, *2*, 3683.
- [32](a)Hakansson, A. E.; Palmelund, A.; Holm, H.; Madsen, R. *Chem. Eur. J.* 2006, *12*, 3243 (b) Anderson, C. E.; Overman, L. E. *J. Am. Chem. Soc.*, 2003, *125*, 12412-12413
- [33]Zhang, H.; Padwa, A. *Tetrahedron Lett.* 2006, *47*, 3905.
- [34]Shin, I.-J.; Choi, E.-S.; Cho, C.-G. *Angew. Chem., Int. Ed.* 2007, *46*, 2303.
- [35]Isobe, K.; Taga, J. I.; Tsuda, Y. *Heterocycles.* 1978, *9*, 625.
- [36]Fujimura, T.; Shibuya, M.; Ogasawara, K.; Iwabuchi, Y. *Heterocycles.* 2005, *66*, 167.
- [37]Pettit, G. R.; Melody, N.; O'Sullivan, M; Thompson, M. A.; Herald, D. L.; Coates, B. *J. Chem. Soc., Chem. Commun.* 1994, 2725.
- [38]McNulty, J.; Mao, J.; Gibe, R.; Mo, R.; Wolf, S.; Pettit, G. R.; Herald, D. L.; Boyd
- [39]M. R. *Bioorg. Med. Chem. Lett.* 2001, *11*, 169.

- [40] Rinner, U.; Siengalewicz, P.; Hudlicky, T. *Org. Lett.* 2002, 4, 115.
- [41] Rinner, U.; Hudlicky, T.; Gordon, H.; Pettit, G. R. *Angew. Chem., Int. Ed.* 2004, 43, 5342.
- [42] Rinner, U.; Hillebrenner, H. L.; Adams, D. R.; Hudlicky, T.; Pettit, G. R. *Bioorg. Med. Chem. Lett.* 2004, 14, 2911.
- [43] Ibn-Ahmed, S.; Khaldi, M.; Chrétien, F.; Chapleur, Y. *J. Org. Chem.* 2004, 69, 6722.
- [44] McNulty, J.; Laricheva, V.; Pandey, S. *Bioorg. Med. Chem. Lett.* 2005, 15, 5315.
- [45] Pettit, G. R.; Melody, N.; Herald, D. L.; Knight, J. C.; Chapuis J. C. *J. Nat. Prod.* 2007, 70, 417.
- [46] McNulty, J.; Nair, J. J.; Griffin, C.; Pandey, S. *J. Nat. Prod.* 2008, 71, 357.
- [47] (a) Wildman, W. C. *The Alkaloids*; Manske, R. H. F., Ed.; Academic Press: New York, 1968, Chapter 10, 307–406. (b) Fuganti, C. *The Alkaloids*; Manske, R. H. F., Ed.; Academic Press: New York, 1975, 10, Chapter 3, 83–164. (c) Polt, R. *Organic Synthesis: Theory and Applications*; Hudlicky, T., Ed; JAI Press: Greenwich, CT, 1997, 3, 109. (d) Hoshino, O. *The Alkaloids*; Cordell, G. A., Ed.; Academic Press: New York, 1998, 51, 323–424. (e) Jin, Z. *Nat. Prod. Rep.* 2003, 20, 606. (f) Rinner, U.; Hudlicky, T. *Synlett.* 2005, 365. (g) Chapleur, Y.; Chretien, F.; Ahmed, S. I.; Khaldi, M. *Curr. Org. Syn.* 2006, 3, 341. (h) Kornienko, A.; Evidente, A. *Chem. Rev.* 2008, 108, 1982. (i). Manpadi, M.; Kornienko, A. *Org. Prep. Proced. Int.* 2008, 40, 107.
- [48] (a) Pandey, G. Krishna, A.. Giriya K and Karthikeyan, M. *Tetrahedron Lett.*, 1993, 34, 6631; (b) G. Pandey, Karthikeyan M. and Murugan, A. *J. Org. Chem.*, 1998, 63, 2867.
- [49] Pandey, G. Murugan, A. Balakrishnan, M., *Chem. Commun.* , 2002, 624–625
- [50] Pandey, G. Balakrishnan, M, Swaroop, P.S. *Eur. J. Org. Chem.* 2008, 5839–5847
- [51] (a) N. Kekre, C. Griffin, J. McNulty and S. Pandey, *Cancer Chemother Pharmacol.*, 56,29(2005). (b) A. McLachlan, N. Kekre, J. McNulty and S. Pandey, *Apoptosis*, 10,619 (2005).
- [52] S. Pandey, N. Kekre, J. Naden and J. McNulty, *Artif. Cells, Blood Substitutes, Immobilization Biotechnol.*, 33,279 (2005).
- [53] Manpadi, M.; Kornienko, A. *Organic Preparations and Procedures Int.*, 40(20), 107-161,2008

- [54] Kornienko, A.;Evidente, A. *Chem. Rev.* 2008, 108, 1982–2014
- [55] Bischler, A; Napieralski, B. Berichte der Deutschen Chemischen Gesellschaft 26 (2): 1903
- [56] Ito,Y; Hirao,T; Saegusa,T. *J. Org. Chem.* 1978,43 ,1011–1013
- [57] (a)Pandey, G.; Tiwari, K. N.; Puranik V. G. *Org. Lett.* 2008, 10, 3611. (b) Pandey, G. S. K. Tiwari. R. S. Singh, R. S. Mali, *Tet. Lett.* 2001, 42, 3947-3949.
- [58] Trudell, M.L.; Chen, Z. *Chem. Rev.* 1996, 96, 1179-1193.
- [59] Pettit, G. R.; Eastham, S. A.; Melody, N.; Orr, B.; Herald, D.L.; McGregor, J.; Knight,J. C.; Doubek, D. L.; Pettit III, G. R.; Garner, L. C.; Bell, J. A. *J. Nat. Prod.* 2006, 69, 7-13
- [60] Nicolaou, K. C.;Montagnon, T.; Baran, P. S. *Angew. Chem. Int. Ed.* 2002, 41,993-996
- [61] Modern Organocopper Chemistry 2002, Willey-VCH Verlag GmbH, ISBNs: 3-527-29773-1, page 188-223.
- [62] Dess, D. B.; Martin, J. C. *J. Org. Chem.*1983, 48, 4155.
- [63] Li, K.; Hamann, L. G.; Koreeda, M. *Tet. Lett.* 1992, 33, 6569-6570
- [64] (a) Nakata, T.; Tanaka, T.; Oishi, T. *Tet Lett.* 1981,22,4723 - 4726. (b) Banfi. S.; Colona, S.;Molinari, H.; Julia, S. *Synth. Commun.* 1983, 13, 901 - 904. (c) Yoon, N. M.; Kang, J. *J. Korean Chem. Soc.* 1975,19,355 - 359.
- [65] M. Movassaghi, M. D. Hill, *Org. Lett.*, 2008, 10, 3485-3488

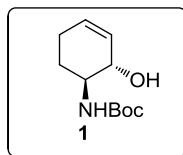
1B.8. EXPERIMENTAL:Preparation of *tert*-butyl ((1*S*,2*S*)-2-hydroxycyclohex-3-en-1-yl)carbamate(**172**)*tert*-butyl ((1*S*,2*S*)-2-hydroxycyclohex-3-en-1-yl)carbamate

To a solution of *tert*-butyl ((1*S*,2*R*)-2-hydroxy-3-(phenylsulfonyl)cyclohex-3-en-1-yl)carbamate (1.0 g, 2.83 mmol, 1.0 equiv.) in methanol:tetrahydrofuran (1:1, 20.0 mL) in a round-bottomed flask equipped with a magnetic stir bar was added $\text{NaH}_2\text{PO}_4 \cdot 2\text{H}_2\text{O}$ (3.39 g, 28.29 mmol, 10 equiv.). The flask was cooled to 0 °C and stirred for 10 min under argon atmosphere, after which Na-Hg (6.33 g, 28.29 mmol, 10 equiv.) was added in portions over 10 min. The reaction was allowed to stir for 60 min at 0 °C and was quenched with saturated ammonium chloride (20.0 mL). The layers were separated and the aqueous layer was extracted with EtOAc (3 x 15.0 mL). The combined organic layers were dried over sodium sulfate, filtered, and concentrated by rotary evaporation. The crude material was purified by silica gel chromatography (20% EtOAc in hexanes) to afford **172** (0.5 g, 83%) as a white crystalline solid (m.p. 112-114 °C).

$[\alpha]^{27.2}_{\text{D}}$:	-4.97 (<i>c</i> 1.12, CHCl_3)
IR (neat) ν_{max} cm^{-1}	:	3405, 3301, 1708, 1682, 1150
^1H NMR (400 MHz, CDCl_3) δ	:	5.81 - 5.72 (m, 1 H), 5.69 - 5.62 (m, 1 H), 4.65 (d, $J = 8.5$ Hz, 1 H), 4.09 - 4.03 (m, 1 H), 3.67 (br. s., 1 H), 3.59 - 3.50 (m, 1 H), 2.22 - 2.10 (m, 2 H), 1.95 - 1.87 (m, 1 H), 1.62 - 1.53 (m, 1 H), 1.46 (s, 9 H)
^{13}C NMR (50 MHz, CDCl_3) δ	:	157.0, 128.9, 128.1, 80.1, 72.5, 54.0, 28.3, 26.7, 24.3

Mass (ESI): m/z : 214 ($\text{M}^+ + \text{H}$), 236 ($\text{M}^+ + \text{Na}$), 252 ($\text{M}^+ + \text{K}$)

Preparation of *tert*-butyl ((1*R*,2*R*,3*S*,6*S*)-2-hydroxy-7-oxabicyclo[4.1.0]heptan-3-yl)carbamate (**171**)

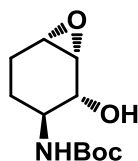

To a solution of **172** (1.0 g, 4.69 mmol, 1.0 equiv.) in dichloromethane (30.0 mL) in a round-bottomed flask equipped with a magnetic stir bar, was added 3-chlorobenzoperoxoic acid (1.26 g, 5.63 mmol, 1.2 equiv.). The flask was cooled to 0 °C and stirred for 3 h under argon atmosphere and was quenched with saturated sodium hydrogen carbonate solution (20.0 mL). The layers were separated and the aqueous layer was extracted with EtOAc (3 x 20.0 mL). The combined organic layers were dried over sodium sulfate, filtered, and concentrated by rotary evaporation. The crude material was purified by silica gel chromatography (40% EtOAc in hexanes) to afford **171** (0.85 g, 79%) as a white crystalline solid.

$[\alpha]_D^{31}$:	-17.0 (<i>c</i> 1.0, CHCl ₃)
IR (neat) ν_{\max} cm ⁻¹	:	3405, 3301, 1705, 1150
¹ H NMR (400 MHz, CDCl ₃) δ	:	4.53 (d, <i>J</i> = 7.5 Hz, 1 H), 3.75 (dd, <i>J</i> = 2.3, 8.5 Hz, 1 H), 3.59 (dd, <i>J</i> = 0.8, 8.8 Hz, 1 H), 3.37 (dd, <i>J</i> = 2.0, 4.0 Hz, 1 H), 3.34 - 3.31 (m, 1 H), 2.02 - 1.96 (m, 2 H), 1.76 - 1.69 (m, 1 H), 1.47 - 1.42 (m, 9 H), 1.36 - 1.28 (m, 1 H)
¹³ C NMR (50 MHz, CDCl ₃) δ	:	156.7, 128.3, 80.1, 73.2, 56.7, 54.6, 50.7, 28.3, 26.9, 22.3
Mass (ESI): <i>m/z</i>	:	230 (M ⁺ +H), 252 (M ⁺ +Na)

Preparation of *tert*-butyl ((1*S*,2*R*,3*S*,4*R*)-2,3,4-trihydroxycyclohexyl)carbamate (**170**)

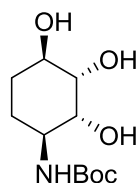

To a solution of **171** (0.7g, 3.05mmol, 1.0 equiv) in tetrahydrofuran: water (5:1, 30.0 mL) in a round-bottomed flask equipped with a magnetic stir bar was added 0.1 mL of conc. sulphuric acid. The flask was stirred for 0.5 h at ambient temperature and was quenched with saturated sodium hydrogen carbonate solution (20.0 mL). The layers were separated and the aqueous layer was extracted with EtOAc (3 x 30.0 mL). The combined organic layers were dried over sodium sulfate, filtered, and concentrated by rotary evaporation to afford **170** (0.75 g, 99%) as a white crystalline solid.

$[\alpha]_D^{31}$:	-9.0 (<i>c</i> 1.2, MeOH)
IR (neat) ν_{\max} cm^{-1}	:	3404, 3301, 1692
^1H NMR (400 MHz, CDCl_3) δ	:	3.83 (dd, <i>J</i> = 2.0, 5.8 Hz, 1 H), 3.71 (d, <i>J</i> = 6.0 Hz, 2 H), 3.60 (dd, <i>J</i> = 3.6, 4.1 Hz, 1 H), 1.84 - 1.67 (m, 3 H), 1.57 - 1.45 (m, 2 H), 1.37 (s, 9 H)
^{13}C NMR (50 MHz, CDCl_3) δ	:	157.9, 81.0, 72.5, 71.1, 69.3, 50.4, 27.6, 25.9, 24.3
Mass (ESI): <i>m/z</i>	:	270 ($\text{M}^+ + \text{Na}$)

Preparation of *tert*-butyl ((3*aR*,4*S*,7*R*,7*aS*)-7-hydroxy-2,2-dimethylhexahydrobenzo[d][1,3]dioxol-4-yl)carbamate (**169**)

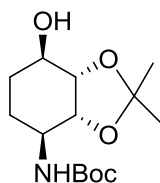

To a solution of **170** (1.0 g, 4.04 mmol, 1.0 equiv.) in anhydrous DMF (30.0 mL) in a round-bottomed flask equipped with a magnetic stir bar was added 2,2 dimethoxypropane (4.95 mL, 40.44 mmol, 10 equiv.) and pTSA (0.766 g, 4.45 mmol, 1.1 equiv). The flask was stirred at ambient temperature until TLC monitoring showed complete conversion of starting compound. The reaction was quenched with water (150.0 mL). The layers were separated and the aqueous layer was extracted with EtOAc (3 x 30.0 mL). The combined

organic layers were dried over sodium sulfate, filtered, and concentrated by rotary evaporation to **169** (1.1 g, 95%) as colorless liquid.

$[\alpha]^{25.2}_D$:	2.0 (<i>c</i> 1.2, CHCl ₃)
IR (neat) ν_{\max} cm ⁻¹	:	3405, 2985, 1705, 1134
¹ H NMR (400 MHz, CDCl ₃) δ	:	4.77 (br. s., 1 H), 4.03 (br. s., 2 H), 3.99 (br. s., 1 H), 3.80 (br. s., 1 H), 1.90 - 1.78 (m, 2 H), 1.57 (d, <i>J</i> = 17.1 Hz, 2 H), 1.51 (s, 3 H), 1.44 (s, 9 H)
¹³ C NMR (50 MHz, CDCl ₃) δ	:	155.3, 108.9, 79.6, 78.8, 69.1, 71.1, 69.3, 49.8, 28.3, 28.0, 26.4, 26.1, 24.0

Mass (ESI): *m/z* : 310 (M⁺+Na)

Preparation of *tert*-butyl ((3*aR*,4*S*,7*aR*)-2,2-dimethyl-7-oxohexahydrobenzo[d][1,3]dioxol-4-yl)carbamate(**168**)

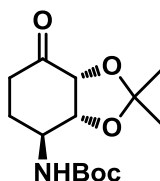

To a solution of **169** (0.639 g, 2.22 mmol, 1.0 equiv.) in anhydrous toluene:DMSO (2:1) (36.0 mL) in a round-bottomed flask equipped with a magnetic stir bar was added IBX (0.934 g 3.34 mmol, 1.5 equiv.). The flask was heated at 55° C temperature until TLC monitoring showed complete conversion of starting compound (6 h). The reaction was quenched with water (100.0 mL). The layers were separated and the aqueous layer was extracted with EtOAc (3 x 30.0 mL). The combined organic layers were dried over sodium sulfate, filtered, and concentrated by rotary evaporator. The crude material after column chromatography (EtOAc:Hexanes 1:5) afforded **168** (0.6 g, 94.5%) as amorphous solid.

$[\alpha]^{25.5}_D$:	-23.5 (<i>c</i> 1.5, CHCl ₃)
IR (DCM) ν_{\max} cm ⁻¹	:	2988, 1710, 1683, 1147

^1H NMR (200 MHz, CDCl_3) δ	: 4.51 - 4.38 (m, 2 H), 4.01 - 3.88 (m, 1 H), 2.56 - 2.42 (m, 2 H), 2.34 - 2.12 (m, 1 H), 2.03 - 1.89 (m, 1 H), 1.50 - 1.41 (m, 12 H), 1.38 (s, 3 H)
^{13}C NMR (50 MHz, CDCl_3) δ	: 207.2, 155.4, 110.5, 80.3, 79.5, 77.9, 49.1, 34.8, 28.3, 27.0, 25.7, 25.3
Mass (ESI): m/z	: 286 ($\text{M}^+ + \text{H}$), 308 ($\text{M}^+ + \text{Na}$)

Preparation of *tert*-butyl ((3*aR*,4*S*,7*aR*)-2,2-dimethyl-7-oxo-3*a*,4,7,7*a*-tetrahydrobenzo[*d*][1,3]dioxol-4-yl)carbamate(**167**)

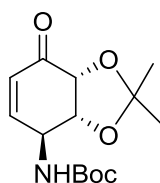

To a solution of **168** (0.06 g, 0.21 mmol, 1 equiv.) in anhydrous THF (1 mL) in a round-bottom flask equipped with a magnetic stir bar was added LiHMDS (0.63 mL, 0.63 mmol, 3 equiv. 1M solution in THF) in 0°C. After 30 min TMSCl (0.032 mL, 0.252 mmol, 1.2 equiv.) was added drop wise. The flask was allowed to warm to room temperature and stirred at that temperature until TLC monitoring showed complete conversion of starting compound (3 h). The reaction was quenched with water (1.0 mL). The layers were separated and the aqueous layer was extracted with EtOAc (3 x 5.0 mL). The combined organic layers were dried over sodium sulfate, filtered, and concentrated by rotary evaporation to afford the enol ether as a yellow liquid, which was used as crude for the next reaction.

The crude enol ether was dissolved in anhydrous DMSO (1 mL) to which palladium (II)acetate (0.007 g, 0.033 mmol, 0.2 equiv.) was added while stirring at ambient temperature in oxygen atmosphere until TLC showed complete conversion of enol ether (16h). The reaction was quenched with water (5.0 mL). The layers were separated and the aqueous layer was extracted with EtOAc (3 x 5.0 mL). The combined organic layers were dried over sodium sulfate, filtered, concentrated by rotary evaporation and chromatographed (EtOAc:Hexanes 1:5) to afford **167** (0.032 g, 67%) as a white solid.

$[\alpha]_D^{23.5}$: 115 (<i>c</i> 1.1, CHCl_3)
IR (neat) ν_{max} cm^{-1}	: 1696, 1682, 1151

^1H NMR (200 MHz, CDCl_3) δ : 6.80 (tdd, $J = 0.6, 4.2, 10.2$ Hz, 1 H), 6.24 - 6.10 (m, 1 H), 4.91 (dd, $J = 0.8, 8.6$ Hz, 1 H), 4.58 - 4.39 (m, 3 H), 1.46 (s, 9 H), 1.41 (d, $J = 2.9$ Hz, 6 H)

^{13}C NMR (100 MHz, CDCl_3) δ : 194.4, 154.9, 146.0, 128.9, 110.1, 80.7, 77.7, 74.4, 48.4, 28.3, 27.4, 25.9

Mass (ESI): m/z : 284 ($\text{M}^+ + \text{H}$), 306 ($\text{M}^+ + \text{Na}$)

tert-butyl ((3*aR*,4*S*,7*aR*)-2,2-dimethyl-7-oxo-3*a*,4,5,6,7,7*a*-hexahydro-[5,5'-bibenzo[d][1,3]dioxol]-4-yl)carbamate (**177**)

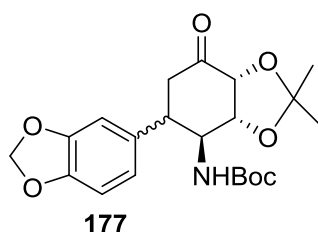

To a stirred and cooled (-15°C) suspension of $\text{CuBr}\cdot\text{SMe}_2$ (0.163 g, 0.794 mmol, 4.5 equiv.) in anhydrous THF (0.5 mL) was added freshly prepared ArMgBr (0.935 mL, 0.617 mmol, 3.5 equiv.) and stirred for 0.5 h after which **167** (0.05 g, 0.176 mmol, 1.0 equiv.) in THF (0.5 mL) was added very slowly. The reaction mixture was stirred at that temperature for 2 h and quenched with 10% aqueous ammonium chloride solution (2 mL) after which it was diluted with EtOAc (10 mL). The organic layer was separated and the aqueous layer was washed with ethyl acetate (3 x 10 mL) and the combined organic layer was dried over anhydrous sodium sulphate and was concentrated *in vacuo*. It was purified via flash silica gel column chromatography (EtOAc:hexanes 3:17) to get **177** (0.055 g, 76%) as light yellowish liquid.

IR (neat) ν_{max} cm^{-1} : 1716, 1695, 1145

^1H NMR (400 MHz, CDCl_3) δ : 6.82 - 6.77 (m, 1 H), 6.75 - 6.70 (m, 1 H), 6.70 - 6.64 (m, 1 H), 5.95 (d, $J = 4.8$ Hz, 2 H), 4.62 - 4.46 (m, 2 H), 4.25 (br. s., 1 H), 3.58 (br. s., 1 H), 2.83 (br. s., 1 H), 2.61 (br. s., 1 H), 1.50 (s, 3 H), 1.43 (s, 3 H), 1.33 - 1.16 (m, 9 H)

HRMS (ESI): m/z calcd. for $\text{C}_{21}\text{H}_{27}\text{NO}_7\text{Na}$ ($[\text{M} + \text{Na}]^+$): 428.1680, found: 428.1683

tert-butyl ((3*aR*,4*S*,5*R*,7*S*,7*aS*)-7-hydroxy-2,2-dimethyl-3*a*,4,5,6,7,7*a*-hexahydro-[5,5'-bibenzo[d][1,3]dioxol]-4-yl)carbamate(**180**)

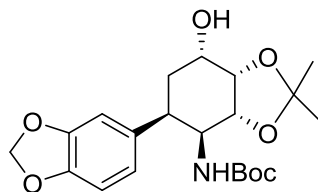

To a stirred and ice cooled solution of **177** (0.05 g, 0.123 mmol, 1.0 equiv.) in distilled methanol (2 mL) was added NaBH₄ (0.009 g, 0.246 mmol, 2 equiv.) and stirred at that temperature for 1 h after which the reaction was quenched with brine (2 mL) and diluted with EtOAc (10 mL). The layers were separated and the aqueous layer was washed with EtOAc (3x5 mL) and the combined organic layer was dried over anhydrous sodium sulphate and was concentrated *in vacuo*. It was purified via flash silica gel column chromatography (EtOAc:hexanes 1:1) to get **180** (0.049 g, 97%) as white amorphous solid.

$[\alpha]_D^{23.5}$: 65 (*c* 1.1, CHCl₃)

IR (neat) ν_{\max} cm⁻¹ : 3408, 1698, 1152

¹H NMR (400MHz, CDCl₃) δ : 6.76 (d, *J* = 8.0 Hz, 1 H), 6.70 - 6.55 (m, 2 H), 5.95 (d, *J* = 1.3 Hz, 2 H), 4.37 - 4.18 (m, 4 H), 4.18 - 4.09 (m, 1 H), 3.55 (br. s., 1 H), 2.31 - 2.18 (m, 1 H), 1.96 - 1.84 (m, 1 H), 1.59 (s, 3 H), 1.41 (s, 3 H), 1.37 (s, 9 H)

HRMS (ESI): *m/z* calcd. for C₂₁H₂₉NO₇Na ([M+Na]⁺): 430.1836, found: 430.1831.

tert-butyl-2-(benzo[d][1,3]dioxol-5-yl)-3-(phenylsulfonyl)-7-azabicyclo[2.2.1]hept-2-ene-7-carboxylate(**190**):

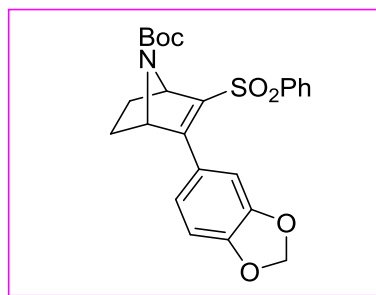

The Grignard reagent prepared from 1-bromo-3,4-(methylenedioxy)benzene (6.66 g, 33.12 mmol, 1.05 equiv.) in anhydrous THF (30 mL) was transferred via cannula to a solution of **192** (15.0 g, 31.54 mmol, 1 equiv.) in dry THF (70 mL) maintained at 0°C. After transfer was complete, the solution was stirred at 25°C until the reaction was complete as shown by TLC (~2 h). The reaction mixture was again cooled to 0°C and quenched by addition of a saturated aqueous solution of ammonium chloride after which it was diluted with ethyl acetate and filtered. The organic layer was separated and the aqueous layer was washed with ethyl acetate (3 X 50 mL) and the combined organic layer was dried over anhydrous sodium sulphate and was concentrated *in vacuo*. It was purified via flash silica gel column chromatography (15:85 ethyl acetate:hexane) to give the compound **190** (12.9 g, 89%) as a white, amorphous solid.

¹H NMR (400 MHz, CDCl₃) δ : 7.84 (d, *J* = 8.1 Hz, 2 H), 7.58 (t, *J* = 7.2 Hz, 1 H), 7.48 (t, *J* = 7.7 Hz, 2 H), 7.13 - 7.07 (m, 2 H), 6.82 (d, *J* = 8.3 Hz, 1 H), 6.01 (s, 2 H), 4.97 (br. s., 1 H), 4.91 (br. s., 1 H), 2.15 - 2.07 (m, 2 H), 1.74 - 1.67 (m, 1H), 1.40 (br. s., 1 H), 1.30 (br. s., 9 H)

¹³C NMR (101 MHz, CHLOROFORM-*d*) δ : 24.52, 27.97, 28.31, 64.23, 67.58, 80.86, 101.51, 108.10, 109.85, 123.76, 124.29, 127.58, 129.02, 133.38 , 140.93, 147.49, 149.17, 155.10

Mass (ESI): *m/z* : 456 (M⁺+H), 478 (M⁺+Na)

t-butyl-2-(benzo[d][1,3]dioxol-5-yl)-3-(phenylsulfonyl)-7-azabicyclo[2.2.1]heptane-7-carboxylate (**188**):

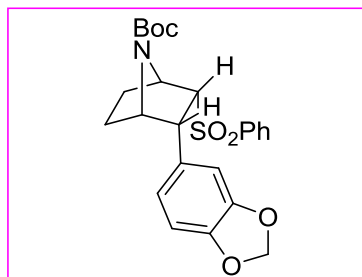

Compound **190** (10.0 g, 21.95 mmol, 1.0 equiv.) was taken in methanol (100 mL) to which was added 10% Pd/C(1.04 g, 0.04 equiv.) and stirred rapidly at ambient temperature under hydrogen at atmospheric pressure. The reaction was monitored periodically for completion by TLC (~12 h). The reaction mixture was filtered through a pad of celite and concentrated *in vacuo*. The crude compound was recrystallized (ethylacetate:hexane 1:9) to get **188** (10.0 g, 99%).

^1H NMR (400 MHz, CDCl_3) δ : 1.43 (s, 9 H) 1.72 - 1.84 (m, 1 H) 1.84 - 1.95 (m, 1 H) 2.30 - 2.43 (m, 1 H) 2.92 (ddd, $J=12.84, 8.81, 4.28$ Hz, 1 H) 3.64 (dd, $J=11.46, 3.65$ Hz, 1 H) 3.94 (d, $J=9.82$ Hz, 1 H) 4.27 (br. s., 1 H) 4.38 (t, $J=4.28$ Hz, 1 H) 5.99 (d, $J=5.54$ Hz, 2 H) 6.74 (d, $J=8.06$ Hz, 1 H) 6.89 (d, $J=7.55$ Hz, 1 H) 7.09 (br. s., 1 H) 7.43 - 7.52 (m, 2 H) 7.55 - 7.70 (m, 3 H)

^{13}C NMR (100 MHz, CDCl_3) δ : 154.4, 147.2, 146.8, 140.4, 133.3, 128.9, 127.6, 127.5, 124.4, 111.3, 107.6, 100.9, 80.5, 67.0, 63.5, 59.6, 49.6, 28.0, 23.7, 23.6

Mass (ESI): m/z : 480.1 ($\text{M}^+ + \text{Na}$)

tert-butyl (-2-(benzo[d][1,3]dioxol-5-yl)-3-(phenylsulfonyl)cyclohex-3-en-1-yl)carbamate(**186**):

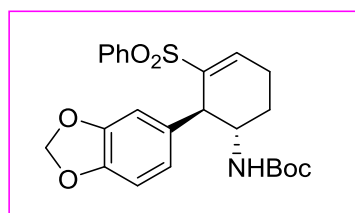

To a well stirred and ice cooled solution of **188** (10.0 g, 21.86 mmol, 1 equiv.) in dry THF (30 mL) was added methylmagnesiumbromide solution (1.4 M solution in THF/toluene, 62.45 mL, 87.42 mmol, 4 equiv.) over a period of 30 min. The ice bath was removed and the reaction mixture was allowed to stir at ambient temperature for 6 h until TLC showed complete consumption of starting material. The reaction mixture was again cooled to 0°C and quenched by the careful addition of saturated aqueous ammonium chloride solution (100 mL). The reaction mixture was diluted with water (100 mL) and DCM (200 mL) to ensure that all the precipitate dissolves. The two layers were separated and the aqueous layer was washed with DCM (2 x 100 mL). The combined organic layer was dried over anhydrous sodium sulphate and concentrated *in vacuo*. The crude product was purified via silica gel chromatography (30:70 ethyl acetate:hexanes) to obtain **186** (8.7 g, 87%) as a white crystalline solid.

IR (chloroform) ν_{\max} cm^{-1} : 2976, 1699, 1640, 1503, 1445

^1H NMR (400MHz, CD_3OD) δ : 7.57 - 7.47 (m, 3 H), 7.46 - 7.40 (m, 1 H), 7.37 (t, J = 7.7 Hz, 2 H), 6.66 (br. s., 1 H), 6.55 - 6.44 (m, 2 H), 6.36 (br. s., 1 H), 5.83 (d, J = 16.1 Hz, 2 H), 3.83 (br. s., 1 H), 3.66 (br. s., 1 H), 2.54 (br. s., 2 H), 1.77 (br. s., 2 H), 1.39 (s, 9 H)

^{13}C NMR (100MHz, CDCl_3) δ : 155.0, 147.3, 146.3, 140.3, 140.1, 140.1, 139.8, 132.7, 128.5, 128.0, 122.0, 108.6, 107.9, 100.9, 79.6, 51.5, 45.1, 28.3, 21.7, 19.6

Mass (ESI): m/z : 480 (M^+ +Na)

tert-butyl (-2-(benzo[d][1,3]dioxol-5-yl)cyclohex-3-en-1-yl)carbamate(**185**):

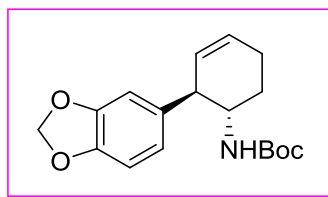

To a well stirred solution of **186** (2.0 g, 4.37 mmol, 1equiv.) in DMF/H₂O (10 mL:10 mL) was added Na₂S₂O₄(2.28 g, 13.11 mmol, 3 equiv.) and NaHCO₃ (1.39 g, 13.11 mmol, 3 equiv.). The round-bottom flask was fitted with a condenser and heated in an oil bath at 105°C for 3 h. The reaction mixture was cooled and diluted with ethyl acetate (30 mL) and washed 3 times with an equal volume of water. The organic layer was dried over anhydrous sodium sulphate and concentrated. The product was purified via silica gel column chromatography (10% ethyl acetate in hexane) to obtain **185** (1.08 g, 78%) as a white crystalline solid.

¹H NMR (400 MHz, CDCl₃) δ : 6.79 - 6.66 (m, 13 H), 5.95 - 5.81 (m, 13 H), 5.59 (d, *J* = 7.6 Hz, 4 H), 4.67 (br. s., 4 H), 3.68 (br. s., 4 H), 3.21 (br. s., 4 H), 2.28 - 2.06 (m, 9 H), 1.95 - 1.82 (m, 5 H), 1.65 - 1.51 (m, 5 H), 1.38 (s, 39 H)

¹³C NMR (100 MHz, CDCl₃) δ : 155.2, 147.5, 146.1, 136.7, 128.2, 127.8, 121.5, 108.7, 107.9, 100.7, 79.0, 52.4, 47.8, 28.3, 25.7, 23.1

HRMS (ESI): *m/z* calcd. for C₁₈H₂₃NO₄Na ([M+Na]⁺): 340.1519, found: 340.1519

tert-butyl (2-(benzo[d][1,3]dioxol-5-yl)-7-oxabicyclo[4.1.0]heptan-3-yl)carbamate(**193**):

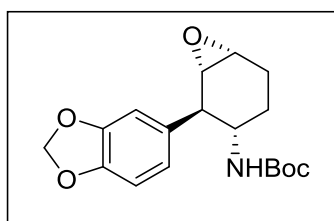

To a stirred solution of **185** (0.5 g, 1.58 mmol, 1.0 equiv.) in dichloromethane was added mCPBA (0.882 g, 3.94 mmol, 2.5 equiv.) at 0°C. After stirring at that temperature for 7 h, the reaction was quenched by the addition of saturated aqueous solution of NaHCO₃. This was diluted with CH₂Cl₂, washed with brine, dried over Na₂SO₄, filtered, and concentrated. The residue was purified by flash chromatography on silica gel (hexane/ethyl acetate, 5:1) to obtain major isomer **193** (0.35 g, 67%) as a white solid along with minor isomer **194** also as a white solid. *R_f* 0.5 (hexane/EtOAc 4:1).

IR (chloroform) ν_{\max} cm⁻¹ : 2545, 1686, 1578, 1415

¹H NMR (400MHz, CDCl₃) δ : 6.82 - 6.66 (m, 3 H), 5.94 (dd, *J* = 1.4, 3.4 Hz, 2H), 4.73 (br. s., 1 H), 3.55 (br. s., 1 H), 3.32 (br. s., 1 H), 3.21 - 3.06 (m, 1 H), 2.92-2.94 (d, *J* = 8.5 Hz, H), 2.30 - 2.11 (m, 1H), 2.11 - 1.94 (m, 1H), 1.74 - 1.59 (m, 1H), 1.50 - 1.40 (m, 1 H), 1.35 (br. s., 9H)

¹³C NMR (100MHz, CDCl₃) δ : 155.0, 147.8, 146.5, 134.5, 121.4, 108.6, 108.3, 101.0, 79.2, 56.1, 52.4, 51.5, 47.2, 29.7, 28.3, 22.7

HRMS (ESI): *m/z* calcd. for C₁₈H₂₃NO₅Na ([M+Na]⁺): 356.1468, found: 356.1470

tert-butyl (-2-(benzo[d][1,3]dioxol-5-yl)-3-hydroxy-4-(phenylselanyl)cyclohexyl) carbamate(**198**):

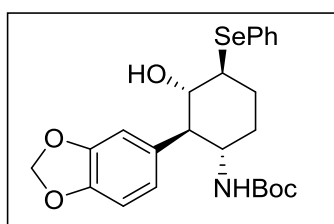

To a stirred solution of DPDS (0.56 g, 1.79 mmol, 2.6 equiv.) in tetrahydrofuran (10 mL) at ambient temperature was added *n*-butyllithium(0.985mL solution in hexane, 1.86 mmol, 2.7 equiv.) slowly. The yellow colour of the solution became colourless. After 10 min **193** (0.23 g, 0.69 mmol, 1 equiv.) in 20 mL tetrahydrofuran was added slowly. The reaction mixture was stirred at that temperature for 14 h and quenched by addition of 5 mL of saturated aqueous ammonium chloride solution. After extraction

with ethyl acetate, the crude mass was chromatographed (hexane/ ethylacetate 7:3) which produced **198** (0.31 g, 91.6%) as a white crystalline solid.

^1H NMR (400MHz, CDCl_3) δ : 7.61 (dd, $J = 1.3, 8.1$ Hz, 2 H), 7.41 - 7.25 (m, 3 H), 6.78 (d, $J = 8.1$ Hz, 1 H), 6.74 - 6.62 (m, 2 H), 5.99 - 5.90 (m, 2 H), 4.28 - 4.15 (m, 1 H), 3.55 (d, $J = 10.1$ Hz, 1 H), 3.46 (t, $J = 9.9$ Hz, 1 H), 3.08 - 2.97 (m, 1 H), 2.40 (t, $J = 10.4$ Hz, 1 H), 2.25 - 2.07 (m, 2 H), 1.69 - 1.54 (m, 1 H), 1.45 - 1.35 (m, 1 H), 1.28 (s, 9 H)

^{13}C NMR (100 MHz, CDCl_3) δ : 155.5, 148.2, 147.1, 136.8, 133.4, 129.9, 129.5, 128.8, 126.6, 122.3, 108.7, 101.3, 79.6, 75.8, 57.8, 52.9, 50.7, 34.3, 30.7, 28.6

HRMS (ESI): m/z calcd. for $\text{C}_{24}\text{H}_{29}\text{NO}_5\text{SeNa}$ ($[\text{M}+\text{Na}]^+$): 514.1103, found: 514.1107

tert-butyl (-6-(benzo[d][1,3]dioxol-5-yl)-5-hydroxycyclohex-3-en-1-yl)carbamate(**199**)

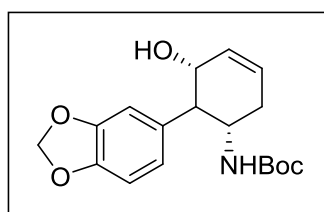

To a stirred and cooled (0 °C) solution of **198** (0.5 g, 1.02 mmol, 1.0 equiv.) in dichloromethane (20 mL) was added 30 % aqueous hydrogen peroxide (1.05 mL, 10.2 mmol, 10 equiv.) and diisopropylethylamine (0.74 mL, 3.06 mmol, 3 equiv.). After 1 h, the reaction mixture was concentrated under vacuo and toluene (25 mL) was added, and the mixture was heated again at 111 °C for 1 h. The mixture was cooled to room temperature, evaporated in vacuo, and the residue was subjected to column chromatographic purification, using hexanes-ethyl acetate mixtures (2:3) to obtain **199** as a yellowish solid (0.3 g, 88%).

^1H NMR (400 MHz, CDCl_3) δ : 6.82 - 6.64 (m, 3 H), 5.93 (d, $J = 5.5$ Hz, 2 H), 5.77 (s, 2 H), 4.48 - 4.29 (m, 2 H), 3.97 (br. s., 1 H), 2.68 - 2.47 (m, 2 H), 2.15 - 1.98 (m, 1 H), 1.31 (br. s., 9 H)

^{13}C NMR (100 MHz, CDCl_3) δ : 155.7, 148.4, 147.2, 133.3, 130.1, 127.2, 122.6, 108.7, 101.4, 79.7, 73.4, 55.6, 49.5, 33.6, 28.6

HRMS (ESI): m/z calcd. for $\text{C}_{18}\text{H}_{24}\text{NO}_5$ ($[\text{M}+\text{H}]^+$): 334.1649, found: 334.1651

tert-butyl(-4-(benzo[d][1,3]dioxol-5-yl)-5-hydroxy-7-oxabicyclo[4.1.0]heptan-3-yl)carbamate (**200**):

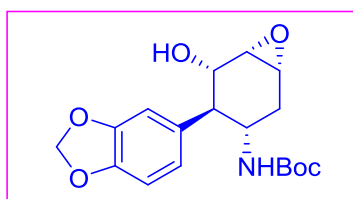

To a stirred and cooled (0°C) solution of **199** (0.5 g, 1.5 mmol, 1.0 equiv.) in dichloromethane (50 mL) was added mCPBA (1.18 g, 77%, 5.25 mmol, 3.5 equiv.). The reaction mixture was stirred at that temperature for 12 h. The reaction mixture was quenched with saturated aqueous NaHCO_3 solution. The colour turned pink which after 2 h of stirring became colourless. The reaction mixture was extracted with DCM and the crude mass was purified with column chromatography using hexane:ethylacetate (1:1) mixture to obtain **200** (0.387 g, 73%) as a white solid.

^1H NMR (800 MHz, CDCl_3) δ : 6.77 (d, $J = 8.0$ Hz, 1 H), 6.72 (br. s., 1 H), 6.67 (d, $J = 8.0$ Hz, 1 H), 5.94 (d, $J = 13.6$ Hz, 2 H), 4.20 - 4.14 (m, 1 H), 4.14 - 4.09 (d, $J = 11.8$ Hz, 1 H), 3.77 (br. s., 1 H), 3.47 - 3.44 (m, 1 H), 3.35 (t, $J = 4.8$ Hz, 1 H), 2.61 (dd, $J = 9.8, 11.8$ Hz, 1 H), 2.56 - 2.50 (m, 1 H), 1.86 - 1.76 (m, 2 H), 1.28 (br. s., 9 H)

^{13}C NMR (200 MHz, CDCl_3) δ : 155.1, 148.1, 147.1, 131.1, 122.5, 108.5, 101.1, 79.7, 73.2, 55.6, 52.0, 50.5, 48.6, 31.4, 28.2

HRMS (ESI): m/z calcd. for $\text{C}_{18}\text{H}_{23}\text{NO}_6\text{Na}$ ($[\text{M}+\text{Na}]^+$): 372.1418, found: 372.1418

tert-butyl (-4-(benzo[d][1,3]dioxol-5-yl)-5-hydroxy-7-oxabicyclo[4.1.0]heptan-3-yl)carbamate **202**):

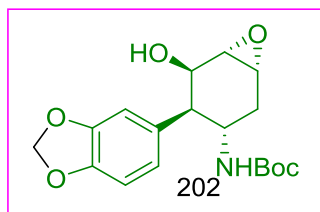

Dess-Martin periodinane (0.328 g, 0.773 mmol, 3 equiv.) was added to a solution of **200** (0.09 g) in dry DCM (6 mL) and the resulting heterogeneous reaction mixture was stirred under Ar atmosphere at ambient temperature for 1 h. The reaction mixture was diluted with 10 mL DCM and treated with 5 mL saturated aqueous solution of NaHCO₃ and 5 mL 5% aqueous solution of sodium thiosulfate. The reaction mixture was stirred for 15 min, by which time both layers became clear. It was extracted with DCM and concentrated to get crude **201** (0.089 g) which was as such re-dissolved in 10 mL of distilled methanol and cooled to 0 °C. CeCl₃·7H₂O (0.105 g, 0.281 mmol, 1.1 equiv.) was added followed by NaBH₄ (0.01 g, 0.269 mmol, 1.05 equiv.). The reaction mixture was stirred at 0 °C for 1 h and diluted with EtOAc (10 mL), quenched with brine (2 mL) and stirred for 4 h. The crude mixture was extracted with EtOAc and collective organic layers were concentrated under vacuo. The residue was subjected to column chromatographic purification using hexane: ethylacetate (3:2) to obtain **202** (0.076 g, 84%) as a white crystalline solid.

¹H NMR (400 MHz, CDCl₃) δ : 6.85 - 6.74 (m, 2 H), 6.69 (d, J = 7.8 Hz, 1 H), 5.94 (d, J = 3.3 Hz, 2 H), 4.27 (br. s., 1 H), 4.20 (br. s., 2 H), 3.32 (br. s., 1 H), 3.31 - 3.25 (m, 1 H), 2.89 (d, J = 8.3 Hz, 1 H), 2.58 (td, J = 5.2, 15.4 Hz, 1 H), 1.92 (d, J = 2.5 Hz, 1 H), 1.79 (dd, J = 8.3, 15.1 Hz, 1 H), 1.35 (br. s., 9 H)

¹³C NMR (100 MHz, CDCl₃) δ : 155.3, 148.0, 146.8, 131.8, 122.2, 109.5, 108.5, 101.0, 79.4, 69.9, 54.8, 52.1, 47.2, 42.6, 31.4, 28.3

HRMS (ESI): m/z calcd. for C₁₈H₂₃NO₆Na ([M+Na]⁺): 372.1418, found: 372.1422

tert-butyl(-2-(benzo[d][1,3]dioxol-5-yl)-3,4-dihydroxy-5-phenylselanyl)cyclohexyl carbamate (**203**):

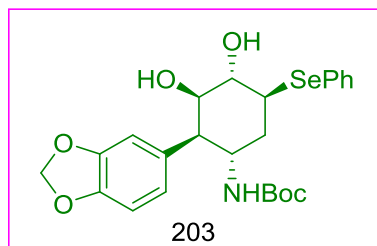

A solution of *n*-butyllithium in hexane (0.69 mL, 1.89 M, 1.3 mmol, 4.55 equiv) was added slowly to a stirred solution of diphenyl diselenide (0.402 g, 1.29 mmol, 4.5 equiv.) in anhydrous THF (6 mL) under inert atmosphere till the yellow colour of the solution turned colourless. After 10 min, a solution of **202** (0.1 g, 0.287 mmol) in THF (12 mL) was added drop wise and stirring continued for 12 h at room temperature. The reaction was quenched by the addition of saturated aqueous solution of NH₄Cl. The organic phase was worked up as usual. The crude product was subjected to column chromatographic purification, using hexanes-ethyl acetate mixtures (7:3) to obtain **203** as a floppy solid (0.131 g, 90% yield).

¹H NMR (400MHz, CDCl₃) δ : 7.62 (d, *J* = 5.8 Hz, 2 H), 7.38 - 7.19 (m, 3 H), 6.82 (s, 1 H), 6.75 - 6.56 (m, 2 H), 5.92 (s, 2 H), 4.56 - 4.34 (m, 2 H), 4.26 (br. s., 1 H), 3.93 (d, *J* = 3.5 Hz, 1 H), 3.43 (br. s., 1 H), 3.17 (br. s., 1 H), 2.90 (br. s., 1 H), 2.43 (br. s., 1 H), 2.29 - 2.15 (m, 2 H), 1.38 (br. s., 9 H)

¹³C NMR (101MHz, CDCl₃) δ : 155.3, 147.7, 146.4, 134.7, 132.5, 129.1, 127.8, 122.1, 109.7, 108.2, 100.9, 79.4, 75.2, 71.7, 49.0, 46.2, 43.8, 33.9, 28.3

HRMS (ESI): *m/z* calcd. for C₂₄H₂₉NO₆SeNa ([M+Na]⁺): 530.1052, found: 530.1060

tert-butyl (-6-(benzo[d][1,3]dioxol-5-yl)-4,5-dihydroxycyclohex-2-en-1-yl)carbamate (**204**):

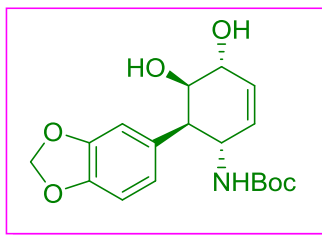

To a stirred and cooled (0 °C) solution of **203** (0.110 g, 0.217 mmol, 1equiv.) in dichloromethane (6 mL) was added 30% aqueous hydrogen peroxide (0.2 mL, 2.17 mmol, 10 equiv.) and diisopropylethylamine (0.1 mL, 0.65 mmol, 3 equiv.). After 1h, the reaction mixture was concentrated under vacuo and toluene (5 mL) was added, and the mixture was heated again at 111 °C for 3 h. The mixture was cooled to room temperature, evaporated in vacuo, and the residue was subjected to column chromatographic purification, using hexanes-ethyl acetate mixtures (2:3) to obtain **204** as a yellowish solid (0.062 g, 81% yield).

IR (chloroform) ν_{\max} cm^{-1} : 3436,2919,2850,1680,1038

^1H NMR (400MHz, CDCl_3) δ : 6.86 (s, 1 H), 6.78 (s, 2 H), 6.00 - 5.84 (m, 4 H), 4.67 - 4.44 (m, 2 H), 4.02 (d, $J = 3.3$ Hz, 1 H), 3.91 - 3.85 (m, $J = 3.8$ Hz, 1 H), 3.16 (br. s., 1 H), 1.39 (s, 9 H)

^{13}C NMR (100MHz, CDCl_3) δ : 155.3, 147.8, 146.6, 132.7, 132.2, 128.3, 121.9, 109.1, 108.3, 100.9, 79.7, 74.1, 68.7, 48.9, 47.1, 28.3

HRMS (ESI): m/z calcd. for $\text{C}_{18}\text{H}_{23}\text{NO}_6\text{Na}$ ($[\text{M}+\text{Na}]^+$): 372.1418, found: 372.1418

tert-butyl (-2-(benzo[d][1,3]dioxol-5-yl)-3,4,5,6-tetrahydrocyclohexyl)carbamate (**205**):

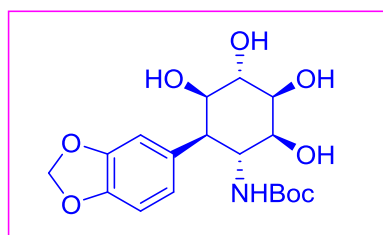

To a solution of **204** (0.01 g, 0.028 mmol, 1.0 equiv) in THF (0.8 mL) in a round bottomed flask equipped with a magnetic stir bar were added a 0.5 M solution of NMO in H₂O (0.171 mL, 85.5 μmol, 3 equiv) and a solution of OsO₄ in *t*BuOH (0.116 mL, 0.005 mmol, 0.2 equiv.). The reaction mixture was stirred in dark at room temperature under an atmosphere of Ar for 15 h. The reaction mixture was quenched with saturated aqueous sodium thiosulfate (5.0 mL) and the layers were separated. The aqueous layer was extracted with EtOAc (5 x 5.0 mL). The combined organic layers were dried over sodium sulfate, filtered, and concentrated by rotary evaporation. The crude material was purified by silica gel chromatography (3% MeOH in DCM) to afford **205** as a white solid (0.01 g, 91%).

¹H NMR (400MHz, CDCl₃) δ 6.87 (s, 1 H), 6.72 (s, 2 H), 5.87 (s, 2 H), 4.84 (d, *J* = 7.1 Hz, 1 H), 4.65 - 4.42 (m, 2 H), 4.33 - 4.04 (m, 4 H), 3.94 - 3.78 (m, 3 H), 3.05 (d, *J* = 11.8 Hz, 1 H), 1.28 (br. s., 9 H)

¹H NMR (800MHz, CD₃OD) δ = 6.93 (s, 1 H), 6.78 (d, *J* = 7.8 Hz, 1 H), 6.70 (d, *J* = 7.8 Hz, 1 H), 5.87(s, 1H), 5.85 (s, 1 H), 4.27 (t, *J* = 11.2 Hz, 1 H), 4.05 - 4.03 (t, *J* = 3.1 Hz, 1 H), 4.01 (br. s., 1 H), 3.76 (br. s., 1 H), 3.76 - 3.73 (dd, *J* = 3.1, 10.6 Hz, 1 H), 3.11 (dd, *J* = 1.6, 12.1 Hz, 1 H), 1.29 (s, 9 H)

¹³C NMR (201MHz, CD₃OD) δ = 159.0, 148.7, 147.6, 135.2, 124.0, 111.3, 108.6, 102.1, 79.8, 77.5, 76.2, 73.5, 72.0, 50.8, 49.0, 28.8

HRMS (ESI): *m/z* calcd. for C₁₈H₂₆NO₈ ([M+H]⁺): 384.1653, found: 384.1651.

5-(benzo[d][1,3]dioxol-5-yl)-6-((*tert*-butoxycarbonyl)amino)cyclohexane-1,2,3,4-tetraol tetraacetate(**206**):

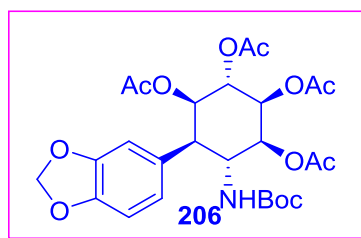

To a solution of **205** (0.034 g, 0.088 mmol, 1 equiv.) and DMAP (0.005 g, 0.044 mmol, 0.5 equiv.) in 5 mL of pyridine at 0°C was added acetic anhydride (0.084 mL, 0.88 mmol, 10 equiv.). The reaction mixture was stirred at that temperature for 1 h after which it was quenched with the addition of ice and extracted with (3 x 6 mL) DCM. The crude material was purified with flash chromatography (EtOAc: Hexane 1:1) to get **206** (0.042 g, 85%) as a white crystalline solid.

IR (neat) ν_{\max} cm^{-1} 1704, 1366, 1177, 1141, 1007, 968, 868.

^1H NMR (400 MHz, CDCl_3 , 25°C) δ : 6.78 (s, 1 H), 6.73 (s, 2 H), 5.92 (d, J = 10.6 Hz, 2 H), 5.35 (br. s., 1 H), 5.18 (dd, J = 2.6, 10.4 Hz, 1 H), 5.11 (t, J = 2.8 Hz, 1 H), 5.01 (br. s., 1 H), 4.71 (q, J = 11.1 Hz, 1 H), 4.18 (d, J = 10.3 Hz, 1 H), 3.15 (d, J = 10.8 Hz, 1 H), 2.19 (s, 3 H), 2.17 (s, 3 H), 2.04 (s, 3 H), 1.99 (s, 3 H), 1.30 (br. s., 9 H)

^{13}C NMR (100 MHz, CDCl_3) δ : 169.4, 168.9, 168.3, 155.4, 147.7, 146.9, 129.7, 122.3, 109.2, 108.1, 101.0, 79.5, 72.1, 71.1, 68.8, 68.1, 47.5, 47.1, 28.1, 20.9, 20.7, 20.6

HRMS (ESI): m/z calcd. for $\text{C}_{26}\text{H}_{34}\text{NO}_{12}$ ($[\text{M}+\text{H}]^+$): 552.2076, found: 552.2075.

6-oxo-1,2,3,4,4a,5,6,11b-octahydro-[1,3]dioxolo[4,5-j]phenanthridine-1,2,3,4-tetrayl tetraacetate(**207**):

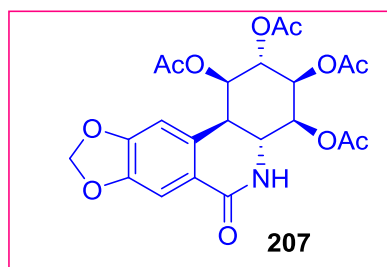

To a solution of **206** (0.02 g, 0.036 mmol, 1 equiv.) and 2-chloropyridine (0.145 mL of 0.5 M solution in DCM, 2 equiv.) in anhydrous DCM (1.0 mL) was added freshly distilled triflic anhydride (0.218 mL of 0.5 M solution in DCM, 3 equiv.) at -84°C . After 20 min $\text{BF}_3\text{-OEt}_2$ (0.1 mL) was added at the same temperature. The reaction mixture was allowed to come to ambient temperature in 4 h after which the reaction mixture was stirred at that temperature for another 8 h. It was diluted with 2 mL of DCM and quenched at 0°C by slow addition of saturated aqueous NaHCO_3 solution (1 mL). The mixture was extracted with (3 x 5 mL) DCM concentrated and chromatographed using flash silica gel (EtOAc:Hexane 1:1) to get **207** (0.011g, 63%) as a yellowish solid.

IR (chloroform) $\nu_{\text{max}} \text{ cm}^{-1}$ 2934, 1704, 1697, 1366, 1177, 1141, 1007, 965.

^1H NMR (400 MHz, CDCl_3) δ : 7.61 (s, 1 H), 6.58 (s, 1 H), 6.04 (dd, $J = 1.3, 7.3$ Hz, 2 H), 5.83 (s, 1 H), 5.60 (t, $J = 2.6$ Hz, 1 H), 5.48 (t, $J = 2.8$ Hz, 1 H), 5.24 (t, $J = 2.8$ Hz, 1 H), 5.19 (dd, $J = 3.4, 10.9$ Hz, 1 H), 4.31 (dd, $J = 10.9, 12.9$ Hz, 1 H), 3.53 - 3.43 (dd, $J = 2.3, 12.9$ Hz, 1 H), 2.18 (s, 3 H), 2.09 (d, $J = 1.2$ Hz, 6 H), 2.05 (s, 3 H)

HRMS (ESI): m/z calcd. for $\text{C}_{22}\text{H}_{23}\text{NO}_{11}\text{Na}$ ($[\text{M}+\text{Na}]^+$): 500.1163, found: 500.1163 .

1B.9. Spectras.

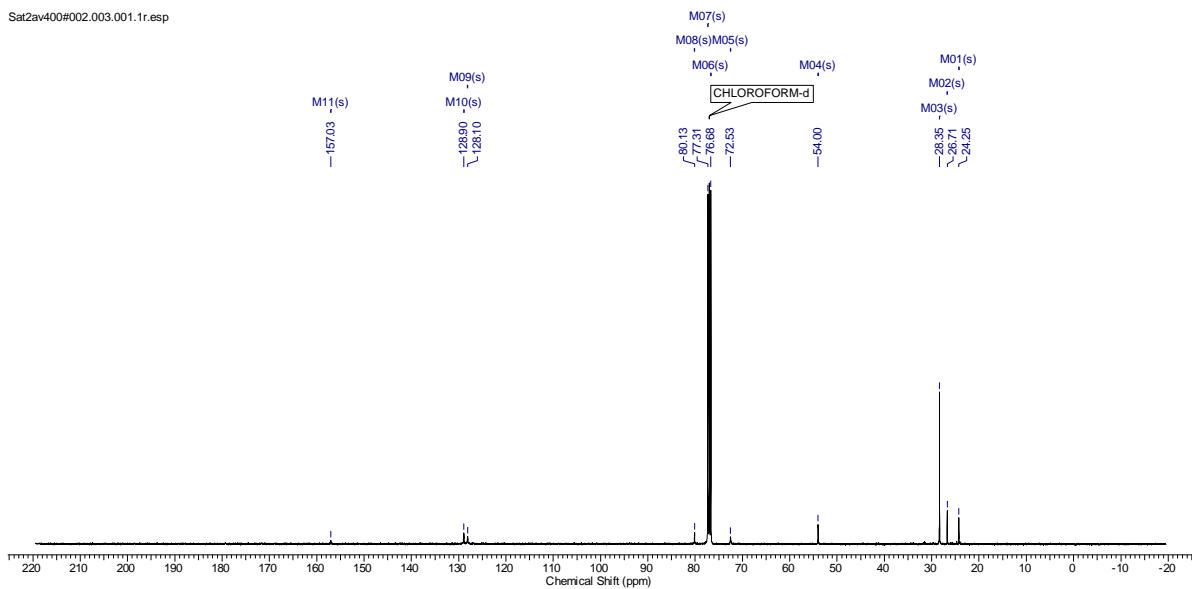
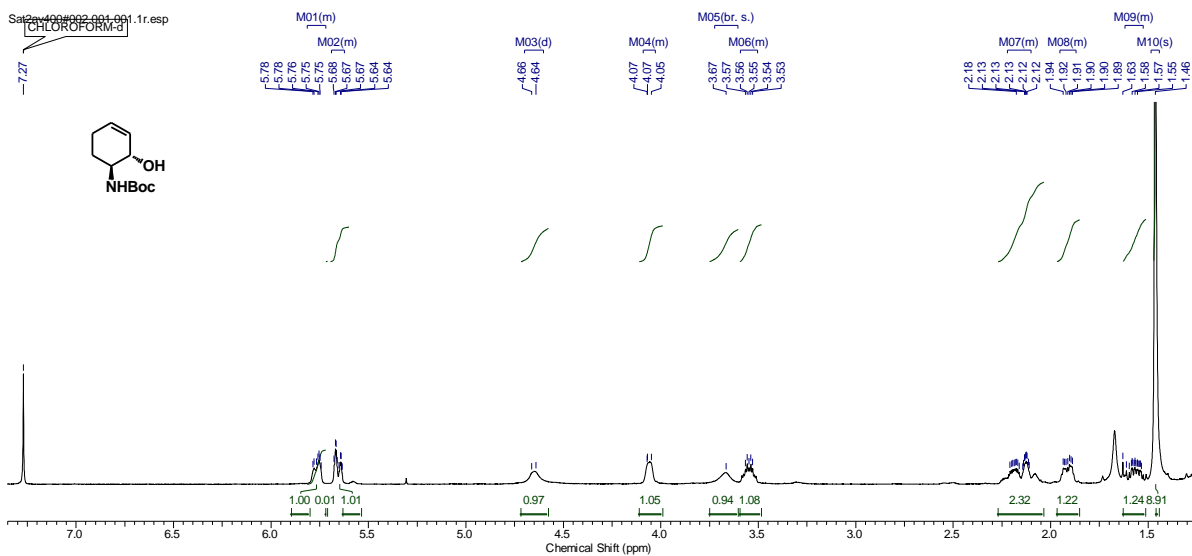

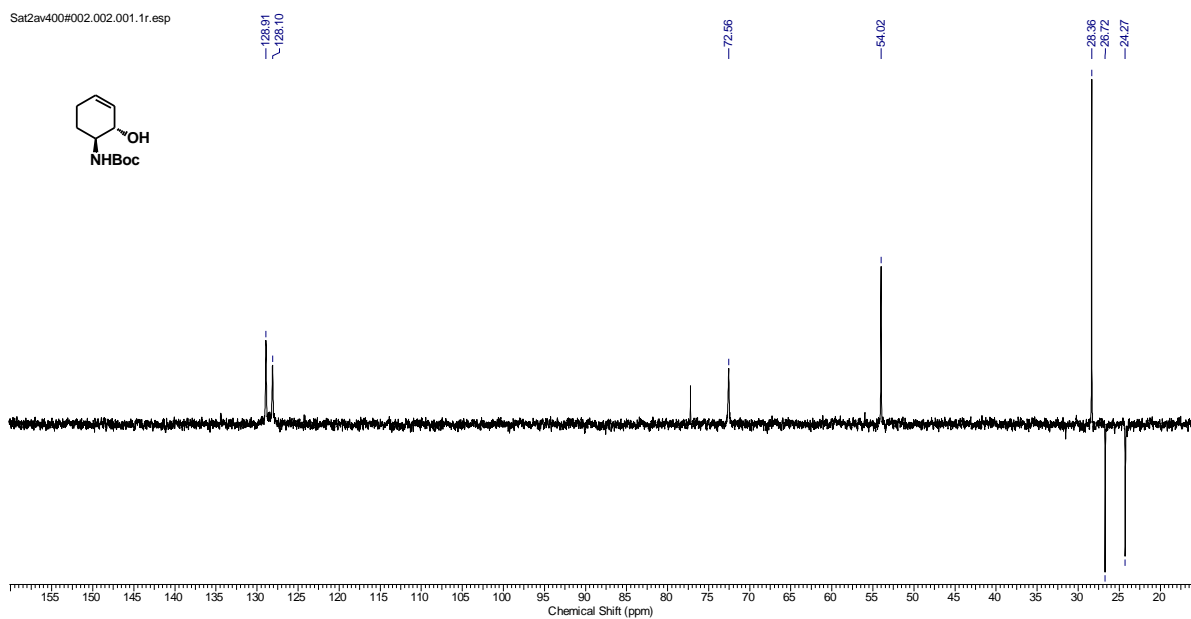

Z:\AV400\JUL_10_400\Sat2av400#002\Sat2av400#002.002.001.1r.esp

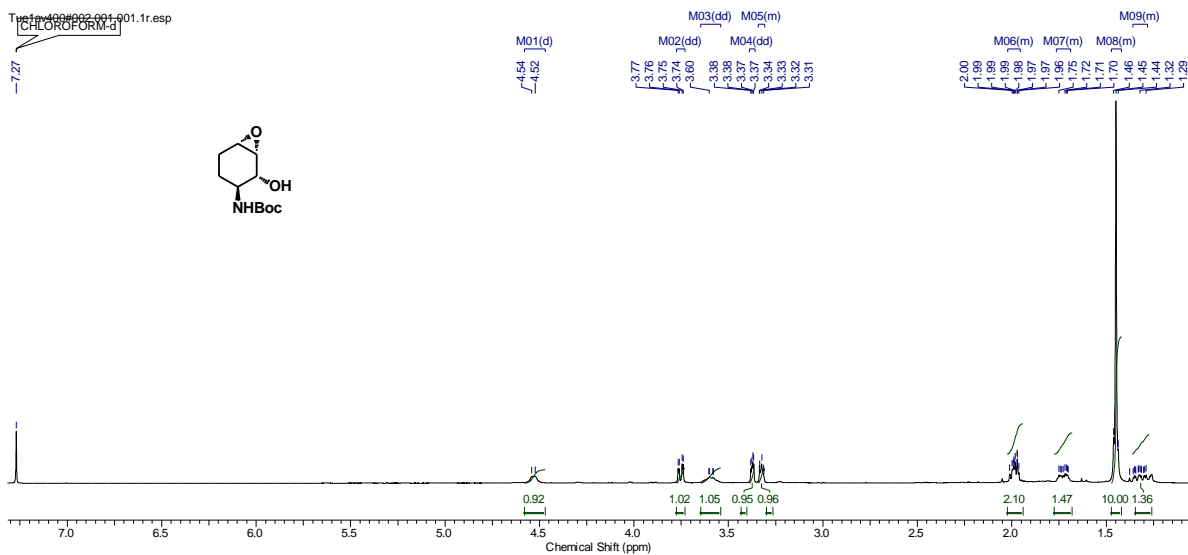

Tue1av400#002.003.001.1r.esp

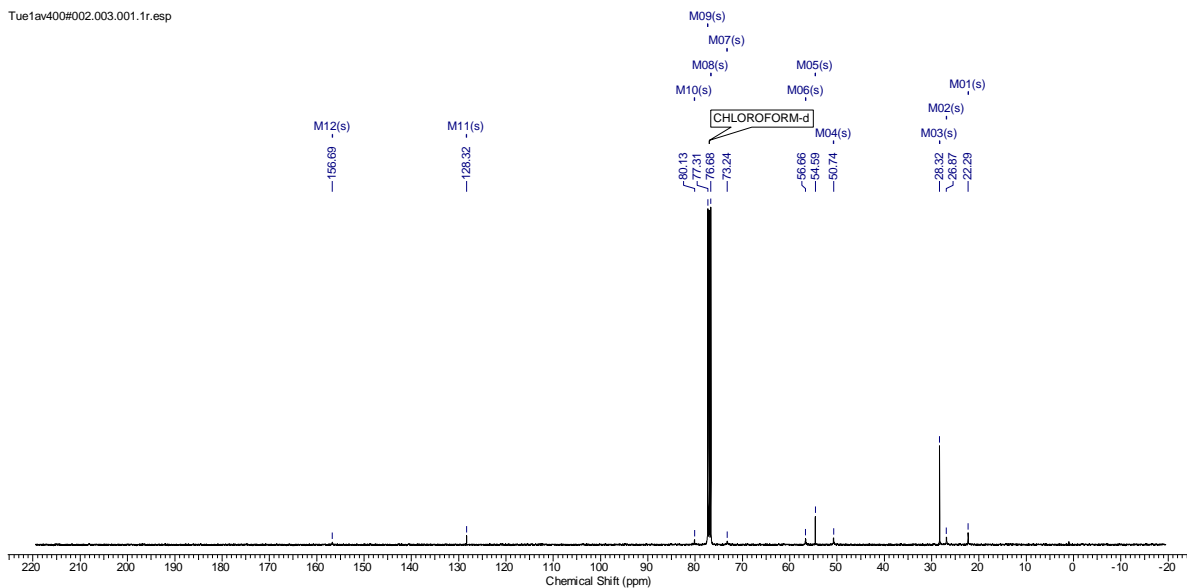

08-09-2011 08:34:00 003.001.1r.esp

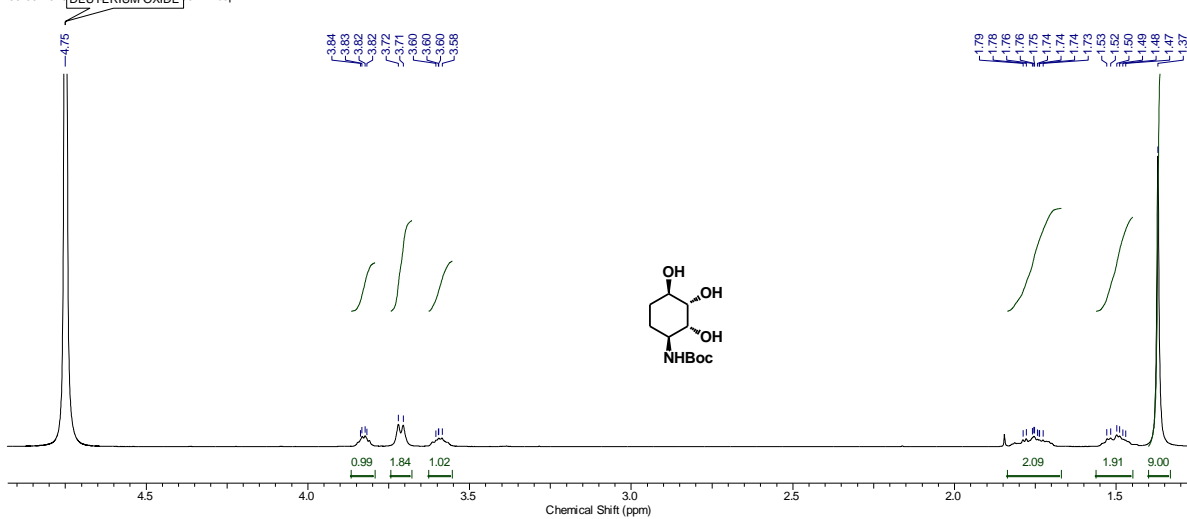

08-09-2010Wed2av400#001.003.001.1r.esp

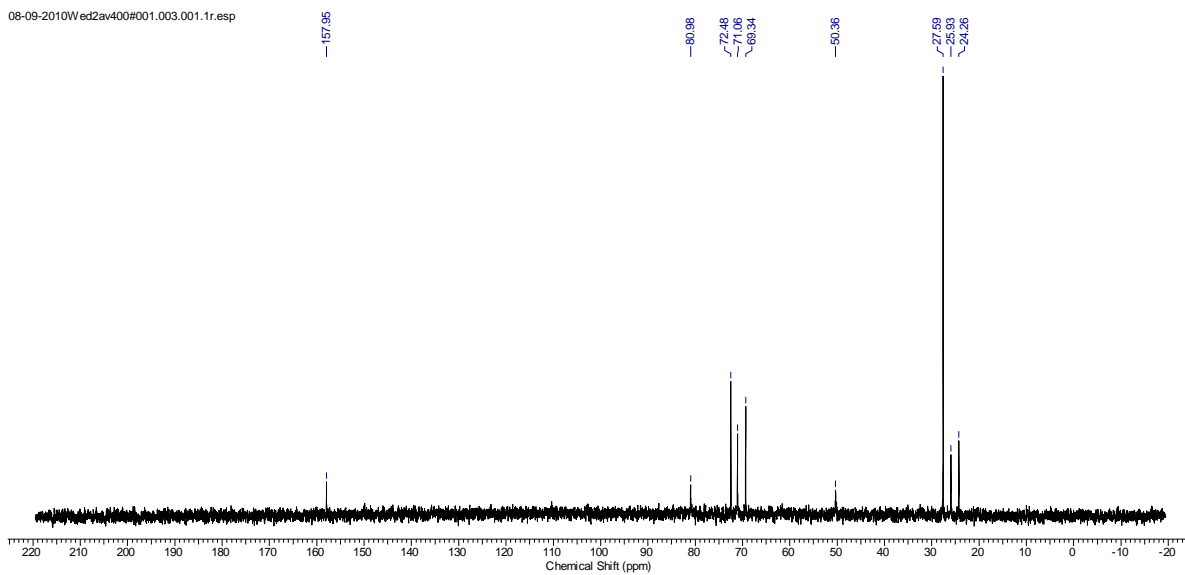

08-09-2010Wed2av400#001.002.001.1r.esp

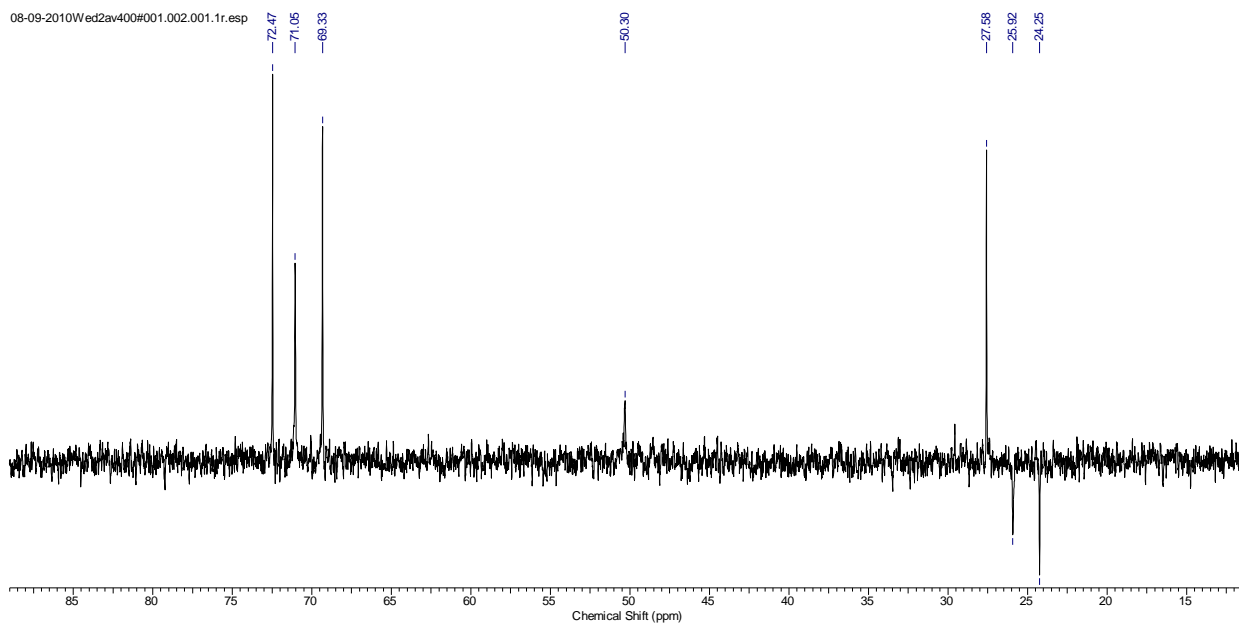

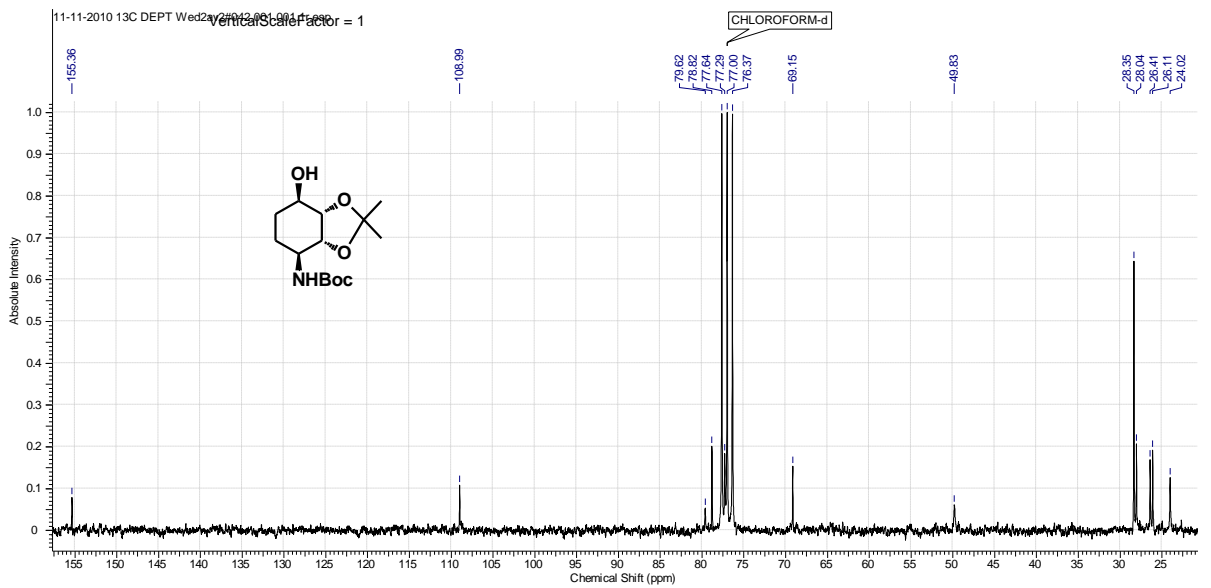
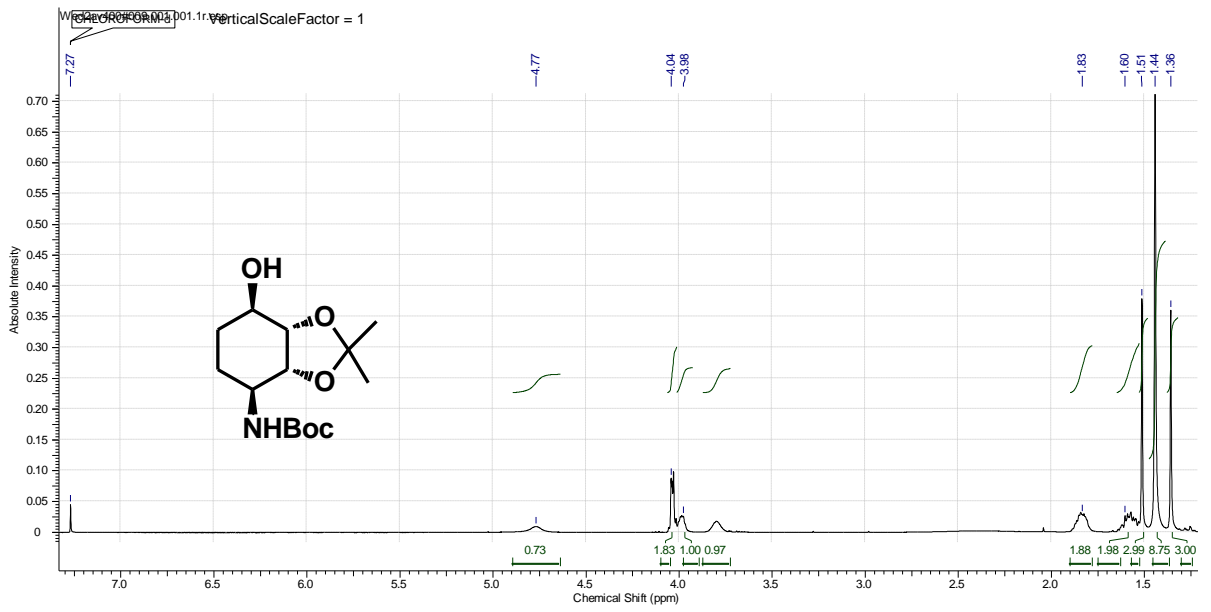

11-11-2010 13C DEPT Wed2av2#042.002.001.1r.esp

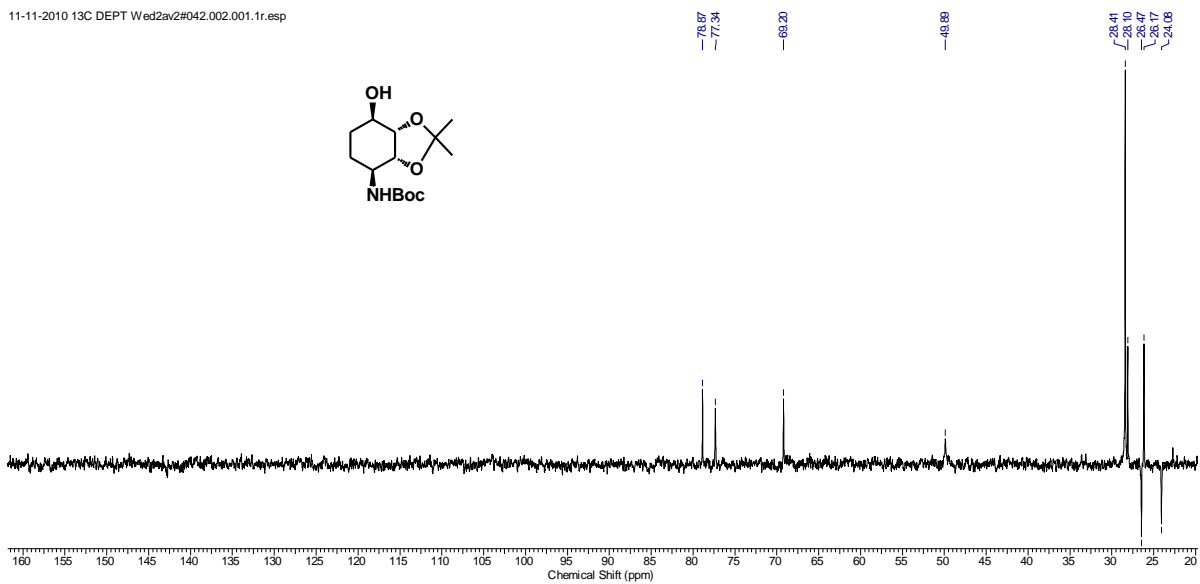

20110308042#021.001.001.1r.esp

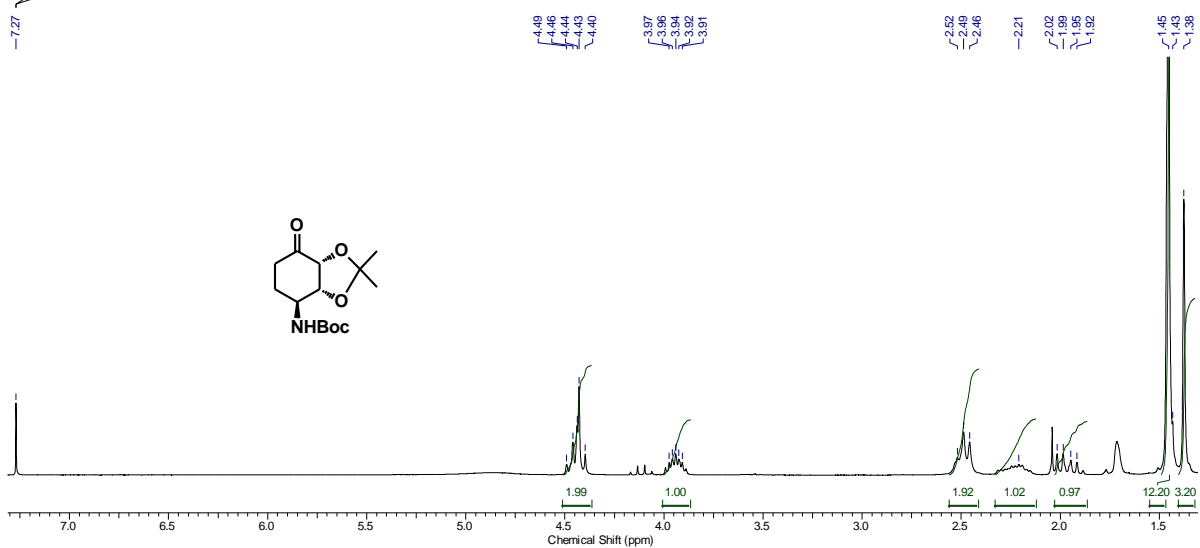

Chapter I: 7-azabicyclo [2.2.1] heptane skeleton and approaches towards....

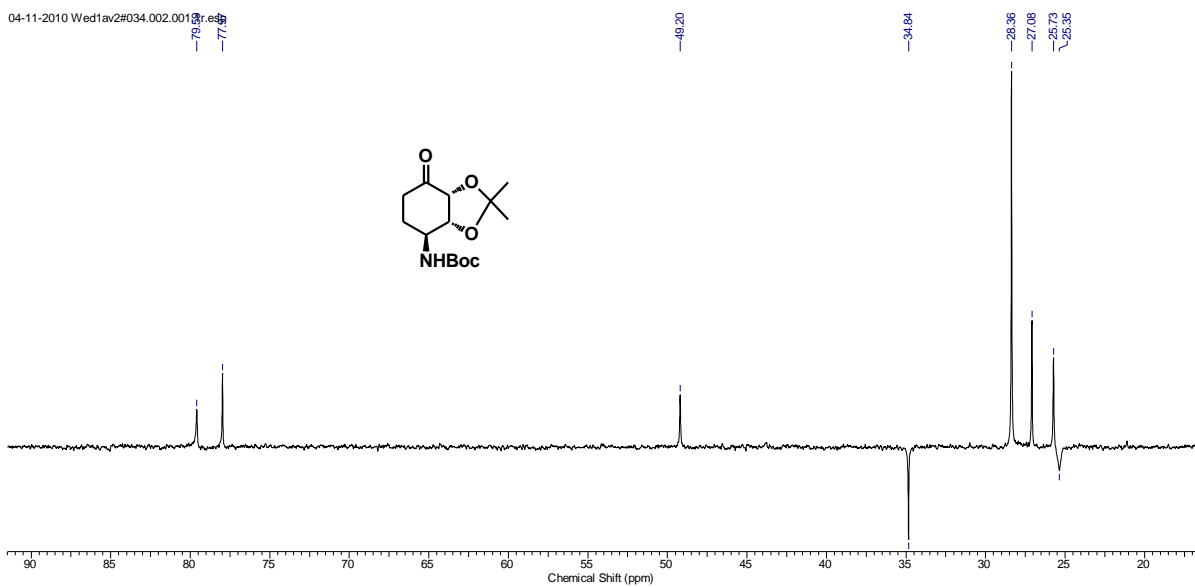
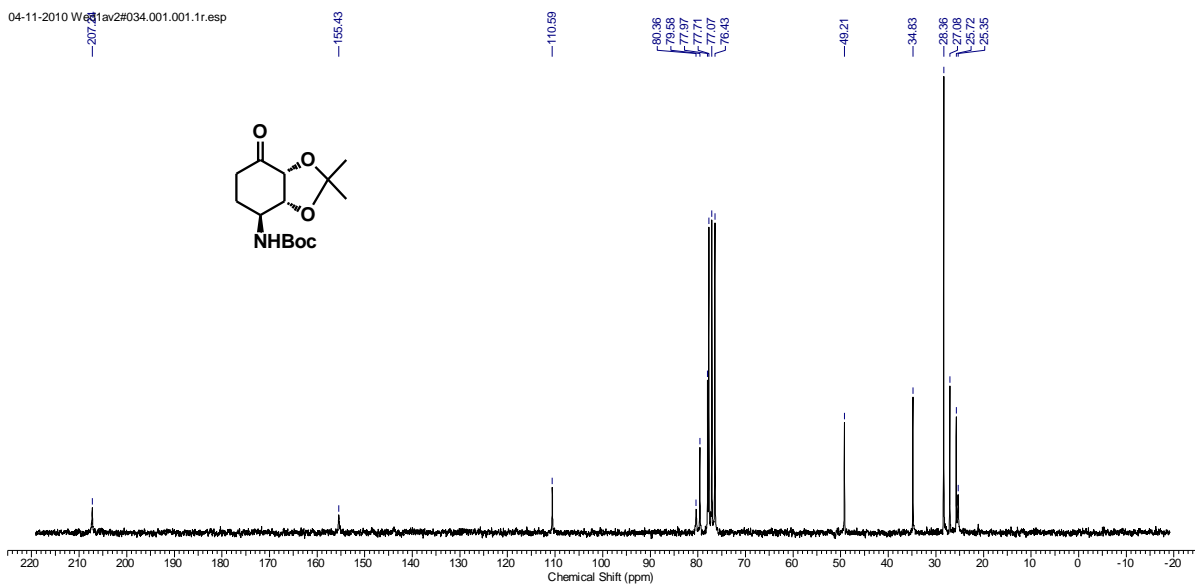

Chapter I: 7-azabicyclo [2.2.1] heptane skeleton and approaches towards....

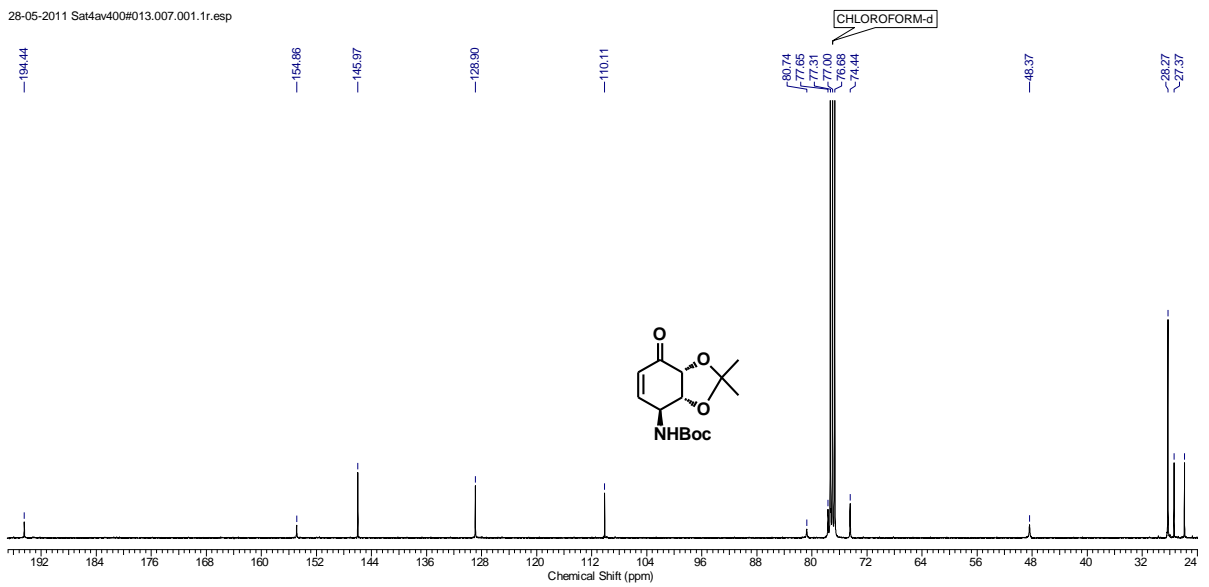
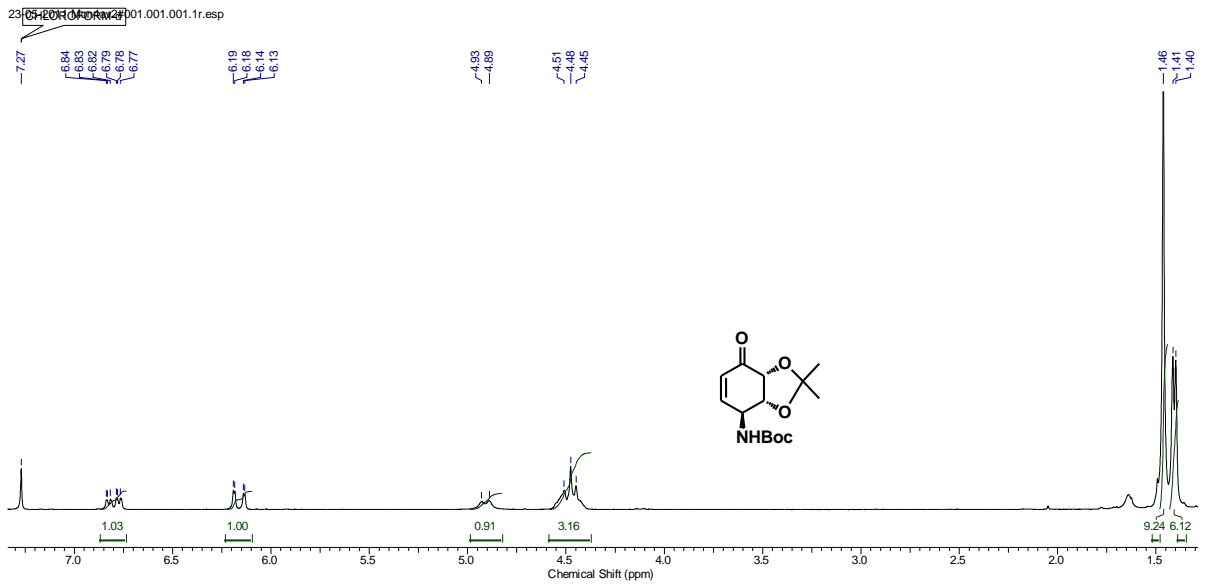

28-05-2011 Sat4av400#013.006.001.1r.esp

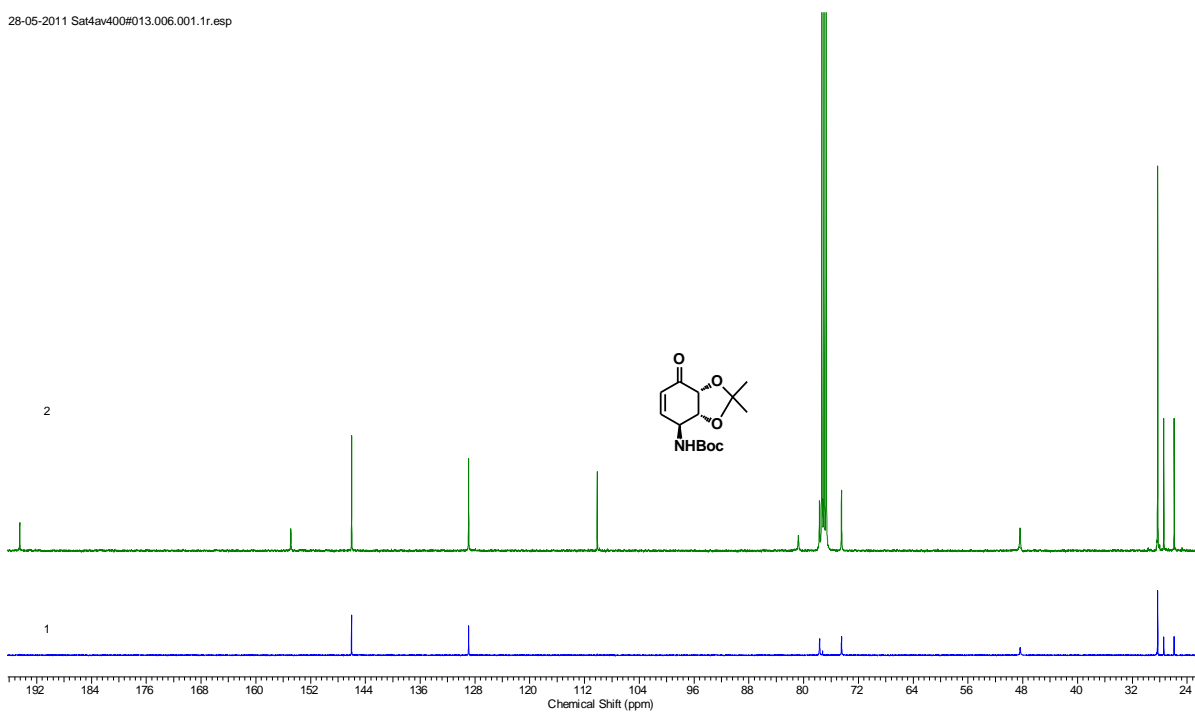

28-05-2011 Sat4av400#013.006.001.1r.esp

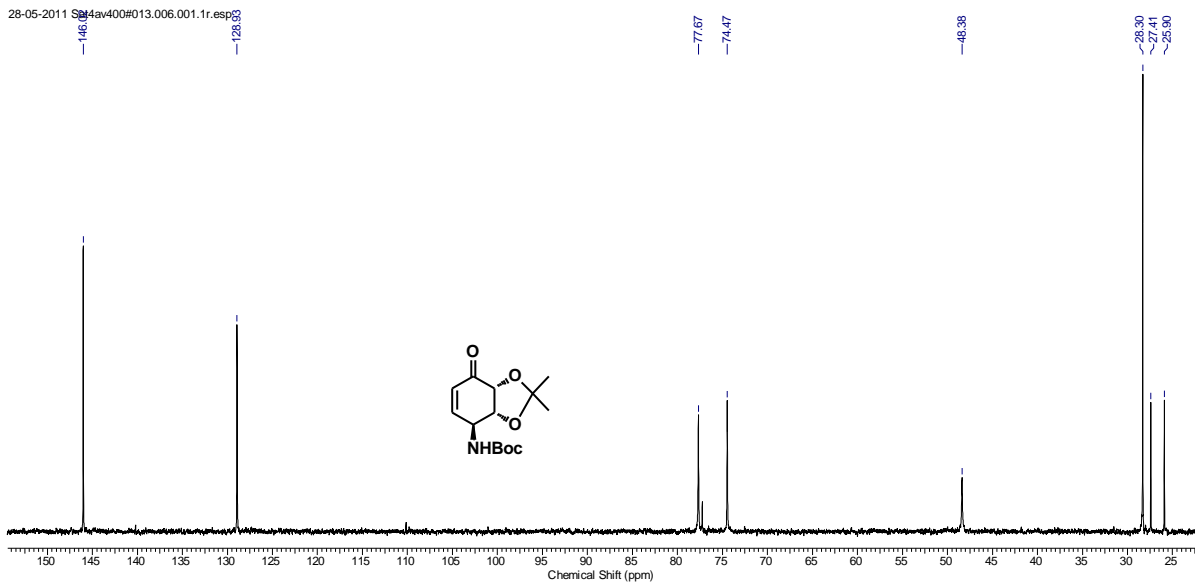

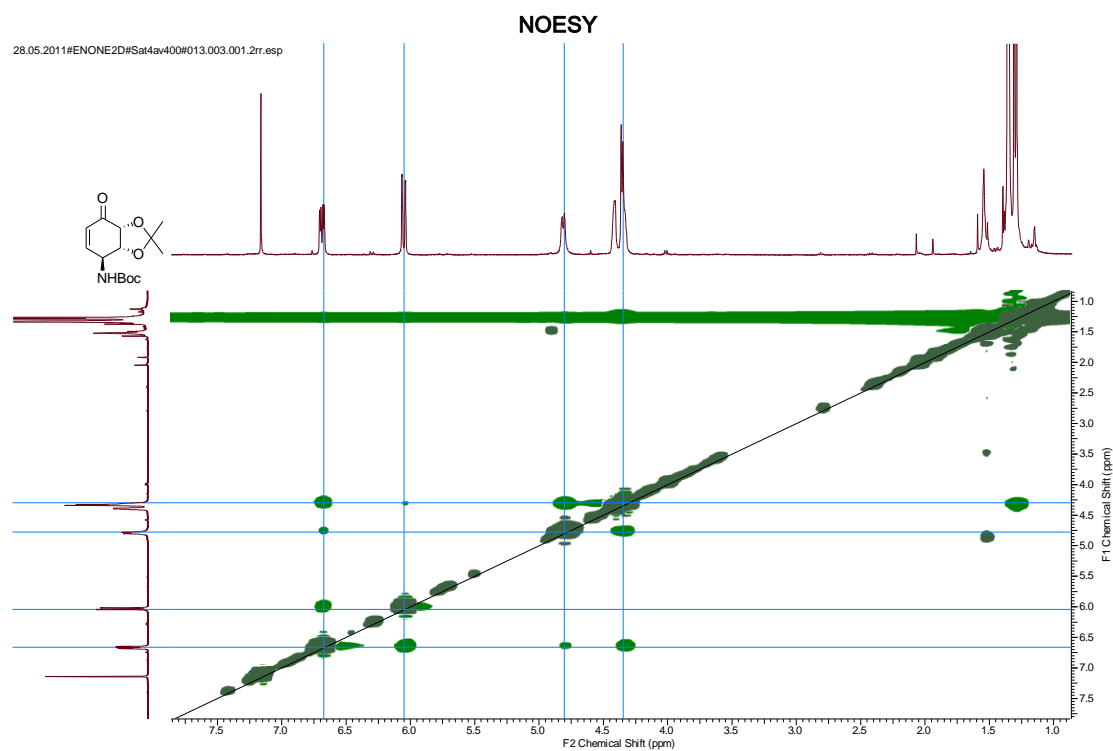
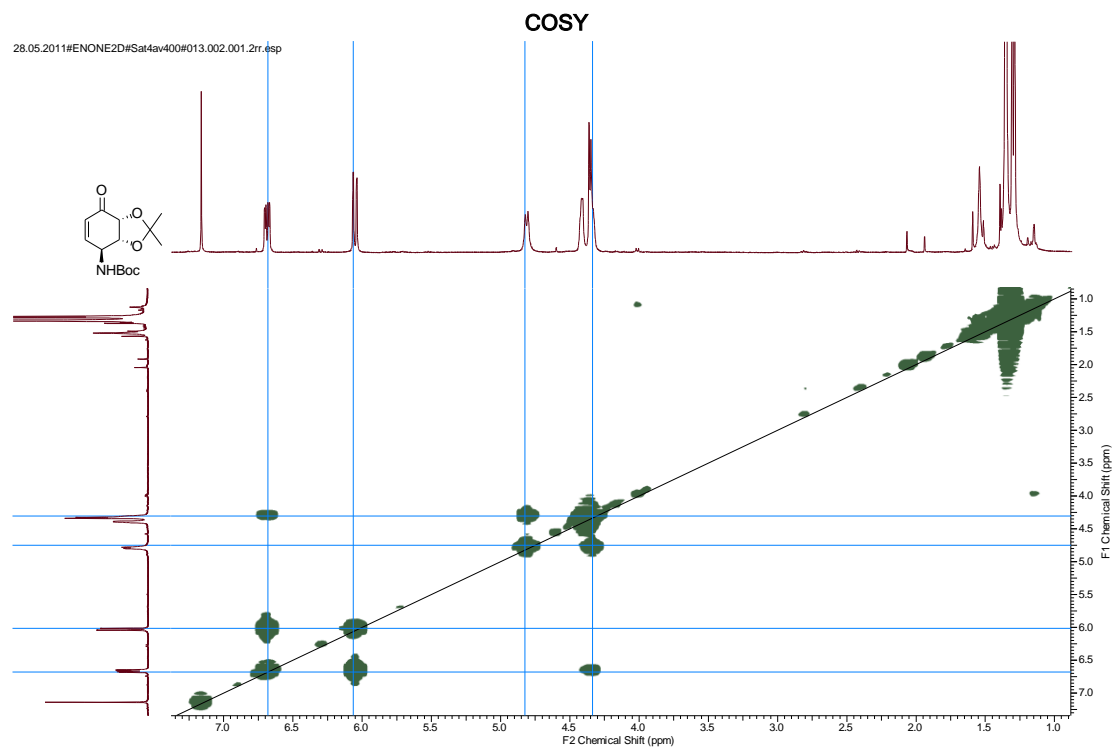

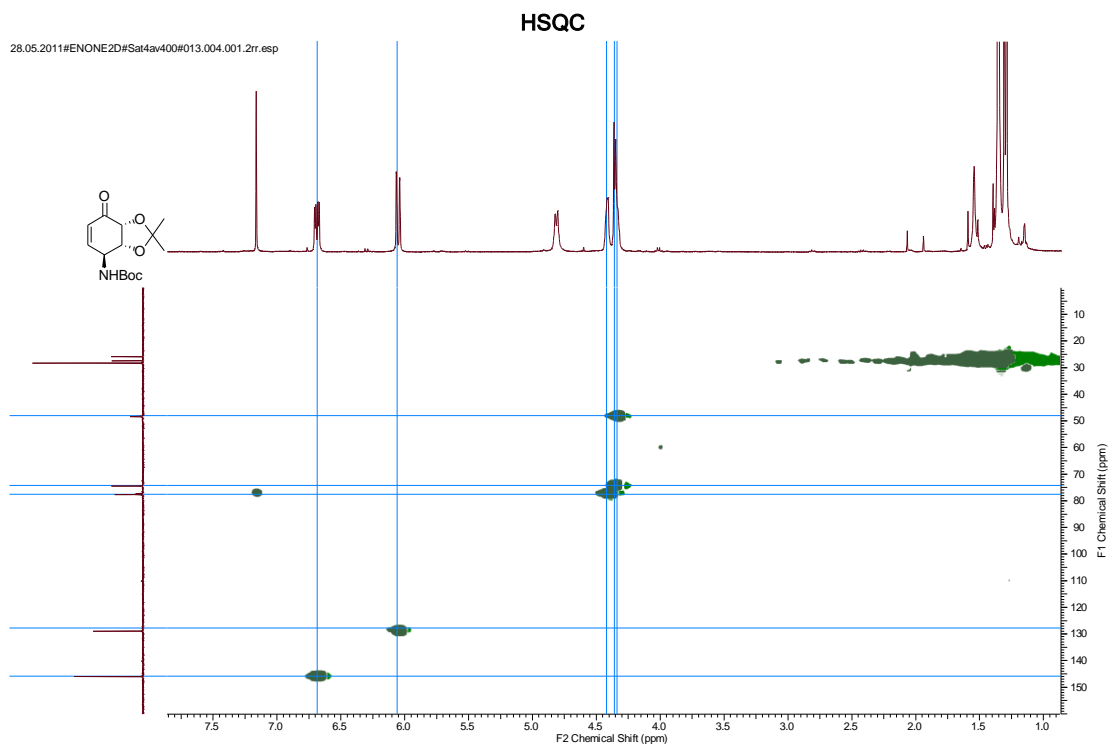

21.06.2011#ENONE2D#Tue4av400#010.001.001.1r.esp

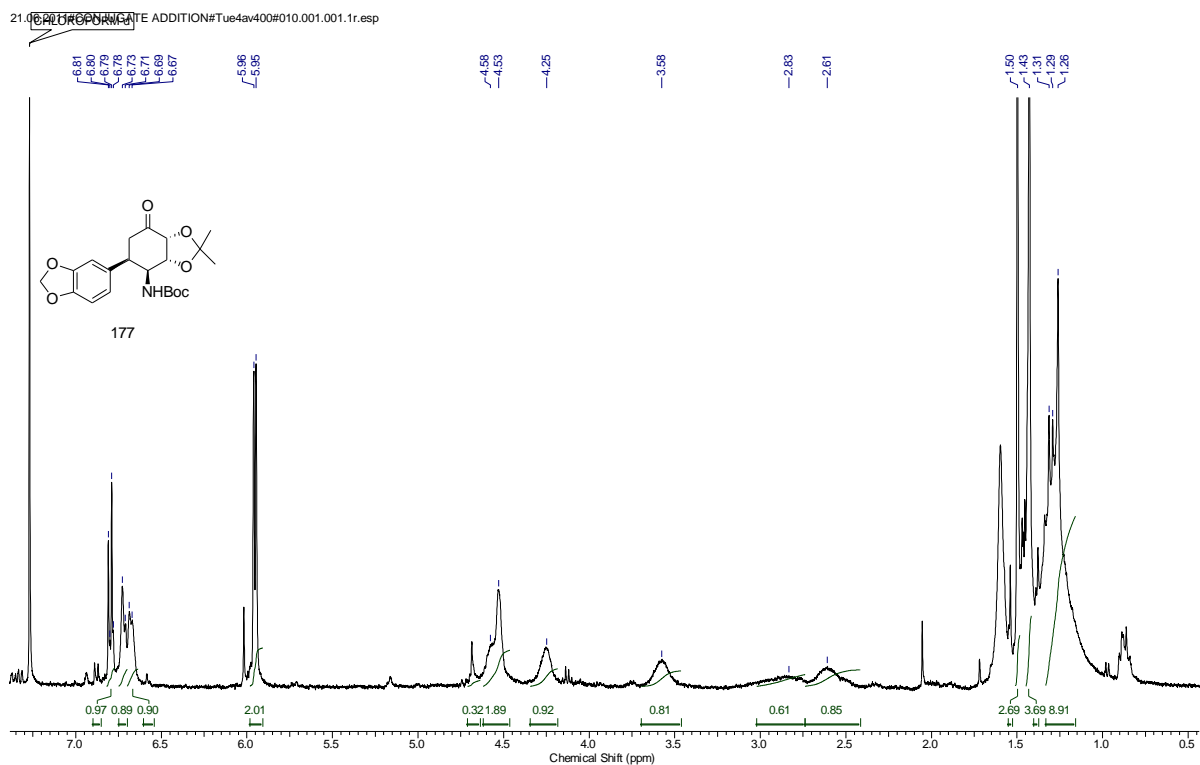

28.06.2016 CHLORFORM-d Sav400#013.001.001.1r.esp

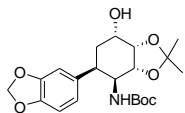
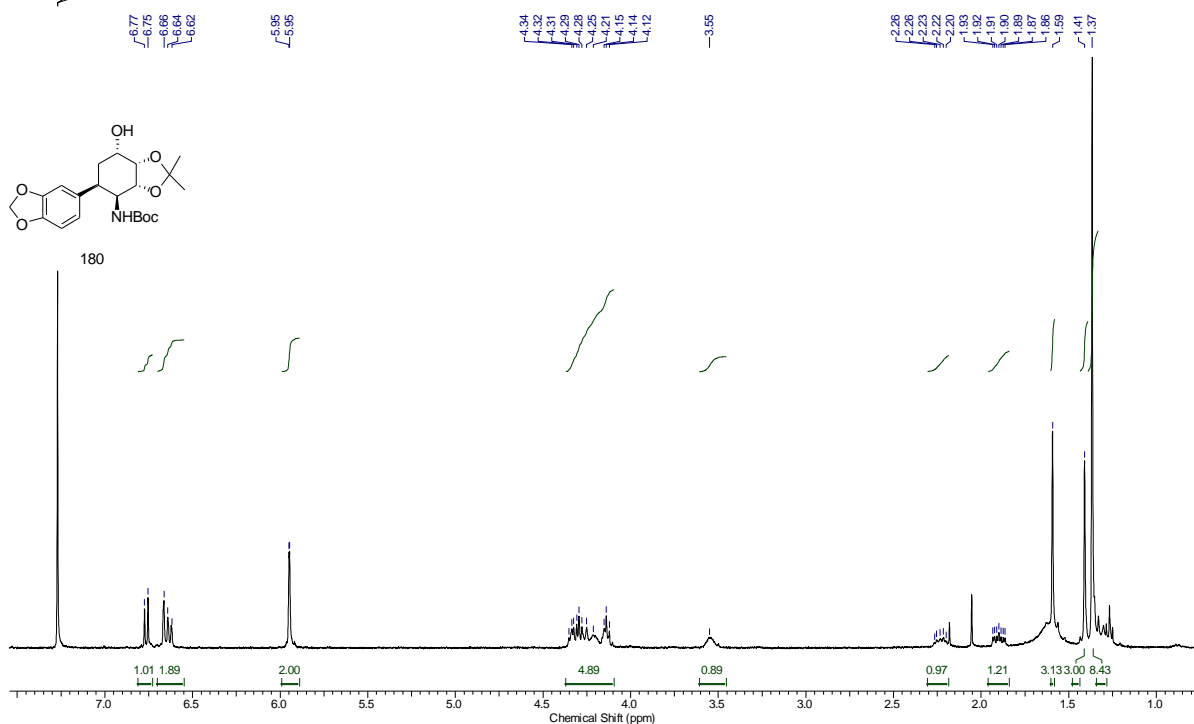

180

$^1\text{H NMR}$ (500MHz, CHLOROFORM-d) δ = 6.76 (d, J = 7.9 Hz, 4 H), 6.68 - 6.59 (m, 7 H), 5.99 - 5.91 (m, 8 H), 4.37 - 4.32 (m, 3 H), 4.31 - 4.27 (m, 4 H), 4.20 (br. s., 4 H), 4.16 - 4.11 (m, 4 H), 3.54 (br. s., 4 H), 2.24 (br. s., 3 H), 1.94 - 1.86 (m, 4 H), 1.59 (s, 11 H), 1.41 (s, 11 H), 1.36 (s, 33 H)

23.07.2016 CHLORFORM-d D2O#Sat4#500#003.001.001.1r.esp

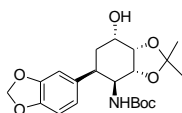
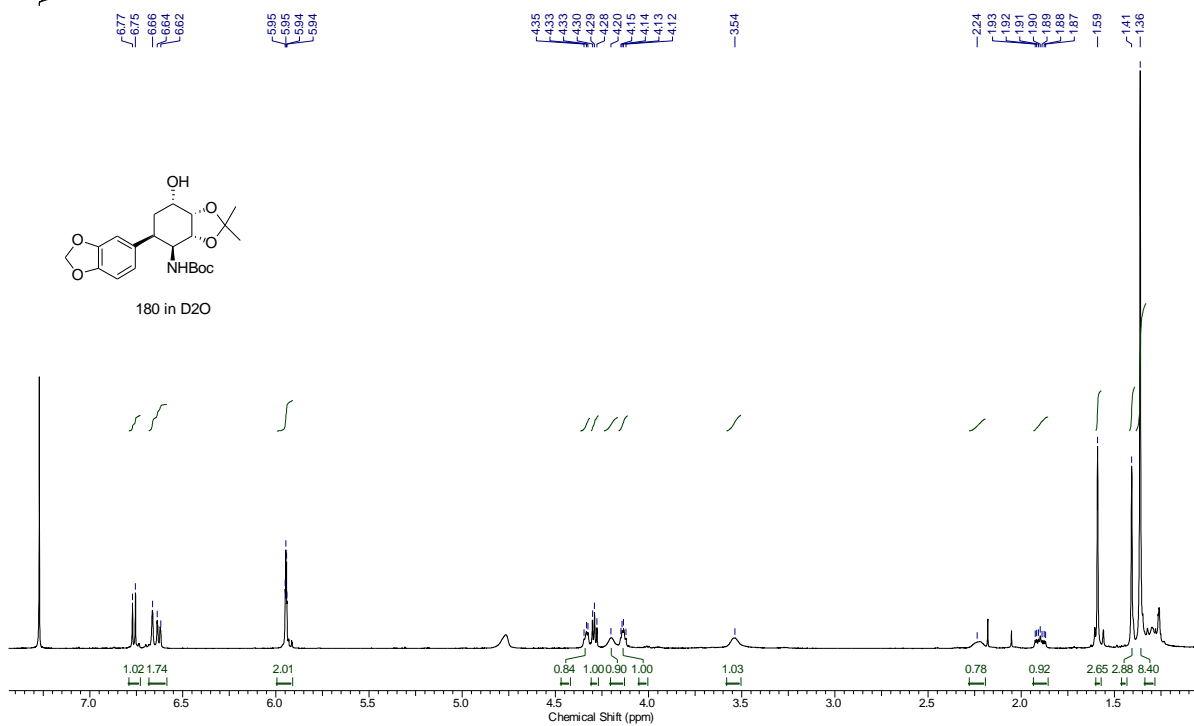

180 in D2O

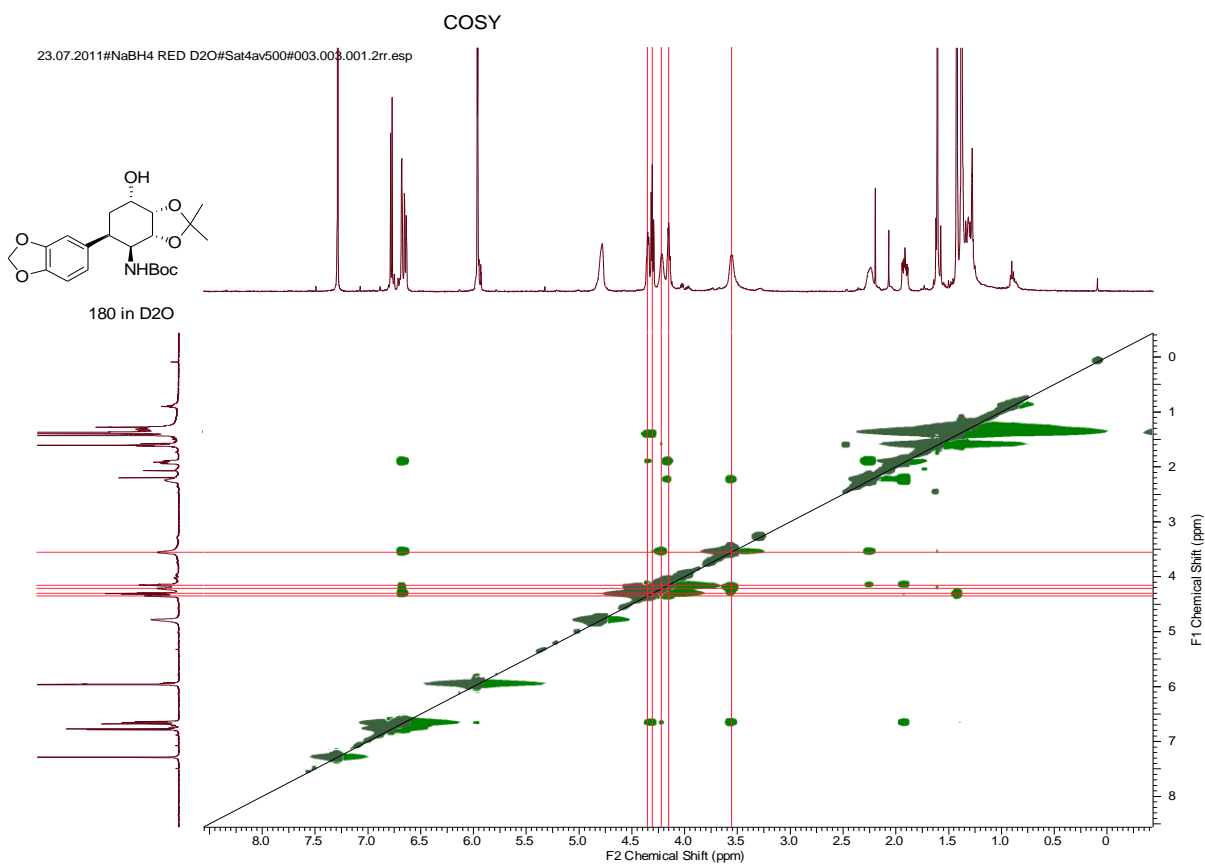
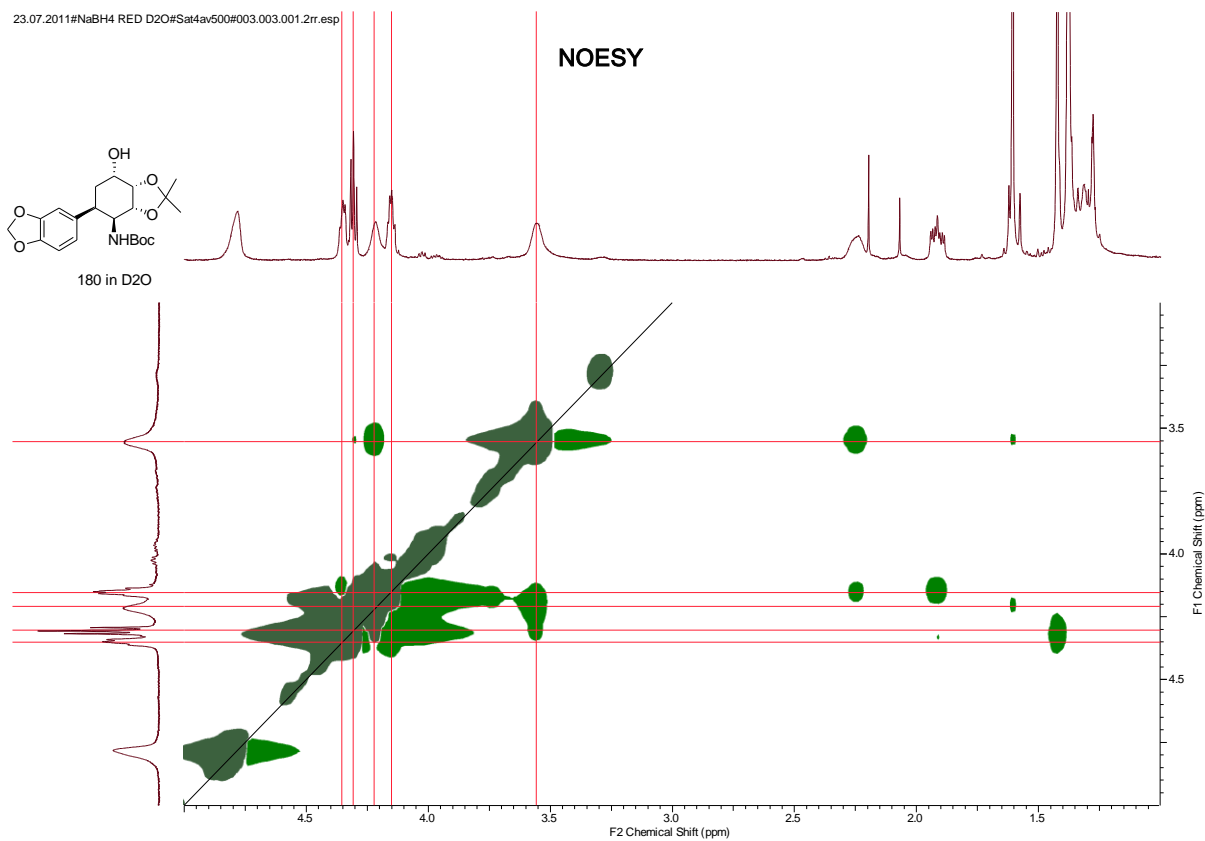

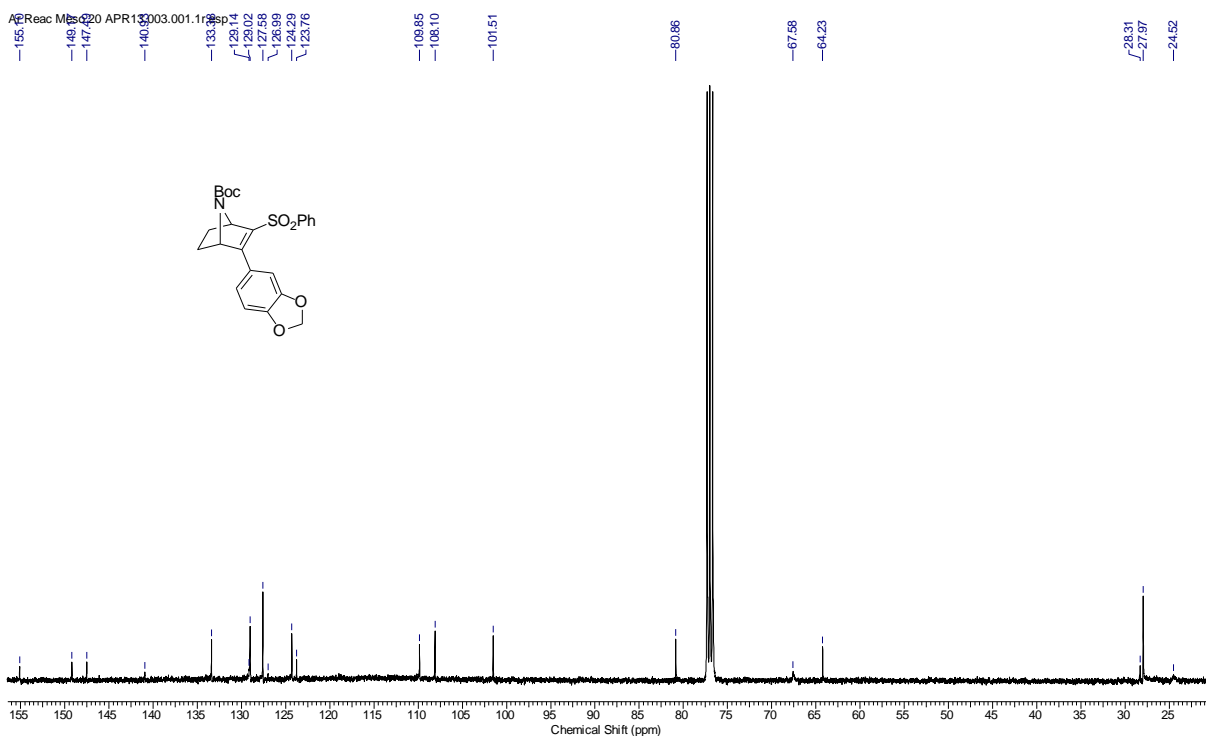
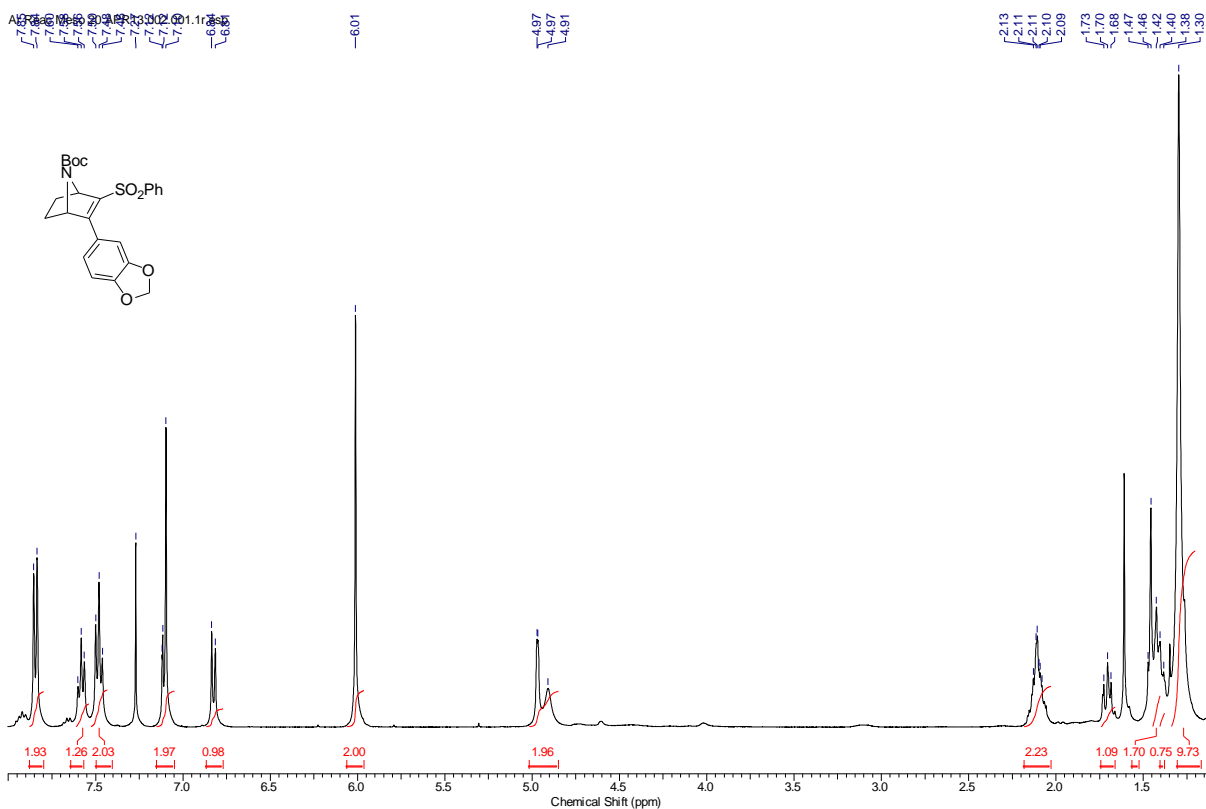

Ar Reac Meso 20 APR13.004.001.1r.esp

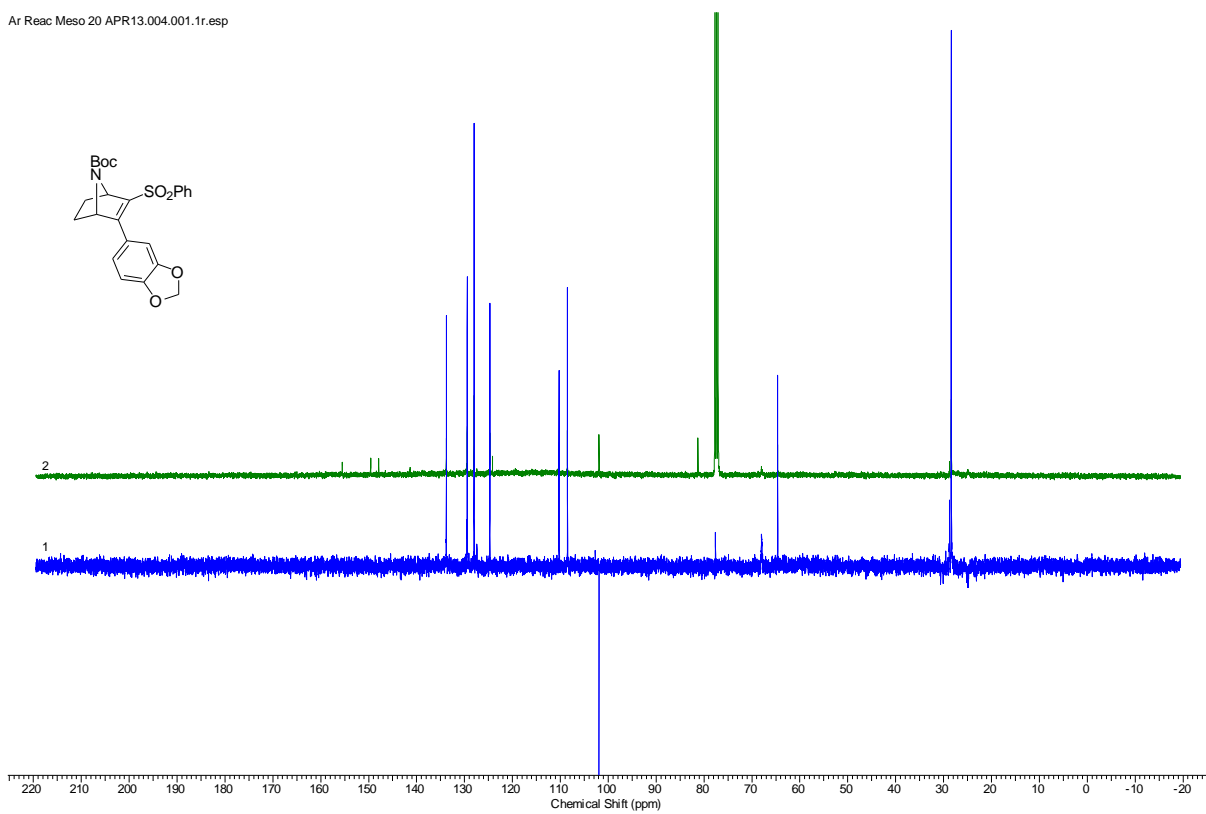

Ar Reac Meso 20 APR13.004.001.1r.esp

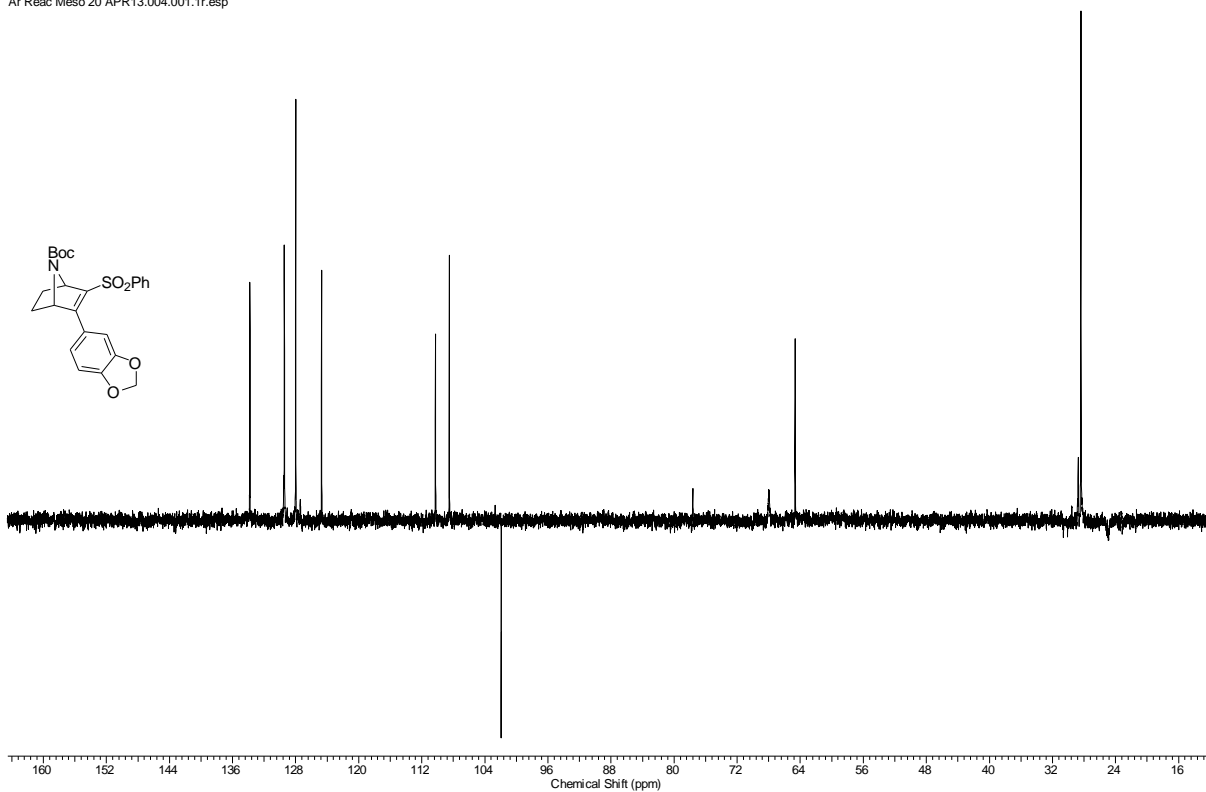

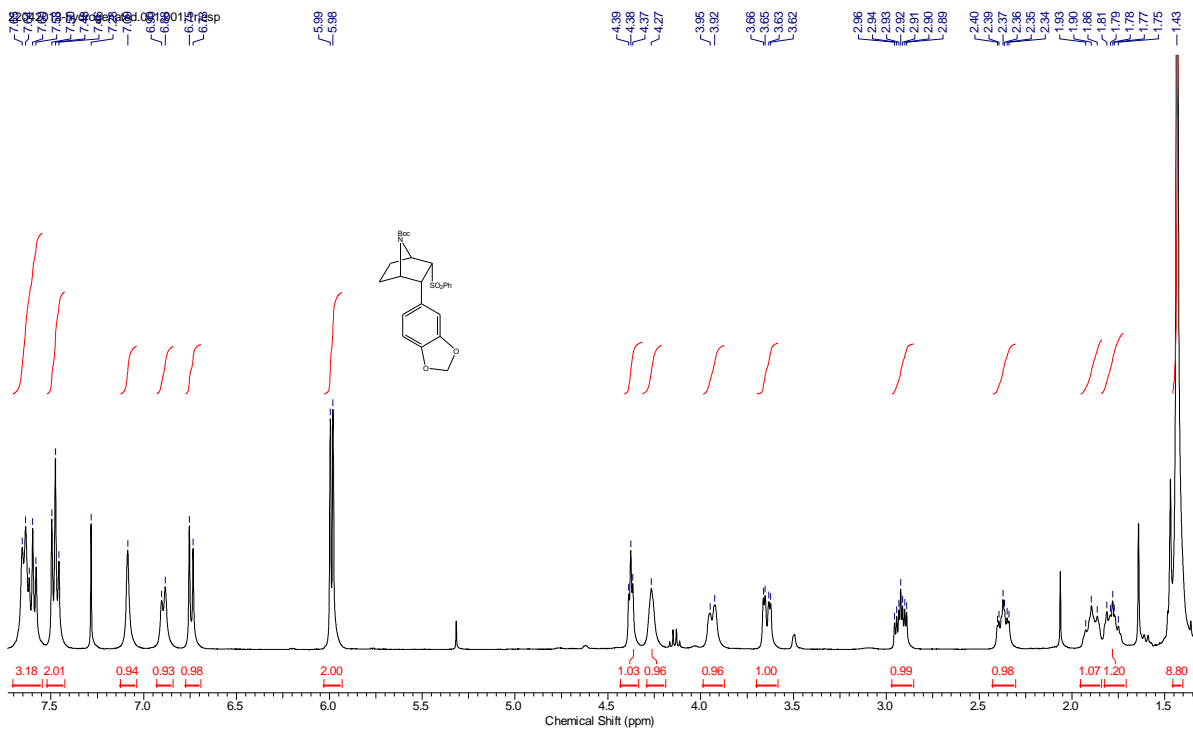
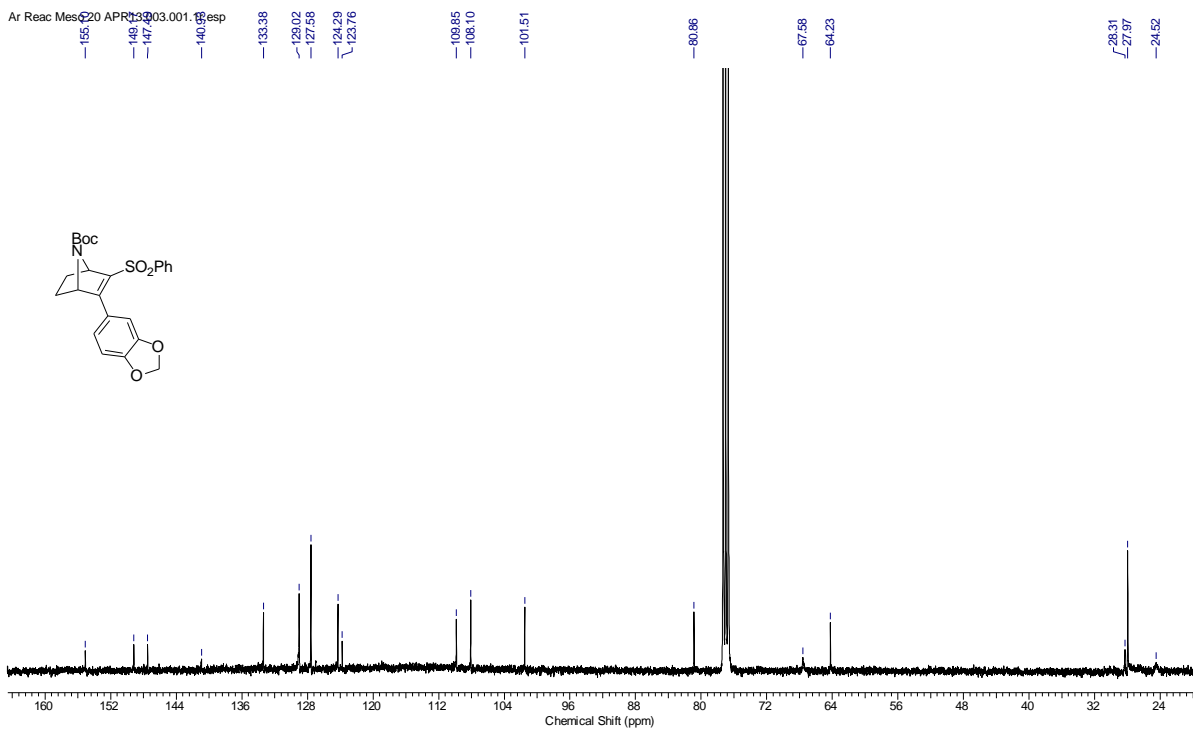

HYDRO-AR-23APR2013.002.001.1r.esp

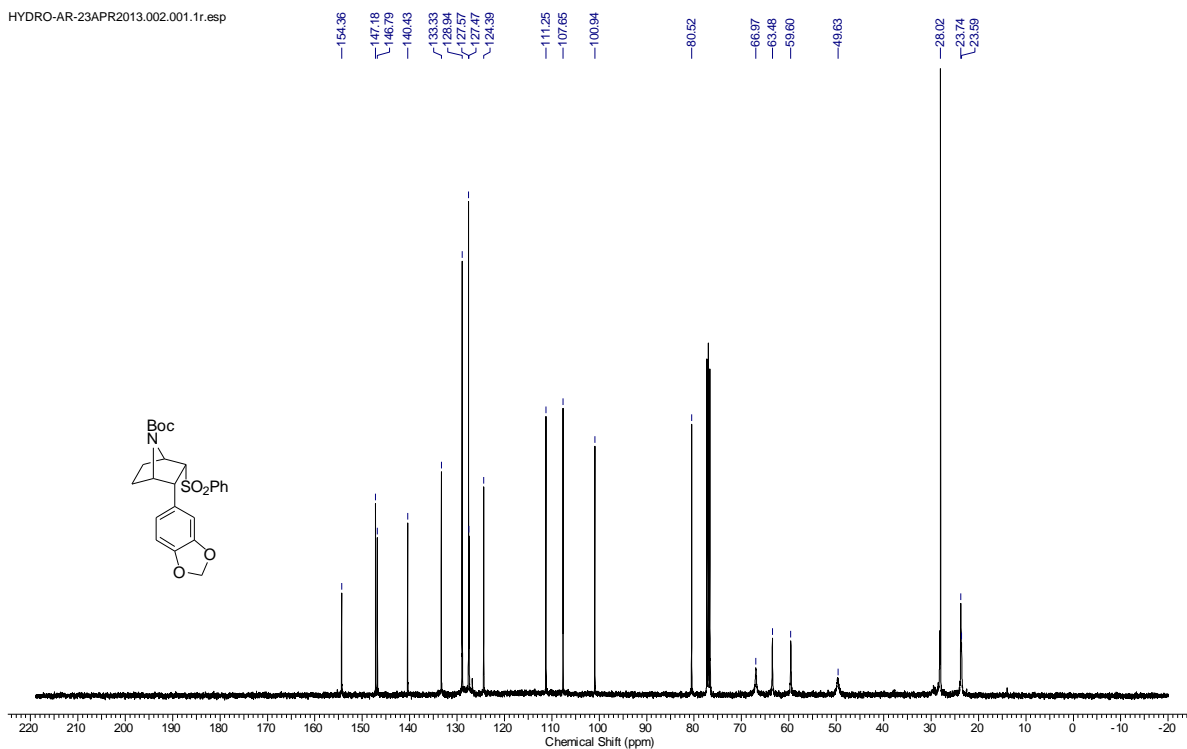

HYDRO-AR-23APR2013.003.001.1r.esp

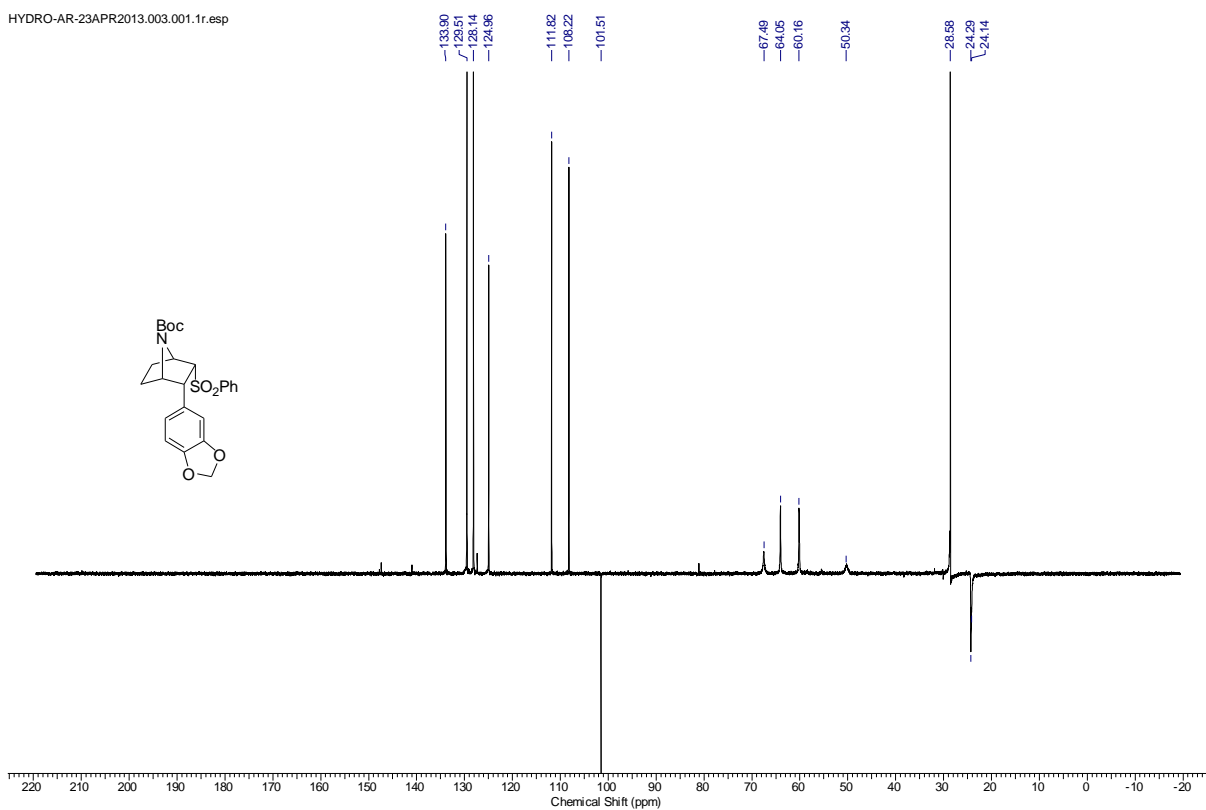

HYDRO-AR-23APR2013.003.001.1r.esp

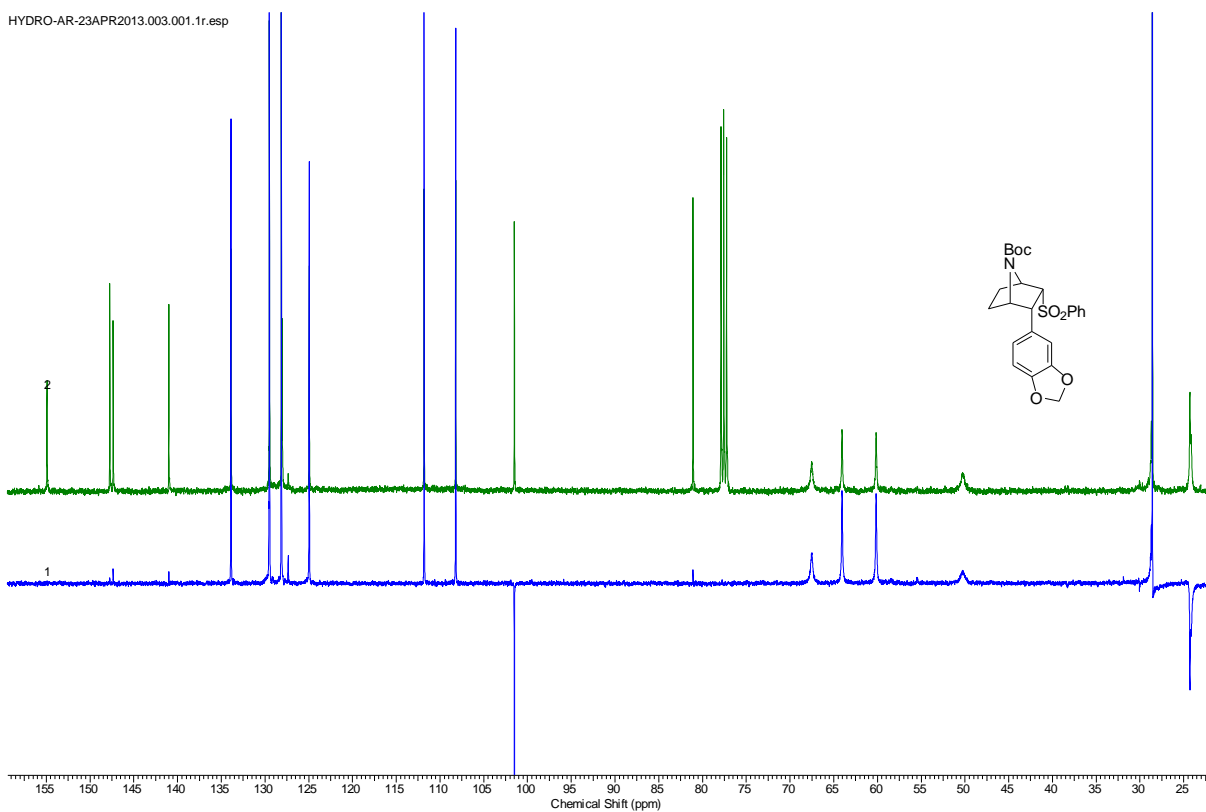
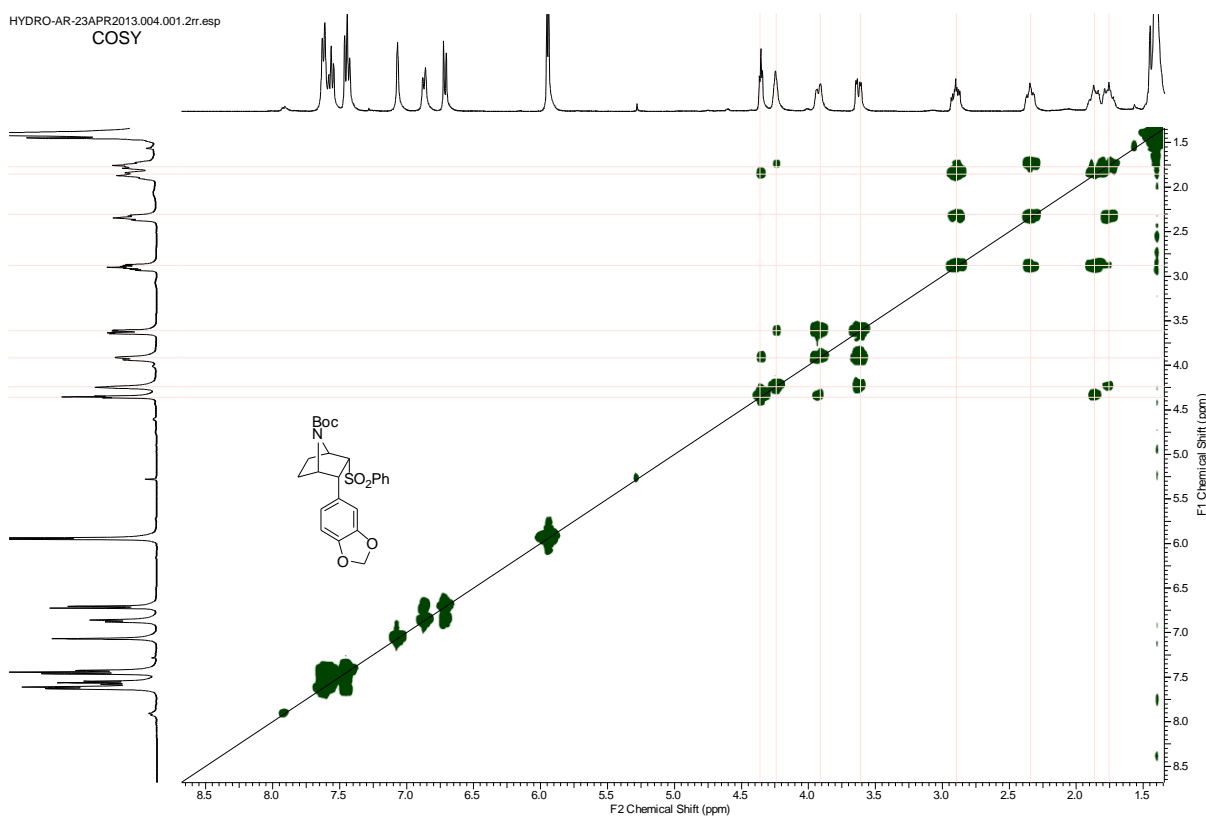
HYDRO-AR-23APR2013.004.001.2rr.esp
COSY

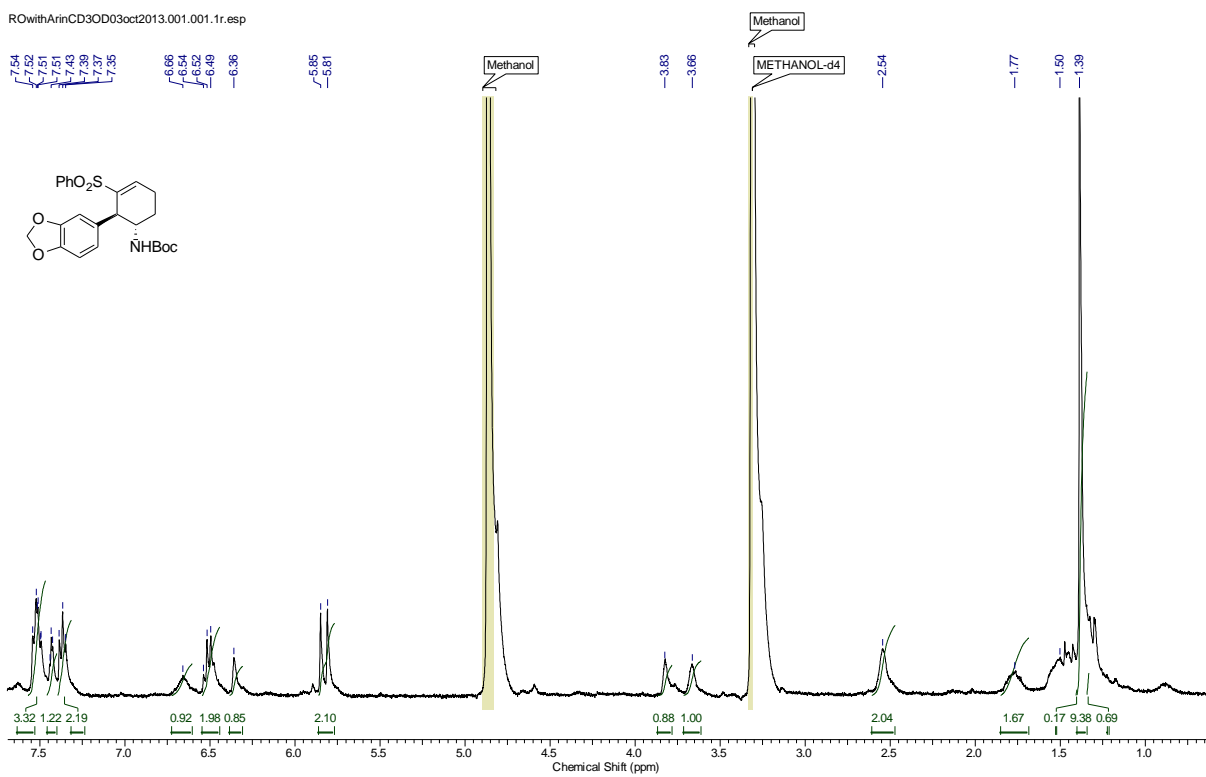
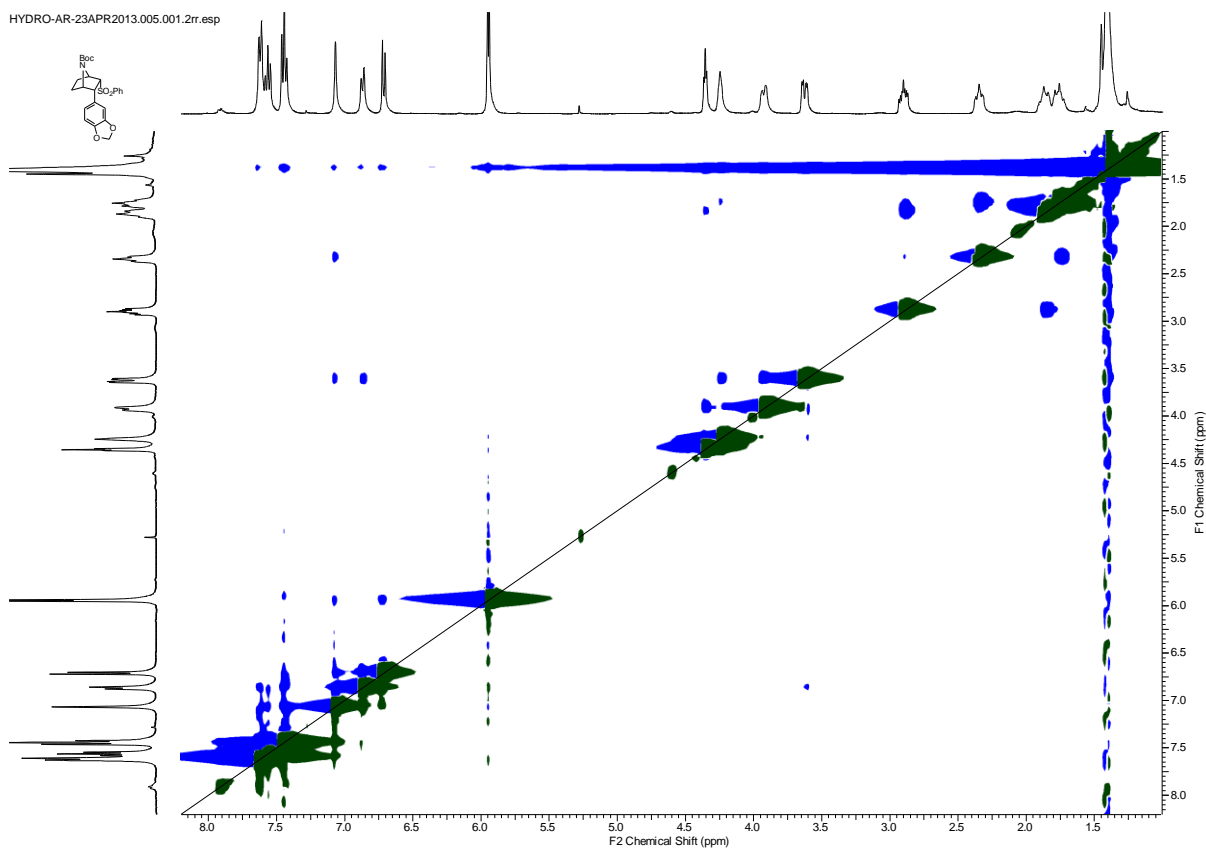

ROwithAriInCD3OD03oct2013.002.001.2rr.esp

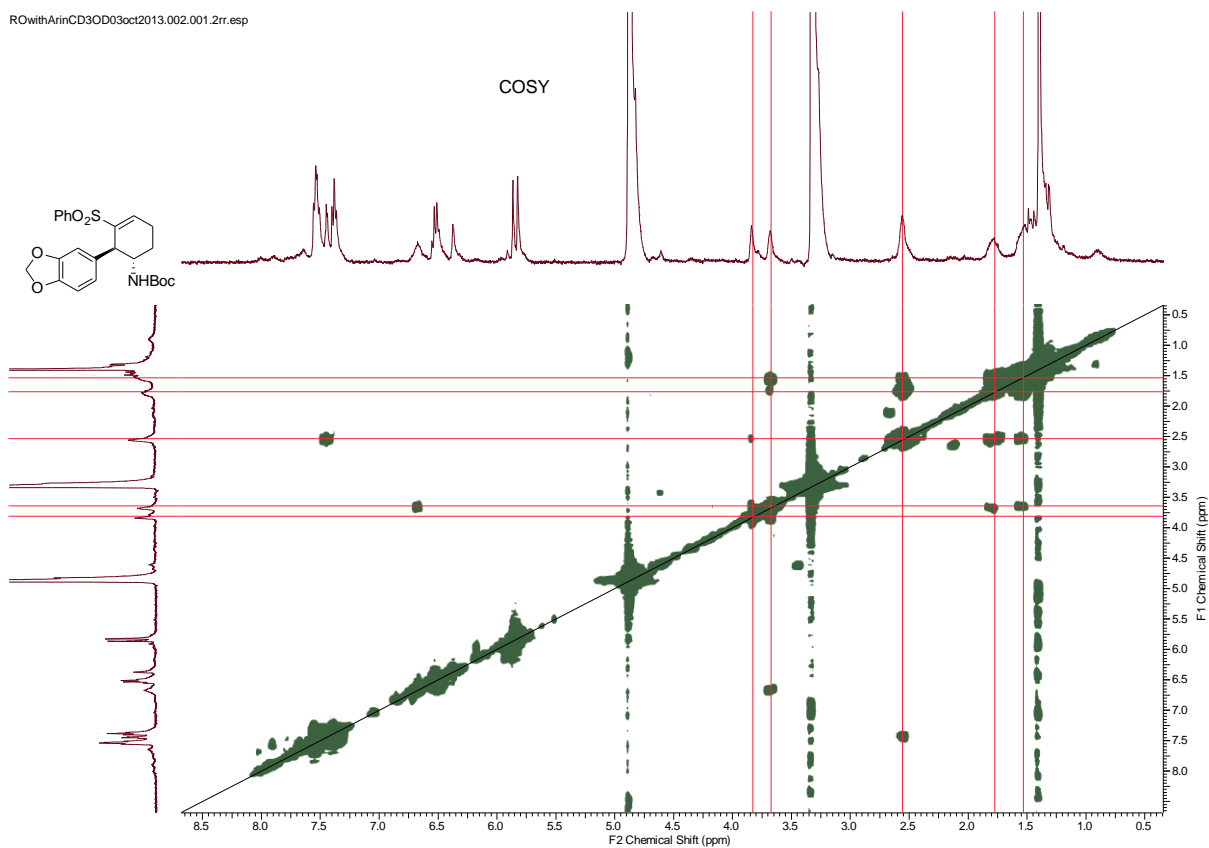

RO-HYDRO-AR-23APR2013.003.001.1r.esp

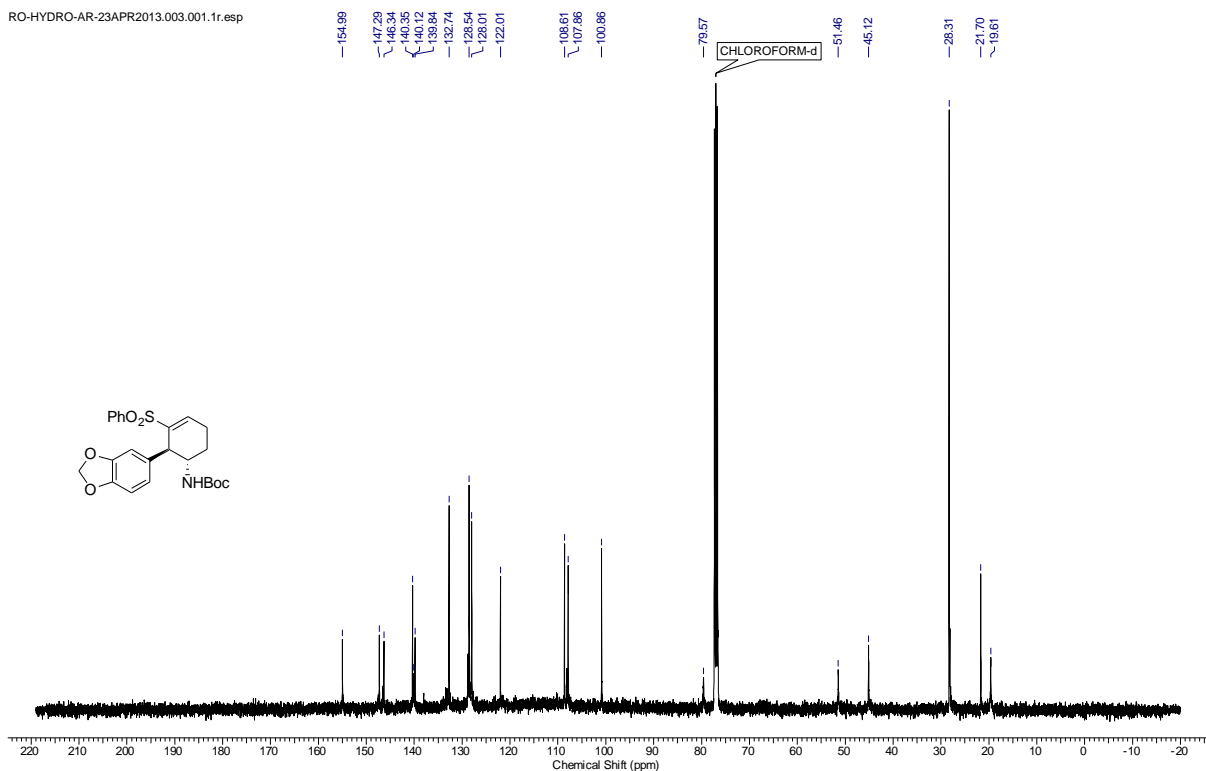

RO-HYDRO-AR-23APR2013.004.001.1r.esp

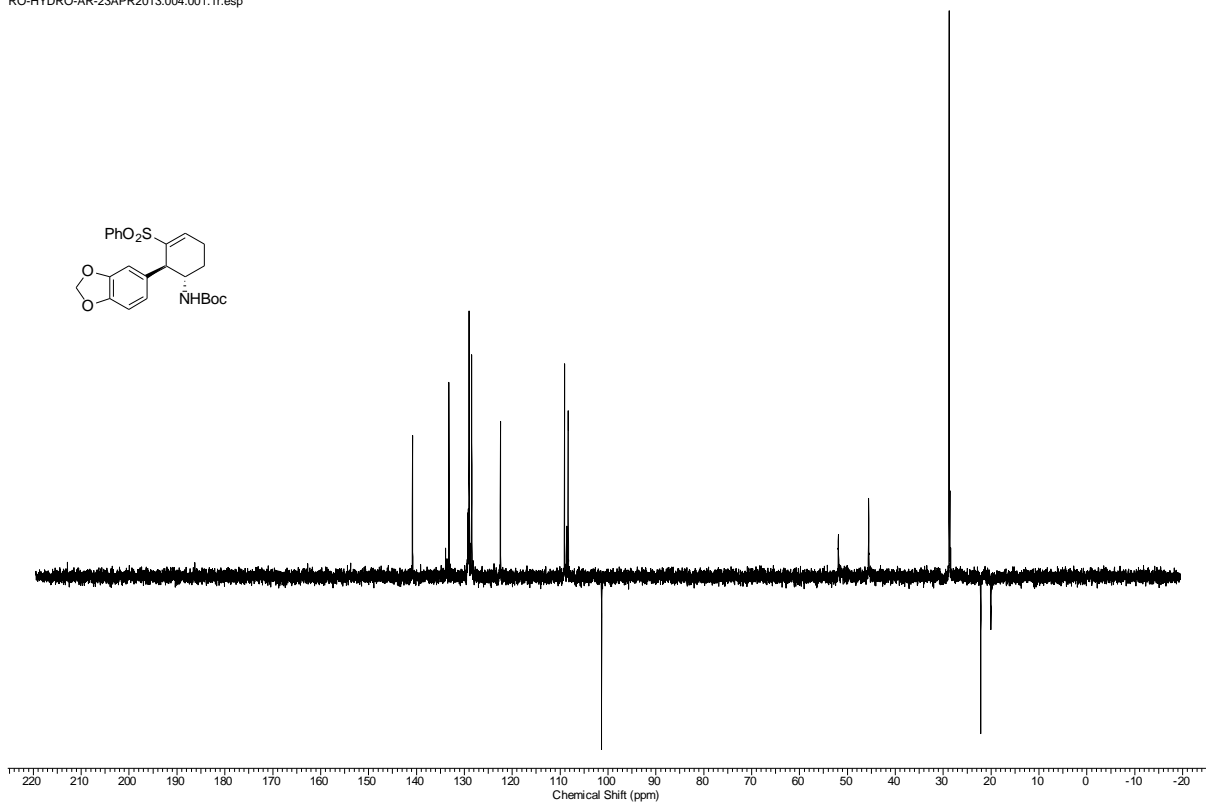
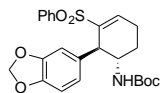

desult@MAGNAPFORM@3.001.001.1r.esp

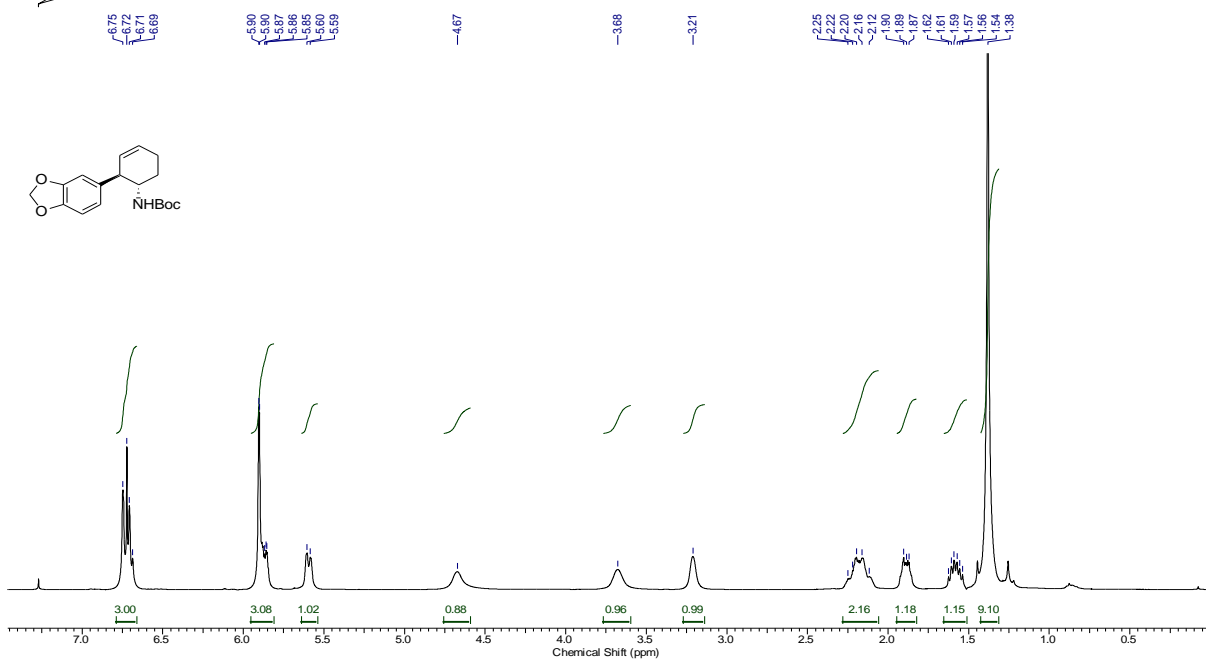

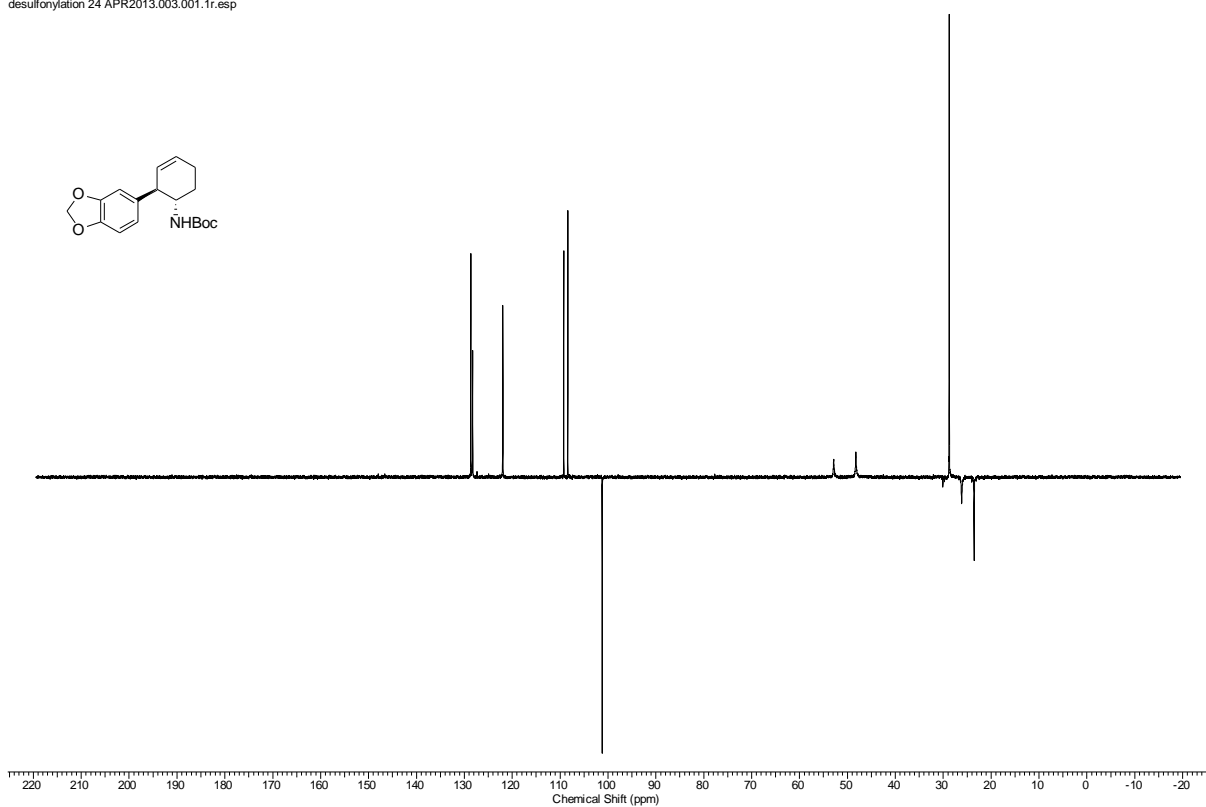
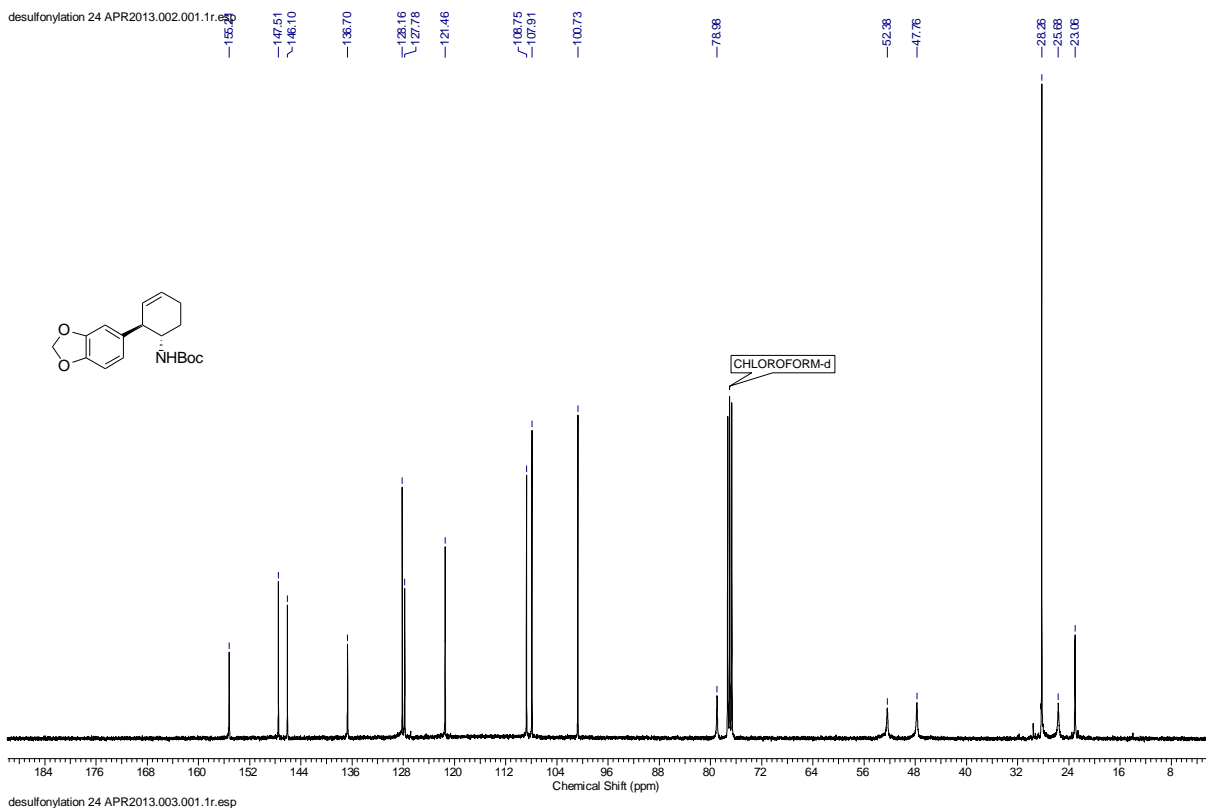

epoxide.006.001.1r.esp

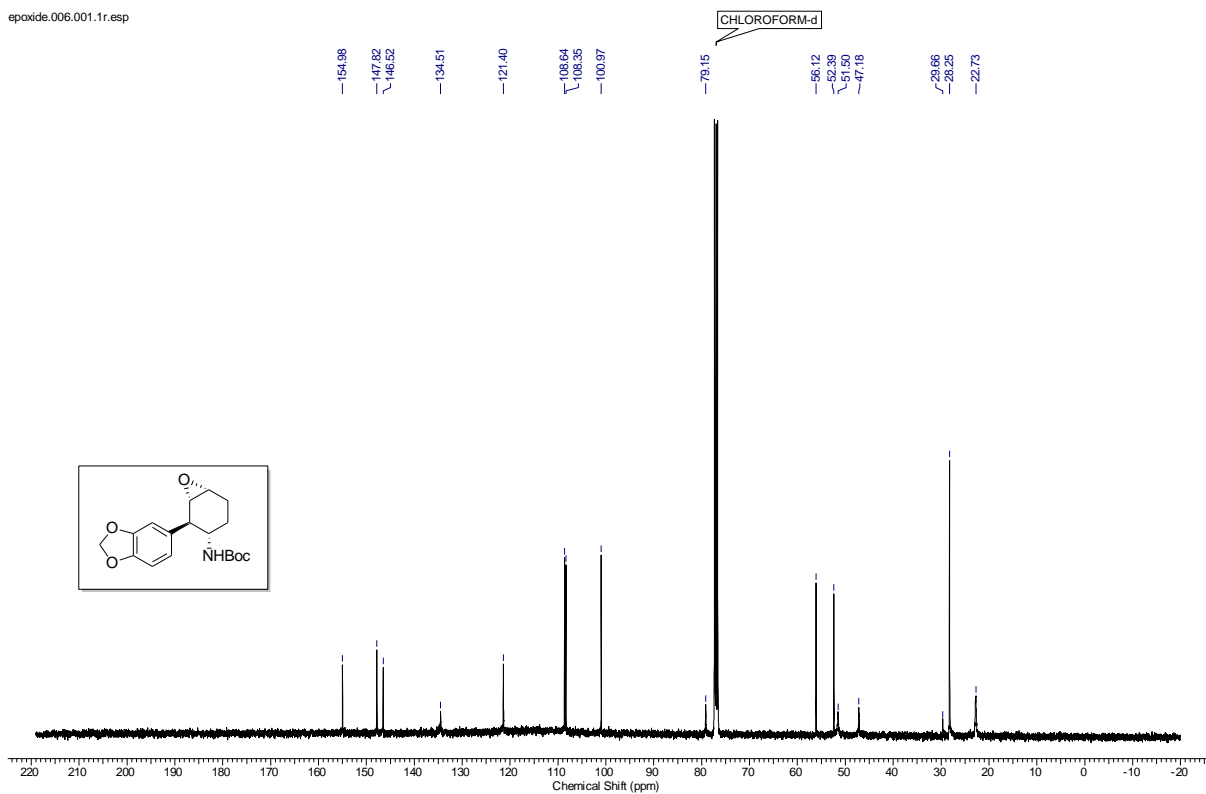

epoxide.003.001.1r.esp

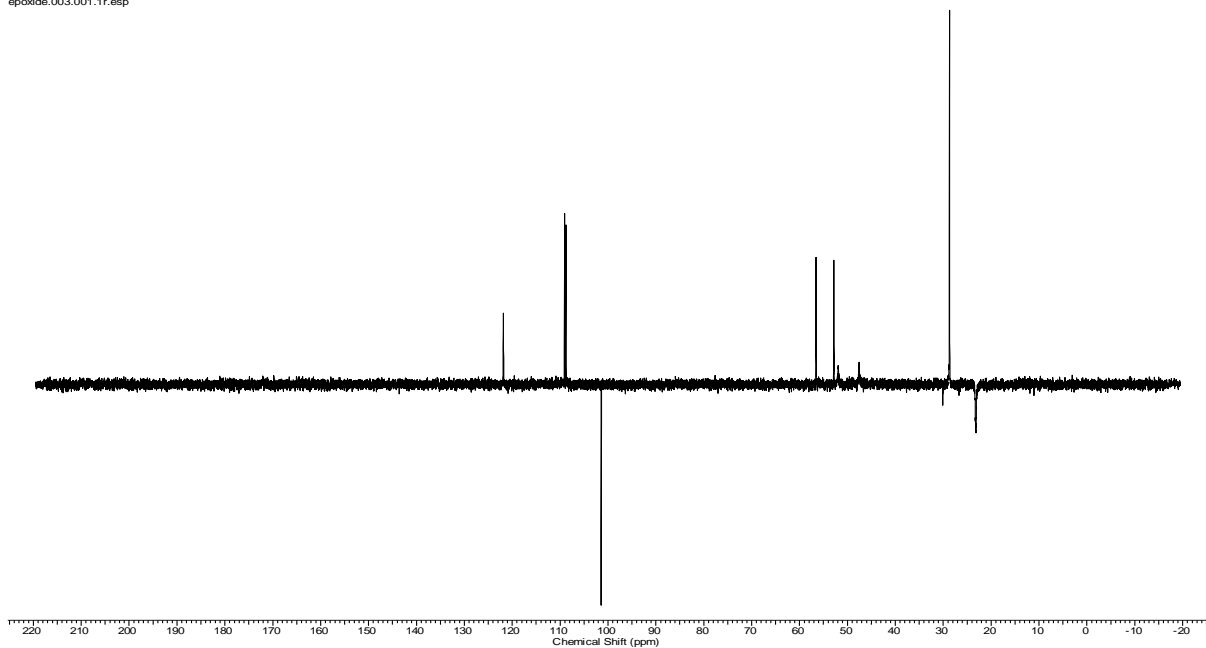

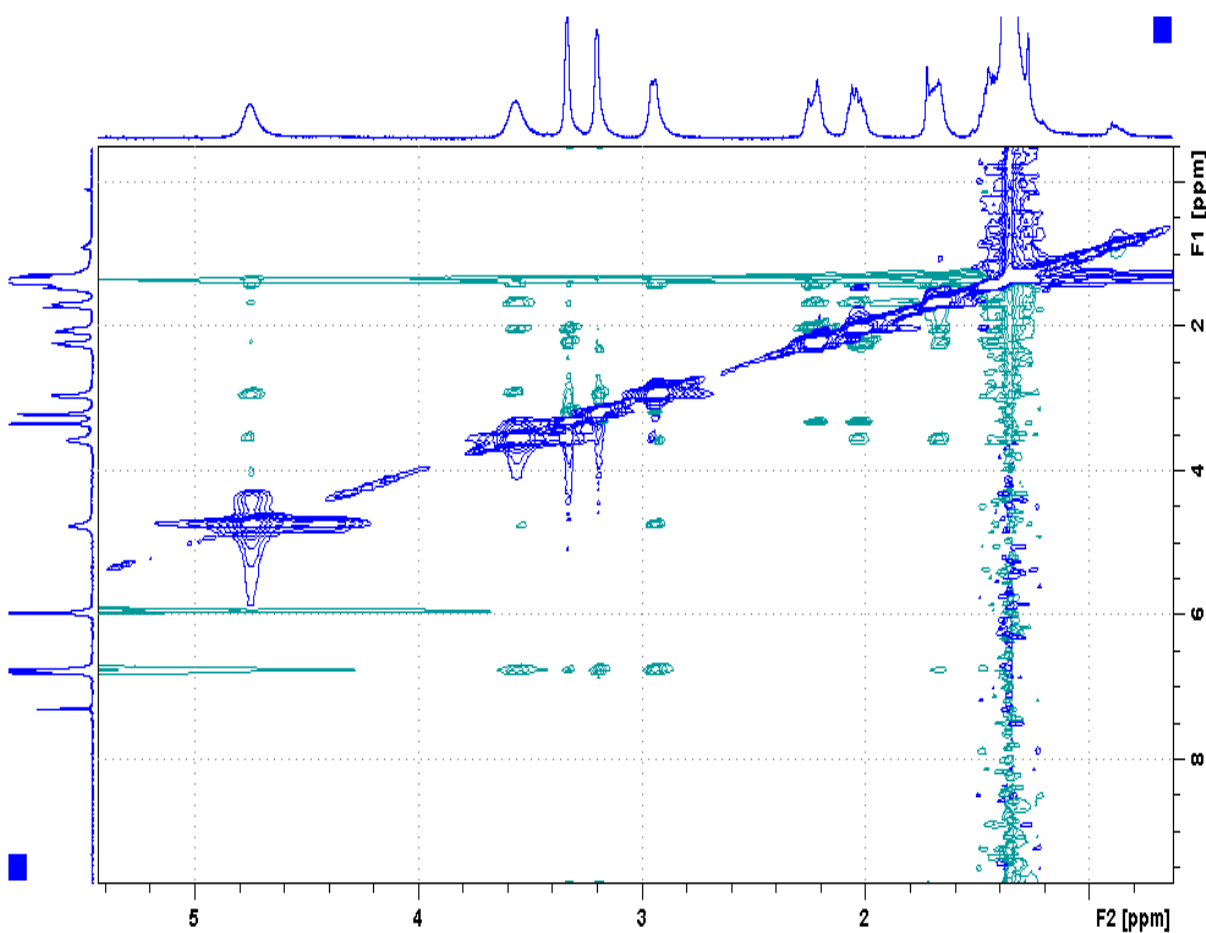
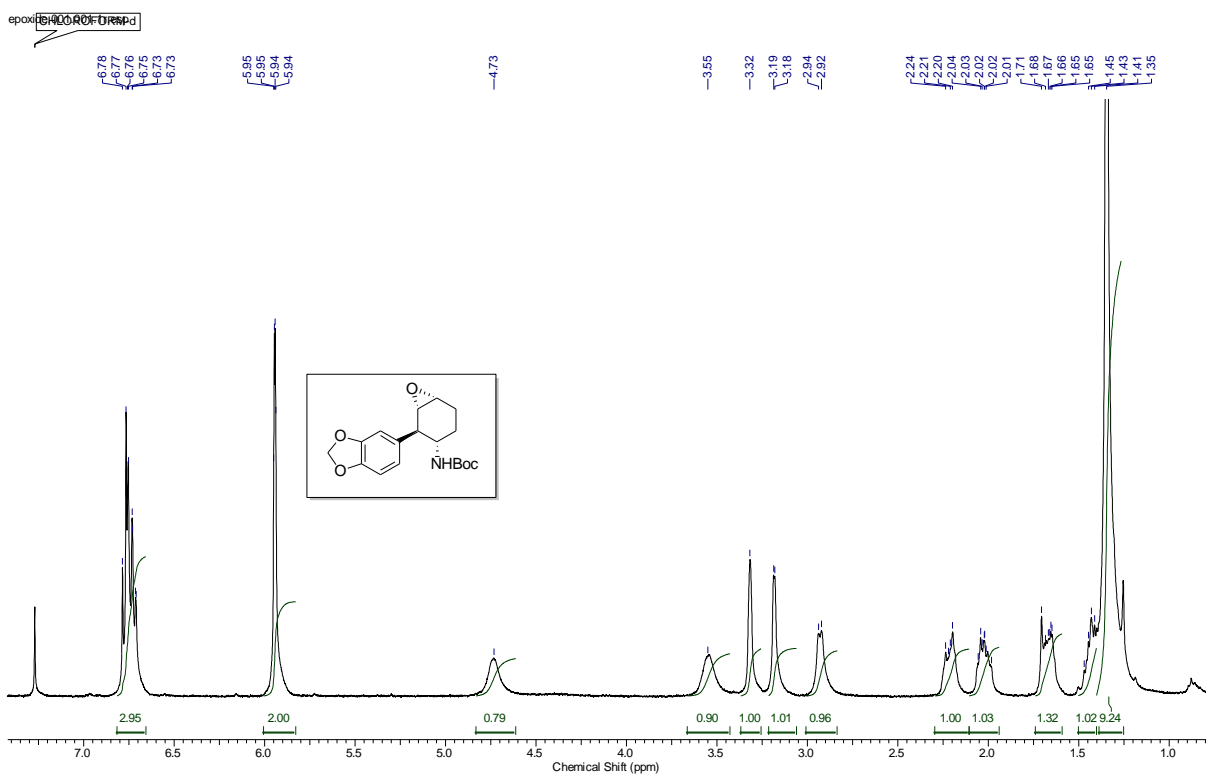

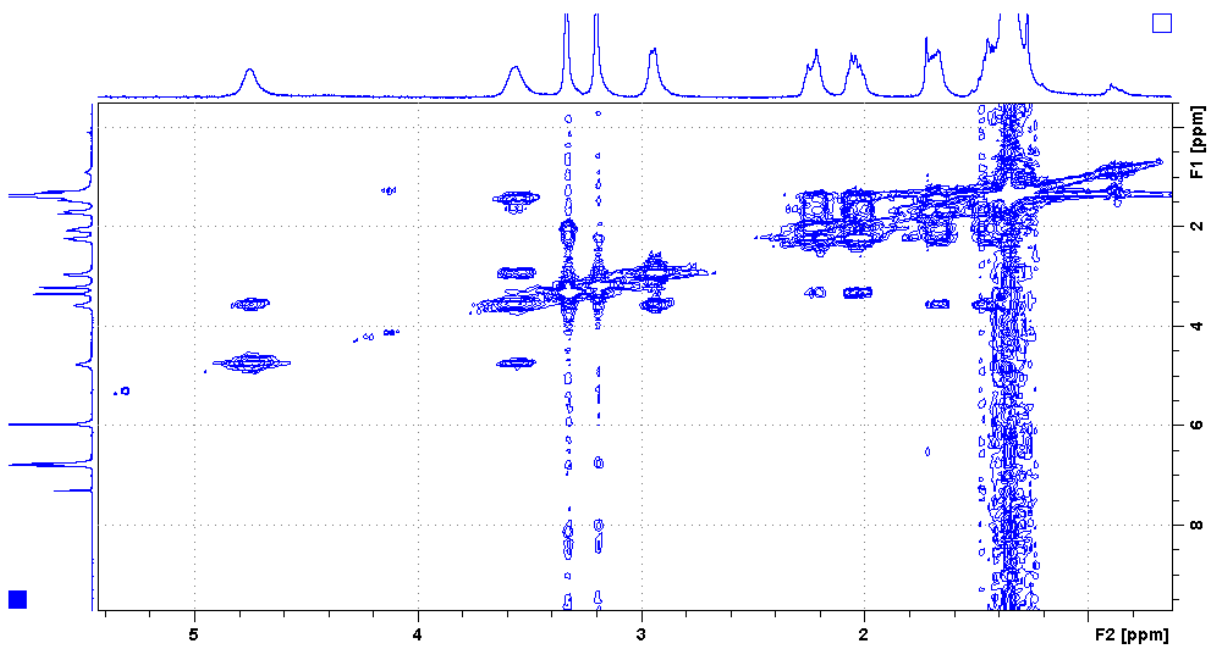

COSY 193

An epoxide open with PhSe 03 JUN2013.002.001.18

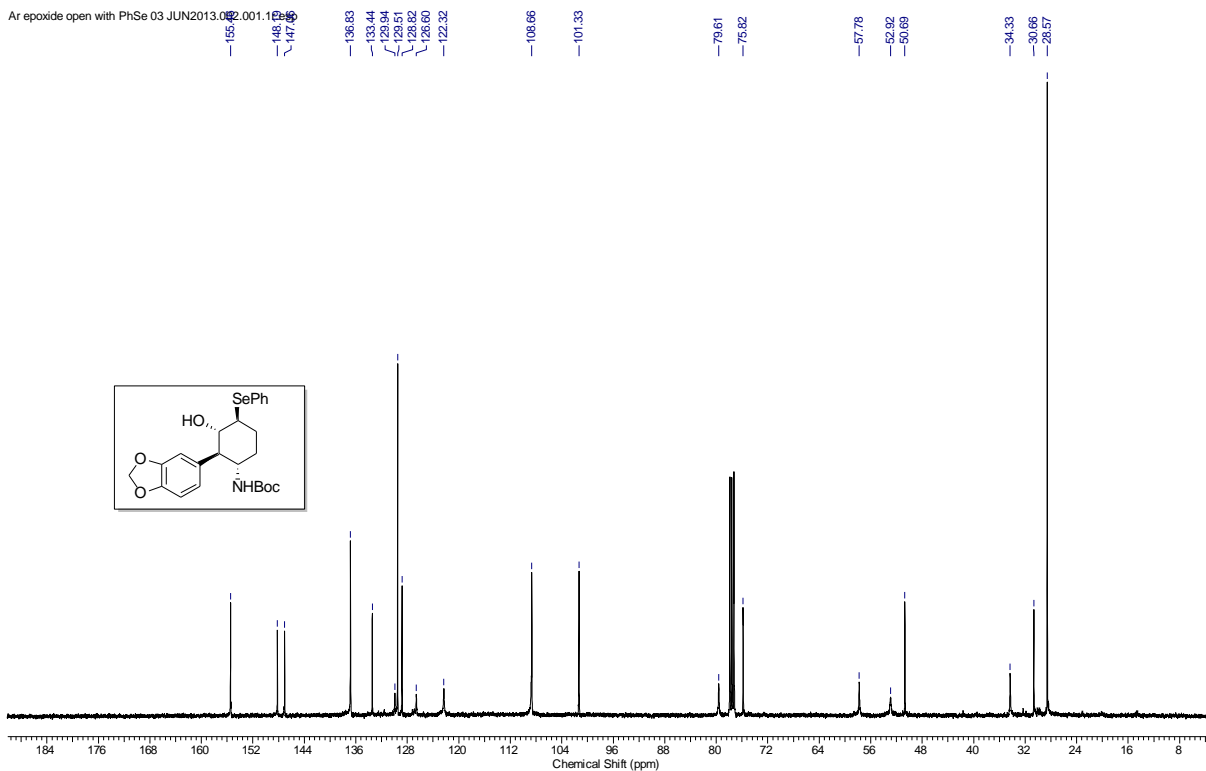

Ar epoxide open with PhSe 03 JUN2013.003.001.1r.esp

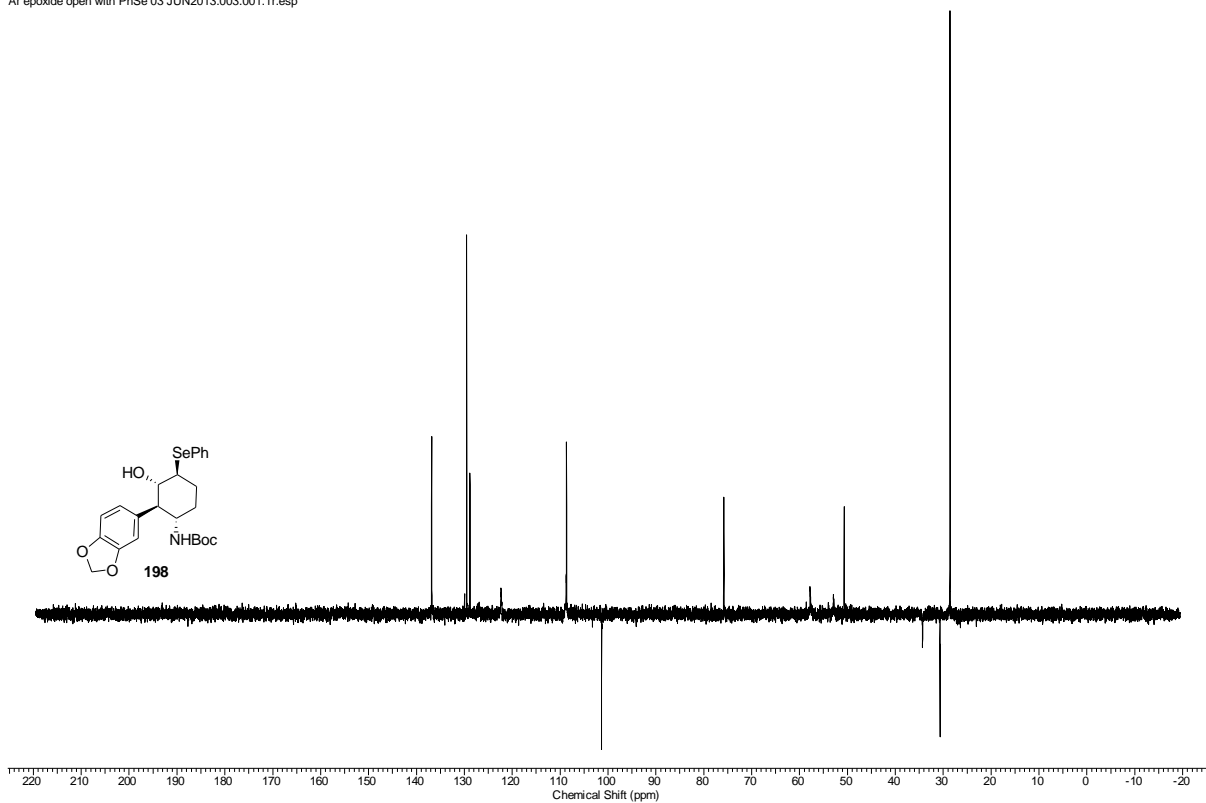

PhSe 03 JUN2013.003.001.1r.esp

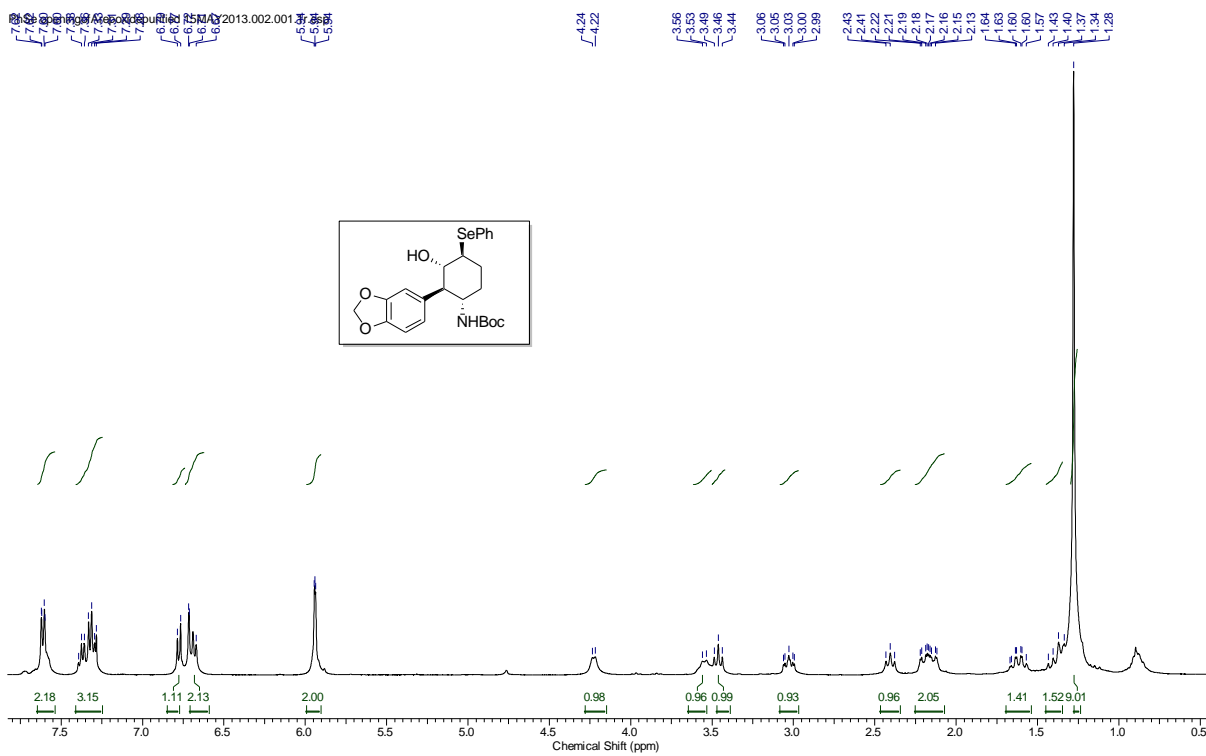

selenoxide elimination27may2013.005.001.1r.esp

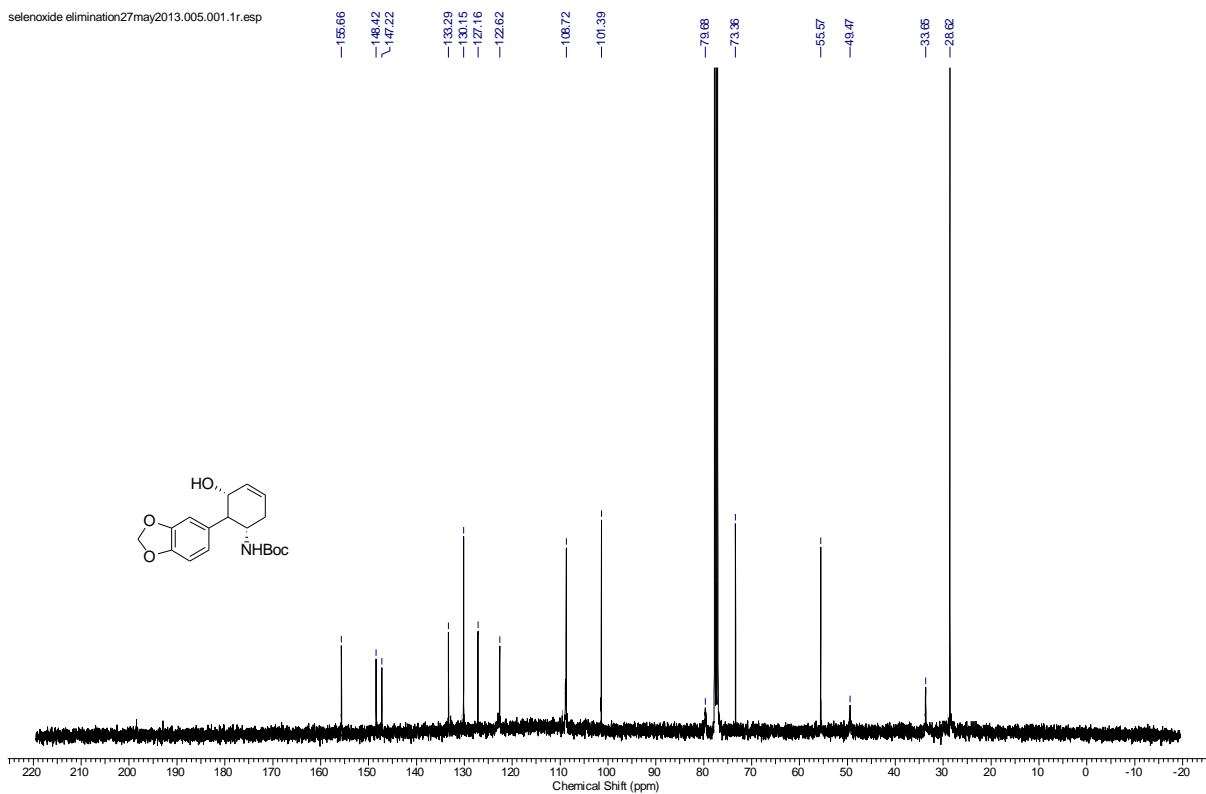

selenoxide elimination27may2013.005.001.1r.esp

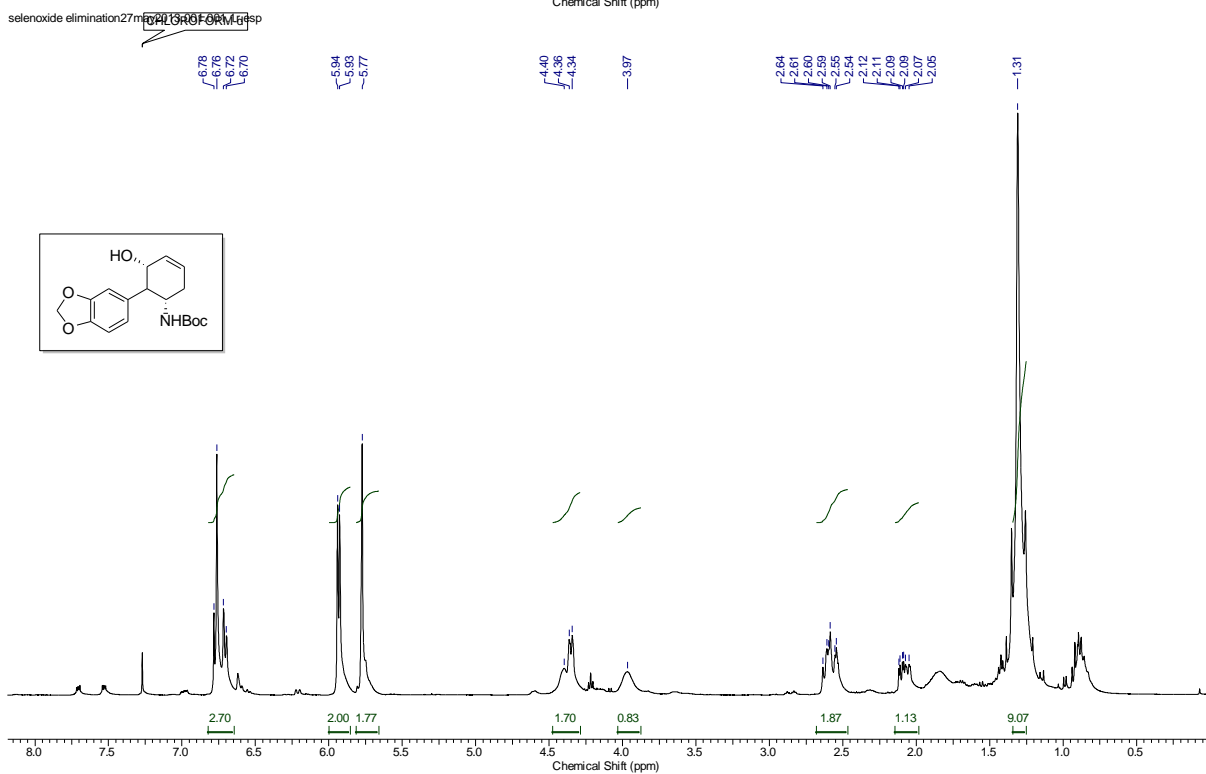

Chapter I: 7-azabicyclo [2.2.1] heptane skeleton and approaches towards....

Ar2ndepoxide15july2013.004.001.1r.esp

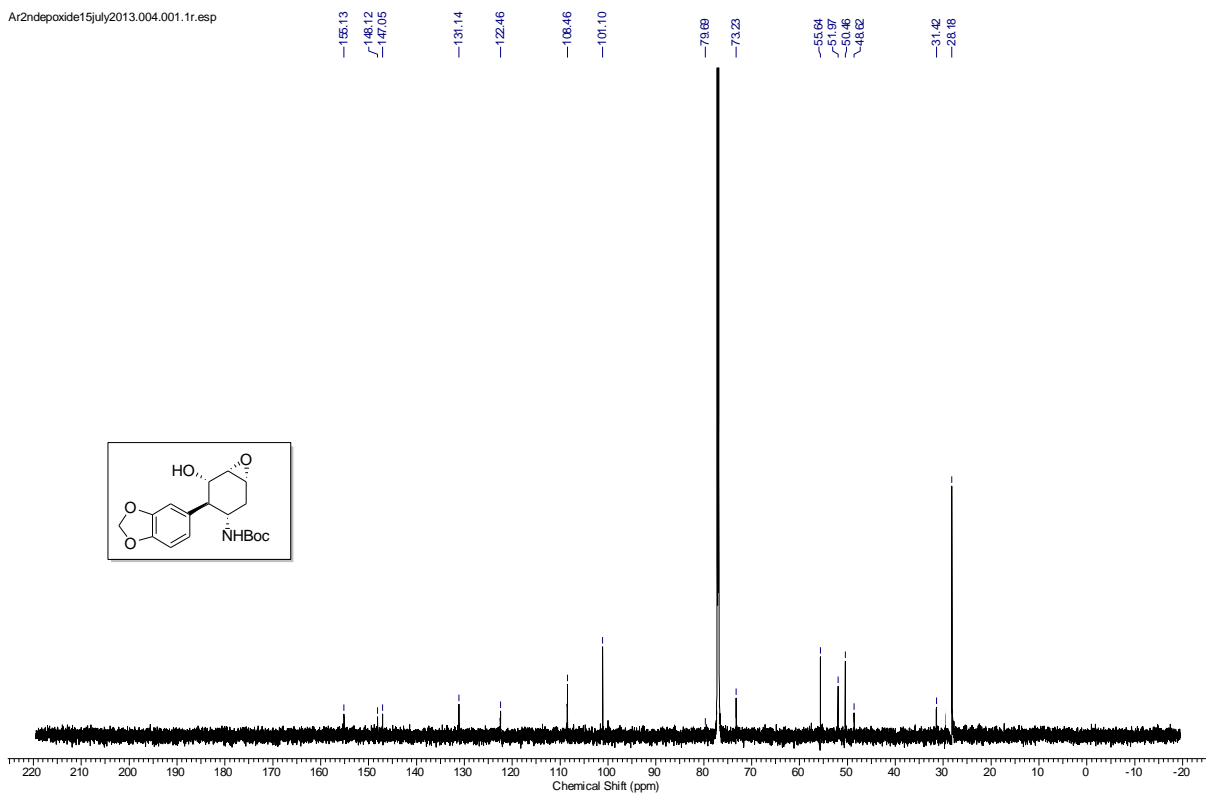

Ar2ndepoxide15july2013.001.001.1r.esp

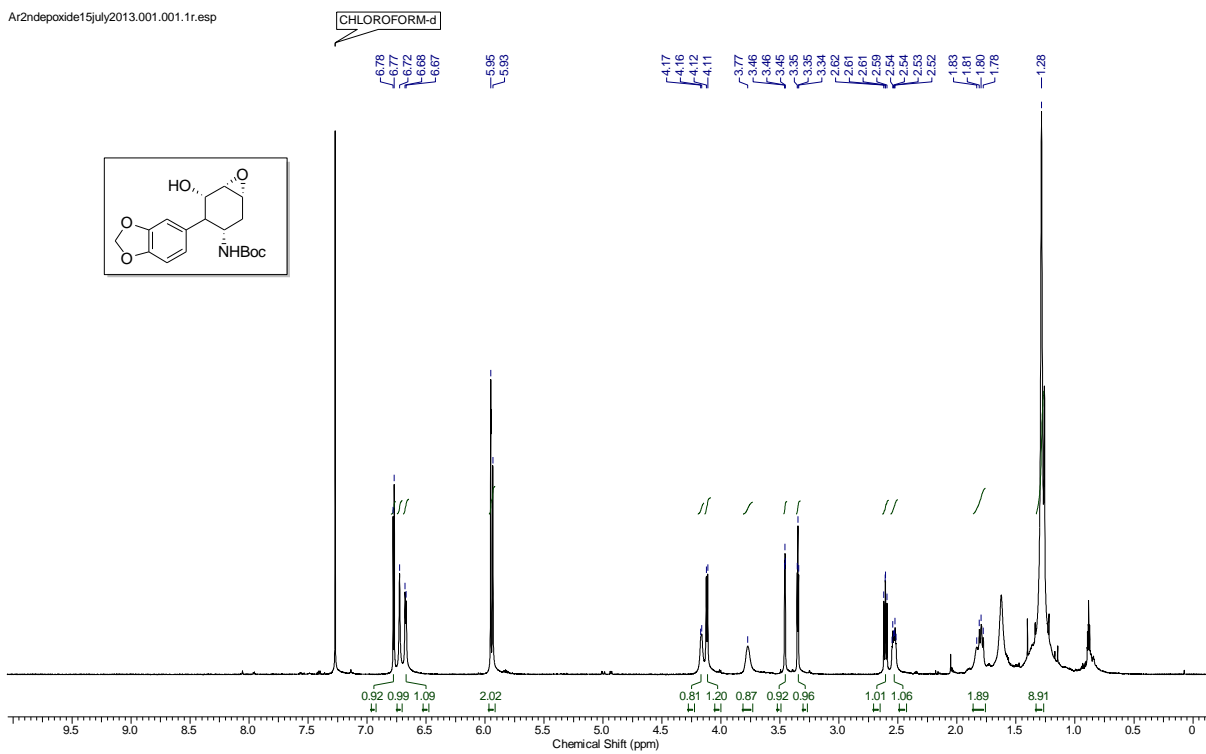

Ar2ndepoxide15july2013.002.001.2rr.esp

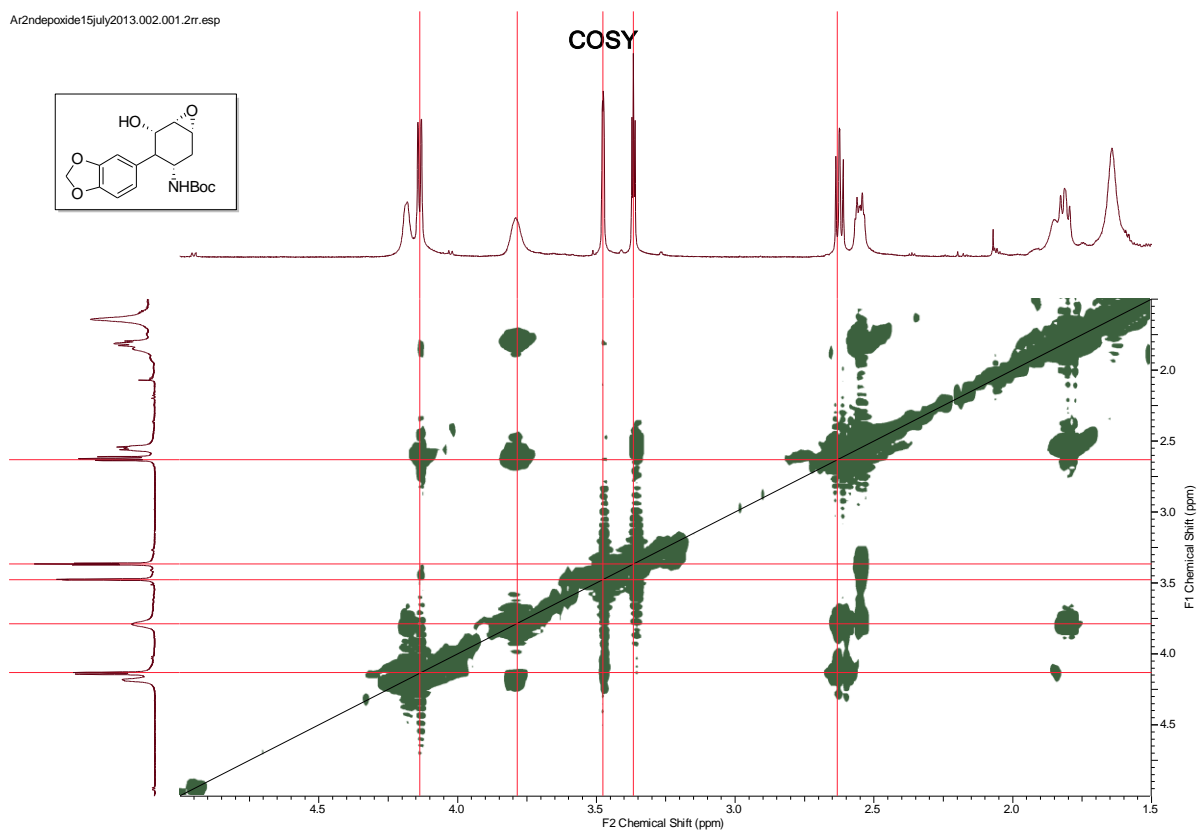

Ar2ndepoxide15july2013.001.001.1r.esp

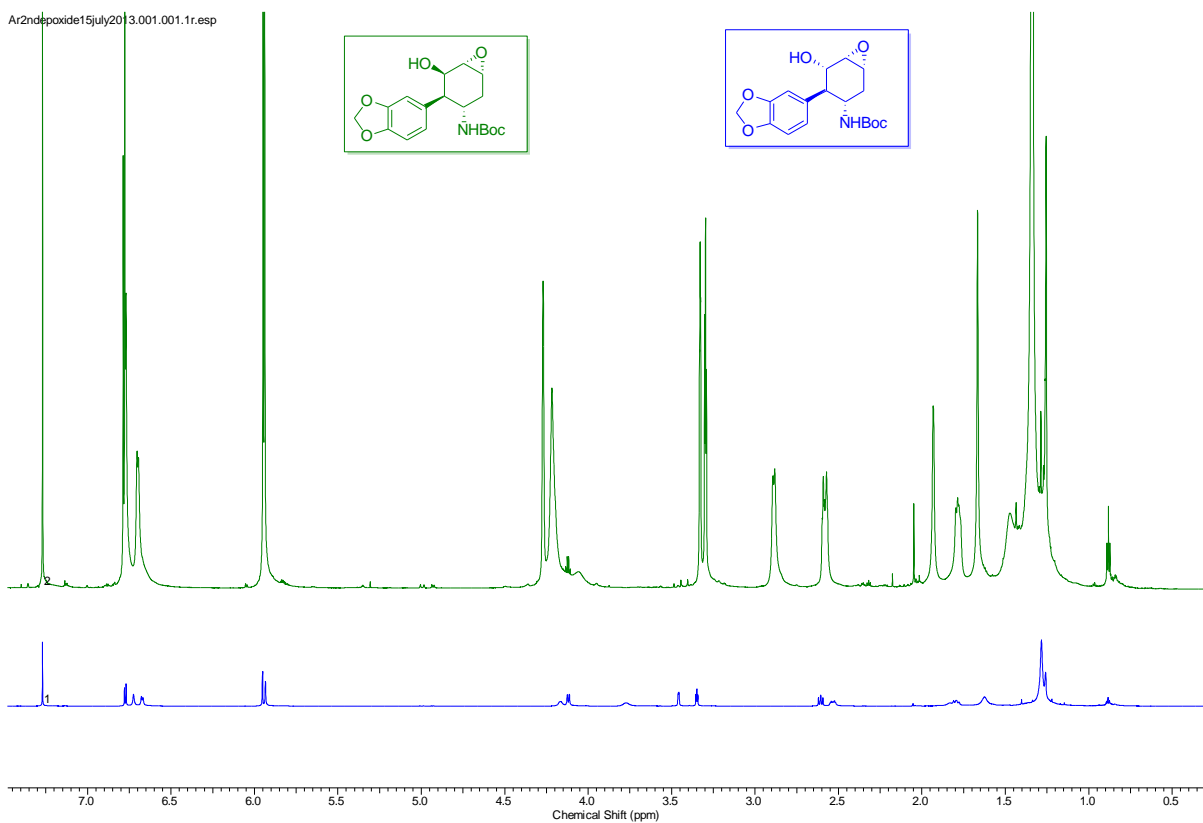

Ar-syn-hydroxyepoxide24july2013.001.001.1r.esp

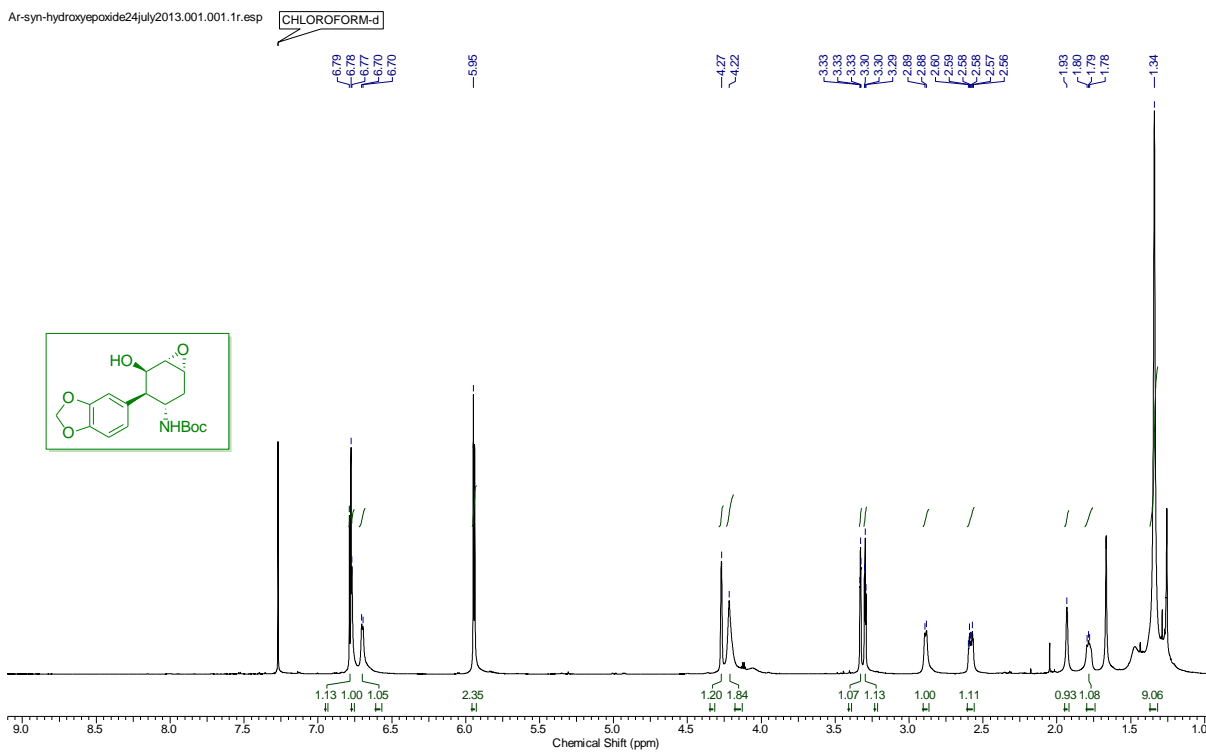

Ar-syn-hydroxyepoxide24july2013.002.001.1r.esp

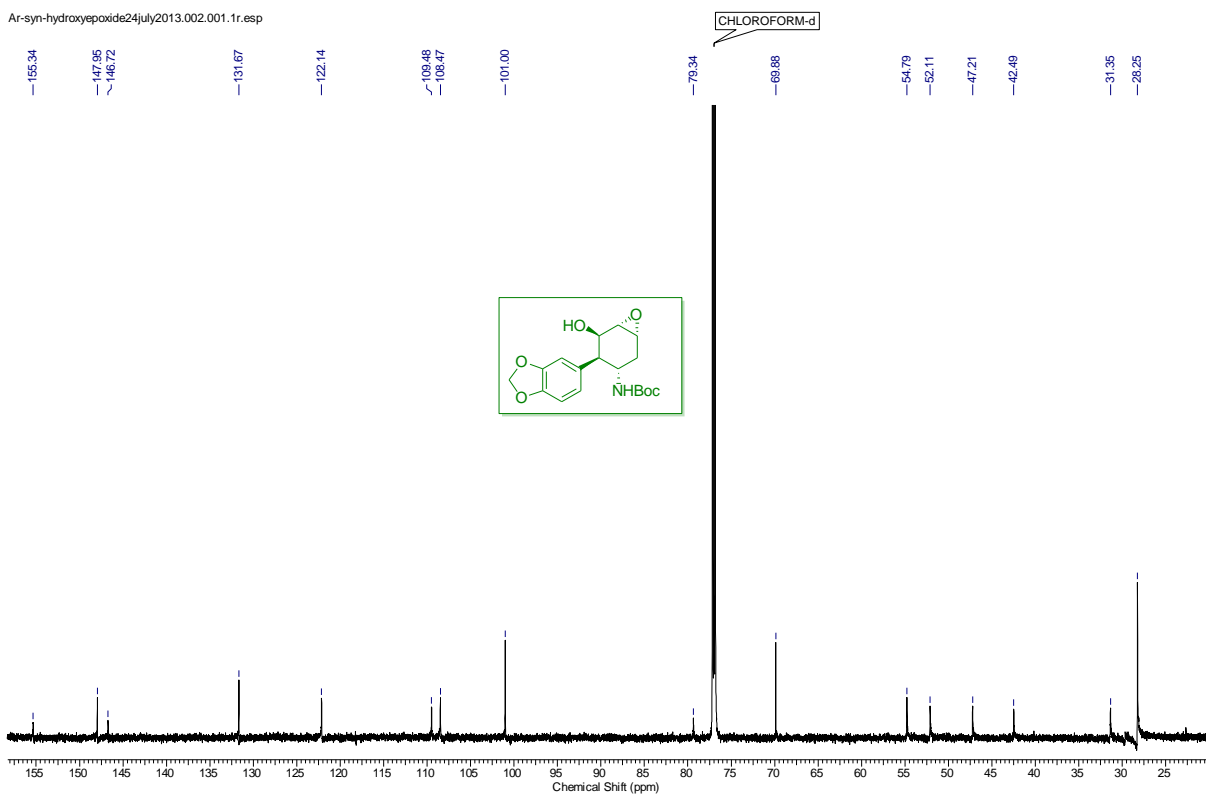

Ar-syn-hydroxyepoxide24july2013.003.001.1r.esp

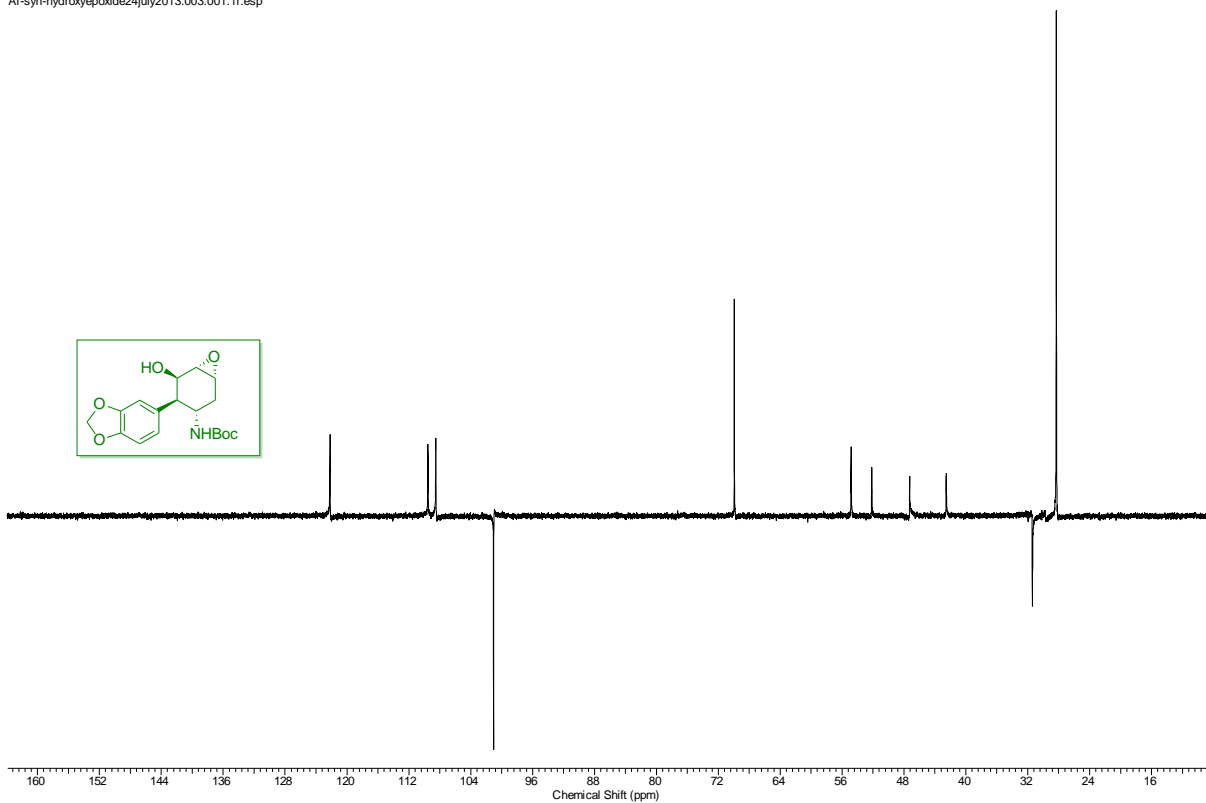

Ar-syn-hydroxyepoxide24july2013.003.001.1r.esp

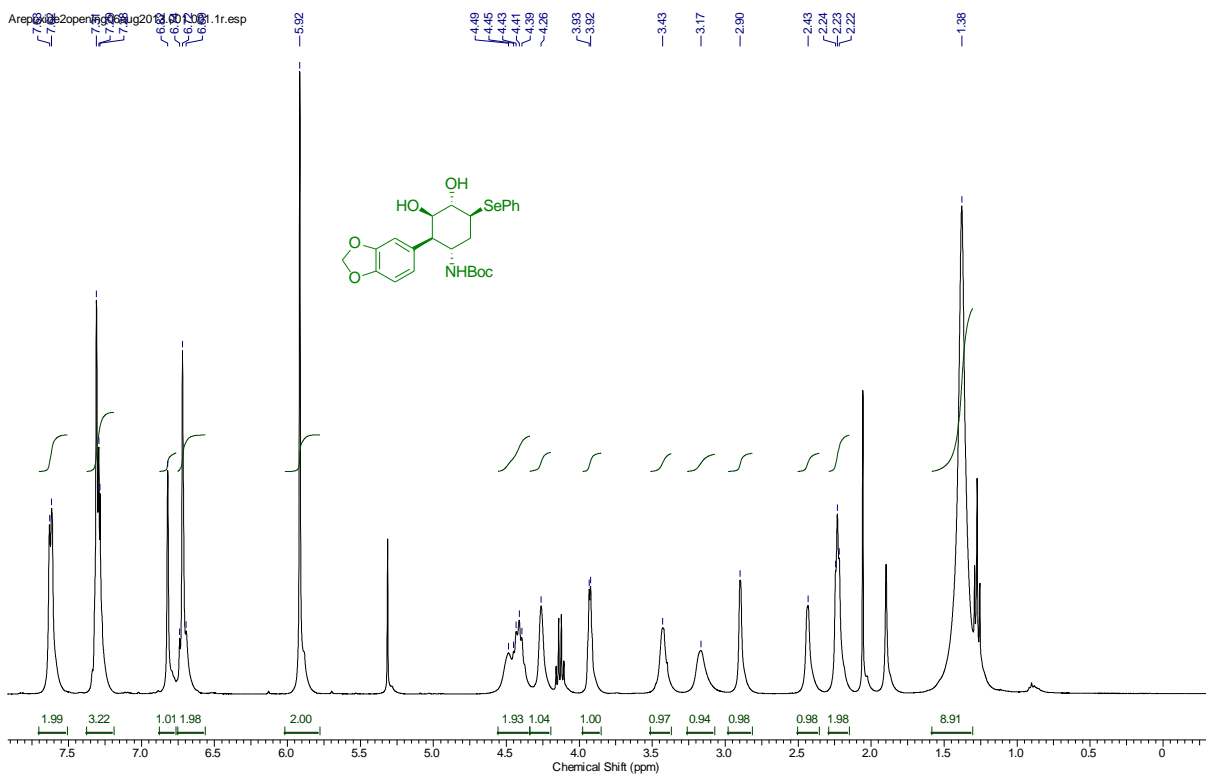

Arepoxide2opening06aug2013.003.001.1r.esp

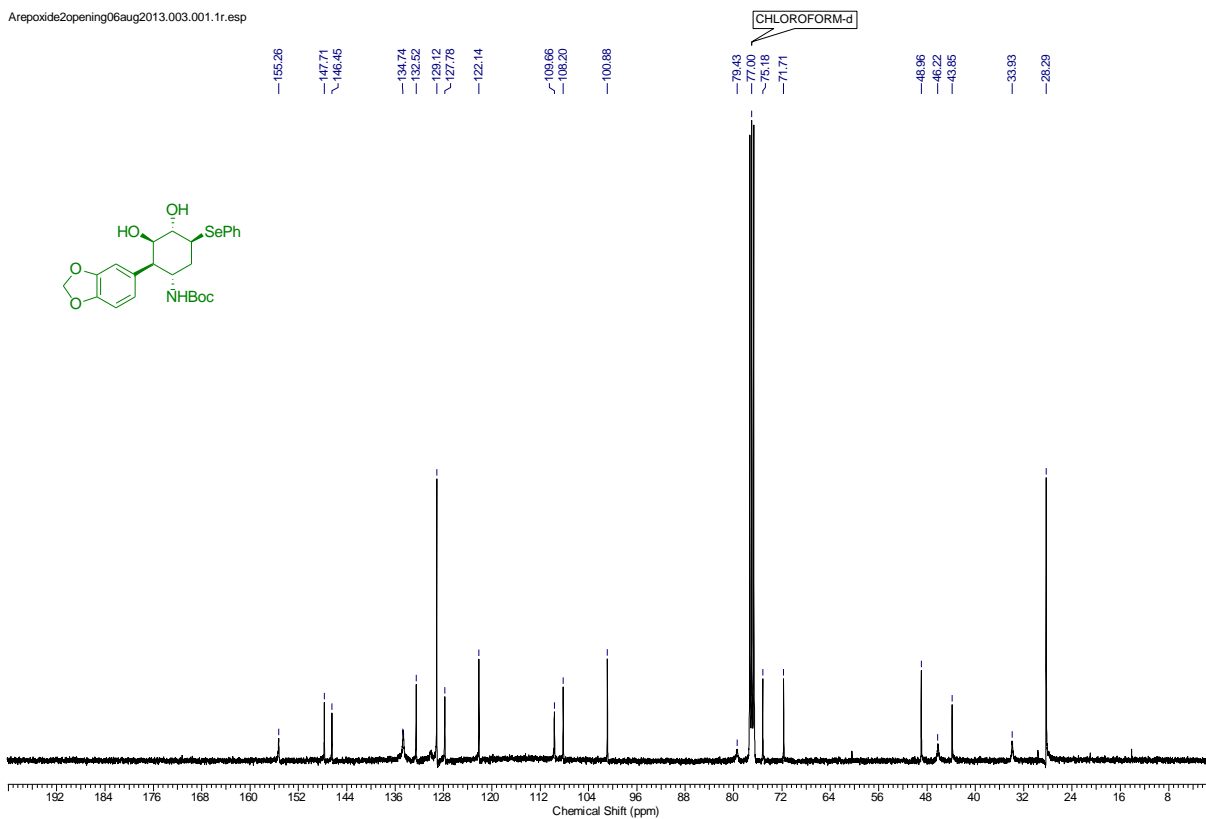

Arepoxide2opening06aug2013.004.001.1r.esp

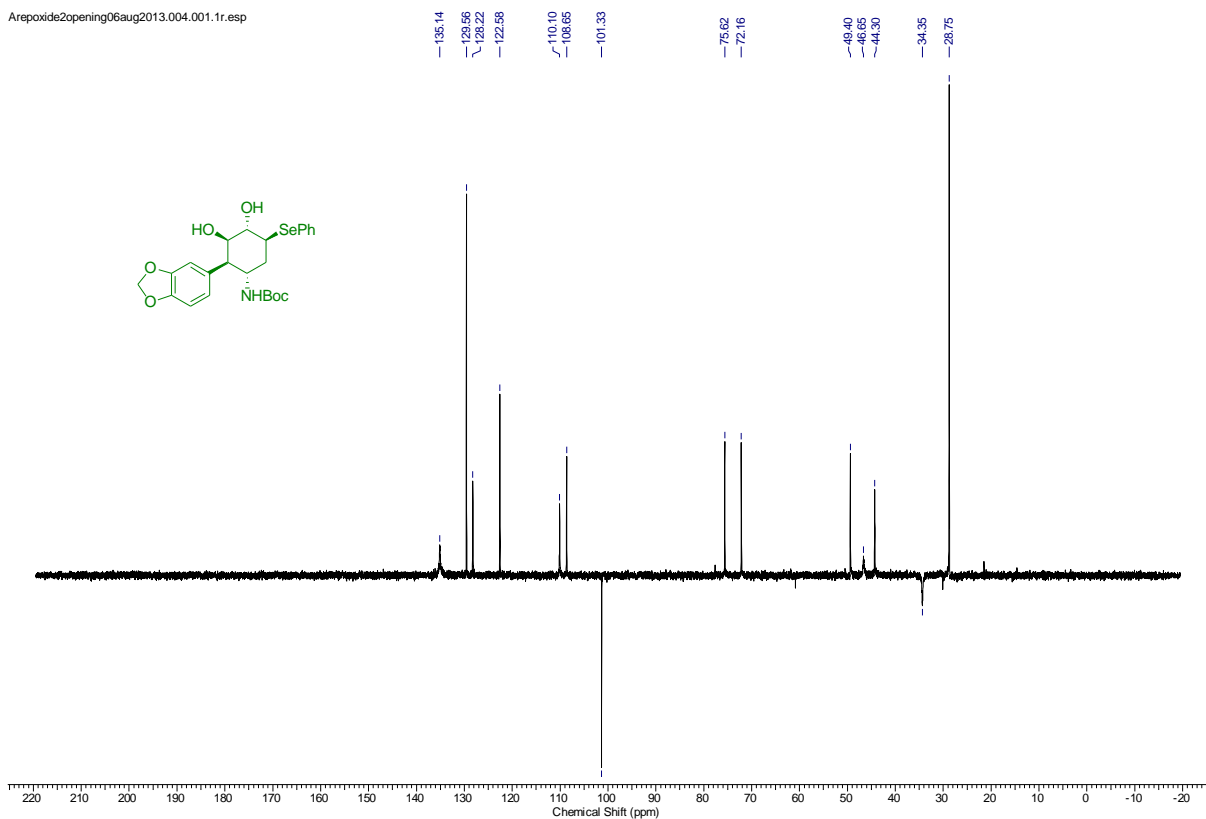

Ardihydroxylation06aug2013.001.001.1r.esp

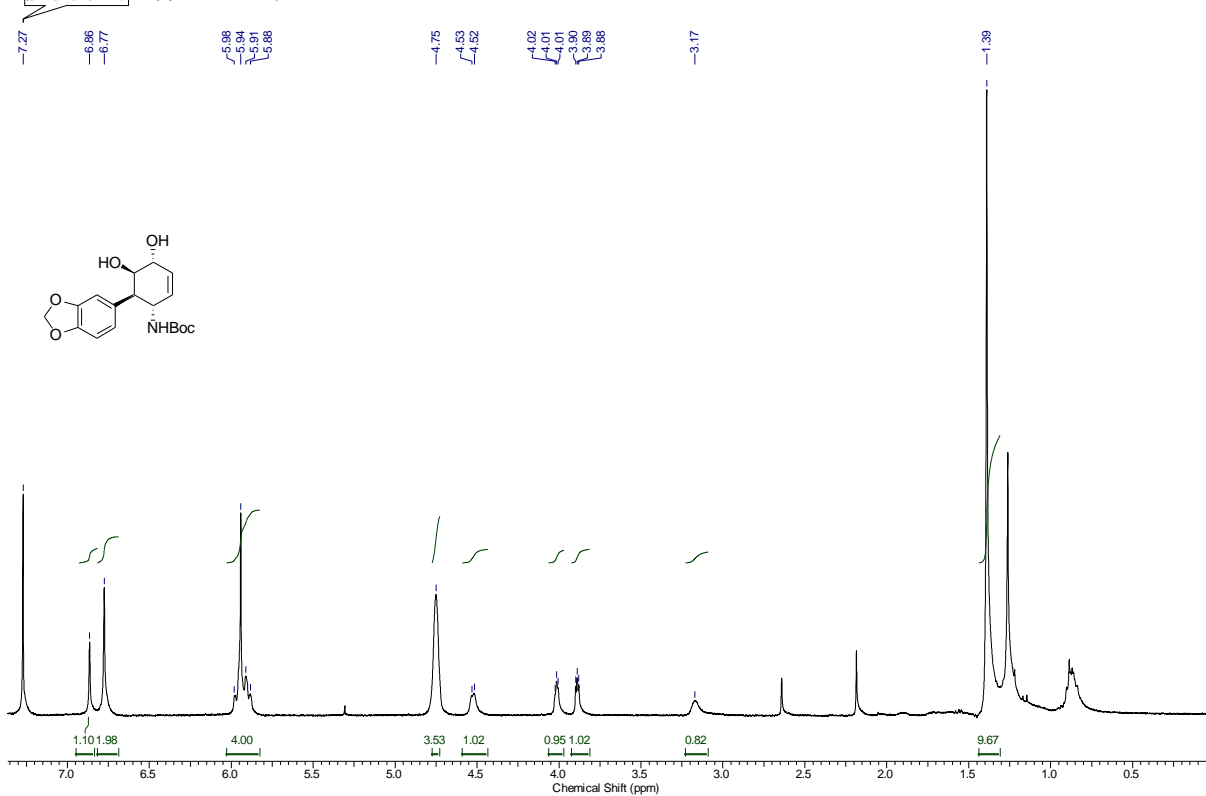

Ardihydroxylation06aug2013.001.001.1r.esp

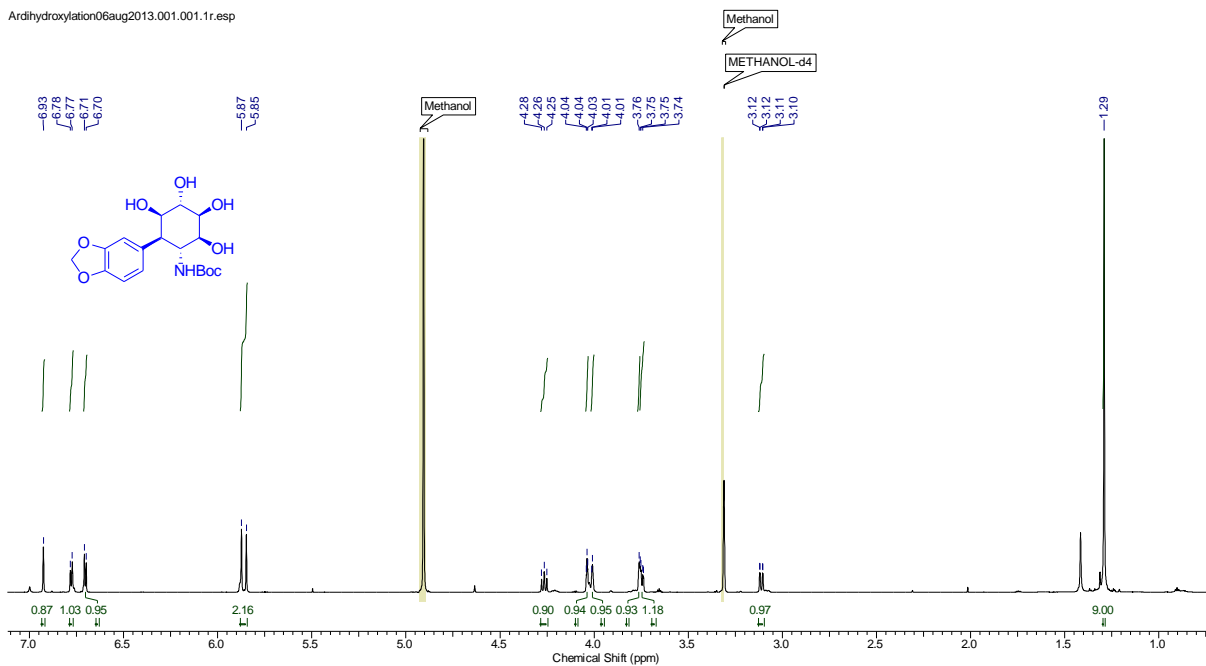

Ardihydroxylation06aug2013.002.001.1r.esp

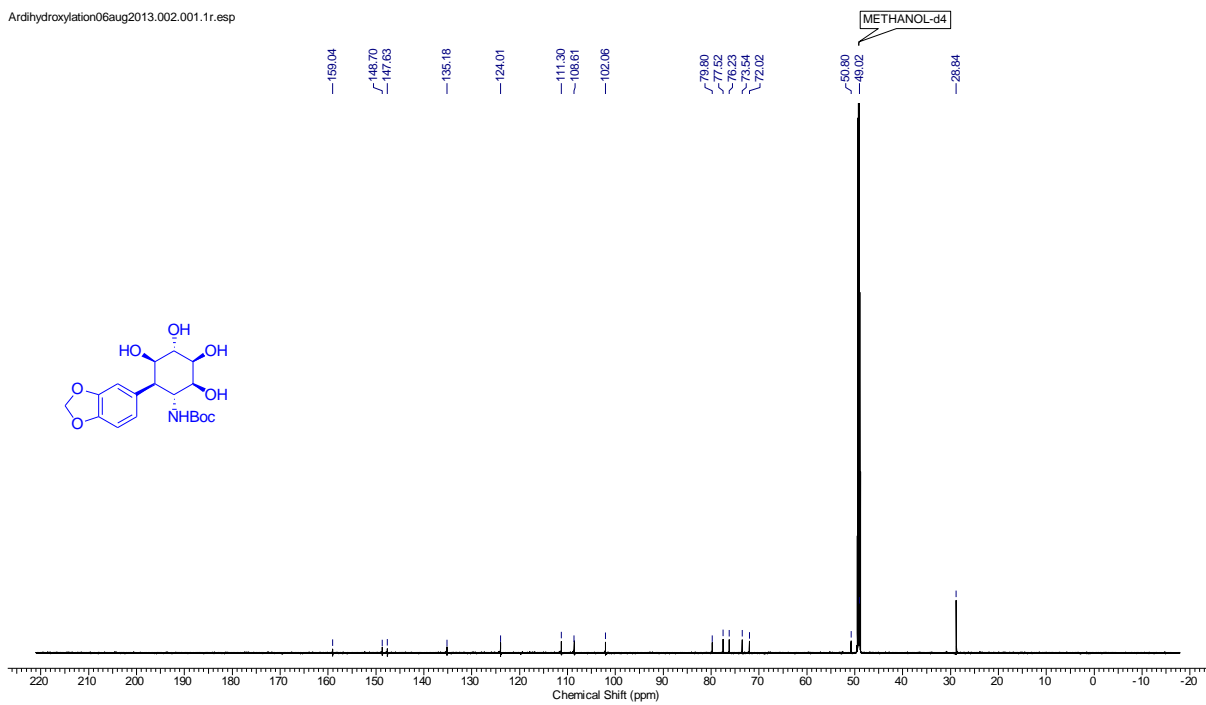

Ardihydroxylation06aug2013.003.001.1r.esp

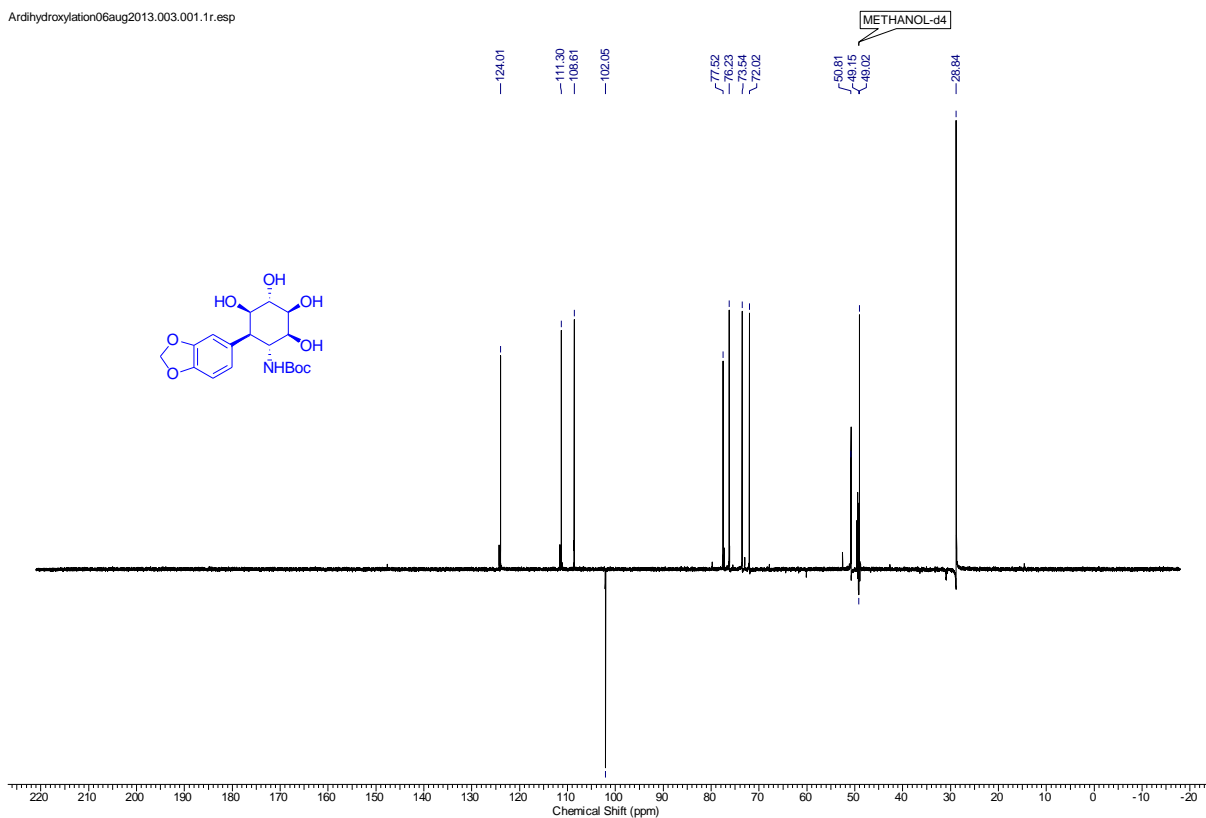

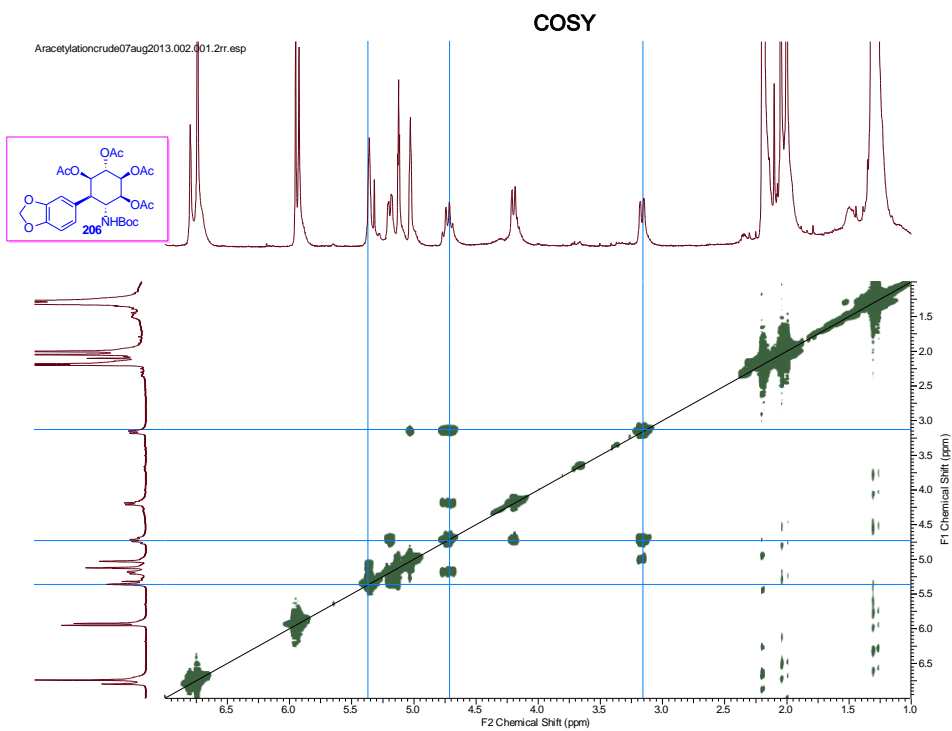
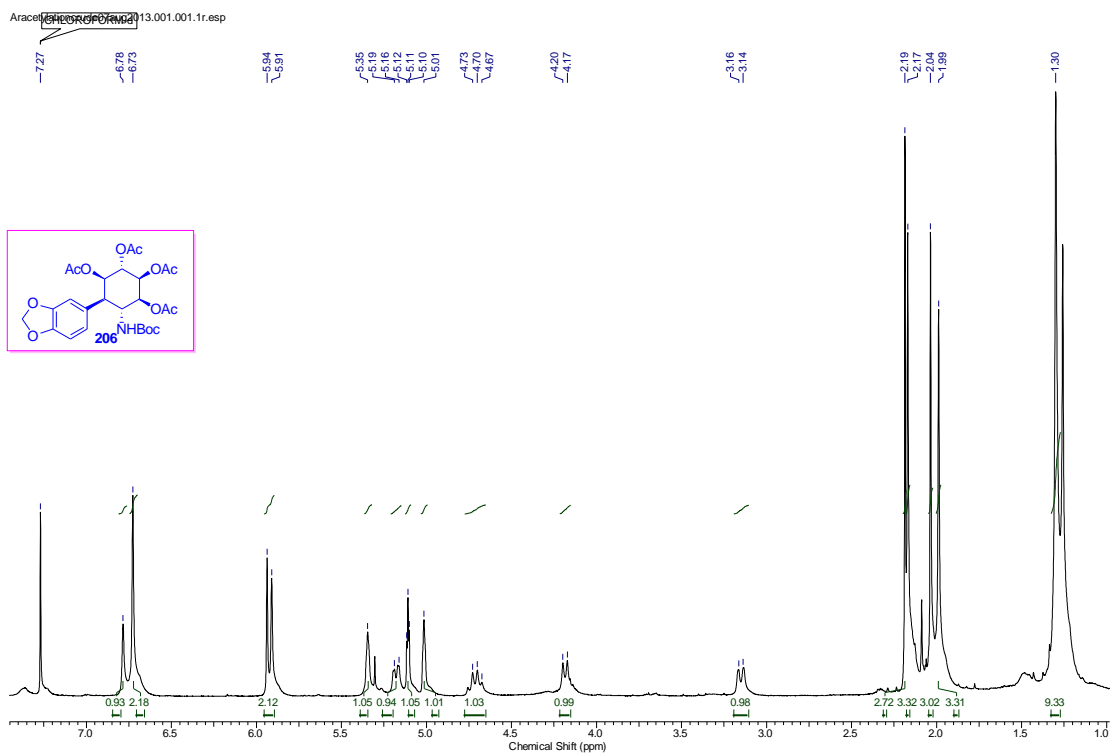

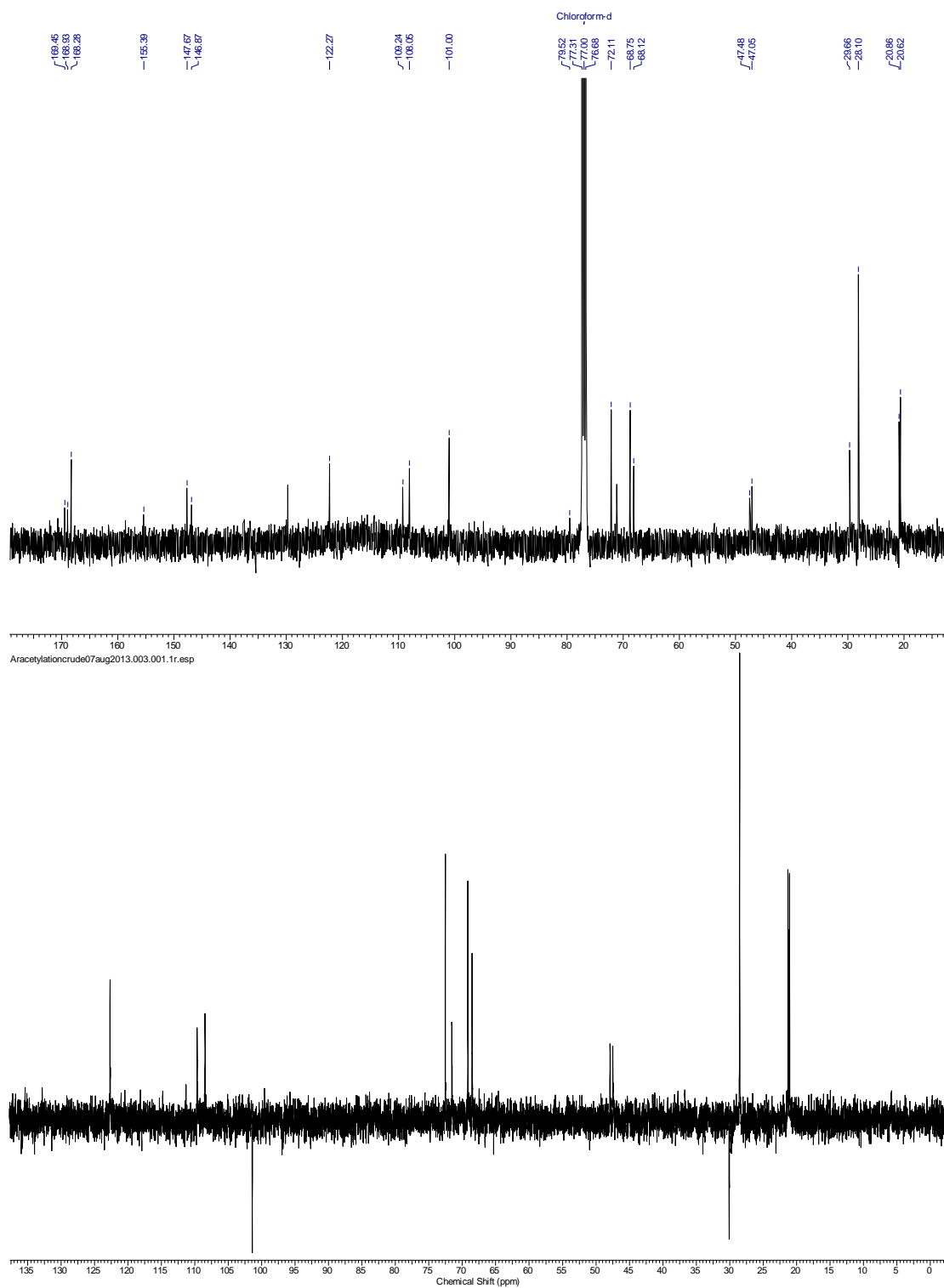

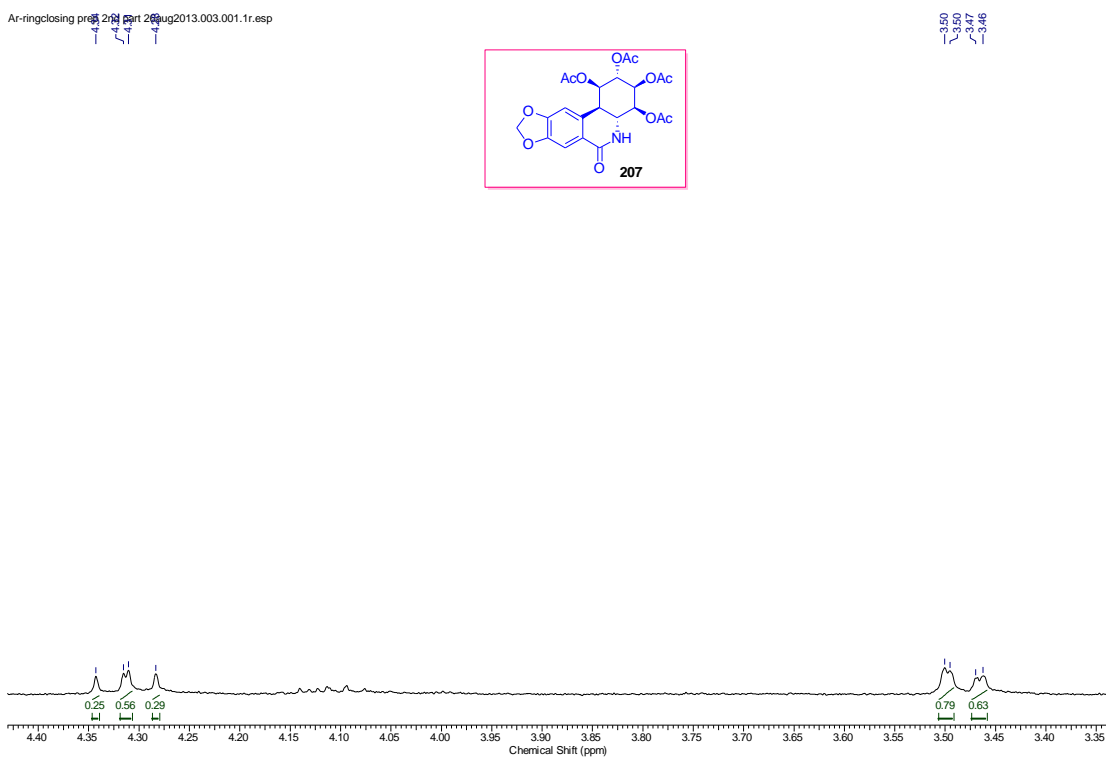
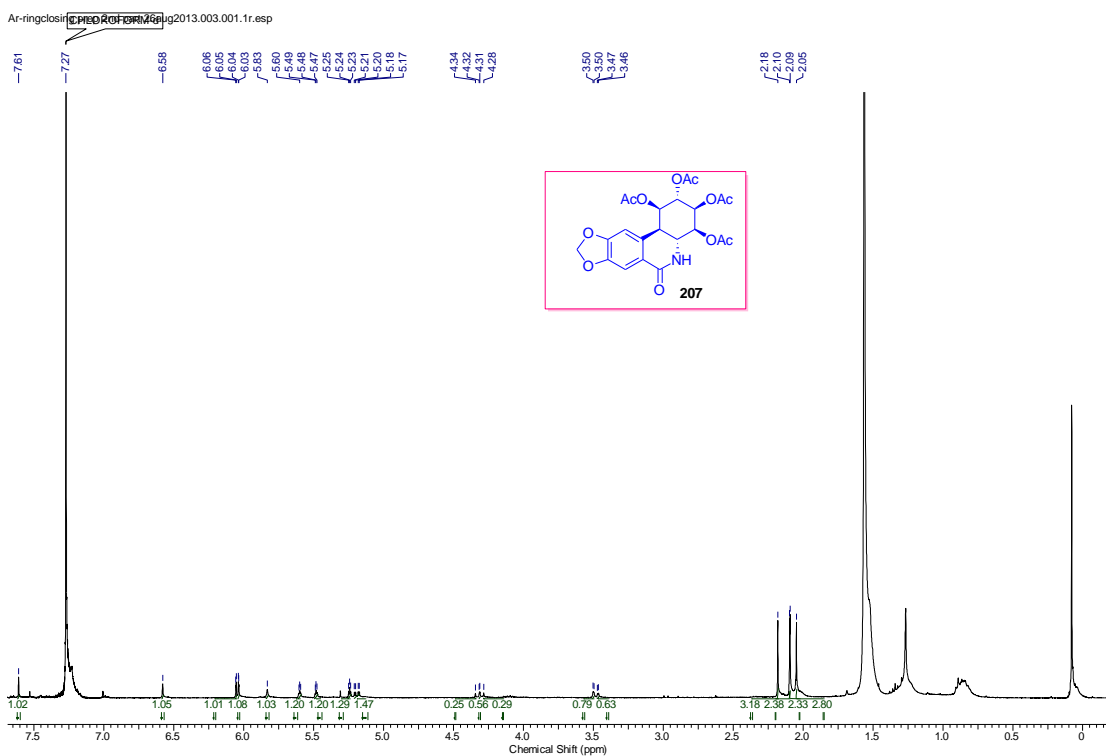

Ar-ringclosing prep 2nd part 26au429303.001.1r.esp

6.05
6.04
6.03

5.83

5.61
5.60
5.59

5.49
5.48
5.47

5.25
5.24
5.23
5.21
5.20
5.18
5.17

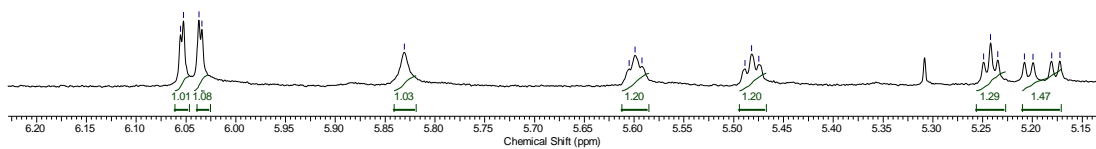
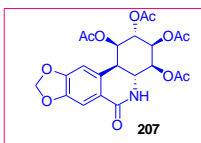

CHAPTER 2

SYNTHESIS OF *EXO*-7-AZABICYCLO[2.2.1]HEPTAN-2-AMINE AND *CIS* 1,2 DIAMINO CYCLOHEXE

2.1a. Introduction

1, 2-Diamines are important scaffolds in organic chemistry. These diamines are routinely used as ligands^[1a-e] in metal-catalysed asymmetric organic transformations. For example, 1,2-diamines are extensively used in the synthesis of thiourea based organocatalysts,^[2a-b] for many useful synthetic transformations. More importantly 1,2-diamines are also found in great abundance in large number of naturally occurring molecules^[3] which have great potential in therapeutic use.

In particular, cyclohexane-1, 2-diamines constitute altogether a distinct sub-class. These classes of compounds have diverse application in many areas of organic chemistry. For example, C₂-symmetric *trans*-1, 2-diaminocyclohexanes (**5**) have been used as ligands^[1c-e] in metal-catalyzed asymmetric reactions and several important organocatalysts^[4a-m] are based on this structural frameworks. On the other hand, *cis*-1, 2-diaminocyclohexanes (**6**) have shown great promise as therapeutic agents in medicinal chemistry.^[5a-l] More recently Maruoka,s group have shown utility of *cis*-cyclohexyldiamine derivatives as an excellent pseudo-enantiomeric organocatalysts. This catalyst produced both enantiomers of product by just simple manipulations of protecting group.^[6a-b] Traditionally, *trans*-diamine is obtained by resolution of its racemate either by using suitable chiral reagents or specific enzymes^[7a-b] whereas corresponding *cis*-diamine is obtained either from *trans*-1, 2-diaminocyclohexanol through multistep functional group manipulations^[5b, 5i, 5k]. There are few other methods also to access *cis*-cyclohexyldiamines such as acrylate cycloaddition with butadiene using D-pantolactone as a chiral auxiliary^[8a-b] employing long reaction sequences and by desymmetrization of corresponding *meso*-vicinal cyclohexanediamine.^[9a-b] Considering the importance of 1, 2-diamines in general and 1, 2-diaminocyclohexanes in particular, we visualized conformationally rigid 7-aza bicyclo[2.2.1]heptane-2-amines (**3**, **4**) as an ideal precursor for the synthesis of 1, 2-diaminocyclohexanes.

2.1b. Origin of the Concept:

This idea originated from our ongoing exploitation of **2** in the synthesis of a variety of natural products/ scaffolds^[10-11] and the presence of C3-phenylsulfonyl moiety as a handle to trigger C4-N7 bond cleavage. We have used **2** as a template in the syntheses of many important natural / synthetically useful compounds. Therefore, it occurred to us that *exo*- as well as *endo*-alcohols obtained by the reduction of **2** under specific reaction condition can be forced to undergo nucleophilic substitution in S_N2 fashion if we can convert the hydroxy group to a suitable potential leaving group. In this manner, we could have access to both *exo*- and *endo*-bicyclic diamine which after anionic rearrangement (C4-N7 cleavage) will produce *cis*- as well as *trans*-1,2 diamines in optically pure form. To test our hypothesis, we began synthesising bicyclic alcohols **7** and **8** as the first step.

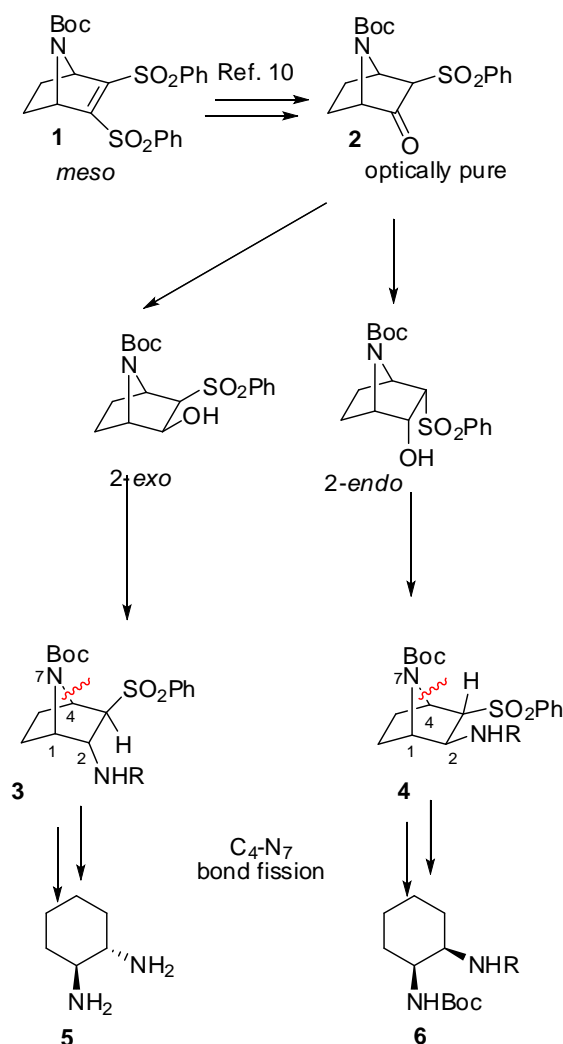

Scheme 1. Proposed planning for the synthesis of 1, 2-cyclohexane diamines.

2.1c. Results and Discussion:

The bicyclic alcohols (**7** and **8**) were obtained by reduction of enantiomerically pure **2** with LiBH₄ under different reaction conditions. Reduction in THF at ambient temperature produced mixture of **7** and **8** (9:1) which were easily separable by simple column chromatography. However, reduction at -78°C reversed the ratio (7:8, 3:7). The ratio of the desired alcohol can further be improved by oxidising the undesired alcohol using IBX followed by reducing again with LiBH₄. This process can be used to obtain any one of these alcohols in >90% yield after two cycle of oxidation/reduction processes.

The corresponding mesylates were obtained by reacting either **7** or **8** with mesylchloride in pyridine at rt. These mesylates (**9** and **10**) were found to be very stable solid (m. p. **9**: 172.4°C-174.9°C, **10**: 177.3°C-181.6°C). The presence of three mesyl group protons at δ 3.18 (s, 3H) in ¹H NMR and the methyl carbon at δ 37.6 in ¹³C NMR confirmed the formation of **9**. Molecular ion peak at m/z 449.1411 in HRMS (ESI) {cal. m/z 449.1411[C₁₈H₂₉N₂O₇S₂ ([M+NH₄]⁺)]} also supported the formation of **9**.

The *endo*-**10** was similarly characterised by observing three methyl protons of mesyl group at δ 3.20 (s, 3H) and the methyl carbon at δ 38.8, by ¹H NMR and ¹³C NMR, respectively.

After accumulating **9** and **10** in appreciable amount, we attempted nucleophilic substitution of these mesylates by different amines. Initially, refluxing **9** with allylamine for 30 min. surprisingly produced **11a** in 95% yield. Identical reaction with **10** also gave the same **11a**. To probe further this unexpected result, mixture of both **9** and **10** were refluxed with allylamine which produced **11a** exclusively. Reaction with acetamide and pyrrolidine too gave only corresponding **11b** and **11c**, respectively. The relative stereochemistry of the products were confirmed using detailed NMR studies. For illustration, in the ¹H NMR spectrum of **11b**, the characteristics H₁, H₂, H₃ and H₄ protons were assigned to δ 4.09 (d, J = 5.3Hz, 1H, H₁), δ 4.63 - 4.52 (m, 2H, H₂&H₄) and δ 3.25 (t, J = 3.8Hz, 1H, H₃), respectively. In COSY spectrum correlation between H₄-H₃-H₂ were visible indicating H₃ to be in

exo-orientation. Similarly absence of correlation between H₁ and H₂ suggested H₂ to be in an *endo* orientation since it also correlated with H₃ and N-H proton. These observations were in complete agreement with the literature reports where couplings are seen between bridge head proton and *exo* proton^[10, 11, 19]. The *endo* proton never couples with the bridge head protons in bicyclo[2.2.1] heptane skeleton. The NOESY also confirms the same structural postulation.

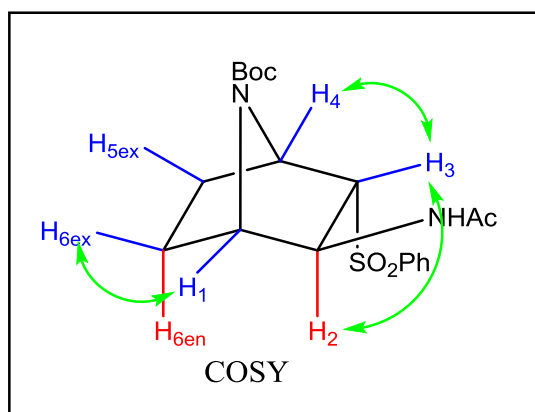

The molecular ion peak at m/z 395.1632 by HRMS (ESI) analysis was found in good agreement with the calculated value { m/z 395.1635 C₁₉H₂₇N₂O₅S ([M+H]⁺) }

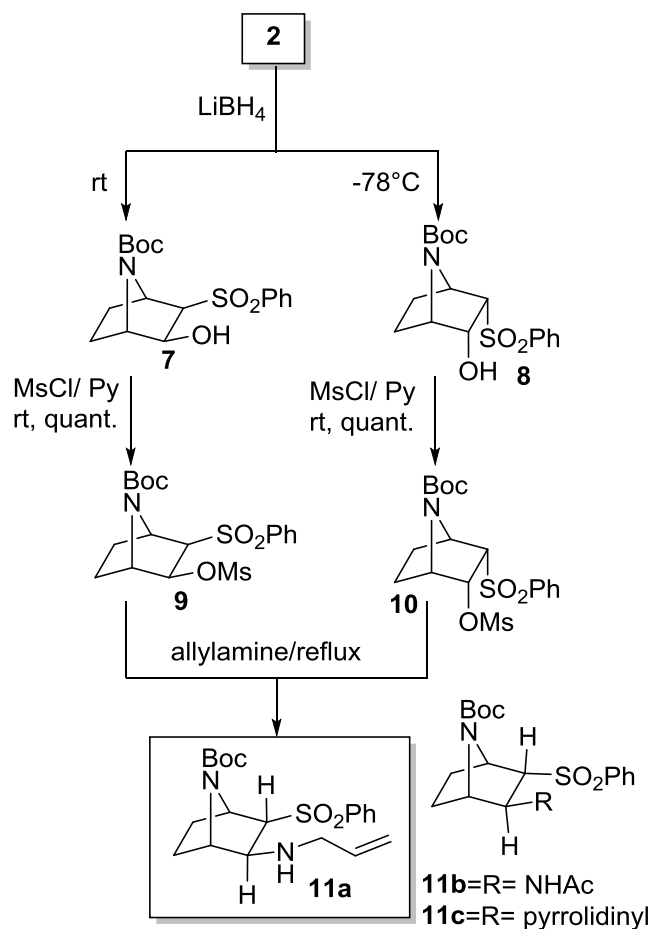
Scheme 2. Preparation of *exo*-7-azabicyclo[2.2.1] heptadiamines

Based on this stereochemical revelation, the possibility of S_N2 type displacement can, thus, be ruled out as in all these reactions the nucleophile positions itself to an *exo*-orientation. Furthermore, the possibility of a unimolecular S_N1 type reaction would be energetically uphill owing to the presence of α -phenylsulfone moiety. Therefore, it was postulated that this reaction might be proceeding by an elimination/addition (E1cB type) mechanism. The driving force for the elimination of mesyl group might be the formation of **12** on which *exo*-attack by the amines is a highly reasonable proposition. To confirm the involvement of **12** as an intermediate, both **9** and **10** were stirred with DBU in DCM at r.t. for 1h and resultant **12** was heated with allylamine to obtain **11a** exclusively.

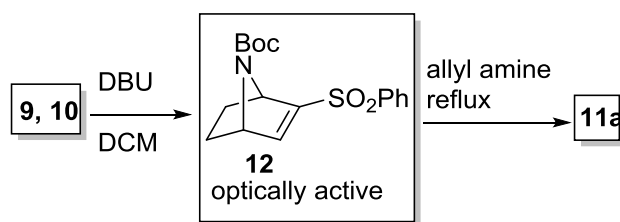

Scheme 3. Support of 12 as an intermediate in amination reaction

To effect C4-N7 cleavage, **11b** was stirred with 4.0 equiv. of MeMgBr (1.4 M solution) in THF at room temperature for 1 h and usual work up followed by crystallization gave **13b** in 80% yield (m.p. >240°C, decomposes). The presence of β proton (H-4) at δ 7.32 (t, $J = 3.6\text{Hz}$, 1H) along with five proton of phenyl sulfonyl group at δ 7.92 - 7.79 (m, 2H), 7.70 - 7.50 (m, 3H) in ^1H NMR spectrum confirmed the formation of **13b**. Further confirmation to this structure was indicated by observing molecular ion peak in HRMS at m/z 395.1632; calculated value 395.1635 for $\text{C}_{19}\text{H}_{27}\text{N}_2\text{O}_5\text{S}$ ($[\text{M}+\text{H}]^+$).

Removal of the phenylsulfonyl moiety by refluxing with Raney-Ni in absolute ethanol gave **14** ($[\alpha]_D^{27} -5$ {c 1, chloroform}) quantitatively. Presence of H₂ and H₁ at δ 3.94 (b s, 1H) and 3.81 (b s, 1H), respectively, together with two N-H protons at δ 6.42 (b s, 1H) and δ 5.01 (b s, 1H) indicated the formation of **14**. Further support to the proposed structure of **14**, was obtained by observing the molecular ion peak at m/z 257.1853. in HRMS(ESI); calculated for $\text{C}_{13}\text{H}_{25}\text{N}_2\text{O}_3$ ($[\text{M}+\text{H}]^+$) m/z 257.1860.

Scheme 4. Synthesis of 1, 2-cyclohexyl diamine

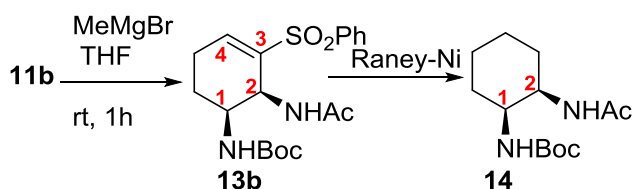

Apart from transforming **13b** to **14**, it was also transformed to **15** and **16** which are endowed with structural features required for further functionalizations by employing simple steps (Scheme-5). Reduction of **13b** using Na/Hg and Pd/C

produced **15** ($[\alpha]_D^{24}$ -31.1 {*c* 0.9, chloroform}) and **16**, respectively, in good yields. The olefinic bond of **15** could be utilised for further functionalization whereas the presence of the phenylsulphonyl group at C3 in **16** provided a handle for further transformation of this structural framework.

Scheme 5. Exploration of methodology for other cyclohexyldiamine analogues

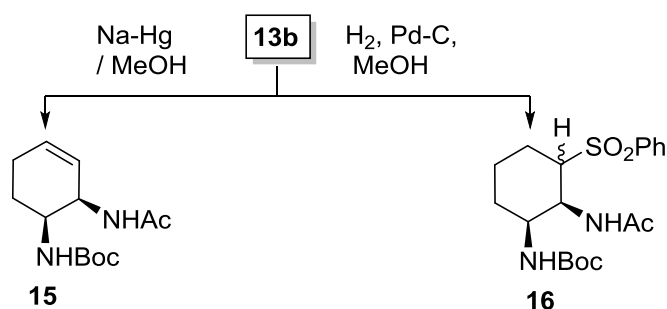

Since conformationally rigid diamines (CRDA) are well known compounds owing to their role in biology, catalysis, coordination and supramolecular chemistry,^[13] we got interested in synthesizing these molecules by broadening the scope of this reaction. Interestingly, *exo*- as well as *endo*-7-aza bicyclo[2.2.1]heptane-2-amines (**18** and **21**) are also known substructures of many pharmacologically important compounds. For example, N6-(*endo*-7-azabicyclo[2.2.1]heptan-2-yl)adenosines are shown to be highly potent A1AR agonists,^[14, 15] whereas *exo*-7-aza bicyclo[2.2.1]heptane-2-amines derivatives act as inhibitors against the plasmepsins of malarial parasite *Plasmodium falciparum*¹⁶. In spite of significant biological activities associated with these structural frameworks, their synthesis have mainly relied on the chiral resolution of racemic amines.^[15, 17] Although **21** has recently been synthesized^[18] by intramolecular cyclization of optically active 3, 4-diaminocyclohexanol under Mitsunobu condition, the strategy suffers from the requirement of purification of diastereomers in almost every steps. Therefore, we visualized the synthesis of **18** from **11b** by simply removing the phenylsulphonyl moiety. In this context, **11b** was refluxed with Raney-Ni in absolute ethanol for 12 h which produced **17** in 81% yield. The absence of five aromatic protons of PhSO₂ group in the ¹H NMR spectrum of **17** was indicative of the transformation. The two bridge head protons were detected at δ 4.22, 4.07, N-H proton at δ 5.93, and the proton attached to NHAc at δ 3.97. The structure of **17** was further established by HRMS (ESI) analysis, m/z 255.1700 {cal. m/z 255.1703 [C₁₃H₂₃N₂O₃ ([M+H]⁺)]}.

Global deprotection of **17** by refluxing with 6N HCl produced **18** ($[\alpha]_D^{27.5} -3$ {c 1.2, methanol}) quantitatively.

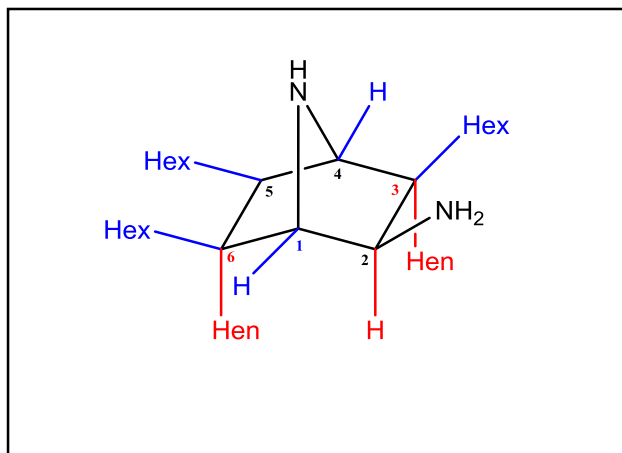

The characteristics H_1 , H_2 and H_4 protons appeared at δ 4.40 (d, $J = 4.8\text{Hz}$, 1H), 3.74 (dd, $J = 4.4, 8.9\text{Hz}$, 1H) and at δ 4.34 (t, $J = 4.6\text{Hz}$, 1H), respectively in the 1H NMR spectrum of **18** in D_2O . In COSY spectrum, correlation between $H_{3en}-H_2-H_{3ex}$ was noticed whereas absence of correlation with H_1 was indicative of *endo* orientation of H_2 . Molecular ion peak observed at m/z 113.1075 in the HRMS (ESI) analysis {cal. m/z 113.1073 $C_6H_{13}N_2$ ($[M+H]^+$)} further confirmed the formation of **18**.

Though we could synthesize the *exo-18*, synthesis of *endo-21* was not possible following this route. Therefore, we decided to proceed with **19**, obtained easily from **2** through

Scheme 6. Synthesis of *exo-7-Azabicyclo[2.2.1]heptan-2-amine*

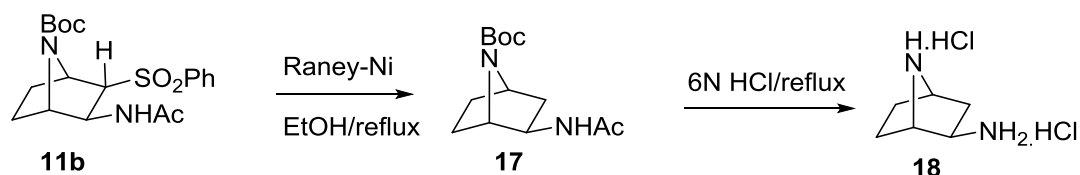

desulfonylation with sodium amalgam. Reductive amination of **19** with benzylamine in the presence of $\text{NaBH}(\text{OAc})_3$ gave **20** in 90% yield. This observed diastereospecificity could be explained by considering the intermediacy of corresponding imine followed by hydride addition from more accessible *exo*-face resulting **20** exclusively. The presence of five aromatic protons of benzyl group in the ^1H NMR spectrum of **20** at δ 7.24 - 7.18 (m, 4H), 7.18 - 7.12 (m, 1H) along with two benzyl protons at δ 3.59 (s, 2H) indicated its formation. In COSY spectrum, existence of correlation between $\text{H}_1\text{-H}_2\text{-H}_{3\text{ex}}$ and $\text{H}_1\text{-H}_2\text{-H}_{3\text{en}}$ indicated of

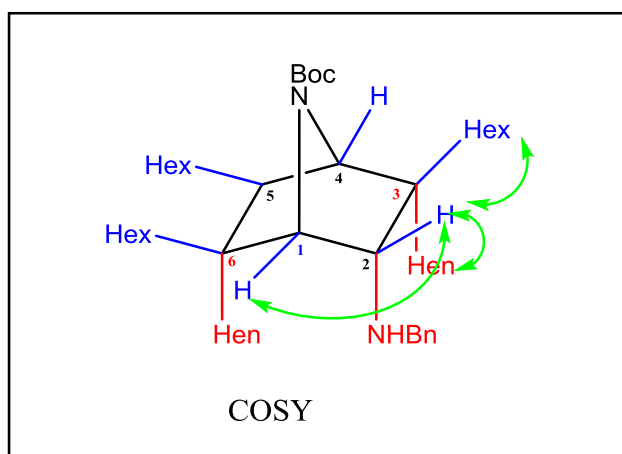

being H_2 in *exo*-orientation. The molecular ion peak at m/z 303.2079 {cal. m/z 303.2079 [$\text{C}_{18}\text{H}_{27}\text{N}_2\text{O}_2$ ($[\text{M}+\text{H}]^+$)]} further confirmed the structure of **20**. Hydrogenolysis of **20** in methanolic HCl produced **21** ($[\alpha]_{\text{D}}^{28}$ -2.6 {c 1.5, H_2O }) in 95 % yield as its dihydrochloride salt. All spectra matched satisfactorily with the literature reported values.^[18]

Scheme 7. Synthesis of *endo*-7-Azabicyclo[2.2.1]heptan-2-amine

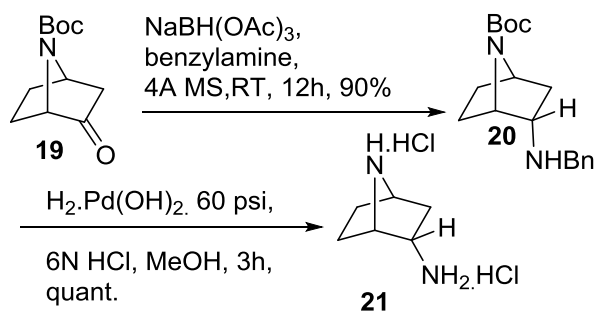

2.2. Conclusion:

We have developed a scalable, novel, and relatively inexpensive strategy towards the syntheses of *cis*-1,2-diaminocyclohexane derivatives and 7-azabicyclo[2.2.1]hept-2-amines. *cis*-1,2-diaminocyclohexane derivatives can be used as organocatalysts, a task currently underway in our laboratory.

2.3. References:

- [1] (a) Trost, B. M.; Radinov, R.; Grenzer, E. M. *J. Am. Chem. Soc.* 1997, *119*, 7879-7880. (b) Jacobsen, E. N.; Zhang, W.; Muci, A. R.; Ecker, J. R.; Deng, L. *J. Am. Chem. Soc.* 1991, *113*, 7063-7064. (c) Trost, B. M.; Van Vranken, D. L. *Chem. Rev.* 1996, *96*, 395-422. (d) Noyori, R.; Hashiguchi, S. *Acc. Chem. Res.* 1997, *30*, 97-102. (e) Jacobsen, E. N. *Acc. Chem. Res.* 2000, *33*, 421-431.
- [2] (a) Takemoto, Y. *Chem. Pharm. Bull.* 2010, *58*, 593-601. (b) Zhang, L.; Luo, S. *Synlett* 2012, 1575-1589.
- [3] Lucet, D.; Le Gall, T.; Mioskowski, C. *Angew. Chem.Int. Ed.* 1998, *37*, 2580-2627.
- [4] (a) Sohtome, Y.; Tanatani, A.; Hashimoto, Y.; Nagasawa, K. *Tet. Lett.* 2004, *45*, 5589-5592. (b) Liu, K.; Cui, H.-F.; Nie, J.; Dong, K.-Y.; Li, X.-J.; Ma, J.-A. *Org. Lett.* 2007, *9*, 923-925. (c) Cao, C.-L.; Ye, M.-C.; Sun, X.-L.; Tang, Y. *Org. Lett.* 2006, *8*, 2901-2904. (d) Sigman, M. S.; Jacobsen, E. N. *J. Am. Chem. Soc.* 1998, *120*, 4901-4902. (e) Yamaoka, Y.; Miyabe, H.; Takemoto, Y. *J. Am. Chem. Soc.* 2007, *129*, 6686-6687. (f) Okino, T.; Hoashi, Y.; Takemoto, Y. *J. Am. Chem. Soc.* 2003, *125*, 12672-12673. (g) Sigman, M. S.; Vachal, P.; Jacobsen, E. N. *Angew. Chem. Int. Ed.* 2000, *39*, 1279-1281. (h) Li, X.-J.; Liu, K.; Ma, H.; Nie, J.; Ma, J.-A. *Synlett* 2008, 3242-3246. (i) Konishi, H.; Lam, T. Y.; Malerich, J. P.; Rawal, V. H. *Org. Lett.* 2010, *12*, 2028-2031. (j) Qian, Y.; Ma, G.; Lv, A.; Zhu, H.-L.; Zhao, J.; Rawal, V. H. *Chem. Commun.* 2010, *46*, 3004-3006. (k) Zhu, Y.; Malerich, J. P.; Rawal, V. H. *Angew. Chem. Int. Ed.* 2010, *49*, 153-156. (l) Wu, R.; Chang, X.; Lu, A.; Wang, Y.; Wu, G.; Song, H.; Zhou, Z.; Tang, C. *Chem. Commun.*, 2011, *47*, 5034-5036. (m) Luo, S.; Xu, H.; Li, J.; Zhang, L.; Cheng, J.-P. *J. Am. Chem. Soc.*, 2007, *129*, 3074-3075.
- [5] (a) Vassilev, L. T.; Vu, B. T.; Graves, B.; Carvajal, D.; Podlaski, F.; Filipovic, Z.; Kong, N.; Kammlott, U.; Lukacs, C.; Klein, C.; Fotouhi, N.; Liu, E. A. *Science* 2004, *303*, 844-848. (b) Hirabayashi, A.; Mukaiyama, H.; Kobayashi, H.; Shiohara, H.; Nakayama, S.; Ozawa, M.; Miyazawa, K.; Misawa, K.; Ohnota, H.; Isaji, M. *Bioorg. Med. Chem.* 2008, *16*, 7347-7357. (c) Nagata, T.; Yoshino, T.; Haginoya, N.; Yoshikawa, K.; Nagamochi, M.; Kobayashi, S.; Komoriya, S.; Yokomizo, A.; Muto, R.; Yamaguchi, M.; Osanai, K.; Suzuki, M.; Kanno, H. *Bioorg. Med. Chem.* 2009, *17*, 1193-1206. (d) Okano, M.; Mito, J.; Maruyama, Y.; Masuda, H.; Niwa, T.;

- Nakagawa, S.-i.; Nakamura, Y.; Matsuura, A. *Bioorg. Med. Chem.* 2009, *17*, 119-132.(e) Yoshikawa, K.; Yokomizo, A.; Naito, H.; Haginoya, N.; Kobayashi, S.; Yoshino, T.; Nagata, T.; Mochizuki, A.; Osanai, K.; Watanabe, K.; Kanno, H.; Ohta, T. *Bioorg. Med. Chem.* 2009, *17*, 8206-8220.(f) Cherney, R. J.; Mo, R.; Meyer, D. T.; Voss, M. E.; Yang, M. G.; Santella III, J. B.; Duncia, J. V.; Lo, Y. C.; Yang, G.; Miller, P. B.; Scherle, P. A.; Zhao, Q.; Mandlekar, S.; Cvijic, M. E.; Barrish, J. C.; Decicco, C. P.; Carter, P. H. *Bioorg. Med. Chem. Lett.*, 2010 *20*, 2425-2430.(g) Cherney, R. J.; Mo, R.; Meyer, D. T.; Nelson, D. J.; Lo, Y. C.; Yang, G.; Scherle, P. A.; Mandlekar, S.; Wasserman, Z. R.; Jezak, H.; Solomon, K. A.; Tebben, A. J.; Carter, P. H.; Decicco, C. P. *J. Med. Chem.* 2008, *51*, 721-724. (h) De Costa, B. R.; Dominguez, C.; He, X. S.; Williams, W.; Radesca, L.; Bowen, W. *J. Med. Chem.* 1992, *35*, 4334-4343.(i) Radesca, L.; Bowen, W. D.; Di Paolo, L.; De Costa, B. R. *J. Med. Chem.* 1991, *34*, 3058-3065.(j) Caron, K.; Lachapelle, V.; Keillor, J. W. *Org. Biomol. Chem.*, 9, 185-197.(k) Govindaraju, T.; Gonnade, R. G.; Bhadbhade, M. M.; Kumar, V. A.; Ganesh, K. N. *Org. Lett.* 2003, *5*, 3013-3016.(l) Trapero, A.; Llebaria, A. *ACS Med. Chem. Lett.*, 2011, *2*, 614-619.
- [6] (a) Moteki, S. A.; Han, J.; Arimitsu, S.; Akakura, M.; Nakayama, K.; Maruoka, K. *Angew. Chem. Int. Ed.*, 2012, *51*, 1187-1190.(b) Nakayama, K.; Maruoka, K. *J. Am. Chem. Soc.* 2008, *130*, 17666-17667.
- [7] (a) Larrow, J. F.; Jacobsen, E. N.; Gao, Y.; Hong, Y.; Nie, X.; Zepp, C. M. *J. Org. Chem.* 1994, *59*, 1939-1942. (b) Pikul, S.; Corey, E. J. *Org. Synth.* 1993, *71*, 22.
- [8] (a) Poll, T.; Sobczak, A.; Hartmann, H.; Helmchen, G. *Tet. Lett.* 1985, *26*, 3095-3098.(b) Yoshino, T.; Nagata, T.; Haginoya, N.; Yoshikawa, K.; Kanno, H.; Nagamochi, M. Ethylenediamine derivatives, PCT Int. Appl. WO2001074774, 2001
- [9] (a) Berkessel, A.; Ong, M. -C.; Nachi, M.; Neudörfl, J. -M. *ChemCatChem* 2010, *2*, 1215-1218. (b) Kitagawa, O.; Yotsumoto, K.; Kohriyama, M.; Dobashi, Y.; Taguchi, T. *Org. Lett.* 2004, *6*, 3605-3607.
- [10] Pandey, G.; Tiwari, K. N.; Puranik, V. G. *Org. Lett.* 2008, *10*, 3611-3614.
- [11] Pandey, G.; Rajender, S. *Chem. Eur. J.* 2011, *17*, 6304-6308.
- [12] Najera, C.; Yus, M. *Tetrahedron* 1999, *55*, 10547-10658.

- [13] Grygorenko, O. O.; Radchenko, D. S.; Volochnyuk, D. M.; Tolmachev, A. A.; Komarov, I. V. *Chem. Rev.* 2011, *111*, 5506-5568.
- [14] Walker, D. P.; Wishka, D. G.; Piotrowski, D. W.; Jia, S.; Reitz, S. C.; Yates, K. M.; Myers, J. K.; Vetman, T. N.; Margolis, B. J.; Jacobsen, E. J.; Acker, B. A.; Groppi, V. E.; Wolfe, M. L.; Thornburgh, B. A.; Tinholt, P. M.; Cortes-Burgos, L. A.; Walters, R. R.; Hester, M. R.; Seest, E. P.; Dolak, L. A.; Han, F.; Olson, B. A.; Fitzgerald, L.; Staton, B. A.; Raub, T. J.; Hajos, M.; Hoffmann, W. E.; Li, K. S.; Higdon, N. R.; Wall, T. M.; Hurst, R. S.; Wong, E. H. F.; Rogers, B. N. *Bioorg. Med. Chem.* 2006, *14*, 8219-8248.
- [15] Ashton, T. D.; Aumann, K. M.; Baker, S. P.; Schiesser, C. H.; Scammells, P. *J. Bioorg. Med. Chem. Lett.* 2007, *17*, 6779-6784.
- [16] Hof, F.; Schütz, A.; Fäh, C.; Meyer, S.; Bur, D.; Liu, J.; Goldberg, D. E.; Diederich, F. *Angew. Chem. Int. Ed.* 2006, *45*, 2138-2141.
- [17] Wishka, D. G.; Walker, D. P.; Corbett, J. W.; Reitz, S. C.; Rauckhorst, M. R.; Groppi, V. E., Jr. Substituted 7-aza[2.2.1]bicycloheptanes for the treatment of disease, EP 1 425 286 B1, 2004.
- [18] Savoia, D.; Grilli, S.; Gualandi, A. *Org. Lett.* 2010, *12*, 4964-4967.
- [19] Trudell, M.L.; Chen, Z. *Chem. Rev.* 1996, *96*, 1179-1193.

2.4. Experimental Section

Preparation of (1*S*, 2*S*, 3*R*, 4*R*)-*tert*-butyl 2-((methylsulfonyl)oxy)-3-(phenylsulfonyl)-7-azabicyclo[2.2.1]heptane-7-carboxylate (**9**):

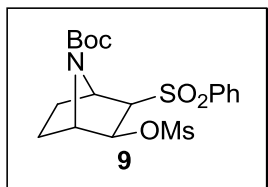

To a solution of **7** (20.0 g, 56.59 mmol) in pyridine (91.3 mL, 1.13 mol) in a round-bottom flask was added methanesulfonyl chloride (10.95 mL, 141.47 mmol) at 0°C and stirred for 24 h until TLC revealed no starting material. The reaction was quenched with water (500.0 mL). The reaction mixture was extracted with EtOAc (3 x 150.0 mL) and the combined organic layer was dried over anhydrous sodium sulphate, filtered, and concentrated by rotary evaporation. The crude material was dried *in vacuo* to give **9** (24.4 g, 99.9%) as a white solid.

$[\alpha]_{\text{D}}^{27.5} +18.0$ (c 0.525, CHCl₃).

m.p. 172.4°C -174.9°C.

IR (neat) ν_{max} cm⁻¹ 1704, 1366, 1177, 1141, 1007, 968, 868.

¹H NMR (200 MHz, CDCl₃, 25°C) δ 8.05 - 7.94 (m, 2H), 7.73 - 7.48 (m, 3H), 4.92 (d, *J* = 7.1Hz, 1H), 4.67 (d, *J* = 3.2Hz, 1H), 4.40 (b s, 1H), 3.56 (d, *J* = 7.2Hz, 1H), 3.18 (s, 3H), 1.78 (s, 2H), 1.39 (s, 11H).

¹³C NMR (100 MHz, DMSO-d₆, 25°C) δ 153.7, 139.7, 134.4, 129.5, 129.4, 80.2, 70.3, 61.6, 58, 37.6, 28.3, 28.2, 23.3.

HRMS (ESI): *m/z* calcd. for C₁₈H₂₉N₂O₇S₂ ([M+NH₄]⁺): 449.1411, found: 449.1411.

Preparation of (1*S*, 2*R*, 3*S*, 4*R*)-*tert*-butyl 2-((methylsulfonyl)oxy)-3-(phenylsulfonyl)-7-azabicyclo[2.2.1]heptane-7-carboxylate (**10**):

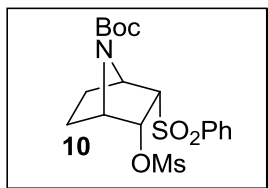

By following the above mentioned procedure, the corresponding mesylate **10** was obtained in 99.5% yield as a white solid.

$[\alpha]_{\text{D}}^{27.6} -13.0$ (*c* 0.475, CHCl₃).

m.p. 177.3°C - 181.6°C

IR. (neat) ν_{max} cm⁻¹ 1706, 1638, 1364, 1152, 1029, 863.

¹H NMR (500 MHz, CDCl₃, 25°C) δ 7.89 (d, *J* = 7.6Hz, 2H), 7.74 - 7.67 (m, 1H), 7.65 - 7.56 (m, 2H), 5.22 (dd, *J* = 4.4, 9.3Hz, 1H), 4.56 - 4.47 (m, 1H), 4.05 (t, *J* = 4.4Hz, 1H), 3.72 (ddd, *J* = 1.5, 4.3, 9.8Hz, 1H), 3.20 (s, 3H), 2.80 - 2.71 (m, 1H), 2.40 - 2.30 (m, 1H), 1.85 - 1.71 (m, 2H), 1.39 (s, 9H).

¹³C NMR (125 MHz, CDCl₃, 25°C) δ 154.0, 139.8, 134.3, 129.6, 128.0, 81.5, 73.9, 64.0, 60.9, 58.5, 38.7, 28.1, 23.0, 21.9.

HRMS (ESI): *m/z* calcd. for C₁₈H₂₉N₂O₇S₂ ([M+NH₄]⁺): 449.1411, found: 449.1409.

Preparation of (1*S*, 2*S*, 3*R*, 4*R*)-*tert*-butyl 2-(allylamino)-3-(phenylsulfonyl)-7-azabicyclo[2.2.1]heptane-7-carboxylate (**11a**):

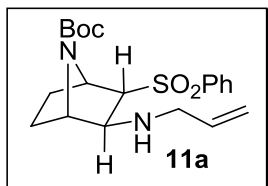

A solution of **9** (10.0 g, 23.2 mmol) in allylamine (34.7 mL, 463.5 mmol) was heated to 55°C for 1 h. When TLC revealed no starting material, allylamine was evaporated off under reduced pressure to obtain **11a** (8.75 g, 96%) as a colorless liquid.

$[\alpha]_{\text{D}}^{25} +29.3$ (*c* 1.1, CHCl₃).

IR (neat) ν_{max} cm⁻¹ 1699, 1639, 1368, 1149.

^1H NMR (500MHz, CDCl_3 , 25°C) δ 7.87 (d, $J = 7.3\text{Hz}$, 2H), 7.67 - 7.59 (m, 1H), 7.59 - 7.51 (m, 2H), 5.65 (b s, 1H), 5.11 - 4.96 (m, 2H), 4.29 (bs, 1H), 4.17 (bs, 1H), 3.41 - 2.91 (m, 4H), 2.39 (t, $J = 9.2\text{Hz}$, 1H), 1.90 - 1.78 (m, 1H), 1.66 - 1.49 (m, 2H), 1.38 (s, 9H).

^{13}C NMR (125MHz, CDCl_3 , 25°C) δ : 155.3, 139.7, 135.9, 133.8, 129.3, 127.9, 116.3, 80.4, 72.9, 63.7, 61.3, 57.3, 50.0, 28.1, 28.0, 26.0, 23.9.

HRMS (ESI): m/z calcd. for $\text{C}_{20}\text{H}_{29}\text{N}_2\text{O}_4\text{S}$ ($[\text{M}+\text{H}]^+$): 393.1843, found: 393.1847.

Preparation of (1*S*, 2*S*, 3*R*, 4*R*)-*tert*-butyl 2-acetamido-3-(phenylsulfonyl)-7-azabicyclo[2.2.1]heptane-7-carboxylate (**11b**):

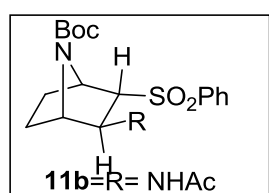

Acetamide (13.7 g, 231.7 mmol) was added to **9** (5.0 g, 11.6 mmol) in a round bottom flask and the mixture was heated until the acetamide melted ($\sim 90^\circ\text{C}$). Potassium carbonate (0.320 g, 2.3 mmol) was added and the reaction mixture was stirred at that temperature for 2 h. The reaction was quenched by adding water (200.0 mL) extracted with EtOAc (3 x 100.0 mL). The combined organic layer was dried over sodium sulphate and concentrated to give **11b** (4.0 g, 87%) as a white solid. The reaction with a mixture of **9** and **10** (50.0 g, 115.9 mmol) gave **11b** (40.0 g, 87%).

$[\alpha]_{\text{D}}^{27.2} +24.7$ (c 2.1, CHCl_3). m.p. $138.5^\circ\text{C} -140^\circ\text{C}$.

IR (neat) ν_{max} cm^{-1} 1651, 1371, 1308, 1151.

^1H NMR (400 MHz, CDCl_3 , 25°C) δ 7.92 (d, $J = 7.5\text{Hz}$, 2H), 7.68 - 7.61 (m, 1H), 7.59 - 7.52 (m, 2H), 5.57 (d, $J = 9.0\text{Hz}$, 1H), 4.63 - 4.52 (m, 2H), 4.09 (d, $J = 5.3\text{Hz}$, 1H), 3.25 (t, $J = 3.8\text{Hz}$, 1H), 2.46 (ddd, $J = 3.1, 8.5, 12.2\text{Hz}$, 1H), 1.94 - 1.83 (m, 1H), 1.76 (t, $J = 5.5\text{Hz}$, 2H), 1.70 (s, 3H), 1.43 (s, 9H).

^{13}C NMR (100 MHz, CDCl_3 , 25°C) δ 168.6, 155.2, 139.5, 134.0, 129.3, 128.2, 81.1, 73.5, 64.2, 58.1, 54.8, 28.1, 26.0, 24.1, 22.9.

HRMS (ESI): m/z calcd. for $\text{C}_{19}\text{H}_{27}\text{N}_2\text{O}_5\text{S}$ ($[\text{M}+\text{H}]^+$): 395.1635, found: 395.1632.

Preparation of (1*R*, 2*S*, 3*S*, 4*S*)-*tert*-butyl 2-(phenylsulfonyl)-3-(pyrrolidin-1-yl)-7-azabicyclo[2.2.1]heptane-7-carboxylate (**11c**):

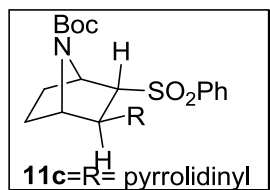

To a stirring solution of pyrrolidine (11.40 mL, 139.0 mmol), **9** (6.0g, 13.90 mmol) was added heating to 90°C. After 1 h, the mixture was concentrated under reduced pressure to obtain **11c** (5.5 g, 97%) as a pale yellow solid.

$[\alpha]_D^{25} +15.2$ (c 2.3, CHCl₃). m.p. 123°C -124°C.

IR (CHCl₃) ν_{\max} cm⁻¹ 2972, 2067, 1637, 1447, 1367.

¹H NMR (500 MHz, CDCl₃, 25°C) δ = 7.90 (dd, J = 1.1, 8.4Hz, 2H), 7.66 - 7.60 (m, 1H), 7.58 - 7.51 (m, 2H), 4.31 (b s, 1H), 4.18 (b s, 1H), 3.59 (b s, 1H), 3.06 (b s, 1H), 2.50 - 2.27 (m, 5H), 1.91 - 1.82 (m, 1H), 1.68 - 1.52 (m, 6H), 1.39 (s, 9H).

¹³C NMR (125MHz, CDCl₃, 25°C) δ = 155.3, 139.9, 133.7, 129.2, 128.1, 80.0, 70.3, 69.3, 61.5, 57.5, 51.4, 28.1, 26.2, 24.4, 23.2.

HRMS (ESI): m/z calcd. for C₂₁H₃₁N₂O₄S ([M+H]⁺): 407.1999, found: 407.2002.

Preparation of (1R, 4S)-tert-butyl 2-(phenylsulfonyl)-7-azabicyclo[2.2.1]hept-2-ene-7-carboxylate (**12**):

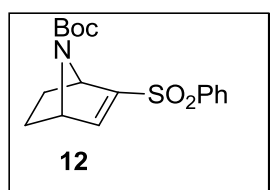

To a solution of **9** and **10** (1.0 g, 2.32 mmol) in dichloromethane was added DBU (0.7 mL, 4.64 mmol) at room temperature and stirred for 1 h by which time TLC revealed no starting material. The reaction was quenched with 10.0 mL of water and extracted with of EtOAc (3 X 10.0 mL). The combined organic layer was concentrated and the crude material was dried *in vacuo* to give **12** (0.77 g, 99%) as a white solid. $[\alpha]_D^{25.4} +6$ (c 2.5, CHCl₃) 1.72 mL of allylamine(23.0 mmol) was added and heated at 55°C for 1 h . When TLC revealed no starting material, the reaction

mixture was concentrated under reduced pressure. The crude material was dried *in vacuo* to obtain **11a** (0.860 g, 95%) as a colorless liquid. The analytical data fully matched with the previously synthesized **11a**.

Preparation of *tert*-butyl ((1*S*, 2*S*)-2-(allylamino)-3-(phenylsulfonyl)cyclohex-3-en-1-yl)carbamate (**13a**):

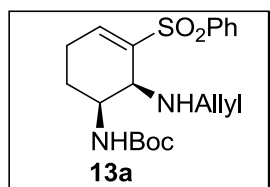

To a solution of **11a** (2.0 g, 5.10 mmol) in 20 mL THF in a round-bottom flask equipped with a magnetic stir bar was added methyl magnesium bromide solution (14.6 mL, 20.4 mmol) drop wise at room temperature. After some time, the solution changed from colourless to yellow. The reaction was quenched with saturated ammonium chloride solution (20 mL) after 4 h. The mixture was extracted with EtOAc (3 x 25.0 mL) and the combined organic layer was dried over anhydrous sodium sulphate, filtered, and concentrated by rotary evaporation. The crude material was purified by column chromatography using petroleum ether and ethyl acetate (70:30) to obtain **13a** (1.72 g, 86%) as a white crystalline solid.

$[\alpha]_D^{27}$ -52.4 (*c* 0.35, MeOH). m.p. 137°C - 138°C.

IR (neat) ν_{\max} cm^{-1} 2927, 1637, 1149.

^1H NMR (500MHz, CDCl_3 , 25°C) δ 7.86 (d, $J = 7.6\text{Hz}$, 2H), 7.66 - 7.59 (m, 1H), 7.58 - 7.50 (m, 2H), 7.14 (dd, $J = 2.7, 4.6\text{Hz}$, 1H), 5.88 - 5.73 (m, 1H), 5.22 - 5.10 (m, 2H), 5.05 (d, $J = 10.1\text{Hz}$, 1H), 3.51 (dd, $J = 6.0, 13.6\text{Hz}$, 1H), 3.45 - 3.37 (m, 1H), 3.32 (b s, 1H), 3.22 (dd, $J = 6.0, 13.6\text{Hz}$, 1H), 2.48 - 2.26 (m, 2H), 1.76 - 1.60 (m, 2H), 1.41 (s, 9H).

^{13}C NMR (125MHz, CDCl_3 , 25°C) δ 155.1, 142.0, 141.0, 139.6, 136.5, 133.4, 129.3, 127.8, 116.1, 79.3, 52.9, 52.4, 49.7, 28.3, 25.3, 23.0.

HRMS (ESI): m/z calcd. for $\text{C}_{20}\text{H}_{29}\text{N}_2\text{O}_4\text{S}$ ($[\text{M}+\text{H}]^+$): 393.1843, found: 393.1847.

Preparation of *tert*-butyl ((1*S*, 2*S*)-2-acetamido-3-(phenylsulfonyl)cyclohex-3-en-1-yl)carbamate (**13b**):

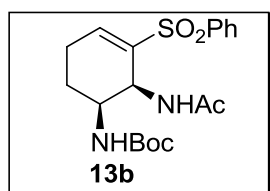

To a solution of **11b** (0.5 g, 1.27 mmol) in 5 mL THF in a round-bottomed flask equipped with a magnetic stir bar was added methyl magnesium bromide solution (3.6 mL, 5.07 mmol) drop wise at room temperature. After some time the solution turned from colourless to yellow. The reaction was quenched with saturated ammonium chloride solution (10.0 mL) after 1 h. The reaction mixture was extracted with EtOAc (3 x 15.0 mL) and the combined organic layer was dried over anhydrous sodium sulphate, filtered, and concentrated by rotary evaporation. The crude material was recrystallised using EtOAc/petroleum ether (90:10) to obtain **13b** (0.4 g, 80%) as a white solid.

$[\alpha]_{\text{D}}^{27.5} -154$ (*c* 0.8, MeOH)

m.p. 243°C -245°C (decomposes).

IR (neat) ν_{max} cm^{-1} 1645, 1306, 1146, 1025.

^1H NMR (200MHz, CDCl_3 , 25°C) δ 7.92 - 7.79 (m, 2H), 7.70 - 7.50 (m, 3H), 7.32 (t, $J = 3.6\text{Hz}$, 1H), 5.81 - 5.60 (m, 1H), 5.32 - 5.08 (m, 1H), 4.87 - 4.70 (m, 1H), 3.60 - 3.40 (m, 1H), 2.56 - 2.39 (m, 2H), 2.11 - 1.89 (m, 5H), 1.39 (s, 9H).

^{13}C NMR (125MHz, DMSO-d_6 , 25°C) δ 168.7, 154.7, 142.6, 140.1, 137.9, 133.3, 129.0, 127.6, 77.6, 49.6, 42.5, 28.3, 25.3, 22.4, 21.1.

HRMS (ESI): m/z calcd. for $\text{C}_{19}\text{H}_{27}\text{N}_2\text{O}_5\text{S}$ ($[\text{M}+\text{H}]^+$): 395.1635, found: 395.1632.

Preparation of *tert*-butyl ((1*S*, 2*R*)-2-acetamidocyclohexyl)carbamate (**14**):

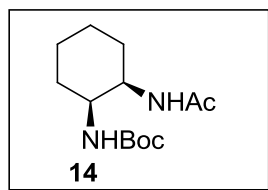

To a stirred solution of **13b** (0.1 g, 0.254 mmol) in absolute ethanol (5 mL) was added Raney-Ni (0.038 g, 0.632 mmol) in one portion and the reaction mixture was refluxed for 12 h. The reaction mixture was cooled and passed through a Celite pad. The filtrate was concentrated by rotary evaporation to obtain **14** (0.065 g, 100%) as a colourless liquid.

$[\alpha]_D^{27} +5$ (*c* 1, CHCl₃).

IR (CHCl₃) ν_{\max} cm⁻¹ 3333, 2933, 2859, 1694, 1645, 1532, 1455, 1367, 1335, 1312, 1249, 1172, 1050, 979, 755.

¹H NMR (400MHz, CDCl₃, 25°C) δ = 6.42 (b s, 1H), 5.01 (b s, 1H), 3.94 (b s, 1H), 3.81 (b s, 1H), 1.95 (s, 3H), 1.84 - 1.53 (m, 4H), 1.43 (s, 13H).

¹³C NMR (100MHz, CDCl₃, 25°C) δ = 170.1, 156.3, 79.7, 50.6, 50.1, 29.4, 28.3, 27.8, 23.4, 22.8, 21.2.

HRMS (ESI): *m/z* calcd. for C₁₃H₂₅N₂O₃ ([M+H]⁺): 257.1860, found: 257.1853.

Preparation of *tert*-butyl ((1*S*, 2*R*)-2-acetamidocyclohex-3-en-1-yl)carbamate (**15**):

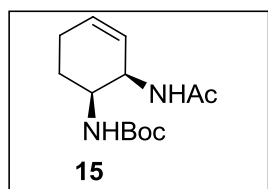

To a stirred solution of **13b** (0.2 g, 0.51 mmol) in methanol 10 mL at -20°C was added 6% sodium amalgam (0.58 g, 1.52 mmol) in one portion and the resultant reaction mixture was stirred for 24 h at that temperature. The reaction was quenched with a saturated aqueous solution of ammonium chloride (10.0 mL) and extracted with EtOAc (3 x 15.0 mL). The combined organic layer was dried over anhydrous sodium sulphate, filtered, and concentrated by rotary evaporation. The crude

material was purified by column chromatography using EtOAc/petroleum ether (70:30) as eluent to obtain **15** (0.11 g, 85%) as a colorless liquid.

$[\alpha]_D^{24} -31.1$ (*c* 0.9, CHCl₃).

IR (CHCl₃) ν_{\max} cm⁻¹ 3435, 2094, 1642, 1369, 1169, 1048.

¹H NMR (400MHz, CDCl₃, 25°C) δ 5.88 - 5.80 (m, 1H), 5.68 (b s, 1H), 5.62 - 5.50 (m, 1H), 5.03 (b s, 1H), 4.62 (b s, 1H), 3.90 (tt, *J* = 4.0, 7.8Hz, 1H), 2.13 (b s, 2H), 2.02 (s, 3H), 1.78 (b s, 1H), 1.68 - 1.61 (m, 1H), 1.45 (s, 9H).

¹³C NMR (100MHz, CDCl₃, 25°C) δ 170.4, 155.9, 130.4, 126.2, 79.5, 48.8, 47.2, 28.3, 24.7, 23.5, 22.8.

HRMS (ESI): *m/z* calcd. for C₁₃H₂₂N₂O₃Na ([M+Na]⁺): 277.1523, found: 277.1517.

Preparation *tert*-butyl ((1*S*, 2*S*)-2-acetamido-3-(phenylsulfonyl)cyclohexyl)carbamate (**16**):

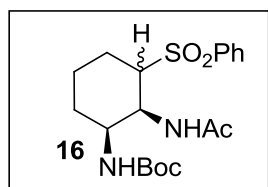

To a solution of **13b** (0.2 g, 0.507 mmol) in 20 mL methanol in a round-bottomed flask equipped with a magnetic stir bar was added 10% Pd/C (0.054 g, 0.05 mmol) at room temperature. A hydrogen balloon was attached and the reaction stirred vigorously for 24 h until TLC revealed no starting material. The reaction mixture was passed through a Celite pad and concentrated *in vacuo* to obtain **16** (0.2 g, 99%) as a colorless liquid.

$[\alpha]_D^{26} +24.8$ (*c* 1.3, CHCl₃).

¹H NMR (200MHz, CDCl₃, 25°C) δ 7.89 - 7.79 (m, 2H), 7.75 - 7.51 (m, 3H), 6.38 (d, *J* = 7.3Hz, 1H), 4.33 - 4.19 (m, 1H), 3.91 (t, *J* = 10.4Hz, 1H), 3.27 (dt, *J* = 3.9,

10.5Hz, 1H), 2.28 - 2.14 (m, 1H), 1.98 (s, 3H), 1.89 - 1.70 (m, 2H), 1.61 - 1.49 (m, 1H), 1.43 (s, 9H).

HRMS (ESI): m/z calcd. for $C_{19}H_{29}N_2O_5S$ ($[M+H]^+$): 397.1792, found: 397.1799.

Preparation of (1*S*, 2*R*, 4*R*)-*tert*-butyl 2-acetamido-7-azabicyclo[2.2.1]heptane-7-carboxylate(**17**):

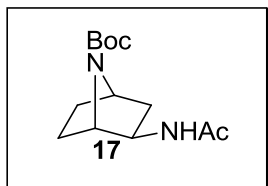

To a solution of **11b** (0.2 g, 0.507mmol) in 10 mL absolute ethanol, freshly prepared Raney-Ni (0.09 g, 1.5 mmol) was added. The reaction mixture was refluxed for 12 h until TLC revealed no starting material. The mixture was cooled, passed through a Celite pad and concentrated *in vacuo* to obtain **17** (0.105 g, 81%) as a colorless liquid.

$[\alpha]_D^{29.2} +71.6$ (c 2, CH_3OH).

IR (neat) ν_{max} cm^{-1} 2978, 1648, 1638, 1368, 1168, 1138, 1020.

1H NMR (400MHz, $CDCl_3$, 25°C) δ = 5.93 (b s, 1H), 4.22 (t, J = 4.9Hz, 1H), 4.07 (d, J = 5.0Hz, 1H), 3.97 (dt, J = 3.3, 7.9Hz, 1H), 1.94 (s, 3H), 1.81 - 1.61 (m, 2H), 1.53 - 1.46 (m, 2H), 1.44 (s, 9H), 1.40 (dd, J = 2.9, 17.2Hz, 2H).

^{13}C NMR (100MHz, $DMSO-d_6$, 25°C) δ = 169.4, 156.4, 80.1, 61.3, 55.9, 53.0, 40.4, 28.3, 28.2, 25.9, 23.2.

HRMS (ESI): m/z calcd. for $C_{13}H_{23}N_2O_3$ ($[M+H]^+$): 255.1703, found: 255.1700.

Preparation of (1*S*, 2*R*, 4*R*)-7-azabicyclo[2.2.1]heptan-2-amineHydrochloride (**18**) :

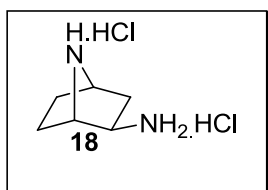

A solution of **17** (0.1 g, 0.393 mmol) in 6N HCl (5 mL) in a round-bottom flask equipped with a magnetic stir bar and a reflux condenser was refluxed for 12 h until TLC revealed no starting material. The reaction was concentrated by rotary evaporation and the crude material was dried *in vacuo* to give **18** (0.071 g, 98%) as brown solid.

$[\alpha]_D^{27.5} -3$ (c 1.2, CH₃OH).

IR (CHCl₃) ν_{\max} cm⁻¹ 3437, 1634, 1227, 1059.

¹H NMR (400MHz, D₂O, 25°C) δ 4.40 (d, *J* = 4.8Hz, 1H), 4.34 (t, *J* = 4.6Hz, 1H), 3.74 (dd, *J* = 4.4, 8.9Hz, 1H), 2.36 (dd, *J* = 8.9, 14.4Hz, 1H), 2.00 - 1.84 (m, 3H), 1.78 - 1.64 (m, 2H).

¹³C NMR (100MHz, D₂O, 25°C) δ 61.4, 58.5, 51.0, 34.4, 24.9, 24.2.

HRMS (ESI): *m/z* calcd. for C₆H₁₃N₂ ([M+H]⁺): 113.1073, Found 113.1075.

Preparation of (1*S*, 2*S*, 4*R*)-*tert*-butyl 2-(benzylamino)-7-azabicyclo[2.2.1]heptane-7-carboxylate (**20**):

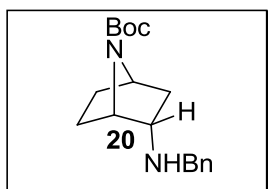

To a solution of **19** (0.20 g, 0.946 mmol) and anhydrous magnesium sulphate in dichloroethane (5.00 mL) in a round-bottomed flask equipped with a magnetic stir bar was added benzylamine (0.16 mL, 1.42 mmol). The flask was stirred for 60 min under argon atmosphere, after which sodium triacetoxyborohydride (0.30 g, 1.42 mmol) was added. The reaction was allowed to stir for 24 h at rt until TLC showed

complete conversion of the starting material. The reaction was quenched with 2N NaOH solution (5.00 mL). The layers were separated and the aqueous layer was extracted with DCM (3 x 10.0 mL). The combined organic layer was dried over sodium sulphate, filtered, and concentrated by rotary evaporation. The crude material was purified by column chromatography with EtOAc/petroleum ether (60:40) as eluent to give **20** (0.27 g, 94%) as a colourless liquid.

$[\alpha]_{\text{D}}^{28.9} +12.2$ (*c* 0.5, CHCl₃).

IR (neat) ν_{max} cm⁻¹ 3087, 3063, 3006, 2975, 2871, 2090, 1698, 1641, 1496, 1456, 1366, 1165.

¹H NMR (400MHz, CDCl₃, 25°C) δ 7.24 - 7.18 (m, 4H), 7.18 - 7.12 (m, 1H), 4.19 - 3.93 (m, 2H), 3.59 (s, 2H), 3.23 - 3.10 (m, 1H), 2.13 - 2.01 (m, 1H), 1.96 (ddd, *J* = 4.5, 9.2, 12.2Hz, 1H), 1.34 (s, 9H), 0.78 (dd, *J* = 4.6, 12.1Hz, 1H).

¹³C NMR (100MHz, CDCl₃, 25°C) δ 155.7, 140.0, 128.4, 128.2, 127.1, 79.5, 58.8, 58.5, 56.8, 52.9, 37.9, 30.1, 28.3, 21.4.

HRMS (ESI): *m/z* calcd. for C₁₈H₂₇N₂O₂ ([M+H]⁺): 303.2067, found: 303.2079.

Preparation of (1*S*, 2*S*, 4*R*)-7-azabicyclo[2.2.1]heptan-2-amine hydrochloride (**21**):

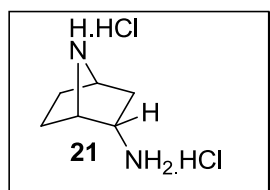

To a solution of **20** (0.1 g, 0.33 mmol) in distilled methanol (5 mL) was added 5 mL 6N HCl solution and Pd(OH)₂/C (0.046 g, 0.66 mmol) and the reaction mixture was put in the Parr Shaker and shaken at 60 psi hydrogen pressure for 4 h at rt. The solution was filtered and evaporated under reduced pressure to obtain **21** (0.059 g, 97%) as a colorless solid.

$[\alpha]_{\text{D}}^{28} +2.2$ (*c* 2, H₂O).

IR (neat) ν_{\max} cm^{-1} 2068, 1637, 1422, 1022.

^1H NMR (400MHz, D_2O , 25°C) δ 4.43 (b s, 1H), 4.28 (t, $J = 4.5\text{Hz}$, 1H), 3.97 - 3.89 (m, 1H), 2.50 - 2.39 (m, 1H), 2.08 - 1.96 (m, 3H), 1.87 - 1.77 (m, 1H), 1.64 (dd, $J = 4.4, 14.4\text{Hz}$, 1H).

^{13}C NMR (100MHz, D_2O , 25°C) 59.4, 59.2, 48.2, 31.3, 26.3, 19.7.

HRMS(ESI): m/z calcd. for $\text{C}_6\text{H}_{13}\text{N}_2$ ($[\text{M}+\text{H}]^+$): 113.1073, found: 113.1044.

2.5. Spectras.

Shimadzu CLASS-VP V6.12 SP5
 Method Name: C:\CLASS-VP\Data\Dr. CHAVAN S. P/PAPAL FH10 % IPAPE
 Data Name: C:\CLASS-VP\Data\Dr.Ganesh Pandey\gp-1739
 User: System
 Acquired: 5/8/12 3:32:28 PM
 Printed: 8/30/12 3:24:09 PM
 Sample Name RF-1-R

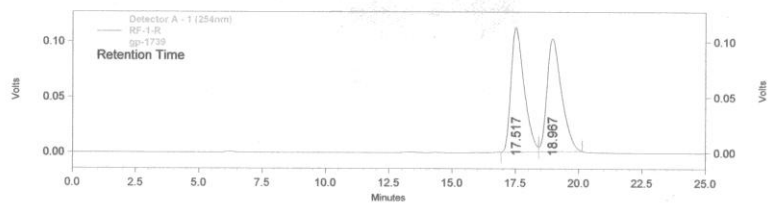

Detector A - 1 (254nm)		
Retention Time	C Area	Area %
17.517	4062486	49.822
18.967	4091435	50.178
Totals		8153921
		100.000

Project Leader : Dr.G. Pandey
 Column : Chiralcel OD-H (250x4.6 mm)
 Mobile Phase : IPA:Pet Ether (10:90)
 Wavelength : 254nm
 Flow Rate : 0.5ml/min
 conc. : 1mg/1 mL
 Inj vol- : 5 ul



Shimadzu CLASS-VP V6.12 SP5
 Method Name: C:\CLASS-VP\Data\Dr. CHAVAN S. P.PAPAL FH10 % IPAPE
 Data Name: C:\CLASS-VP\Data\Dr.Ganesh Pandey\gp-1810
 User: System
 Acquired: 8/24/12 5:18:20 PM
 Printed: 8/24/12 5:46:37 PM
 Sample Name RF-C

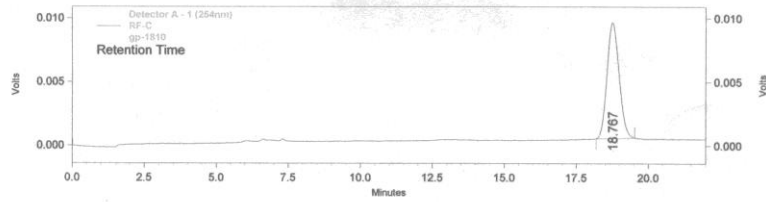

Detector A - 1 (254nm)		
Retention Time	C Area	Area %
18.767	266496	100.000
Totals		100.000
	266496	

Project Leader : Dr.G. Pandey
 Column : Chiralcel OD-H (250x4.6 mm)
 Mobile Phase : IPA:Pet Ether (10:90)
 Wavelength : 254nm
 Flow Rate : 0.5ml/min
 conc. : 1mg/1 mL
 Inj vol- : 2 ul

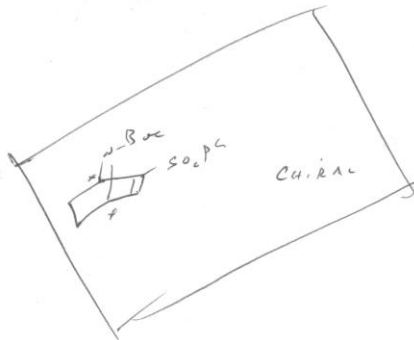

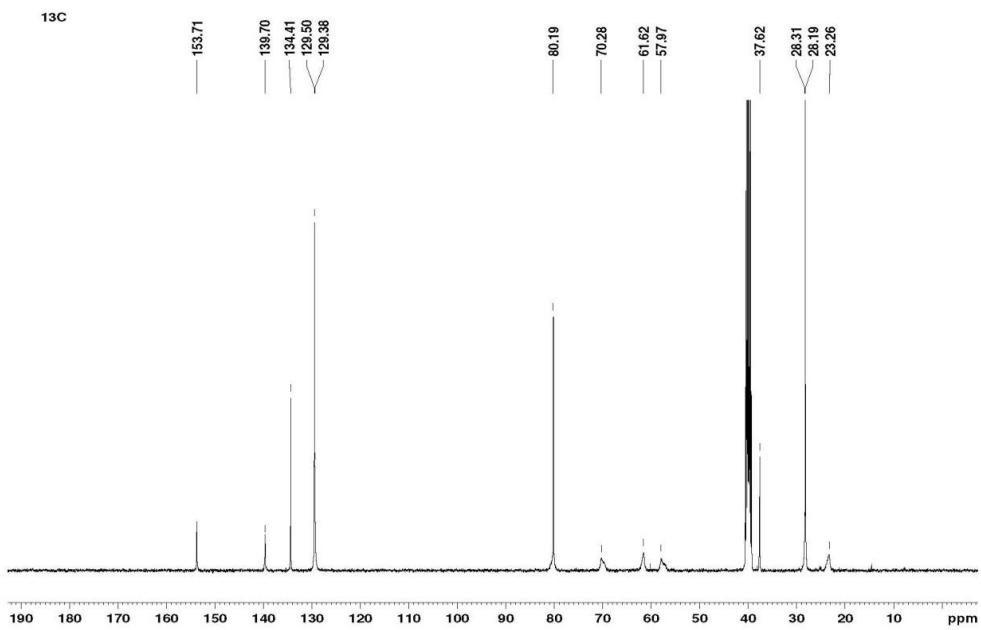
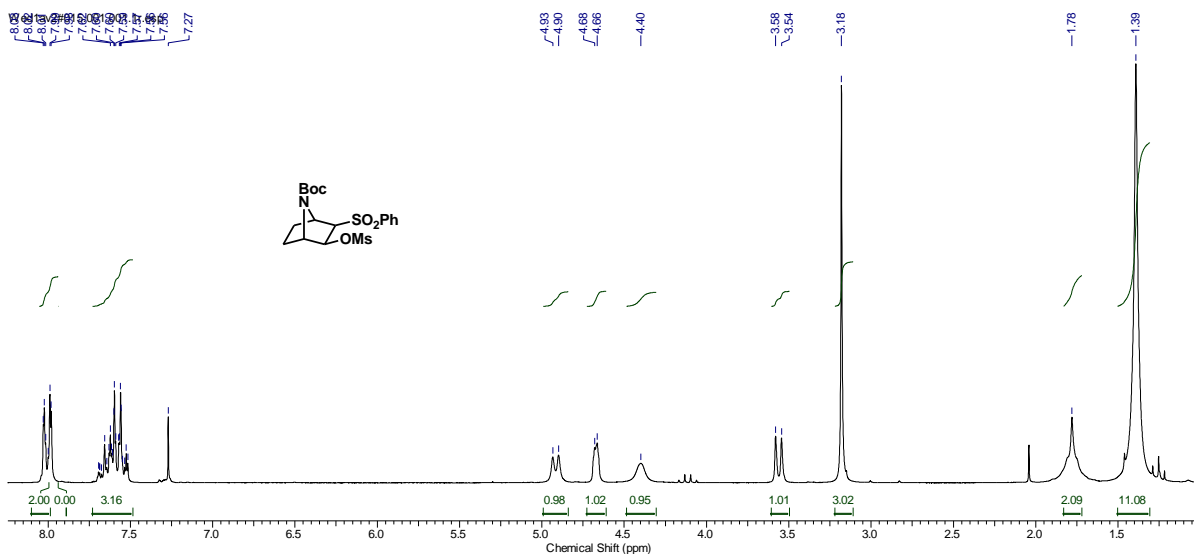

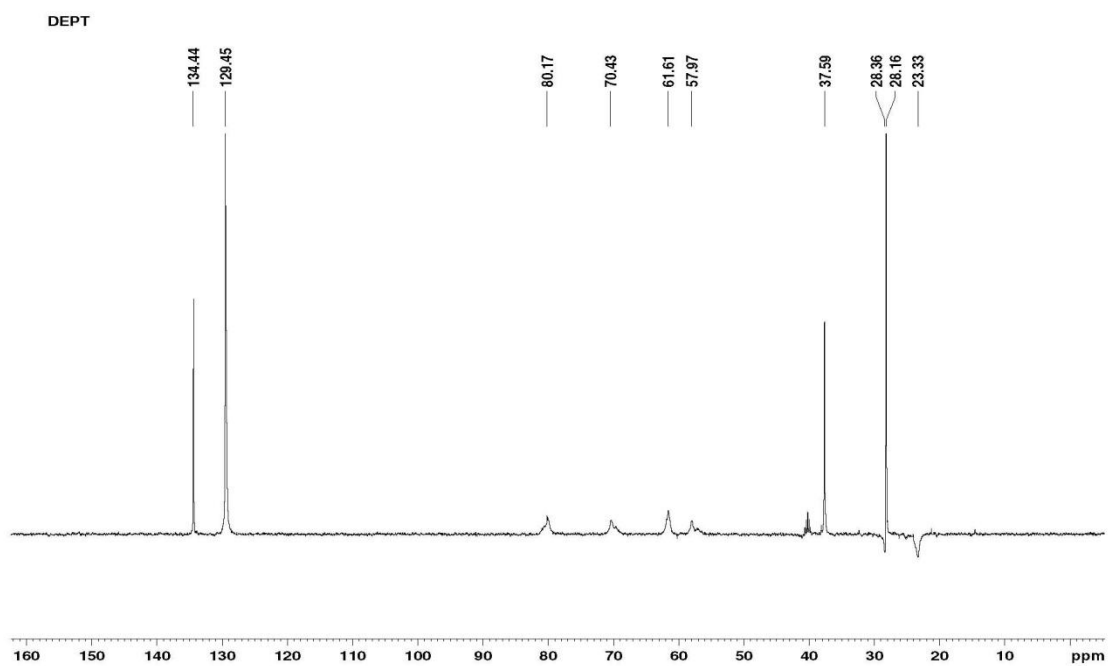

Mon2av400#022.003.001.2rr.esp

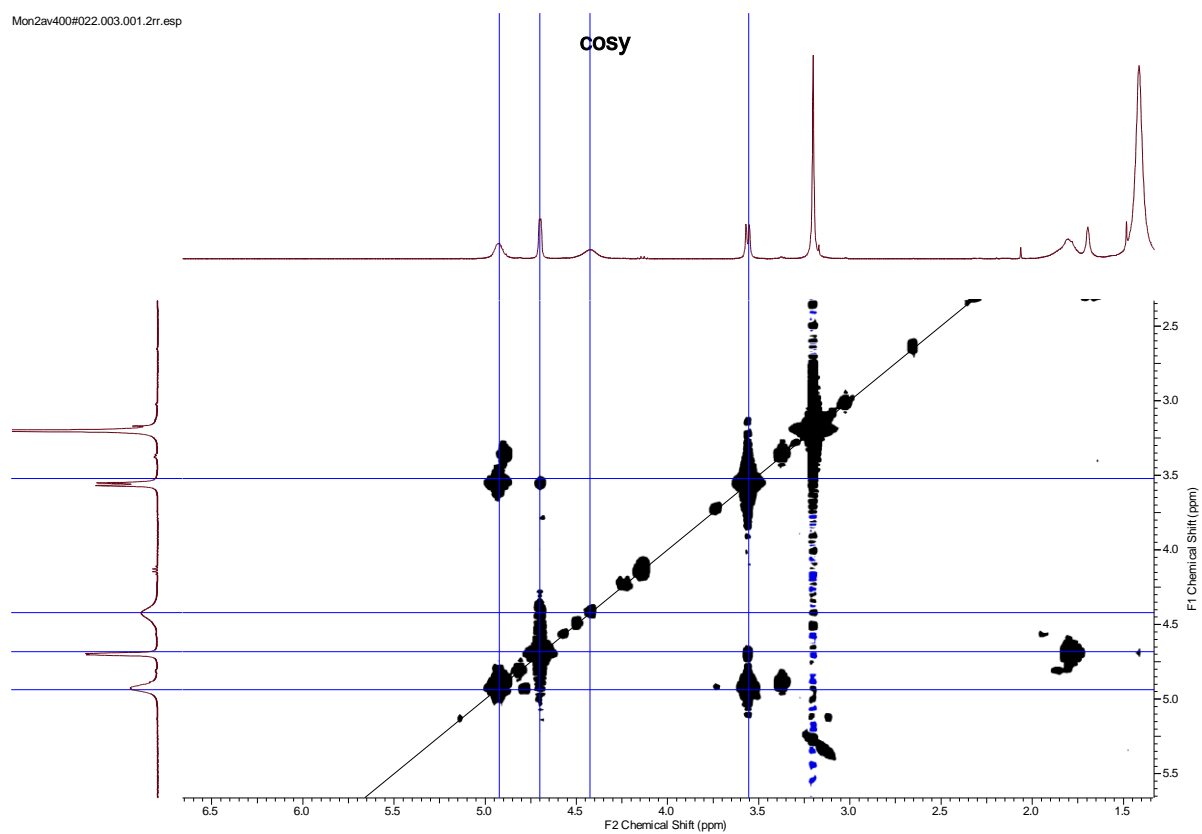

Mon2av400#022.004.001.2rr.esp

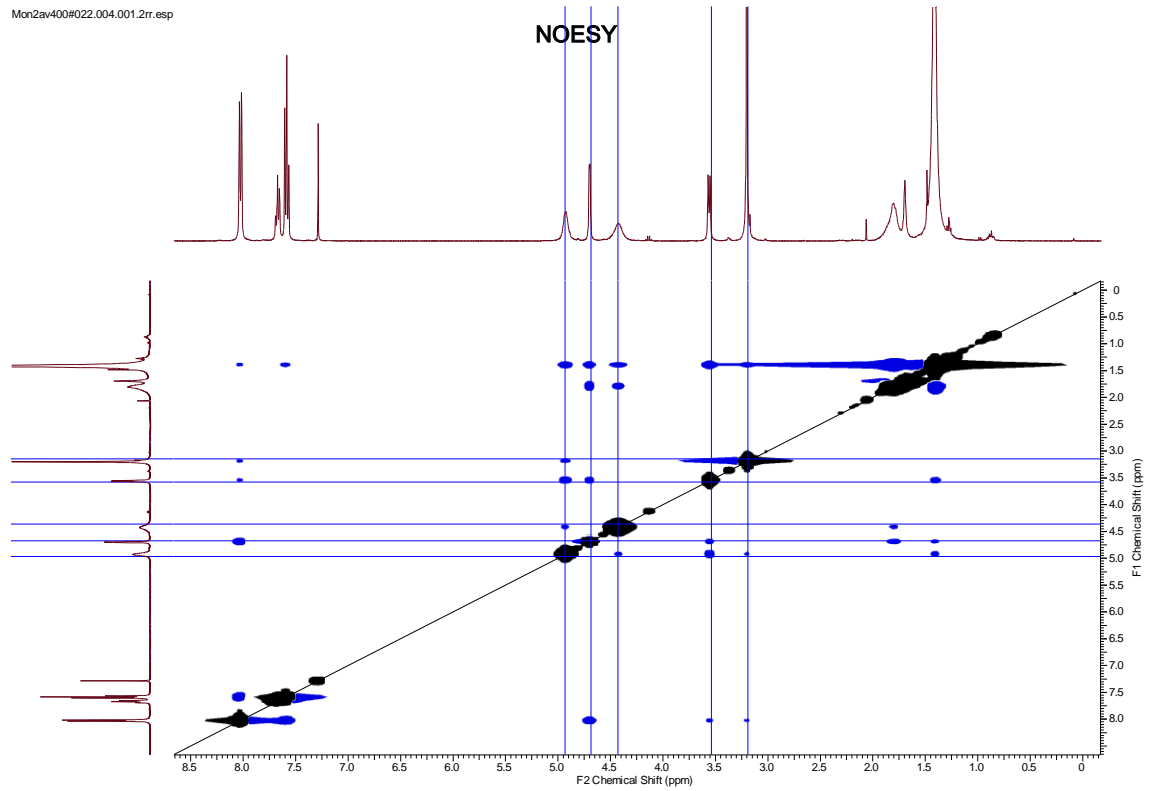

Debasis 1H

Mon2av400#022.004.001.2rr.esp

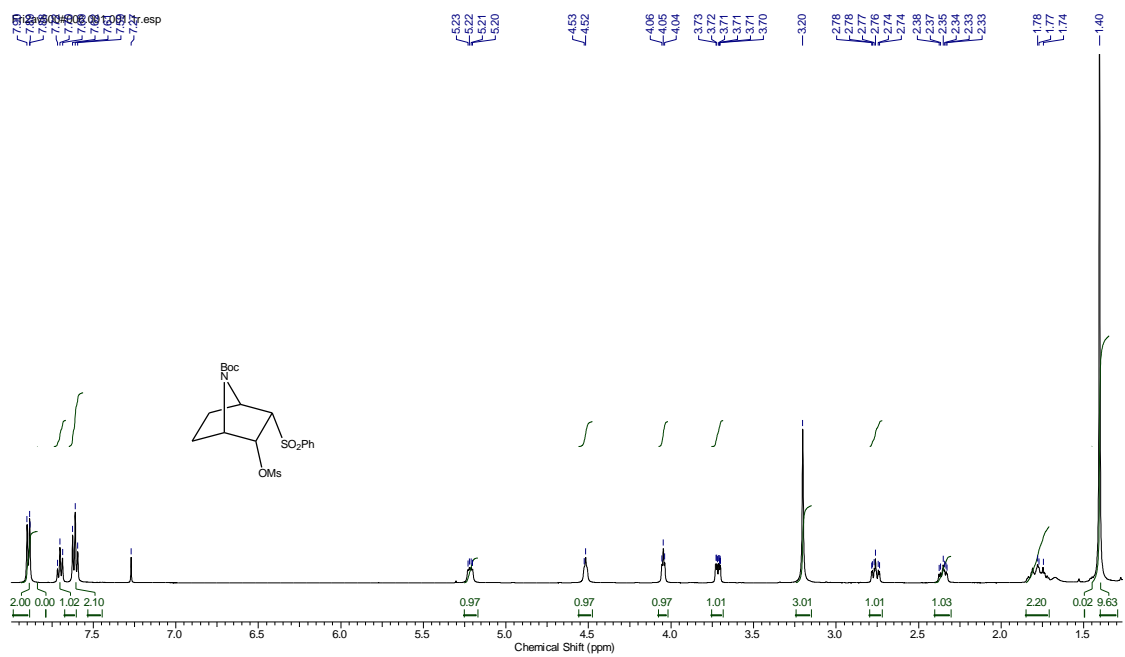

Z:\AV_500\Jun_12_500\Fri2av500#006\Fri2av500#006.001.001.1r.esp

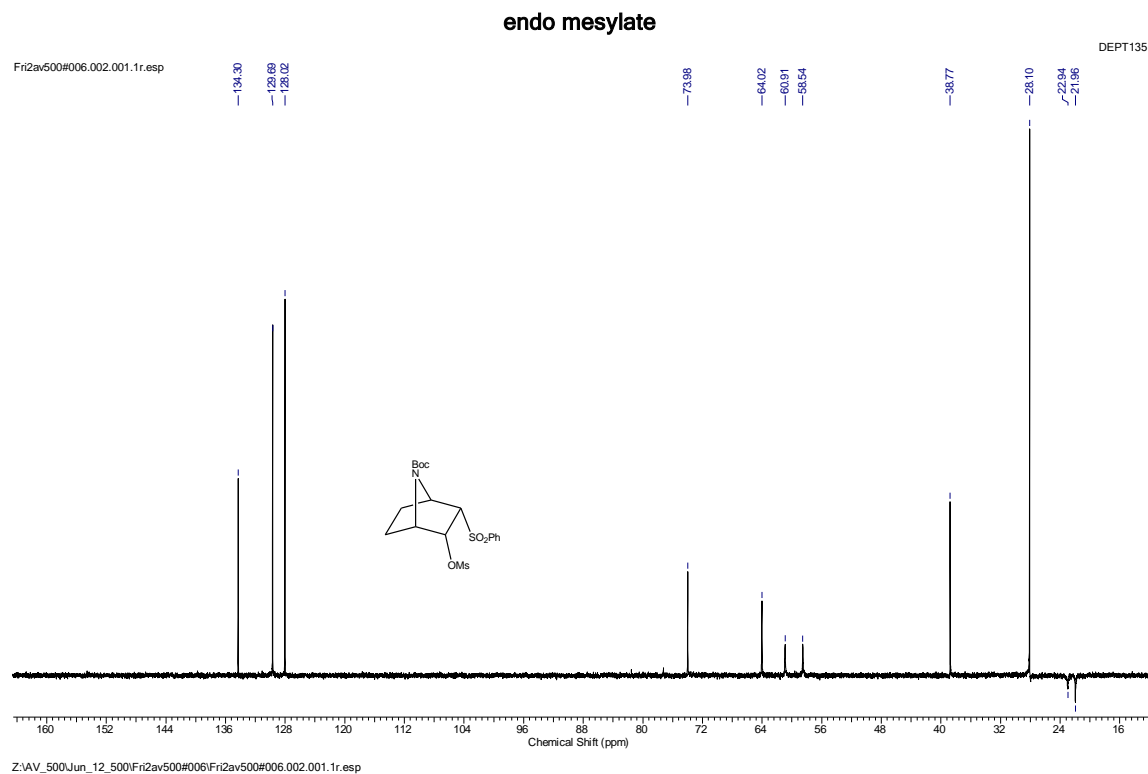
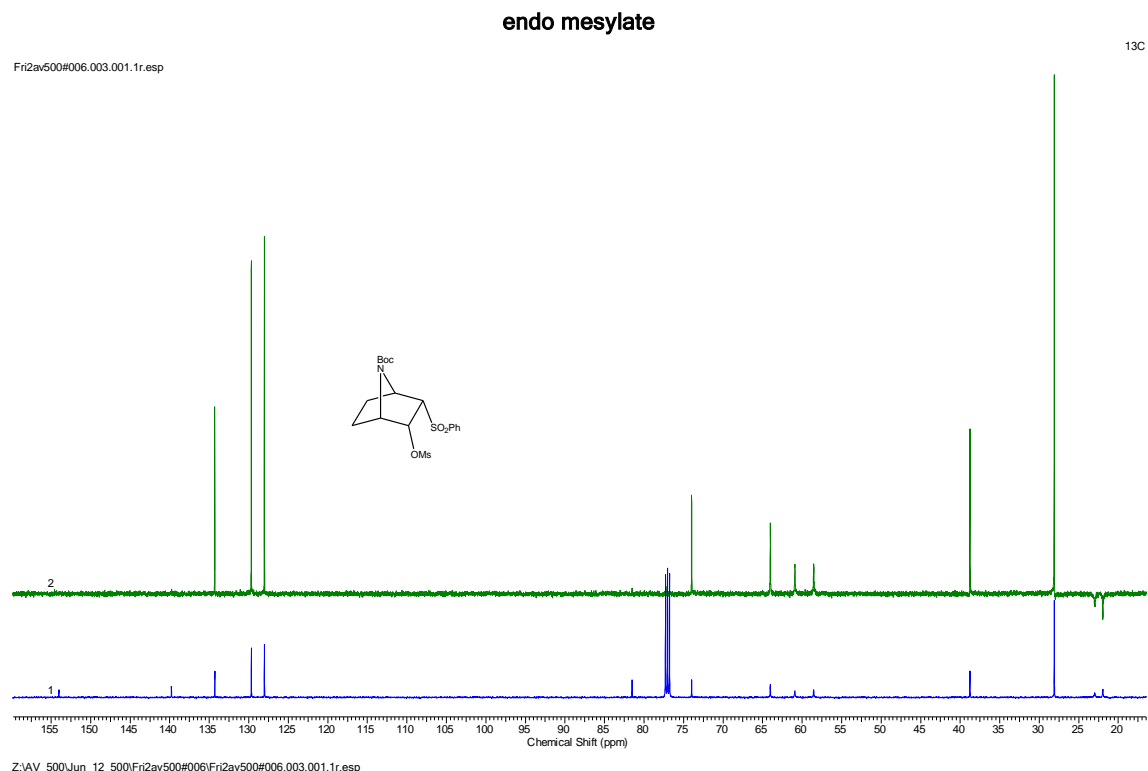

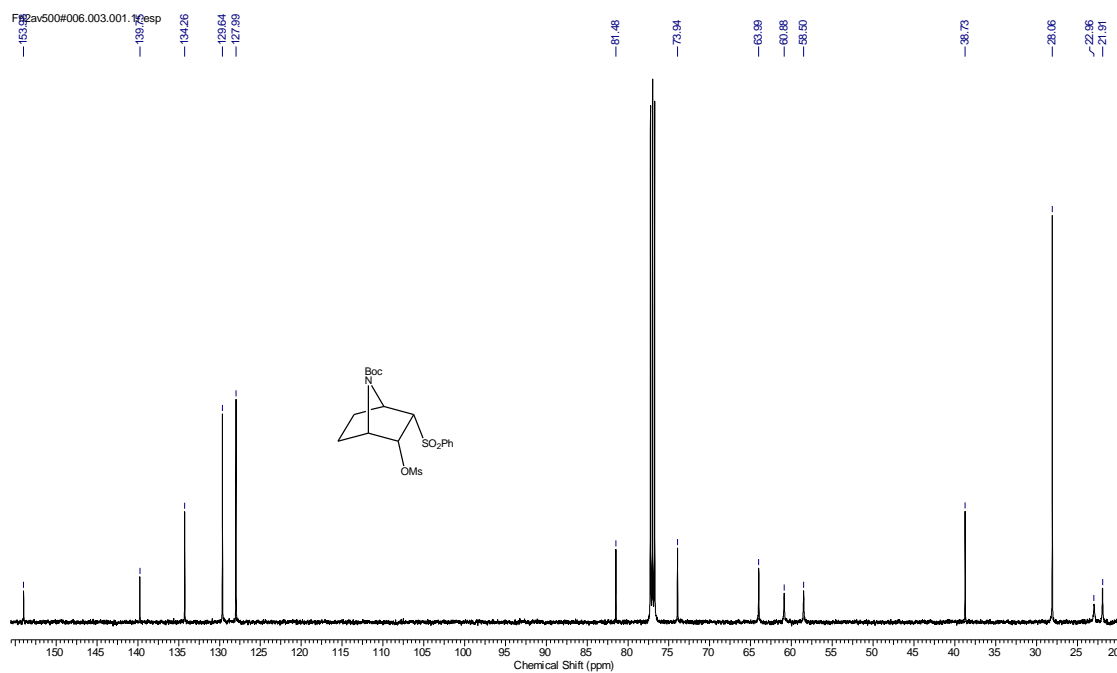

Debasis Dey 1H

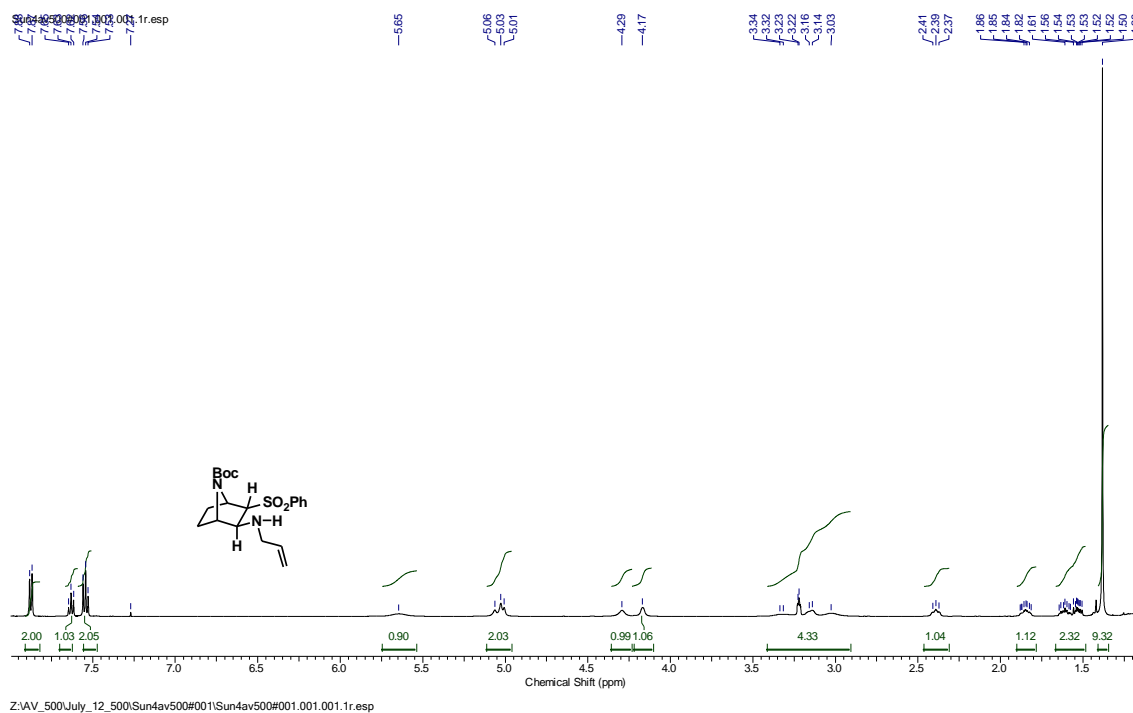

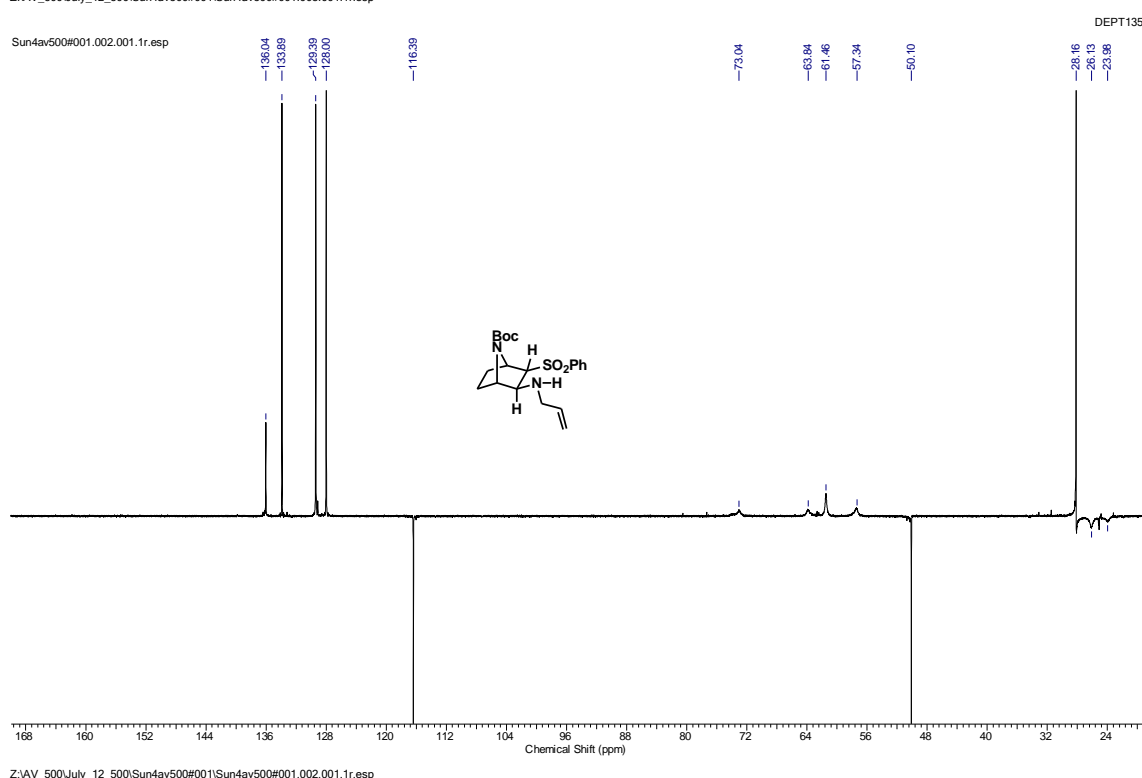
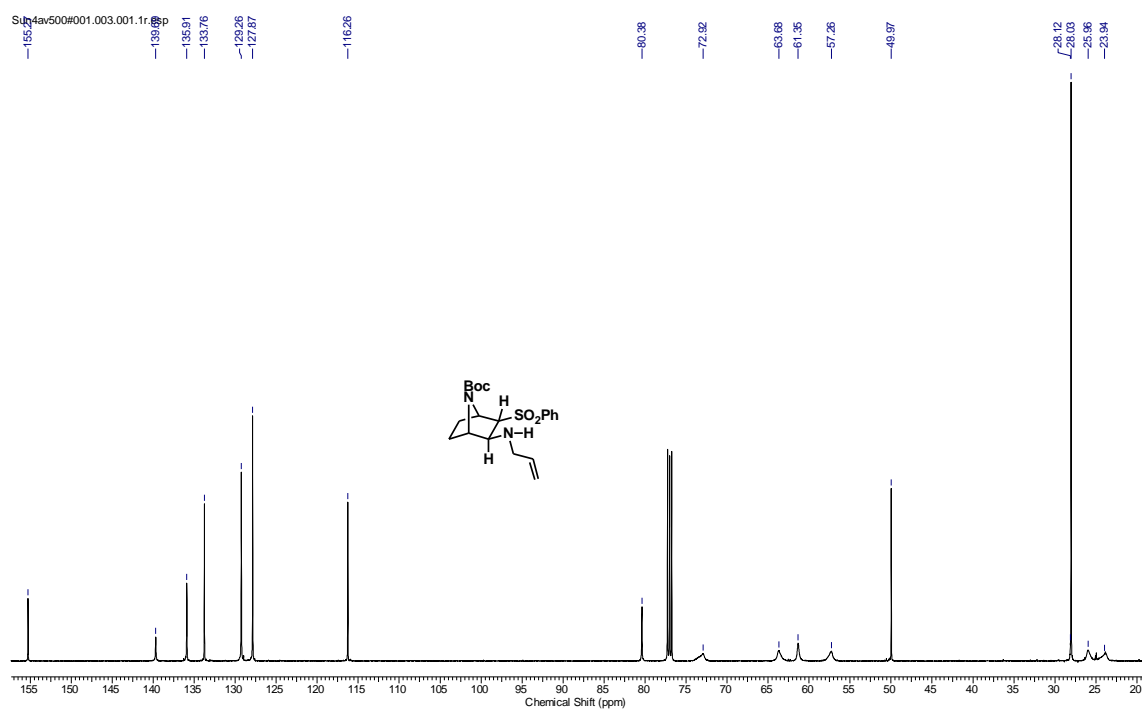

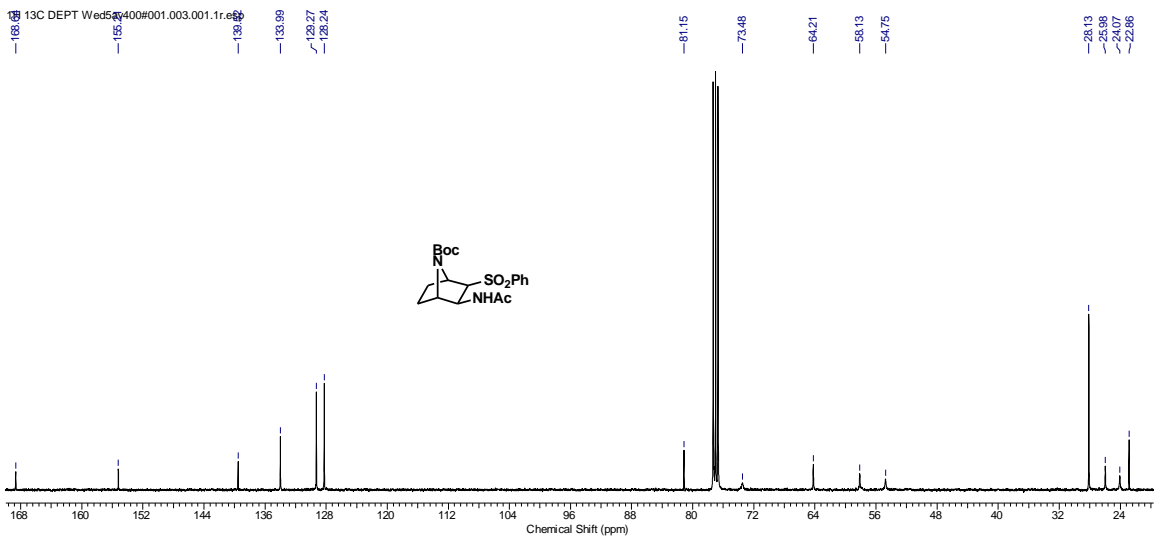
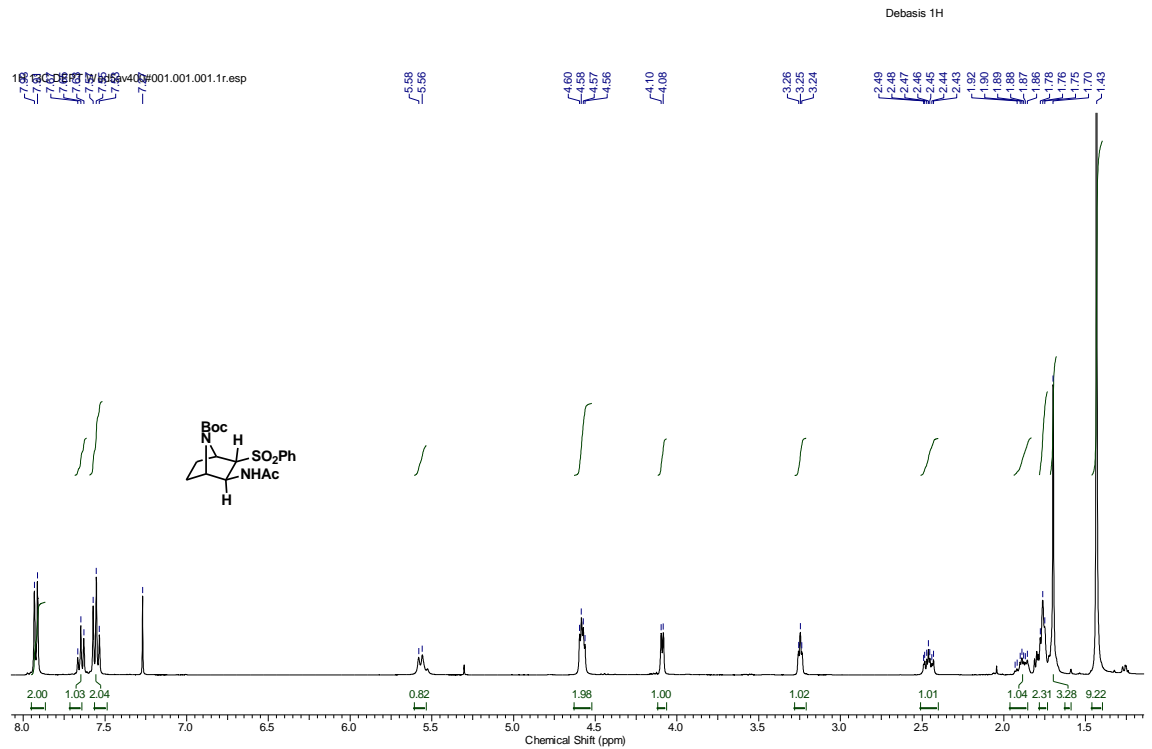

1H 13C DEPT Wed5av400#001.002.001.1r.esp

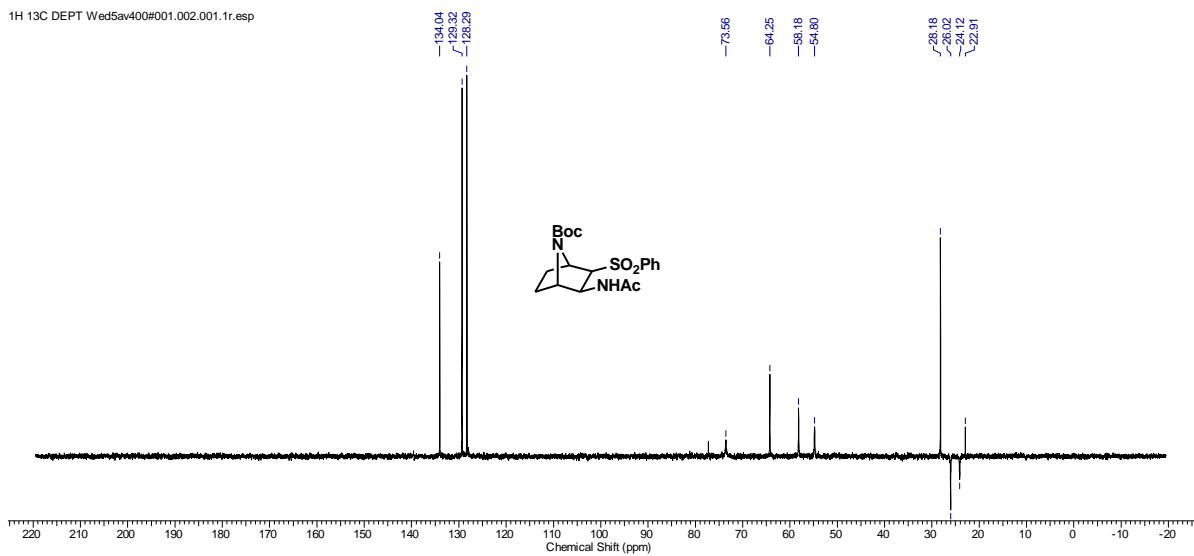

Mon3av400#011.005.001.2rr.esp

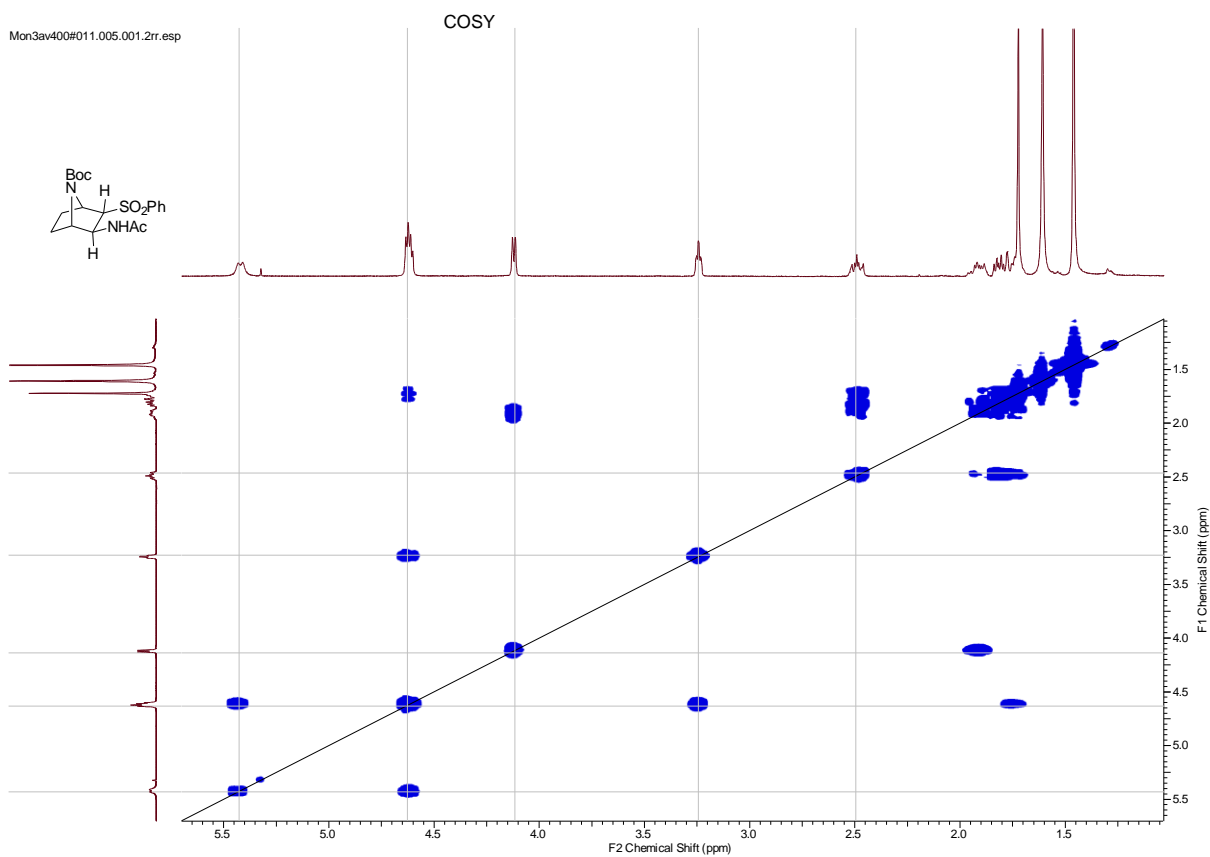

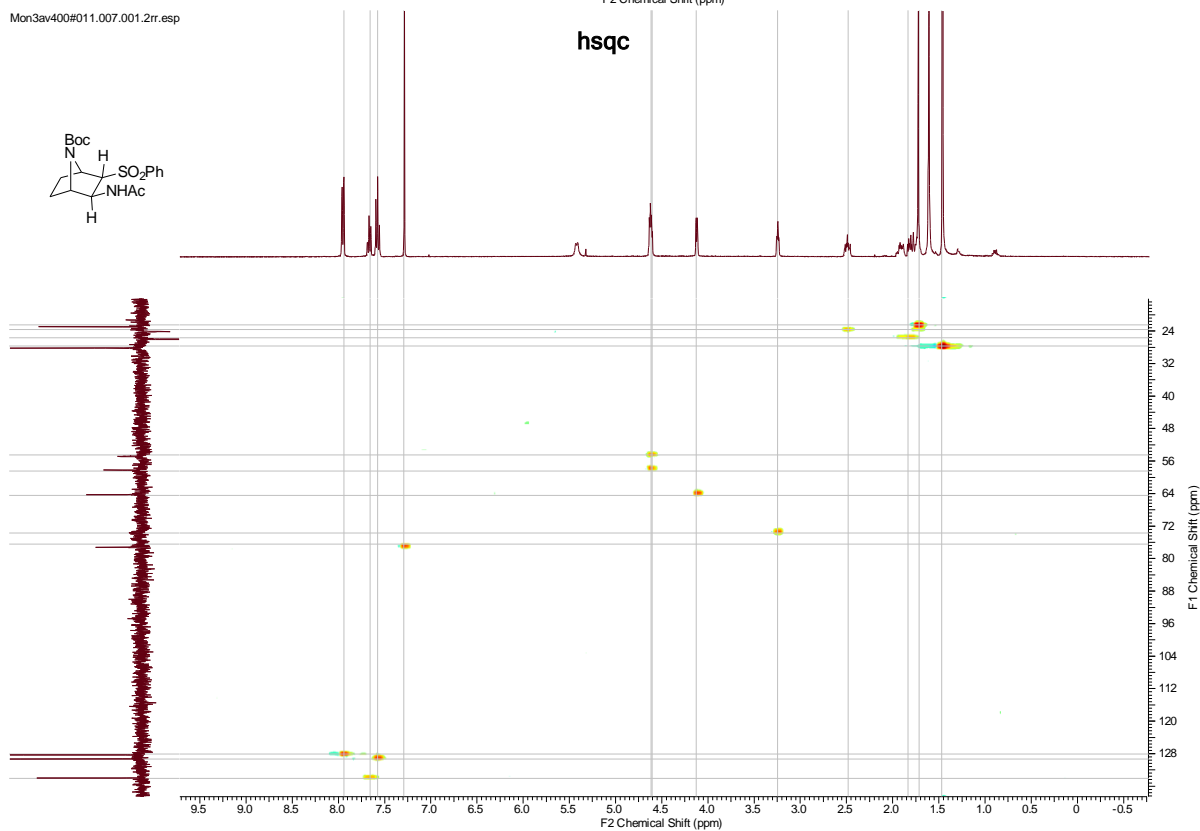
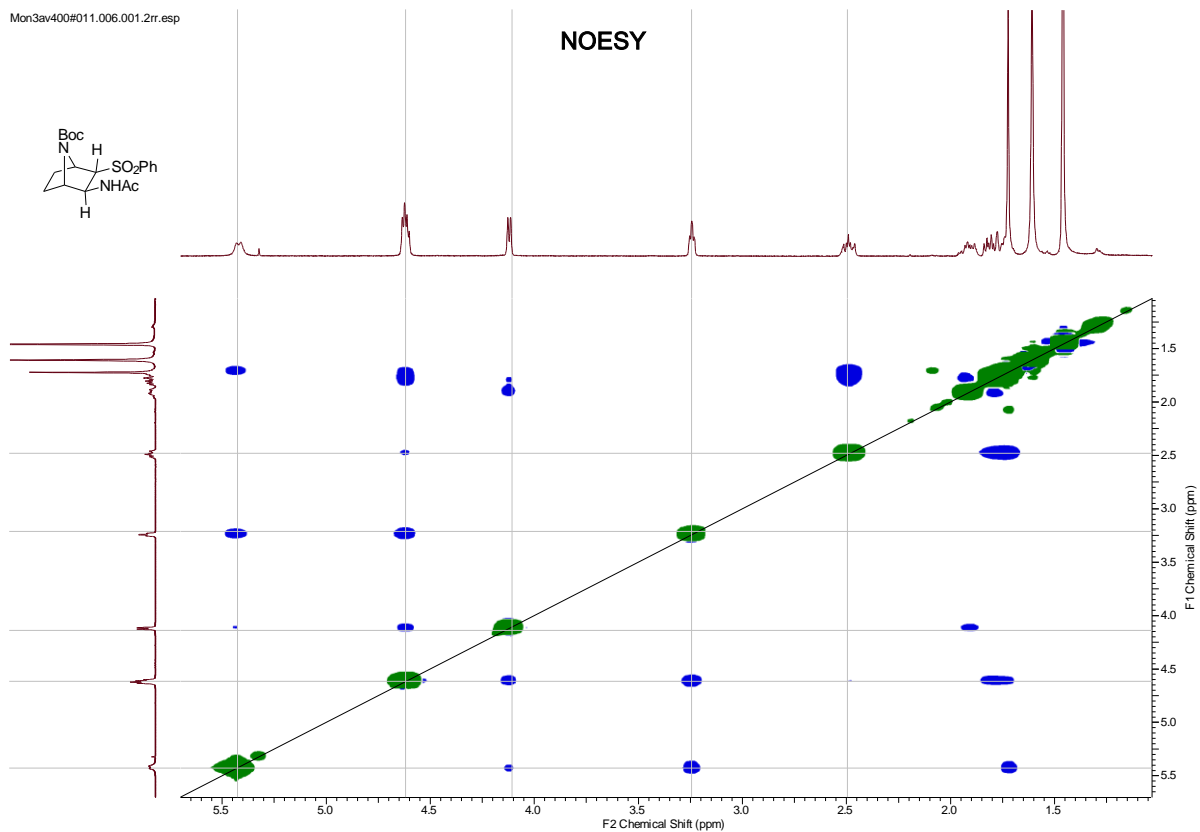

1H 13C DEPT Wed5av400#001.002.001.1r.esp

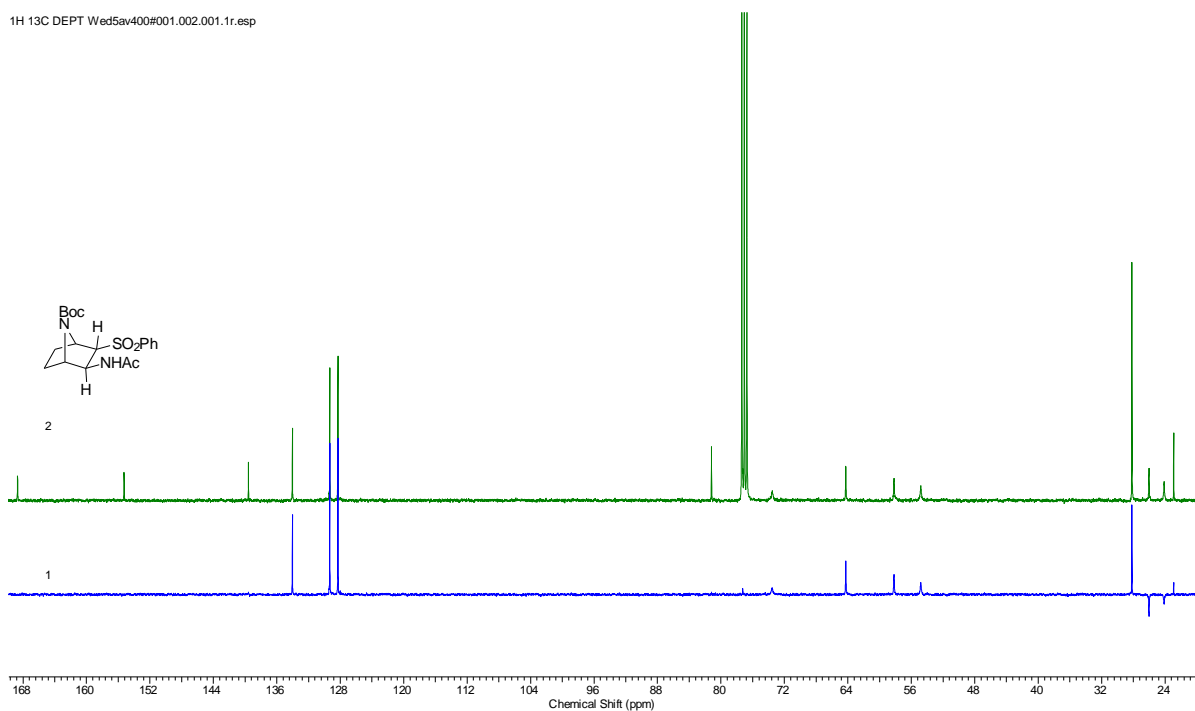

Debasis Dey 1H/CDCl3

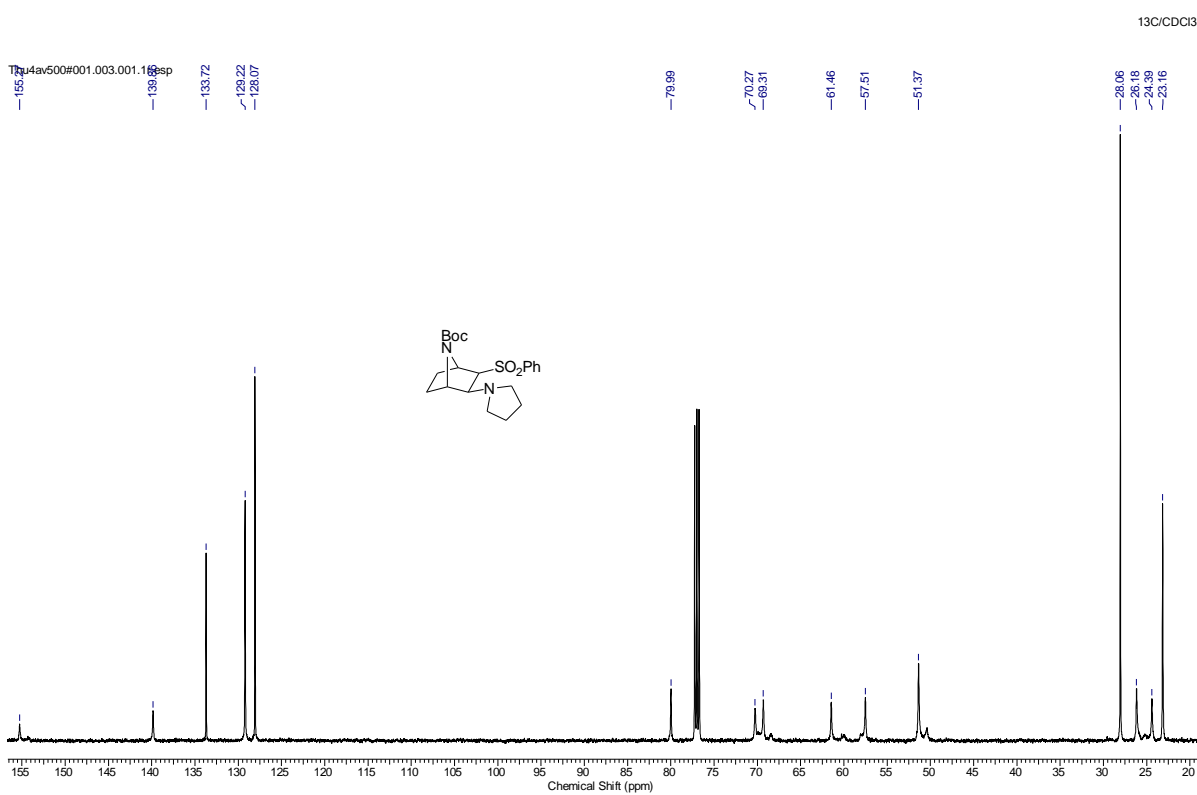
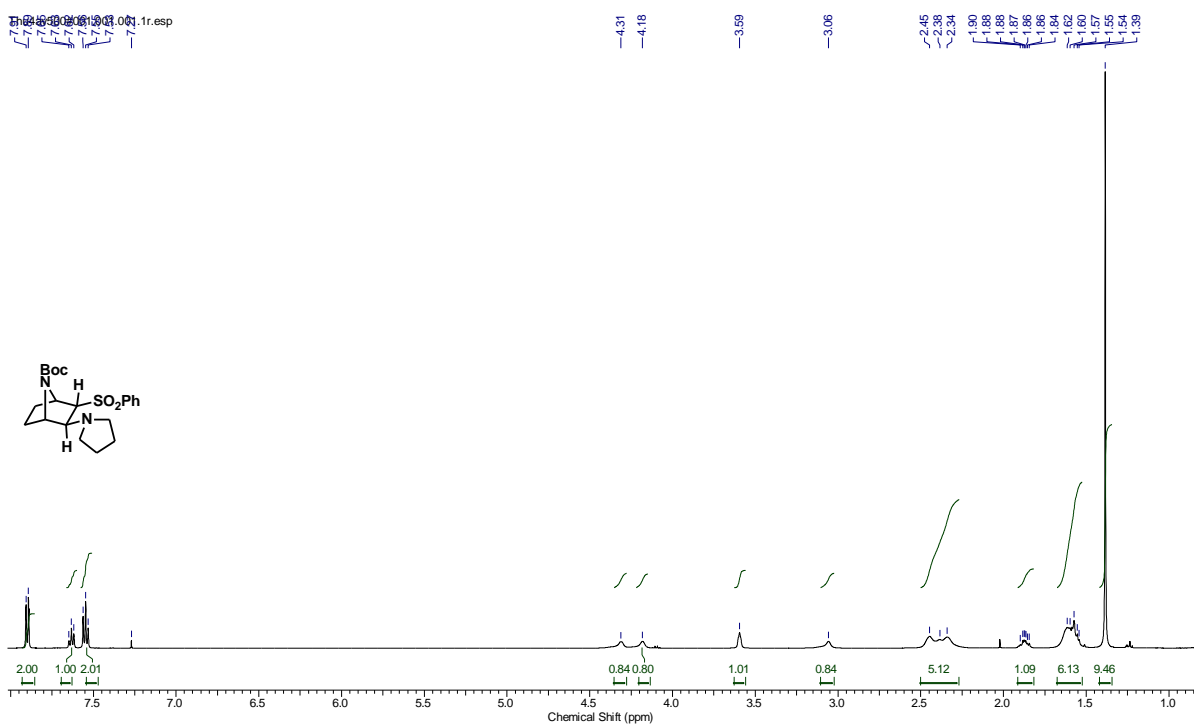

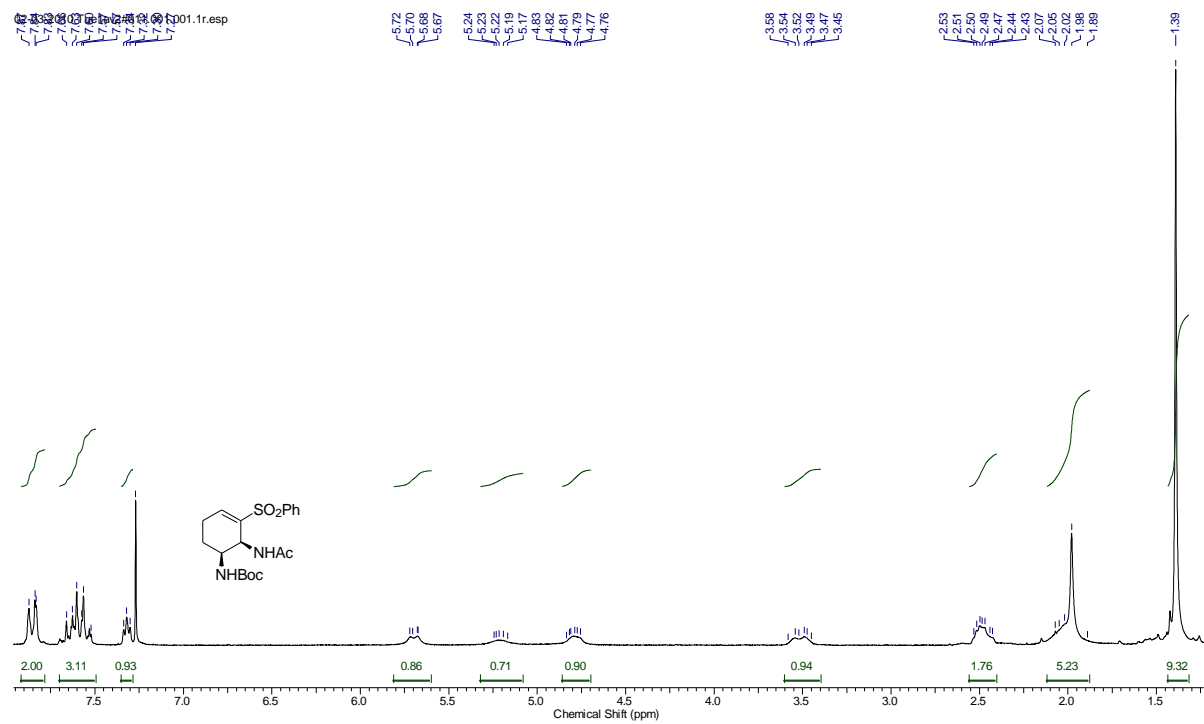
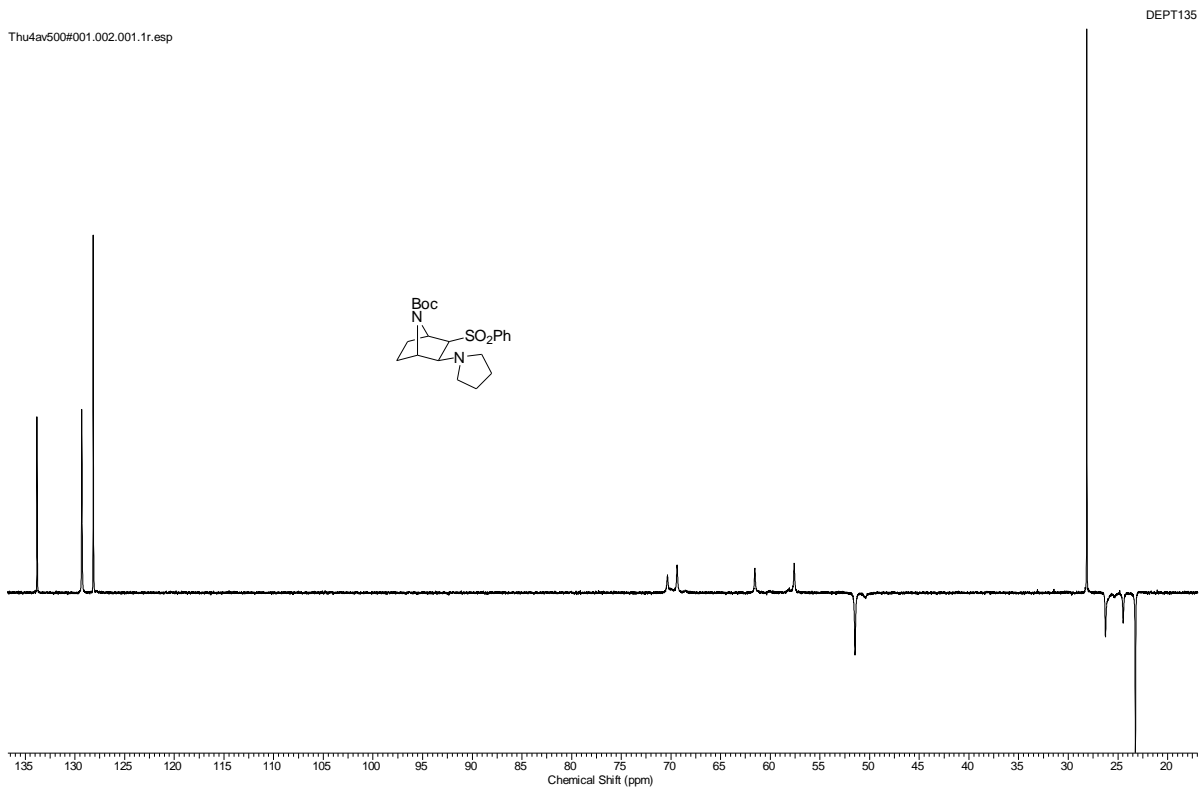

C:\AMAR FILES\SPECTRAS\OSELTAMIVIR SCHEME\acetamide ringopening\02-03-2010 Tue1av2#011\02-03-2010 Tue1av2#011.001.001.1r.esp

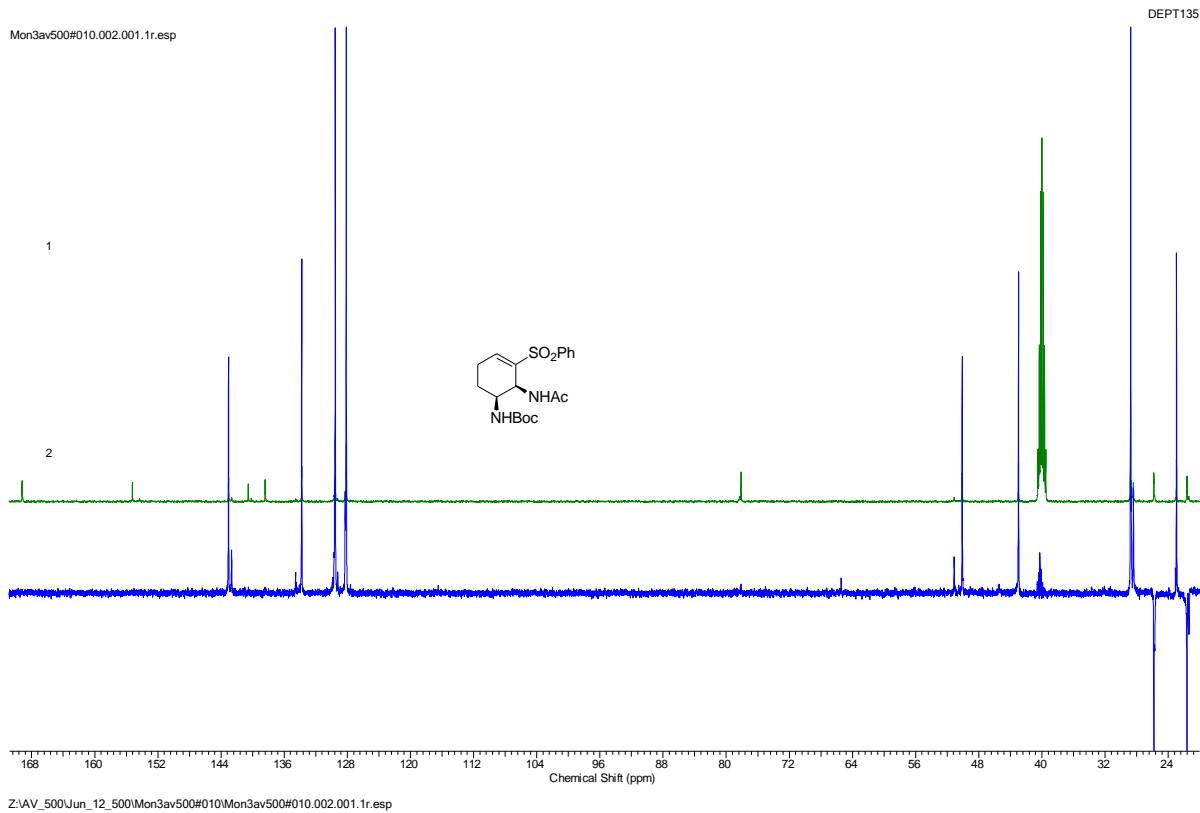
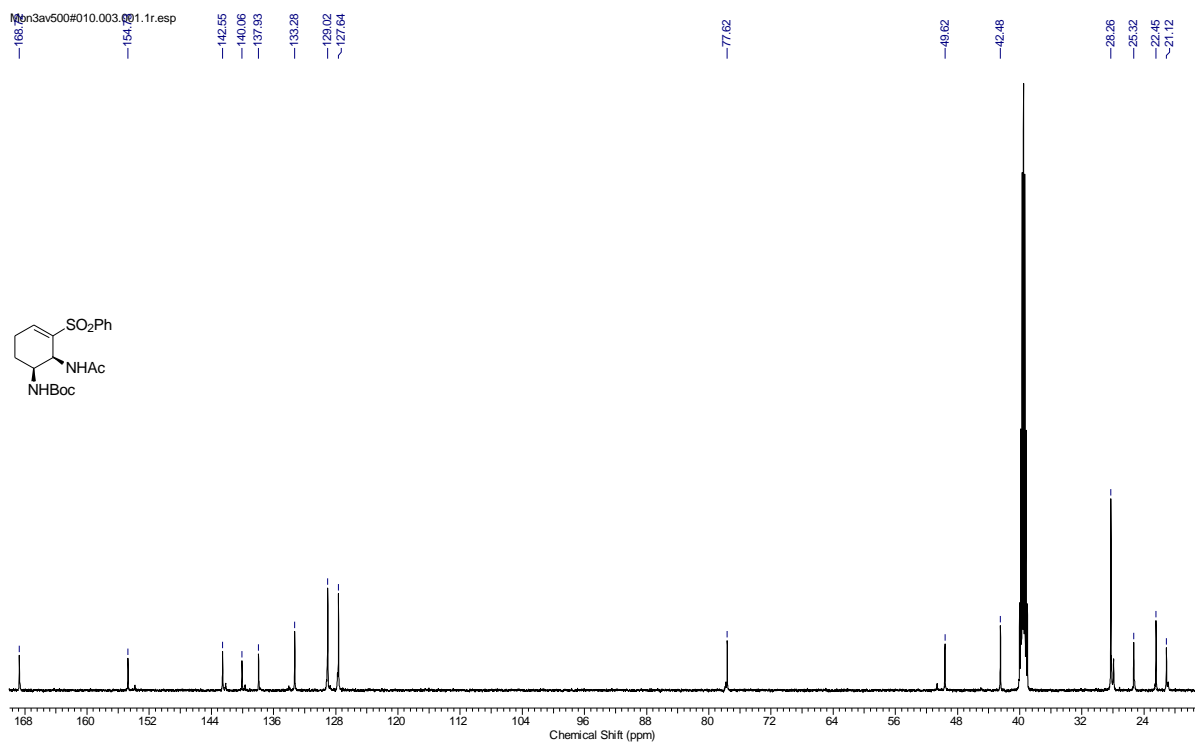

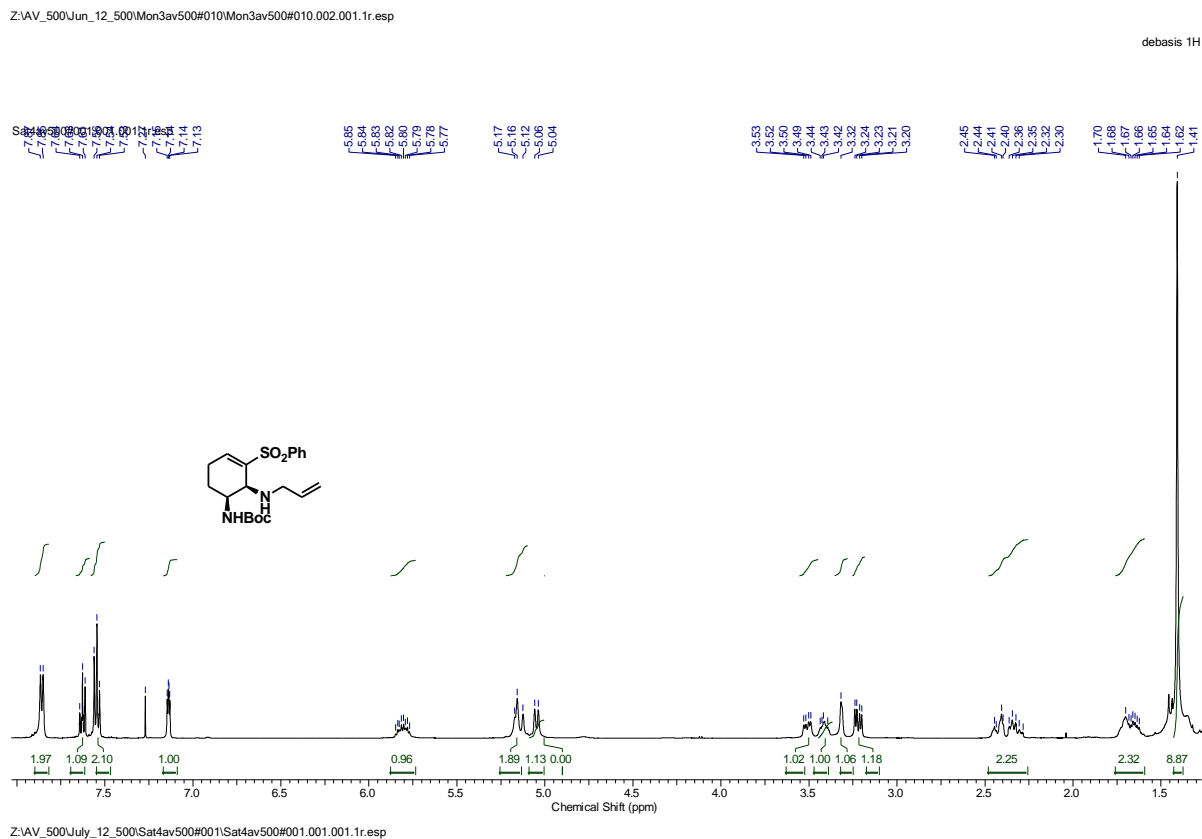
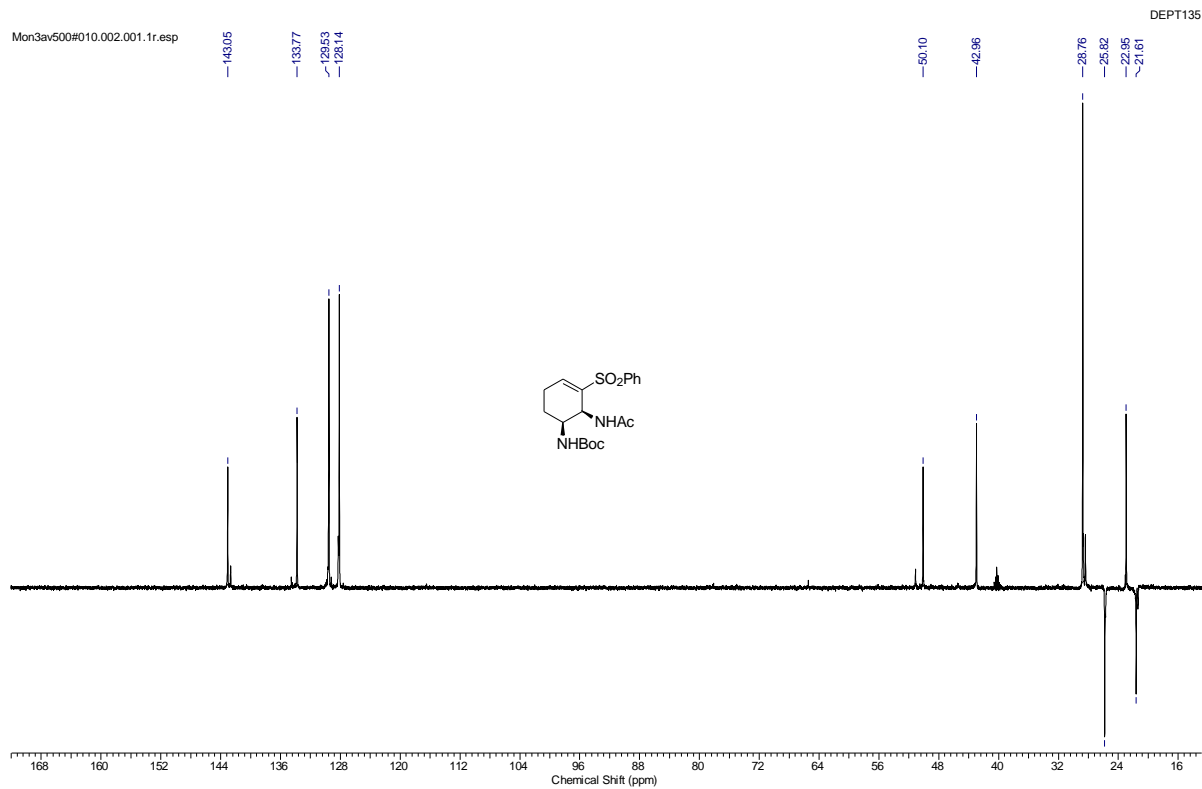

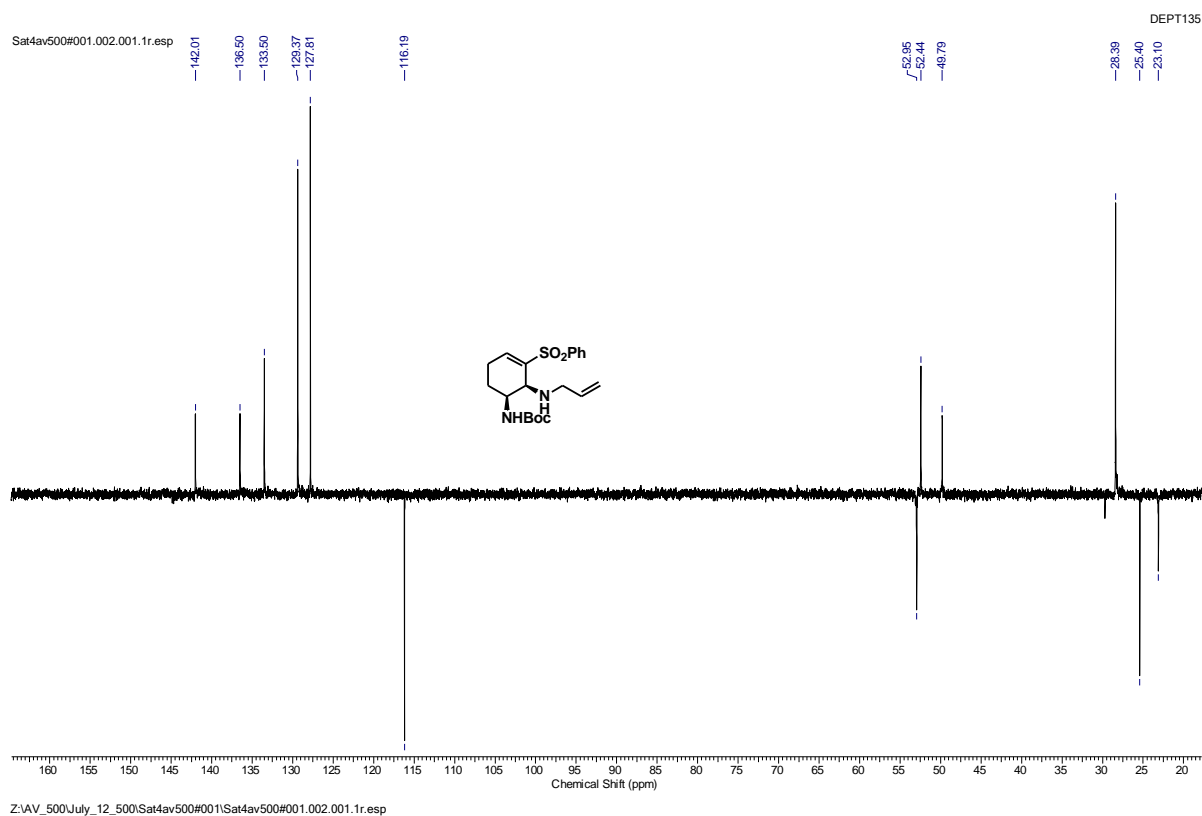
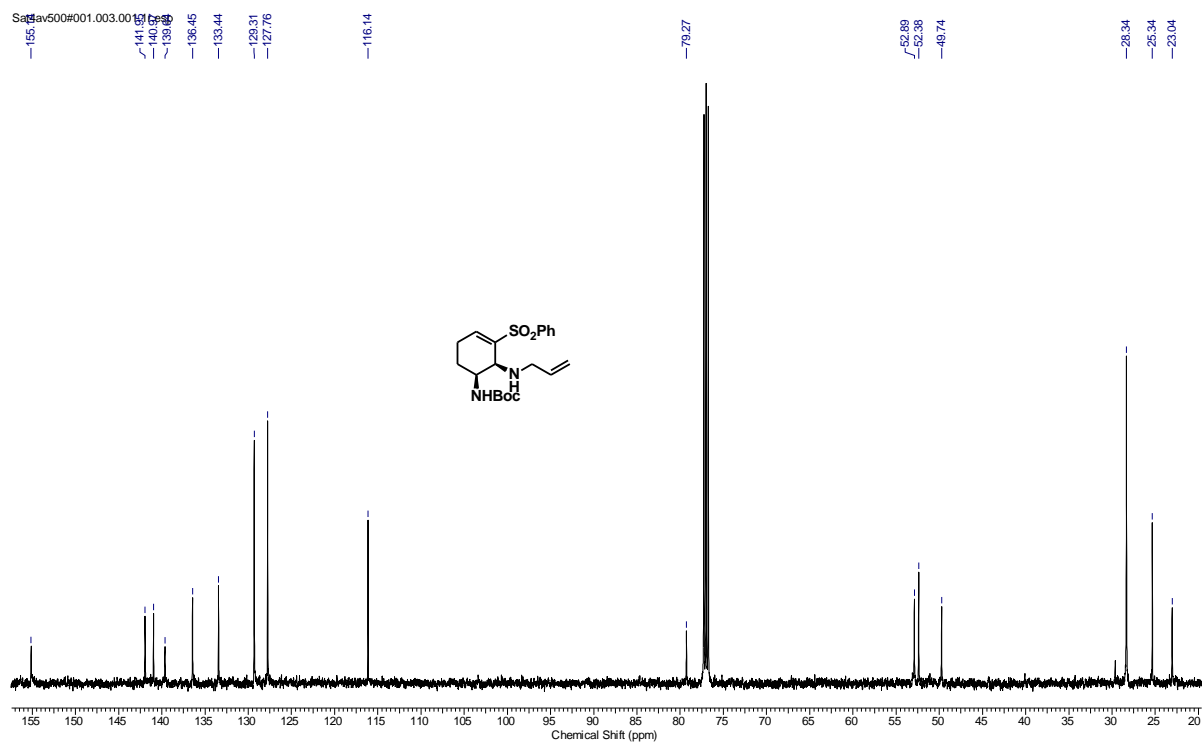

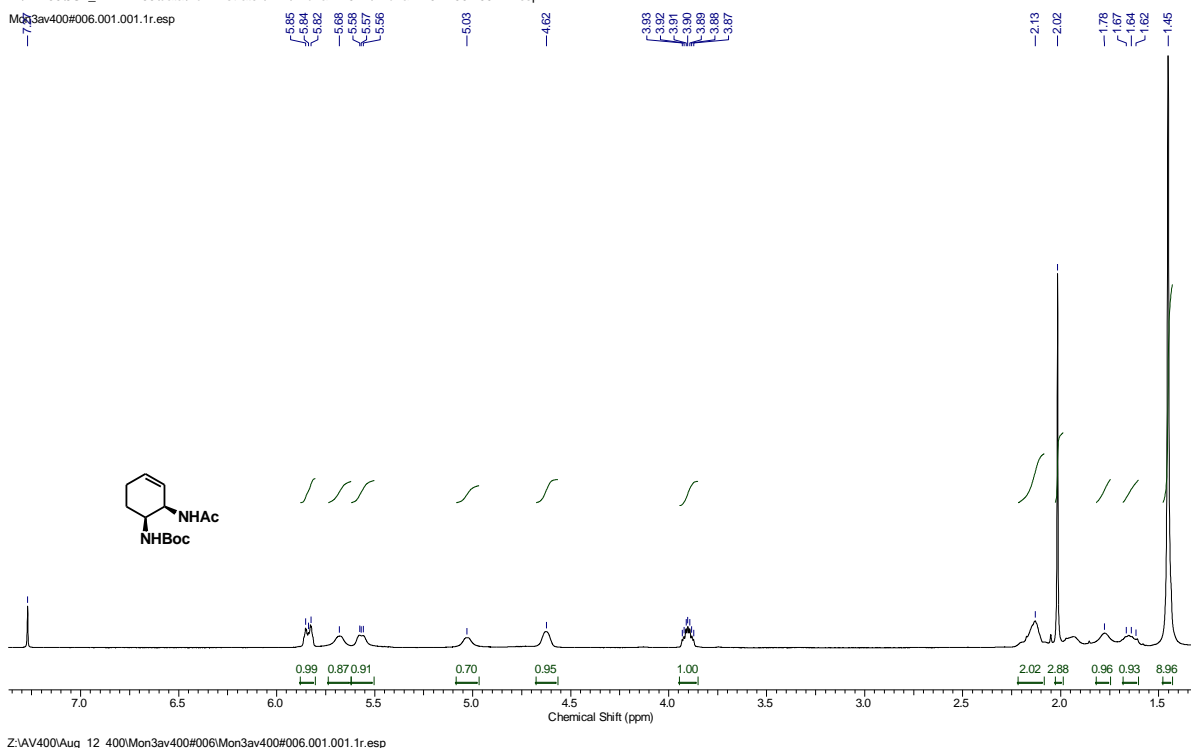
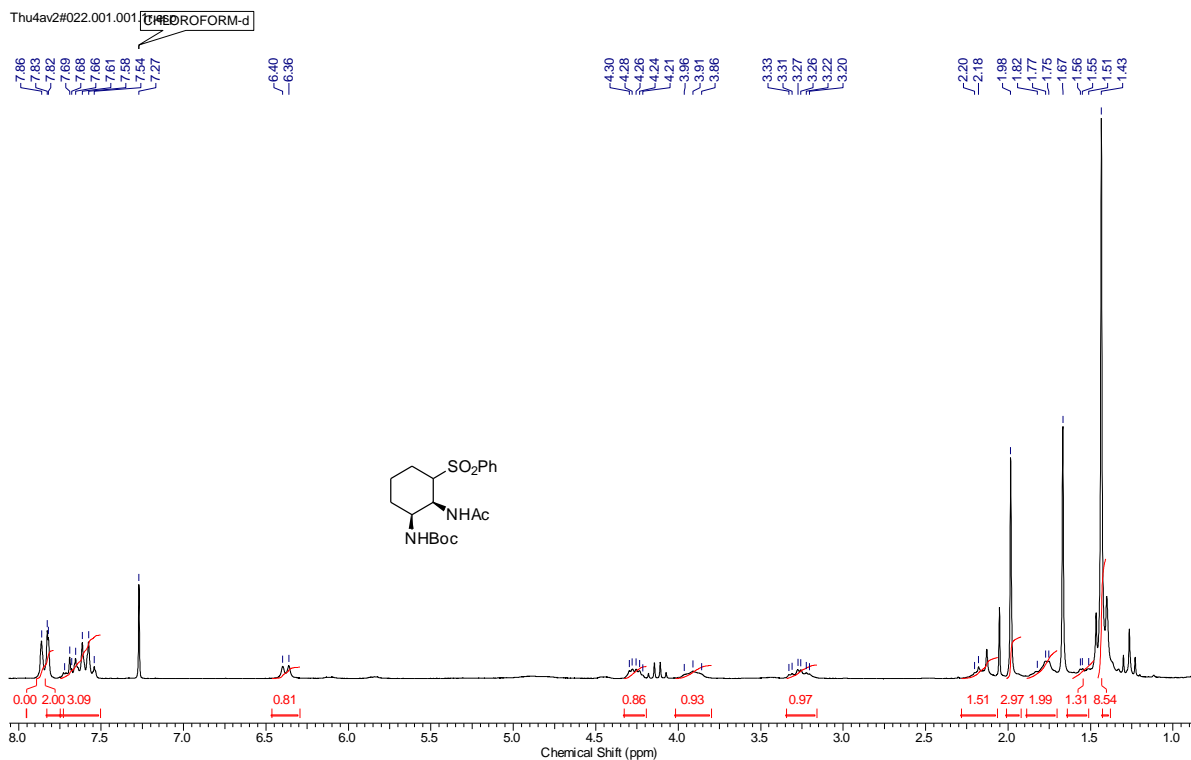

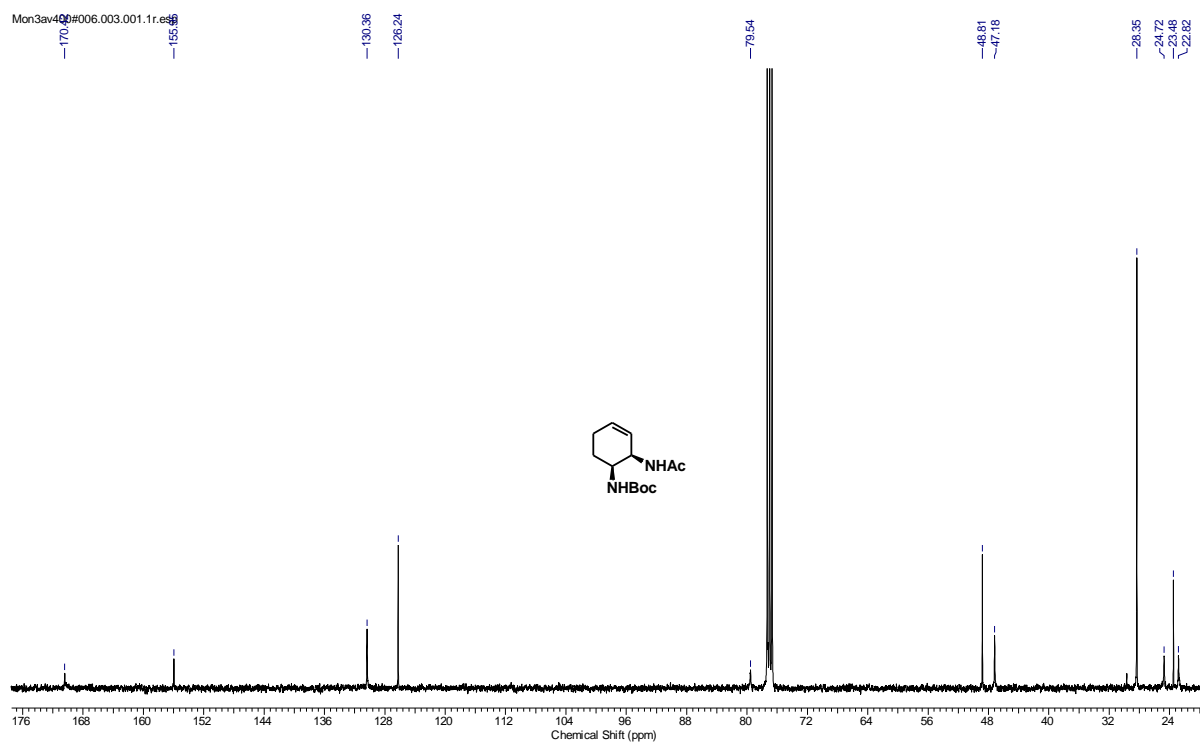

Z:\AV400\Aug_12_400\Mon3av400#006\Mon3av400#006.003.001.1r.esp
Mon3av400#006.002.001.1r.esp

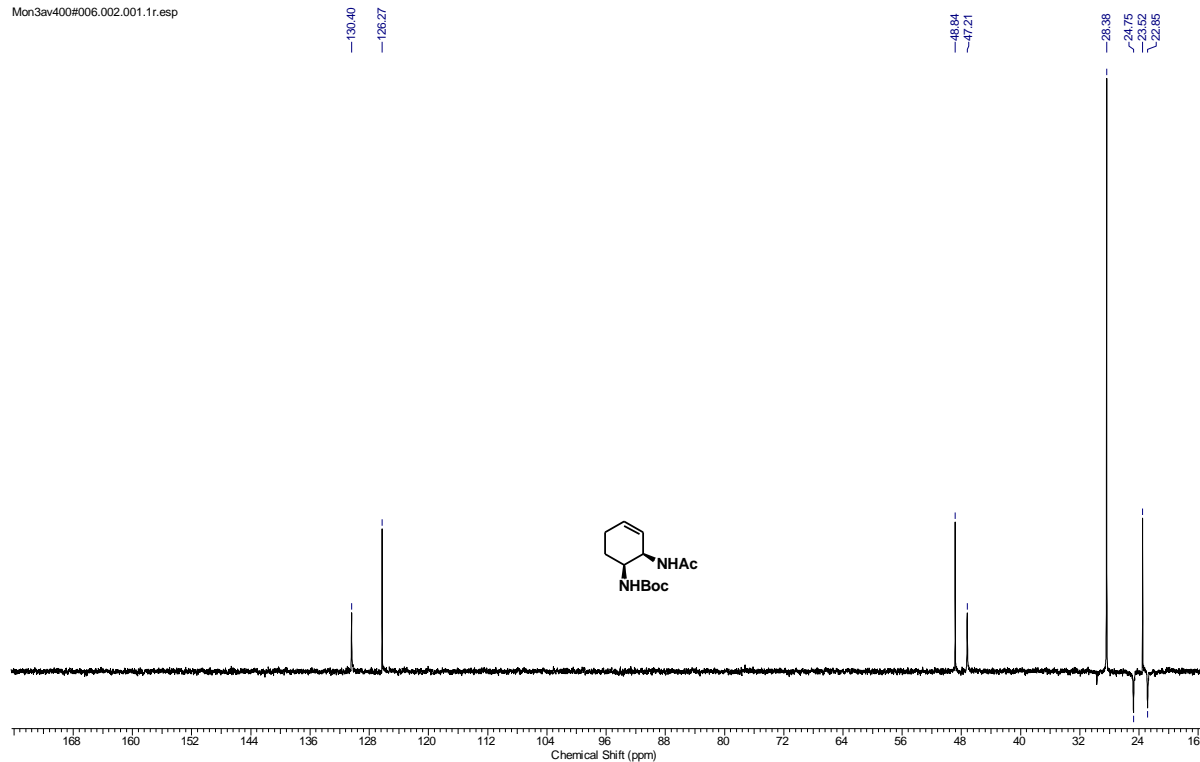

Z:\AV400\Aug_12_400\Mon3av400#006\Mon3av400#006.002.001.1r.esp

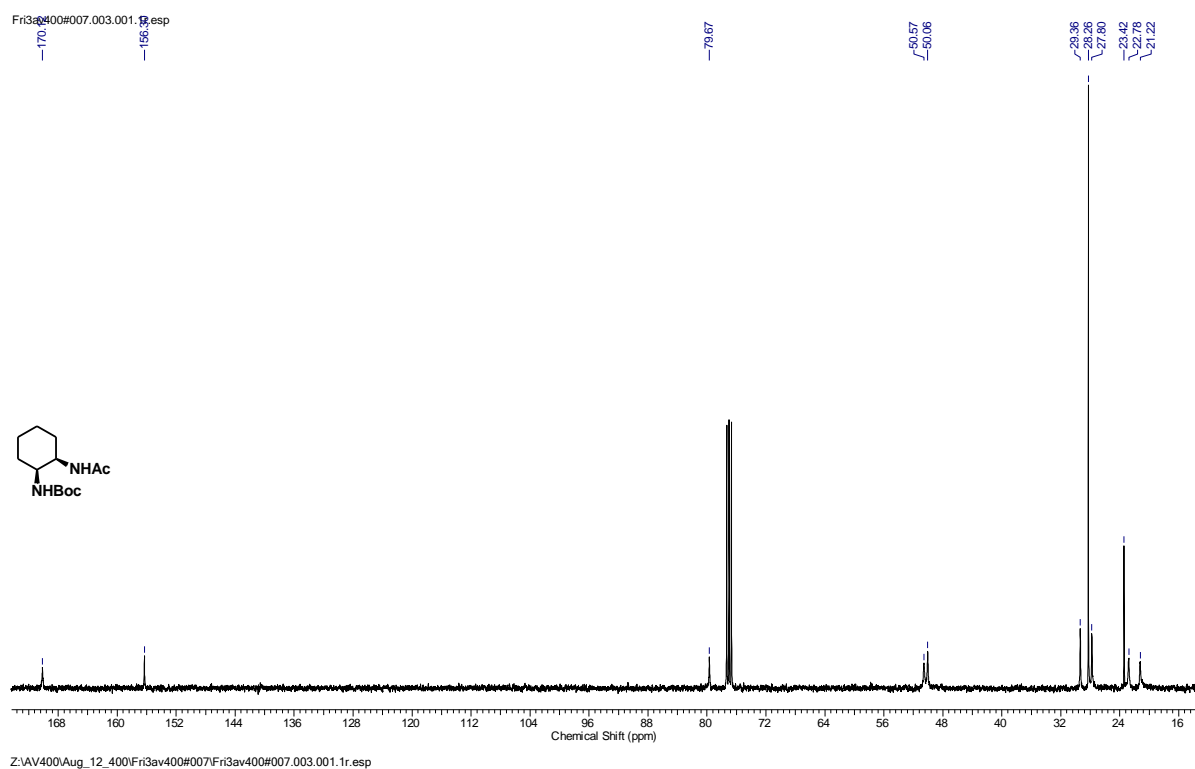
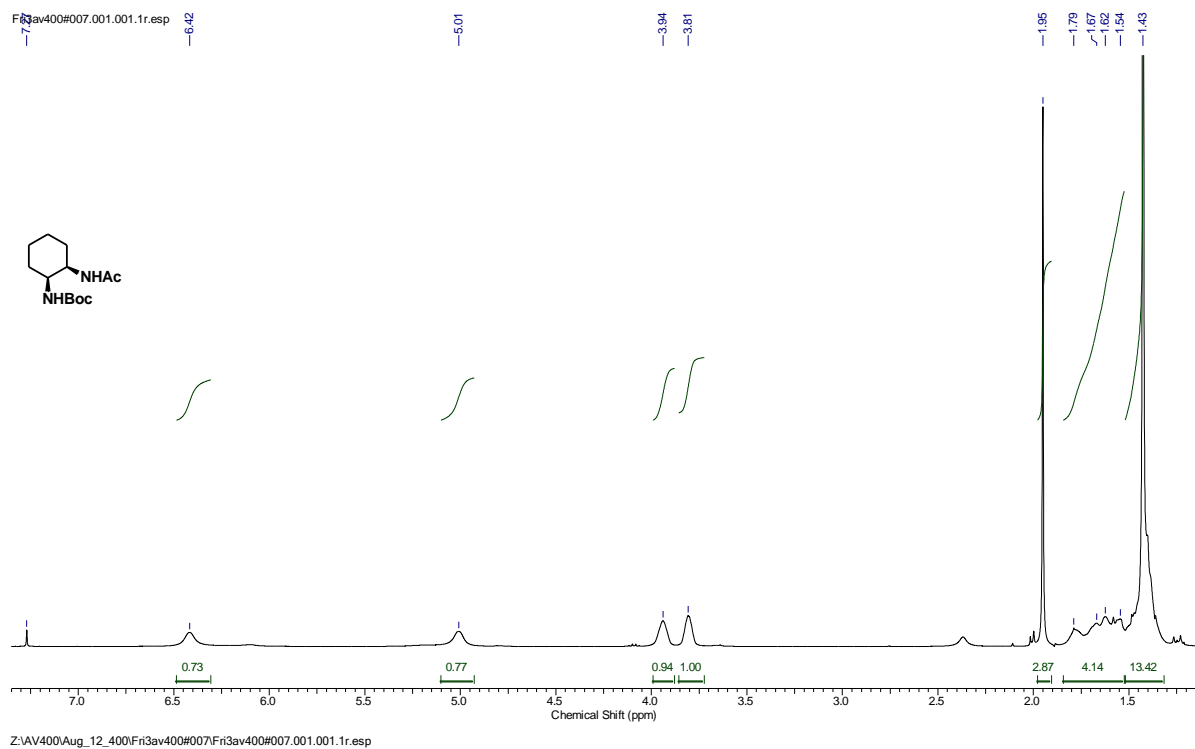

Fri3av400#007.002.001.1r.esp

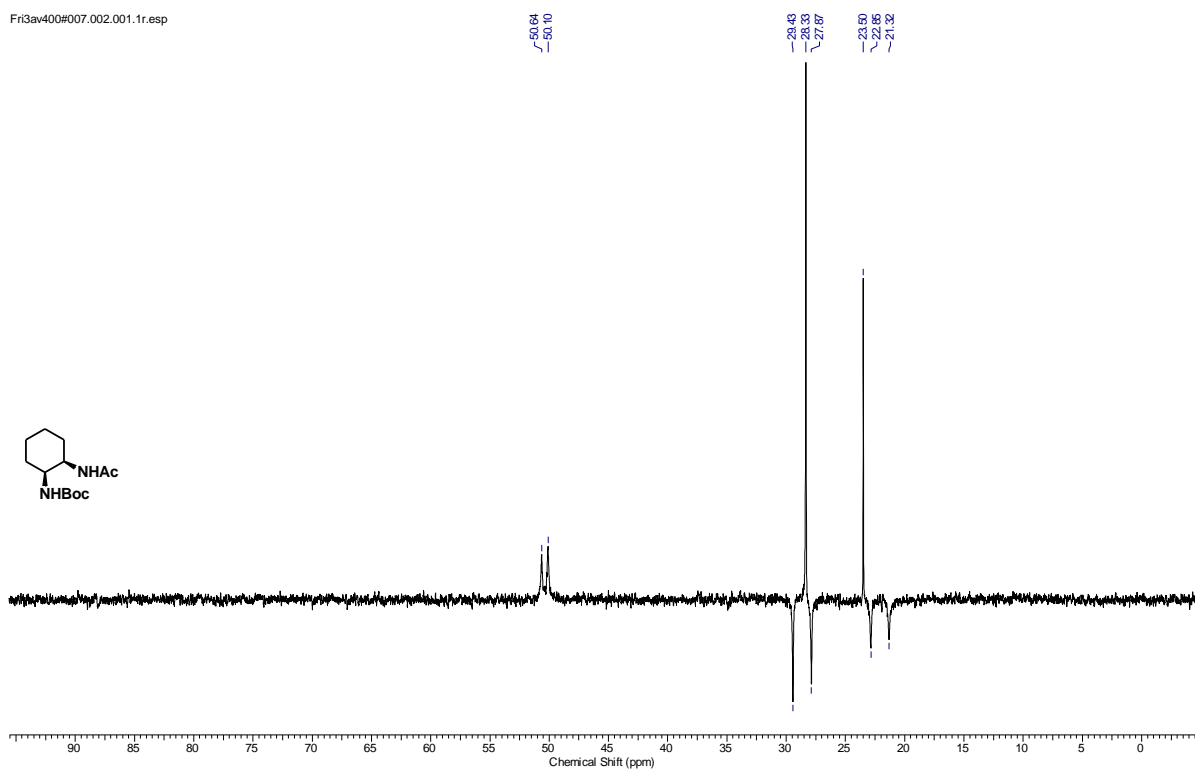

Z:\AV400\Aug_12_400\Fri3av400#007\Fri3av400#007.002.001.1r.esp

Fri3av400#007.002.001.1r.esp

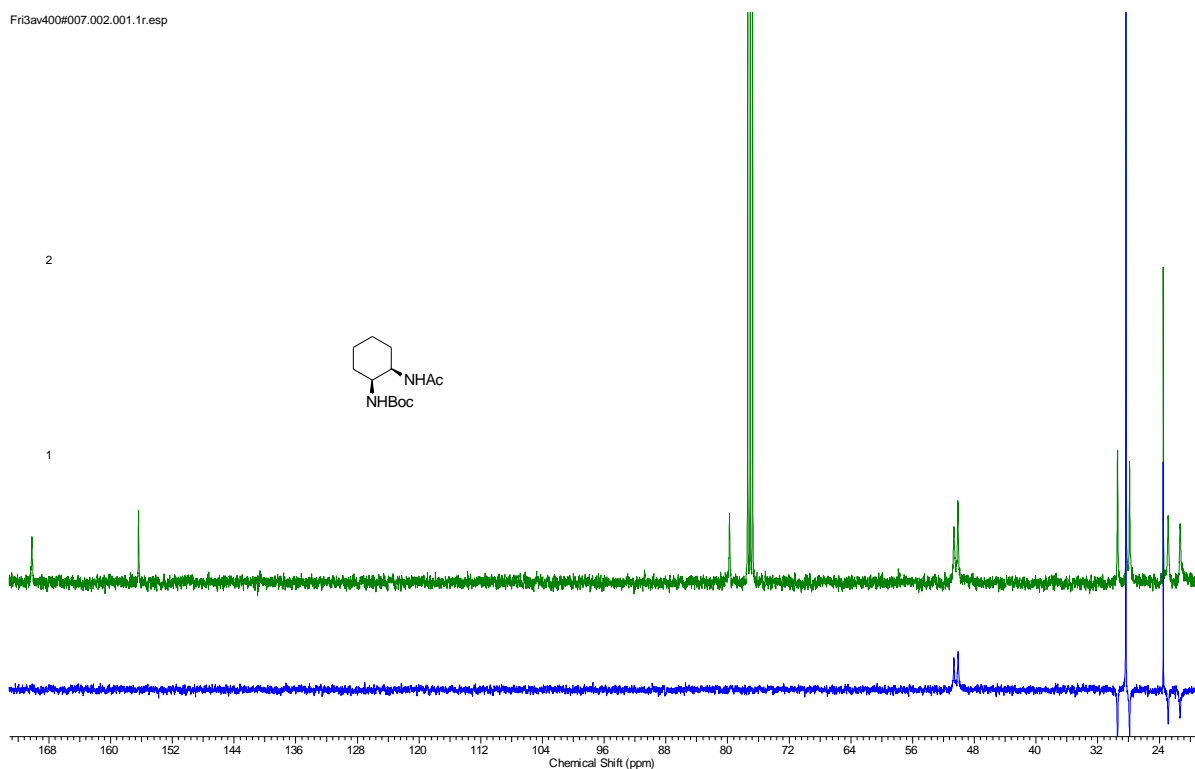

Z:\AV400\Aug_12_400\Fri3av400#007\Fri3av400#007.002.001.1r.esp

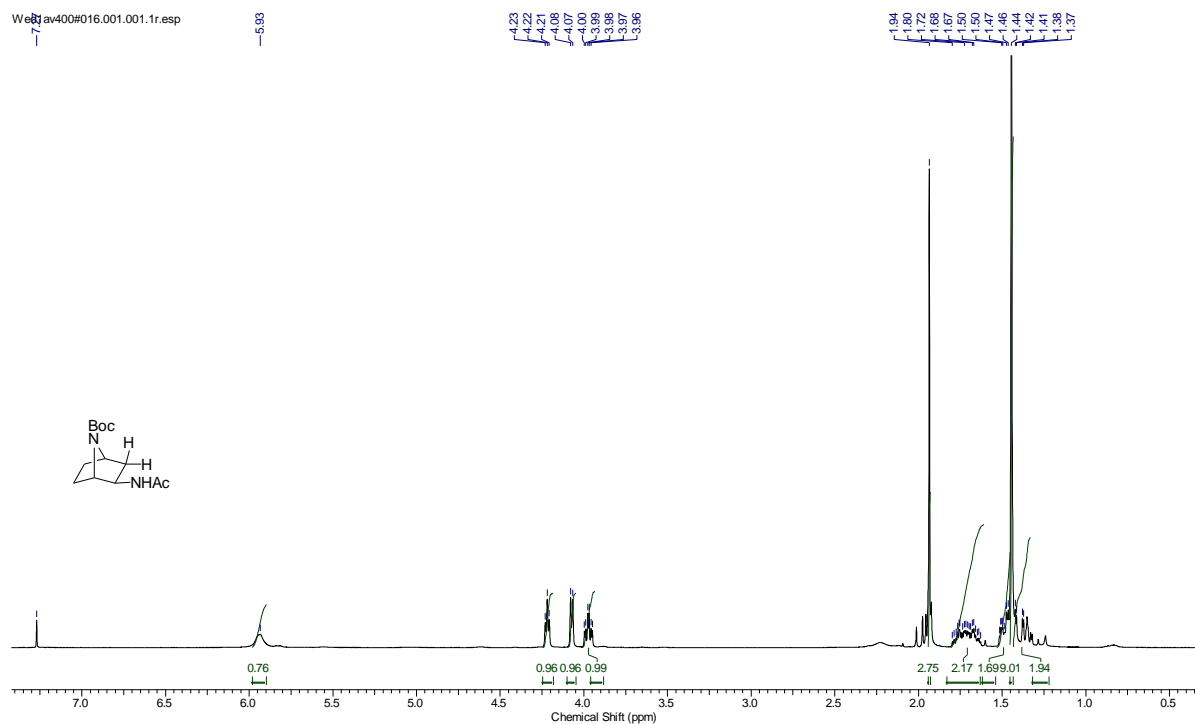

Z:\AV400\July_12_400\Wed1av400#016\Wed1av400#016.001.001.1r.esp

Wed1av400#016.003.001.1r.esp

Chemical structure: CC(=O)N[C@H]1[C@@H](C)N(C(=O)OC(C)(C)C)[C@H]1C

Chemical Shift (ppm)

Z:\AV400\July_12_400\Wed1av400#016\Wed1av400#016.003.001.1r.esp

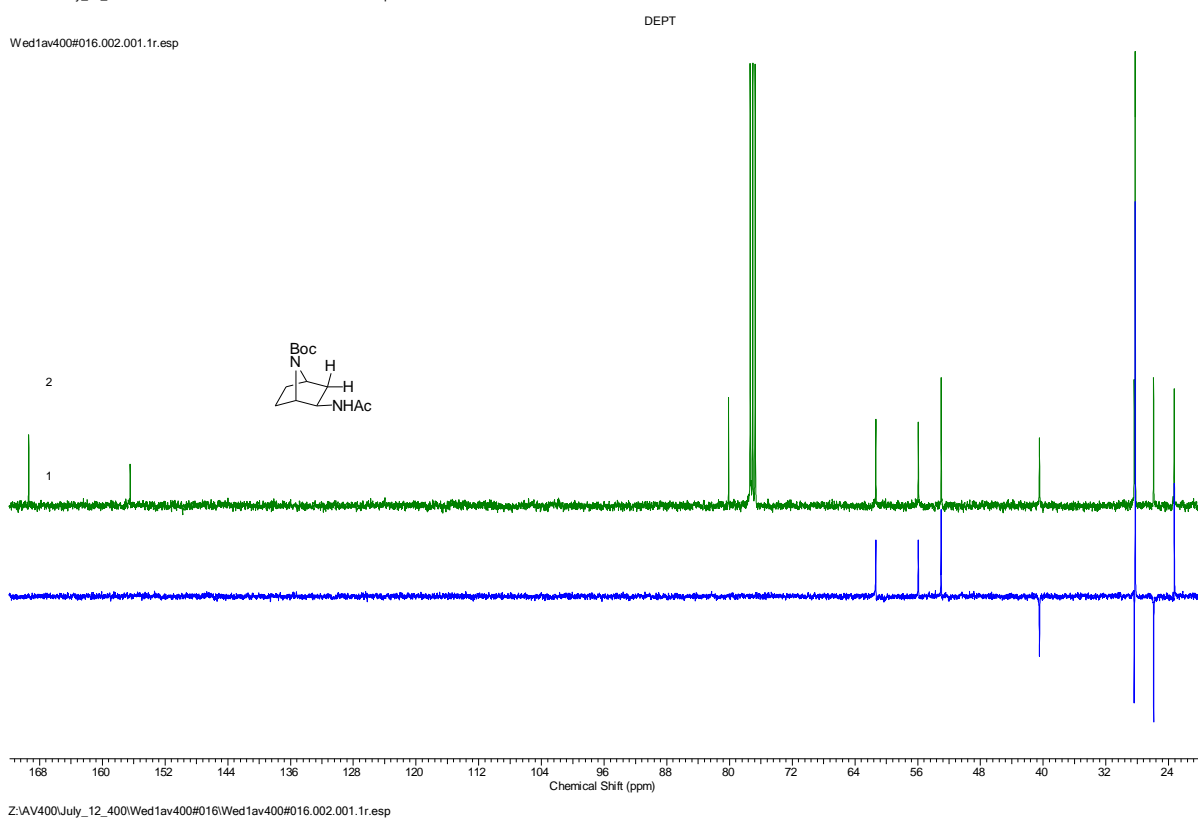
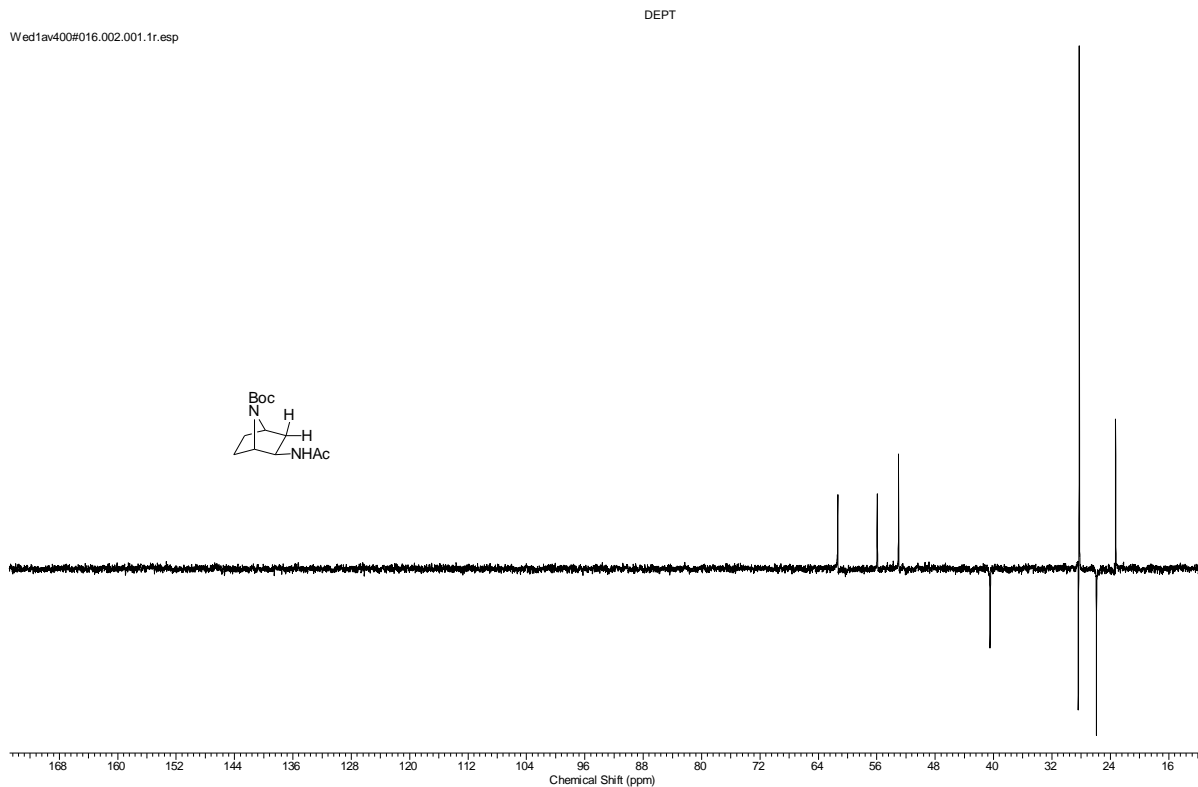

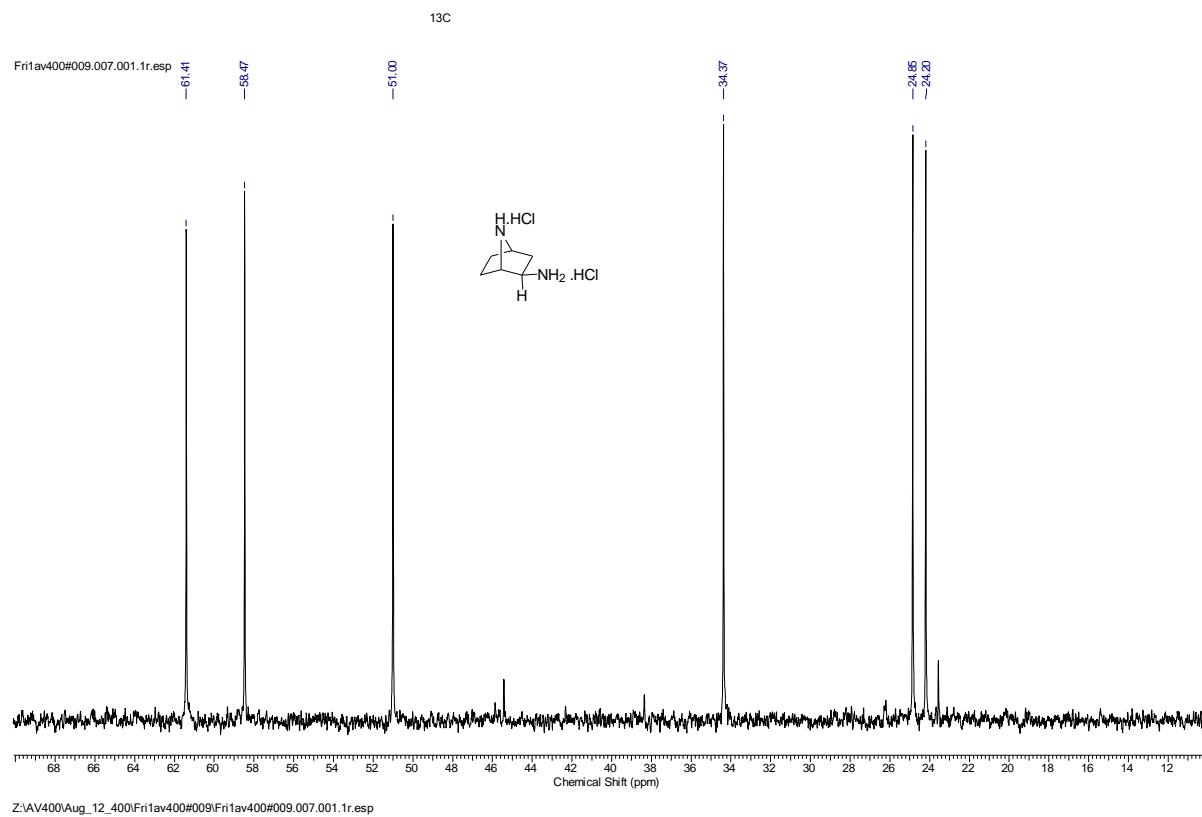
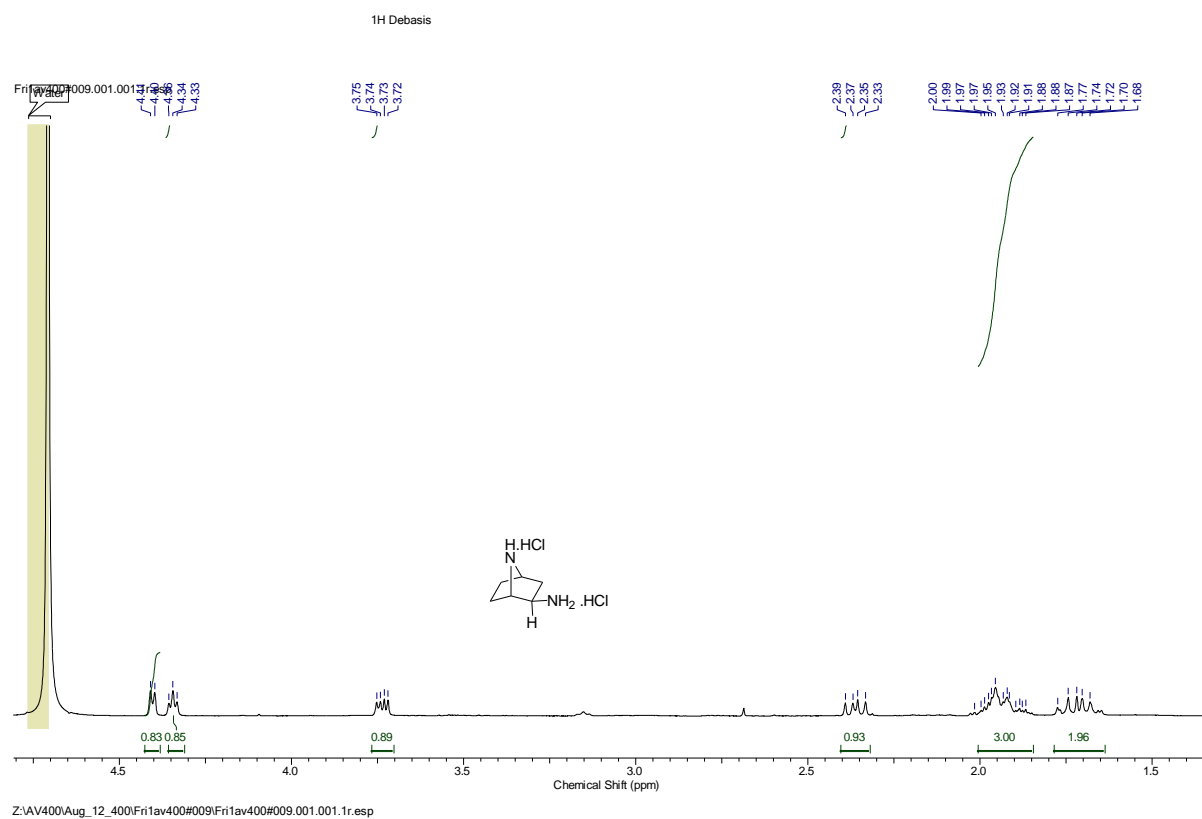

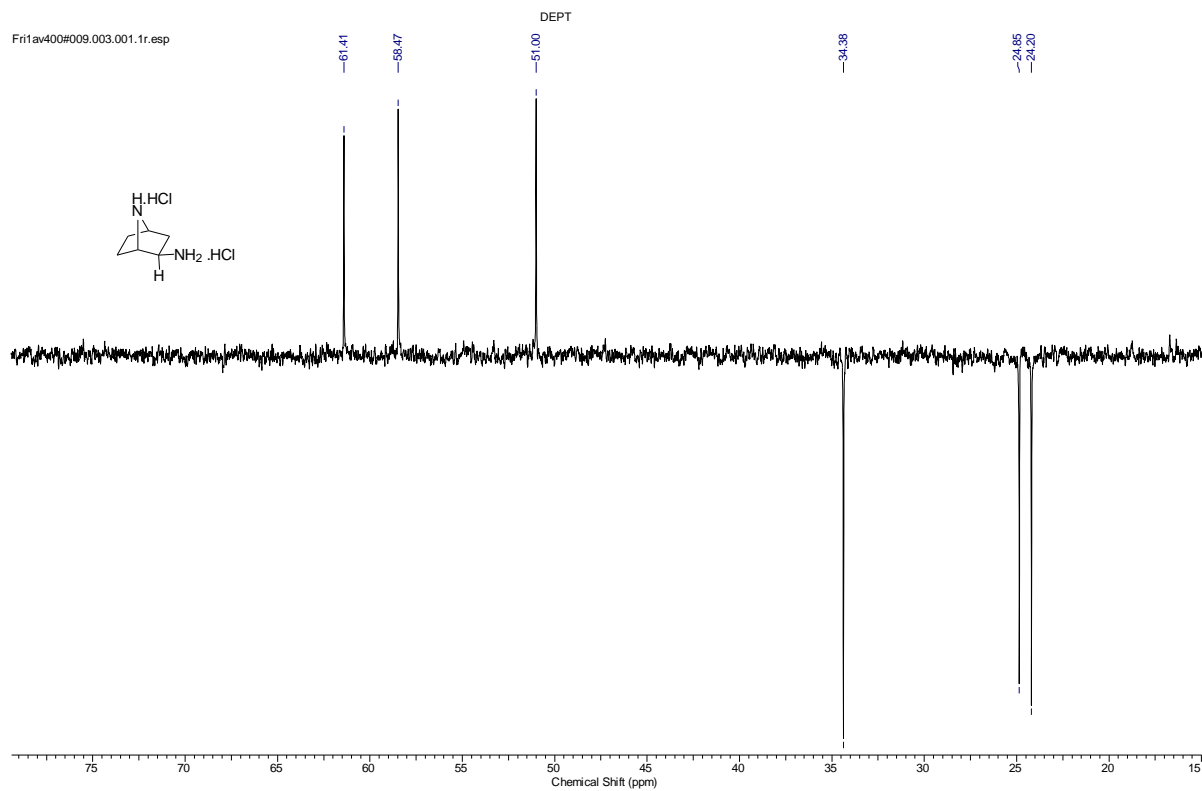

Z:\AV400\Aug_12_400\Fri1av400#009\Fri1av400#009.003.001.1r.esp

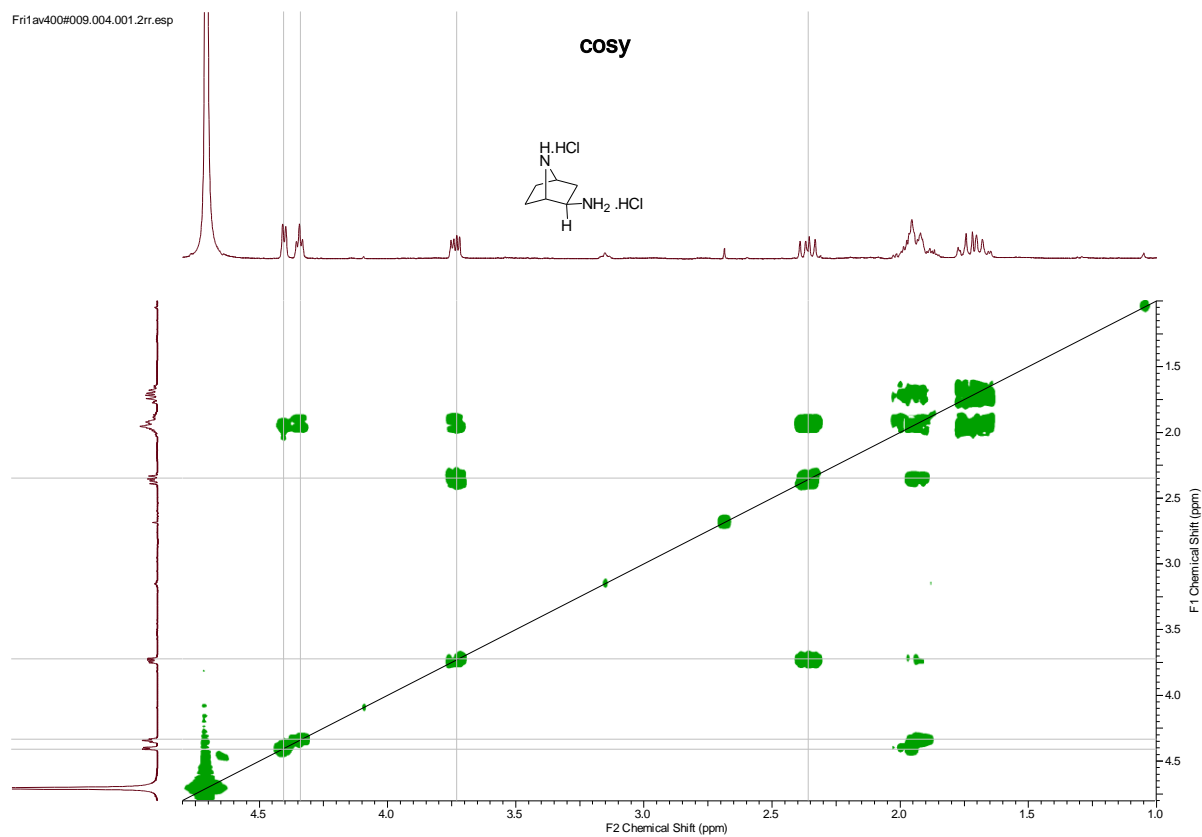

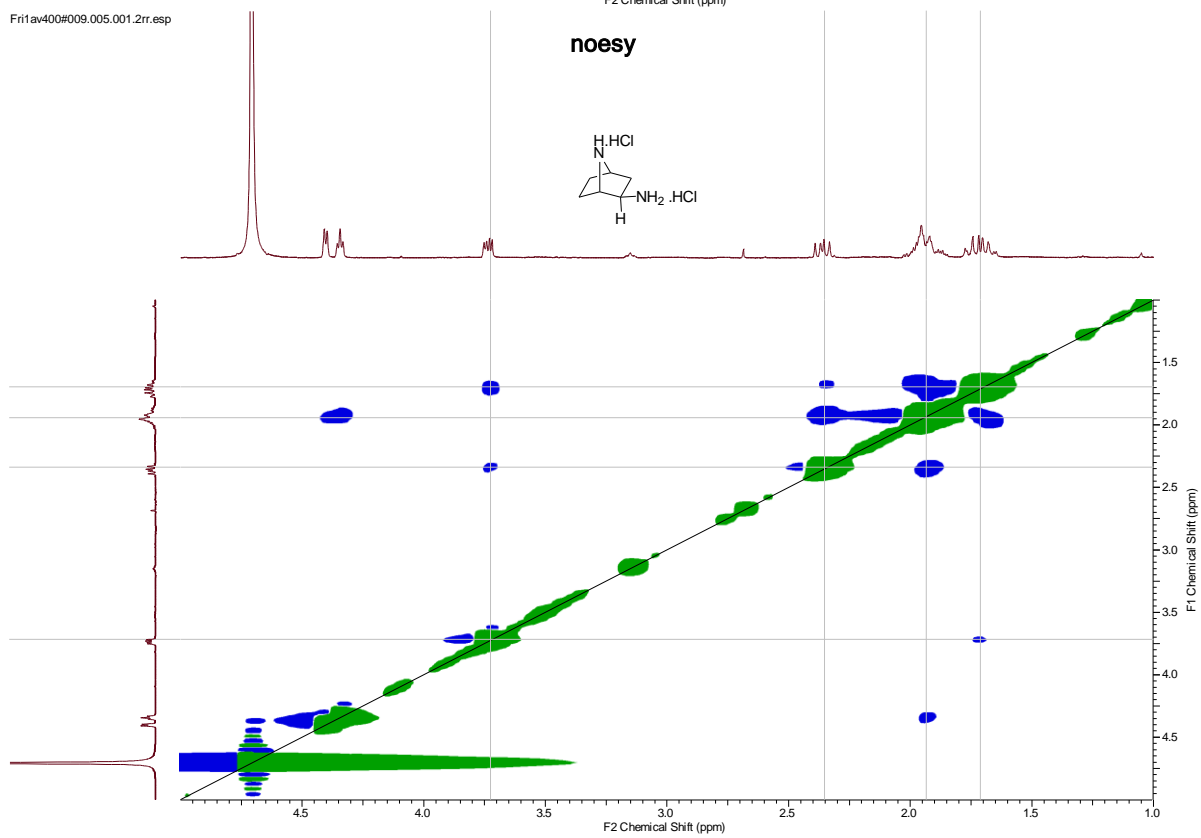
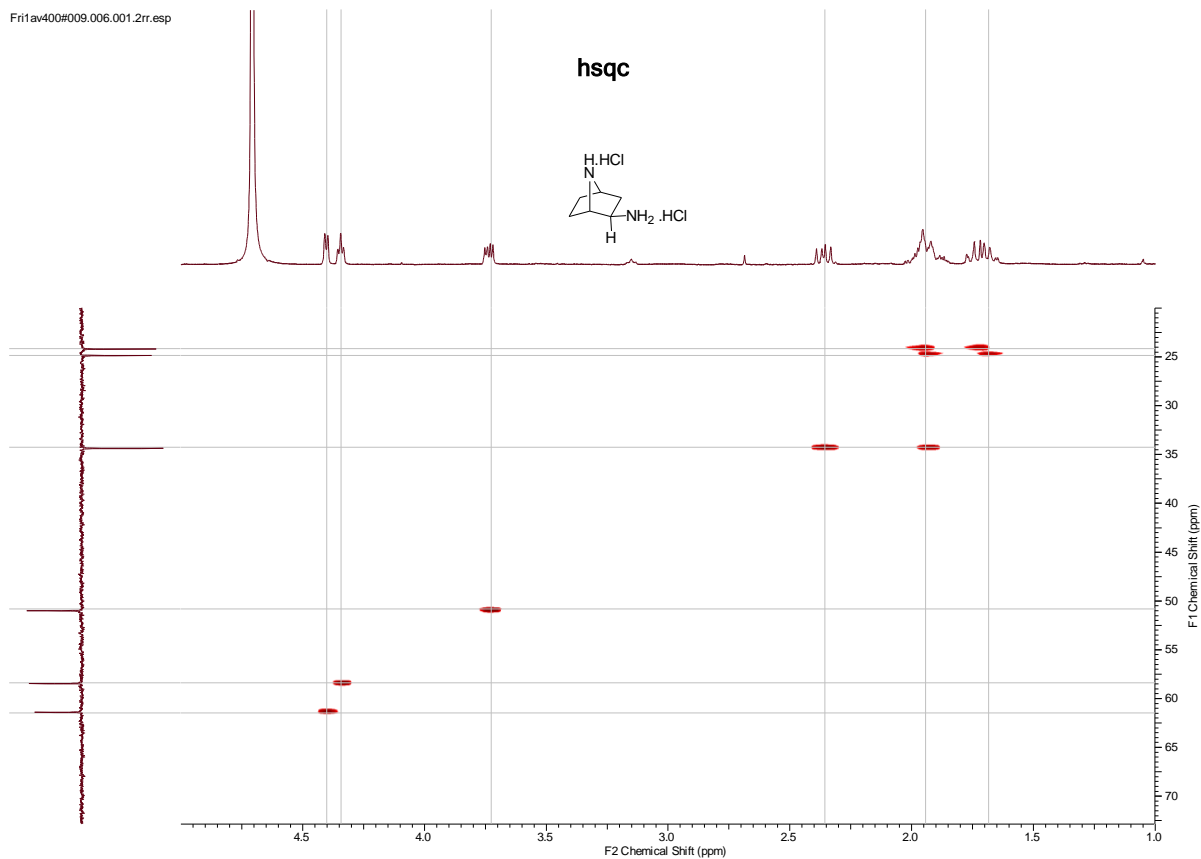

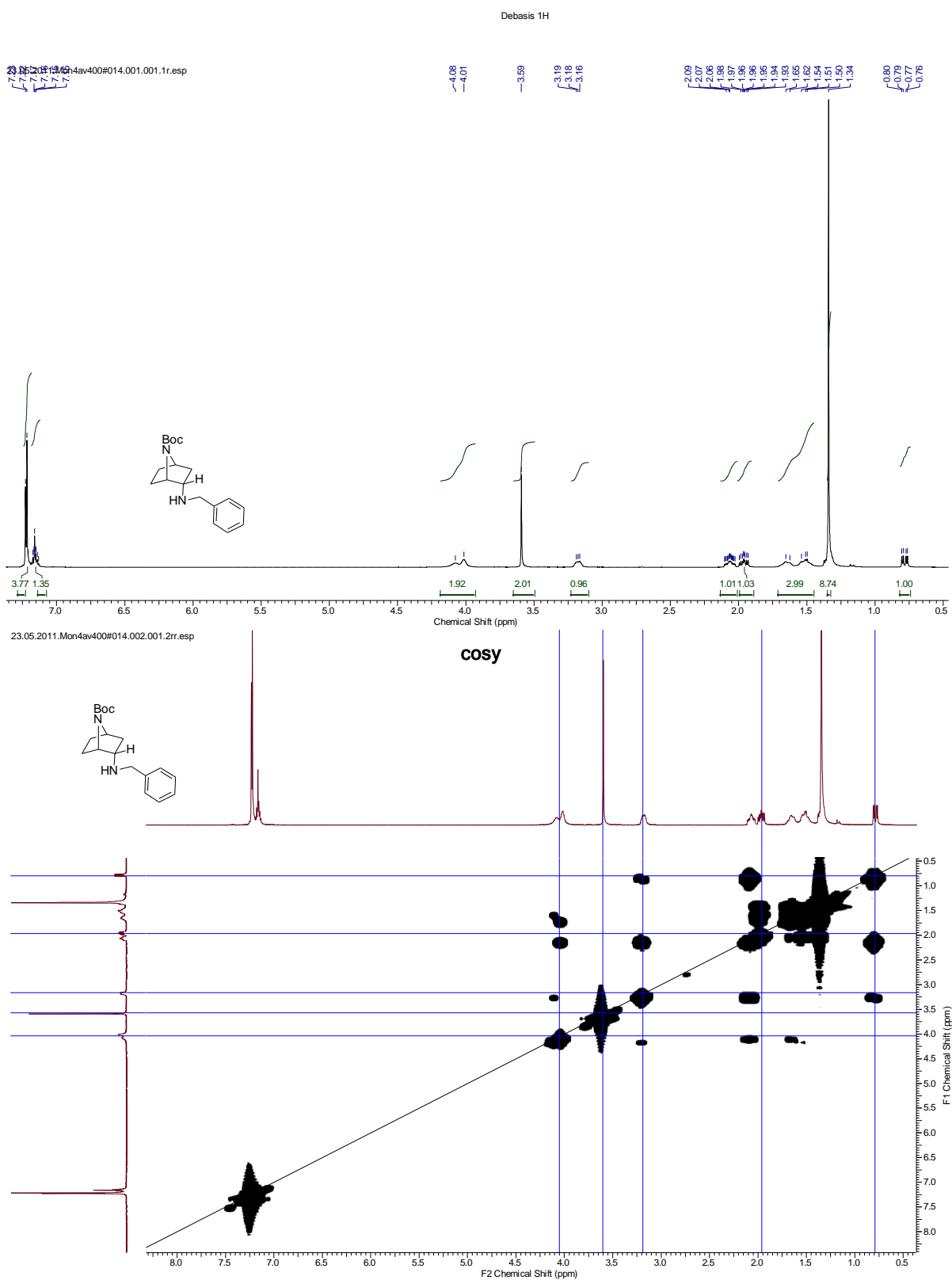

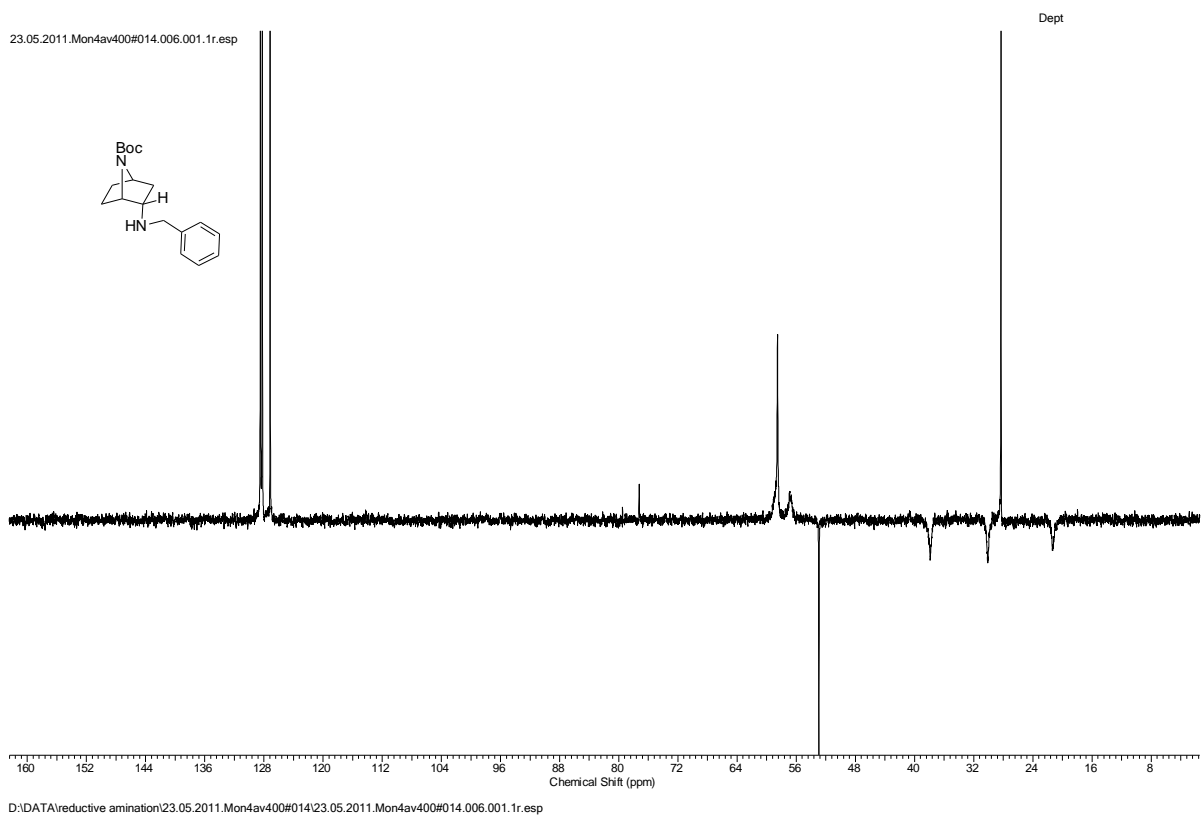
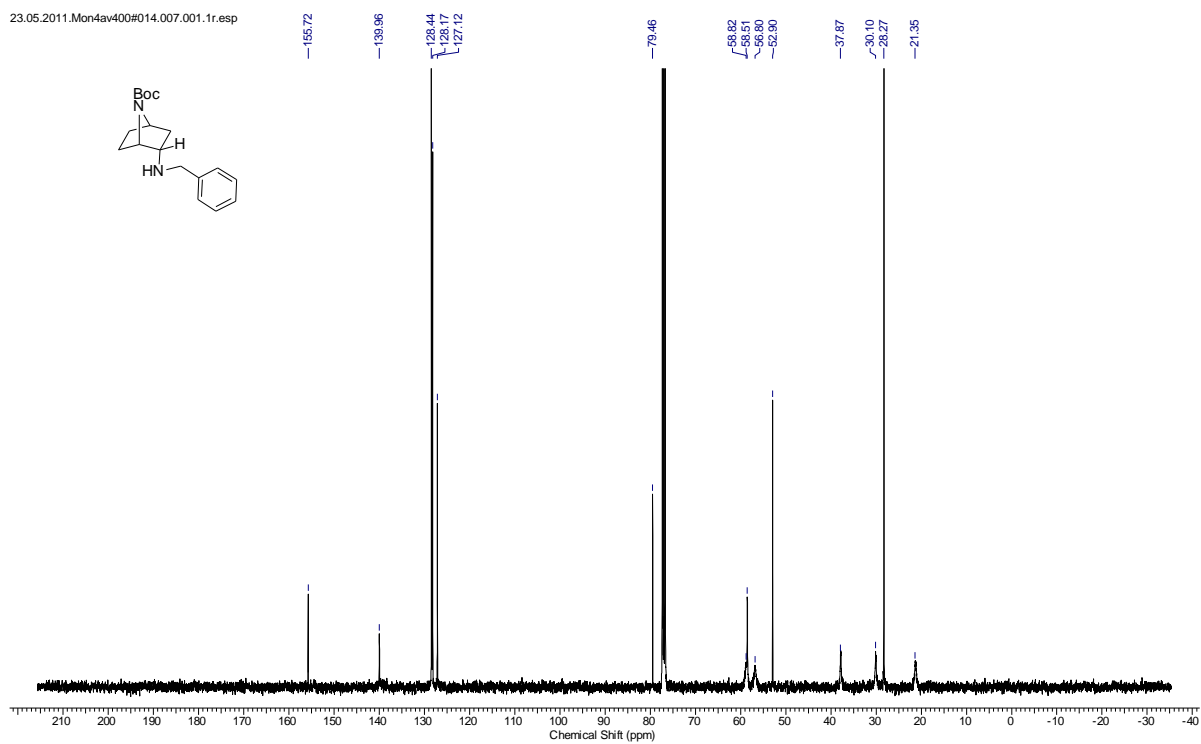

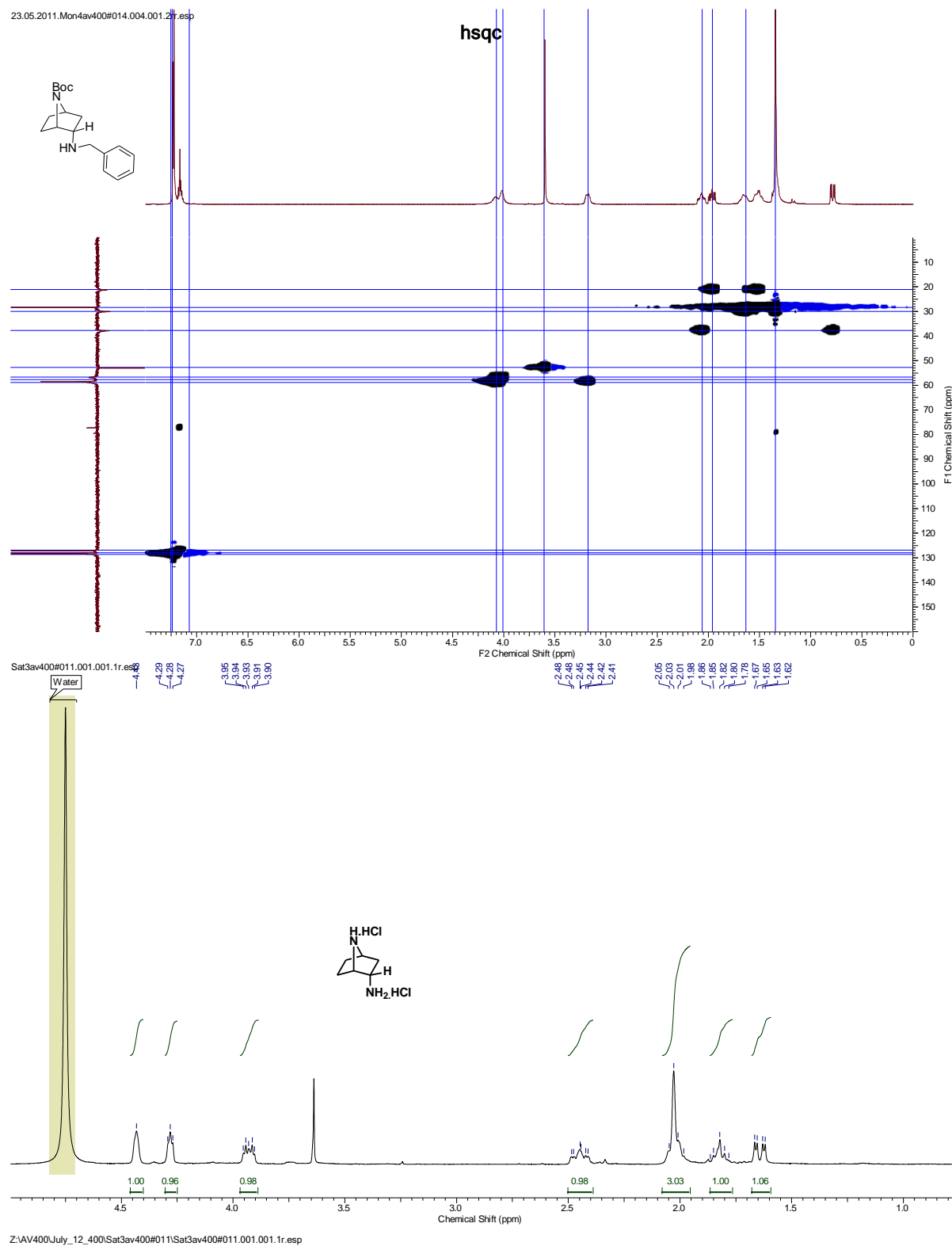

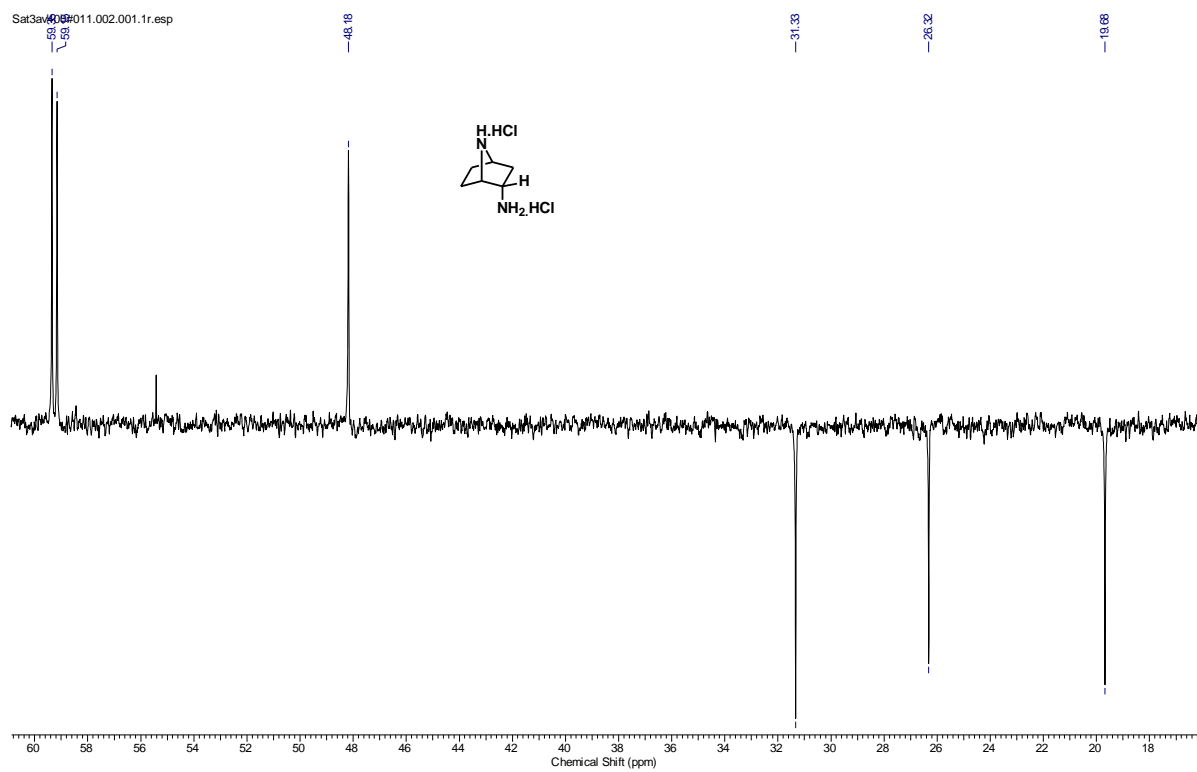

Z:\AV400\July_12_400\Sat3av400#011\Sat3av400#011.002.001.1r.esp

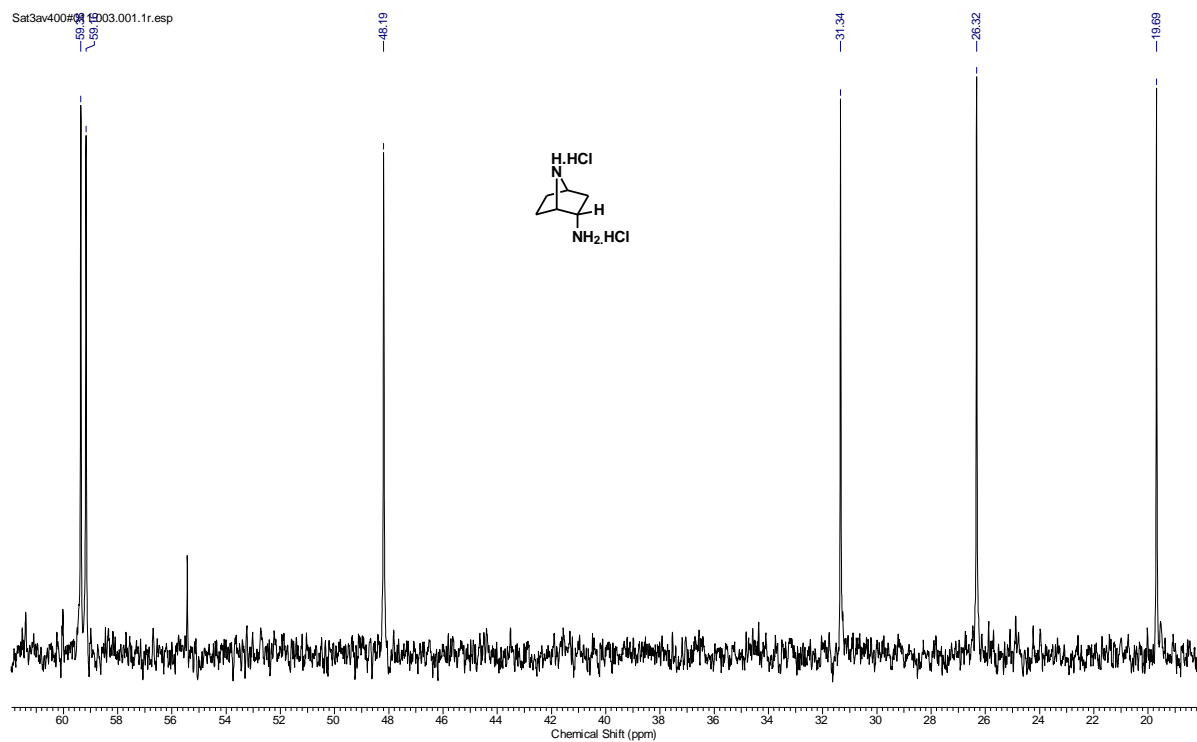

Z:\AV400\July_12_400\Sat3av400#011\Sat3av400#011.003.001.1r.esp

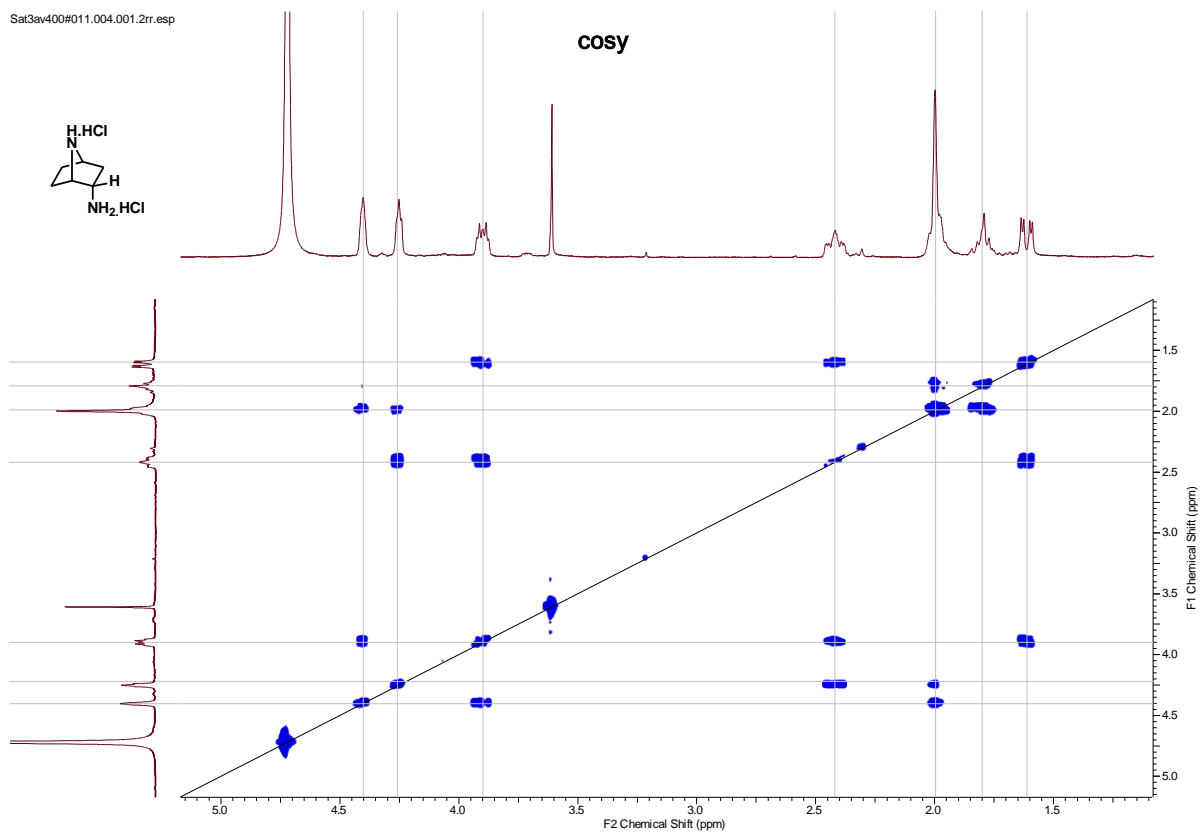
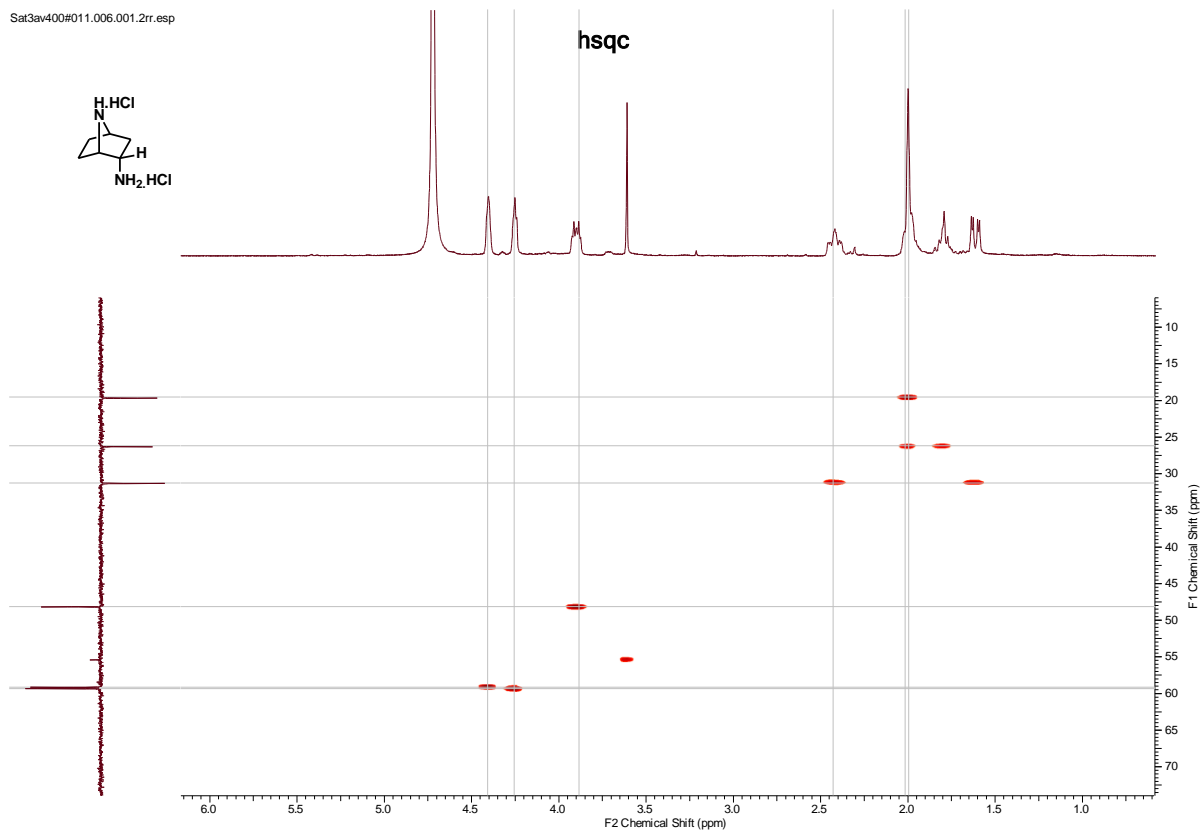

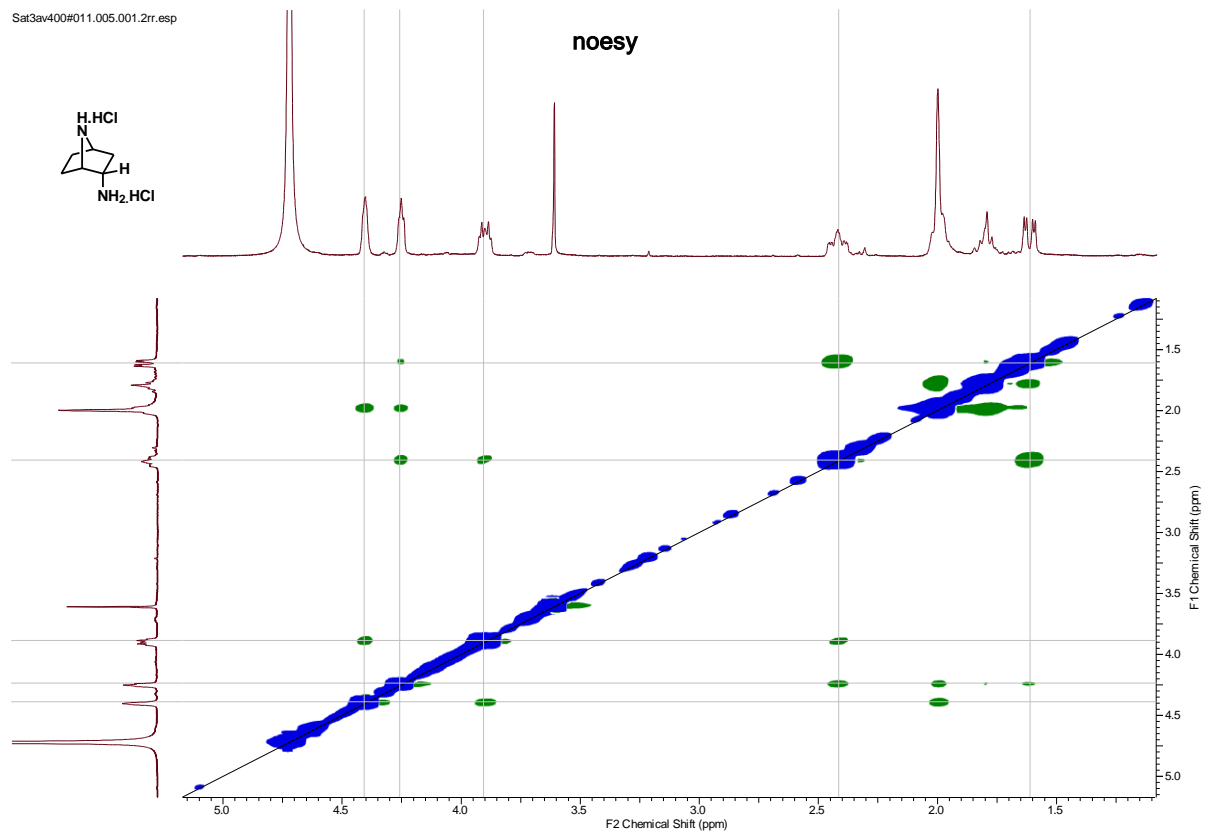

CHAPTER 3:
SYNTHESIS OF AMINOCYCLITOLS UTILIZING 7-
AZABICYCLO [2.2.1]HEPTA-2-ONE AS A CHIRAL
TEMPLATE:

3.1. Introduction:

Cyclic polyhydroxylated amines, more prevalently known as aminocyclitols, are saccharide-like compounds with varied biological activities¹. For example, aminoglycoside antibiotics, representing a clinically important group of drugs that have aminocyclitol core, have achieved extensive therapeutic use throughout the humanity. Because of their close structural relationship with sugars, aminocyclitols are also regarded as aminocarbasugars².

Biochemically, carbasugars and cyclitols themselves are recognized as the pseudo-sugars in a living system, and they show interesting biological activities based on the structural similarity to sugars. The most interesting and significant points for the synthesis of glycosidase inhibitors possessing cyclitols are how one can form the frameworks of the cyclitols and how can the functional groups essential to generate their specific and interesting biological activities be introduced.

Natural aminocyclitols are secondary metabolites found as structural subunits in some complex natural products, such as validamycins, a family of antibiotics isolated from the fermentation broth of *Streptomyces hygroscopius*³. A validamycin **2** is composed of one valienamine unit, together with an additional unit of validamine, valioline or hydroxyvalidamine. The α -amylase inhibitor acarbose **1** is another complex natural product containing an aminocyclitol unit valienamine linked with a trisaccharide (Figure 1).

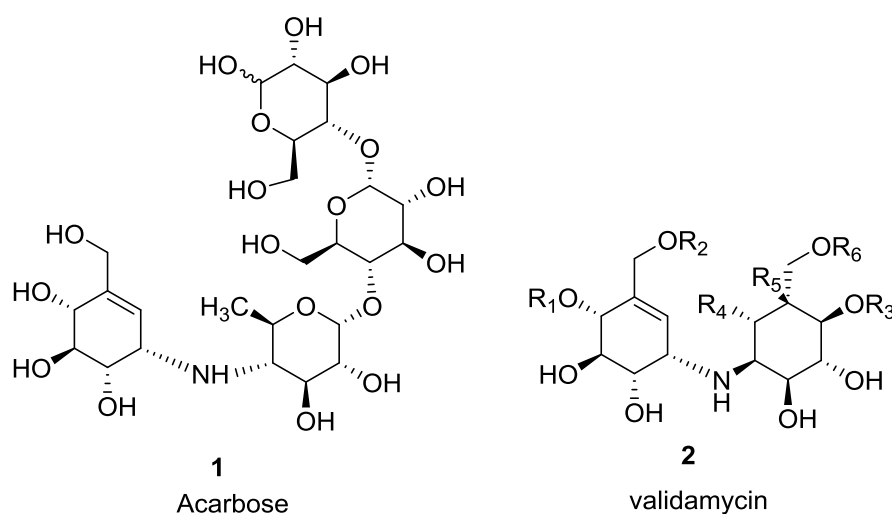

Figure 1. Acarbose and validamycin

Owing to the protonation of their amino group at physiological pH, aminocyclitols are believed to mimic the transition state in the enzymatic glycoside hydrolysis. In parallel, hundreds of analogs have been synthesized and tested as inhibitors of glycosidase enzymes besides being used as biosynthetic building blocks in many antibiotics.

Compounds with obvious structural similarity to a carbohydrate skeleton are a new class of inhibitors and the elucidation of their mechanism of action may add new insights in the search for new therapeutic agents. Conduramines as well as aminocarbasugars, due to their structural similarity, are a family of carbohydrate mimics which have attracted a great deal of attention among organic and medicinal chemists due to their profound biological activities towards glycosidases. The polyhydroxy glycosidase inhibitors are a widely diverse class of compounds often isolated from plants and microorganisms and they have significant therapeutic use or potential. Current interest in these compounds has been extended to a diverse range of diseases including lysosomal storage disorders and cancer, and special attention has been given to those compounds with anti-HIV activity. Isolation of suitable glucosidase inhibitors from natural sources or their chemical synthesis provides biochemical tools for the elucidation of the mechanistic activity of enzyme through the use of kinetic data combined with variations in potential inhibitor structural information. Such knowledge is fundamental to the discovery of lead compounds, because of their promising therapeutic potential.

Aminocyclitols and diamincyclitols, derived from conduramines and their analogues, comprise parts of aminoglycoside antibiotics which are among the oldest known antibiotics. These compounds possess arrays of hydroxyl and amino groups and are potentially interesting systems, as they can target pivotal RNA sites, and are thus candidates for drug discovery⁴. Apart from, due to their glycosidase inhibitory activities, they can act as potential anticancer or antiviral agents⁵. Apart from clinical use, aminocyclitols such as conduramines have also been used as building blocks for the syntheses of many important natural products. Therefore, it is not surprising that a large number of reports related to their synthesis have appeared in literature.

3.2. Hypothesis.

Owing to our sustained interest in the field of glycosidase inhibitors⁶, sometime back we had disclosed a successful pathway for the synthesis of conduramines in optically pure form employing 7-aza bicyclo[2.2.1]hept 2-one as a template. In continuation, we envisioned that the entire class of aminocyclitols can be classified into two categories based on the stereochemistry of hydroxyl moiety vicinal to the amino group. The *cis* series where the adjacent OH group is *cis/syn* to the amine functionality and the *trans* series where the hydroxy group is *trans/anti* to the amino group (figure 1). The same classification will also hold true with other higher order aminocyclitols such as hygromycin or streptomycin core. Based on the above classification, precursors **10** and **11** can be drawn to serve as a general template for the purpose of synthesizing all the aminocyclitols. The suitably placed olefin in these precursors would serve the purpose for installing desired hydroxyl moieties as well as other functionalities in desired stereochemistry on the periphery of the cyclohexane ring in an enviable mode.

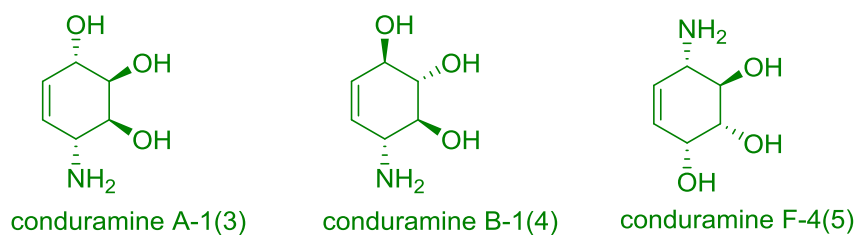
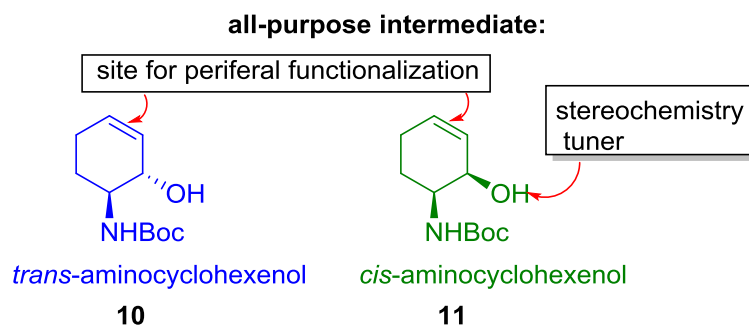
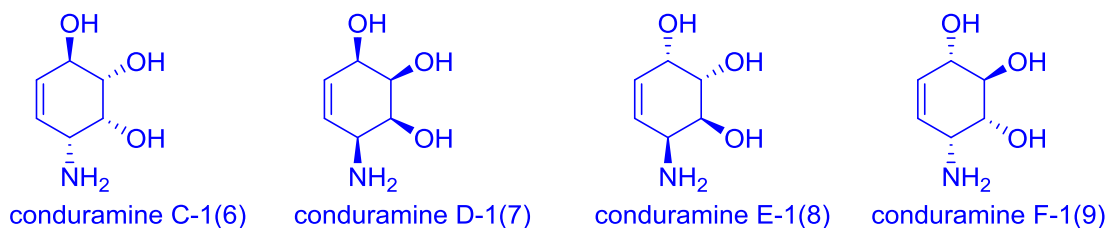
The *trans* series:**The *cis* series:****Figure 2. Various conduramines and proposed synthetic intermediate****3.3. Results and discussion.**

In first chapter we have revealed the synthesis of these two important intermediates (**10**&**11**). Our laboratory has previously synthesized^{6a} *ent*-conduramine F-1 as well as dihydroconduramine E-1 by utilizing the *cis*-aminocyclohexenol **11**. In this chapter, we wish to disclose the details of synthesis of other important conduramines from **10** as well as from **11**.

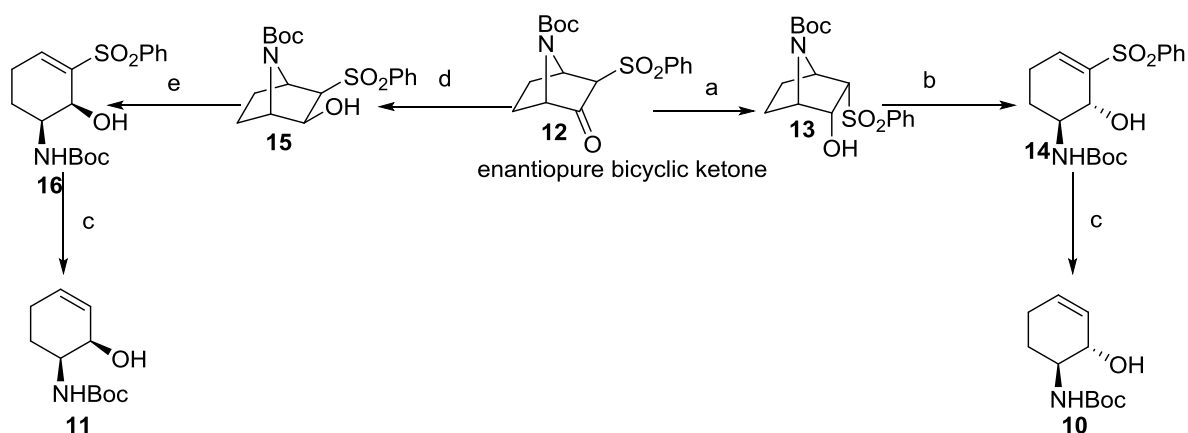

Reagents and conditions: (a) LiBH_4 , THF, -78°C , 1h, 95%; (b) 1.4M MeMgBr (10 equiv.), THF, 10h, 82%; (c) Na-Hg , MeOH , 0°C , 1h, 87%; (d) LiBH_4 , THF, 0°C to rt, 5h, 91%; (e) 1.4M MeMgBr (6 equiv.), THF, 2h, 75%

Scheme 1. Synthesis of aminohexenol 10 & 11.

3.3a. Dihydroconduramine F-4

Towards synthesizing dihydroconduramine F-4, we first converted **10** to dihydroconduramine F-4 (**18**) in two steps. Dihydroxylation of **10**, using catalytic amount of OsO_4 and NMO as reoxidant, produced **17** in 95% yield as a single diastereomer. The stereochemistry of **17** was quite predictable as dihydroxylation of free allylic cyclohexenols has been shown to be dependent on the conformation of hydroxyl group and according to Donohoe⁷, diastereoselective *anti* attack to the OH group is usually achieved under standard conditions. The carbamate deprotection with dil. HCl produced dihydroconduramine F-4 [**18**, $[\alpha]_D^{23}$: -28 (c 0.5, H_2O)] in 90% yield (Scheme 5).

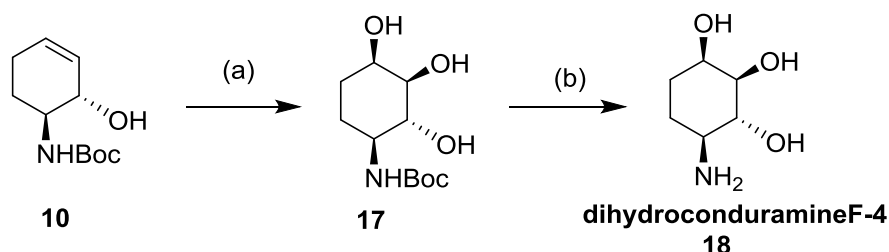

Scheme 2. Synthesis of Dihydroconduramine F-4

Reagents and Conditions : (a) OsO_4 , NMO, NaHCO_3 , $t\text{-BuOH}:\text{H}_2\text{O}$ (1:1), 12 h, rt, 95% (b) 3N HCl, 1,4-dioxane, 6 h, 100°C , 90%

^1H NMR of **18** displayed three sets of multiplets at δ 4.03 - 4.01 (m, 1 H), 3.63 (t, J = 9.8 Hz, 1 H) and 3.42 (dd, J = 3.0, 9.4 Hz, 1 H) each integrating for one proton which were assigned to three protons attached to hydroxyl group. A multiplet at δ 3.04, integrating for one proton, was assigned to proton attached with amine group and the multiplet between δ 1.84- 1.54, integrating for four protons, were assigned as two methylene protons. The mass spectrum of **18** showed molecular ion peak at 148 ($\text{M}^+\text{+H}$). The confirmation of stereochemistry was done by carrying out COSY and NOESY experiments.

3.3b. Dihydroconduramine A-1

Towards transforming **10** to dihydroconduramine A1, epoxidation of the olefinic bond followed by stereoselective opening provided **20** in 84 % yield as described in chapter one. The carbamate group of **20** was subsequently deprotected using aqueous HCl to obtain dihydroconduramine A1 hydrochloride salt **21** in quantitative yield. Presence of H_1 , H_2 and H_3 at δ 3.87 (br. s., 1 H), 3.70 (br. s., 1 H), 3.52 (br. s., 1 H), respectively, together with H_4 at δ 3.18 (br. s., 1 H) indicated the formation of **21**. Further support to the proposed structure of **21**, was obtained by observing the molecular ion peak at m/z 170.0786. in HRMS(ESI); calculated for $\text{C}_6\text{H}_{13}\text{NO}_3\text{Na}$ ($[\text{M}+\text{Na}]^+$) m/z 170.0788.

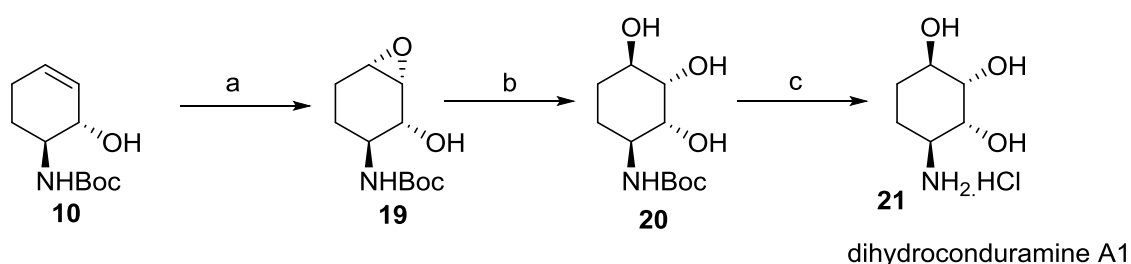

Reagents and conditions: (a) mCPBA, DCM, 0°C to rt, 3h, 85%; (b) 0.5M H_2SO_4 , THF: H_2O (1:1), 1h, 99%; (c) 1M HCl, dioxane, reflux, 1h, 99%;

Scheme 3: Synthesis of dihydroconduramine A1

3.3c. *ent*-Conduramine A-1

To expand the synthetic utility of **11**, synthesis of conduramine A1 was planned from **25**, synthesis already described chapter one. Luche reduction of **25**, unfortunately produced an inseparable diastereomeric mixture (2:1) of **26**. The ratio was determined by ^1H NMR. Fortunately only one diastereomer got protected upon reaction with $(\text{Boc})_2$ at -78°C . The presence of 18 H at δ 1.25-1.4 indicated the formation of **27**. Further support to the proposed structure of **27**, was obtained by observing the molecular ion peak at 508.2516. in HRMS(ESI); calculated for $\text{C}_{24}\text{H}_{39}\text{NO}_9\text{Na}$ ($[\text{M}+\text{Na}]^+$) m/z 508.2517.

The carbamate, carbonate and acetonide group were deprotected all together with trifluoro acetic acid, to obtain *ent*-conduramine A-1 in 90% yields. The spectral data matched well with the reported value⁸.

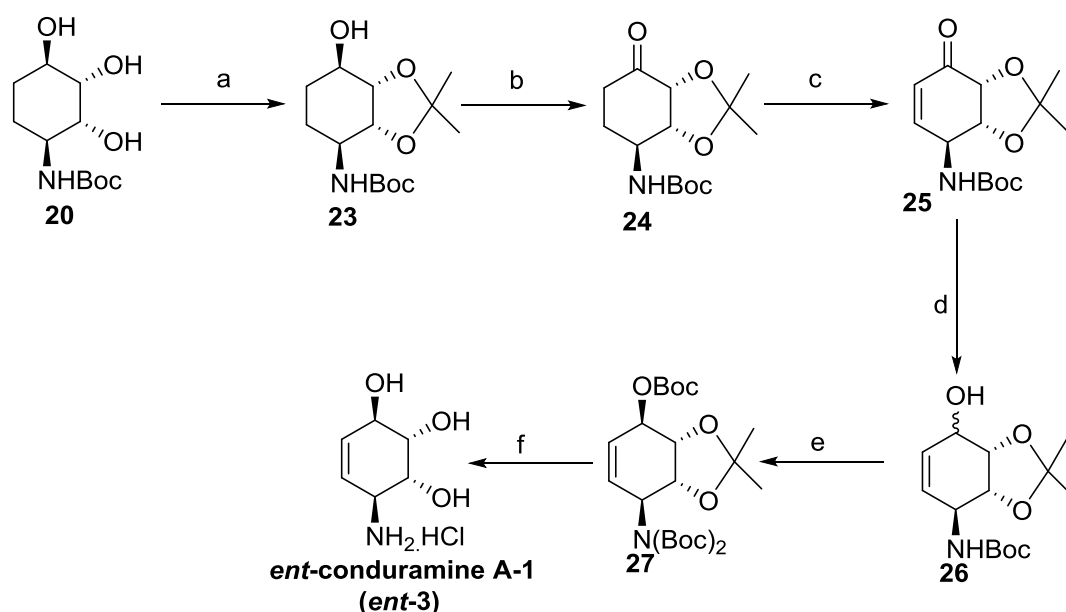

Reagents and conditions: (a) 2,2-DMP, pTSA, dry DMF, rt, 1h, 95%; (b) IBX, DMSO, rt, 12h, 90%; (c) LiHMDS, TMSCl, 0°C to rt, 4h then $\text{Pd}(\text{OAc})_2$, acetonitrile, rt, 24h, 67%; (d) NaBH_4 , $\text{CeCl}_3 \cdot 7\text{H}_2\text{O}$, MeOH, 0°C to rt, 20h, 75%; (e) LiHMDS, $(\text{Boc})_2\text{O}$, -78°C , 56%; (f) TFA, DCM, 8 h then 1M HCl, THF, 4h, 97%;

Scheme 4: Synthesis of *ent*-conduramine A1

3.3d. Dihydroconduramine -C1

The synthesis of conduramine C1 commenced with *syn* selective epoxidation of **11** by mCPBA in DCM which produced **28** in 75% yields. The reaction was diastereoselective as evident from NMR analysis of the reaction mixture. The characteristic two protons, attached to epoxide ring (H-1, H-2) were assigned to δ 3.38 (s, 2 H). Further support to the proposed structure of **28**, was obtained by observing the molecular ion peak at 230.1389. in HRMS(ESI); calculated for $C_{11}H_{20}NO_4$ ($[M+H]^+$) m/z 230.1387.

Regioselective epoxide ring opening using aqueous sulphuric acid in tetrahydrofuran produced **29** in 92% yields which was characterised by the chemical shift values of the protons H1, H2, H3 and H4. For illustration H1 and H2 appeared at δ 3.36 (d, $J = 12.5$ Hz, 1 H) and δ 3.46 (d, $J = 10.7$ Hz, 1 H) respectively. Large coupling constant value ($J > 10$ Hz) suggested a *trans* relationship.

The carbamate group of **29** was removed using aqueous HCl to obtain hydrochloride salt of dihydroconduramine C-1 **30** in quantitative yield. The spectral data and specific optical rotation $[[\alpha]_D^{27} + 20$ (c 1.0, H_2O)] matched satisfactorily with the reported values.

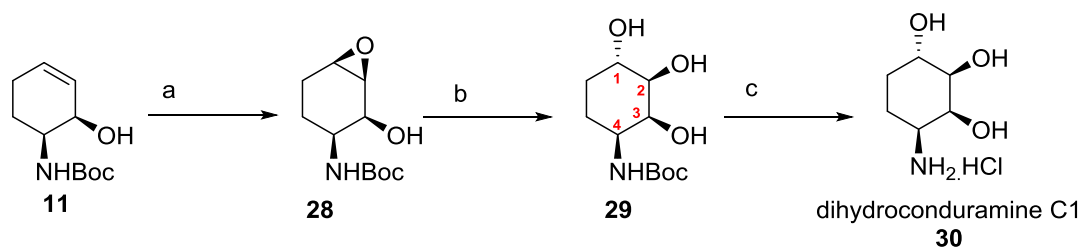

Reagents and conditions: (a) mCPBA, DCM, 0°C to rt, 3h, 85%; (b) 0.5M H_2SO_4 , THF: H_2O (1:1), 1h, 99%; (c) 1M HCl, dioxane, reflux, 1h, 99%

Scheme 5: Synthesis of dihydroconduramine C1

3.3e. Conduramine D-1

After completion of the synthesis of dihydroconduramine C-1, we next turned our attention towards another important aminocyclitol conduramine D-1.

The two *syn* hydroxyl group of **29** were preferentially protected with pentanonide to obtain **31** (95% yield) by reaction with 3,3-dimethoxy pentane. The two methyl groups, characteristics of pentanonide, appeared at δ 1.03-0.78 (m, 6 H). Further support to the structure of **31** was obtained from DEPT studies where four methylene group protons appeared at δ 30.2, 28.4, 28.3 and 25.0. Additional support to the proposed structure of **31**, was obtained by observing the molecular ion peak at 338.1938. in HRMS(ESI); calculated for $C_{16}H_{29}NO_5Na$ ($[M+Na]^+$) m/z 338.1938.

Compound **31** was oxidised to **32** (81%) with IBX (2-iodoxybenzoic acid) by refluxing in ethyl acetate. The characteristic carbonyl group peak in ^{13}C NMR at δ 206.9 was indicative of its formation, supported by observing the molecular ion peak at 336.1780. in HRMS(ESI); calculated for $C_{16}H_{27}NO_5Na$ ($[M+Na]^+$) m/z 336.1781.

The crucial conversion of **32** to **33** was performed using Seagussa-Ito oxidation protocol^[9] of enol ethers. For this purpose, **32** was first converted to corresponding silyl enolether by reaction with LiHMDS and trimethylsilyl chloride at 0°C- rt. Usual work up followed by stirring of the crude with Pd(OAc)₂ in anhydrous acetonitrile for 24h in the presence of oxygen gave **33** in 67% yield.

The characteristic olefinic protons could easily be characterized at δ 6.72 (d, J = 10.4 Hz, 1 H), 6.09 (dd, J = 2.6, 10.4 Hz, 1 H) which are in good agreement with the characteristics of α,β -unsaturated carbonyl compound. Luche reduction of **33** produced **34** as a single diastereomer in 75% yield.

Global deprotection of **34** using aq. HCl provided hydrochloride salt of conduramine D-1 in 90% yield. The specific optical rotation matched satisfactorily with that of literature reported value.^[8]

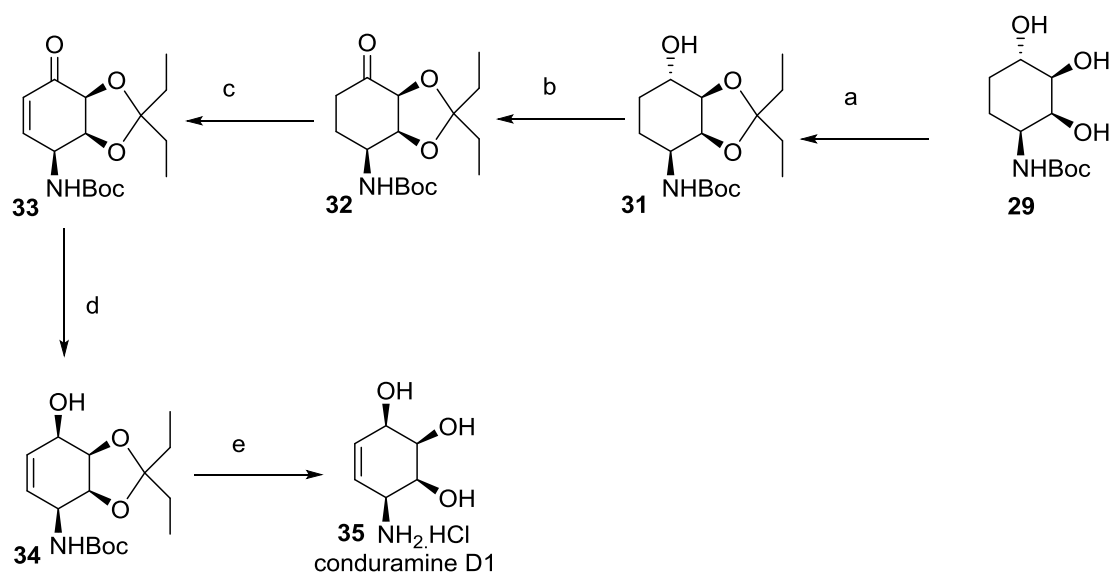

Reagents and conditions: (a) 3,3-DMP, pTSA, dry DMF, rt, 1h, 95%; (b) IBX, EtOAc, reflux, 10h, 81%; (c) LiHMDS, TMSCl, 0°C to rt, 4h then Pd(OAc)₂, acetonitrile, rt, 24h, 67%; (d) NaBH₄, CeCl₃·7H₂O, MeOH, 0°C to rt, 20h, 75%; (e) 1M HCl, dioxane, reflux, 3h, 99%;

Scheme 5: Synthesis of conduramine D-1

3.4. Conclusion:

We have shown that from **12**, two very important intermediates **10** and **11** can be synthesized easily which could be used in the synthesis of many conduramines in straight forward manner. Synthesis of some other important aminocyclitols is in progress in our laboratory.

3.5. References.

1. (a) Ferrier, R. J.; Blattner, R.; Clinch, K.; Furneaux, R. H.; Gardiner, J. M.; Tyler, P. C.; Wightman, R. H.; Williams, N. R. *Carbohydr. Chem.* **1996**, *28*, 251. (b) Ashry, E. S.; Rashed, N.; Shobier, A. H. *Pharmazie* **2000**, *55*, 403. (c) Chapleur, Y. *Carbohydrate Mimics – Concepts and Methods*, Wiley-VCH, Weinheim, **1998**.
2. Arjona, O.; Gomez, A. M.; Lopez, J. C.; plummet, J. *Chem. Rev.* **2007**, *107*, 1919.
3. Chen, X.; Fan, Y.; Zheng, Y.; Shen, Y. *Chem. Rev.* **2003**, *103*, 1955.
4. Wang, H.; Tor, Y. *Angew. Chem. Int. Ed.*, **1998**, *37*, 109.
5. (a) Vartesy, L.; Fehlhaber, H. W.; Schulz, A. *Angew. Chem. Int. Ed.*, **1994**, *33*, 1844. (b) Ogawa, S.; Ashiura, M.; Uchida, C.; Wantabe, S.; Yamazaki, C.; Yamagishi, K.; Inokuchi, J. *Bioorg. Med. Chem. Lett.* **1996**, *6*, 929. (c) Lew, W.; Williams, M. A.; Mendel, D. B.; Escarpe, P. A.; Kim, C. U. *Bioorg. Med. Chem. Lett.* **1997**, *7*, 1843. (d) Sears, P.; Wong, C. H. *J. Chem. Soc. Chem. Comm.* **1998**, 1161 and references cited therein.
6. (a) Pandey, G.; Tiwari, K. N.; Puranik, V. G. *Org. Lett.* **2008**, *10*, 3611-3614. (b) Pandey, G.; Rajender, S. *Chem. Eur. J.* **2011**, *17*, 6304-6308. (c) G. Pandey, M. Kapur, *Synthesis* **2001**, 1263;(d) G. Pandey, M. Kapur, *Org. Lett.* **2002**, *4*, 3883. (e) G. Pandey, M. Kapur, M. Islam Khan, S. M. Gaikwad, *Org. Biomol. Chem.* **2003**, *1*, 3321. (f) G. Pandey, S. G. Dumbre, M. I. Khan, M. Shabab, *J. Org. Chem.* **2006**, *71*, 8481.(g) G. Pandey, S. G. Dumbre, M. I. Khan, M. Shabab, V. G. Puranik, *Tetrahedron Lett.* **2006**, *47*, 7923. (h) G. Pandey, S. G. Dumbre, S. Pal, M. I. Khan, M. Shabab, *Tetrahedron* **2007**, *63*, 4756. (i) G. Pandey, K. C. Bharadwaj, M. I. Khan, K. S. Shashidhara, V. G. Puranik, *Org. Biomol. Chem.* **2008**, *6*, 2587. (j) G. Pandey, D. Grahacharya, K. S. Shashidhara, M. I. Khan, V. G. Puranik, *Org. Biomol. Chem.* **2009**, *7*, 3300. (k) G. Pandey, D. Dey, S. R. Gadre, *Chimia.* **2013**, *67*, 30-38.
7. Donohoe, T. J.; Moore, P. R.; Beddoes, R. L. *J. Chem. Soc. Perkin Trans. 1* **1997**, 43.
8. R. L.Toung, Y. Liu, J. M. Muchowski, Y. Wu *J. Org. Chem.* **1998**, *63*, 3235-3250
9. Ito, Y; Hirao, T; Saegusa, T. *J. Org. Chem.* **1978**, *43*, 1011-1013

3.6. EXPERIMENTAL.

Preparation of *tert*-butyl ((1*S*,2*R*,3*R*,4*R*)-2,3,4-trihydroxycyclohexyl)carbamate (**17**):

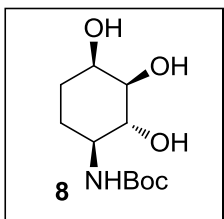

To a solution of **10** (0.050 g, 0.234 mmol) in THF (2 mL), *N*-methylmorpholine-*N*-oxide (0.041 g, 0.352 mmol) and OsO₄ (0.1 mL, 2.5 wt% solution in *tert*-butyl alcohol) was added in succession to a stirred solution of sodium bicarbonate (0.019 g, 0.234 mmol) in *tert*-butyl alcohol (3 mL) and water (0.75 mL). The reaction was stirred at room temperature for 15 h and excess 10% NaHSO₃ solution was added. The reaction mixture was diluted with EtOAc and worked up in the usual manner. The column chromatography purification provided **17** (0.055 g, 55%) as a crystalline solid.

mp	:	135-139 °C
[α] ³⁰ _D	:	-17.0 (<i>c</i> 1.2, MeOH)
IR ν _{max} cm ⁻¹ in CHCl ₃	:	3400, 3300, 1687
¹ H NMR (200 MHz, D ₂ O) δ	:	4.07 (s, 1H) 3.71 (m, 1H) 3.36-3.61 (m, 3H) 1.58-1.95 (m, 4H) 1.44 (s, 9H)
¹³ C NMR (125 MHz, D ₂ O) δ	:	71.3, 68.9, 66.6, 48.6, 24.6, 21.8
MS (ESI): <i>m/z</i>	:	148 (M ⁺ +H), 170 (M ⁺ +Na)

Preparation of (1*R*,2*R*,3*R*,4*S*)-4-aminocyclohexane-1,2,3-triol hydrochloride (**18**):

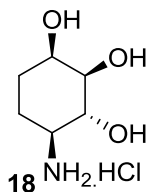

To a solution of **17** (0.050 g, 0.234 mmol) in dioxane (2 mL), 2 mL of aqueous hydrochloric acid (6M solution) was added. The reaction was refluxed for 1.5 h and concentrated in vacuo which produced **18** (0.037g, 99%) as pale yellow solid.

$[\alpha]_D^{23}$:	-28 (<i>c</i> 0.5, H ₂ O)
¹ H NMR (800 MHz, D ₂ O) δ	:	4.03 - 4.01 (m, 1 H), 3.63 (t, <i>J</i> = 9.8 Hz, 1 H), 3.42 (dd, <i>J</i> = 3.0, 9.4 Hz, 1 H), 3.04 - 3.01 (m, 1 H), 1.84 - 1.80 (m, 2 H), 1.70 (dt, <i>J</i> = 4.2, 13.2 Hz, 1 H), 1.58 - 1.54 (m, 1 H)
¹³ C NMR (200 MHz, D ₂ O) δ	:	74.1, 70.7, 68.9, 53.7, 26.9, 22.3
MS (ESI): <i>m/z</i>	:	148 (M ⁺ +H), 170 (M ⁺ +Na)

Preparation of (1*R*,2*S*,3*R*,4*S*)-4-aminocyclohexane-1,2,3-triol hydrochloride (**21**):

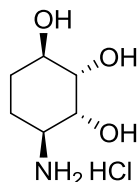

A solution of **20** (0.060 g, 0.242 mmol) in 6N HCl (5 mL) in a round-bottom flask equipped with a magnetic stir bar and a reflux condenser was refluxed for 12 h until TLC revealed no starting material. The reaction was concentrated by rotary evaporation and the crude material was dried *in vacuo* to give **21** (0.04 g, 89%) as brown solid.

$[\alpha]_D^{26}$:	-70.0 (<i>c</i> 1.0, MeOH)
¹ H NMR (400 MHz, CDCl ₃) δ	:	3.87 (br. s., 1 H), 3.70 (br. s., 1 H), 3.52 (br. s., 1 H), 3.18 (br. s., 1 H), 1.84 - 1.44 (m, 4 H)
¹³ C NMR (100 MHz, CDCl ₃) δ	:	71.9, 69.3, 68.8, 50.8, 24.8, 22.8
MS (ESI): <i>m/z</i>	:	148 (M ⁺ +H), 170 (M ⁺ +Na)

tert-butyl((3*aR*,4*S*,7*aS*)-7-hydroxy-2,2-dimethyl-3*a*,4,7,7*a*-tetrahydrobenzo[*d*][1,3]dioxol-4-yl)carbamate(**26**):

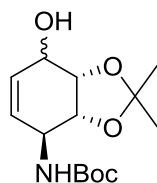

To a stirred and ice cooled solution of **25** (0.05 g, 0.18 mmol, 1.0 equiv.) and $\text{CeCl}_3 \cdot 7\text{H}_2\text{O}$ (0.066 g, 0.19 mmol, 1.1 equiv.) in distilled methanol (1 mL) was added NaBH_4 (0.007 g, 0.19 mmol, 1.1 equiv.) in one portion. The reaction mixture was stirred at that temperature for 1 h after which it was quenched with brine (2 mL) and extracted with EtOAc (3x5 mL). The combined organic layers were concentrated and the crude material was chromatographed (EtOAc: Hexanes 1:1) to obtain **26** (0.038 g, 75%) as colourless liquid.

HRMS(ESI): Cal. For $\text{C}_{14}\text{H}_{23}\text{NO}_5\text{Na}[\text{M}+\text{Na}]^+$: 308.1468, found: 308.1468.

Preparation of **27**:

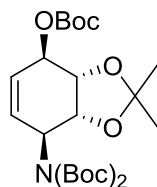

To a stirred and cooled (-78°C) solution of **26** (0.03 g, 0.105 mmol, 1.0 equiv.) in THF was added LiHMDS (0.53 mL, 0.53 mmol, 5 equiv.). After 1h $(\text{Boc})_2\text{O}$ (0.09 mL, 0.42 mmol, 4 equiv.) was added and the reaction mixture was allowed to come to room temperature. The reaction was quenched with saturated aqueous solution of ammonium chloride and extracted with EtOAc (3x5 mL). The combined organic layers were concentrated and the crude material was chromatographed (EtOAc: Hexanes 1:9) to obtain **27** (0.029 g, 57%) as colourless liquid.

$[\alpha]_{\text{D}}^{25}$: -37.0 (*c* 1.0, CHCl_3)

^1H NMR (400 MHz, CDCl_3) δ : 5.96 - 5.80 (m, 2 H), 5.45 (t, $J = 3.9$ Hz, 1 H), 5.13 - 5.03 (m, 1 H), 4.61 (dd, $J = 4.3, 6.8$ Hz, 1 H), 4.46 (dd, $J = 4.7, 6.9$ Hz, 1 H), 1.61 (s, 3 H), 1.50 (s, 18 H), 1.48 (s, 9 H), 1.36 (s, 3 H)

^{13}C NMR (200 MHz, CDCl_3) δ : 153.4, 152.5, 133.3, 123.8, 109.5, 83.0, 82.1, 73.9, 68.4, 57.2, 28.0, 27.8, 26.8, 25.3

HRMS(ESI); calculated for $\text{C}_{24}\text{H}_{39}\text{NO}_9\text{Na}$ ($[\text{M}+\text{Na}]^+$) m/z 508.2517, found : 508.2516

Preparation of *ent*-conduramine A-1 hydrochloride (*ent*-**3**):

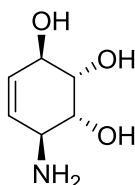

To a stirred and ice cooled solution of **27** (0.011 g, 0.023 mmol, 1.0 equiv.) in DCM was added TFA (0.035 mL, 0.45 mmol, 20 equiv.) and stirred for 8 h after which the reaction mixture was concentrated and 1 mL 1M HCl was added and stirred for another 4 h. the reaction mixture was evaporated to get *ent*-conduramine A1 (*ent*-**3**) hydrochloride (0.004 g, 97%) as yellowish solid.

$[\alpha]_{\text{D}}^{23}$: -57.0 (c 1.0, H_2O)

^1H NMR (400MHz, D_2O) δ : 5.66 (d, $J = 10.3$ Hz, 1 H), 5.53 (d, $J = 10.3$ Hz, 1 H), 4.27 (br. s., 1 H), 3.99 (br. s., 1 H), 3.81 - 3.73 (m, 1 H), 3.71 - 3.64 (m, 1 H)

MS (ESI): m/z : 146 (M^++H), 168 (M^++Na)

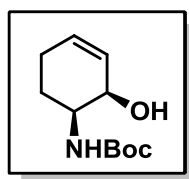
Preparation of *tert*-butyl ((1*S*,2*R*)-2-hydroxycyclohex-3-en-1-yl)carbamate(**11**)

To a solution of *t*-butyl ((1*S*,2*S*)-2-hydroxy-3-(phenylsulfonyl)cyclohex-3-en-1-yl)carbamate (1.1 g, 3.11 mmol, 1.0 equiv) in methanol:tetrahydrofuran (30.0 mL, 5:1) in a round-bottomed flask equipped with a magnetic stir bar was added NaH₂PO₄•2H₂O (3.73 g, 31.12 mmol, 10 equiv). The flask was cooled to 0 °C and stirred for 10 min under argon atmosphere, after which Na-Hg (6.96 g, 31.11 mmol, 10 equiv) was added in portions over 10 min. The reaction was allowed to stir for 60 min at 0 °C and was quenched with saturated ammonium chloride (20.0 mL). The layers were separated and the aqueous layer was extracted with EtOAc (3 x 20.0 mL). The combined organic layers were dried over sodium sulfate, filtered, and concentrated by rotary evaporation. The crude material was purified by silica gel chromatography (30% EtOAc in hexanes) to afford **11** (0.6 g, 90%) as colorless liquid.

$$[\alpha]_D^{25} : -76.0 (c 1.0, \text{CHCl}_3)$$

$$\text{IR (neat)} \nu_{\text{max}} \text{ cm}^{-1} : 3405, 3301, 1708, 1682, 1150$$

$$^1\text{H NMR (200MHz, CDCl}_3) \delta : 5.96 - 5.73 \text{ (m, 2 H)}, 5.08 \text{ (br. s., 1 H)}, 4.12 \text{ (d, } J = 7.1 \text{ Hz, 1 H)}, 3.71 \text{ (d, } J = 14.9 \text{ Hz, 1 H)}, 2.15 \text{ (d, } J = 9.6 \text{ Hz, 2 H)}, 1.80 - 1.68 \text{ (m, 2 H)}, 1.46 \text{ (s, 10 H)}$$

$$^{13}\text{C NMR (50 MHz, CDCl}_3) \delta : 155.6, 131.6, 127.3, 79.3, 65.3, 50.0, 28.4, 24.7, 23.56$$

$$\text{Mass (ESI): } m/z : 214 (M^+ + H), 236 (M^+ + Na), 252 (M^+ + K)$$

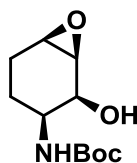
Preparation of *tert*-butyl ((1*S*,2*S*,3*S*,6*R*)-2-hydroxy-7-oxabicyclo[4.1.0]heptan-3-yl)carbamate(**28**)

To a solution of **11** (0.5g, 2.34 mmol, 1.0 equiv) in dichloromethane(30.0 mL) in a round-bottomed flask equipped with a magnetic stir bar was added 3-chlorobenzoperoxoic acid (1.05 g, 4.69 mmol, 2.0 equiv). The flask was cooled to 0 °C and stirred for 3 h under argon atmosphere and was quenched with saturated sodium hydrogen carbonate solution (20.0 mL). The layers were separated and the aqueous layer was extracted with EtOAc (3 x 20.0 mL). The combined organic layers were dried over sodium sulfate, filtered, and concentrated by rotary evaporation. The crude material was purified by silica gel chromatography (50% EtOAc in hexanes) to afford **28** (0.38 g, 70%) as a white crystalline solid.

$[\alpha]_D^{24}$:	-27.0 (<i>c</i> 1.0, CHCl ₃)
IR (neat) ν_{\max} cm ⁻¹	:	3405, 3301, 1711, 1682, 1152
¹ H NMR (500 MHz, CDCl ₃) δ	:	5.23 (d, <i>J</i> = 8.5 Hz, 1 H), 4.07 (br. s., 1 H), 3.63 - 3.54 (m, 1 H), 3.37 (s, 2 H), 2.15 (s, 1 H), 1.97 - 1.88 (m, 1 H), 1.52 (br. s., 1 H), 1.43 (s, 9 H)
¹³ C NMR (125 MHz, CDCl ₃) δ	:	155.7, 79.4, 65.4, 55.1, 54.7, 49.6, 28.3, 22.4, 21.1
Mass (ESI): <i>m/z</i>	:	230 (M ++H), 252 (M ++Na)

Preparation of *tert*-butyl ((1*S*,2*S*,3*R*,4*S*)-2,3,4-trihydroxycyclohexyl)carbamate(**29**)

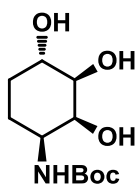

To a stirred solution of **28** (0.2g, 0.8 mmol, 1 equiv.) in 20 mL THF was added 5 mL of 1M H₂SO₄ solution. The reaction is stirred for 1.5 h after which the reaction was quenched with saturated sodium bicarbonate solution. The layers were separated and the aqueous layer was washed with (3x15 mL) of ethyl acetate. The combined organic layer was dried with anhydrous sodium sulfate and concentrated under reduced pressure to **29** (0.21 g, 97%) as a white amorphous solid.

$[\alpha]_D^{31}$:	-1.5 (<i>c</i> 1.0, CHCl ₃)
IR (neat) ν_{\max} cm ⁻¹	:	3405, 3301, 1708, 1682, 1150

^1H NMR (500 MHz, D_2O) δ : 3.93 (br. s., 1 H), 3.66 - 3.59 (m, 1 H), 3.46 (d, $J = 10.7$ Hz, 1 H), 3.36 (d, $J = 12.5$ Hz, 1 H), 1.89 (br. s., 1 H), 1.63 - 1.47 (m, 2 H), 1.36 (s, 9 H), 1.27 (d, $J = 15.6$ Hz, 1 H)

^{13}C NMR (125 MHz, D_2O) δ : 157.3, 81.1, 74.7, 71.8, 69.0, 51.0, 29.1, 27.6, 23.8

Mass (ESI) : m/z : 270 ($\text{M}^+ + \text{Na}$)

Preparation of (1*S*,2*R*,3*S*,4*S*)-4-aminocyclohexane-1,2,3-triol hydrochloride (**30**):

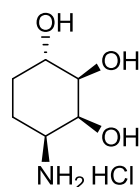

To a solution of **29** (0.050 g, 0.234 mmol) in dioxane (2 mL), aqueous hydrochloric acid (2 mL, 6M solution) was added. The reaction mixture was refluxed for 1.5 h and concentrated in vacuo which produced **30** (0.033g, 89%) as a white solid.

$[\alpha]_{\text{D}}^{27}$: +20 (c 1.0, H_2O)

^1H NMR (400MHz, D_2O) δ : 4.05 (br. s., 1 H), 3.67 (dt, $J = 4.8, 10.3$ Hz, 1 H), 3.40 - 3.29 (m, 2 H), 1.98 - 1.89 (m, 1 H), 1.81 - 1.73 (m, 1 H), 1.73 - 1.61 (m, 1 H), 1.35 - 1.21 (m, 1 H)

^{13}C NMR (125 MHz, D_2O) δ : 74.2, 69.5, 68.4, 50.8, 28.1, 22.1

MS (ESI): m/z : 148 ($\text{M}^+ + \text{H}$), 170 ($\text{M}^+ + \text{Na}$)

Preparation of *tert*-butyl ((3*aS*,4*S*,7*S*,7*aR*)-2,2-diethyl-7-hydroxyhexahydrobenzo[*d*][1,3]dioxol-4-yl)carbamate(**31**)

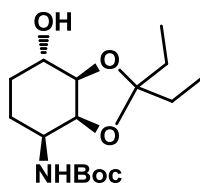

To a solution of **29** (0.21 g, 0.85 mmol, 1.0 equiv) in anhydrous DMF (10.0 mL) in a round-bottomed flask equipped with a magnetic stir bar was added 3,3-dimethoxy pentane (0.561 g, 4.25 mmol, 5 equiv.) and (0.146 g, 0.85 mmol, 1 equiv) *para*-toluene sulfonic acid. The flask was stirred at ambient temperature until TLC monitoring showed complete conversion of starting compound (12 h). The reaction was quenched with water (50.0 mL). The layers were separated and the aqueous layer was extracted with EtOAc (3 x 10.0 mL). The combined organic layers were dried over sodium sulfate, filtered, and concentrated by rotary evaporation to afford **31** (0.25 g, 93%) as a light yellow liquid.

$[\alpha]_D^{28.1}$: -2.87 (*c* 1.04, CHCl₃)

IR (neat) ν_{\max} cm⁻¹ : 3409, 2877, 1685, 1150

¹H NMR (200MHz, CDCl₃) δ : 4.97 (dd, *J* = 0.8, 10.2 Hz, 1 H), 4.35 - 4.23 (m, 1 H), 3.88 (dd, *J* = 5.3, 7.1 Hz, 2 H), 3.76 - 3.61 (m, 1 H), 2.18 (s, 1 H), 1.95 - 1.55 (m, 7 H), 1.46 (s, 9 H), 1.03 - 0.78 (m, 6 H)

¹³C NMR (101MHz, CDCl₃) δ : 155.2, 113.2, 81.0, 79.5, 75.2, 72.2, 48.8, 30.2, 28.4, 28.3, 25.0, 8.5

Preparation of *tert*-butyl ((3*aS*,4*S*,7*aS*)-2,2-diethyl-7-oxohexahydrobenzo[d][1,3]dioxol-4-yl)carbamate (**32**)

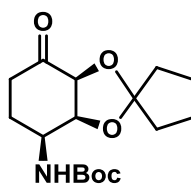

To a solution of **31**(0.5g, 1.59 mmol,1.0 equiv) in ethyl acetate (30.0 mL) in a round-bottomed flask equipped with a magnetic stir bar was added iodoxy benzoic acid (0.665g, 2.38 mmol,1.5 equiv.). The flask was heated to reflux until TLC monitoring showed complete conversion of starting compound (8h). The reaction mixture was cooled and passed through celite and then concentrated in vacuo. The crude was purified by column chromatography (20% ethyl acetate in petroleum ether) to obtain **32** (0.45 g, 90 %) as an amorphous solid.

$[\alpha]^{28.3}_D$: -9 (*c* 0.55, CHCl₃)
 IR (neat) ν_{\max} cm⁻¹ : 1711, 1687, 1145
¹H NMR (400MHz, CDCl₃) δ : 5.06 - 4.94 (m, 1 H), 4.58 - 4.48 (m, 1 H), 4.27 (d, *J* = 5.8 Hz, 1 H), 4.21 - 4.07 (m, 1 H), 2.53 - 2.43 (m, 1 H), 2.37 (d, *J* = 5.5 Hz, 1 H), 2.03 (d, *J* = 4.5 Hz, 1 H), 1.98 - 1.88 (m, 1 H), 1.67 - 1.56 (m, 4 H), 1.49 - 1.38 (m, 9 H), 0.89 (dt, *J* = 1.8, 7.5 Hz, 6 H)
¹³C NMR(100 MHz, CDCl₃) δ : 206.9, 155.1, 114.4, 79.9, 78.0, 77.6, 48.6, 37.4, 29.5, 28.7, 28.3, 25.1, 8.4, 8.2

tert-butyl ((3*aS*,4*S*,7*aS*)-2,2-diethyl-7-oxo-3*a*,4,7,7*a*-tetrahydrobenzo[*d*][1,3]dioxol-4-yl)carbamate (**33**)

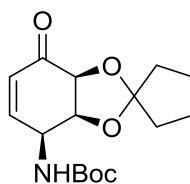

To a solution of **32** (0.1 g, 0.32 mmol, 1 equiv.) in anhydrous THF (4 mL) in a round-bottom flask equipped with a magnetic stir bar was added 0.96 mL of LiHMDS (0.957 mmol, 3 equiv. 1M solution in THF) in 0°C. After 30 min, 0.86 mL of TMSCl (0.382 mmol, 1.2 equiv.) was added drop wise. The reaction mixture was allowed to warm to room temperature and stirred until TLC showed complete conversion of starting compound (4h). The reaction was quenched with ice cooled water (5.0 mL) and was extracted with EtOAc (3 x 5.0 mL). The combined organic layers were dried over sodium sulfate, filtered, and concentrated by rotary evaporation to afford corresponding enol ether as a yellow liquid, which was used as such for the next reaction.

The crude enol ether was dissolved in anhydrous DMSO (3 mL), palladium (II) acetate (0.020g, 0.062 mmol, 0.2 equiv.) was added and stirred at ambient temperature in oxygen atmosphere until TLC showed complete conversion of enol ether (24 h). The reaction mixture was passed through a pad of celite and concentrated by rotary

evaporation. The residue was subjected to chromatographic purification to yield **33** (0.065 g, 67%) as a colorless liquid.

$[\alpha]^{25.5}_D$: -33.5 (*c* 1.5, CHCl₃)

IR (neat) ν_{\max} cm⁻¹ : 1700, 1692, 1150

¹H NMR (400MHz, CDCl₃) δ 6.72 (td, *J* = 1.9, 10.4 Hz, 1 H), 6.10 (dd, *J* = 2.6, 10.4 Hz, 1 H), 5.30 (d, *J* = 9.1 Hz, 1 H), 4.86 (dd, *J* = 4.2, 6.2 Hz, 1 H), 4.68 (dt, *J* = 2.1, 4.7 Hz, 1 H), 4.33 (d, *J* = 5.3 Hz, 1 H), 1.71 - 1.64 (m, 2 H), 1.57 - 1.53 (m, 2 H), 1.50 (s, 9 H), 0.93 (t, *J* = 7.4 Hz, 3 H), 0.82 (t, *J* = 7.4 Hz, 3 H)

Mass (ESI): *m/z* : 312 (M⁺+H), 334 (M⁺+Na)

tert-butyl ((3*aS*,4*S*,7*R*,7*aR*)-2,2-diethyl-7-hydroxy-3*a*,4,7,7*a*-tetrahydrobenzo[*d*][1,3]dioxol-4-yl)carbamate (**34**)

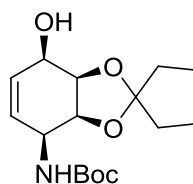

To a stirred and ice cooled solution of **33** (0.05 g, 0.16 mmol, 1.0 equiv.) and CeCl₃·7H₂O (0.066 g, 0.177 mmol, 1.1 equiv.) in distilled methanol (1 mL) was added NaBH₄ (0.007 g, 0.177 mmol, 1.1 equiv.) in one portion. The reaction mixture was stirred at that temperature for 1 h after which it was quenched with brine (2 mL) and extracted with EtOAc (3x5 mL). The combined organic layers were concentrated and the crude material was chromatographed (EtOAc: Hexanes 1:1) to obtain **34** (0.038 g, 75%) as colourless liquid.

$[\alpha]^{23}_D$: -100 (*c* 0.5, CHCl₃)

¹H NMR (400MHz, CDCl₃) δ : 5.76 (d, *J* = 10.8 Hz, 1 H), 5.53 (dd, *J* = 1.5, 10.1 Hz, 1 H), 5.20 (d, *J* = 7.8 Hz, 1 H), 4.60 - 4.44 (m, 2 H), 4.14 - 3.98 (m, 2 H), 1.68 - 1.60 (m, 4 H), 1.48 (s, 9 H), 0.87 (td, *J* = 7.6, 19.4 Hz, 6 H)

HRMS(ESI): Cal. For C₁₆H₂₈NO₅[M+H]⁺: 314.1962, found: 314.1961.

(1*S*,2*R*,3*R*,6*S*)-6-aminocyclohex-4-ene-1,2,3-triol hydrochloride(**35**)

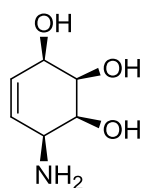

To a solution of **34** (0.020 g, 0.063 mmol, 1 equiv.) in dioxane (2 mL), aqueous hydrochloric acid (2 mL, 6M solution) was added. The reaction was refluxed for 3 h and concentrated in vacuo which produced **35** (0.011 g, 99%) as a yellowish solid.

$[\alpha]_D^{24}$: -117 (*c* 1.0, MeOH)
 $^1\text{H NMR}$ (400MHz, D_2O) δ : 5.98 (d, *J* = 10.1 Hz, 1 H), 5.88 - 5.82 (m, 1 H),
4.34 (br. s., 1 H), 4.12 (br. s., 1 H), 4.03 (d, *J* = 5.3 Hz, 1 H),
3.90 (br. s., 1 H)

HRMS(ESI): Cal. For $\text{C}_6\text{H}_{12}\text{NO}_3[\text{M}+\text{H}]^+$: 146.0812, found: 146.0813

3.7. Spectras.

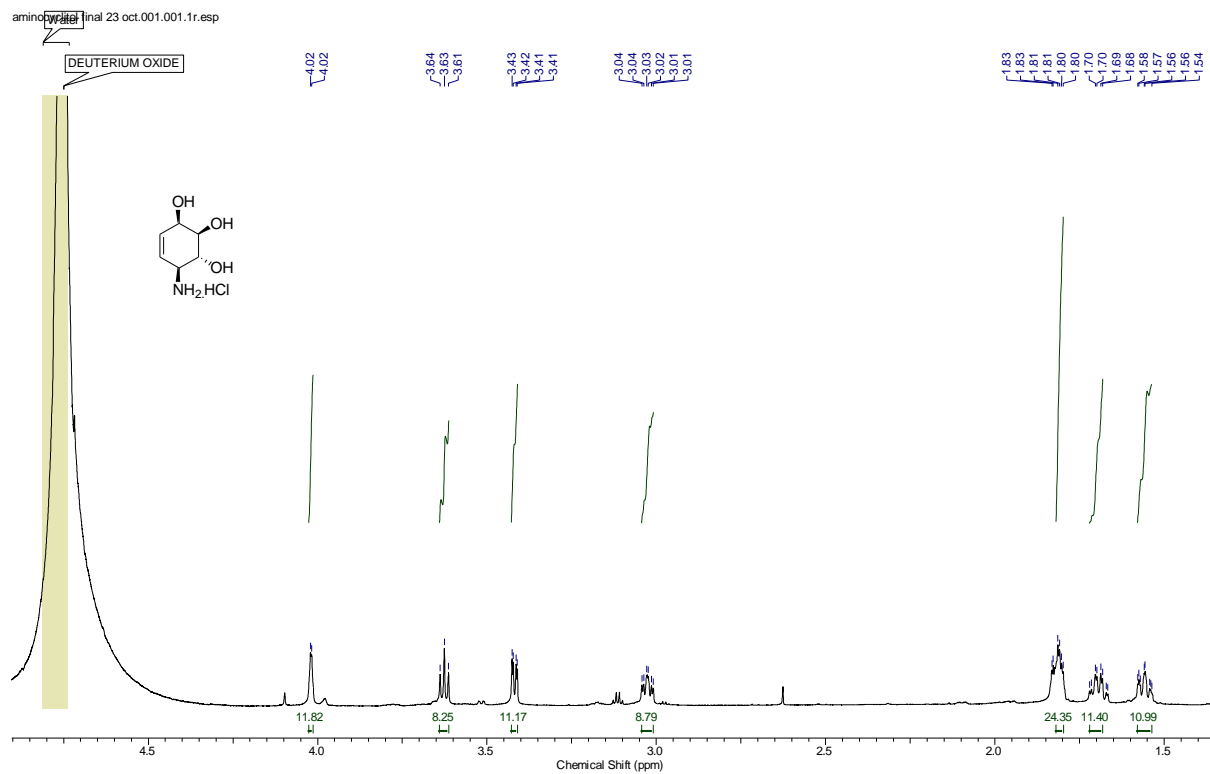

1H_standardization_pulse_sequence

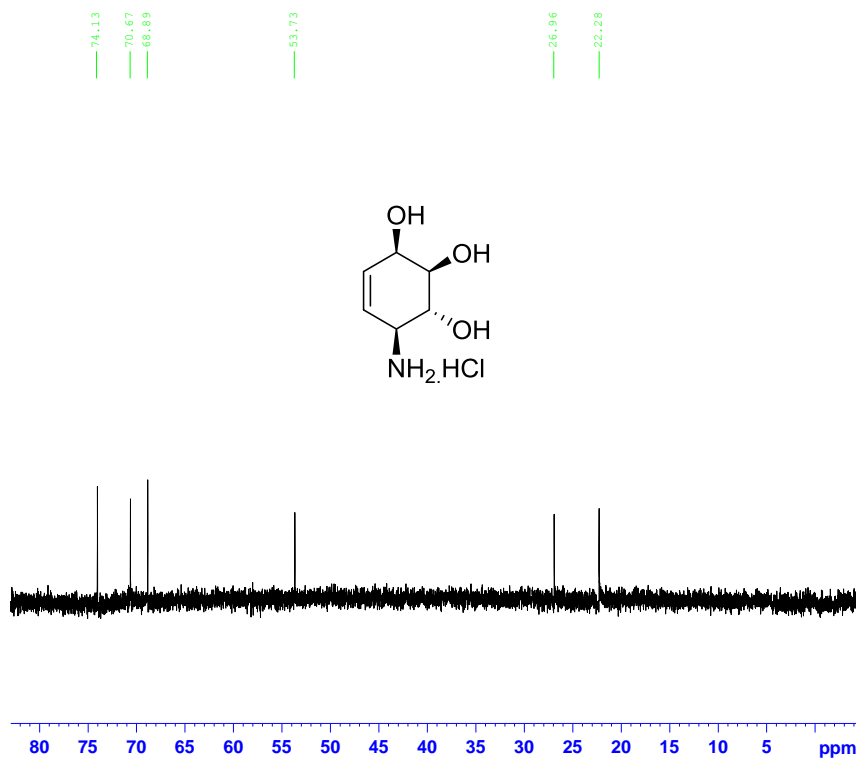

```

NAME aminocyclitol final 23 oct
EXPNO 2
PROCNO 1
Date_ 20131026
Time_ 14.33
INSTRUM spect
PROBHD 5 mm CPTCI 1H-
PULPROG zgpg30
TD 65536
SOLVENT D2O
NS 6144
DS 16
SWH 48076.922 Hz
FIDRES 0.733596 Hz
AQ 0.6816244 sec
RG 2.8
DW 10.400 usec
DE 6.50 usec
TE 298.0 K
D1 2.0000000 sec
D11 0.0300000 sec
TD0 1

----- CHANNEL f1 -----
NUC1 13c
P1 11.80 usec
PL1 -2.20 dB
PL1W 138.40063477 W
SF01 201.2330858 MHz

----- CHANNEL f2 -----
CPDPRG2 waltz16
NUC2 1H
PCPD2 60.00 usec
PL2 3.00 dB
PL12 19.48 dB
PL13 24.00 dB
PL2W 11.58211422 W
PL12W 0.25048809 W
PL13W 0.09200000 W
SFO2 800.2124400 MHz
SI 32768
SF 201.2129650 MHz
WDW EM
SFB 0
LB 1.00 Hz
GB 0
PC 4.00

```

Aminocyclitolfinal25thoct2013.002.001.1r.esp

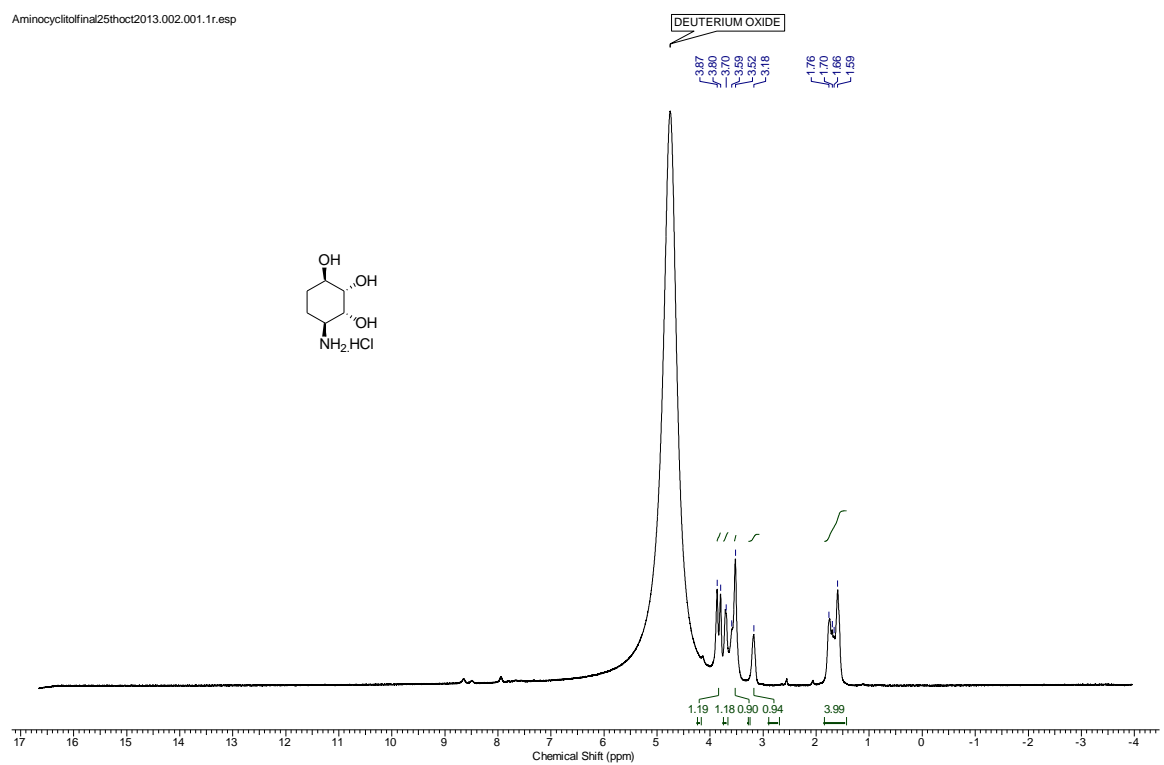

71.968
69.280
68.832

50.840

24.785
22.770

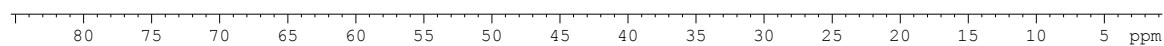

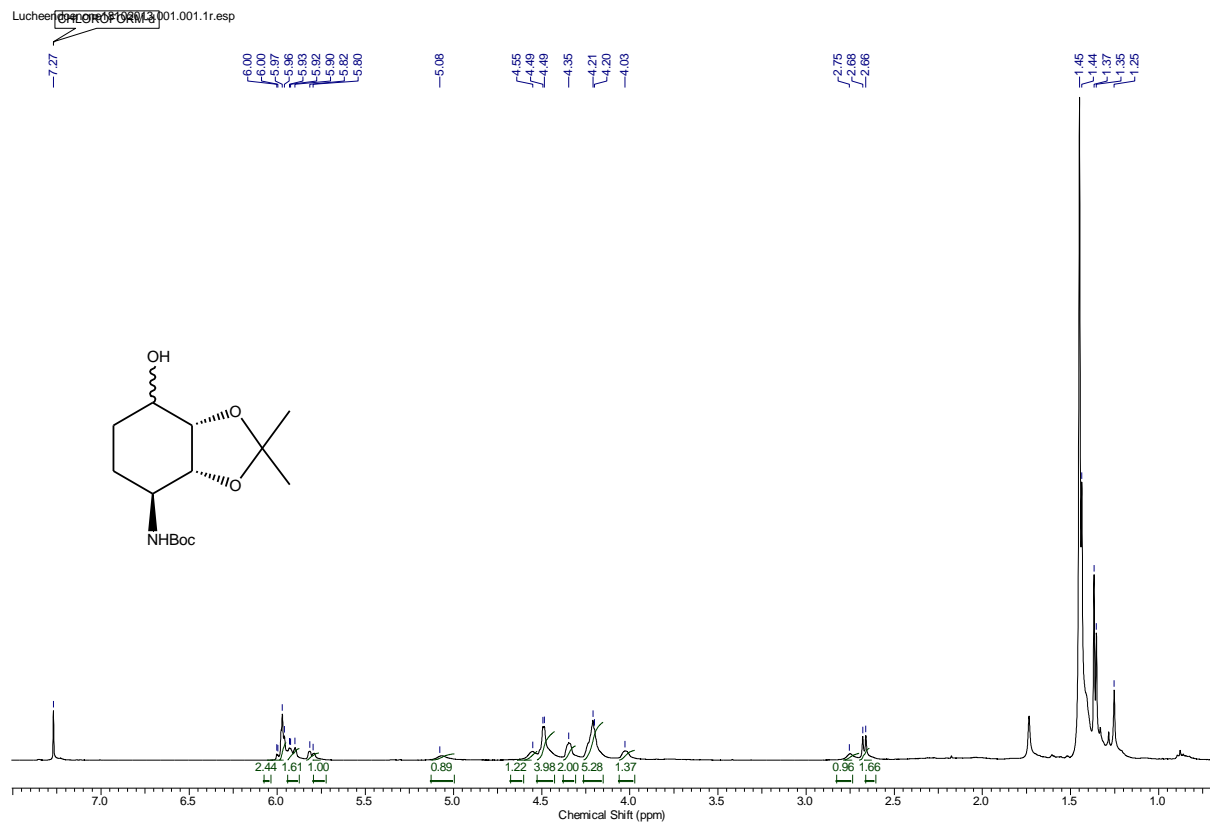

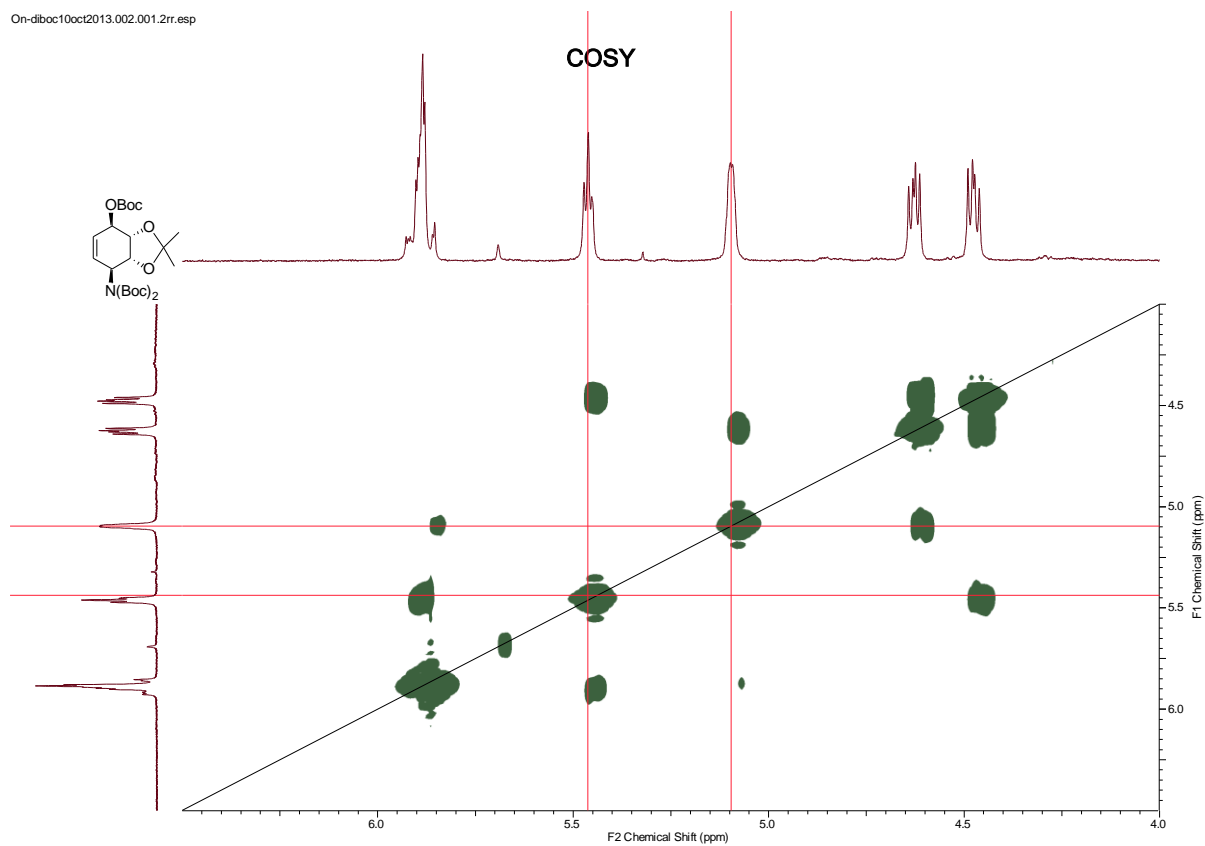
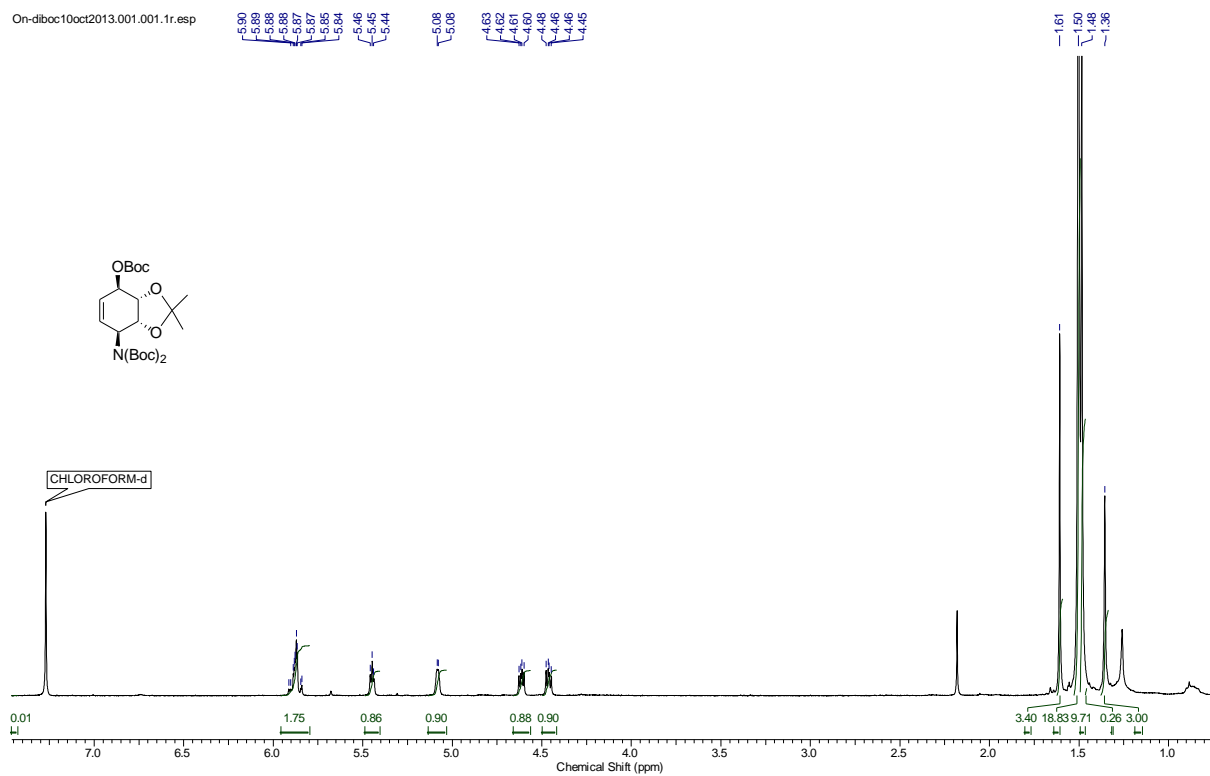

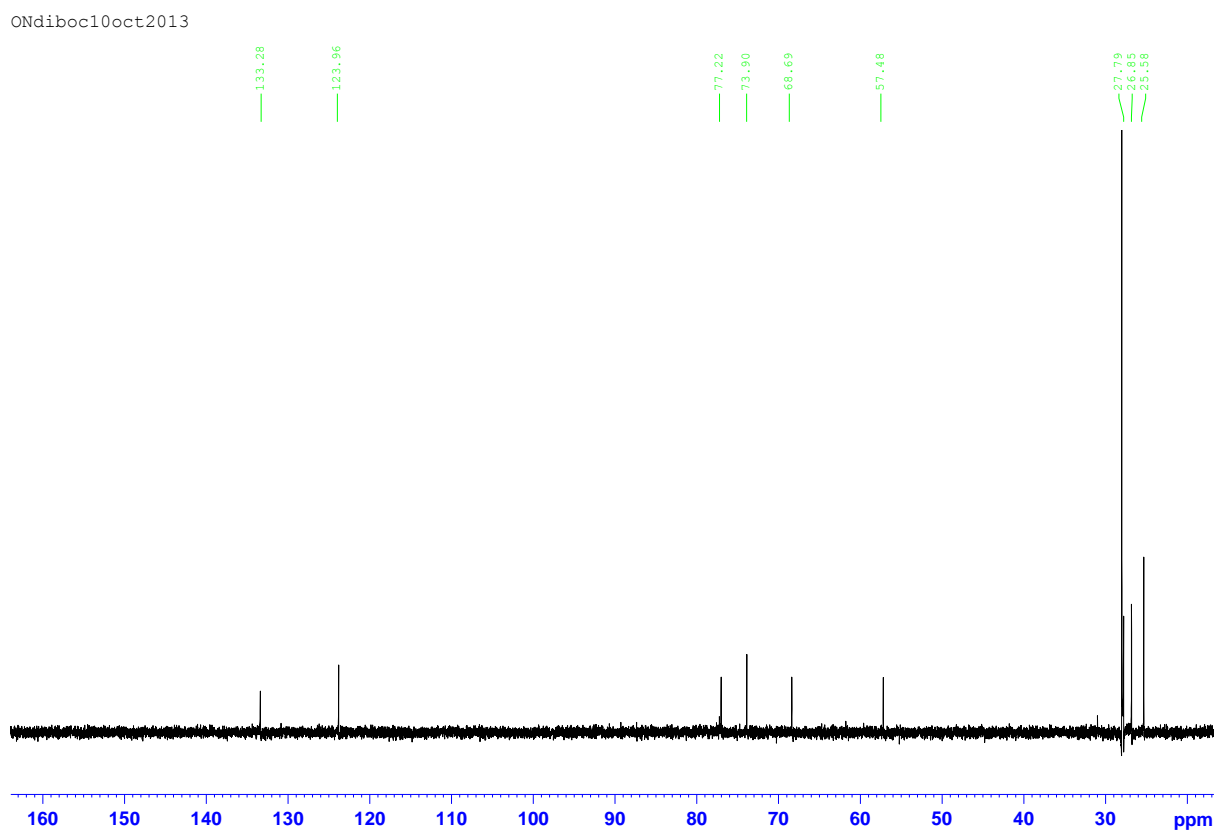
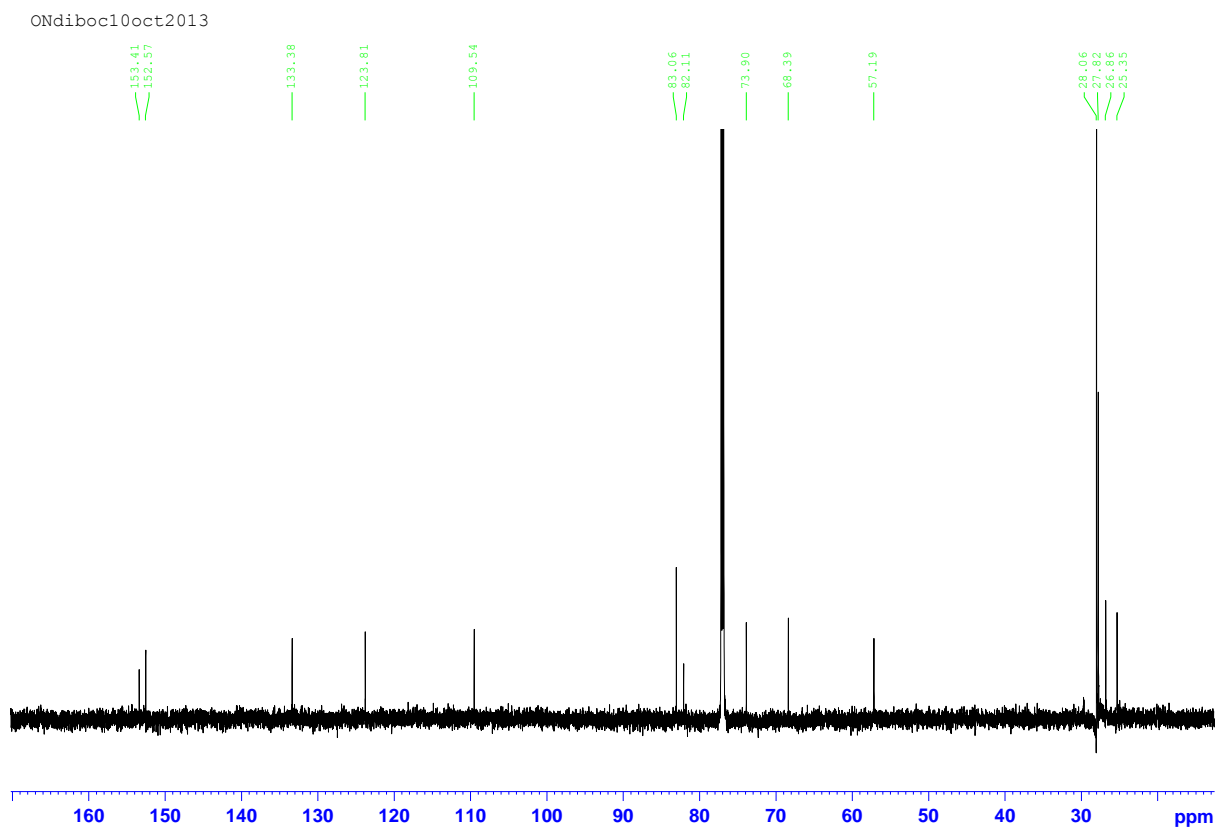

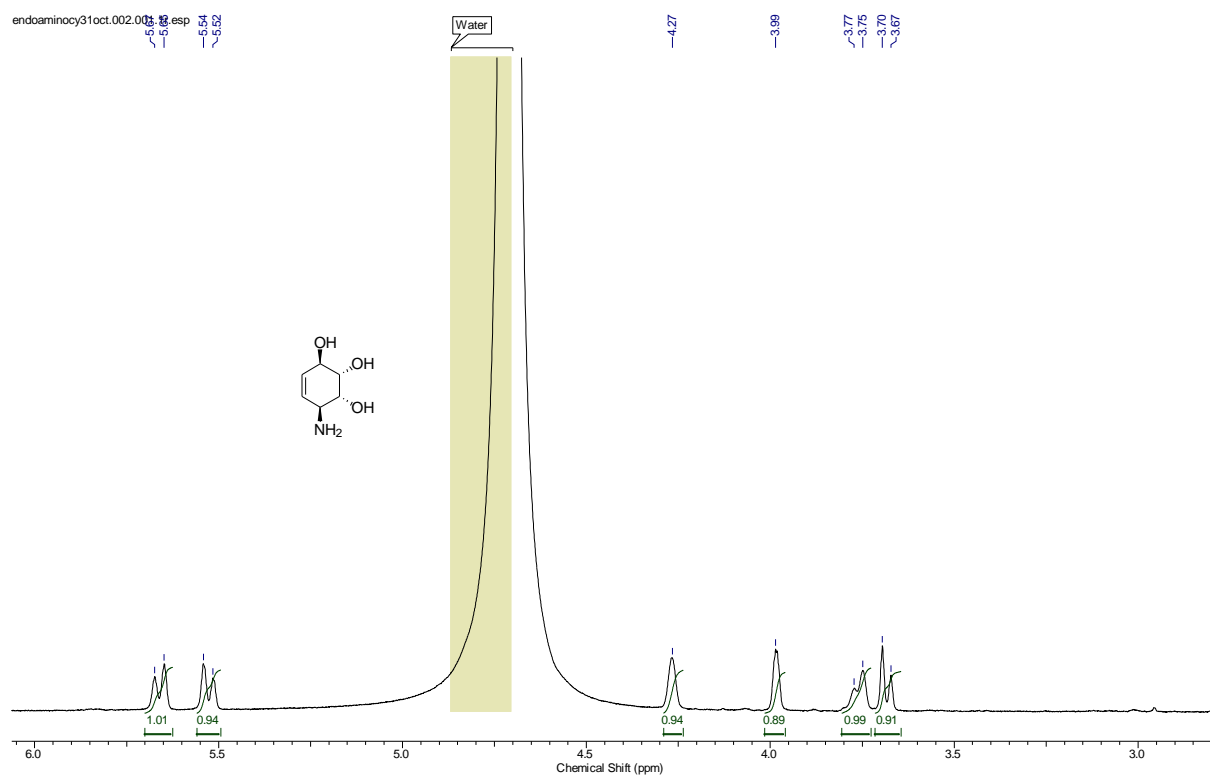
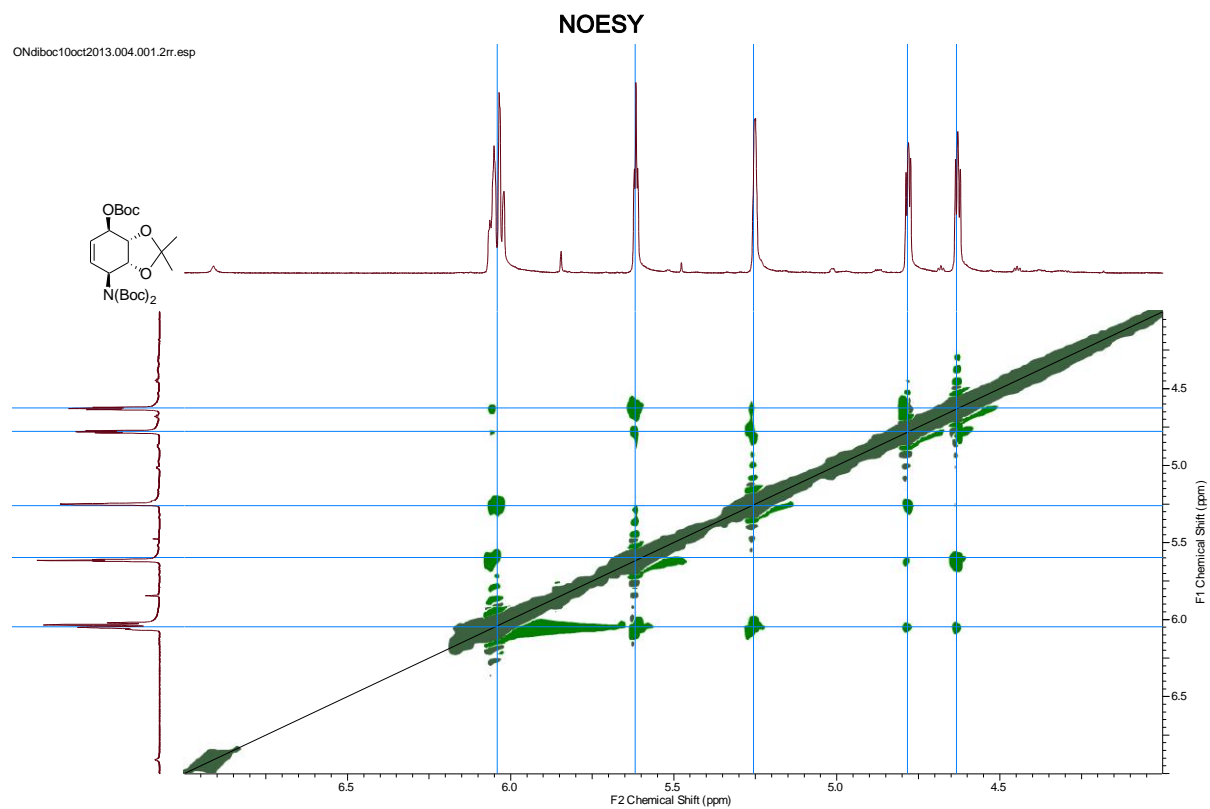

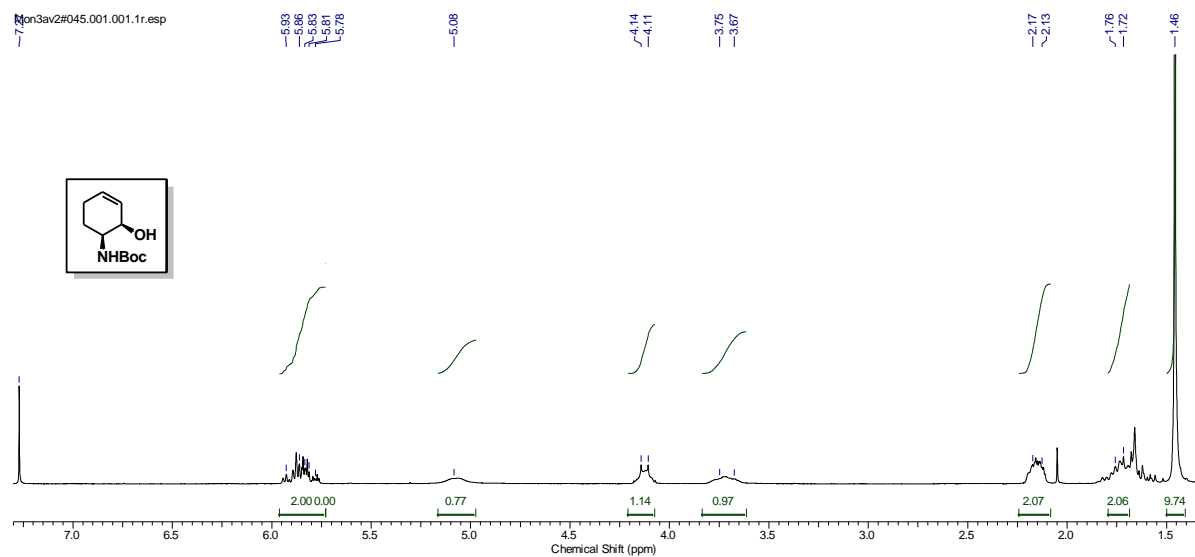
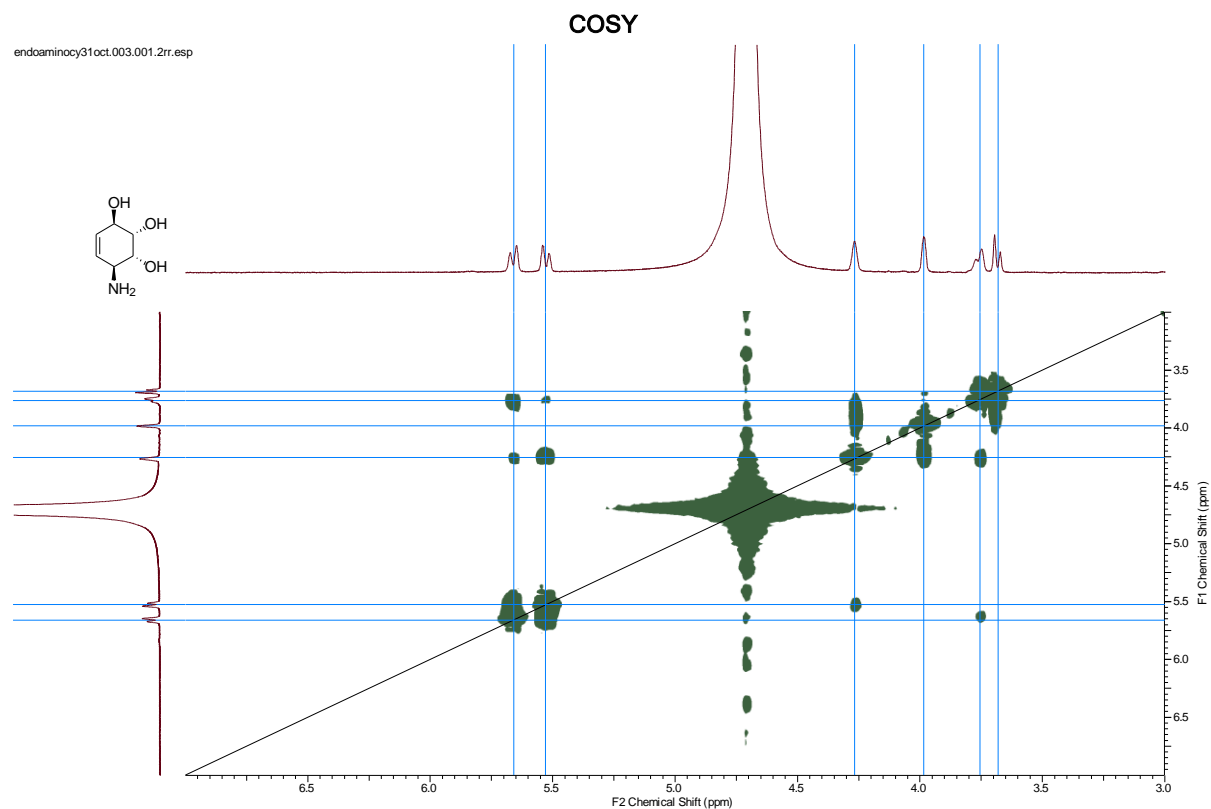

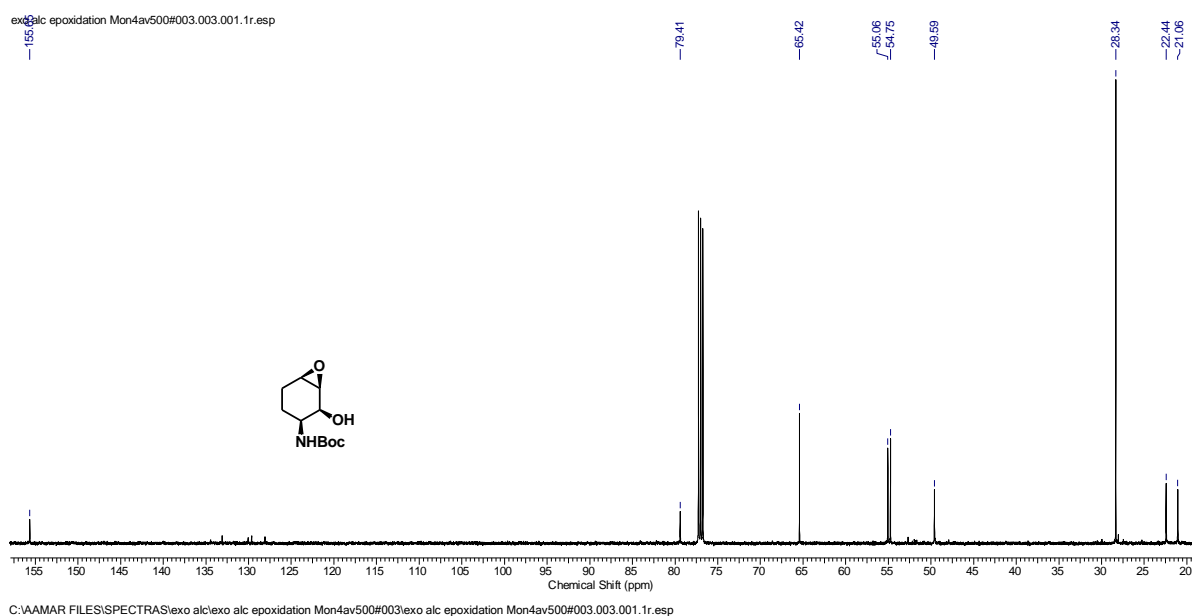
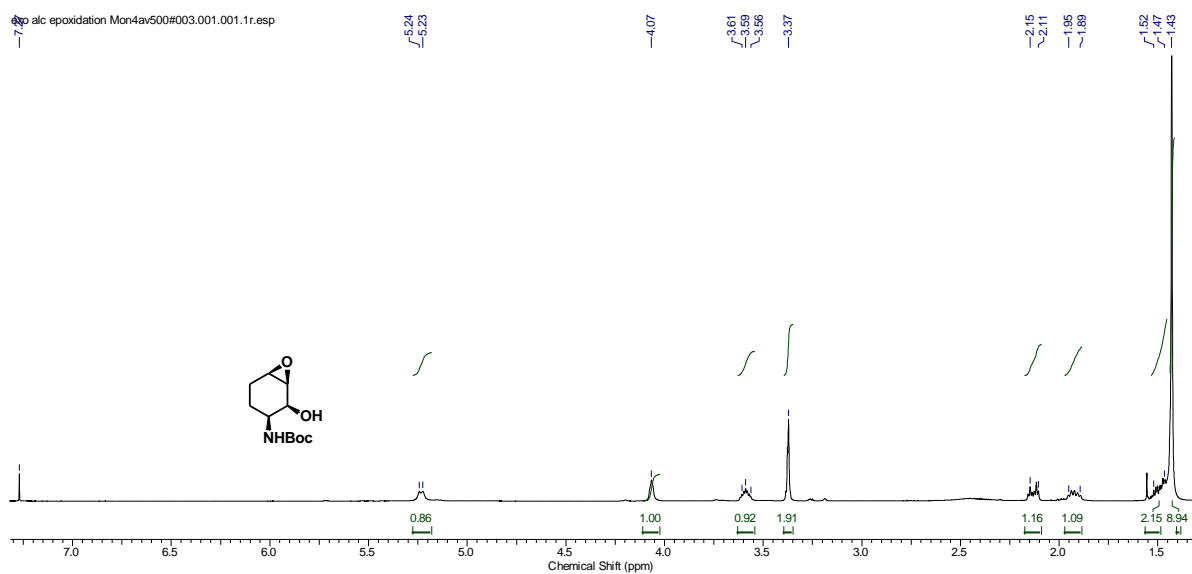

05-11-2011 12:54:43
dd
DEPT135

exo alc epoxidation Mon4av500#003.002.001.1r.esp

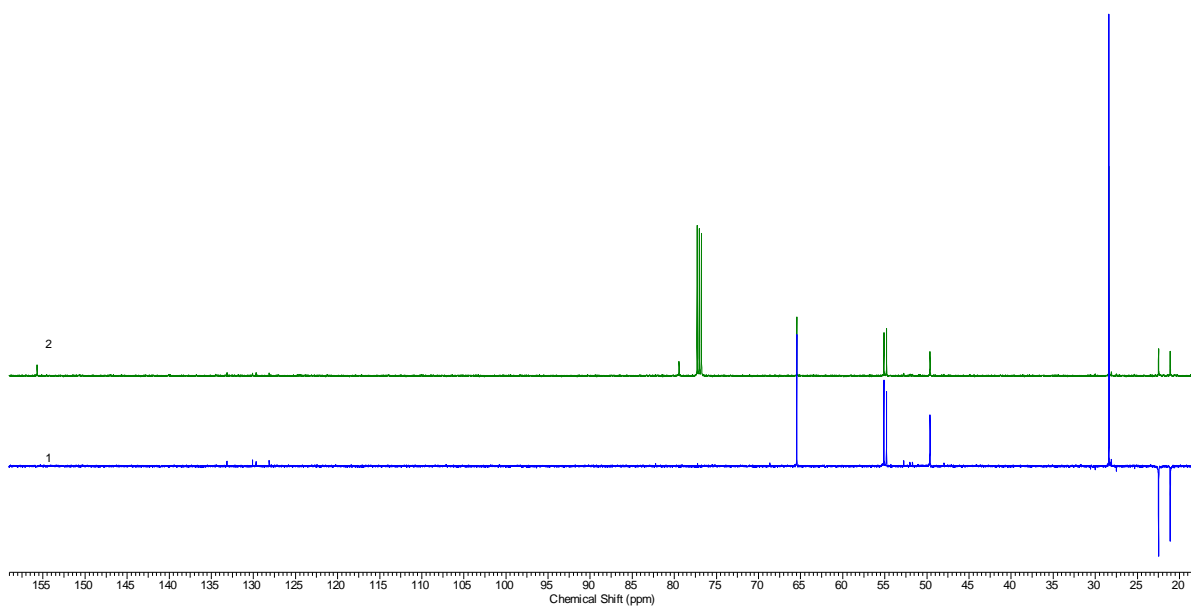

C:\AAMAR FILES\SPECTRAS\exo alc\exo alc epoxidation Mon4av500#003\exo alc epoxidation Mon4av500#003.002.001.1r.esp

exo alc epoxidation Mon4av500#003.002.001.1r.esp

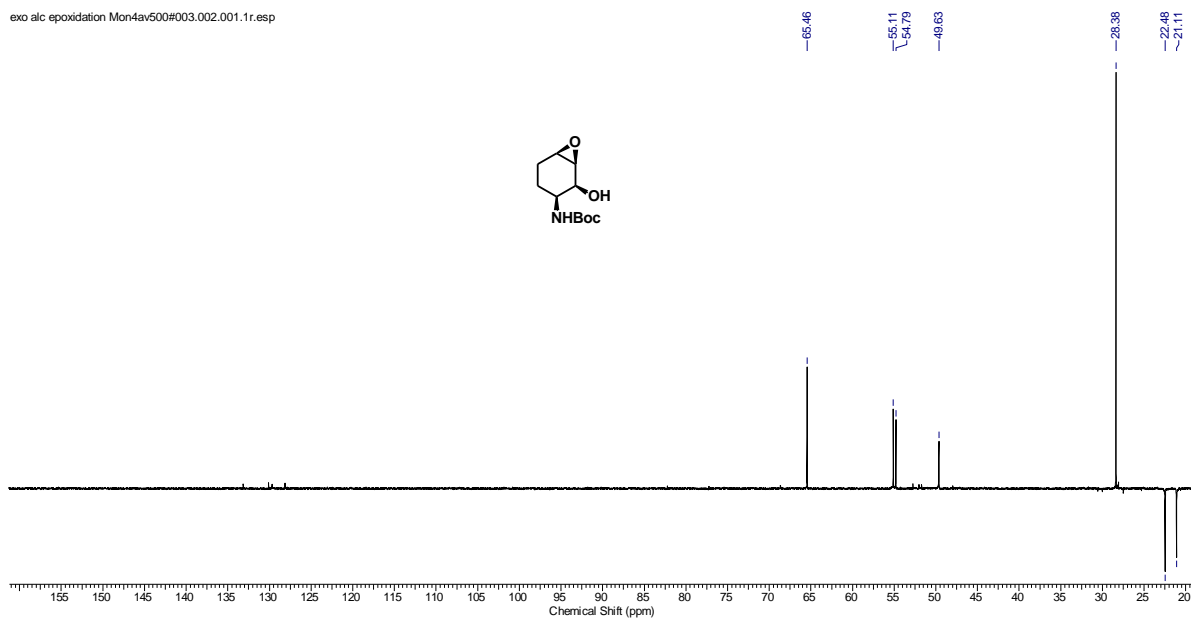

C:\AAMAR FILES\SPECTRAS\exo alc\exo alc epoxidation Mon4av500#003\exo alc epoxidation Mon4av500#003.002.001.1r.esp

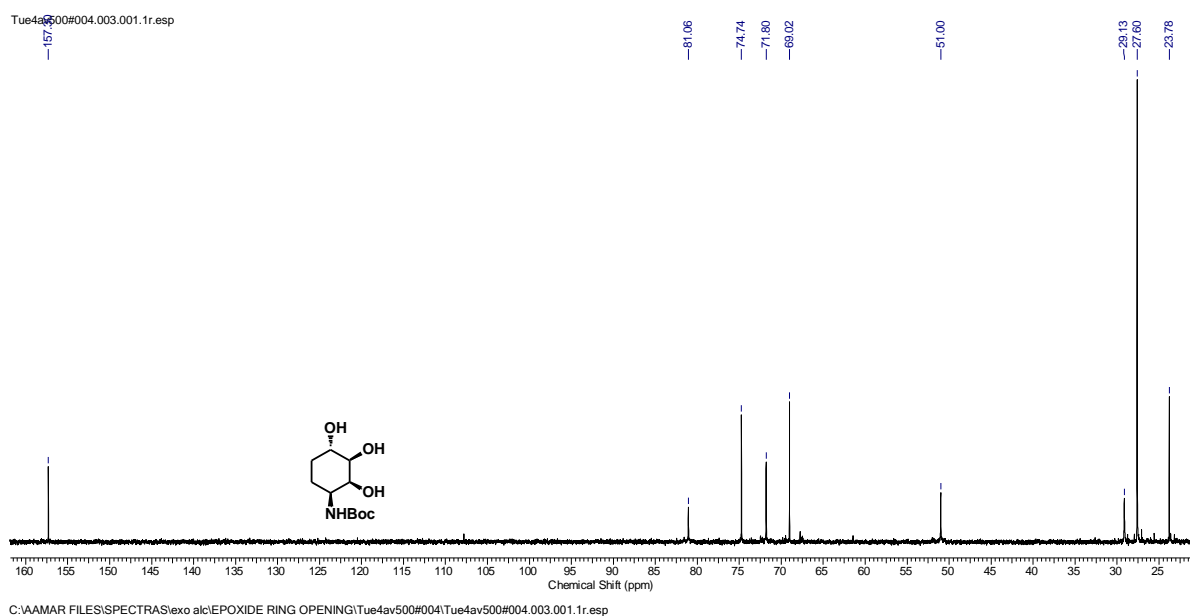
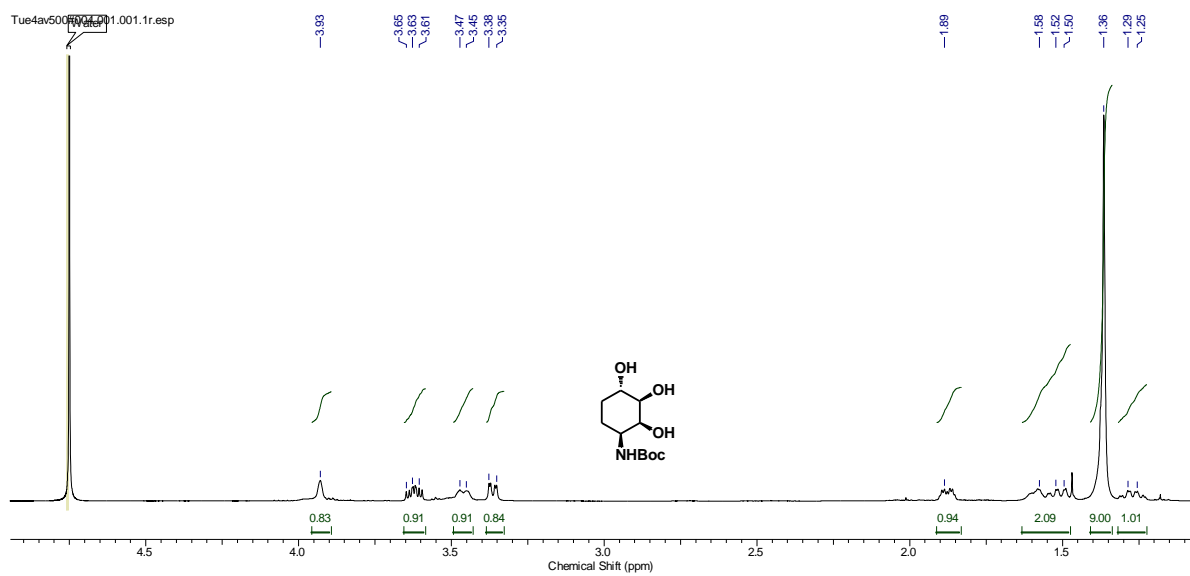

epoxide opening

05-11-2011 15:25:12
dd
DEPT135

Tue4av500#004.002.001.1r.esp

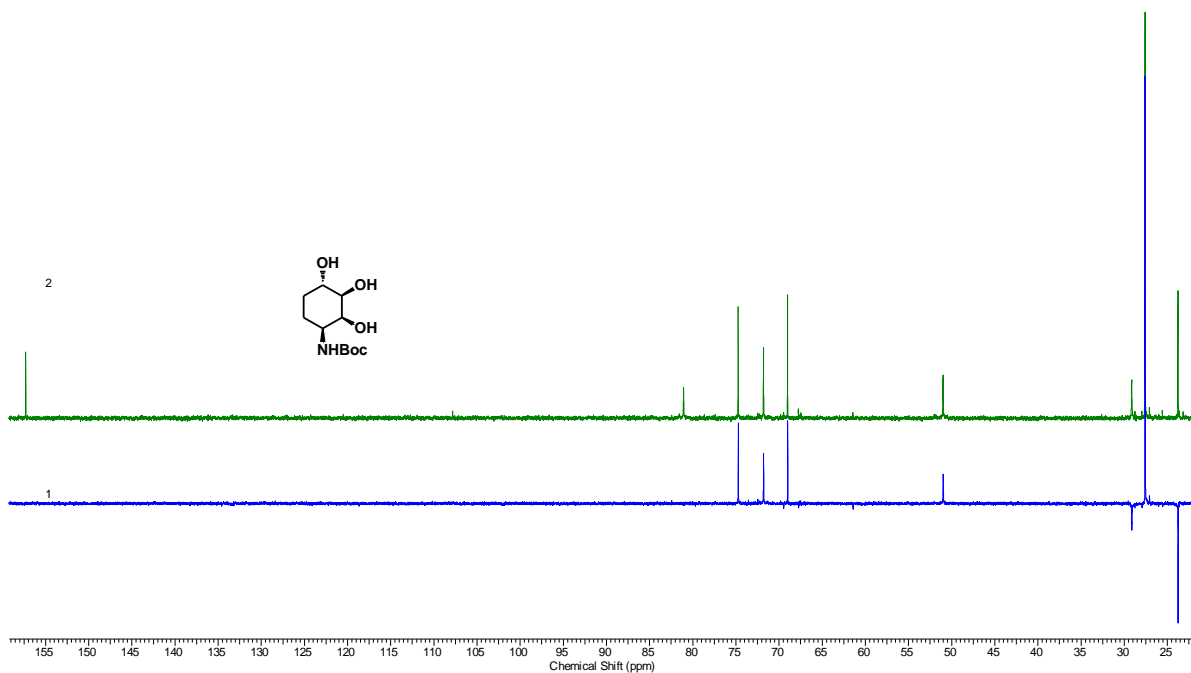

C:\AAMAR FILES\SPECTRAS\exo alc\EPOXIDE RING OPENING\Tue4av500#004\Tue4av500#004.002.001.1r.esp

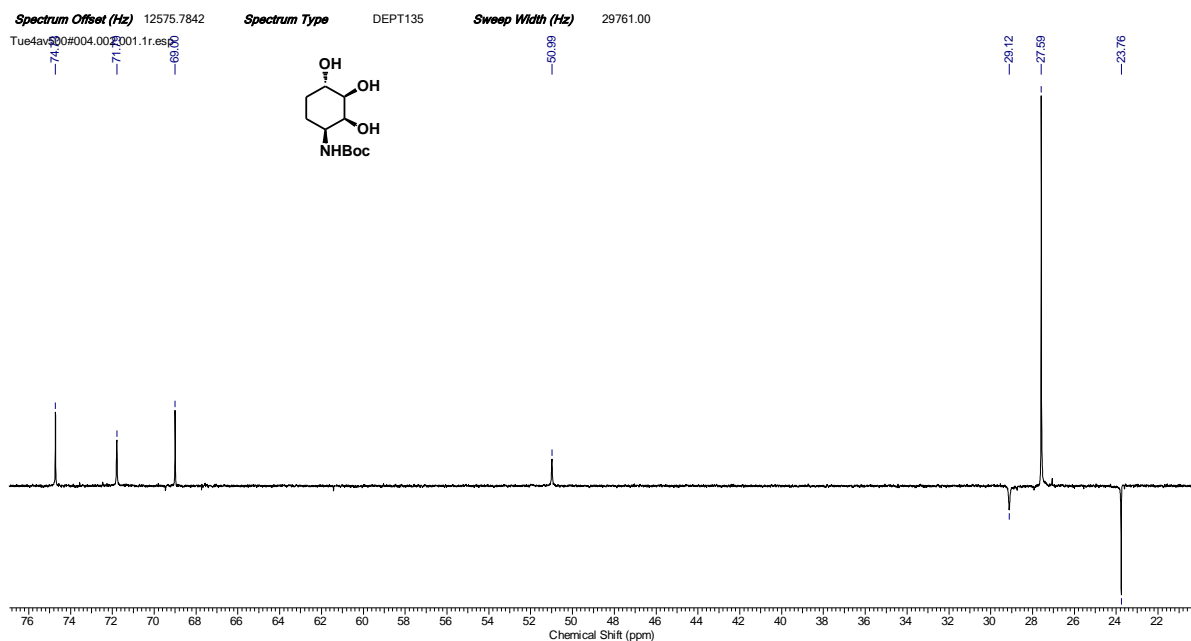

C:\AAMAR FILES\SPECTRAS\exo alc\EPOXIDE RING OPENING\Tue4av500#004\Tue4av500#004.002.001.1r.esp

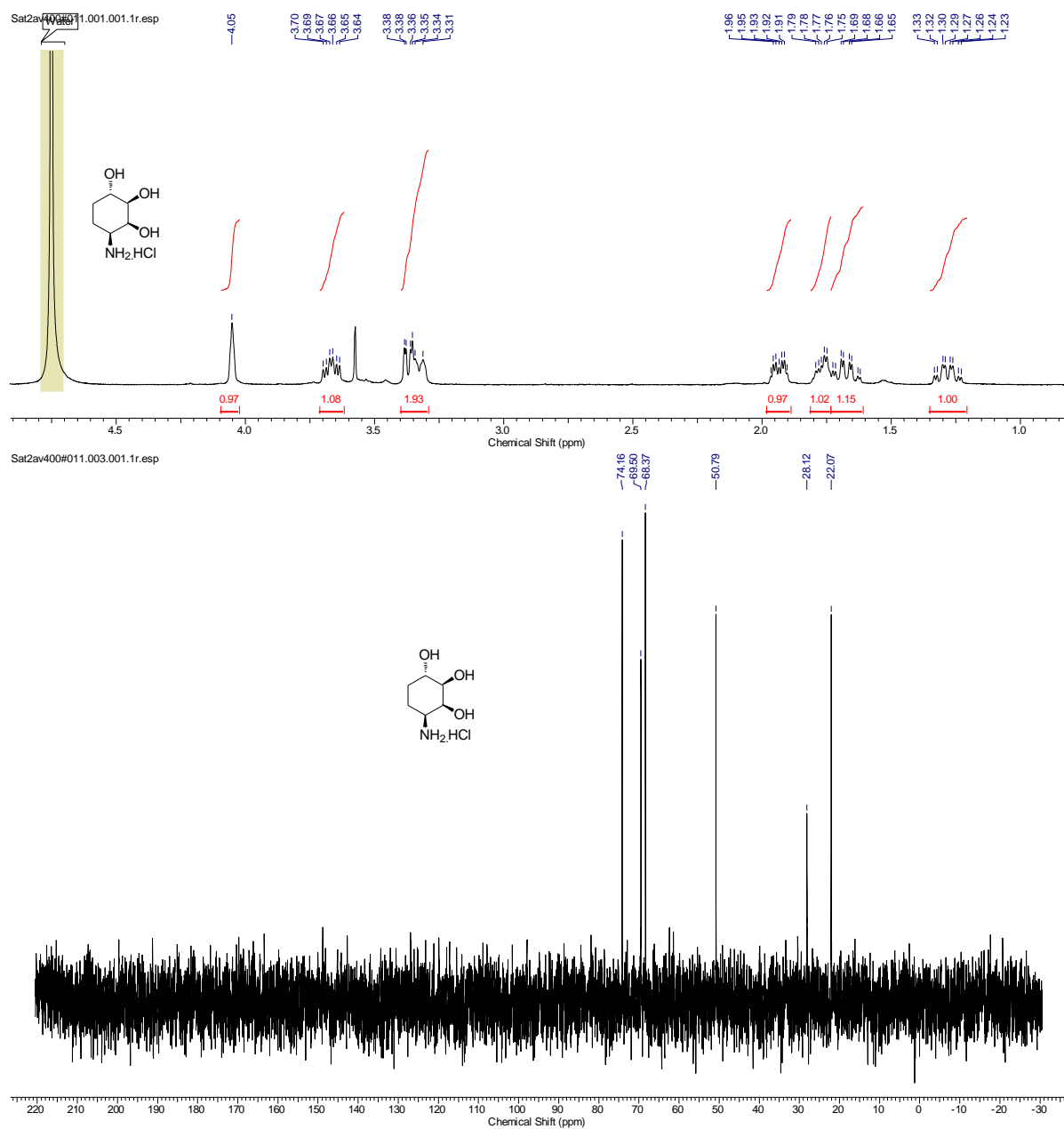

Sat2av400#011.002.001.1r.esp

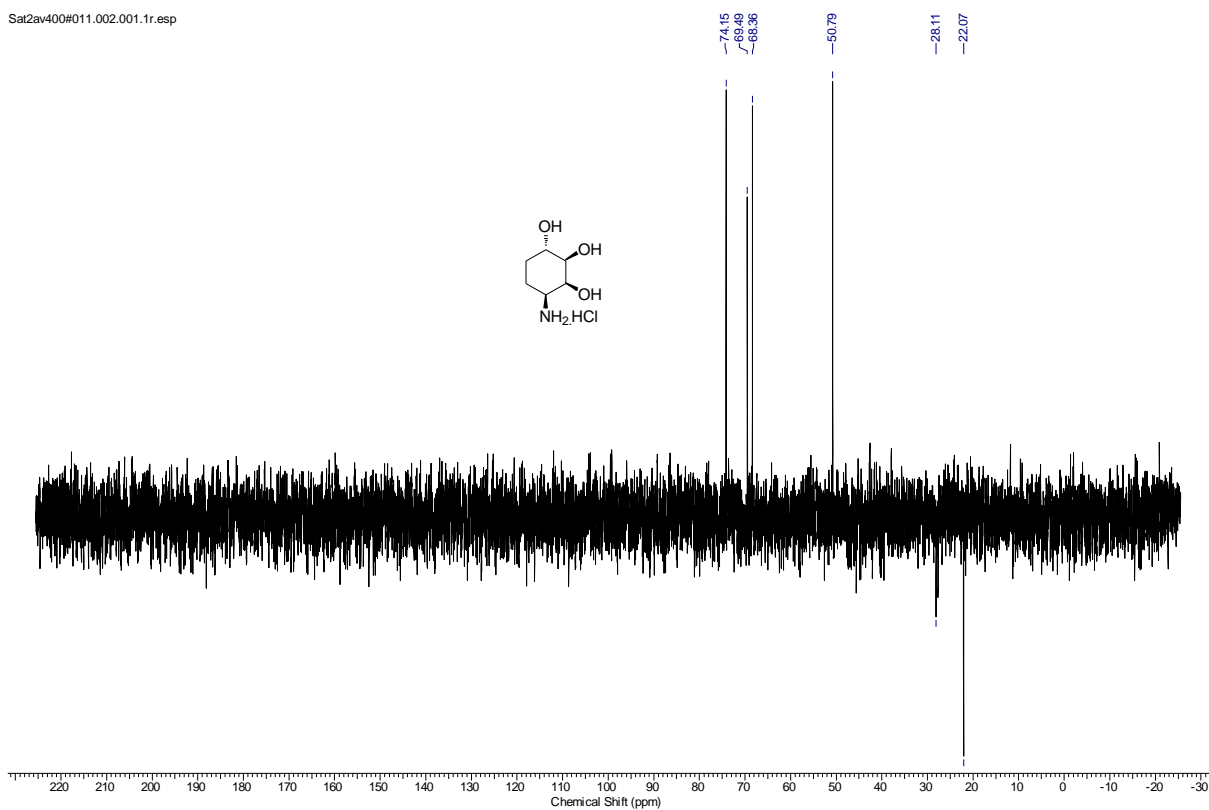

Temperature (degree C) 27.000

Mon6av2#040.001.001.1r.esp

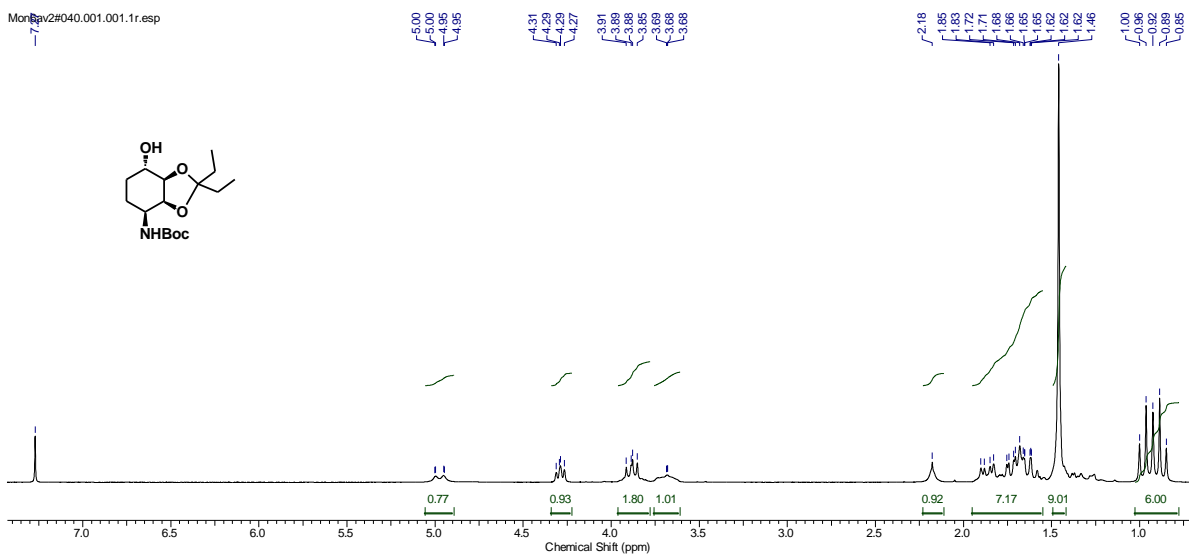

C:\AAMAR FILES\SPECTRAS\exo alciACETAL PROTECTION\Mon6av2#040\Mon6av2#040.001.001.1r.esp

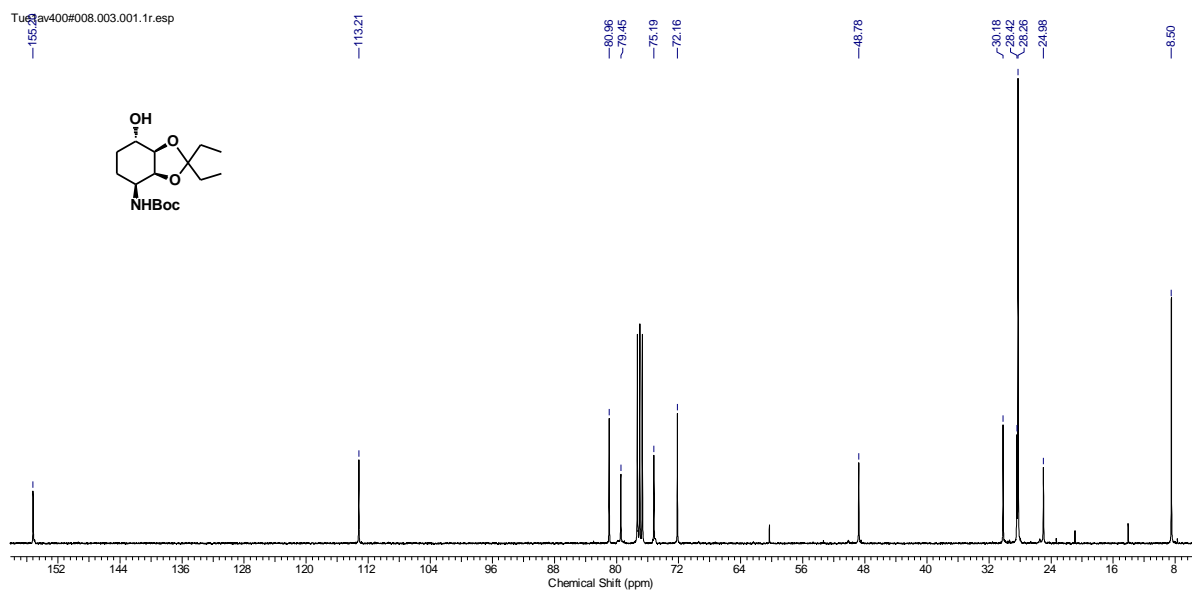

acetal protection of epoxide opening

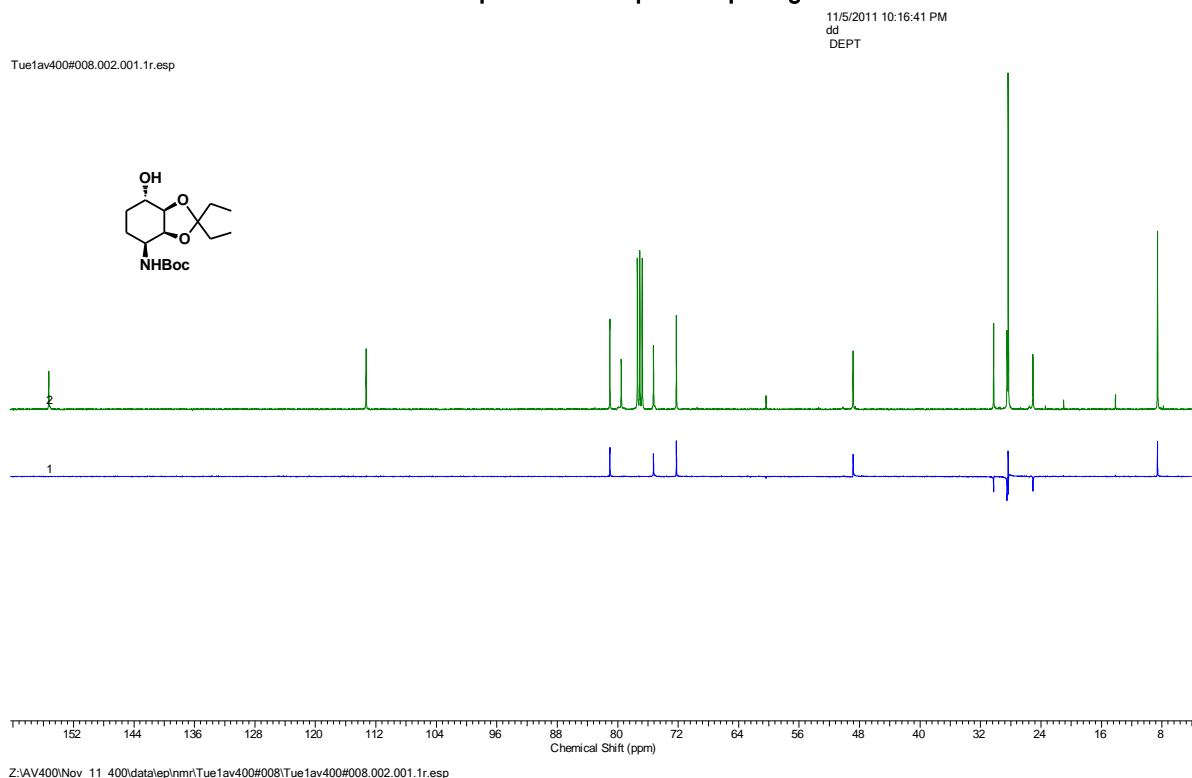

Temperature (degree C) 22.300

Tue1av400#008.002.001.1r.esp

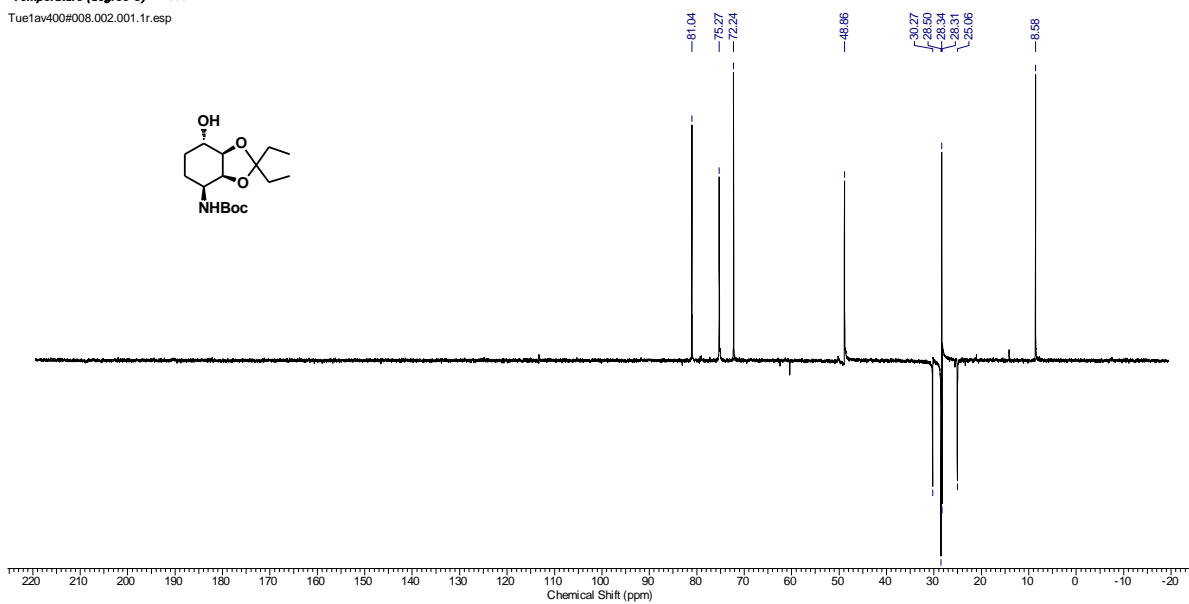

Z:\AV400\Nov_11_400\data\ep\nmr\Tue1av400#008\Tue1av400#008.002.001.1r.esp

Fri1av400#016.001.001.1r.esp

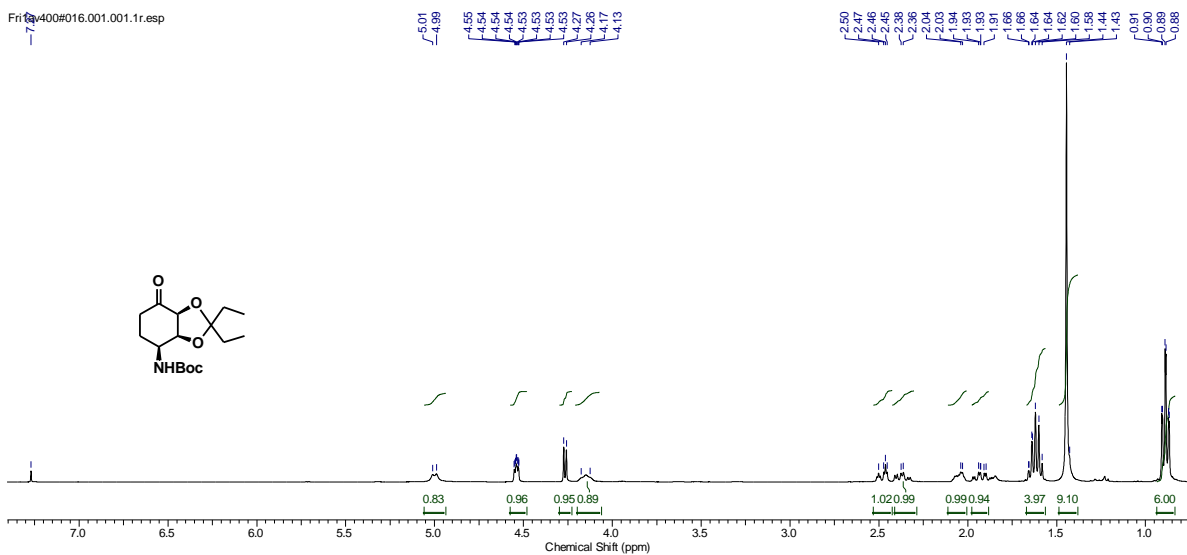

C:\AAMAR FILES\SPECTRAS\exo alclbx oxidation\Fri1av400#016\Fri1av400#016.001.001.1r.esp

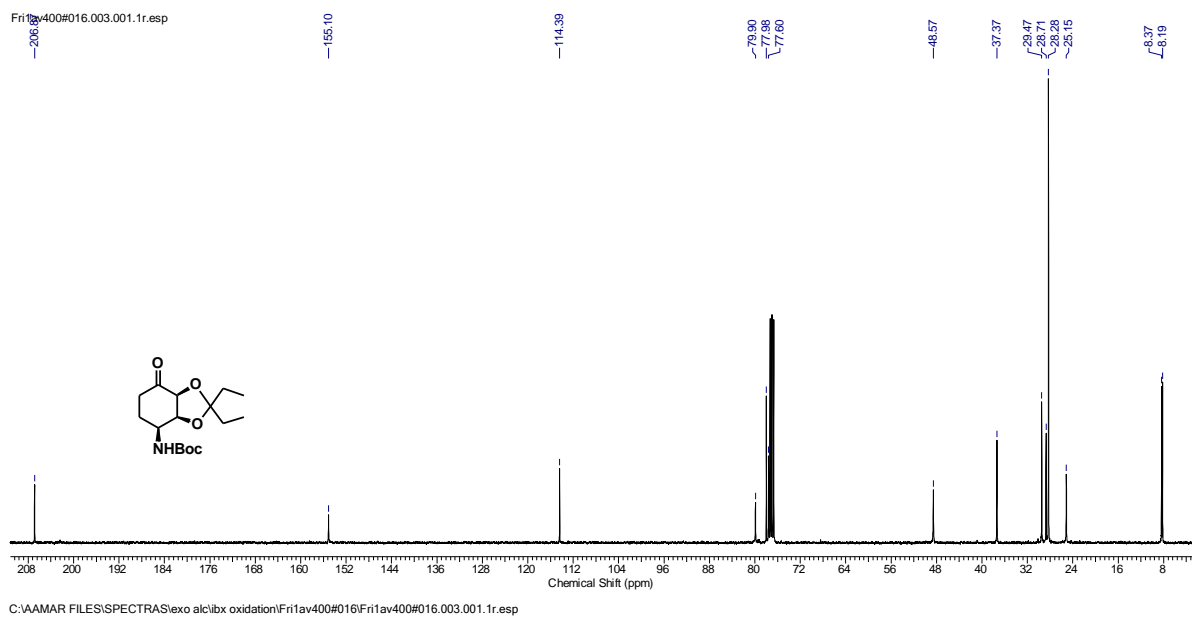

ketone

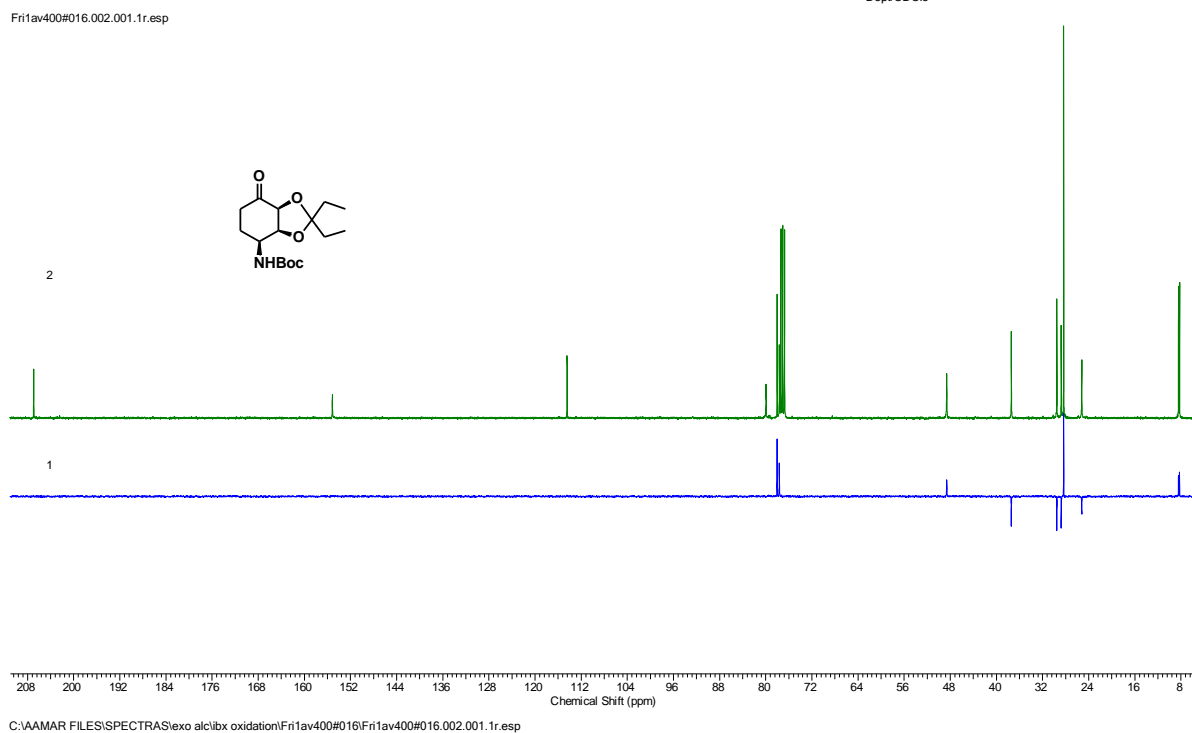
05-11-2011 22:49:25
dd
Dept/CDCI3

Fri1av400#016.002.001.1r.esp

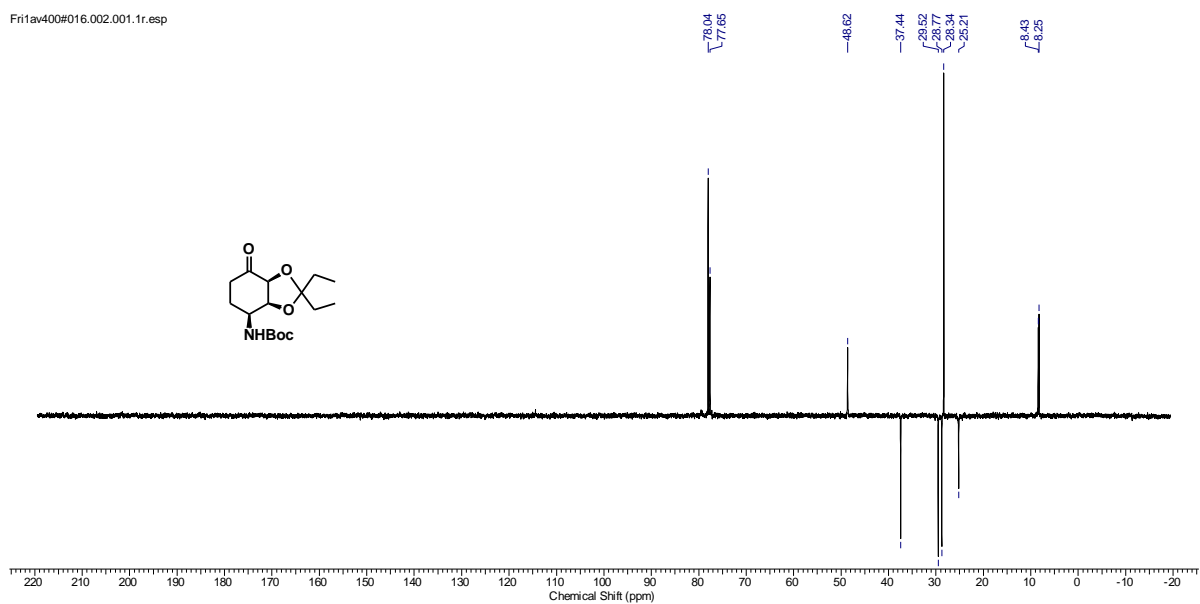

C:\AAMAR FILES\SPECTRAS\exo alclibx oxidation\Fri1av400#016\Fri1av400#016.002.001.1r.esp

Exoeneone

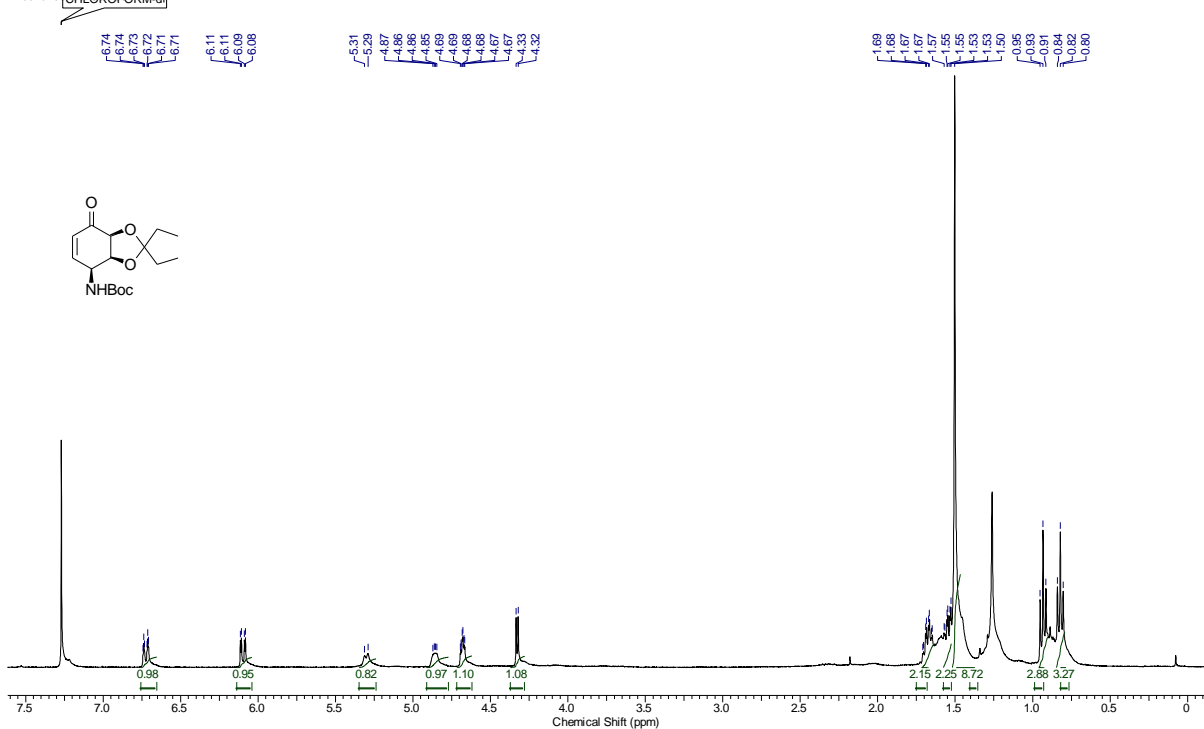

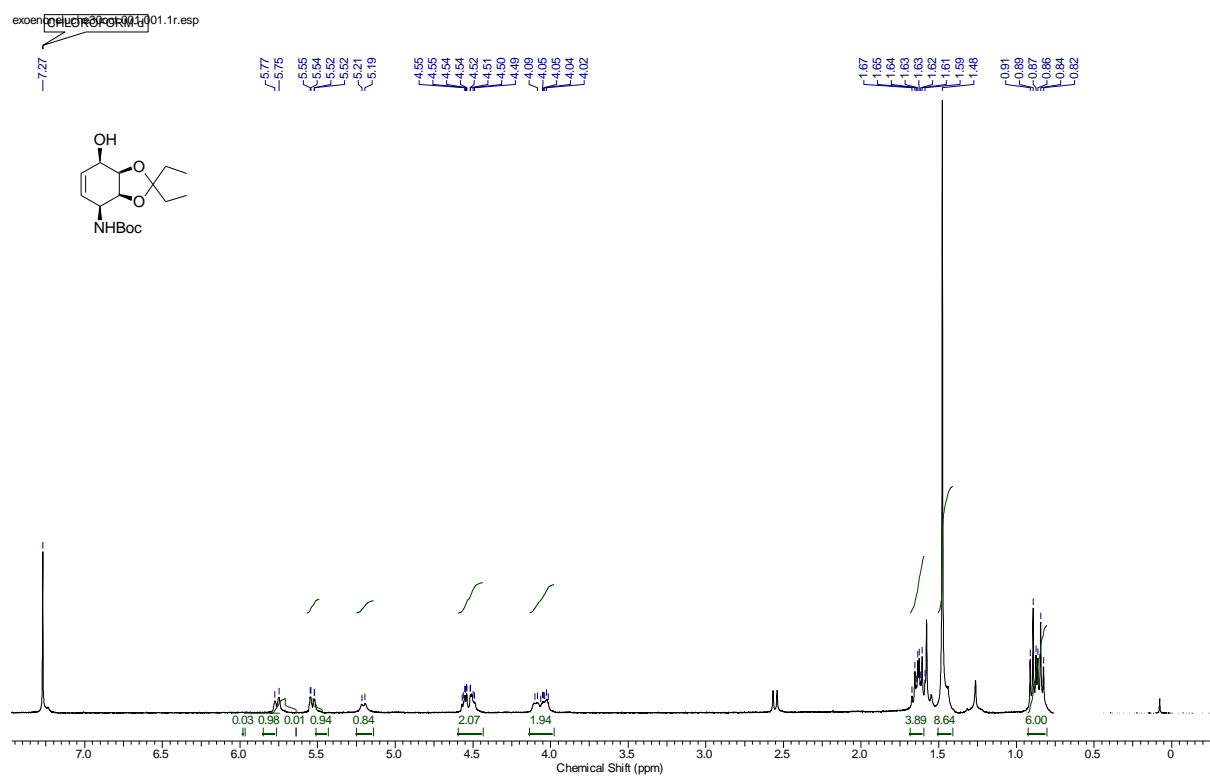
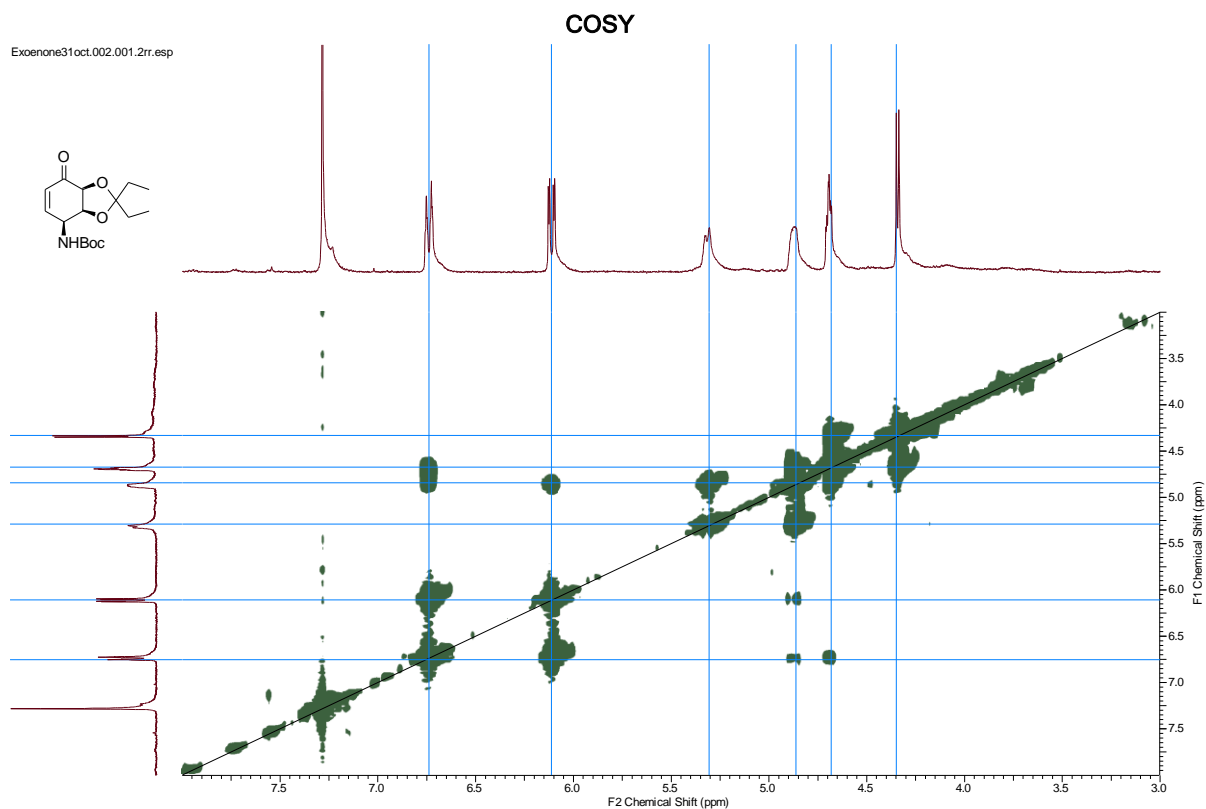

All-cis Aminocyclitol 31OCT13 For DD.001.001.1r.esp

