

**Gibberellin Production: Strain Improvement
and Process Optimization in Stirred Tank
Reactor**

A

THESIS

SUBMITTED TO THE

UNIVERSITY OF PUNE

FOR THE DEGREE OF

DOCTOR OF PHILOSOPHY

IN

BIOTECHNOLOGY

BY

GEETANJALI J. LALE

UNDER THE GUIDANCE OF

DR. RAMCHANDRA V. GADRE

AT

CHEMICAL ENGINEERING AND PROCESS DEVELOPMENT DIVISION

CSIR-NATIONAL CHEMICAL LABORATORY

PUNE-411008, INDIA

August 2014

Dedicated to my parents and guide...

CERTIFICATE

This is to certify that the work incorporated in the thesis entitled '**GIBBERELLIN PRODUCTION: STRAIN IMPROVEMENT AND PROCESS OPTIMIZATION IN STIRRED TANK REACTOR**' submitted by **Ms. Geetanjali J. Lale** was carried out by the candidate under my supervision at Chemical Engineering and Process Development Division, National Chemical Laboratory, Pune 411008 (India). Such material as has been obtained from other sources has been duly acknowledged in the thesis.

Dr. Ramchandra V. Gadre

Senior Principal Scientist

Chemical Engineering & Process Development Division,

National Chemical Laboratory,

Pune - 411008 (India)

August 2014

DECLARATION BY THE CANDIDATE

I hereby declare that the work incorporated in the thesis entitled '**GIBBERELLIN PRODUCTION: STRAIN IMPROVEMENT AND PROCESS OPTIMIZATION IN STIRRED TANK REACTOR**' is my own work conducted under the supervision of **Dr. Ramchandra V. Gadre**, at Chemical Engineering and Process Development Division, National Chemical Laboratory, Pune 411008 (India). I further declare that to the best of my knowledge, this thesis does not contain any part of work, which has been submitted for the award of any degree either of this University or any other University without proper citation.

Ms. Geetanjali J. Lale

(Research student)

Dr. Ramchandra V. Gadre

(Research guide)

ACKNOWLEDGEMENTS

This gives me immense pleasure to express a deep sense of respect and gratitude to my research supervisor, Dr. Ramchandra V Gadre, Scientist, CSIR-National Chemical Laboratory (NCL), Pune, for his constant encouragement and sustained interest during my stay at NCL. He taught, criticized, encouraged and advised all of which have helped me during my Ph.D. work and preparation of the thesis. He has given me the benefit of his excellent training in abundant measure. His principles and values have always been a source of inspiration for me. Without his intellectual inputs, motivation and consistent support the objective would not have been accomplished. His creative thinking, administrative skills, unbiased nature and gracious personality inspired me a lot. His idea of giving independence in designing experiments really inspired me many a times. Working with him was an enriching and enlivening experience. Throughout my tenure at NCL we have had numerous fruitful discussions that I believe will contribute enormously towards my success in future career. I really consider myself honoured for having him as my mentor.

I am equally obliged to Dr. Sanjay N Nene, Head, Biochemical Engineering group, (NCL) for his encouragement and help to carry out study of Ph.D. work. I especially appreciate the freedom he has given me in the laboratory. His dynamic personality and energetic nature is an inspiration.

I am extremely grateful to Mr. Vitthal V Jogdand, for his valuable suggestions, keen interest, constant encouragement and critical evaluation of my thesis. I thank all the staff members of Biochemical Engineering Group, especially Dr. H V Adikane, Dr. Rita Verma, Dr. D M Thakar and other members for their support in completing this work.

My special thanks to Dr. Mrs Smita Gadre for her guidance, motivation and good wishes. She was always there whenever I needed her.

I extend my warm gratitude to my dear friends Renuka Joshi, Trupti, Dipa, Anirudh, Abhijeet Karale, Laxman, Parin and Mahesh Khot for helping me in my experimental work, for their valuable suggestions and technical support. I would like to thank Mukesh Patale, Santosh Dhule, Amol Dive, Hitesh Suthar, Jahnvi Shah, Vaishali Sajjan, Supriya Patil, Prabhakar Shrivastav, Asiya Khan, Amey Bhide, Bhalchandra Vaidya, Sandeep Golegaonkar and Karthik Narayanan for their co-operation and ensuring a friendly working ambiance.

I gratefully acknowledge the Council of Scientific and Industrial Research, New Delhi, for the award of Senior Research Fellowship and Director, NCL for allowing me to carry out my research in NCL. I am thankful to all staff of NCL facilities, Library facility, all other laboratories, Administration and Security.

No words can suffice to acknowledge the encouragement and moral support given by my parents. I am grateful to my sisters and their family for their constant support, blessings and love. I appreciate support from husband Rajesh and my child Raghav. This work would not have been possible without their support and persistent motivation. And finally I appreciate support from all my well wishers.

CONTENTS

CHAPTER 1

1.1 Chemistry of gibberellins	4
1.2 Biological Activity of gibberellins	5
1.3 Commercial uses of gibberellins	8
1.3.1 Commercial uses of GA ₃	8
1.3.2 Commercial uses of GA ₄₊₇	9
1.4 Biosynthesis of gibberellins in <i>F. fujikuroi</i>	11
1.4.1 Regulation of GA gene expression in <i>F. fujikuroi</i>	16
1.5 Production of gibberellins	19
1.5.1 Strain improvement	19
1.5.2 Media optimization	21
1.5.3 Environmental factors in gibberellin production	23
1.5.4 Fermentation techniques for GA ₃ production	23
1.6 Extraction and purification of gibberellins (GA ₃ , GA ₄ and GA ₇)	28
1.7 REFERENCES	32

CHAPTER 2

2.1 Analytical and Microbiological Methods Employed During Course of Study	47
2.2 Chemicals	47
2.3 Details of Analytical methods	48
2.3.1 Microscopic Count of Cells/Fragments and Protoplasts	48
2.3.2 Dry cell weight Estimation	48
2.3.3 Residual sugar analysis	48
2.3.3.1 Estimation of sugar by using LIQUIZONE Glucose-MR GOD-POD kit	48
2.3.3.2 Estimation of reducing sugar by DNSA (Dinitro salicylic acid method)	49
2.3.3.4 Estimation of sugars by HPLC	51
2.3.4 Estimation of intracellular lipids	51
2.3.5 High Performance Liquid Chromatography (HPLC)	52
2.3.5.1 HPLC Instrument	52
2.3.5.2 Sample preparation	52
2.3.5.3 Analysis of Gibberellins	52
2.3.5.3a Reversed Phase HPLC Analysis of Gibberellic Acid (GA ₃)	53
2.3.5.3b Reversed Phase HPLC Analysis of Gibberellin ₄ (GA ₄)	54

2.3.5.4 Reversed Phase HPLC Analysis of Fusaric acid	55
2.3.5.5 Reversed Phase HPLC Analysis of Moniliformin	56
2.3.6 Melting point analysis of extracted and purified Gibberellin A ₃	56
2.3.7 Nuclear Magnetic Resonance (NMR)	57
2.3.8 Liquid Chromatography with Mass Spectrophotometer (LC-MS)	57
2.4 REFERENCES	58
CHAPTER 3	
3.1 INTRODUCTION	62
3.2 MATERIALS AND METHODS	67
3.2.1 Microorganisms	67
3.2.2 Chemicals	67
3.2.3 Media composition	68
3.2.4 Growth in Tube Culture	70
3.2.5 Growth in Shake flasks	70
3.2.6 Screening of strains for GA ₃ production	70
3.2.7 Choice of carbon source	71
3.2.8 Screening of nitrogen sources for selected GA ₃ producing cultures	71
3.2.9 Mutagenesis of selected strain	71
3.2.10 Mutant selection	73
3.2.10.1 Screening of the selected mutants in tubes	73
3.2.10.2 Shake flask screening of selected mutants for GA ₃ production	74
3.2.10.3 Comparison of selected mutants	74
3.2.11 Characterization of selected mutant Mut189 of <i>F. fujikuroi</i>	76
3.2.11.1 Morphology	76
3.2.11.2 Carbohydrate utilization	76
3.2.12 Protoplast fusion	76
3.2.12.1 Microorganisms	78
3.2.12.2 Optimization of protoplast formation	78
3.2.12.3 Separation and Regeneration of protoplasts	79
3.2.12.4 Intergeneric protoplast fusion and selection of fusant	79
3.2.12.5 Production of GA ₃ by Selected Fusant	79
3.3 RESULT AND DISCUSSION	80

3.3.1 Selection of strain for production of GA ₃	80
3.3.2 HPLC analysis	83
3.3.3 Choice of carbon source	84
3.3.4 Screening of nitrogen sources for selected GA ₃ producing culture	86
3.3.5 Mutagenesis	89
3.3.6 Preliminary screening of the selected mutants	96
3.3.7 Shake flask screening of selected mutants for GA ₃ production	96
3.3.8 Comparison of selected mutants	100
3.3.9 Characterization of selected mutant Mut189 of <i>F. fujikuroi</i>	103
3.3.9.1 Morphology	103
3.3.9.2 Carbohydrate utilisation by mutant Mut189	104
3.3.10 Protoplast fusion	107
3.3.10.1 Optimization of protoplast formation	107
3.3.10.2 Protoplast Fusion and Selection of fusant	110
3.3.10.3 Production of GA ₃ by Selected Fusant	112
3.4 CONCLUSIONS	114
3.5 REFERENCES	116
CHAPTER 4	
4.1 INTRODUCTION	124
4.2 MATERIAL AND METHODS	128
4.2.1 Shake flask cultures	128
4.2.2 Choice of carbon source for GA ₃ production	129
4.2.3 Choice of nitrogen source for GA ₃ production	129
4.2.4 Evaluation of growth and GA ₃ production in media with different concentrations of defatted soyabean meal	130
4.2.5 Mutant stability for GA ₃ production	130
4.2.6 Time-course study of GA ₃ production by Mut189 in optimized medium	131
4.2.7 Effect of control of pH on rate of GA ₃ production	131
4.2.8 Effect of temperature on GA ₃ production during stationary phase	131
4.2.9 Effect of glucose feeding on GA ₃ production	132
4.2.10 Evaluation of mutant Mut189 for GA ₃ production in 14 L fermenter	132
4.2.10.1 Batch fermentation for GA ₃ production	131
4.2.10.2 Extractive fermentation	136

4.2.10.3 Repeated batch fermentation	137
4.2.10.4 Fed-batch fermentation for GA ₃ production	137
4.2.11 Purification and characterization of GA ₃ from the fermentation broth	138
4.3 RESULTS AND DISCUSSION	141
4.3.1 Choice of carbon source for GA ₃ production	141
4.3.2 Choice of nitrogen source for GA ₃ production	142
4.3.3 Evaluation of growth and GA ₃ production in media with different concentrations of defatted soyabean meal	143
4.3.4 Mutant stability for GA ₃ production	145
4.3.5 Time course study of GA ₃ production by mutant Mut189 in optimized medium	146
4.3.6 Effect of pH on rate of GA ₃ production	147
4.3.7 Effect of temperature on GA ₃ production during stationary phase	149
4.3.8 Effect of glucose feeding on GA ₃ production	150
4.3.9 Evaluation of mutant Mut189 for GA ₃ production in 10 L fermenter	153
4.3.9.1 Batch fermentation	153
4.3.9.2 Extractive Fermentation	157
4.3.9.3 Repeated batch fermentation	159
4.3.9.4 Fed batch fermentation	160
4.3.10 Analysis of fusaric acid and moniliformin	166
4.3.11 Purification and characterization of GA ₃ from the fermentation broth	168
4.4 CONCLUSIONS	173
4.5 REFERENCES	175
CHAPTER 5	
5.1 INTRODUCTION	183
5.2 MATERIALS AND METHODS	185
5.2.1 Microorganisms	185
5.2.2 Media	185
5.2.3 Culture conditions	189
5.2.3.1 Tube cultures	189
5.2.3.2 Shake flask cultures	189
5.2.4 Screening of cultures for production of GA ₄	189
5.2.5 Effect of pH on GA ₄ production	190
5.2.6 Preparation of wheat gluten	190

5.2.7 Choice of carbon source for GA ₄ production by mutant Mut189	191
5.2.8 Screening of different nitrogen sources for GA ₄ production by Mut189	192
5.2.9 Evaluation of GA ₄ production in 10 L fermenter by mutant Mut189	192
5.3 RESULTS AND DISCUSSION	193
5.3.1 Screening of cultures for production of GA ₄	193
5.3.2 HPLC Analysis of GA ₄	195
5.3.3 Effect of pH control on GA ₄ production	198
5.3.4 Choice of carbon source for GA ₄ production by mutant Mut189	199
5.3.5 Screening of different nitrogen sources for GA ₄ production by Mut189	200
5.3.6 Evaluation of GA ₄ production in 10 L fermenter by mutant Mut189	203
5.4 CONCLUSIONS	206
5.5 REFERENCES	207

LIST OF FIGURES AND TABLES

CHAPTER 1

Figure 1.1	Summary of effects of GAs on plants
Figure 1.2	Effect of application of GA ₃ on grapes
Figure 1.3	Biosynthesis of gibberellins and other co-metabolites in <i>F. fujikuroi</i>
Figure 1.4	Biochemical pathway of gibberellins synthesis in <i>F. fujikuroi</i>
Figure 1.5	Macro and Microconidia from <i>F. fujikuroi</i>
Table 1.1	Chemical and physical properties of gibberellins
Table 1.2	Genes of the gibberellin (GA) biosynthetic gene cluster: function and regulation
Table 1.3	A few patents on gibberellins (GA ₃ and GA ₄) production by <i>Fusarium</i> strain and their separation from culture filtrate
Table 1.4	Properties of ER from various organisms

CHAPTER 3

Figure 3.1	Schematic representation of UV exposure chamber
Figure 3.2	Shake flasks with different medium volumes
Figure 3.3	Shake Flask with increased medium strength
Figure 3.4	Scheme of fusion for transference of genes for GA ₃ production from fungi into the yeast culture
Figure 3.5	Growth of <i>F. fujikuroi</i> strains obtained from NCIM on RA agar
Figure 3.6	Reverse phase HPLC chromatogram of A) standard compound GA ₃ B) a sample of fermentation broth
Figure 3.7	Growth of <i>F. fujikuroi</i> NCIM 1019 on RA agar containing different carbon sources
Figure 3.8	Comparison of nitrogen sources for GA ₃ production by <i>F. fujikuroi</i> 1019
Figure 3.9	Effect of nitrogen sources on the growth of <i>F. fujikuroi</i> 1019 and its specific gibberellic acid productivity
Figure 3.10	Technique used for strain improvement by random mutagenesis
Figure 3.11a	UV survival curve for <i>F. fujikuroi</i> NCIM 1019

Figure 3.11b	EMS survival curve for <i>F. fujikuroi</i> NCIM 1019
Figure 3.12	Comparison of GA ₃ production rates of selected mutants
Figure 3.13	Effect of different medium volume in 250 ml Erlenmeyer flasks on GA ₃ production by morphological mutants of <i>F. fujikuroi</i>
Figure 3.14	Effect of medium strength in 250 ml Erlenmeyer flasks on GA ₃ production by morphological mutants of <i>F. fujikuroi</i>
Figure 3.15	Phase contrast micrographs a) <i>F. fujikuroi</i> NCIM 1019 b) Mutant Mut189
Figure 3.16	Scanning electron micrographs a) <i>F. fujikuroi</i> NCIM 1019 b) Mutant Mut189
Figure 3.17a	Carbohydrate utilization by <i>F. fujikuroi</i> NCIM1019
Figure 3.17b	Carbohydrate utilization by Mutant Mut189
Figure 3.18	Effect of age of the mycelium on the release of protoplasts from <i>T. cutaneum</i> NCIM 3352 and Mut32
Figure 3.19	Effect of enzyme concentration on the release of protoplasts from <i>T. cutaneum</i> NCIM 3352 and Mut32
Figure 3.20	Effect of osmotic stabilisers on release the of protoplasts from <i>T. cutaneum</i> NCIM 3352 and Mut32
Figure 3.21	Growth of parent fungus, parent yeast and selected fusant on regeneration agar
Figure 3.22	Micrographs of parent fungus, parent yeast and selected fusant
Figure 3.23	Photograph of shake flask cultures of parent yeast, parent fungus and selected fusant
Table 3.1	Comparison of GA ₃ production by five <i>Fusarium</i> strains
Table 3.2	Colony characteristics of <i>Fusarium</i> strains on RA media
Table 3.3	Effect of different carbon sources on GA ₃ production
Table 3.4	Summary of Mutagenesis Series
Table 3.5	<i>F. fujikuroi</i> mutants screened through test tube for enhanced production of gibberellic acid
Table 3.6	<i>F. fujikuroi</i> mutants selected for shake flask culture study
Table 3.7	Growth characteristics of selected mutants of <i>F. fujikuroi</i> on RA media
Table 3.8	Growth and gibberellic acid production by selected mutants of <i>F.</i>

fujikuroi

CHAPTER 4

- Figure 4.1 Fermenter set up for GA₃ production
- Figure 4.2 Schematic representation of inoculum preparation for 10 L laboratory fermenter
- Figure 4.3 Schematic representation of Extractive Fermentation
- Figure 4.4 Steps involved in extraction and purification of gibberellic acid
- Figure 4.5 Effect of defatted soyabean meal on growth and GA₃ production
- Figure 4.6 Time course profile of gibberellic acid production in shake flask culture
- Figure 4.7 pH values in the flasks with different quantities of CaCO₃
- Figure 4.8 Effect of pH on GA₃ production by Mut189
- Figure 4.9a Effect of different glucose feed concentration on GA₃ production
- Figure 4.9b Effect of different glucose feed concentration on GA₃ production rate
- Figure 4.10 Control flasks: Total glucose addition
- Figure 4.11a Fermentation profile of *F. fujikuroi* mutant Mut189 in LMF medium
- Figure 4.11b GA₃ production profile of *F. fujikuroi* Mut189 during batch fermentation
- Figure 4.12 Fermentation profile of *F. fujikuroi* mutant Mut189 in LMF medium with controlled pH
- Figure 4.13 Extractive fermentation of GA₃ production by mutant Mut189 in LMF
- Figure 4.14 Fed-batch fermentation run F1 with mutant Mut189
- Figure 4.15a Fed-batch fermentation run F2 with mutant Mut189
- Figure 4.15b GA₃ production profile of Mut189 during fed batch F2
- Figure 4.15c Fed-batch fermentation run F3 with mutant Mut189
- Figure 4.15d A screen view of online fermentation data of process parameters acquired by NBS BioCommand Plus Software of fed-batch run F3
- Figure 4.16 Reversed phase HPLC chromatogram of standard fusaric acid
- Figure 4.16a Reversed phase HPLC chromatogram of fermentation broth of *F. fujikuroi* mutant Mut189

Figure 4.17	Reversed phase HPLC chromatogram of A) standard compound GA ₃ B) Purified GA ₃ from fermentation broth of Mut189
Figure 4.18	On-line spectral scanning of standard GA ₃
Figure 4.19	On-line spectral scanning of purified GA ₃
Figure 4.20	Mass spectra of authentic GA ₃ and purified GA ₃ from the fermentation broth
Figure 4.21	¹ H NMR spectra of the standard GA ₃
Figure 4.22	¹ H NMR spectra of the purified GA ₃ from fermentation broth
Table 4.1	Effect of different carbon sources on GA ₃ production by mutant Mut189
Table 4.2	Effect of different nitrogen sources on GA ₃ production by Mut189
Table 4.3	Stability of mutant Mut189 during four transfers and culture in shake flasks
Table 4.4	Effect of shift in temperature on GA ₃ production
Table 4.5	The Repeated Batch operation and GA ₃ production
Table 4.6	Summary of fermentation batches performed using mutant Mut189

CHAPTER 5

Figure 5.1	Preparation of wheat gluten by conventional laboratory scale dough process
Figure 5.2	Reversed phase HPLC chromatogram of A) standard compound GA ₄ B) a sample of fermentation broth
Figure 5.3	Mass spectra of authentic GA ₄
Figure 5.3a	Mass spectra of GA ₄ from the fermentation broth
Figure 5.4	Fermentation profile of <i>F. fujikuroi</i> mutant Mut189 in LFM medium
Figure 5.5	Glucose uptake and GA ₄ production by mutant Mut189
Table 5.1	Screening of <i>Fusarium</i> strains from NCIM and selected mutants of <i>F. fujikuroi</i> NCIM1019 for GA ₄ production in LFM
Table 5.2	GA ₄ production in shake flask with CaCO ₃
Table 5.2a	GA ₄ production in shake flasks without CaCO ₃

Table 5.3	Choice of carbon sources for GA ₄ production by mutant Mut189
Table 5.4	Comparison of nitrogen sources for GA ₄ production by mutant Mut189

ABBREVIATIONS, ACRONYMS AND SYMBOLS

°C	Degree centigrade
DCW	Dry cell weight
DNSA	Dinitro salicylic acid
DO ₂	Dissolved oxygen
EMS	Ethyl methyl sulphonate
g	Gram
GAs	Gibberellins
GA ₃	Gibberellin A ₃
GA ₄	Gibberellin A ₄
GA ₇	Gibberellin A ₇
h	Hour
HPLC	High performance liquid chromatography
L or l	Liter
LFM	Liquid fermentation medium
LMF	Liquid medium for fermentation
mg	Milligram
mm	Millimeter
Mut32	GA ₃ and carotenoid pigment producing mutant of <i>Fusarium fujikuroi</i> NCIM 1019
Mut189	GA ₃ and GA ₄ producing mutant of <i>Fusariumfujikuroi</i> NCIM 1019
min	Minute
NADH	Nicotinamide adenine dinucleotide
NADPH	Nicotinamide adenine dinucleotide phosphate
NCIM	National Collection of Industrial Microorganisms
PDB	Potato dextrose broth
rpm	Rotations per minute
sec	Second
SEM	Scanning electron microscopy
RA	Regeneration agar
<i>t</i>	Time
T	Temperature
μl	Micro liter
UV	Ultra violate
v/v	Volume by volume
vvm	Volume per volume per minute

Chapter 1

Introduction

Abstract:

This chapter summarizes an overview of sources, applications and importance of gibberellins (GA₃ and GA₄) during the plant growth development. Their applications, functions, and physicochemical properties are outlined. A literature survey on the biosynthetic pathway, methods of production, approaches and strategies used for enhanced biotechnological production of gibberellin is summarized.

INTRODUCTION

Gibberellins are a group of naturally occurring highly functionalised tetracyclic diterpenoid carboxylic acids. They are distributed widely throughout the plant kingdom. Some members of gibberellins function as growth hormones in higher plants controlling developmental processes such as the induction of hydrolytic enzyme activity during seed germination, stem elongation, flower induction and seed and pericarp growth (Graebe, 1987; Cosgrove and Sovonick-Dunford, 1989; Ozga *et al.*, 2002; Ayele *et al.*, 2006). The concentration of bioactive gibberellins (GAs) varies between plants in the range of 10^{-11} to 11^{-9} g/g fresh weight; however, this is dependent on the plant tissue type and plant species, and is closely regulated (Davies, 2010).

In 1917 the Japanese plant pathologist, Sawada, identified a fungus as the causal agent of the ōbakanaeō or ōfoolish seedlingō disease and described it as *Lisea fujikuroi* (Sawada, 1917). Symptoms of this disease are abnormal growth of the plants by hyperelongation of the internodes, yellowish green leaves and pale green flag leaves, lesions on roots and only partially filled, sterile, or empty grains, which drastically lower grain yields. In 1926, the Japanese scientist Eiichi Kurosawa discovered that the disease was not because of fungus itself but caused by a chemical substance secreted by the pathogen (Kurosawa, 1926). Yabuta first isolated the solid compound from the culture fluid and called it gibberellin A in allusion to the fungus, which was redefined as *Gibberella fujikuroi* in 1931 (Ito and Kimura, 1931). This compound stimulated plant growth when applied to rice roots (Yabuta, 1935). With this biological test, Yabuta and Sumiki reported the isolation of two crystalline substances from cultures of the fungus with different chemical properties, that they named gibberellins A and B, both after the fungal source (Yabuta and Sumiki, 1938). After the pause imposed by the World War I, a new phase of gibberellin research began. A team at Akers Research Laboratories (Imperial Chemical Industries) chose a strain of their *Fusarium* collection for fermentation study and during the first extraction of the culture, crude crystalline preparations with high biological activity were obtained. After further purification steps, a gibberellin was isolated that the authors called ōgibberellic acidō (Curtis and Cross, 1954). Its molecular formula was $C_{19}H_{22}O_6$ and its physiological properties were different from

the Japanese gibberellin A. In the meantime, research was conducted in the United States of America to produce gibberellin A for agricultural uses with gibberellin producing strain from Japan. A compound called gibberellin X was isolated. A comparison of its chemical properties with those of the British gibberellins revealed identical chemical properties and the name gibberellic acid was generally accepted (Stodola *et al.*, 1955). Further investigations on the Japanese gibberellin A by Takahashi *et al.*, in 1955, succeeded in separating gibberellin A into three components named A₁, A₂ and A₃. Chemical structure determination at the ICI Laboratories in the United Kingdom revealed that the compound was identical with Gibberellin A₃ same as isolated by the British and American researchers (Cross *et al.*, 1959). The ability of GA₃ to restore normal growth of plant dwarf mutants (Lang, 1956) and the occurrence of GA₃-like substances in higher plants (Radley, 1956) prompted the suggestion that GAs are natural plant hormones, regulating growth and development in higher plants. Thus, in the mid-50s, British scientists discovered that GAs are natural regulators of growth and development in higher plants (Lang, 1956; Radley, 1956; Kato *et al.*, 1962). Although GAs are ubiquitous plant hormones, they were first identified as secondary metabolites of the rice-pathogenic fungus *Fusarium fujikuroi* (teleomorph *Gibberella fujikuroi*). The discovery that GAs are capable of influencing many developmental processes in plants stimulated worldwide biotechnological production of these plant hormones using high-GA producing mutants of the fungus *F. fujikuroi*.

1.1 Chemistry of gibberellins

Birch and co-workers determined incorporation patterns from ¹⁴C-labelled acetate and mevalonate into GA₃ in fungal cultures and concluded that GAs were diterpenoid compounds (Birch *et al.*, 1958, 1959). The variety of gibberellins has increased since many new ones were isolated from *F. fujikuroi* and from plants. Rather than giving a trivial name to each of them or using a complex systematic nomenclature, gibberellins are known by the letters 'GA' followed by a serial number (MacMillan and Takahashi, 1968). Gibberellins can be classified into two groups: C₂₀-gibberellins, which possess the complete diterpenoid skeleton with 20 carbon atoms and C₁₉-gibberellins, which have biogenetically lost one carbon atom (C-atom number 20). They have a typical tetracyclic ring system called *ent*-gibberellane.

Structural modifications can be made to the *ent*-gibberellane skeleton of both C₂₀ and C₁₉-GAs, such as the insertion of additional functional groups. Both the position and stereochemistry of this substituent can have a profound effect on the biological activity of the GA. The C₂₀-GAs normally do not have biological activity, but can be metabolized to C₁₉-GAs that may be bioactive. In almost all the C₁₉-GAs, the carboxyl at C-4 forms a lactone with C-10. All bioactive GAs are C₁₉-GAs, although not all C₁₉-GAs are bioactive. The most prominent bioactive gibberellins are GA₃, GA₄, and GA₇ (Sponsel and Hedden, 2004). Their structure and chemical properties are given in Table 1.1.

<i>Gibberellin</i>	<i>Formula</i>	<i>Structure</i>	<i>Molecular weight</i>	<i>Melting point (°C)</i>
GA ₃	C ₁₉ H ₂₄ O ₅		346	234-236
GA ₄	C ₁₉ H ₂₄ O ₅		332	214-216
GA ₇	C ₁₉ H ₂₂ O ₅		330	169-172

Table 1.1 Chemical and physical properties of gibberellins

1.2 Biological Activity of gibberellins

Different gibberellins are usually found in the same plants and their pattern can change depending on the stage of development. Response of the plants to the various effects caused by different gibberellins can differ depending on the plant genera, organs and developmental stage. Only a few of the 136 known GAs have intrinsic biological activity. Not surprisingly, many of the GAs that were identified in the earliest years of GA research are the ones which possess the highest biological activity and are useful as active hormones. These include mainly GA₃, GA₄ and GA₇.

They are involved in a number of developmental and physiological processes in plants. These processes include seed germination, seedling emergence, stem and leaf growth, floral induction and flower and fruit growth (Pharis and King, 1985).

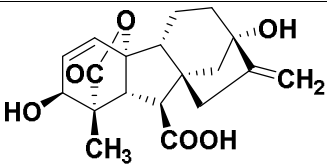
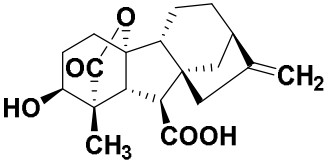
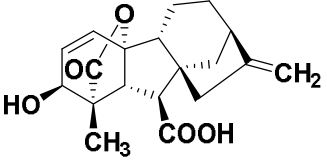
Although gibberellins appear to be involved in every aspect of plant growth and development, their most typical property is the enhancement of stem growth. Gibberellic acid has specially been effective on dwarf plant and dwarfism due to a deficiency in natural GAs is reversed by the application of exogenous GAs to plant. GAs may modify the sex expression of flowers, induce the parthenocarpic development of fruit and delay senescence (Mander, 2003). Gibberellic acid has been reported to influence vegetative growth, flowering, fruiting and various disorders in many fruit crops including strawberry (Paroussi *et al.*, 2002). Similarly, gibberellic acid has been reported to enhance pollen germination (Kappel and MacDonald, 2007; Voyiatzis and Paraskevopoulou-Paroussi, 2002) and may also affect colour development in strawberry fruit. Thus, GA₃ may also affect the occurrence of albino, malformed and button or nubbin berries to a larger extent, thereby increasing the production of healthy fruit with better quality.

Reduction of flowering in fruit trees is due to the inhibitory effect of gibberellins produced by seeds of developing fruits (Chan and Cain, 1967; Hoad, 1984). Gibberellins are thought to move from the fruit to the nearby nodes, where they inhibit the initiation of new floral primordia which are usually initiated about 608 weeks after fruit set (Webster and Spencer, 2000). Based on this inhibitory effect, the application of gibberellic acid (GA₃) during flower bud induction interrupts the floral process and partially reduces flowering. This partial inhibition of flowering results in a partial reduction of the number of developing fruits and thus, can be used as an indirect thinning method, providing a marked reduction in thinning costs. This technique has been successfully applied in apple trees (McArtney and Li, 1998; Tromp, 2000). Similarly, study was carried out for 'Black Diamond' and 'Black Gold' Japanese Plums by Agusti *et al.*, (2006) who reported reduced cost of manual thinning by almost 50% and increased individual fruit weight.

Overall, gibberellins appear to be involved in every aspect of plant growth and development as summarized below

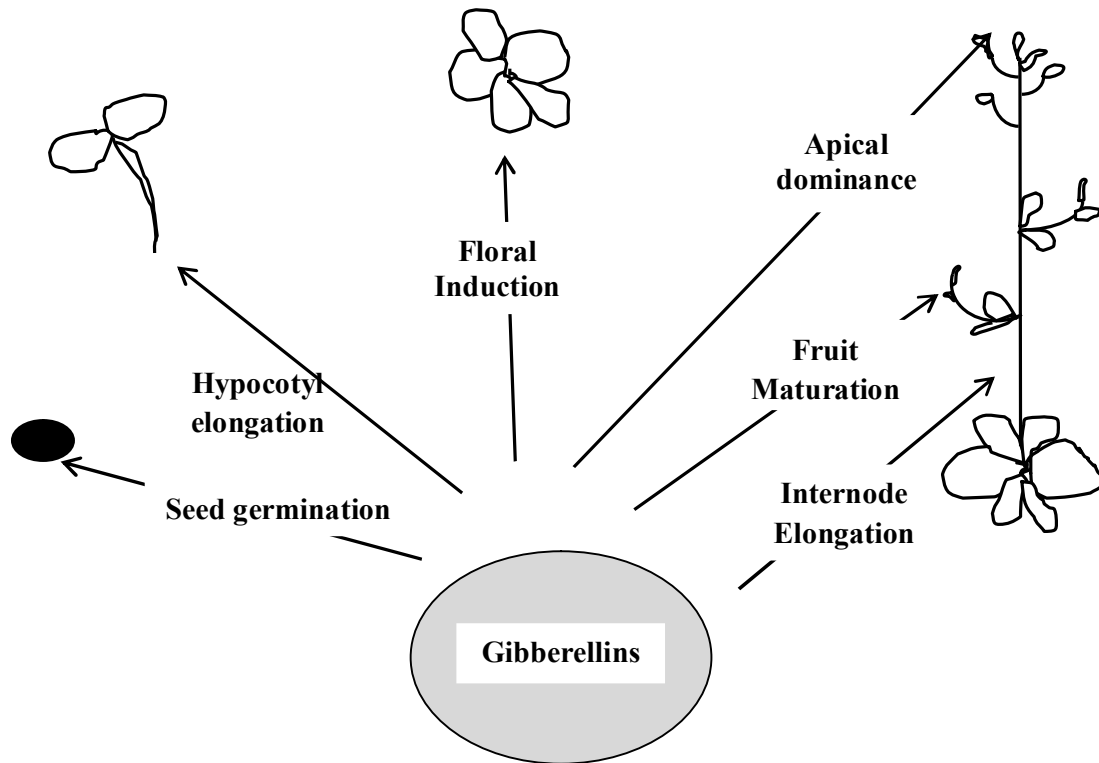

Figure 1.1 Summary of effects of GAs on plants

It is important for plants to produce and maintain optimal levels of bioactive GAs to ensure normal growth and development. Plant response to GA is mediated by negative regulators of GA response called DELLA proteins. In plants, bioactive GAs represses expression of several genes whose products are involved in their biosynthesis and promotes expression of genes involved in GA inactivation (Yamaguchi, 2008; Fleet and Sun, 2005). Recently, a soluble GA receptor, GIBBERELLIN INSENSITIVE DWARF1 (GID1), was identified in rice (*Oryza sativa*). The protein GID1 is found to be localized in the nucleus and binds biologically active gibberellins (Ueguchi-Tanaka *et al.*, 2005; Willige *et al.*, 2007). The GID1s interact with DELLA proteins in a GA-dependent manner. Upon receipt of the GA signal, GID1 binds to DELLAs and then DELLAs undergo degradation through the proteasome and thus promoting GA-mediated transcription (Hartweck, 2008).

1.3 Commercial uses of gibberellins

Gibberellic acid (GA_3) is the most often commercially used GA, because it can be readily obtained in large quantities from fermentations of the fungus *F. fujikuroi*. The global use of GA_3 per annum is approximately 50 tons. GA_4 and/or GA_7 , are used for specific crops or specific purposes for which they are more effective than GA_3 . $GA_{4/7}$ is produced in lower yields by commercial fermentations and therefore are more expensive than GA_3 . The major commercial uses of GAs are to promote the growth of a variety of fruit crops, to increase sugar yield in sugarcane and to stimulate the barley-malting process in the beer-brewing industry as described by Gianfagna (1995) and detailed below.

1.3.1 Commercial uses of GA_3

- Gibberellin A_3 is widely used for increase in the size and yields of seedless grapes. Almost all seedless grapes on the market in India are treated with GA_3 . It substitutes for the presence of seeds, which would normally be the source of native GAs for fruit growth. Repeated spraying with GA_3 increases both rachis length (producing looser clusters) and fruit size. The increased rachis length prevents the cluster from being too compact and this reduces the chance of fungal growth inside the cluster. Two to three additional applications of GA_3 during fruit development are thought to increase berry size by enhancing the import of carbohydrates into the developing fruit. In excess of 8 tons of GA_3 are used in the California grape industry annually.

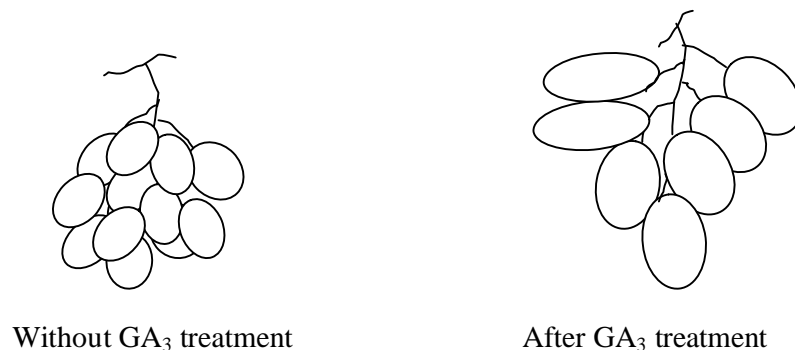

Figure 1.2 Effect of application of GA_3 on grapes

- In the brewing industry, the production of beer relies on the hydrolytic breakdown of starch in barley grains to yield fermentable sugars, principally

maltose, which are then subjected to fermentation by yeast. Gibberellins from the embryo of germinating grains are necessary for the synthesis of α -amylase by the cells of the aleurone layer, which, in turn is necessary for the hydrolysis of starch within the endosperm. In the multistep malting process, mature barley grains are soaked to allow them to imbibe water. Next, the grains are spread out to germinate, during which time the starch within the endosperm will be hydrolyzed by α -amylase allowing the embryo to grow. This process of starch breakdown is referred to as "modification." Gibberellic acid applied during this time will supplement the native GAs in the grain, enhance the production of α -amylase and consequently, speed up the hydrolysis of starch. Thus, in the brewing of beer, malt production is a costly, time consuming step from which 263 days may be saved by the addition of 256500 g of GA₃ for each kg of barley.

- Gibberellic acid is used extensively to increase the sucrose yield of sugarcane. Sugarcane, a normally fast-growing C₄ member of the Poaceae (grass) family, is sensitive to cooler winter temperatures, which reduce internode elongation and subsequent sucrose yield. The adverse effects of cooler temperatures can be counteracted by the application of GA₃.
- The rind of citrus fruit typically softens at maturity, and is subject to injury by pests and environmental factors which adversely affect the appearance of otherwise marketable fruit. By inhibiting senescence, GA₃ maintains the rind in better condition.
- A variety of ornamental plants can be induced to flower either earlier than usual, or in off-seasons. Sporadic flowering in some plants is often a problem with plant breeders, but may be reorganized with GA₃ applications.

1.3.2 Commercial uses of GA₄₊₇

Although gibberellic acid is the most predominant among the gibberellins, GA₄ and GA₇ are also equally important because they are immediate precursors of GA₃, and possess bioactivities different from that of GA₃ (Tudzynski, 1999). The separation of gibberellins A₄ and A₇ from each other is difficult due to their structural similarities. GA₄ and GA₇, differ from each other only by the absence or presence of an olefin double bond between carbon atoms 1 and 2. As the separation is not economically

feasible, GA₄ and GA₇ are commercially sold and also used as a mixture (Gallazzo and Lee, 2001).

- One of the most important fields of application is based on the ability of GA₄ and GA₇ to reduce the severity and frequency of russet on some strains of "Golden Delicious" apples. Russet is a "scabby" skin disorder in apples, especially in "golden delicious" reducing the fruit value. Application of GA₄₊₇ on apples 1 to 2 weeks after full bloom can reduce russet by 70-80%. Time and number of treatments are reported to be more important than the concentration (Martin, 1983; McLaughlin and Greene, 1984).
- Another important field of application of GA₄₊₇ is masculinization in cucumber. GA₄₊₇ mixture applied by spraying during the pre-flowering stages of growth induce male flower formation of monoecious and gynoecious cucumbers. This phenomenon can be utilized in the production of hybrid seed (Rappaport, 1980).
- The most significant effect is the induction of flowering in certain coniferous species, especially in species of the Pinaceae (Pharis and King, 1985). Seed cone production is also reported to be promoted by GA₄₊₇ in numerous Pinaceae species. This enables a better seed production for economically important forest trees (Tompsett and Fletcher, 1979; Ho, 1988).
- Some of the economically most important forest trees have poor natural regeneration because of the infrequency of good seed years (flowering in this family may not occur for 10 years and longer). Application of GA₄ and GA₇ might enable the conifer tree breeders to accelerate the generation time and to carry out breeding programs more efficiently (Bruckner and Blechschmidt, 1991).

As a result of these properties and their commercial applications, considerable interest has been generated in study of the biosynthesis of GAs and their regulation. In spite of gibberellin occurrence in different plants, fungi and bacteria, the commercial source of the bio-active GAs, particularly GA₃, GA₄ and GA₇ is the fermentation using the fungus, *F. fujikuroi*, from which the GA₃ was originally discovered.

1.4 Biosynthesis of gibberellins in *F. fujikuroi*

Gibberellins were first isolated as phytoxic metabolites of a fungal rice pathogen, *G. fujikuroi*, now named *F. fujikuroi* (O'Donnell *et al.*, 1998). This fungus played a crucial role in studying the structure and biochemical origin of GAs. *Fusarium fujikuroi* belongs to the *Gibberella fujikuroi* (Sawada) species complex, which contains species from the *Fusarium* sections *Liseola* and *Elegans*. This species complex is composed of nine reproductively isolated biological species (mating populations) denoted by the letters A through I (Britz *et al.*, 1999; Kerényi *et al.*, 1999; Leslie 1995; Nirenberg and O'Donnell, 1998; O'Donnell *et al.*, 1998). All these *Fusarium* species are important fungal pathogens of various crops such as maize, rice, barley, sugarcane, pine, mango, pineapple, sorghum, and many more. Moreover, these species differ in their ability to produce secondary metabolites such as fumonisins, moniliformin (Desjardins *et al.*, 1995, 2000; Kedera *et al.*, 1999; Leslie *et al.*, 1992), fusaric acid (Bacon *et al.*, 1996); fusarins (Song *et al.*, 2004), the pigments neurosporaxanthin and bikaverin (Linnemannstöns *et al.*, 2002a, b), and GAs (Tudzynski and Holter, 1998; Desjardins *et al.*, 2000). So far, the ability to produce GAs and to cause bakanae disease has been confirmed only for rice isolates belonging to the species *F. fujikuroi* (sexual stage: *G. fujikuroi* MP-C) (Tudzynski, 2005). GA biosynthesis pathway in fungus differs fundamentally from that in higher plants at the chemical, enzymatic, and genetic levels and has evolved independently in plants and *F. fujikuroi* (MacMillan, 1997; Hedden *et al.*, 2002; Yamaguchi, 2008).

Depending on media constituents and environmental conditions along with major secondary metabolite gibberellins, *F. fujikuroi* produces other co-metabolites as presented in Fig. 1.3

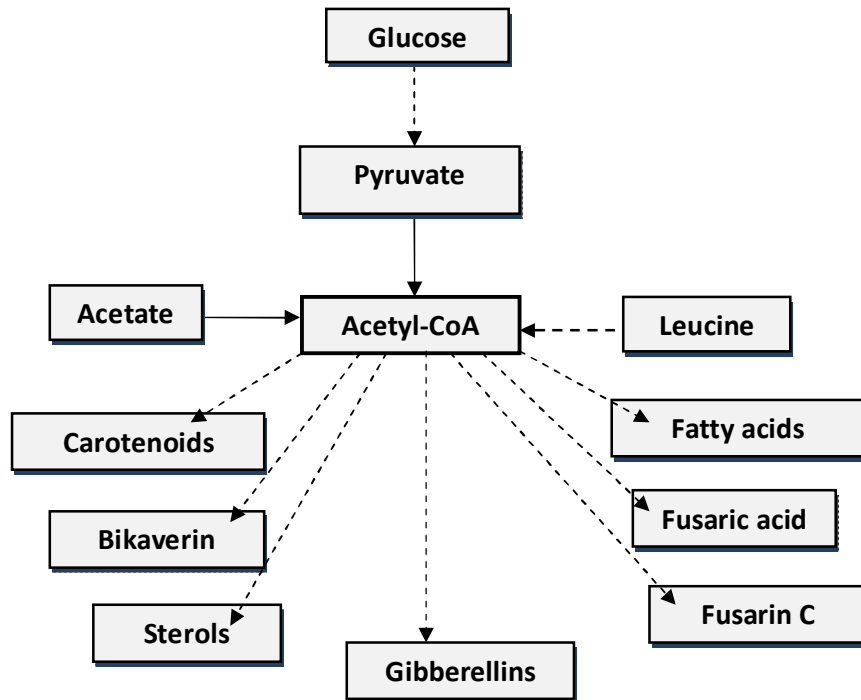

Figure 1.3 Biosynthesis of gibberellins and other co-metabolites in *F. fujikuroi*

In the 1960s and early 1970s, the basic biosynthetic pathway to gibberellic acid (GA₃), the end-product of GA biosynthesis in *F. fujikuroi*, was determined by incorporation of ¹⁴C-labelled acetate and mevalonate, isolating intermediates and by using GA-deficient mutants as reviewed by Bearder (1983).

Gases, like other diterpenoids, are produced from hydroxymethylglutaryl (HMG) coenzyme-A via mevalonic acid, isopentenyl diphosphate, geranyl diphosphate, farnesyl diphosphate (FDP) and geranylgeranyl diphosphate (GGDP). GGDP is a precursor not only for GAs, but also for the carotenoid neurosporaxanthin (Domenech *et al.*, 1996; Linnemannstons *et al.*, 2002) and ubiquinones. GGDP for GA biosynthesis is exclusively synthesized by the GA pathway-specific GGDP synthase, *ggs2* (Tudzynski and Holter, 1998). By two cyclization steps from GGDP via ent-copalyl diphosphate (CPP) ent-kaurene, the first GA-specific intermediate is produced. A single bifunctional CPS/KS-encoding gene, *cps/ks*, is responsible for both cyclization steps (Tudzynski *et al.*, 1998). Sequential oxidation of ent-kaurene at C-19 via ent-kaurenol and ent-kaurenal yields ent-kaurenoic acid oxidised further to ent-7 -hydroxykaurenoic acid. A final oxidation at C-6 leads to formation of

GA₁₂-aldehyde. GA₁₂-aldehyde is first 3-hydroxylated to GA₁₄-aldehyde, which is then oxidized at C-7 to form GA₁₄ (Hedden *et al.*, 1974; Urrutia *et al.*, 2001). Four oxidation steps to produce GA₁₄ catalyzed by P450-1 has 3-hydroxylase activity in addition to ent-kaurenoic acid oxidase activity. GA₁₄ is then converted to the C₁₉ gibberellin GA₄ by 20-oxidase. GA 20-oxidase activity is due to the action of P450-2 that converts GA₁₄ to GA₄ (Tudzynski *et al.*, 2002). GA₄, the first biologically active GA, is then converted to GA₇ by GA₄-desaturase that introduces the 1, 2-double bond.

The final step in the fungal pathway is the 13-hydroxylation of GA₇ to produce GA₃ catalyzed by P450-3 (Tudzynski *et al.*, 2003). Biochemical pathway of gibberellins synthesis in *F. fujikuroi* is presented in Fig. 1.4. Individual steps of gibberellins biosynthesis and their cofactor requirement are presented in Table 1.2.

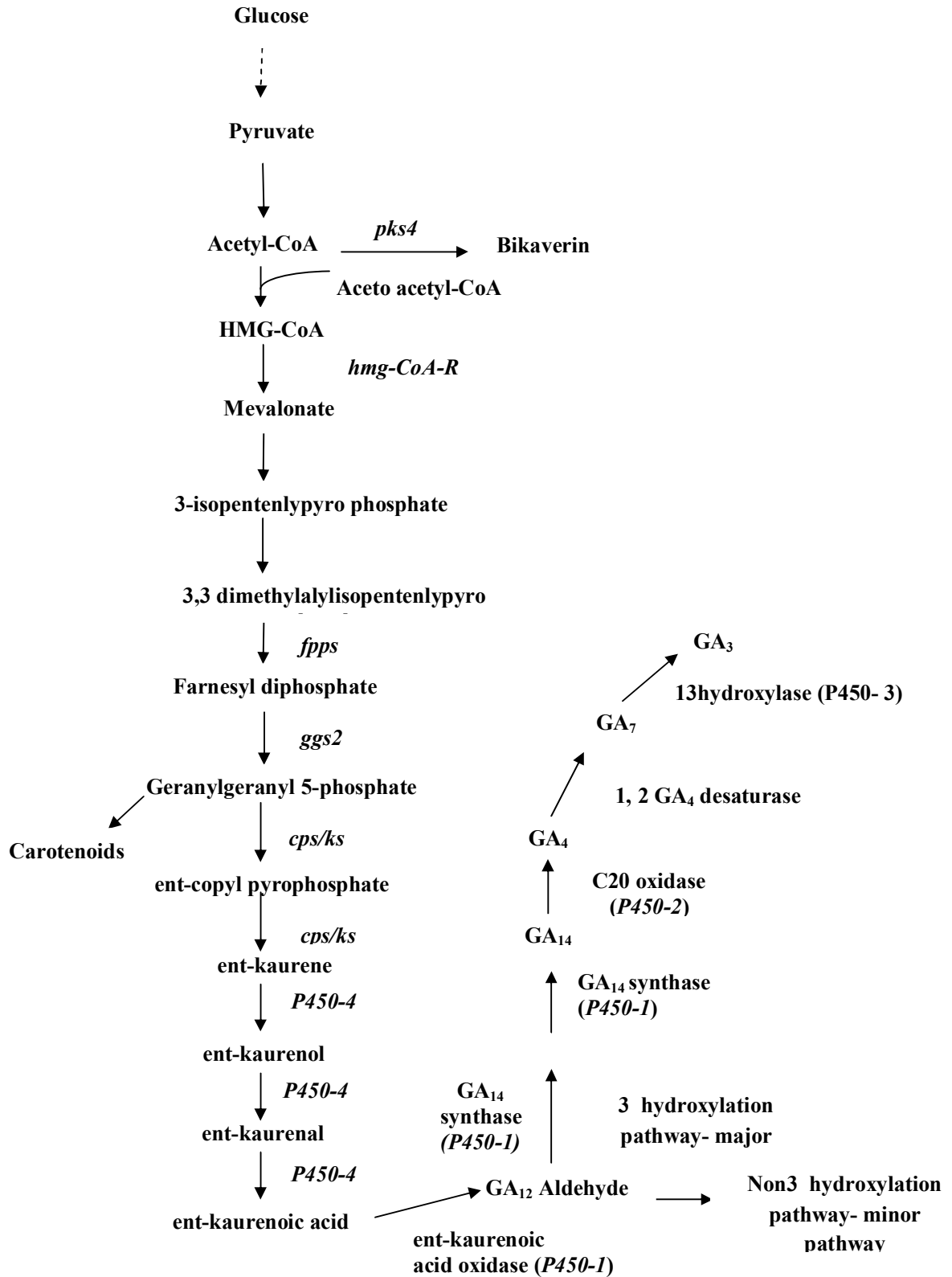

Figure 1.4 Biochemical pathway of gibberellins synthesis in *F. fujikuroi*

Chapter 1

<i>Initial compound</i>	<i>Reaction product</i>	<i>Enzyme</i>	<i>Cofactor Requirement</i>
2Acetyl CoA	Acetoacetyl CoA	Acetyl CoA-C-acetyltransferase 2.3.1.9	
Acetoacetyl CoA + Acetyl CoA + H ₂ O	3-Hydroxymethyl glutaryl CoA + CoA	Hydroxymethyl glutaryl CoA synthase 2.3.3.10	
3-Hydroxymethyl glutaryl CoA + 2NADPH + 2H ⁺	Mevalonate + CoA + 2NADP	Hydroxymethyl glutaryl CoA reductase 1.1.1.34	NADPH
Mevalonate + ATP	Mevalonate phosphate + ADP	Mevalonate kinsase 2.7.1.36	ATP
Mevalonate phosphate + ATP	Mevalonate pyrophosphate + ADP	Phospho mevalonate kinsase 2.7.4.2	ATP
Mevalonate pyrophosphate + ATP	Isopentenyl pyrophosphate + ADP + CO ₂ + Pi	Mevalonate diphosphate decarboxylase 4.1.1.33	ATP
Isopentenyl pyrophosphate	Dimethylallylpyrophosphate	Isopentenyl pyrophosphate isomerise 5.3.3.2	
Dimethylallylpyrophosphate + isopentenyl PP	Geranyl Pyrophosphate + Pi	Geranyl transtransferase 2.5.1.10	
Geranyl Pyrophosphate + isopentenyl PP	Farnesyl Pyrophosphate + Pi	Geranyl transtransferase 2.5.1.10	
Farnesyl Pyrophosphate + isopentenyl PP	Geranyl geranyl diphosphate + Pi	Farnesyl transtransferase 2.5.1.29	
Geranyl geranyl diphosphate	<i>ent</i> -Copoly PP	Ent-Copalyl diphosphate synthase 5.5.1.13	
<i>ent</i> -Copoly PP	Ent-Kaur-16ene + Pi	<i>ent</i> -kaurene synthase 4.2.3.19	
Ent-Kaur-16ene + NADPH + H ⁺ + O ₂	Ent-Kaur-16en-19-ol + NADP + H ₂ O	<i>Ent</i> -kaurene oxidase 1.14.13.78	NADPH
Ent-Kaur-16en-19-ol + NADPH + H ⁺ + O ₂	Ent-Kaur-16en-19-al + NADP + H ₂ O	<i>Ent</i> -kaurene oxidase 1.14.13.78	NADPH
Ent-Kaur-16en-19-al + NADPH + H ⁺ + O ₂	Ent-Kaur-16en-19-oate + NADP + H ₂ O	<i>Ent</i> -kaurene oxidase 1.14.13.78	NADPH
Ent-Kaur-16en-19-oate + NADPH + H ⁺ + O ₂	Ent-7 α hydroxyl Kaur-16-en-19-oate + NADP + H ₂ O	<i>Ent</i> -kaurenoic acid oxidase 1.14.13.79	NADPH
Ent-7 α hydroxyl Kaur-16-en-19-oate + NADPH + H ⁺ + O ₂	GA12 Aldehyde + NADP + H ₂ O	P450-1 monooxygenase 1.14.13.13 and P450- reductase 1.6.2.4	NADPH
GA12 Aldehyde + NADPH + H ⁺ + O ₂	GA14 + NADP + H ₂ O	P450-1 monooxygenase 1.14.13.13 and P450- reductase 1.6.2.4	NADPH
GA14 + NADPH + H ⁺ + O ₂	GA36 + NADP + H ₂ O + CO ₂	P450-1 monooxygenase 1.14.13.13 and P450- reductase 1.6.2.4	NADPH
GA36 + NADP + H ₂ O + O ₂	GA ₄ + NADP + H ₂ O	P450-2 monooxygenase and P450- reductase 1.6.2.4	NADPH
GA ₄ + NADPH + H ⁺ + O ₂	GA ₇ + NADP + H ₂ O	Desaturase	NADPH
GA ₇ + NADPH + H ⁺ + O ₂	GA ₃ + NADP + H ₂ O	P450-2 monooxygenase and P450- reductase 1.6.2.4	NADPH

Table 1.2 Individual steps of Gibberellin biosynthesis and their cofactor requirement

1.4.1 Regulation of GA gene expression in *F. fujikuroi*

In fungi, it has been known that the secondary metabolism regulation is responsive to environmental signal, including the carbon and nitrogen source, ambient temperature, light and pH value (Keller *et al.*, 2005). GA biosynthesis in *F. fujikuroi* is also influenced by several of these factors. Conditions of optimal GA production are also of commercial interest and they have been studied extensively (Borrow *et al.*, 1955; Darken *et al.*, 1959; Fuska *et al.*, 1961; Geissman *et al.*, 1966; Bruckner and Blechschmidt, 1991; Candau *et al.*, 1992). These early physiological studies revealed that the most striking regulatory principle is repression of GA biosynthesis by high amounts of nitrogen, especially by glutamine and ammonium (Borrow *et al.*, 1964; Munoz and Agosin, 1993). This mechanism is called nitrogen metabolite repression in filamentous fungi. Nitrogen repression is a well known regulatory principle of secondary metabolite formation (Munoz and Agosin, 1993). On one hand, it prevents the energy-consuming expression of genes for utilization of alternative nitrogen sources in the presence of preferred nitrogen sources and on the other hand, in their absence, it enables the utilization of alternative nitrogen sources like nitrate, arginine, urea by inducing expression of the corresponding genes as reviewed by Marzluf (1997). In a mutant strain of *F. fujikuroi* ammonium or nitrate was shown to affect the production of GA₃ while phosphate did not influence the biosynthesis of GA₃. The negative effect of ammonium or nitrate ions is due to inhibition of activity and *de novo* synthesis of specific gibberellin producing enzyme (Bruckner and Blechschmidt, 1991; Avalos *et al.*, 1997)

Tudzynski *et al.*, (1999) studied regulation of the GA biosynthetic genes in *F. fujikuroi* and their expression at the molecular level with the help of cloning and showed that nitrogen repression of GA biosynthesis is due to repression of GA gene expression. The major transcription factor responsible for this gene activation under nitrogen-limiting conditions is the positively acting transcription factor AreA. Six of the seven cluster genes, with P450-3 as the exception, are regulated by AreA (Tudzynski *et al.*, 2003; Mihlan *et al.*, 2003). In addition, glutamine synthetase (GS) was shown to be essential for expression of GA and bikaverin biosynthesis genes in *F. fujikuroi* suggesting a role in the nitrogen regulation network (Teichert *et al.*, 2004). Several other regulators have been identified in *F. fujikuroi* in the last few

years that are involved in the nitrogen regulation network. They play minor roles for regulation of nitrogen-repressed genes such as GA biosynthetic genes and ammonium and amino acid permeases.

Another regulation mechanism is carbon catabolite repression. It is also a well known mechanism in many fungi and it results in the preferential utilization of glucose from a mixture of carbon sources due to the repression of the expression of the genes encoding enzymes required for the utilization of less favoured carbon compounds (Dowzer and Kelly, 1991). High amounts of glucose had been described to inhibit formation of diterpenoid gibberellins by *F. fujikuroi* (Borrow *et al.*, 1964). Use of alternative carbon source, inert for carbon catabolite, such as plant oils was studied by earlier researchers, Muromtsev and Agnistova (1984) and Gancheva *et al.*, (1984). In the biotechnological industry, feeding glucose seems to be preferred in order to avoid a late onset of GA production and the undesired accumulation of fat and carbohydrate in the mycelium (Vass and Jefferys, 1979). A genetic analysis of carbon regulation of gibberellin biosynthesis was carried out by Tudzynski *et al.*, (2000). They described the isolation, sequencing and expression as well as initial functional analysis of the *creA* genes from the phytopathogenic fungus *F. fujikuroi*. They reported CreA binding sites in some of the gibberellin biosynthetic genes but the exact mechanism and target gene(s) of glucose repression is still not known. Genes, enzymes, their function and regulation involved in gibberellin biosynthesis of *F. fujikuroi* is presented in Table 1.3

<i>Gene</i>	<i>Enzyme function</i>	<i>Regulation of gene expression</i>	<i>Reference</i>
General isoprenoid pathway			
hmgr	HMG-CoA reductase	Constitutive expression	Woitek <i>et al.</i> , (1997)
fpps	Farnesyl diphosphate synthase	Constitutive expression	Homann <i>et al.</i> , (1996)
ggs (ggs1)	General GGDP-synthase, primary metabolism	Constitutive expression	Mende <i>et al.</i> , (1997)
GA biosynthetic gene cluster			
ggs2	GA-specific GGDP-synthase	AREA-control	Tudzynski and Holter, (1998)
cps/ks	Bifunctional ent-copalyl-ent-kaurene synthase	AREA- control	Tudzynski <i>et al.</i> , (1998)
P450-4	ent-kaurene oxidase (P450 monooxygenase)	AREA- control	Tudzynski <i>et al.</i> , (1999)
P450-1	Multifunctional cytochrome P450 monooxygenase, GA14-synthase	AREA- control	Rojas <i>et al.</i> , (2001)
P450-2	GA 20-oxidase, oxidative elimination of the carbon 20 (P450 monooxygenase)	AREA- control	Tudzynski <i>et al.</i> , (2002)
des	GA ₄ 1.2-desaturase, conversion of GA ₄ to GA ₇	AREA- control	Tudzynski <i>et al.</i> , (2003)
P450-3	13-hydroxylase, conversion GA ₇ to GA ₃	No N-metabolite repression	Tudzynski <i>et al.</i> , (2003)

Table 1.3 Genes of the gibberellin (GA) biosynthetic gene cluster: function and regulation

1.5 Production of gibberellins

Ease of increasing production by manipulation of environmental and genetic conditions is the main reason for the use of microorganisms to produce compounds. Over 1000-fold enhancement in production level have been recorded in literature for some of the small molecular weight metabolites (Demain, 2000). Majority of the research efforts for enhancement in GA production using biological processes have been focused mainly on the screening of fungal strains able to produce with high yield, the optimization of culture conditions, optimization of operation strategies in batch and fed-batch fermentation processes. The strategies employed for increasing the production level and yield of GA₃ are as follows.

1.5.1 Strain improvement

Although microbes are extremely good at producing an amazing array of valuable products, they usually produce these compounds in small amounts. When a strain suitable for a product formation at relatively high concentration is found, a strain improvement program is initiated by genetic modification of the strain using mutagenesis and recombinant DNA techniques in order to increase the desired product concentration. Mutagenesis and screening for increased product formation seem to be the most important means for obtaining improved strains in the shortest possible time. In general, *F. fujikuroi* is a suitable organism for the induction and isolation of mutants. *F. fujikuroi* produces two types of conidia. The microconidia are unicellular, uninucleate, and normally fusiform to clavate, pear shaped reproductive bodies produced in chains. The macroconidia are multi-cellular, thin walled, crescent, with boot shaped basal cells. Uninucleate microconidia allow the expression of recessive mutations. Multicellular macroconidia are not produced by many gibberellin-producing strains of *F. fujikuroi*.



Figure 1.5 Macro and Microconidia from *F. fujikuroi*

Since most strain development of gibberellin-producing organisms has been done at ICI's Pharmaceutical Division and other industrial laboratories, the mutagenic techniques and screening principles have not been published because of their proprietary nature.

Several GA-deficient mutants of *F. fujikuroi* in which GA biosynthesis is blocked at different points of the pathway, have played an important role in the discovery of major steps of GA biosynthesis. Potential intermediates were isolated from cultures of these mutants and used to demonstrate their incorporation into GA₃ without the requirement for isotopically labelled substrates.

Morphological and biochemical mutants of *F. fujikuroi* have been isolated after treatment with different chemical and physical mutagens. Mutants with minimal unwanted pigment formation presumably make more carbon available for increased gibberellin production during secondary metabolism and this is likely to be a possible way of strain improvement. *F. fujikuroi* produces two types of pigments, the polyketide ōbikaverinō and the carotenoid ōneurosporaxanthinō. Candau *et al.*, (1991) studied the mutant strains with lower levels of neurosporaxanthin which produce more gibberellins because the competing biosynthetic pathway with the same precursor, mevalonate, is blocked.

During the last few years, commercial interest is concentrated on production of GA₄ and GA₇ for specialized horticultural uses. GA₃ producing strains can be switched

over to increased production of the precursors of GA₄ and GA₇, by use of mutants with blocked hydroxylation at C-13. Thus, GA₄ and GA₇ can be isolated without expensive separation procedures from GA₃.

1.5.2 Media optimization

Fermentative production of gibberellins is the classical example of secondary metabolite as the phases of growth can be clearly distinguished and related to environmental and nutritional stages operating in the fermenter. Borrow *et al.*, (1964) comprehensively studied this process and established non-producing and producing phases of gibberellins fermentation process. The submerged fermentation for GA₃ production is influenced to a great extent by a variety of physical and nutritional parameters. The optimization of these parameters is prerequisite to the development of commercial process.

Glucose or sucrose has been often used as carbon for GA₃ production. High amounts of glucose have also been described to inhibit GA₃ production (Borrow *et al.*, 1964). Many workers have used alternative carbon sources such as maltose, mannitol (Candau *et al.*, 1991), starch and plant meals (Fuska *et al.*, 1961). Mixtures of fast and slowly utilizable carbon sources increased the production rate as reported by Darken *et al.*, (1959). While successful use of plant oils was reported by Muromtsev and Agnistova (1984) and Gancheva *et al.*, (1984). The biosynthesis of GAs begins from acetyl CoA and follows the isoprenoid pathway. Therefore, plant oils as carbon source are not only inert for carbon catabolite repression but also make available a pool of acetyl-CoA and additionally, may contain natural precursors for GA biosynthesis (Tudzynski, 1999). Several industrial residues such as milk whey, molasses, oilseed cake, mussel processing waste have been used as carbon sources. GA₃ concentration of 3.0 g/l obtained in fermentation was reported by Pastrana *et al.*, (1993, 1995) using mussel processing waste under submerged fermentation. A few patent reports that the addition of intermediate compound of gibberellins pathway such as mevalonic acid, kaurene as precursors in the fermentation medium greatly improved GA₃ yield (Birch *et al.*, 1960; Tachibana and Azuma, 1994).

The kinetics of the growth and GA₃ production in nitrogen-limited synthetic media were first studied in detail by Borrow *et al.*, (1964). The quality and quantity of

nitrogen source play a significant role in GA₃ production. The published literature describes that media yielding high amount of GAs contained low concentration of nitrogen sources. Geissman *et al.*, (1966) studied GA formation in a synthetic medium containing 80 g/l glucose, mineral salts and ammonium nitrate in varying concentrations. They observed that when the initial nitrogen amount was 4.8 g/l and glucose became the limiting nutrient, gibberellins were not produced. While in low nitrogen medium, which contained the same amounts of glucose and salts, but only 0.48 g/l ammonium nitrate, gibberellins were produced. This medium was successfully used for GA₃ production using *F. fujikuroi*. Thus, gibberellic acid production began at or soon after nitrogen exhaustion. Besides media with low ammonium or nitrate concentrations, complex ingredients such as corn steep extracts (Darken *et al.*, 1959) as well as soybean and peanut meals (Fuska *et al.*, 1961) positively affect GA biosynthesis. It was suggested that plant extracts might contain precursors or inducers of the GA pathway (Rademacher, 1997).

The influence of C: N ratio is directly related with GA₃ production. The C: N ratio used in the medium must provide a) initial quick mycelia growth in balanced medium state, b) lead to quick initiation of gibberellins production after nitrogen exhaustion and imbalanced state and c) result in extended metabolite production in the presence of sufficiently available carbon source. In submerged fermentation, for the initial growth phase, C: N ratio ranges between 10:1 to 25:1, while the ratio varies from 25:1 to 200:1 for production phase (Borrow *et al.*, 1964; Kumar and Losane, 1989; Bruckner and Blechschmidt, 1991; Tudzynski, 1999).

Besides carbon and nitrogen requirement, trace elements are needed in the biosynthesis of secondary metabolites. Negligible information is available on this aspect in the microbial production of GA₃. Requirements of the trace minerals are often believed to be met by impurities in commercial media ingredients (Borrow *et al.*, 1964, Kumar and Losane, 1989; Bruckner and Blechschmidt, 1991)

1.5.3 Environmental factors in gibberellin production

Variation in pH of the medium is one of the most influent factors in the composition of produced gibberellin mixture. For GA₃ production, generally employed medium pH is between 3.5-5.8. It has been reported that increased pH leads to increased

production of GA₄ and GA₇ (Kumar and Losane, 1989). Effect of initial pH of the medium on GA₃ production was investigated by Rangaswamy (2012). It was noted that initial pH of the medium did not greatly influence the production of GA₃ although highest yield of 6.5 g/l was obtained on the 8th day when the initial pH was adjusted to 7.0.

The effect of temperature on the growth and secondary metabolism depends on the strain employed. Fermentation temperature ranging between 25 °C and 34°C for GA₃ production is reported by various researchers. Jefferys (1970) reported optimum temperature for the growth of the strain was between 31-32 °C and the production of GA₃ maximized at 29°C.

Since the biosynthesis of gibberellins involves many oxidative steps, a good aeration of fermenters is critical for an optimal production process. Since the value of oxygen consumption for a growing mycelium in the exponential growth phase remains constant, the demand for oxygen increases more or less exponentially. The thickening of broth tends to decrease oxygen transfer and the resulting oxygen restriction drastically reduces GA₃ formation (Vass and Jefferys, 1979). Therefore medium and nutrient feed to fermenter is required to be arranged such that some further linear proliferation occurs during the early production phase, to reduce the storage of lipids and carbohydrates and thickening the broth.

1.5.4 Fermentation techniques for GA₃ production

Fermentation is the industrial method practiced for GA₃ production preferentially with *F. fujikuroi*. It is possible to produce GA₃ by chemical synthesis (Corey *et al.*, 1978) or extraction from plants (Kende, 1967) but these methods are not economically feasible. Surface fermentation using liquid medium was employed in earlier years for GA production and its use was continued till 1955. Although the surface culture offers advantages such as low power requirement, use of simple reactors for growth and fermentation and low shear of the fungal mycelia, this method was abandoned for GA₃ production due to disadvantages inherently present in the method as low product yield, prolonged incubation time (10-30 days), wide range of undesired by-products and possibility of contamination (Kumar and Losane, 1987; Brucker and Blechschiemidt, 1991). Different studies have been carried out to

decrease cost of GA₃ production using several approaches such as screening of fungi, strain improvement, optimization of the nutrients and cultural conditions, development of new processes (immobilisation, fed batch culture) and minimization of cost of extraction.

Solid state fermentations have been successfully used for the production of secondary metabolites. This technique has also been applied for the production of GA₃ to increase the yield and to minimize production and extraction of gibberellic acid. Solid state fermentation using the substrates like wheat bran, rice bran, corn grains, cassava bagasse, pre-treated coffee bean pods in the medium is reported to result in 1.6 times higher GA₃ than in submerged culture (Kumar and Losane, 1987). Bandelier *et al.*, (1997) had developed aseptic pilot scale reactor (50 L) and reported GA₃ yield of about 3 g/kg of substrate. Comparative study for the production of GA₃ in liquid and solid substrate cultivation has also been done by Agosin *et al.*, (1997). They obtained 6.7 times higher GA₃ yield for organic substrate than liquid culture medium. Using inert support such as amberlite, maximum biomass 40 mg/g inert support and GA₃ production 0.73 mg/g inert support was achieved by Gelmi *et al.*, (2000). Recently, Rangaswamy (2012) reported use of jatropha seed cake as substrate for solid-state fermentation that resulted in gibberellic acid yield of 105 mg/g of bran. This is so far the highest reported yield of GA₃ obtained by SSF. This technique has a number of economic advantages over submerged fermentation process in the production of GA₃ and in utilization of agro industrial by-product. The main drawback of this technique is difficulty in controlling important parameters such as temperature, water content of the medium; scale up of the production to industrial level and difficulty in maintaining aseptic culture conditions during the process as reported by Robinson *et al.*, (2001).

Several authors have described the formation of GA₃ in a fixed-bed reactor by immobilized mycelium using calcium alginate beads (Heinrich and Rehm, 1981; Kumar and Lonsane 1988; Nava Saucedo *et al.*, 1989; Escamilla-Silva *et al.*, 2000). Nava-Saucedo *et al.*, (1989) reported that in a continuous system, immobilized mycelium produced about 2 fold more GA₃ as compared to free mycelium for a similar level of biomass. They also hypothesized that this technique can be applied extensively due to its economic nature as compared to conventional fermentation technique. The immobilized cells produced GA₃ with high stability over 84 days at a

constant value of about 210 mg/l (Lu *et al.*, 1995). Using immobilized *F. fujikuroi* mycelium in fluidized bioreactor, Eleazar *et al.*, (2000) reported a yield of 2.8 g/l while immobilized mycelia of *F. fujikuroi* in calcium polygalacturonate was reported to produce 3.9 g/l GA₃ by Escamilla-Silva *et al.*, (2000). But for large scale production of GA₃, several difficulties were encountered such as problem of sterility maintenance, difficulty in the process control and the risk of strain reversion.

Thus, even though impressive results with solid-state fermentation and immobilization techniques have been achieved, the standard industrial fermentation until now is the submerged cultivation under conditions of nitrogen limitation using genetically improved strains. There are several reports on submerged fermentation of gibberellic acid and a few of them are discussed below

- Darken *et al.*, (1959) studied gibberellic acid production using *F. moniliforme* strain and reported that the slowly utilized carbon source apparently permitted more effective production of gibberellic acid after the maximum rate of growth was obtained with the rapidly utilized glucose, sucrose or corn starch.
- Sanchez-Aiarroquin (1963) has reported gibberellic acid production from various substrates using 43 strains of *Fusarium*. He observed that glucose was better utilized by the strains for the production of gibberellic acid, ammonium nitrate was a better source of nitrogen and addition of corn steep liquor was essential for increased yield.
- Borrow *et al.*, (1964) studied metabolism of gibberellic acid in stirred tank reactor and showed that specific growth rate and gibberellin concentration are fairly constant over the pH range of 3.5 to 6.5. However, the composition of the produced gibberellin-mixture was dependent on the pH of the medium. The increased production of the intermediates like GA₄, GA₇ was explained presumably because of increased excretion of intermediates into the broth at higher pH and these intermediate compounds cannot be transported back into the mycelium to be further metabolized to the end-product, GA₃.
- Gancheva and Dimova (1984) established that in submerged culture fermentations, the growth and biosynthesis of gibberellins was dependent on the age and quantity of vegetative inoculum. They reported use of 48 h vegetative

culture, harvested after mycelium growth slowed down and 10 % v/v vegetative mycelium as an inoculum for gibberellins fermentation.

- Holme and Zacharias (1965) and Bu'Lock *et al.*, (1974) described the production of gibberellin A₃, in glycine-limited continuous culture and had observed maximum gibberellic acid synthesis at a growth rate of 0.005/h.
- Maddox and Richert (1977) had shown dairy waste (filtered whey) as feasible basal medium supplemented with Mg²⁺ (10 mg/l) for production of gibberellic acid. A maximum yield of 750 mg/l GA₃ was reported.
- Vass and Jefferys (1979) mentioned that at the end of fermentation, a greater percentage of available carbohydrates from the feed had been metabolized to cell-storage components than to gibberellins. The elimination of such losses seemed to be a good target for further improvement.
- A continuous fermentation with immobilized cells was presented with a possibility of increasing the viability of the mycelium to hundreds of days and therefore increasing the duration of secondary metabolite production. The maximum GA productivity was reported to be 0.768 mg GA₃/gram biomass/day (Nava Saucedo *et al.*, 1989).
- Hollmann *et al.*, (1995) have studied extractive fermentation for gibberellic acid in a stirred tank fermenter in an effort to minimize the product inhibition after understanding kinetics of decomposition under fermentation conditions. A two-fold increased yield of GA₃ as a result of on-line extraction of GA₃ product by polyalkoxylate (Genapol2822) was described.
- Pastrana *et al.*, (1995) studied fed-batch culture model for improved production of gibberellic acid using mussel processing waste by *G. fujikuroi* NRRL 2284.
- Escamilla Silva *et al.*, (1999) studied morphological phases of the different strains of *G. fujikuroi* and found similar morphological phases in the bioreactor to those obtained in shake flasks. They also reported 1100 mg/l gibberellic acid yield when 38 h grown strain H-984 of *G. fujikuroi* in shake flask was inoculated into bioreactor.
- Giordano and Domenech (1999) described how the level of aeration affects the metabolism of *G. fujikuroi* grown in batch cultures. The production of gibberellins, fatty acids, polyketide bikaverin and fusarin-C was strongly influenced by aeration. Higher aeration resulted in increased growth and the

production of bikaverin and gibberellins while low aeration stimulated fatty acid and fusarin-C production.

- For the first time, Shukla *et al.*, (2005) proposed a mathematical model for submerged cultivation to describe biomass growth, substrate consumption and GA₃ production. The model can serve as useful tool for simulating the nutrient (nitrogen and/or carbon) feeding strategies of fed-batch cultivation for production of high concentration of GA₃ and/or higher productivity in minimum possible cultivation time.
- Shukla *et al.*, (2005) used model-based nutrient feeding strategy and obtained volumetric productivity of 0.0168 g/l/h for GA₃ which was approximately 2.9 times higher than that obtained in conventional batch cultures.
- Karakoc and Aksoz (2006) reported the optimal cultural parameters for GA₃ production by *Pseudomonas* sp. isolated from wastes of processed olive and GA₃ yield (285.06 mg/l) at 72 h of incubation at pH 7 in the dark at 30 °C on a rotary shaker.
- Escamilla-Silva *et al.*, (2008) presented a mathematical description of the principal kinetics involved in gibberellic acid and bikaverin production in an air-lift bioreactor using a non-structured model.
- Khalaf *et al.*, (2009) have studied biosynthesis of gibberellic acid using milk permeate in repeated batch operation by a mutant *Fusarium moniliforme* c-14 cells immobilized onto loofa sponge discs. During four reusable cycles, they obtained highly stable GA₃ production and reduction in the initiation time of gibberellic acid production, resulting in higher levels of GA₃ in shorter time duration
- Rangaswamy (2012) described optimization of GA₃ production by submerged fermentation as well as solid state fermentation using *Fusarium moniliforme*. According to them, use of jatropha de-oiled seed cake as substrate for solid-state fermentation resulted in gibberellic acid yield of 105 mg/g of bran while 15 g/l by optimization of physiological parameters in submerged fermentation. Thus, an economically viable process for commercial production of GA₃ was described.

1.6 Extraction and purification of gibberellins (GA₃, GA₄ and GA₇)

During the fermentation process, the gibberellins are secreted into the medium. Prior to the extraction of gibberellins from dilute aqueous solutions, the fungus mycelium has to be separated from the broth by means of filtration and or centrifugation. The resulting culture filtrate contains a mixture of gibberellins, unconsumed nutrients and other water soluble metabolites of the fungus. The gibberellin purification procedure therefore requires the isolation of the gibberellin from the culture broth, followed by the separation of the gibberellins from each other. Commercially it is desirable to separate GA₃ from GA₄ and GA₇ because the plant regulatory effects of these gibberellins differ in some important aspects and the compounds have different applications. The separation of gibberellins A₄ and A₇, from each other is even more difficult by reason of the structural similarities between these two gibberellins. They differ from each other only by the absence or presence of an olefinic double bond between carbon atoms 1 and 2. Although several reports are available on the isolation of GA₃ from fermentation broth, its isolation in pure state is still a challenging task.

Earlier, the isolation of GA, from culture filtrates was reported by adsorption on active carbon. After adsorption, the gibberellins were eluted with water-miscible solvents such as methanol or acetone (Jefferys, 1970). This procedure required large amounts of solvents. Also desorption of gibberellins from active carbon is incomplete resulting in heavy losses of gibberellins and high costs and low efficiency.

Another commonly reported technique of gibberellin extraction from aqueous solution was the use of liquid-liquid extraction with water immiscible organic solvents like esters of simple alkane carboxylic acids as ethyl acetate or butyl acetate. For the purpose of extraction, the culture filtrate is adjusted to pH 2 with dilute aqueous hydrochloric acid and the gibberellins are extracted with ethyl acetate. Subsequent recovery of the gibberellins from this extract was achieved by adsorption on solid sodium or potassium bicarbonate or by buffer-solvent back extraction processes. However, liquid-liquid extraction demands large amounts of solvents and their recovery is expensive because of the solubility of these solvents in water that leads to heavy loss of the extracting solvent Jefferys, (1970).

A third means of gibberellin recovery is the use of ion-exchange resins characterized by binding GA, onto functional groups of the resins (Roux, 1964). As the gibberellin molecule contains a lactone ring that is essential for biological activity. This lactone ring is very unstable in acid and alkaline environments present during the desorption with ammonia. Using synthetic, highly porous polymeric adsorbents with a nonionic character and with a nonpolar or weakly polar surface such as Amberlite XAD-4, XAD-2, and XAD-7 the disadvantages can be avoided. Gibberellins are bound quantitatively by this type of resins. The elution by of the bound gibberellins can be achieved with aqueous solutions of methanol, acetone, or ethanol. The advantage is that gibberellins and impurities can be desorbed by the same solvent at different concentrations of the desorption solvent in water (Brucker and Blechschmidt, 1991).

Thus, in general GA₃ from the fermentation broth could be recovered either by adsorption or by solvent extraction and then purified by repeated liquid-liquid partition and concentration under vacuum. Finally gibberellins as amorphous powder or a crystalline product can be obtained.

The use of Emulsion Liquid Membrane (ELM) technology for GA₃ extraction from the fermentation broth appears to be an alternative to the conventional multi-stage extraction processes as described by Aroca *et al.*, (2010).

A few patents on gibberellin production by *Fusarium* strain and its separation from culture filtrate are presented in Table 1.4.

<i>Patent No.</i>	<i>Title</i>	<i>Reference</i>
US 2842051A	Gibberellic acid compounds and preparation and use thereof	Brian <i>et al.</i> , (1958)
US 2906671A	Process of producing gibberellic acid by cultivation of <i>Gibberella fujikuroi</i>	Borrow <i>et al.</i> , (1959)
US 2906673A	Metabolic process	Borrow <i>et al.</i> , (1959)
US 2906670	Process of producing gibberellic acid by two stage cultivation of <i>Gibberella fujikuroi</i>	Borrow <i>et al.</i> , (1959)
US 2977285	Process of producing gibberellic acid	Birch <i>et al.</i> , (1961)
US 2980700	Process of gibberellic acid purification	Gerald, (1961)
US 3021261A	Culture process for gibberellic acid	Bergman <i>et al.</i> ,

		(1962)
US 3084106	Conversion of hydrocarbons by <i>Gibberella fujikuroi</i>	Hitzman and Mills, (1963)
US 3738822	Gibberellin preparations	Asahi <i>et al.</i> , (1973)
US 4154596	Gibberellin salts	George <i>et al.</i> , (1979)
US 4156684	Gibberellin A.sub.4 separation	Crutcher and Richard, (1979)
JP 55120794	Preparation of gibberellins by fermentation	Takahashi <i>et al.</i> , (1980)
EP 0024951A3	Fermentation method for producing plant growth hormone	Graebbe and Rademacher, (1981)
EP 0078686A1	Process for making gibberellins	Turner <i>et al.</i> , (1983)
JP 58152499	Production of gibberellin A ₄	Iwasaki <i>et al.</i> , (1983)
EP 0024951B1	Fermentation method for producing gibberellin	Graebbe and Rademacher, (1983)
EP 0007240B1	Process of dehydroxylation of 13-hydroxy gibberellins and intermediates useful in the process	MacMillan <i>et al.</i> , (1984)
US 4578483	Gibberellin amine salts	Mabelis and Richard Peter, (1986)
EP 0112629B1	Plant growth regulators	Mabelis and Richard Peter, (1987)
DD 266591	Isolation of gibberellins from culture filtrate	Neumann <i>et al.</i> , (1989)
DD 282241	Isolation and purification from culture media	Koellner <i>et al.</i> , (1990)
CN 1063309	Solvent extraction of gibberellins from fermentation filtrate	Li <i>et al.</i> , (1992)
PL 163608	Method of isolating gibberellins from aqueous solutions	Heropolitanski <i>et al.</i> , (1994)
JP06090775A2	Gibberellins manufacture from ent-kaurene	Jumoku and Seibun, (1994)
JP06090775	Production of gibberellins	Tachibana <i>et al.</i> , (1994)
US5562831	Method for separation of gibberellin	Ku <i>et al.</i> , (1996)

	mixtures	
RU 2084531	Strain of <i>Fusarium moniliforme</i> ó a producer of the phytohormones gibberellins A4 and A7	Fond Mishustina, (1997)
JP 10158256	3-EPI-Gibberellic acid ether and its production	Seto <i>et al.</i> , (1998)
JP 3183722	Production of gibberellins	Tachibana <i>et al.</i> , (2001)
US 6287800	Production of high titers of gibberellins GA ₄ and GA ₇ by <i>Gibberella fujikuroi</i> LTB-1027	Gallazoo and Lee, (2001)
WO 2002055725A2	Novel Nucleic acids, methods and transformed cells for the modulation of gibberellins production	Tudzynski, (2002)
US 7846699B2	Process for gibberellic acid production with <i>Fusarium moniliforme</i> strain	Rangaswamy and Balu, (2010)

Table 1.4 A few patents on gibberellins (GA₃ and GA₄) production by *Fusarium* strain and their separation from culture filtrate

At present, the annual world production of GA₃ exceeds about 50 tons with a market value of US \$100 million. In India, although gibberellic acid is used for several years, the requirement is mainly met through imports from the companies like Zhejiang Biotech (China), Phylaxia (Hungary), Abbott Laboratories (USA) *etc.* The international price ranges between 200 to 500 US \$ per kg. In India, GA₃ is mainly used for the growth of seedless varieties of grapes. An association of grape farmers, Maharashtra Grape Growers Association, imports and supplies about two metric tons of good quality of gibberellic acid to the members of the association. In local market in India, GA₃ is available at 45-70 Rupees per gram and is relatively expensive compound used in agriculture. Gibberellic acid although being used in India for more than 20 years, is not manufactured in the country.

Production of gibberellins (GA₃, GA₄ and GA₇) in *F. fujikuroi* is governed by a variety of factors like producing strain, concentration and type carbon and nitrogen source, medium composition and environmental factors like pH, temperature and dissolved oxygen. Production of these gibberellins, therefore, is a scientifically challenging topic and has an industrial importance because of its increasing demand in the world.

1.7 REFERENCES

- Agosin, E., Maureira, M., Biffani, V., Perez, F. 1997. Production of gibberellins by solid substrate cultivation of *Gibberella fujikuroi*. In: *Advances in Solid State Fermentation*. Roussos, S., Lonsane, B.K., Raimbault, M. *et al.*, Dordrecht, Kluwer, 355-366.
- Agusti, D.M., Juan, G.R.M., Reig, C. 2006. The inhibition of flowering by means of gibberellic acid application reduces the cost of hand thinning in Japanese plums (*Prunus salicina Lindl.*). *Scientia Horticulturae*, **110**, 319-323.
- Aroca, G., Berrios, J., Leo Pyle, D. 2010. Gibberellic acid extraction from aqueous solutions and fermentation broths by using emulsion liquid membranes. *Journal of Membrane Science*, **348**, 91-98.
- Asahi, Y., Hyogo., Nakamachi, H. 1973. Gibberellin preparations, *US 3738822*.
- Avalos, J., Sanchez-Fernandez, R., Fernandez-Martin, R., Candau, R. 1997. Regulation of gibberellin production in the fungus *Gibberella fujikuroi*. *Recent Research Development in Plant Physiology*, **1**, 105-115.
- Ayele, B.T., Ozga, J.A., Kurepin, L.V., Reinecke, D.M. 2006. Developmental and embryo axis regulation of gibberellin biosynthesis during germination. *Plant Physiology*, **142**, 1267-1281.
- Bacon, C.W., Porter, J.K., Norred, W.P., Leslie, J.F. 1996. Production of fusaric acid by *Fusarium* species. *Applied and Environmental Microbiology*, **62**, 4039-4043.
- Bandelier, S., Renaud, R., Durand, A., 1997. Production of gibberellic acid by fed-batch solid state fermentation in an aseptic pilot-scale reactor. *Process Biochemistry*, **32**, 141-145.
- Bearder, J.R. 1983. In vivo diterpenoid biosynthesis in *Gibberella fujikuroi*: the pathway after ent-kaurene. In: *The biochemistry and physiology of gibberellins*. Crozier A Ed Praeger, New York.
- Bergman, D.E., Waukegan., Denison, F.W. 1962. Culture process for gibberellic acid, *US 3021261A*.
- Birch, A.J., Manchester, Nixon, I.S., 1961. Process of producing gibberellic acid, *US 2977285*.

- Birch, A.J., Richards, R.W., Smith, H., Harris, A., Whalley, W.B. 1959. Studies in relation to biosynthesis: XII. Rosenonolactone and gibberellic acid. *Tetrahedron*, **7**, 241-251.
- Birch, A.J., Richards, R.W., Smith, H., 1958. The biosynthesis of gibberellic acid. *Proceedings of the Chemical Society*, **1**, 192-193.
- Borrow, A., Brown, S., Jefferys, E.G., Kessell, R.H.J., Lloyd, P.B., Rothwell, A., Swait, J.C. 1964. The kinetics of metabolism of *Gibberella fujikuroi* in stirred culture. *Canadian Journal of Microbiology*, **10**, 4076444.
- Borrow, A., Jefferys, E.G., Nixon, I.S. 1959. Process of producing gibberellic acid by cultivation of *Gibberella fujikuroi*, US 2906671A.
- Borrow, A., Jefferys, E.G., Nixon, I.S. 1959. Metabolic process, US 2906673A.
- Borrow, A., Jefferys, E.G., Nixon, I.S. 1959. Process of producing gibberellic acid by two stage cultivation of *Gibberella fujikuroi*, US 2906670.
- Borrow, A., Brian, P.W., Chester, V.E., Curtis, P.J., Hemming, H.G., Henehan, C., Jefferys, E.G., Lloyd, P.B., Nixon, I.S., Norris, G.L.F., Radley, M. 1955. Gibberellic acid, a metabolic product of the fungus *Gibberella fujikuroi*: some observations on its production and isolation. *Journal of the Science of Food and Agriculture*, **6**, 340-348.
- Brian, P.W., Radley, M.E., Curtis, P.J., Elson, G.W. 1958. Gibberellic acid compounds and preparation and use thereof, US 2842051A.
- Britz, H., Coutinho T.A., Wingfield, M.J., Marasas, W.F.O., Gordon, T.R., Leslie, J.F. 1999. *Fusarium subglutinans f. sp. pini* represents a distinct mating population in the *Gibberella fujikuroi* species complex. *Applied and Environmental Microbiology*, **65**, 1198-1201.
- Buðock, J.D., Detroy, R.W., Hostalek, Z., Munim-Al-Shakarchi, A. 1974. Regulation of secondary metabolism in *Gibberella fujikuroi*. *Transactions of the British Mycological Society*, **62**, 377-389.
- Bruckner, B., Blechschmidt, D. 1991. Nitrogen regulation of gibberellin biosynthesis in *Gibberella fujikuroi*. *Applied Microbiology and Biotechnology*, **53**, 646-650.
- Candau, R., Avalos, J., Cerda-Olmedo, E. 1992. Regulation of gibberellin biosynthesis in *Gibberella fujikuroi*. *Plant Physiology*, **100**, 1184-1188.

- Candau, R., Avalos, J. Cerda-Olmedo, E. 1991. Gibberellins and carotenoids in the wild type and mutants of *Gibberella fujikuroi*. *Applied and Environmental Microbiology*, **57**, 3378-3382.
- Chan, B.G., Cain, J.C., 1967. The effect of seed formation on subsequent flowering in apple. *Proceedings of the American Society for Horticultural Science*, **91**, 63-67.
- Corey, E. J., Danheiser, R. L., Chandrasekaran, S., Siret, P., Keck G. E., Gras, J. L. 1978. Stereospecific total synthesis of gibberellic acid. A key tricyclic intermediate. *Journal of the American chemical society*, **100**(25), 8031-8034.
- Cosgrove, D.J., Sovonick-Dunford, S.A. 1989. Mechanism of gibberellin-dependent stem elongation in peas. *Plant Physiology*, **89**, 184-91.
- Cross, B.E., Grove, J.F., MacMillan, J., Moffatt, J.S., Mulholland, T.P.C., Seaton, J.C., Sheppard, N., 1959. A revised structure for gibberellic acid. *Proceedings of the Chemical Society*, **30**, 302-303.
- Crutcher., Richard, E. 1979. Gibberellin A.sub.4 separation, *US 4156684*.
- Curtis, P.J., Cross, B.E., 1954. Gibberellic acid. A new metabolite from the culture filtrates of *Gibberella fujikuroi*. *Chemistry and Industry*(London), 1066.
- Darken, M.A., Jensen, A.L., Shu, P. 1959. Production of gibberellic acid by fermentation. *Journal of Applied Microbiology*, **7**, 301-303.
- Darken, M.A., Jensen A.L., Shu, P. 1959. Production of gibberellic acid by fermentation. *Applied Microbiology*, **7**, 301-303.
- Davies, P.J. 2010. The plant hormones: their nature, occurrence, and functions. *Plant Hormones*, 1-15.
- Demain, A.L. 2000. Small bugs, big business:The economic power of the microbe. *Biotechnology Advances*, **18**(6), 499-514.
- Desjardins, A.E., Manandhar, G., Plattner, R.D., Maragos, C.M., Shrestha, K., McCormick, S.P. 2000. Occurrence of *Fusarium* species and mycotoxins in Nepalese maize and wheat and the effect of traditional processing methods on mycotoxin levels. *Journal of Agricultural and Food Chemistry*, **48**, 1377-1383.
- Desjardins, A.E., Plattner, R.D., Nelsen, T.C., Leslie, J.F. 1995. Genetic analysis of fumonisin production and virulence of *Gibberella fujikuroi* mating population A (*Fusarium moniliforme*) on maize (*Zea mays*) seedlings. *Applied and Environmental Microbiology*, **61**, 79-86.

- Domenech, C.E., Giordano, W., Avalos, J., Cerda-Olmedo, E. 1996. Separate compartments for the production of sterols, carotenoids and gibberellins in *Gibberella fujikuroi*. *European Journal of Biochemistry*, **239**, 720-725.
- Dowzer, C.E.A., Kelly, J.M. 1991. Analysis of the creA gene, a regulator of carbon catabolite repression in *Aspergillus nidulans*. *Molecular and Cellular Biology*, **11**, 5701-5709.
- Escamilla-Silva, E.M., Chavez-Parga, M.D.C. Gonzalez-Ortega, O., Negrete-Rodriguez, M.L.X., Alatorre, G.G. 2008. Kinetics of the gibberellic acid and bikaverin production in an airlift bioreactor. *Process Biochemistry*, **43**(8), 855-860.
- Escamilla-Silva, E.M., Dendooven, L., Magana, I.P., Parra, R.S., De la Torre, M., 2000. Optimization of gibberellic acid production by immobilized *Gibberella fujikuroi* mycelium in fluidized bioreactors. *Journal of Biotechnology*. **76**, 147-155.
- Escamilla-Silva, E.M., Dendooven, L., Reynell, U.J.A., Ramirez, M.A.I., Alatorre, G.G.L., Martinez, M.T. 1999. Morphological development and gibberellin production by different strains of *Gibberella fujikuroi* in shake flasks and bioreactor. *World Journal of Microbiology and Biotechnology*, **15**, 753-755.
- Fleet, C.M., Sun, T.P. 2005. A DELLAcate balance: The role of gibberellin in plant morphogenesis. *Current Opinion in Plant Biology*, **8**, 77-85.
- Fond, M. 1997. Strain of *Fusarium moniliforme* ó a producer of the phytohormones gibberellins A4 and A7, *RU 2084531*.
- Fuska, J., Kuhr, I., Podojil, M., Sevcik, V., 1961. The influence of the nitrogen source on the production of gibberellic acid in submerged cultivation of *Gibberella fujikuroi*. *Folia Microbiologica*, **6**, 18-21.
- Gallazoo, J.L., Lee, M.D. 2001. Production of high titers of gibberellins GA₄ and GA₇ by *Gibberella fujikuroi* LTB-1027, *US 6287800*.
- Gancheva, V., Dimova, Ts., Kamenov, K., Foutekova, M. 1984. Biosynthesis of gibberellins. III. Optimization of nutrient medium for biosynthesis of gibberellins upon using mathematical methods for planning the experiments. *Acta Microbiologica Bulgarica*, **14**: 80.
- Geissman, T.A., Verbiscar, A.J., Phinney, B.O., Cragg, G. 1966. Studies on the biosynthesis of gibberellins from (3)-kaurenoic acid in cultures of *Gibberella fujikuroi*. *Phytochemistry*, **5**, 933-947.

- Gelmi, C., Perez-Correa, R., Gonzalez, M. Agosin, E. 2000. Solid substrate cultivation of *Gibberella fujikuroi* on an inert support. *Process Biochemistry*, **35**, 1227-1233.
- George., Edwin, F., Lawrence; Jeffrey, C., Middleton., Michael, R. 1979. Gibberellin salts, *US 4154596*.
- Gerald, W.P. 1961, Process of gibberellic acid purification, *US 2980700*.
- Gianfagna, T. 1995. Natural and synthetic growth regulators and their use in horticultural and agronomic crops. In: *Plant Hormones*. Davies, P.J. (ed), Dordrecht: Kluwer Academic Publishers, 751-773.
- Giordano, W., Domenech, C.E. 1999. Aeration affects acetate destination in *Gibberella fujikuroi*. *FEMS Microbiology Letters*, **180**, 111-116.
- Graebe, J.E. 1987. Gibberellin biosynthesis and control. *Annual Review of Plant Physiology*, **38**, 419-465.
- Graebe, J., Rademacher, W. 1983. Fermentation method for producing gibberellins, *EP 0024951B1*.
- Graebe, J., Rademacher, W. 1981. Fermentation method for producing plant growth hormone, *EP 0024951A3*.
- Hartweck, L.M. 2008. Gibberellin signalling. *Planta*, **229**, 1-13.
- Hedden, P., Phillips, A.L., Rojas, M.C., Carrera, E., Tudzynski, B., 2002. Gibberellin biosynthesis in plants and fungi: a case of convergent evolution? *Journal of Plant Growth Regulation*, **20**, 319-331.
- Hedden, P., MacMillan, J., Phinney, B.O. 1974. Fungal products. Part XII. Gibberellin A14-aldehyde, an intermediate in gibberellins biosynthesis in *Gibberella fujikuroi*. *Journal of the Chemical Society Perkin Transactions 1*, 587-592.
- Heinrich, M, Rehm, H.J. 1981. Growth of *Fusarium moniliforme* on n-alkanes: comparison of an immobilization method with conventional processes. *European Journal of Applied Microbiology and Biotechnology*, **11**(3), 139-145.
- Heropolitanski, R., Kominiak, M.J., Machalowska, M. 1994. Method of isolating gibberellins from aqueous solutions, *PL 163608*.
- Hitzman, D.O., Mills, A.M. 1963. Conversion of hydrocarbons by *Gibberella fujikuroi*, *US 3084106*.

- Ho, R.H., 1988. Gibberellin A_{4/7}, enhances seed cone production in field-grown black spruce, *Canadian Journal of Forest Research*, **18**, 139.
- Hoad, G.V., 1984. Hormonal regulation of fruit bud formation in fruit trees. *Acta Horticulturae*, **149**, 13-23.
- Holme, T., Zacharias, B. 1965. Gibberellic acid formation in continuous culture. *Biotechnology and Bioengineering*, **7**: 405-415.
- Hollmann, D., Geipel, S., Switalski, J., Onken, U. 1995. Extractive fermentation of gibberellic acid by *Gibberella fujikuroi*. *Journal of fermentation and Bioengineering*, **79**, 594-600.
- Homann, V., Mende, K., Arntz, C., Ilardi, V., Macino, G., Morelli, G., Bose, G., Tudzynski, B. 1996. The isoprenoid pathway: cloning and characterization of fungal FPPS genes. *Current Genetics*, **30**, 232-239.
- Ito, S., Kimura, J., 1931. Studies on the bakanae disease of the rice plant. *Rep. Hokkaido National Agricultural Experiment Station*, **27**, 1-99.
- Iwasaki, Toshiaki, I., Kunio, S., Masasuke, M., Kazuyuki, A., Takemitsu. 1983. Production of gibberellin A₄, JP 58152499.
- Jefferys, E.G. 1970. The gibberellin fermentation. *Advances in Applied Microbiology*, **13**, 283-316.
- Jumoku, S., Seibun. 1994. Gibberellins manufacture from ent-kaurene, JP 06090775A2.
- Kappel, F., MacDonald, R. 2007. Early gibberellic acid spray increase fruiting and fruit size of Sweetheart sweet cherry. *Journal-American Pomology Society*, **61**(1), 38-43.
- Karakoc, S., Aksoz, N., 2006. Some optimal cultural parameters for gibberellic acid biosynthesis by *Pseudomonas sp.* *Turk Journal of Biology*, **30**, 81-85.
- Kato, J., Purves, W.K., Phinney, B.O., 1962. Gibberellin-like substances in plants. *Nature*, **196**, 687-688.
- Kedera, C.J., Plattner, R.D., Desjardins, A.E. 1999. Incidence of *Fusarium spp.* and levels of fumonisin B1 in maize in western Kenya. *Applied and Environmental Microbiology*, **65**, 41-44.
- Keller, N.P., Turner, G., Bennett, J.W. 2005. Fungal secondary metabolism from biochemistry to genomics. *Nature Reviews Microbiology*, **3**, 937-947
- Kende, H. 1967. Preparation of radioactive gibberellin A1 and its metabolism in dwarf peas *Plant Physiology*, **42**, 1612-1618.

- Kerenyi, Z., Zeller, K., Hornok, L., Leslie, J.F. 1999. Standardization of mating type terminology in the *Gibberella fujikuroi* species complex. *Applied and Environmental Microbiology*, **65**, 4071-4076.
- Khalaf, M.A., Samir, M.A. 2009. Biosynthesis of gibberellic acid from milk permeate in repeated batch operation by a mutant *Fusarium moniliforme* cells immobilized on loofa sponge. *Bioresource Technology*, **100**, 374-379.
- Koellner, H.J., Ludwin, H.W.L., Neumann, E., Paul, D., Kerns, G., Steffen, J. 1990. Isolation and purification from culture media, *DD 282241*.
- Ku., Yin, Y., Sawick., David, P. 1996. Method for separation of gibberellin mixtures, *US 5562831*.
- Kumar, P.K.P., Lonsane, B.K., 1989. Microbial production of gibberellins: State of the art. *Advances in Applied Microbiology*, **34**, 29-138.
- Kumar, P.K.P., Lonsane, B.K. 1988. Immobilized cells of *Gibberella fujikuroi* P3 for production of gibberellic acid and pigment in batch semi-continuous culture. *Applied Microbiology and Biotechnology*, **28**:537-542.
- Kumar, P.K.R., Lonsane, B.K. 1987. Gibberellic acid by solid state fermentation: Consistent and improved yields. *Biotechnology and Bioengineering*, **30**, 267-271.
- Kurosawa, E., 1926. Experimental studies on the nature of the substance secreted by the *bakanae* fungus. *Transactions of the Natural History Society of Formosa*, **16**, 213-227.
- Lang, A., 1956. Bolting and flowering in biennial *Hyoscyamus niger*, induced by gibberellic acid. *Plant Physiology*, **31**, (Suppl.), xxxv.
- Leslie, J.F. 1995. *Gibberella fujikuroi*: available populations and variable traits. *Canadian Journal of Botany*, **73**, 282-291.
- Leslie, J.F., Doe, R.D., Plattner, D., Shackelford, D., Jonz, J. 1992. Fumonisin B1 production and vegetative compatibility of strains from *Gibberella fujikuroi* mating population $\delta A\delta$ (*Fusarium moniliforme*). *Mycopathologia*, **117**, 37-46.
- Li, Z., Lei, J., Zhang, D. 1992. Solvent extraction of gibberellins from fermentation filtrate, *CN 1063309*.
- Linnemannstons, P., Prado, M.M., Fernandez-Martin, R., Tudzynski, B., Avalos, J. 2002a. A carotenoid biosynthesis gene cluster in *Fusarium fujikuroi*: the genes carB and carRA. *Molecular Genetics and Genomics*, **267**, 593-602.

- Linnemannstons, P., Schulte, J., Prado, d.M.M., Proctor, R.H., Avalos, J., Tudzynski, B. 2002b. The polyketide synthase gene *pks4* from *Gibberella fujikuroi* encodes a key enzyme in the biosynthesis of the red pigment bikaverin. *Fungal Genetics and Biology*, **37**, 143-148.
- Lu, Z-X., Xie, Z-C., Kumakura, M. 1995. Production of gibberellic acid in *Gibberella fujikuroi* adhered onto polymeric fibrous carriers. *Process Biochemistry*, **30**(7), 661-665.
- Ludwig, J., Haeckert, H. 1989. Isolation of gibberellins from culture filtrate, *DD 266591*.
- Mabelis., Richard, P. 1986. Gibberellin amine salts, *US 4578483*.
- Mabelis., Richard, P. 1987. Plant growth regulators, *EP 0112629B1*.
- MacMillan, J., 1997. Biosynthesis of the gibberellin plant hormones. *Natural Product Research*, **14**, 221-243.
- MacMillan., Beale., Michael., H. 1984. Process of dehydroxylation of 13-hydroxy gibberellins and intermediates useful in the process, *EP 0007240B1*.
- MacMillan, J., Takahashi, N. 1968. Proposed procedure for the allocation of trivial names to the gibberellins. *Nature*, **217**, 170-171.
- Maddox, I.S., Richert, S.H. 1977. Production of gibberellic acid using a dairy waste as the basal medium. *Applied and Environmental Microbiology*, **33**(1), 201-202.
- Mander, L.N. 2003. Twenty years of gibberellin research. *Natural Product Report*, **20**, 49-69.
- Martin, G.C. 1983. Commercial uses of gibberellins. In: *The Biochemistry and Physiology of Gibberellin*, Volume 2, chap. 11, Crozier A Ed Praeger, New York.
- Marzluf, G.A. 1997. Genetic regulation of nitrogen metabolism in the fungi. *Microbiology and Molecular Biology Reviews*, **61**, 17-32.
- McArtney, S.J., Li, S.H., 1998. Selective inhibition of flowering on Braeburn apple trees with gibberellins. *Journal of Horticultural Science*, **33**, 699-700.
- McLaughlin, J.M., Greene, D.W. 1984. Effects of BA, GA₄₊₇, and daminozide on fruit set, fruit quality, vegetative growth, flower initiation, and flower quality of Golden Delicious apple. *Journal of the American Society for Horticulture Science*, **109**, 34-39.

- Mende, K., Homann, V., Tudzynski, B. 1997. The geranylgeranyl diphosphate synthase gene of *Gibberella fujikuroi*: isolation and expression. *Molecular and General Genetics*, **255**, 96-105.
- Mihlan, M., Homann, V., Liu, T.W.D., Tudzynski, B. 2003. AREA directly mediates nitrogen regulation of gibberellin biosynthesis in *Gibberella fujikuroi*, but its activity is not affected by NMR. *Molecular Microbiology*, **47**, 975-991.
- Munoz, G.A., Agosin, E. 1993. Glutamine involvement in nitrogen control of gibberellic acid production in *Gibberella fujikuroi*. *Applied and Environmental Microbiology*, **59**, 4317-4322.
- Muromtsev, G.S., Agnistova, V.N. 1984. Gibberellins (in Russian). In: Letunova, S.V., (ed.) Nauka, Moscow.
- Nava-Saucedo, J.E., Barbotin, J-N, Thomas D 1989. Continuous production of gibberellic acid in a fixed-bed reactor by immobilized mycelia of *Gibberella fujikuroi* in calcium alginate beads. *Applied Microbiology and Biotechnology*, **30**(3), 226-233.
- Neumann, E., Mueller, S., Butter, E., Fengler, B., Kramer, P., Koellner, H., Kuenstler, R., Takahashi., Nobutaka, M., Akira. 1980. Preparation of gibberellins by fermentation, *JP 55120794*.
- Nirenberg, H.I., O'Donnell, K. 1998. New *Fusarium* species and combinations within the *Gibberella fujikuroi* species complex. *Mycologia*, **90**, 434-458.
- O'Donnell, K., Cigelnik, E., Nirenberg, H.I. 1998. Molecular systematics and phylogeography of the *Gibberella fujikuroi* species complex. *Mycologia*, **90**, 465-49.
- Ozga, J.A. Huizen, R., Reinecke, D.M. 2002. Hormone and seed-specific regulation of pea fruit growth. **128**, 1-11.
- Paroussi, G., Voyiatzis, D.G., Paroussi, E., Drogour, P.D. 2002. Growth, flowering and yield responses to GA₃ of strawberry grown under different environmental conditions. *Scientia Horticulturae*, **96**, 103-113.
- Pastrana, L.M., Gonzalez, M.P., Torrado, A. and Murado, M.A. 1995. A fed batch culture model for improved production of gibberellic acid from waste medium. *Biotechnology Letters*, **17**, 2636268.
- Pastrana, L.M., Gonzalez, M.P., Torrado, A. and Murado, M.A. 1993. Production of gibberellic acid from mussel processing waste in submerged batch culture. *Bioresource Technology*, **45**, 213-221.

- Pharis, R.P., King, R.W. 1985. Gibberellins and reproductive development in seed plants. *Annual Review of Plant Physiology*, **36**, 517-568.
- Rademacher, W. 1997. Gibberellins. In: *Fungal Biochemistry*. Anke T Ed Chapman & Hall, London, 193-205.
- Radley, M. 1956. Occurrences of substances similar to gibberellic acid in higher plants. *Nature*, **178**, 107061071.
- Rangaswamy, V. 2012. Improved Production of Gibberellic Acid by *Fusarium moniliforme*. *Journal of Microbiology Research*, **2**(3), 51-55.
- Rangaswamy, V., Balu, G. 2010. Process for gibberellic acid production with *Fusarium moniliforme* strain, US 7846699B2.
- Rappaport, L. 1980. Applications of gibberellins in agriculture. In: *Plant Growth Substances*, Skoog F Ed Berlin, 377.
- Robinson, T, Singh, D., Nigam, P. 2001. Solid state fermentation a promising microbial technology for secondary metabolite production. *Applied Microbiology and Biotechnology*, **55**, 284-289.
- Rojas, M.C., Hedden, P., Gaskin, P., Tudzynski, B. 2001. The P450-1 gene of *Gibberella fujikuroi* encodes a multifunctional enzyme in gibberellin biosynthesis. *Proceedings of the National Academy Sciences of the USA*, **98**, 5838-5843.
- Sanchez-Marroquin, A. 1963. Microbiological production of gibberellic acid in glucose media. *Applied Microbiology*, **11**, 523-528.
- Sawada, K., 1917. Contributions on Formosan fungi. *Transactions of the Natural History Society of Formosa*, **7**, 131-133.
- Shukla, R., Chand, S., Srivastava, A. K. 2005. Improvement of gibberellic acid production using a model based fed-batch cultivation of *Gibberella fujikuroi*. *Process Biochemistry*, **40**, 2045-2050.
- Shukla, R., Chand, S., Srivastava, A.K. 2005. Batch kinetics and modeling of gibberellic acid production by *Gibberella fujikuroi*. *Enzyme and Microbial Technology*, **36**, 492-497.
- Seto., Hideharu, Y., Shigeo. 1998. 3-EPI-Gibberellic acid ether and its production, JP10158256.
- Song, Z., Cox, R.J., Lazarus, C.M., Simpson, T.J. 2004. Fusarin C biosynthesis in *Fusarium moniliforme* and *Fusarium venenatum*. *ChemBioChem*, **5**, 1196-1203.

- Sponsel, V.M., Hedden, P., 2004. Gibberellin biosynthesis and inactivation. In: Plant Hormones: Biosynthesis, Signal transduction, Action. Davies PJ Ed Kluwer Academic Publishers, Dordrecht, Netherlands, 63-94.
- Stodola, F.H., Raper, K..B., Fenell, D.T., Conway, H.F., Johns, V.E., Langford, C.T., Jackson, R.W. 1955. *Archives of Biochemistry and Biophysics*, **54**, 240-245.
- Tachibana., Kubota A., Azuma, M., Masahiro. 2001. Production of gibberellins, *JP 3183722*.
- Tachibana., Kubota, A., Azuma, M., Masahiro.1994. Production of gibberellins, *JP 06090775*.
- Takahashi, N., Kitamura, H., Kawarada, A., Seta, Y., Takai, M., Tamura, S., Sumiki, Y. 1955. Isolation of gibberellins and their properties. *Journal of the Agricultural Chemical Society of Japan*, **19**, 267-277.
- Teichert, S., Schonig, B., Richter, S., Tudzynski, B. 2004. Deletion of the *Gibberella fujikuroi* glutamine synthetase gene has significant impact on transcriptional control of primary and secondary metabolism. *Molecular Microbiology*, **53**, 1661-1675.
- Tromp, J., 2000. Flower-bud formation in pome fruits as affected by fruit thinning. *Plant Growth Regulation*, **31**, 27-34.
- Tompsett, P.B., Fletcher, A.M. 1979. Promotion of flowering on mature *Picea sitchensis* by gibberellins and environmental treatments. The influence of timing and hormonal concentration. *Plant Physiology*, **45**, 112.
- Tudzynski, B., 2005. Gibberellin biosynthesis in fungi: genes, enzymes, evolution, and impact on biotechnology. *Applied Microbiology and Biotechnology*, **66**, 597-611.
- Tudzynski, B., Mihlan, M., Rojas, M.C., Linnemannstöns, P., Gaskin, P., Hedden, P., 2003. Characterization of the final two genes of the gibberellins biosynthesis gene cluster of *Gibberella fujikuroi*: des and P45063 encode GA₄ desaturase and the 13-hydroxylase respectively. *Journal of Biological Chemistry*, **278**, 28635-28643.
- Tudzynski, B., Mihlan, M., Rojas, M.P., Gaskin, P., Hedden, P. 2003. Characterization of the final two genes of the gibberellins biosynthesis gene cluster of *Gibberella fujikuroi*. *Journal of Biological Chemistry*, **278**, 28635-28643.

- Tudzynski, B. 2002. Novel Nucleic acids, methods and transformed cells for the modulation of gibberellins production, *WO 2002055725A2*.
- Tudzynski, B., Rojas, M.C., Gaskin, P., Hedden, P., 2002. The gibberellin 20-oxidase of *Gibberella fujikuroi* is a multifunctional monooxygenase. *Journal of Biological Chemistry*, **277**, 21246-21253.
- Tudzynski, B., Songjie, L., Kelly, J.M. 2000. Carbon catabolite repression in plant pathogenic fungi: isolation and characterization of the *Gibberella fujikuroi* and *Botrytis cinerea* creA genes B. *FEMS Microbiology Letters*, **184**, 9-15.
- Tudzynski, B. 1999. Biosynthesis of gibberellins in *Gibberella fujikuroi*: biomolecular aspects. *Applied Microbiology and Biotechnology*, **52**, 298-310.
- Tudzynski, B., Homann, V., Feng, B., Marzluf, G.A. 1999. Isolation, characterization and disruption of the areA nitrogen regulatory gene of *Gibberella fujikuroi*. *Molecular and General Genetics*, **261**, 106-114.
- Tudzynski, B., Holter, K. 1998. Gibberellin biosynthetic pathway in *Gibberella fujikuroi*: evidence for a gene cluster. *Fungal Genetics and Biology*, **25**, 157-170.
- Tudzynski, B., Kawaide, H., Kamiya, Y. 1998. Gibberellin biosynthesis in *Gibberella fujikuroi*: cloning and characterization of the copalyl diphosphate synthase gene. *Current Genetics*, **34**, 234-240.
- Turner., Vincent, J., Bell., Arthur, R. 1983. Process for making gibberellins, *EP 0078686A1*.
- Ueguchi-Tanaka, M., Ashikari, M., Nakajima, M., Itoh, H., Katoh, E., Kobayashi, M., Chow, T.H.Y., Kitano, H., Yamaguchi, I., Matsuoka, M. 2005. GIBBERELLIN INSENSITIVE DWARF1 encodes a soluble receptor for gibberellin. *Nature*, **437**, 693-698.
- Urrutia, O., Hedden, P., Rojas, M.C. 2001. Monooxygenases involved in GA12 and GA14 synthesis in *Gibberella fujikuroi*. *Phytochemistry*, **56**, 505-511.
- Vass, R.C., Jefferys, E.G. 1979. Gibberellic acid. In: *Economic microbiology, Volume 3, Secondary products of metabolism*. Rose A H Ed Academic Press, London, 421-435.
- Voyiatzis, D.G., Paraskevopoulou-Paroussi, G., 2002. The effect of photoperiod and gibberellic acid on strawberry pollen germination and stamen growth. *Acta Horticulturae*, **567**, 257-260.

- Webster, A.D., Spencer, J.E., 2000. Fruit thinning plums and apricots. *Plant Growth Regulation*, **31**, 101-112.
- Willige, B.C., Ghosh, S., Nill, C., Zourelidou, M., Dohmann, E.M., Maier, A., Schwechheimer, C. 2007. The DELLA domain of GA INSENSITIVE mediates the interaction with the GA INSENSITIVE DWARF1A gibberellin receptor of *Arabidopsis*. *Plant Cell*, **19**, 1209-1220.
- Woitek, S., Unkles, S.E., Kinghorn, J.R., Tudzynski, B. 1997. 3-Hydroxy-3-methylglutaryl-CoA reductase gene of *Gibberella fujikuroi*: isolation and characterization. *Current Genetics*, **31**, 38-47.
- Yabuta, T. 1935. Biochemistry of the bakanae fungus of rice. *Agriculture Horticulture*, **10**, 17-22.
- Yabuta, T., Sumiki, T. 1938. On the crystal of gibberellin, a substance to promote plant growth. *Journal of the Agricultural Chemical Society of Japan*, **14**, 1526.
- Yamaguchi, S. 2008. Gibberellin metabolism and its regulation. *Annual Review of Plant Biology*, **59**, 225-259.

Chapter 2

Analytical Methods

Abstract:

This chapter summarizes analytical methods used during the course of the study. The microbiological and microscopic techniques such as cell growth measurement in terms of dry cell weight (DCW), fragments and protoplast counts are also described. Analysis of gibberellins (GA₃ and GA₄) and mycotoxins like fusaric acid and moniliformin by high performance liquid chromatography (HPLC) is described. Confirmation of gibberellin (GA₃) extracted and purified from the fermentation broth performed using chemical and physical techniques such as LC-MS, NMR and melting point is described.

2.1 Analytical and Microbiological Methods Employed During Course of Study

<i>Analyte</i>	<i>Methodology</i>
Fungal fragments/Protoplasts, Yeast Cell/Protoplasts Count	Microscopic techniques, Neubauer Improved Cell Counting Chamber
Fungal Growth Measurement	Dry Cell Weight Estimation
Residual Sugar Estimation	LIQUIZONE Glucose-MR GOD-POD kit and also by HPLC and dinitrosalicylic acid (DNS) method
Intracellular Lipid	Solvent Extraction Method
Gibberellin A ₃	Reversed Phase HPLC
Gibberellin A ₄	Reversed Phase HPLC
Fusaric acid	Reversed Phase HPLC
Moniliformin	Reversed Phase HPLC
Extracted and Purified GA ₃	Melting Point
Extracted and Purified GA ₃ Chemical Characterization	Nuclear Magnetic Resonance, LC-MS
GA ₃ and GA ₄ in fermentation broth	Liquid chromatography with Mass Detector

2.2 Chemicals

Gibberellic acid (G 7645), GA₄ (G 7276), fusaric acid (F 6513) and moniliformin (M 5269) were purchased from Sigma Chemical Company, St Louis, MO, USA and were used as reference compounds for high performance liquid chromatography (HPLC) and LC-MS analysis. HPLC grade acetonitrile and methanol, chloroform, formic acid (85 %), ammonium di-hydrogen phosphate and phosphoric acid (AR grade) were procured from E. Merck (Mumbai, India Ltd). For analysis of residual glucose from fermentation broth LIQUIZONE Glucose-MR GOD-POD kit was purchased from Medsource Ozone Biochemicals Pvt. Ltd., Delhi, India.

2.3 Details of Analytical methods

2.3.1 Microscopic Count of Cells/Fragments and Protoplasts

Fragments and protoplasts were counted under a microscope using Neubauer improved cell counting chamber (Marienfeld, Germany). Around 150 microliters of the cell/protoplast suspension was placed on the cell count slide. It was covered with cover slip and excess liquid was removed. Fragments/protoplasts present in each square of $1/16 \text{ mm}^2$ were counted. Cells/ mycelia fragments in all 16 squares were counted. Fragments/protoplasts present per square were calculated. The fragments/protoplasts per microliter were calculated by following formula.

The fragments/protoplasts per microliter = Fragments/protoplasts per square (average) x160

Suspension of fragments/protoplasts was diluted, if necessary.

2.3.2 Dry cell weight Estimation

For dry cell weight (DCW) estimation, fifty ml whole broth sample from shake flasks or fermenter was filtered under vacuum through Whatmann filter paper Grade-1. The cell mass was washed twice with distilled water and then the cell mass residue was taken to constant weight in an oven at $103 \text{ }^\circ\text{C}$.

2.3.3 Residual Sugar Analysis

2.3.3.1 Estimation of sugar by using LIQUIZONE Glucose-MR GOD-POD kit

The procedure recommended by the company was used for the analysis of sugar.

I. Principle of analytical method

Glucose is oxidised to gluconic acid and hydrogen peroxide in presence of glucose oxidase. Hydrogen peroxide further reacts with phenol and 4-aminoantipyrine by the catalytic action of peroxidase to form a red colored quinoneimine dye complex. Intensity

of the color formed is directly proportional to the amount of glucose present in the test sample.

II. Procedure

Concentration of standard glucose solution was 1 mg/ml

Additions into clean and dry test tubes labelled as Blank, Standard and Test were as follow

<i>Addition sequence</i>	<i>Blank</i>	<i>Standard</i>	<i>Test</i>
Glucose reagent	1000 1	1000 1	1000 1
Distilled water	10 1	-	-
Glucose standard	-	10 1	-
Sample	-	-	10 1

1. Contents of all the tubes were mixed well and the tube were incubated at room temperature for 30 minutes
2. After 30 minutes of incubation the absorbance of Standard and Test sample against the Blank at 505 nm was measured.

Calculations of glucose concentration in test sample was performed by following formula

$$\text{Glucose (mg/ml)} = \frac{\text{Absorbance of test}}{\text{Absorbance of sample}} \times 100$$

2.3.3.2 Estimation of reducing sugar by DNSA (Dinitro salicylic acid method)

I. Principle of analytical method

The dinitro salicylic acid test is useful mainly for reducing sugars. 3, 5-Dinitrosalicylic acid is reduced to 3-amino-5-nitrosalicylic acid, and in turn, the aldehyde groups present

in reducing sugars are oxidized to carboxyl groups that develop the orange color. The intensity of the colour developed is proportionate to the concentration of sugar. Rochelle salt addition stabilises developed color.

II. Preparation of DNSA reagent

- 1g NaOH is dissolved in 20 ml water and 1g DNSA added to it and dissolved
- Additional 30 ml water added to dissolve reagent properly
- To this reagent solution, 30g Rochelle salt (sodium potassium tartarate) is added and dissolved by continuous stirring
- Finally volume was made to 100 ml
- The reagent is stored in amber coloured stoppered bottle

III. Procedure

For standard graph preparation, standard glucose solution (1 mg/ml) using A. R. grade glucose was prepared. Additions into clean and dry test tubes were as follows

Glucose standard	0.2ml	0.4ml	0.6ml	0.8ml	1.0ml
Distilled water	0.8ml	0.6ml	0.4ml	0.2ml	-
DNSA reagent	1ml to all tubes				

- For blank 1ml distilled water + 1ml DNSA reagent were mixed together
- All the tubes kept in boiling water bath for 5 minutes, cooled under tap water and 10 ml distilled was added to each tube
- Optical density measured at 540 nm and standard graph of sugar concentration verses optical density was prepared.

To determine sugar concentration from test solution, test solution were diluted to bring the sugar concentration in the range of 2.0 to 2.0 mg/ml and optical density of test solution measured after DNSA reaction as described above. Sugar concentration of the diluted test solution was determined from standard graph and multiplied by dilution factor.

2.3.3.3 Estimation of sugars by HPLC

Concentrations of sugars like glucose, fructose, glycerol and other co-metabolites were determined using HPLC equipped with an Aminex HPX-87H, 300 × 7.8 mm column (Bio-Rad) at 50 °C. Mobile phase used was 0.01 N H₂SO₄ at 0.5 ml/min flow rate. A refractive index detector, Shodex RI-71, was used for detection. IRIS 32 chromatography software was used for the data processing. The quantification was done by external standard technique using peak area of reference compounds. Multiple injections of standard solutions with varying concentrations were done for preparing standard curves of the compounds of interest.

2.3.4 Estimation of intracellular lipids

In the present study, it was observed that *Fusarium fujikuroi* stored intracellular lipids under nitrogen limitation during growth. Therefore to estimate whether the parent/ mutants diverted some amount of glucose to synthesize intracellular lipid under nitrogen limitation, the cellular lipids were extracted and estimated.

Lipids from one gram of freeze-dried cells were extracted with 25 ml of chloroform: methanol (1:2) mixture for 2 h in a Soxhlet extractor. The biomass was separated by centrifugation and re-extracted twice with the same amount of chloroform: methanol mixture. All the three extract was mixed together and 10 ml of 0.9% saline was added to the extract for phase separation, followed by centrifugation at 5000 rpm for 5 min at 10 °C. The upper water and methanol phase was discarded. The bottom chloroform phase was washed twice in a separating funnel with distilled water and stored overnight with anhydrous Na₂SO₄. After filtering out Na₂SO₄, chloroform was removed by evaporating at 50 °C under vacuum. The lipid extracted was weighed and expressed as grams of crude lipids, per gram dry cell mass.

2.3.5 High Performance Liquid Chromatography (HPLC)

2.3.5.1 HPLC Instrument

The High Performance Liquid Chromatography equipment (Thermo Separation Products Fremont, CA, USA) had following configuration.

- Four-channel Solvent degasser SCM 1000,
- Quaternary low pressure gradient pump P4000,
- Rheodyne 7725 manual injector with 20 μ l loop
- UV-Visible Forward Optics Scanning Detector Spectra Focus UV3000,
- Chromatography software PC1000 and Spectacle Ver 3.0.1A.

The spectral scanning detector and the chromatography software has an ability to determine the spectral behaviour of all the peaks in the chromatogram during the elution itself and generates Peak Purity Index.

2.3.5.2 Sample preparation

Fermented broths of the parent and mutant cultures of *Fusarium fujikuroi* were filtered under vacuum through Whatman filter paper Grade-1. The filtrates were centrifuged at 10000 rpm for 10 minutes and supernatants were collected. The supernatants were filtered through 13 mm, 0.2 μ m hydrophilic Durapore membranes (Millipore) using a syringe filtration system. If necessary, samples were diluted in water.

2.3.5.3 Analysis of Gibberellins

In the present study, on the basis of detection of absorption maxima using photodiode array and also by consulting the literature, a modification of the reversed phase HPLC method described by Barnades and Van De Werken (1980) was used for GA₃ and GA₄. HPLC method was standardized for the analysis of two gibberellins GA₃ and GA₄ using an isocratic mode of elution. The developed methods were used for quantification of gibberellins as well. Standard mixture of gibberellin (20 μ l) of each solution was injected into HPLC and detected at a wavelength of 205 nm. Each run was repeated thrice and detector response was measured in terms of peak area. After standardizing the

method of analysis so as to obtain a separate sharp peak for each analyte, the extracted samples were also injected under same conditions of HPLC and response was measured through peak area at a wavelength of 205 nm.

2.3.5.3a Reversed Phase HPLC Analysis of Gibberellic Acid (GA₃)

I. Column

The GA₃ analysis was performed on a reversed phase C₁₈, analytical column-LiChroCART, LiChrospher 100, 125 × 4 mm. The column with particle size 5 μm; pore size 80 Angstrom and 4 × 4 mm C₁₈ guard column was obtained from Merck KGaA, Darmstadt, Germany.

II. Mobile phase

The mobile phase was composed of 20% (v/v) acetonitrile in 5 mmol ammonium dihydrogen phosphate, at pH 2.5 adjusted by H₃PO₄. The mobile phase was filtered through 47 mm, 0.45 μm HVLP PVDF hydrophilic Durapore membrane and used at a flow rate of 0.6 ml/min.

III. Detection

The detection of GA₃ was done at 205 nm.

IV. Standard working solution

For preparation of standard gibberellins A₃, 10 mg GA₃ was dissolved in 20% acetonitrile in water and the volume was made to 25 ml to obtain stock solution of GA₃ containing 400 mg/l. From this stock solution, working standard solutions were made by serial dilution.

V. Quantification

Peak area of standard GA₃ was calculated and average value taken for making the standard graph. The quantification of gibberellic acid was done by external standard method using peak area.

Calculation of response factor was done by following formula

$$\text{Response factor} = \frac{\text{Concentration of GA}_3 \text{ in Standard Solution}}{\text{Area of GA}_3 \text{ Peak in Standard solution}}$$

The quantity of gibberellins (mg/l) present in the fermented broth sample filtrate was calculated using the following formula

$$\text{Concentration of GA}_3 \text{ in sample} = \text{Response Factor} \times \text{Area of GA}_3 \text{ Peak in Sample}$$

VI. Peak Purity determination for GA₃

Analysis of gibberellic acid (GA₃) in fermentation broth was confirmed using an on-line spectral scanning detector during HPLC analysis. On-line spectral analysis of the GA₃ peak was performed for standard and samples for peak purity confirmation using UV3000 scanning detector with PC1000 and Spectacle software. The 3-D spectral scanning was performed between 200 and 350 nm.

2.3.5.3b Reversed Phase HPLC Analysis of Gibberellin₄ (GA₄)

I. Column

The GA₄ analysis was performed using reversed phase C₁₈, 250 × 4 mm analytical column (LiChroCART, LiChrospher 100). The column with particle size 5 μm; pore size 80 Angstrom and 4 × 4 mm C₁₈ guard column was purchased from Merck (Merck KGaA, Darmstadt, Germany).

II. Mobile phase

GA₄ analysis was performed using mobile phase composed of 60% (v/v) acetonitrile and 1% acetone in 5 mmol ammonium dihydrogen phosphate, at pH 2.5 adjusted by H₃PO₄. The mobile phase was filtered through 47 mm, 0.45 μm HVLP PVDF hydrophilic Durapore membrane and used at a flow rate of 1.0 ml/min.

III. Detection

The detection of GA₄ was done at 205 nm.

IV. Standard working solution

For preparation of standard gibberellins A₄, 10 mg GA₄ was dissolved in 60% acetonitrile and 1% acetone in water and diluted to 10 ml, to obtain stock solution of GA₄ containing 1 g/l. From this stock solution, working standard solutions were made by serial dilution. The quantification of GA₄ was done by external standard method using peak area as described above in **2.3.5.3a**.

Like gibberellic acid (GA₃), analysis of GA₄ in fermentation broth was confirmed using an on-line spectral scanning detector during HPLC analysis.

2.3.5.4 Reversed Phase HPLC Analysis of Fusaric acid

Fusaric acid was analysed by a modification of the reversed phase HPLC method described by Amalfitano *et al.*, (2002).

I. Column

Fusaric acid analysis was done using reversed phase C₁₈, 125 x 4 mm analytical column-LiChroCART, LiChrospher 100. A chromatography column with particle size 5 μm; pore size 80 angstrom and 4 x 4 mm C₁₈ guard column was purchased from Merck KGaA, Darmstadt, Germany.

II. Mobile phase

The mobile phase contained 47.5% methanol in 5 mmol dipotassium dihydrogen phosphate, at pH 7.4. The flow rate of the mobile phase used was 0.6 ml/min.

III. Detection

The detection of fusaric acid was carried at 268 nm. Standard fusaric acid solutions of 2 and 10 mg/l were used for calibration. The quantification was done by external standard method using peak area as described above in **2.2.5.3a**.

2.3.5.5 Reversed Phase HPLC Analysis of Moniliformin

Moniliformin was analyzed according the method described by J. Fotso *et al.*, (2002).

I. Column

Moniliformin analysis was performed using reversed phase C₁₈ 125 x 4 mm analytical column-LiChroCART, LiChrospher 100. The column with particle size 5 μm, pore size 80 angstrom and 4 x 4 mm C₁₈ guard column was purchased from Merck (Merck KGaA, Darmstadt, Germany).

II. Mobile phase

Mobile phase was composed of 60 % acetonitrile. Flow rate used was 1 ml/min.

III. Detection

The detection of moniliformin was carried at 229 nm. On-line spectral scans for the fusaric acid and moniliformin were performed during HPLC analysis for determination of peak purity. The spectral pattern determination for the standard fusaric acid and moniliformin was performed using the detector and software as described in **2.2.5.3a**. Similarly, spectral scan of the peaks in chromatograms of samples having elution time close to the standard fusaric acid and moniliformin peaks were performed.

2.3.6 Melting point analysis of extracted and purified Gibberellin A₃

Melting point of the GA₃ extracted and purified from the fermented broth was analyzed. Analysis was performed using BUCHI melting point apparatus B-540 (Flawil, Switzerland). Temperature range used was between 200-250 °C with gradient increase of 5°C/min.

2.3.7 Nuclear Magnetic Resonance (NMR)

Structural confirmation of purified gibberellic acid (GA₃) was performed by nuclear magnetic resonance (NMR) spectrometer. ¹H NMR spectra were recorded in deuteriochloroform on a Bruker AV 500MHz NMR spectrometer, Switzerland.

2.3.8 Liquid Chromatography with Mass Spectrophotometer (LC-MS)

Identification of purified GA₃ and production of GA₄ in fermentation broth was confirmed by LC-MS technique. LC-MS analysis was performed using Waters Alliance 2695 separation module. It was done by comparison with mass spectra of authentic GA₃ and GA₄ standard from Sigma Chemical Company, USA.

In case of GA₄, standard and sample were spiked with sodium ion to produce adducts rather than a protonated species like GA₃. Sodium added ions, were detected as base peaks, and the molecular masses of the GA₄ were determined by comparing [M + Na]⁺ ions.

The column used for LC-MS was same to that of analytical HPLC. Mobile phase used for GA₃ was 20% acetonitrile, 0.1% formic and 1% acetone, at a flow rate of 0.6 ml/min. While mobile phase for analysis of GA₄ was composed of 60% acetonitrile with 0.1% formic and 1% acetone, and used at a flow rate of 1.0 ml/min. Standard GA₃ and GA₄ were injected as reference compounds at a concentration of 1 mg/ml for comparison.

LC-MS analysis of GA₃ and GA₄ was performed under following conditions:

- Source temperature 150 °C
- Desolvation temperature 350 °C
- Polarity ES negative for GA₃ and ES positive for GA₄
- Energy 10 V
- Capillary voltage 3.50 kV

2.4 REFERENCES

- Amalfitano, C., Pengue, R., Andolfi, A., Vurro, M., Zonno, M.C., Evidente, A. 2002. HPLC analysis of fusaric acid, 9,10-dehydrofusaric acid and their methyl esters, toxic metabolites from weed pathogenic *Fusarium* species. *Phytochemical Analysis*, **13**, 277-282.
- Barendse, G.W.M., Van DeWerken, P.H., 1980. High performance liquid chromatography of gibberellins. *Journal of Chromatography*, **198**, 449-455.
- Fotso, J., Leslie J. F., Smith, J. S. 2002. Production of Beauvericin, Moniliformin, Fusaproliferin and Fumonisin B1, B2, and B3 by Fifteen Ex-Type Strains of *Fusarium* Species. *Applied and Environmental Microbiology*, **68**, 5195-5197.
- Miller, G.L. 1959. Use of dinitrosalicylic acid reagent for determination of reducing sugar. *Analytical Chemistry*, **33**, 426-428.

Chapter 3

***Fusarium fujikuroi* Cultivation in Shake Flask**

Abstract:

Five *Fusarium* sp. were obtained from National Collection of Industrial Microorganisms (NCIM), CSIR-National Chemical Laboratory, Pune and maintained on potato dextrose agar slants. The cultures were inoculated in liquid medium for fermentation (LMF) in 250 ml Erlenmeyer flasks and cultivated for seven days for production of gibberellins. A selected strain, *F. fujikuroi* NCIM 1019, was subjected to mutagenesis for enhanced production of gibberellic acid. Several mutagenesis rounds were performed using intermittent mutants as parents for the next round. In all more than one thousand colonies were selected and cultivated for gibberellin production in test tubes and in Erlenmeyer flasks. Attempts of intergeneric protoplast fusion between *F. fujikuroi* and *Trichosporon cutaneum* and yielded a new culture that produced gibberellic acid and still had yeast-like morphology. A mutant, Mut189 was selected because of its short filament length, low viscosity in liquid fermentation medium and higher gibberellic acid production. Mutant Mut189 was a stable mutant and produced around 400 mg/l gibberellic acid under similar cultivation conditions.

Flow Sheet of Work

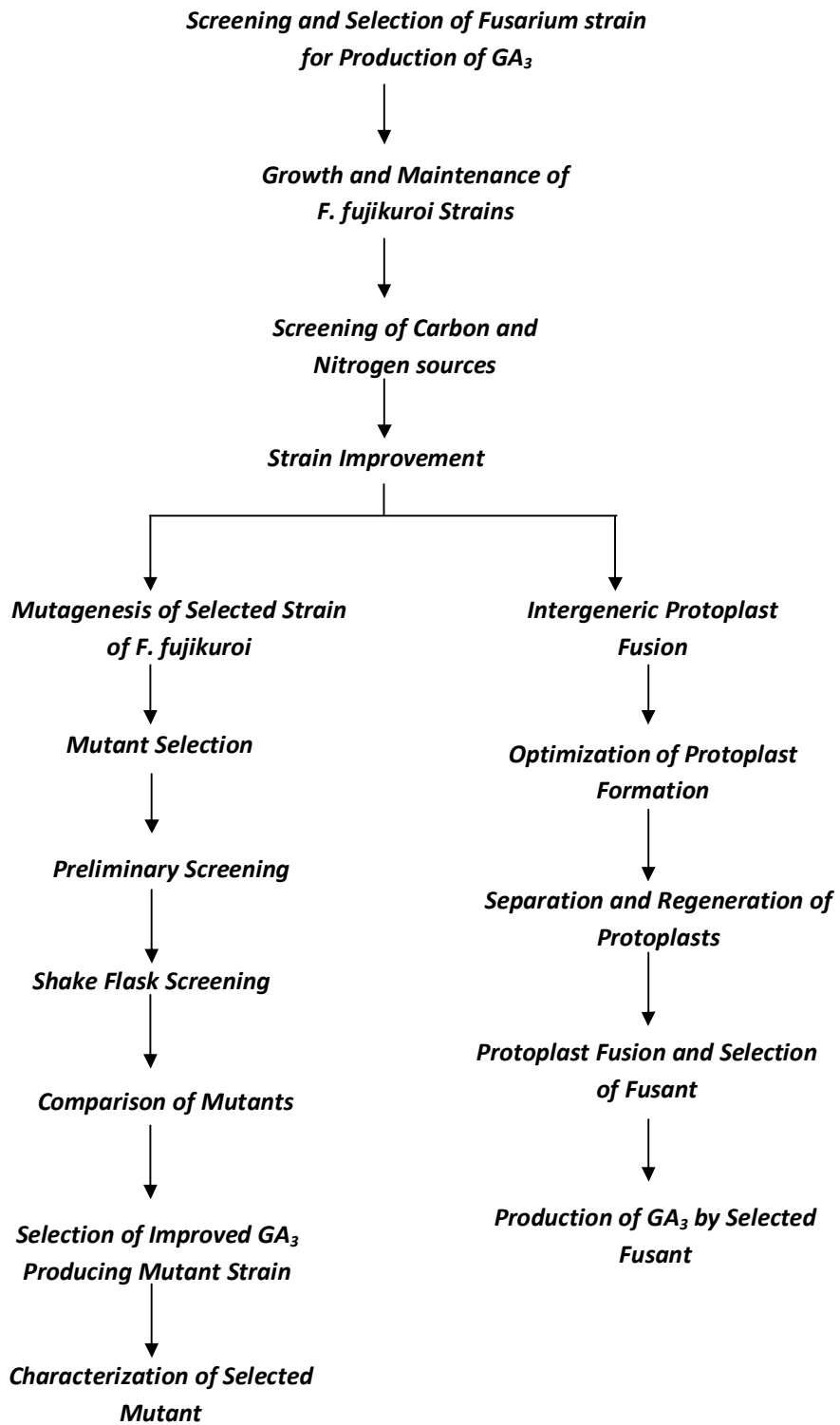

3.1 INTRODUCTION

The power of the microbial culture in the competitive world of commercial synthesis can be appreciated by the fact that not only structurally complicated bio-molecules but even simple molecules are currently made by fermentation more economically rather than by chemical synthesis. Although the chemical synthesis and technologies have evolved rapidly in the last few decades, many natural products are still so complex that they probably will never be made commercially by chemical synthesis.

Microbial metabolites can be largely grouped into primary and secondary metabolites. Microbial strains isolated from the nature normally produce tiny amounts of secondary metabolites. Although secondary metabolites are not essential for microbial growth, they are very important for the health, and nutrition of human and animals and therefore for sound economics of our societies (Berdy, 2005). The secondary metabolites are not essential for the growth of the producing cultures but the microbial cultures need small amounts of these compounds for their own competitive benefit (survival) in nature. The secondary metabolites are complex molecules synthesized through series of complex energy consuming steps and therefore the wild cultures do not overproduce these metabolites (Demain and Fang, 2000). Regulatory mechanisms have evolved in microorganisms that enable a strain to avoid excessive production of its metabolites. Thus, strain improvement programs are absolutely required for commercially viable production of very useful secondary metabolites. The strain improvement programmes normally initiate with an aim of isolating cultures from nature, exhibiting desired phenotypes (Adrio and Demain, 2006).

Commonly, the ability of a microbial strain to produce higher concentrations of a compound of interest is what is desired, although the spectrum of improvements can also include other traits. Several procedures are employed to improve microbial strains and all of them bring about changes in DNA sequence. These changes are achieved by mutation, genetic recombination, or the modern DNA splicing techniques of genetic engineering. The ease with which permanent characteristics of microorganisms could be changed by mutation and the simplicity of the mutation techniques had tremendous appeal to microbiologists. The substantial increases in fermentation productivity and the resulting decreases in costs have come about

mainly by mutagenesis and screening for higher producing microbial strains (Demain and Adrio, 2008).

Mutation has been the major factor involved in the hundred to thousand-fold increased production of microbial metabolites. It has the ability to modify genetically a microbial culture to higher productivity, the most important factor in keeping the fermentation industry in its viable, healthy state (Vinci and Byng, 1999; Parekh *et al.*, 2000). It has also been used to shift the proportion of metabolites produced in a fermentation broth to a more favourable distribution, elucidate the pathways of secondary metabolism, yield new compounds, and for other functions. Classical strain development has typically relied on mutation and systematic screening of improved strains. Application of strain improvement to new fermentation processes continued to be documented in the literature despite the age of the technology. Strain improvement has been the main factor involved in the achievement of impressive titers of industrial metabolites. *Penicillium chrysogenum* X-1612 was the first superior penicillin producing mutant, isolated after X-ray mutagenesis. This was the beginning of a successful relationship between mutational genetics and industrial microbiology (Hersbach *et al.*, 1984). Through strain improvement program the production of tetracycline was reported to be increased over 20 g/l (Podojil *et al.*, 1984) while production of penicillin 70 g/l and that of cephalosporin C over 30 g/l (Elander, 2003).

The most common method used to obtain high yielding mutants is to treat cells of a desired culture with a mutagenic agent until a desired kill rate is obtained, plate out the survivors on suitable, preferably selective media and test each resulting colony or a randomly selected group of colonies for product formation in shake flasks. The most functional mutagens comprise *N*-methyl *N*-nitro *N*-nitroso guanidine (NTG), methyl methane sulfonate (MMS), ethyl methyl sulphonate (EMS), hydroxylamine (HA) and ultraviolet light (UV) (Adrio and Demain, 2006; Parekh *et al.*, 2000). Overall yield improvement has depended mainly on mutation and selection, combined with optimization of fermentation conditions.

Strain improvement may also be possible by the introduction of extra copies of genes of which the products are rate-limiting, or of genes conferring beneficial growth characteristics. Protoplasts are widely used for making genetically modified

organisms, since the cell wall would otherwise block the passage of DNA into the cell. The use of protoplast fusion has been reported to improve a wide range of industrial strains of bacteria and fungi including *Streptomyces*, *Nocardia*, *Penicillium*, *Aspergillus*, and *Saccharomyces*. This technique is frequently employed in the brewing industry for improving yield and incorporating traits are not easily achievable through simple mutation (Parekh, 2009).

In recent years, frequencies of recombination have increased and strain improvement programs now routinely include protoplast fusion between different mutant lines (Demain and Adrio, 2008). Although a considerable number of reports have appeared on the fusion of protoplasts of industrially useful microorganisms such as yeasts, filamentous fungi and bacteria, with regards to *F. fujikuroi*, intergeneric protoplast fusion has not been reported. Current literature did not reveal any use of protoplast fusion techniques to improve GA₃ production by *F. fujikuroi*.

F. fujikuroi is a mesophilic fungus with septate, branched mycelial morphology. The strains belonging to mating type -C \emptyset produce less conidia and are prolific producers of gibberellins (Giordano *et al.*, 1999; Tudzynski *et al.*, 2005). Production of gibberellins by *F. fujikuroi* involves a long biochemical pathway and is a result of multi-gene activity; therefore the conventional mutagenesis is a preferred method for strain improvement in order to obtain enhanced gibberellins (GA₃) producing mutants. It is a common observation that *F. fujikuroi* grows in viscous, filamentous form in liquid medium and the broth behaves in non-Newtonian manner. To increase the gibberellin productivity, it is necessary to increase the cell mass in the fermentation broth and in doing so; the culture broth becomes extremely viscous. This adversely affects the mixing and oxygen transfer rate. Viscosity of the culture broth and low solubility of oxygen in aqueous broth often leads to dissolved oxygen limitation during fermentation. Availability of dissolved oxygen governs the concentrations and ratio of secondary metabolites produced by *F. fujikuroi* during fermentation (Giordano and Domenech, 1999). Any change in morphology of the fungal strain that lowers the viscosity can result in improved oxygen transfer and in turn, increase the GA₃ production as they are oxidation products. Morphological mutants affected in mycelia formation, which produce colonies with a modified

appearance or new colours were found to be useful in strain improvement (Adrio and Demain, 2006).

F. fujikuroi produces two types of pigments, the polyketide bikaverin (Kajer *et al.*, 1971) and the carotenoid neurosporaxanthin (Avalos and Cerda-Olmedo, 1987). Earlier, Candau *et al.*, (1991) investigated mutants of *F. fujikuroi* for pigment accumulation. They had studied strain improvement of *F. fujikuroi* by screening of mutants with blocked carotenoid biosynthesis and reported that mutant strains with lower levels of neurosporaxanthin can produce more gibberellins. A decrease in production of pigments like bikaverin and carotenoids by *F. fujikuroi* is likely to be beneficial for production of gibberellins because of the increased carbon flow through the gibberellin pathway as well as requirement of lesser steps during extraction and purification of the gibberellins from fermented broth. Thus, in addition to improvement in gibberellin producing capabilities, undesirable properties, especially growth characteristic exhibiting viscosity to broth, undesirable other secondary metabolite formation can be eliminated by classical mutagenesis.

Interestingly, the compositions of fermentation products of *F. fujikuroi* also depend on the nature, composition and concentration of media constituents as well. The effect of a variety of carbon and nitrogen sources in nutrient medium on gibberellic acid (GA₃) production has been investigated by Gohlwar *et al.*, (1984). All reported media yielding high amount of GA₃ contained low concentrations of nitrogen content. It is also reported that complex nutrients like peanut meal, soya meal and corn steep liquor positively affected GA₃ biosynthesis (Sanchez-Marroquin, 1963; Fuska *et al.*, 1961; Podojil and Ricicoca, 1964). GA₃ production in complex media containing glucose as carbon source has been well documented. However, gibberellins biosynthesis was indicated to be suppressed by high amount of glucose (Borrow *et al.*, 1964). There are a few reports available on GA₃ production with alternative carbon sources like sucrose, slowly utilisable carbon sources like starch, combination of fast and slowly utilisable carbon sources (Gonzalez *et al.*, 1994) and also some oils such as sunflower oil, cooking oil, rapeseed oil (Gancheva *et al.*, 1984).

An extensive search was carried out for the medium constituents for GA₃ production by fermentation and it was found high C: N ratio is essential parameter for its

production. Nitrogen limitation is the prerequisite for GA₃ formation because GA₃ production starts towards the end of the growth phase with the exhaustion of nitrogen source from the medium. Based on literature survey, a liquid fermentation medium was constituted to screen the cultures for GA₃ production.

Overall successful improvement in gibberellic acid production depends upon genetic makeup of the strain, along with physiological, nutritional and cultural parameters employed during fermentation as summarized below.

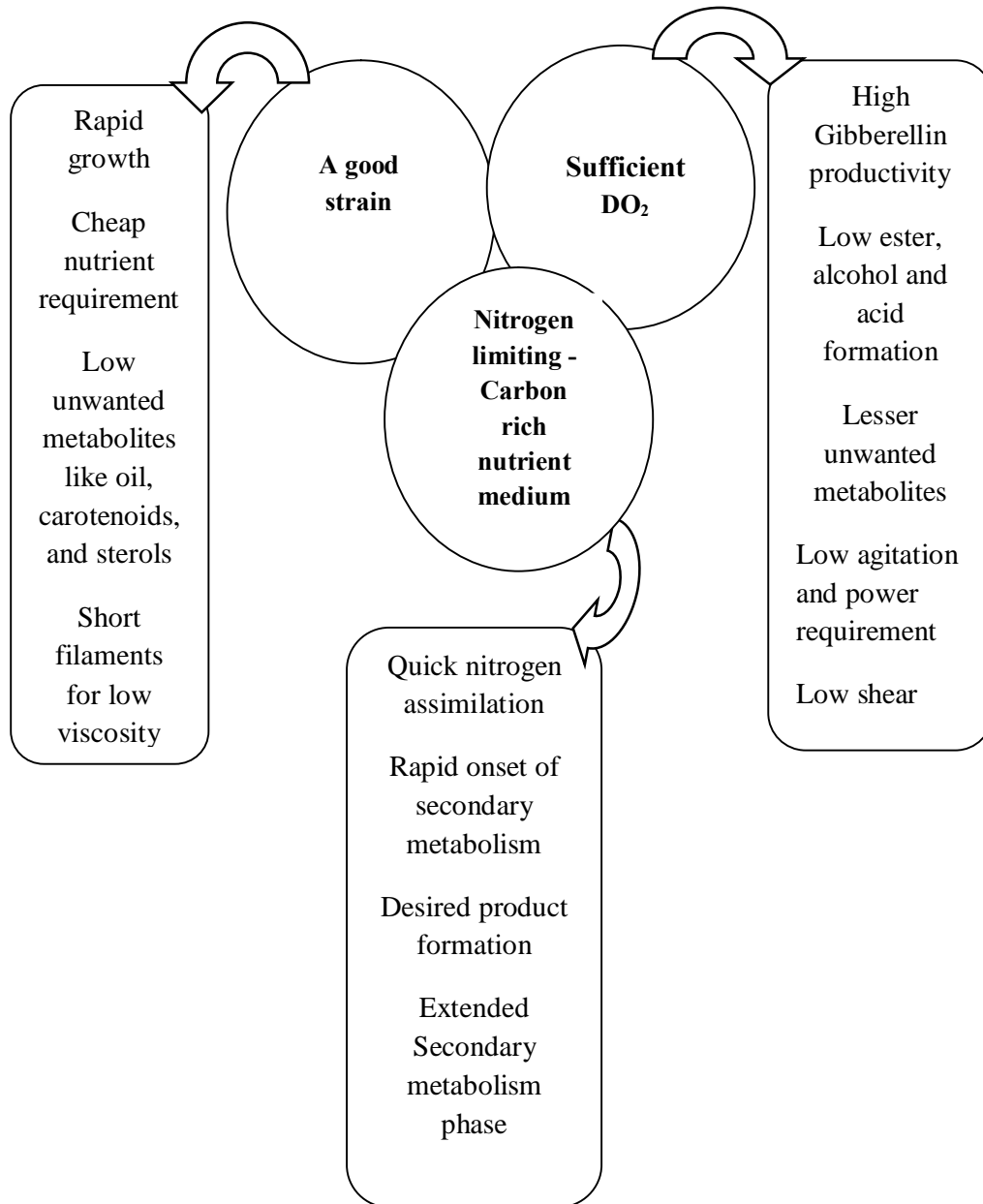

The objective of the present section of work was 1) selection of wild strains of *Fusarium fujikuroi* obtained from National collection of Industrial microorganism, NCL, Pune for their ability to produce GA₃, 2) to enhance GA₃ production and minimize unwanted by-products of *F. fujikuroi* by classical mutagenesis and 3) through primary and secondary screening study selection of morphologically altered mutant with enhanced GA₃ production.

3.2 MATERIALS AND METHODS

3.2.1 Microorganisms

Five fungal strains namely *F. fujikuroi* NCIM 665, *F. fujikuroi* NCIM 850, *F. fujikuroi* NCIM 1035, *F. fujikuroi* NCIM 892, *F. fujikuroi* NCIM 1019 were obtained from National Collection of Industrial Microorganism (NCIM), CSIR-National Chemical Laboratory, Pune, India. These cultures were grown on Potato Dextrose Agar plates by spread plate technique using dilute suspensions and pure colonies were transferred to potato dextrose agar (PDA) slants (HiMedia Mumbai, India) supplemented with 2 g/l yeast extract for maintenance. The mutants generated during experiments of strain improvement were also maintained on PDA agar slants. For long-term storage of the selected mutants, soil culture and glycerol stocks were prepared and maintained at 4 °C and -80 °C, respectively. Agar slopes were incubated at 28 °C for 364 days and stored at 4 °C. The regeneration agar (RA) was used for growth of the survivors after mutagenesis.

3.2.2 Chemicals

Ethyl methyl sulphonate (EMS), analytical grade sugars, Enzyme Novozyme 234, Polyethylene glycol (PEG, MW 3500) and gibberellins (GA₃ and GA₄) were purchased from Sigma-Aldrich, USA. All media ingredients and nystatin were purchased from HiMedia, Mumbai, India. Defatted soyabean meal and defatted cottonseed meal was from Chandrasekhar Exports Pvt. Ltd. (Kolhapur, India) while defatted peanut meal was from local cattle feed. Cane sugar was purchased from local sources. Pravastatin and Lovastatin were kind gifts from Lupin Pharmaceuticals Ltd. Mumbai, India.

3.2.3 Media Compositions

Media compositions used in the experiments were as follows

1) Potato Dextrose Agar (PDA)

Ingredient	Conc. g/l
Potato infusion	200
Yeast Extract	2
Dextrose	20
Agar	15

2) Liquid Medium for Growth (LMG)

Ingredient	g/l
KH ₂ PO ₄	1.5
NaCl	0.5
MgSO ₄ .7H ₂ O	0.2
Na ₂ MoO ₄ .2H ₂ O	0.05
Yeast extract	0.3
Glucose	30.0
Defatted peanut Meal	9.0
Trace mineral solution*	1 ml
pH	6.8 before autoclaving

3) Regeneration Agar (RA)

Ingredient	g/l
KH ₂ PO ₄	1.5
NaCl	0.5
MgSO ₄ .7H ₂ O	0.2
Na ₂ MoO ₄ .2H ₂ O	0.05
Yeast extract	0.3
Glucose	30.0
Soyapeptone	3.0
Bile salt	1.0
Trace mineral solution	1 ml

Agar	20.0
pH	6.8 before autoclaving

4) Liquid Medium for Fermentation (LMF)

Ingredient	g/l
KH ₂ PO ₄	1.5
NaCl	0.5
MgSO ₄ .7H ₂ O	0.2
Na ₂ MoO ₄ .2H ₂ O	0.05
Glucose	30.0
Ammonium nitrate	3.0
Trace mineral solution*	1 ml
pH	6.8 before autoclaving

5) Malt Extract Glucose Yeast extract Peptone agar (MGYP)

Ingredient	g/l
Malt Extract	3.0
Glucose	10.0
Yeast extract	3.0
Peptone	5.0
Agar	2.0
pH	7.0 before autoclaving

6) Trace Mineral Solution*

Ingredient	g/l
CaCl ₂ . 7H ₂ O	1.0
MnCl ₂ . 7H ₂ O	0.1
CuCl ₂ . 7H ₂ O	0.05
FeCl ₂	0.1
H ₃ BO ₃	0.1
ZnSO ₄	0.1

The ingredients were dissolved in distilled water and a few drops of concentrated HCl were added till solution became clear.

3.2.4 Growth in Tube Culture

Small pieces of respective young cultures from PDA slants were suspended in 0.5 ml sterile physiological saline, mycelium was teased with sterile thick wire instead of a loop and the suspension was transferred to 5 ml liquid medium in 150 × 25 mm test tubes without rim and the tubes were incubated at 28 °C, 220 rpm, for 48 h.

3.2.5 Growth in Shake flasks

In case of shake flask cultures, the medium volume used was 45 ml in 250 ml Erlenmeyer flasks throughout the experiments and 5 ml inoculum was used to make the final volume 50 ml at the beginning of the experiments unless otherwise stated. All flask experiments were performed in duplicate, for 168 h, unless otherwise mentioned. At the end of the incubation period, final volume of the culture broth was adjusted to 50 ml by sterile distilled water to compensate for evaporative loss of water. Care was taken that the shake flask cultures do not remain stationary even for few minutes during sample withdrawal from the flasks.

Whenever other carbon sources were to be used, in place of glucose, they were used at 60 g/l and alternative nitrogen sources were used on equal nitrogen basis. Carbon sources were autoclaved separately for all the experiments and later mixed with other media components.

3.2.6 Screening of strains for GA₃ production

In an effort to select a suitable strain of the fungus for production of gibberellic acid, the cultures obtained from NCIM were screened for GA₃ production by inoculating them in 250 ml Erlenmeyer flasks with 50 ml LMF and incubating the flasks at 28 °C, 220 rpm for 168 h. During incubation samples were withdrawn aseptically at regular interval and analyzed for dry cell weight (DCW), pH, residual sugars and GA₃ concentration by high performance liquid chromatography (HPLC). The culture broth was filtered over qualitative filter paper circle under vacuum and the filtrate was used for analysis of residual sugar and gibberellic acid. The cell mass residue was washed with three volumes of distilled water to remove adhering soluble compounds from the medium and observed for conidia, cell and filament morphology, oil storage vacuoles and pigmentation. The parent strain were studied in

shake flask cultures for 1) repeated production of more GA₃, 2) relatively less production of soluble as well as cell bound pigments 3) relatively few micro-conidia and macro-conidia and 4) and short mycelial length measured using a microscope and stage micrometer so that it would have lower viscosity in fermentation broth.

3.2.7 Choice of carbon source

Utilization of carbon sources namely glucose, sucrose and fructose was investigated for growth and GA₃ production by *F. fujikuroi* NCIM 1019. The carbon sources (60 g/l) were autoclaved separately and later added to remaining constituents of LMF. Flasks were inoculated with respective seed cultures and incubated at 28 °C, 220 rpm. Samples were analysed after 168 h as described earlier.

3.2.8 Screening of nitrogen sources for selected GA₃ producing cultures

The shake flask experiments were done to evaluate the nitrogen sources for GA₃ production by *F. fujikuroi* NCIM 1019. The effect of nitrogen source was studied in LMF with different inorganic and organic nitrogen sources added at concentration equivalent to 0.7 g/l δ Nö. The nitrogen sources were used on equal δ Nö basis. Respective cultures were inoculated in 250 ml Erlenmeyer flasks with 45 ml medium and incubating at 28 °C, 220 rpm for 168 h. Samples were analyzed for dry cell weight, pH, and residual glucose and GA₃ concentration.

3.2.9 Mutagenesis of selected strain

The parent strain *F. fujikuroi* (NCIM 1019) that was found to qualify most of the conditions laid down for strain selection (described in 3.2.6 above), was grown in 50 ml liquid medium (LMG) for growth, at 220 rpm and 28 °C for 72 h. The selected strain of the *F. fujikuroi* grows in a viscous mycelial form and produces very less or no conidia in plate cultures or submerged cultures. For mutagenesis it is necessary to have individual cells as colony forming units (CFU). The mycelial culture was filtered over sterile sintered glass funnel G-0, (Borosil, Mumbai, India) to get short fragments in the filtrate and then the filtrate was further filtered through sterile absorbent cotton layer of 1 cm thickness to get short fragments or individual cells for experiments with mutagenesis. The suspension of individual cells or of 1-2 cell fragments was collected and used for mutagenesis programme.

Three different approaches were employed for mutagenesis. Survival curves were drawn from the number of surviving cells with respect to time for each of the mutagen used and optimum time and concentrations were determined for the respective mutagens in order to get 90-95 % kill rate.

(1) UV irradiation: A small mechanical device fabricated using aluminum sheets with a UV lamp inside was used. This device allowed accurate exposure time of UV radiation without switching the UV lamp ON and OFF. Cells or Fragments were counted under a microscope using Neubauer improved cell counting chamber (Marienfeld Germany). The cell number was adjusted to 1×10^5 cells/ml either by centrifugation followed by suspension in desired volume of sterile physiological saline or by dilution with sterile physiological saline. Twenty microlitre of this suspension were spread inoculated on regeneration agar plates. The plates were exposed to germicidal Ultra Violet (UV) radiation (Sankyo Denki Co. Ltd., Japan) for 0 to 15 seconds at a distance of 20 cm. The exposure time was controlled by changing the shutter position in the UV exposure device described above. The schematic representation of UV exposure chamber is given in Fig. 3.1.

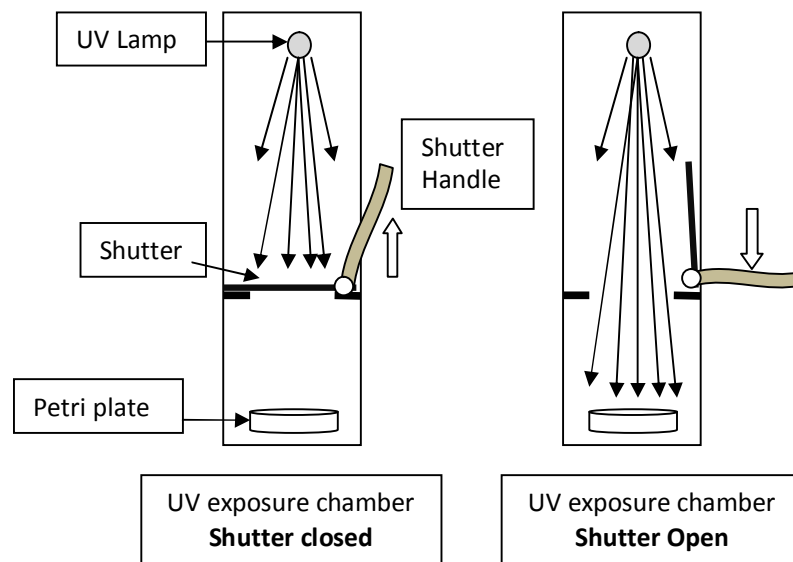

Figure 3.1 Schematic representation of UV exposure chamber

(2) Ethyl Methyl Sulphonate (EMS) treatment: To 1 ml suspension of the cells/fragments (1×10^5 cells/ml), 20 μ l EMS was added, mixed thoroughly, and exposed

for different time intervals from 0 to 60 minutes. At fixed time interval, 0.5 ml of the treated cell suspension was withdrawn aseptically and transferred to 0.5 ml filter sterilized sodium thiosulfate solution (5%) to inactivate EMS.

(3) Combination of UV and EMS treatment: This treatment was carried out by irradiation of the cell suspension with UV for 5 seconds followed by the EMS treatment for 30 minutes as described above.

Mutagenesis programme was initiated with UV and the surviving colonies were screened for morphological variations and less pigmentation. Subsequently, UV mutagenesis was coupled to chemical mutagenesis. The sequence of mutagenesis procedures used in this study was UV EMS UV + EMS.

To exert higher selection pressure for selecting mutants, in some of the mutagenesis series, regeneration agar (RA) plates were incorporated with 250 mg/l Pravastatin or Lovastatin. Pravastatin inhibits synthesis of sterols and other secondary metabolites because it is a specific inhibitor of Hydroxy Methyl Glutaryl CoA (HMG-CoA) reductase. In some of the mutagenesis series, plates were incorporated with 4000 U/100 ml concentration Nystatin (polyene antibiotic) or Diphenylamine 25 mg/100 ml (an electron transport decoupler). Nystatin was dissolved in HPLC grade ethanol and then added to the molten agar before pouring the plates. The regeneration agar plates were incubated at 28 °C, for 5-6 days in dark, till colonies developed.

3.2.10 Mutant selection

After incubation of plates with treated cells at 28 °C for five to six days, the plates, which showed 5-10 % of survival, were selected. Colonies with different growth characteristics, appearance and pigmentation were marked, recorded, picked up and transferred to PDA agar slants for maintenance. Morphological observations of the colonies on plates and growth on slants were performed with respect to shape, size, pigmentation, surface appearance, roughness, margins and thickness.

3.2.10.1 Screening of the selected mutants in tubes

The preliminary screening was done in test tube cultures. For this, a small piece of the mycelium from freshly prepared slant was teased in sterile physiological saline as

described earlier and inoculated in 4.5 ml liquid medium for fermentation (LMF) in 25 X 150 mm test tubes. Cultures were incubated at 220 rpm 28 °C on rotary shaker for 5 days. The liquid cultures were observed microscopically for mycelium length and cell thickness. The mycelium was filtered using Whatman Grade 1 filter paper and filtrates were analyzed for pH, residual sugar and GA₃ concentration.

3.2.10.2 Shake flask screening of selected mutants for GA₃ production

The mutants that showed 15-20% more gibberellic acid production in preliminarily screening than their respective parent were studied in shake flask experiments. Five ml 48 h grown seed cultures in test tube were transferred to 45 ml LMF in 250 ml Erlenmeyer flasks and incubated for 5 days at 220 rpm 28 °C on rotary shaker as described in 3.2.4.2 above. The liquid cultures were observed microscopically for mycelial length and thickness. The apparent viscosity in shake flask cultures was noted in terms of "high medium and low". Samples were analyzed for dry cell weight (DCW), pH, residual glucose and GA₃ concentration. The mutants with enhanced GA₃ production were used as intermediate parent strains for mutagenesis for further desired strain improvement. Mutants which showed higher glucose utilization, enhanced GA₃ production, low or no pigmentation and morphological change that will suit the fermentation broth rheology, compared to parent, were selected. Intermediate mutants were also screened for enhanced GA₃ production by optimizing key medium components (carbon and nitrogen sources and their concentration) and the process parameters in shake flask.

3.2.10.3 Comparison of selected mutants

Viscosity of the fermentation broth is a major issue in all fungal fermentation because of the mycelial nature of the organism. The selection of the mutants in the present investigation was dependent upon growth characteristics and lower viscosity of the liquid cultures in shake flasks. Medium volume and strength of medium in Erlenmeyer flasks exerts effect on metabolism because of differences in the oxygen transfer rates and the dissolved oxygen levels in the fermenting mass. To investigate this, in one experiment, the medium volumes in 250 ml Erlenmeyer flasks were varied to have 15, 30, 45 and 60 ml LMF.

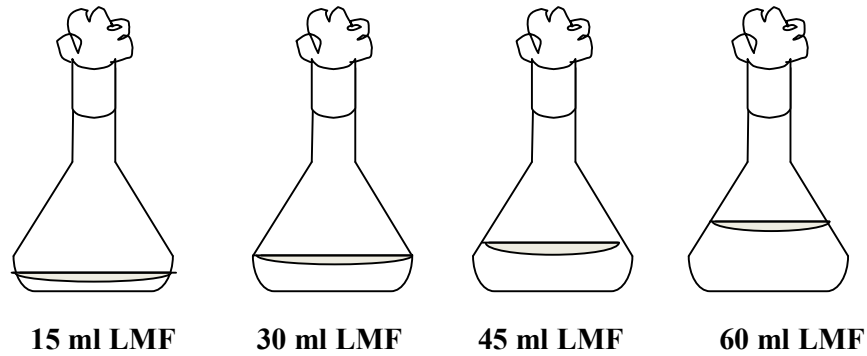

Figure 3.2 Shake flasks with different medium volumes

In another set of experiment, the concentrations of the ingredients in the medium were increased from 1 fold to 1.25, 1.5 and 1.75 fold keeping volume constant as shown in Fig. 3.2 below. These Erlenmeyer flasks with different medium volumes or medium strengths were inoculated with 48 h old 10% (v/v) inoculum of four selected mutant strains (with approximately 18 g/l dry cell mass).

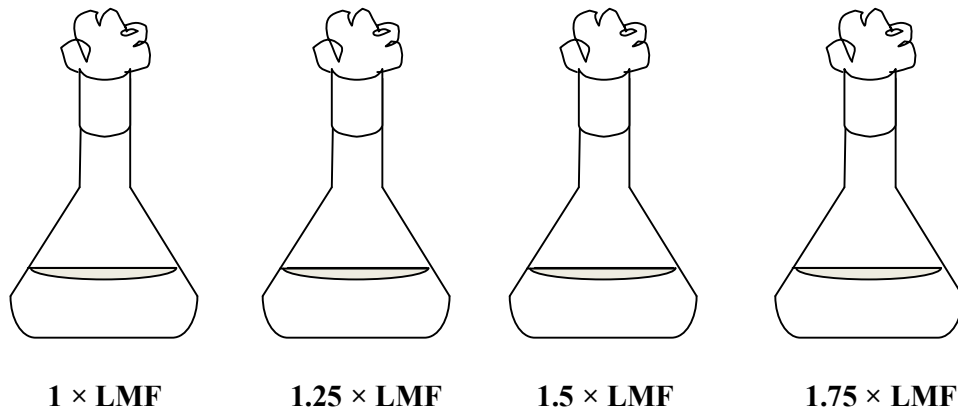

Figure 3.3 Shake Flask with increased medium strength

All the experiments were performed in triplicates. The flasks were incubated on rotary shaker at 220 rpm 28 °C, for 5 days. The volumes of the cultures were corrected with distilled water. Samples were analysed for dry cell mass, pH, residual sugar and gibberellic acid concentration using HPLC as described earlier.

3.2.11 Characterization of selected mutant Mut189 of *F. fujikuroi*

3.2.11.1 Morphology

Mutant strain, Mut189 that showed improved gibberellic acid production in the screening studies was selected for optimization of fermentation medium and process parameters. Morphological and biochemical variations of the mutant compared to its parent were studied. Morphological variations of the mutant Mut189, compared to its parent *F. fujikuroi* NCIM1019 were examined by phase contrast and scanning electron microscopy (SEM) as detailed below.

Respective cultures were grown in fermentation medium for 48 h and washed twice with sterile physiological saline. Appropriately diluted cell suspensions were visualized under phase contrast microscope. For studies using SEM, a small sample was applied on the Polydimethylsiloxane (PDMS) and dried under vacuum at room temperature for 30 min and visualized under Scanning electron microscopy (Quanta 200 3D, FEI). Multiple images were obtained. Optical images were taken with Nikon Eclipse, E600-POL (Japan).

3.2.11.2 Carbohydrate utilization

Carbohydrate utilization pattern of *F. fujikuroi* NCIM1019 and its mutant Mut189 was studied using various sugars such as arabinose, cellobiose, fructose, galactose, glucose, glycerol, maltose, mannose, raffinose, rhamnose, sucrose, and xylose. A small piece of the mycelium from freshly prepared slant was spot inoculated on the agar plates of media containing 25 g l⁻¹ of each of the above mentioned sugars. Plates were incubated at 28 °C and observed for growth. The growth on different sugars was compared with respect to colony size, shape, surface appearance, roughness, margins and pigmentation.

3.2.12 Protoplast fusion

Genetic manipulation in filamentous fungi can be successfully achieved through fusion of protoplast. Interspecific, intraspecific and intergeneric hybridation could be

done by this technique and strain improvement of industrial fungal strains is possible (Lalithakumari, 2000).

Intergeneric fusion of protoplasts is a means of acquiring desirable strain characteristic from other species. The present study was aimed to optimize the conditions for the isolation of viable protoplasts and to attempt intergeneric protoplast fusion between the selected mutant of *F. fujikuroi* and a yeast culture *Trichosporon cutaneum* (NCIM 3352) to obtain a yeast-like fusant producing GA₃.

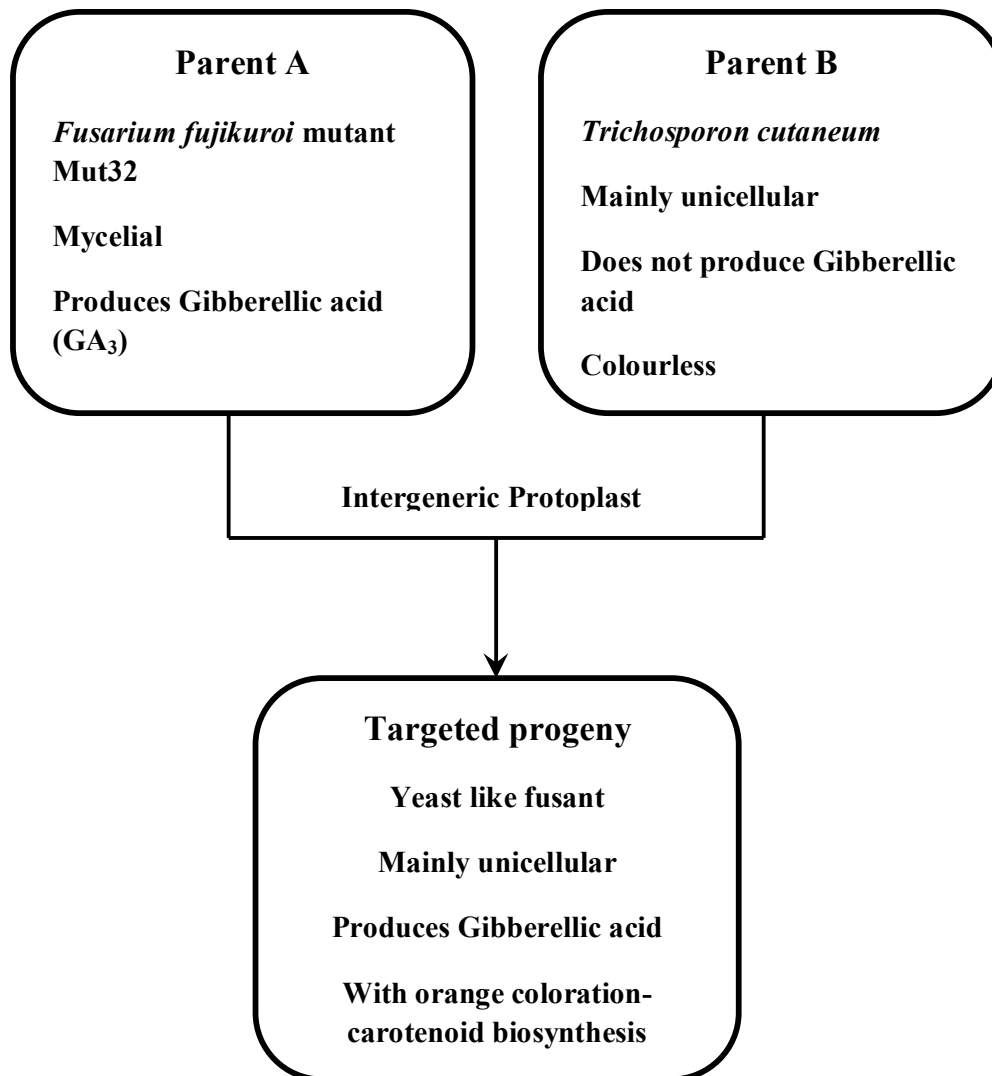

Figure 3.4 Scheme of fusion for transference of genes for GA₃ production from fungi into the yeast culture

3.2.12.1 Microorganisms

Intergenic protoplast fusion was attempted between the selected mutant of *F. fujikuroi* and a yeast culture. Mut32, a mutant strain of *F. fujikuroi* selected for protoplast fusion was producer of carotenoid pigment and GA₃. The yeast, *Trichosporon cutaneum* (NCIM 3352) was selected on the basis of non-fermenting, non pigmented and non-pseudo mycelium formation. The strains were maintained on PDA agar slants.

3.2.12.2 Optimization of protoplast formation

Protoplasts were prepared using commercial lysing enzyme (Novozyme 234, Sigma). To achieve maximum protoplast formation, age of the cultures, concentration of lysing enzyme and osmotic stabilizer were optimized as described below.

To optimize conditions for protoplasts formation preparation of fungal mycelium and yeast cells was performed. The Mut32, mutant strain of *F. fujikuroi* and *Trichosporon cutaneum* (NCIM 3352) were grown in 250 ml Erlenmeyer flasks containing 25 ml potato dextrose broth. The flasks were incubated on a rotary shaker at 220 rpm, 28 °C. The young mycelium of *F. fujikuroi* was separated by filtration while yeast cells were concentrated by centrifugation at 10,000 rpm for 10 min. Fresh mycelium and yeast biomass each were washed separately with sterile distilled water followed by washes with sterile osmotic stabilizer. About 100 mg fresh mycelium/yeast biomass with lytic enzyme in 100 ml shake flasks was incubated on rotary shaker at 100 rpm, 28 °C. The lysis of cell wall and the release of protoplasts were monitored at 30 min intervals under a light microscope. The protoplasts were counted using Neubauer improved cell counting chamber (Marienfeld Germany).

Culture age which is suitable for the isolation of maximum protoplasts was standardized by growing the test organisms, Mut32 and *T. cutaneum* NCIM3352 for 24 h as described above. The cultures were harvested at different time interval studied for the isolation of protoplasts. The commercial lysing enzyme Novozyme 234 tested with 2, 5, 10, 15 mg/ml concentration for both the cultures. While different osmotic stabilizers such as mannitol, potassium chloride, magnesium sulphate, sodium chloride were used and studied at a fixed concentration 0.6M and pH 6.8 for maximum protoplast formation.

3.2.12.3 Separation and Regeneration of protoplasts

Protoplasts of fungal culture Mut32, mutant strain of *F. fujikuroi* were separated by filtration over sterile cotton and a layer of tissue paper. While yeast *Trichosporon cutaneum* (NCIM 3352) protoplasts were isolated by centrifugation at 1000 rpm for 10 min. The resultant filtrates containing protoplasts of the both cultures were washed with osmotic stabilizer to remove the lytic enzyme remnants by centrifugation. The sediment protoplasts were re-suspended in known amount of osmotic stabiliser, their purity was checked under microscope and the number of protoplasts counted using Neubauer improved cell counting chamber (Marienfeld Germany). The protoplast suspension was spread inoculated on MGYP agar medium with and without 0.8 M KCl as osmotic stabilizer. Plates were incubated at 28 °C till colonies appeared. Growth only on MGYP agar plates with osmotic stabilizer confirms the absence of fungal or yeast cells in the suspension of protoplasts.

3.2.12.4 Intergeneric protoplast fusion and selection of fusant

Protoplasts were fused according to method of Ferenczy and Pesti (1982) with little modifications. One ml of the suspension containing 10^5 protoplasts in phosphate buffer (0.6 M $MgSO_4$ at pH 6.8) was prepared and equal number of protoplasts from Mut32 and *T. cutaneum* were mixed. The mixture was centrifuged at 1000 rpm for 10 min. The supernatant was discarded and the pellet was re-suspended in fusion mixture 30% polyethylene glycol (PEG, MW 3500) in 10 mM $CaCl_2$ solution and mixed gently by rolling the tube. The suspension was incubated for 10 minutes at room temperature. The fusion mixture was serially diluted with the osmotic stabilizer and plated on soft MGYP agar medium (Agar 1%) amended with 0.8M KCl osmotic stabilizer. Plates were incubated at 28 °C till colonies appeared. Fusants were selected based on change in their colony characteristics and morphology. Colony looking like yeast with pigmentation not normally present in the parent yeast was selected and studied further for GA_3 production.

3.2.12.5 Production of GA_3 by Selected Fusant

The selected yeast like hybrid strains were purified by three times plate streaking from very dilute suspensions and studied further for GA_3 production in shake flask cultures. Five ml 48 h grown seed cultures of parent fungus, parent yeast and

selected fusant were transferred to 50 ml LMF in 250 ml Erlenmeyer flasks and incubated for 5 days at 220 rpm, 28 °C on rotary shaker. The liquid cultures were observed microscopically for morphological differences. The apparent viscosity in shake flask cultures was noted as low, medium and high. Samples were analyzed for pH, residual glucose and GA₃ concentration by HPLC and further confirmed by LC-MS.

3.3 RESULTS AND DISCUSSION

3.3.1 Selection of strain for production of GA₃

Screening of microbial strains, their performance and suitable environment for GA₃ production is the most essential aspect to develop the technological solution for GA₃ production using biotechnological process. The effort was to identify GA₃ producing *Fusarium* strain, to study the strains using various culture conditions and consequently select the best strain suitable for mutagenesis for further desired improvements in GA₃ production. Newly isolated microbial strains and their mutants can be competitive to the current industrial production process, additionally productivity and yield could be further increased by optimizing different fermentation methods.

At present GA₃ is produced by submerged fermentation technique using fungus *F. fujikuroi*. It has been reported that *F. fujikuroi* is a complex of eight mating populations (MP-A to MP-C). All these *Fusarium* species are fungal pathogen of various crops such as maize, rice, barley and many more. So far, the ability to produce GAs and to cause bakanae disease has been confirmed only for rice isolate belonging to the species *F. fujikuroi* (sexual stage: *G. fujikuroi* MP-C) (Tudzynski, 1999). It is also reported that the strains belonging to mating type $\text{C}\emptyset$ produce less conidia and are prolific producers of gibberellins (Giordano *et al.*, 1999). Other fungi such as *Sphaceloma manihoticola*, *Neurospora crassa*, *Phaeoshaeria spp.* also produce some gibberellins but their yields are too low to be commercially available (MacMilan, 2002).

On the basis of these earlier reports in literature five *Fusarium* strains namely *F. fujikuroi* NCIM 665, *F. fujikuroi* NCIM 850, *F. fujikuroi* NCIM 1035, *F. fujikuroi*

NCIM 892, *F. fujikuroi* NCIM 1019 were selected from National Collection of Industrial Microorganisms (NCIM) for screening of their ability to produce GA₃.

The five strains of *F. fujikuroi* obtained from National Collection of Industrial Microorganisms (NCIM) were screened for GA₃ production and growth. When these strains were grown in 50 ml liquid fermentation medium containing ammonium nitrate as nitrogen source and glucose as carbon source, they showed differences in growth characteristics as well as product formed. Strains grew in a free, long mycelia form in liquid cultures making the broth viscous. The dry cell mass reached to about 10 g/l in all the cultures (Table 3.1). As compared to other four strains, *F. fujikuroi* NCIM1019 grew in a highly viscous filamentous form in shake flask. It produced only a few micro-conidia while the other four strains produced large number of micro and macro-conidia on solid medium as well as in liquid cultures. Along with less conidia production, *F. fujikuroi* NCIM1019 comparatively exhibited low production of cell bound and water-soluble pigment. Growth characteristics of cultures on RA medium plate are presented in Table 3.2 and Fig. 3.5.

The sugar uptake was similar in liquid cultures of the five strains studied. On screening, all five cultures were found to produce GA₃ in LMF as presented in Table 3.1. However, there were differences in GA₃ concentration and their specific GA₃ productivity. The strains produced between 15 and 76 mg/l GA₃ in shake flask cultures in 7 days. The GA₃ concentration (76 mg/l) in the broth of *F. fujikuroi* 1019 was considerably higher than that in the other *F. fujikuroi* strains. The specific GA₃ productivity (8.36 mg GA₃/g dry cell weight) and GA₃ yield (1.34 mg GA₃ g/sugar utilized) was also highest.

F. fujikuroi NCIM 1019 was selected amongst the five *Fusarium* species obtained from NCIM on the basis of its growth characteristics, very low conidia formation, relatively higher GA₃ production and its specific productivity. This strain was used for further strain improvement program.

<i>Culture</i>	<i>Dry cell mass g/l</i>	<i>Sugar utilized g/l</i>	<i>GA₃ mg/l</i>	<i>GA₃ mg/g DCW</i>	<i>GA₃ produced mg/g sugar utilized</i>
<i>F. fujikuroi</i> NCIM 665	10.94	57.06	17.0	1.55	0.29
<i>F. fujikuroi</i> NCIM 850	10.71	56.77	15.5	1.44	0.27
<i>F. fujikuroi</i> NCIM1035	6.54	56.92	16.0	2.44	0.28
<i>F. fujikuroi</i> NCIM892	6.44	56.67	40.5	6.28	0.71
<i>F. fujikuroi</i> NCIM1019	9.15	56.92	76.0	8.36	1.34

Table 3.1 Comparison of GA₃ production by five *Fusarium* strains

<i>Fusarium strains</i>	<i>Size</i>	<i>Shape</i>	<i>Margin</i>	<i>Surface Appearance</i>	<i>Roughness</i>	<i>Pigmentation</i>
<i>F. fujikuroi</i> NCIM665	Larger	Circular	Regular	Fibrous	Soft	Reddish purple
<i>F. fujikuroi</i> NCIM850	Larger	Circular	Regular	Fibrous	Soft	Reddish purple
<i>F. fujikuroi</i> NCIM1035	5-4cm	Circular	Regular	Fibrous	Soft	Dark purple
<i>F. fujikuroi</i> NCIM892	6-5cm	Circular	Regular	Fibrous	Soft	Reddish purple
<i>F. fujikuroi</i> NCIM1019	4-3cm	Circular	Regular	Cottony	Soft	Faint reddish purple

Table 3.2 Colony characteristics of *Fusarium* strains on RA media



F.fujikuroi 665



F.fujikuroi 850



F.fujikuroi 892



F. fujikuroi 1035

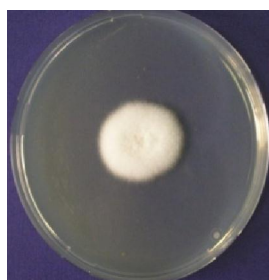

F. fujikuroi 1019

Figure 3.5 Growth of *F. fujikuroi* strains obtained from NCIM on RA agar

3.3.2 HPLC analysis

The HPLC analysis method used in the current investigation well resolved GA₃ present in fermentation broth. Chromatograms of the reference compounds and a sample of fermentation broth showing GA₃ are presented in Fig. 3.6.

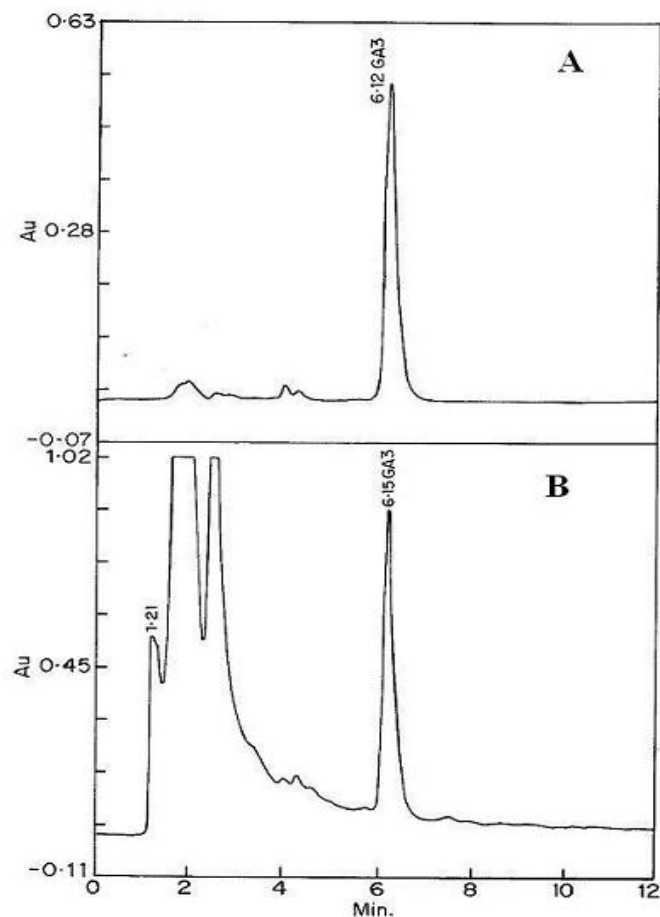

Figure 3.6 Reversed phase HPLC chromatogram of A) standard compound GA₃ B) a sample of fermentation broth

Fig. 3.6 shows chromatograms of standard gibberellic acid (GA₃) and that of the sample of fermentation broth. The GA₃ eluted at 6.12 min by using the reverse phase HPLC as described in Chapter 2. Total run time was 12 min with mobile phase flow rate of 0.6 ml min⁻¹. Excellent peak separation was achieved under isocratic mode of elution. Online scanning showed a peak purity index of 999 for the standard GA₃ peak and had maximal absorbance (max) at 205 nm. GA₃ peak in the chromatogram of the fermentation broth had identical spectral pattern and peak purity index to that of the standard GA₃.

3.3.3 Choice of carbon source

To select the suitable carbon source for GA₃ production, *F. fujikuroi* NCIM 1019 was grown in the liquid fermentation medium with various carbon sources. Results

presented in Table 3.3 show that irrespective of carbon source used, growth of *F. fujikuroi* NCIM 1019 was almost similar. The cell mass ranged between 7.3 and 9 g/l with different carbon sources used. Morphologically no distinct difference was observed. Except glycerol, filtrates of other sugars were faint purplish colored.

Table 3.3 also shows that varying carbon sources in the culture medium affected GA₃ production by *F. fujikuroi* NCIM 1019. When glucose, was used as carbon source it produced higher amount of GA₃ (82 mg/l) as compared to other carbon sources. Also specific gibberellic acid productivity (9.1 mg GA₃/g dry cell weight) of *F. fujikuroi* NCIM 1019 was relatively higher in glucose containing medium.

Glucose and sucrose have been regularly used carbon sources in GA₃ fermentation study (Bruckner and Blechschmidt, 1991). It is also easy to use because concentrated solutions can be prepared and sterilized on larger scale. Glucose is a better choice of carbon source and was used as carbon source for *F. fujikuroi* NCIM 1019 for successive experiments.

<i>Carbon sources</i>	<i>Dry cell weight g /l</i>	<i>GA₃ mg /l</i>	<i>GA₃ mg/ dry cell weight</i>
Glucose	9	82	9.1
Fructose	8.52	41	4.81
Sucrose	8.32	45	5.41
Soluble starch	7.52	56	7.45
Glycerol	7.3	32	4.38

Table 3.3 Effect of different carbon sources on GA₃ production

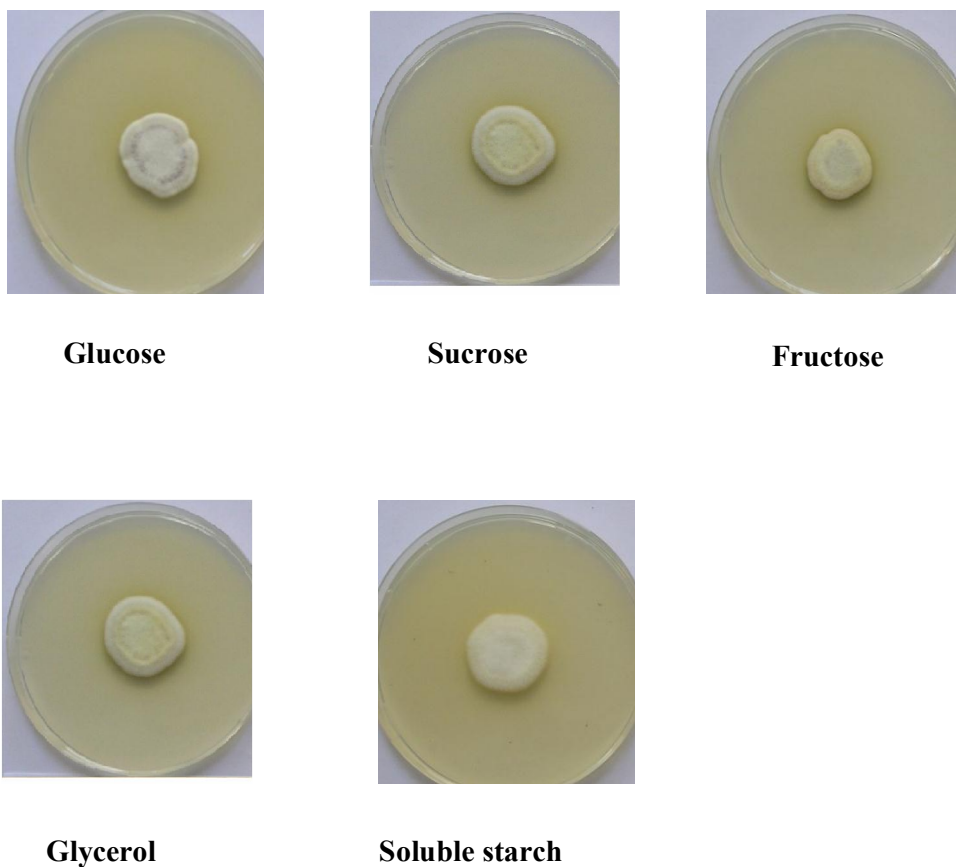

Figure 3.7 Growth of *F. fujikuroi* NCIM 1019 on RA agar containing different carbon sources

3.3.4 Screening of nitrogen sources for selected GA₃ producing culture

Nitrogen limitation is the precondition for gibberellins formation as production of gibberellins starts towards the exhaustion of nitrogen source from the medium (Borrow *et al.*, 1964). Therefore in present investigation C: N of 100:1 was maintained in liquid fermentation medium. The nitrogen sources used during the present study can be grouped in three main categories. Ammonium salts or nitrates, digests prepared from vegetable or animal proteins and complex defatted plant meals.

Results of effect of different nitrogen sources on GA₃ production, the growth and GA₃ productivity by *F. fujikuroi* NCIM 1019 presented in Fig. 3.8 and Fig. 3.9 respectively.

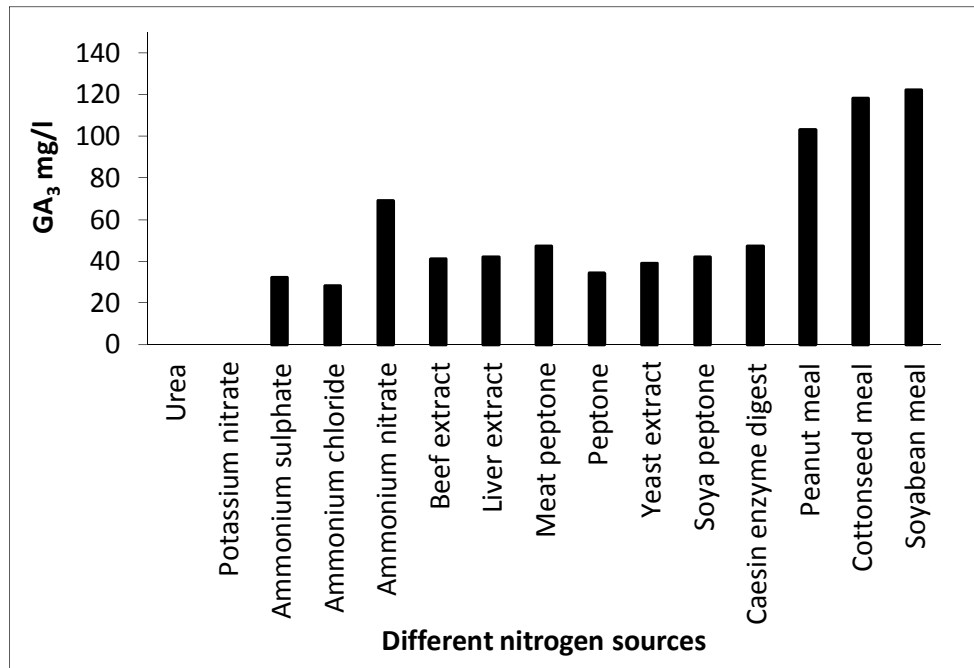

Figure 3.8 Comparison of nitrogen sources for GA₃ production by *F. fujikuroi* 1019

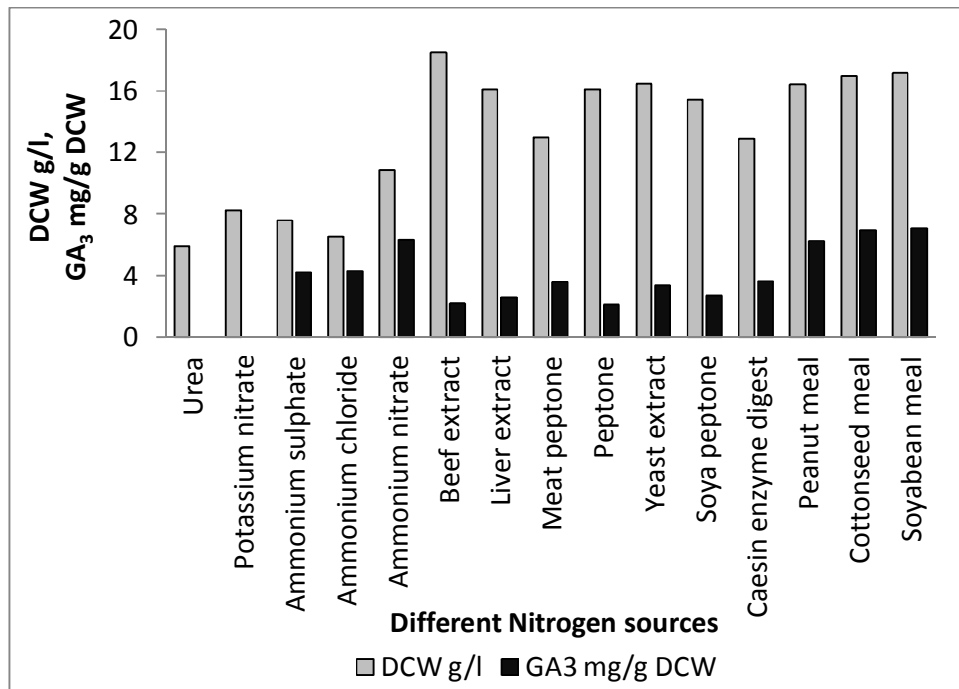

Figure 3.9 Effect of nitrogen sources on the growth of *F. fujikuroi* 1019 and its specific gibberellic acid productivity

From Fig. 3.9 it can be seen that *F. fujikuroi* NCIM 1019 could utilize a wide variety of inorganic and organic nitrogen sources for the growth. The growth of *F. fujikuroi*

NCIM 1019 in terms of dry cell mass ranged between 5.92-10.85 and 12.82-18.49 g/l in media containing inorganic and organic nitrogen sources respectively. Among the inorganic nitrogen source based media, ammonium compounds were more suitable for the growth as well as gibberellic acid production by *F. fujikuroi* 1019. Although the strain could utilize urea and potassium nitrate and grew to the same extent, it did not produce any gibberellic acid (Fig. 3.8 and Fig. 3.9). Thus inorganic nitrogen sources although helped growth, the production of gibberellic acid was rather low. This could be because of several different reasons like lowering of pH in the fermentation medium in the shake flask when chlorides and sulphates were used, failure of the cells to initiate secondary metabolism, unfavourable physiological stage for gibberellin biosynthesis, absence of key intermediates necessary for gibberellin production etc.

Fig. 3.8 and Fig 3.9 also illustrate that the digests prepared from plant and animal proteins (beef extract, meat extract, liver extract, yeast extract, casein enzyme digest, soyapeptone) resulted in substantial increased cell mass of the *F. fujikuroi* NCIM 1019. The growth in terms of dry cell mass was between 12.82-18.49 g/l. As compared to inorganic nitrogen sources the growth was almost doubled. However increased growth did not result proportionally increased gibberellic acid production. The digested nitrogenous nutrients are a rich source of amino acids and polypeptides. This indicates that the strain preferred organic soluble nitrogen sources for growth. This is not uncommon because several secondary metabolites are produced by cells under severe nutritional stress.

It was reported that the source and concentration of the nitrogen in the fermentation media have the greatest effect on the growth of *F. fujikuroi* and its GA₃ production (Tudzynski, 1999). In general, complex organic nitrogen sources were found to be better for growth and GA₃ production by *F. fujikuroi* (Darken *et al.*, 1959; Fuska *et al.*, 1961). Complex nitrogen sources like plant extracts might contain precursors or inducers of the GA pathway and boosts gibberellins biosynthesis reported by Rademacher (1997). In present investigation also similar findings were obtained. Used different nitrogen sources influenced the growth and GA₃ production by *F. fujikuroi* NCIM 1019 (Fig. 3.8 and Fig. 3.9). Among studied different organic nitrogen sources, mainly three different defatted plant meals enhanced growth and

gibberellic acid production in *F. fujikuroi* NCIM 1019 (Fig. 3.8). These plant meals yielded almost similar quantities of GA₃ under identical conditions. Difference in growth and specific gibberellic acid productivity (mg GA₃/g dry cell weight) was also marginal as seen from Fig. 3.9.

In addition to gibberellic acid, *F. fujikuroi* 1019 produced cell bound or water soluble pigments like carotenoids or bikaverins in media with defatted peanut meal and cottonseed meal. *F. fujikuroi* is known to biosynthesize several polyketide pigments like bikaverin and nor-bikaverin (Kjaer *et al.*, 1971) as well as the carotenoids like neurosporaxanthin (Avalos and Cerda-Olmedo, 1987). The pigment production is undesirable because the pigment/s may interfere with extraction and purification of gibberellic acid (Shukla *et al.*, 2003). Therefore from present study amongst studied different nitrogen sources, defatted soyabean meal was elected as suitable nitrogen source for the growth and gibberellic acid production and used in all the subsequent experiments.

3.3.5 Mutagenesis

The parent strain *F. fujikuroi* NCIM 1019 grew in a viscous filamentous form in shake flask. The filtered and washed mycelium looked orange in colour and the filtrate had a red-violet colour. Earlier Keller (1983) reported that although single cells or spores are preferred for mutagenesis, in case of non-spore-forming filamentous organisms, mycelia/ protoplasts are mutagenized. Similarly in present study also the selected parent *F. fujikuroi* NCIM 1019 did not produce macro or microconidia on normal growth media and therefore small mycelial fragments having one or two cells were used for the mutagenesis.

General protocol followed during the strain improvement programme for *F. fujikuroi* NCIM 1019 is presented in flow diagram (Fig. 3.10) and the same protocol was also followed for the intermediate mutants until a desired mutant was obtained.

Survival curve of *F. fujikuroi* NCIM 1019 after the mutagen treatments are presented in Fig. 3.11a, b. The figure illustrate that 95% kill was obtained on treating the cells with UV for 7 seconds, whereas for the chemical mutagens (EMS) optimum time was found to be between 30 to 40 min.

The detailed summary of each mutagenesis series, selection of the mutants and the selected mutant used as intermediate parents for next series of mutagenesis is given in Table 3.4. Altogether 38 mutation series were performed from which 1056 mutants were selected and screened for GA₃ production.

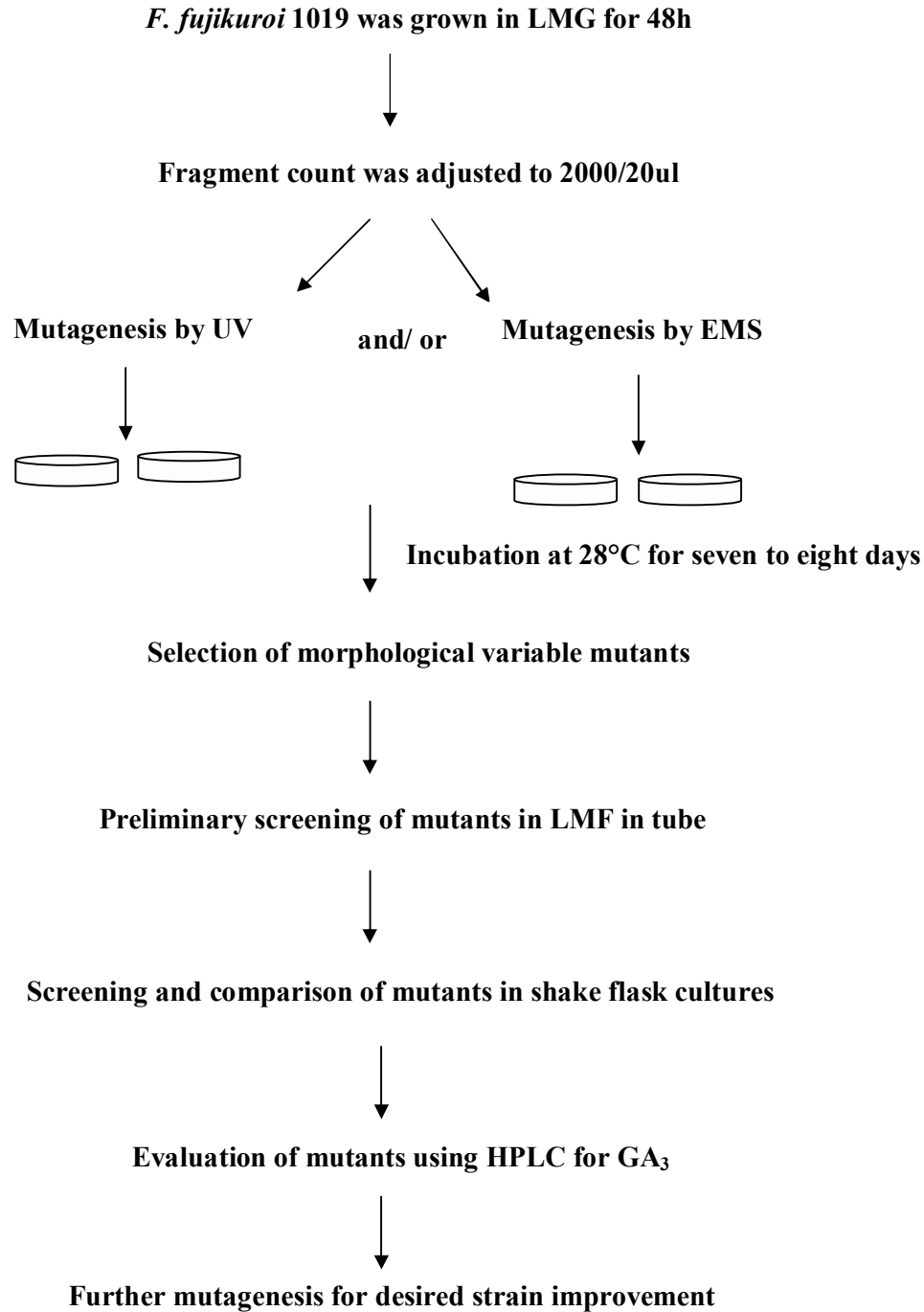

Figure 3.10 Technique used for strain improvement by random mutagenesis

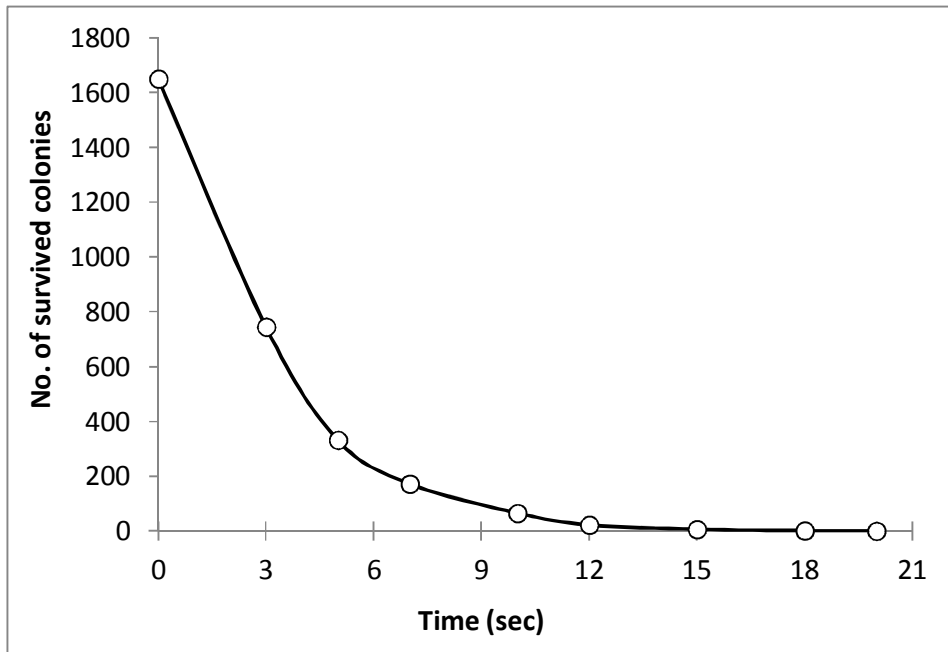

Figure 3.11a UV survival curve for *F. fujikuroi* NCIM 1019

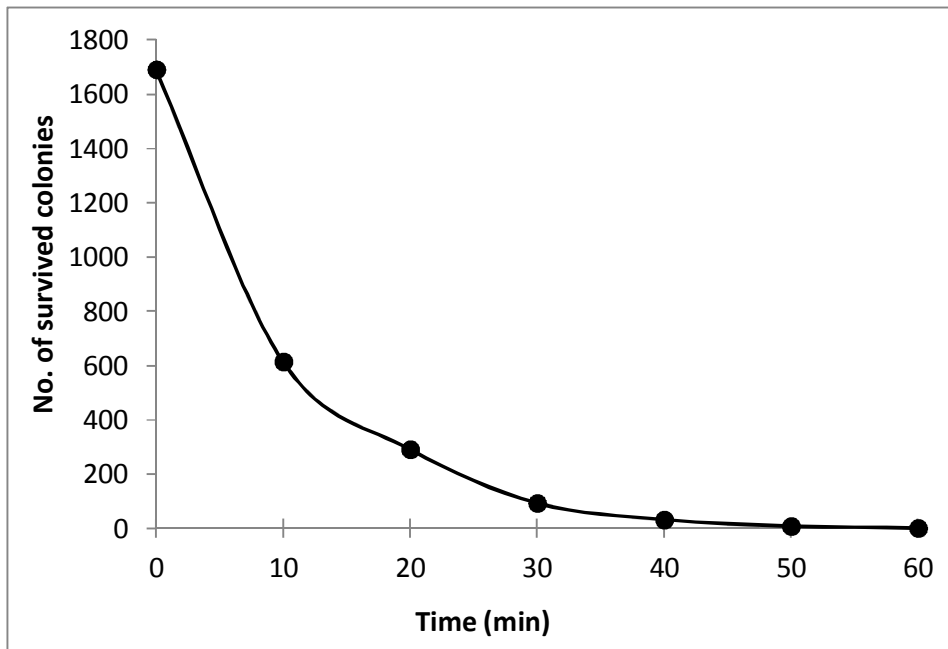

Figure 3.11b EMS survival curve for *F. fujikuroi* NCIM 1019

<i>Series</i>	<i>Parent used</i>	<i>Mutagen</i>	<i>No. of survivors selected</i>	<i>Mutant Selected</i>	<i>Inhibitors used in RA media</i>
1	<i>F. fujikuroi</i> NCIM1019	UV	40	Car1	Pravastatin
2	Car1	UV	30	Mut4	Pravastatin
3-4	Mut4	UV	45		Pravastatin
5-10	Mut4	UV	35	Mut65	Nystatin
11-14	Mut65	UV	115	Mut189	Diphenylamine
15-22	Mut189	EMS	341		Diphenylamine
23-24	Mut189	UV+EMS	167		
25-27	Mut23	UV+EMS	53		
28-30	Mut189	UV	52		
31-35	Mut189	UV	78		Lovastatin
36-38	Mut189	UV	100		
38			1056	Car1 Mut4 Mut65 Mut189	

Table 3.4 Summary of Mutagenesis Series

The small mycelial fragments with one or two cells were reasonably suitable for the mutagenesis experiments. A variety of morphological mutants having different mycelial and soluble pigmentation as well as colony morphologies were generated from *F. fujikuroi* upon exposure to UV radiation and EMS. Various morphological differences in the generated mutants were noted at each mutagenesis stage. In general they were as follows

- Small, compact dry colonies
- Orange, pale yellow or colourless colonies

- Colonies with or without soluble dark red pigment
- Mycelial, cottony colonies to short surface mycelium with branching

To screen large number of survivors from plate culture, mainly two different approaches were employed for the selection of enhanced GA₃ producer. Approaches to the selection of mutants were 1) Mutants with modified colony characteristics

Usually in liquid media *F. fujikuroi* strains grows with long filamentous mycelia that causes the fermentation broth to become very viscous. During fermentation either in shake flask or in fermenter, the viscosity of the broth causes limitation to the oxygen transfer rate and this declines the production of secondary metabolites like gibberellic acid that are oxidation products. Mutants with modified colony characteristics expected to grow with morphological change that will suit the fermentation broth rheology.

2) Mutants with low or no pigmentation

In *F. fujikuroi* culture the pathway leading to gibberellic acid synthesis, acetoacetyl CO-A is a branch point as several other metabolites are generated through this compound under different degrees of nitrogen limitation, oxygen availability, temperature and pH. One of them is the pigment either water-soluble (bikaverin) or cell bound (carotenoids). Mutants with low or no pigmentation was another key to the selection of mutants with possible increase in gibberellin production.

The parent strain *F. fujikuroi* NCIM 1019 grew in a viscous filamentous form in shake flask. The filtered and washed mycelium looked orange in colour and the filtrate had a redóviolet colour. Result presented in Table 3.4 show that after first mutagenesis 40 survivors producing white, cottony, circular colony on regeneration agar were selected. Strains were resistant to HMG CO-A reductase inhibitor (pravastatin). A mutant strain Car1 was selected. Although morphologically similar to the parent, the carotenoid accumulation in the cells was negligible as appeared from filtered and washed cell mass. The culture filtrate, unlike parent, did not have the distinct bikaverin colour also. Based on the loss of pigmentation and 25% increased GA₃ as compared to parent, Car1 was selected and used as the parent in subsequent mutagenesis experiments.

The UV mutagenesis of Car1 generated a wide variety of mutants. The survivors selected after mutagenesis of Car1 strain exhibited various morphological changes. Amongst 30 screened survivors, non-pigmented mycelial mutant strain Mut4, exhibiting less apparent viscosity in liquid cultures as compared to parent (Car1) was selected.

During subsequent UV mutagenesis study of Mut4 survivors with different colony characteristics were generated. The colonies that grew rapidly and became large were presumably produced from the cells without any alteration. Those colonies that grew slowly, remained small, and compact showed variations in their phenotype, had genetic alteration presumably caused because of a mutation. The different mutants with different colony morphologies were expected to have modified morphology in liquid cultures also. The smaller colonies (0.5-1 cm) with crusty, uneven margins, rough surfaces and decreased/no pigmentation on regeneration agar plates were selected. These characteristics indicated that they might have morphology suitable for micro-pelleted mutants, when grown in liquid cultures. A mutant strain Mut65 grew with short length, thicker mycelium without pigmentation. It produced 10% increased GA₃ than immediate parent Mut4 while 3 fold increased as compared to first parent. Based on altered morphology and higher GA₃ production Mut65 was selected.

Later mutations were carried out using Mut65 as parent strain and a mutant strain Mut189 was selected in similar way. It produced small, compact, rough, dry and irregular colonies on RA media. It grew profusely in a free, short branched mycelial form with increased cell thickness in liquid cultures and the broth has lower apparent viscosity. Mut189 produced almost 4 fold increased GA₃ as compared to first parent and almost 70-80% increased GA₃ than Mut65.

UV, EMS and UV + EMS mutagenesis using Mut189 as parent were also performed. A wide range of mutants generated at each mutagenesis series. Although mutants were selected in similar way as discussed earlier but they produced either low or similar concentration of GA₃ as compared to Mut189.

The average terminal hyphal length had distinct differences between four strains. The average apical hyphal length of Car1 strain was 248 μm, Mut4 mutant was 173 μm,

Mut65 strain was 94 μ m while that of Mut189 was just 74 μ m. These lengths were measured at 24 h in shake flask cultures when they were near the end of the logarithmic phase and therefore these lengths were of mature hyphae. The present invention indicate that use of morphologically changed mutant strains would be advantageous for the fermentation because the problem associated with poor mixing and oxygen transfer in fermenter could be minimized.

During screening of mutants, a mutant named Mut189 was selected because it produced considerably high amount of GA₃. The mutant Mut189 did not produce any pigment either cell bound or water soluble as appeared from filtered and washed cell mass and clear pale yellow filtrate respectively. The selected mutant showed morphological difference than the parent *F. fujikuroi*. It grew as short branched mycelial form with increased cell thickness and low apparent viscosity in liquid cultures.

Although almost nothing is known about the mechanisms causing higher production in superior random or morphological mutants, it is likely that many of these mutations involve regulatory genes, especially as regulatory mutants obtained in basic genetic studies and found to be altered in colonial morphology. So the morphological mutants have been important in strain improvement study (Adrio and Demain, 2006). Earlier researchers have reported several mutants of *F. fujikuroi* mainly deficient GA biosynthesis. They were studied specifically for the discovery of major steps of GA biosynthesis. Very few reports are available with respect to enhanced GA₃ production by strain improvement of *F. fujikuroi*. Avalos *et al.*, (1995) isolated 12 mutants of the wild type *F. fujikuroi* IMI58289 by treatment with NTG. These mutants not produced GA₃ when grown in minimal liquid media. Along with 12 gibberellin defective mutants, they obtained SG22 super carotenoid producer. Avalos and Cerda-Olmeda (1987) studied strain improvement of *F. fujikuroi* by screening of mutants with blocked carotenoid biosynthesis. They reported that mutant strains with lower levels of neurosporaxanthin can produce more gibberellins when the competing biosynthetic pathway with the same precursor mevalonate is blocked. Khalaf *et al.*, (2009) recorded best yield of GA₃ (2.40 g/l) from milk permeate by immobilized mycelia of mutant gamma-14 on loofa sponge discs under optimized cultural conditions (4 immobilized discs, 30°C and pH 5).

3.3.6 Preliminarily screening of the selected mutants

To study large number of survived mutant colonies for enhanced GA₃ production the tube level screening of *F. fujikuroi* was found to be suitable as a primary screening tool. The growth and GA₃ production by different mutants in test tubes differed considerably from the respective parents. The difference in GA₃ content was at times due to difference in growth and productivity. Some of the mutants could not grow well in liquid medium and resulted in poor GA₃ production. While some of the mutants grew well with modified morphology and produced higher GA₃ compared to the appropriate parent. Result presented in Table 3.5 show that in all 1056 survived mutant colonies were screened. More than 200 colonies showed better result in tube level screening as compared to their respective parent culture.

<i>Mutagenesis Series No</i>	<i>No of mutants screened in test tube</i>	<i>No of mutants selected for further study</i>
1	40	4
2-4	75	2
5-10	35	11
11-14	115	28
15-22	341	39
23-24	167	24
25-27	53	12
28-30	52	34
31-35	78	40
36-38	100	17
38	1056	211

Table 3.5 *F. fujikuroi* mutants screened through test tube for enhanced production of gibberellic acid

3.3.7 Shake flask screening of selected mutants for GA₃ production

During preliminary screening, 1056 mutants of *F. fujikuroi* for enhanced GA₃ production were screened. Around 211 mutants that showed at least 15-20% higher GA₃ production compared to their respective parent were further studied in shake flask cultures. The oxygen transfer and mixing is far better in shake flasks and

several strains can be compared simultaneously. Twenty three mutants as listed below in Table 3.6 were further selected through shake flask study and studied in detail with respect to growth characteristics on RA media, net gibberellic acid production, specific production (mg GA₃/g dry cell mass), yield (mg GA₃/g sugar utilized) as well as rate of production (GA₃ mg/l/day). They were evaluated in shake flask experiment simultaneously, under identical cultural conditions.

List of mutants	Car1, Mut4, Mut23, Mut32, Mut65, Mut189, Mut226, Mut362, Mut404, Mut730, Mut735, Mut736, Mut749, Mut754, Mut757, Mut767, Mut768, Mut772, Mut775, Mut780, Mut788, Mut799, Mut801
------------------------	---

Table 3.6 *F. fujikuroi* mutants selected for shake flask culture study

Mutant names	Size	Shape	Surface appearance	Roughness	Margin	Pigmentation
<i>F. fujikuroi</i> NCIM1019	2-3cm	Circular	Cottony	Soft	Regular	Red purple
Car1	1cm	Circular	Fibrous	Soft	Regular	White
Mut4	0.9cm	Circular	Cottony	Soft	Regular	Pale orange
Mut23	0.8cm	Circular	Cottony	Soft	Regular	White
Mut32	5mm	Circular	Cottony	Soft	Regular	Orange
Mut65	2mm	Circular	Rough	Crusty	Irregular	Pale orange
Mut189	2mm	Circular	Rough	Crusty	Irregular	Pale orange
Mut226	2mm	Circular	Rough	Crusty	Irregular	Red
Mut362	3mm	Circular	Rough	Crusty	Irregular	White
Mut404	4mm	Circular	Rough	Crusty	Irregular	Pale orange
Mut730	2mm	Circular	Rough	Crusty	Irregular	Pale orange
Mut735	3mm	Circular	Rough	Crusty	Regular	Pale orange
Mut736	3mm	Circular	Dry compact	Crusty	Regular	White
Mut749	4mm	Circular	Dry compact	Crusty	Irregular	White
Mut754	4mm	Circular	Dry compact	Crusty	Irregular	White
Mut757	5mm	Circular	Dry compact	Crusty	Irregular	White
Mut767	2mm	Circular	Dry compact	Crusty	Irregular	White
Mut768	2mm	Circular	Dry compact	Crusty	Regular	Pale orange
Mut772	3mm	Circular	Dry compact	Crusty	Regular	White
Mut775	3mm	Circular	Dry compact	Crusty	Irregular	Pale orange
Mut780	4mm	Circular	Dry compact	Crusty	Irregular	Pale orange
Mut788	2mm	Circular	Rough	Hard	Regular	White
Mut799	3mm	Circular	Rough	Hard	Irregular	Pale orange
Mut801	3mm	Circular	Rough	Hard	Irregular	White

Table 3.7 Growth characteristics of selected mutants of *F. fujikuroi* on RA media

<i>Mutant Names</i>	<i>Apparent viscosity</i>	<i>Dry cell weight g/l</i>	<i>Sugar Utilized g/l</i>	<i>GA₃ mg/l</i>	<i>Specific productivity GA₃ mg/g dry cell weight</i>	<i>Yield GA₃ mg/g sugar utilised</i>
<i>F. fujikuroi</i>	Higher	18	60	118	6.56	1.97
NCIM1019						
Car1	High	19.5	60	295	15.13	4.92
Mut4	High	21.52	54.5	300	13.94	5.50
Mut23	High	19.81	58.2	153	7.72	2.63
Mut32	High	20.1	56.3	270	13.43	4.8
Mut65	Low	19.26	40.5	327	16.98	8.07
Mut189	Low	19.7	41.9	434	22.03	10.36
Mut226	Low	20.53	54.5	373	18.17	6.84
Mut362	Low	18.95	52.4	387	20.42	7.39
Mut404	Medium	18.29	57.7	375	6.50	6.50
Mut730	Low	21.8	58.1	343	15.73	5.90
Mut735	Medium	21.84	56.4	332	15.2	5.89
Mut736	Medium	20.53	57.3	322	15.6	5.62
Mut749	Low	21.3	58.9	381	17.89	6.64
Mut754	Low	22.4	60	391	17.46	6.52
Mut757	Medium	20.9	57.3	346	16.56	6.04
Mut767	Medium	21.12	56.9	346	16.38	6.08
Mut768	Medium	20.2	58.1	282	13.96	4.85
Mut772	Medium	19.9	59.1	304	15.28	5.14
Mut775	Medium	18.92	57.6	350	18.5	6.08
Mut780	Low	19.9	58.8	387	19.45	6.58
Mut788	Medium	20.7	56.9	338	16.33	5.94
Mut799	Medium	19.7	57.8	338	17.16	5.85
Mut801	Medium	18.42	58.7	352	19.11	6.0

Table3.8 Growth and gibberellic acid production by selected mutants of *F. fujikuroi*

When the selected 23 mutant strains were grown in 50 ml LMF medium they exhibited different growth characteristics from each other in liquid cultures. The

result of growth and gibberellic acid production by selected mutants of *F. fujikuroi* is detailed in Table 3.8.

Table 3.8 shows that there was no major change in the extent of growth of mutant strains in terms of dry cell mass. The dry cell mass was ranged between 18-22.5 g/l. Parent strain *F. fujikuroi* NCIM 1019 grew profusely in a free, long mycelia form in liquid cultures making the broth highly viscous. While mutant strains Mut65, Mut189, Mut226, Mut730, Mut749, Mut754, Mut362 and Mut780 grew with short, thick, highly branched mycelium in liquid culture and the broth had lower apparent viscosity as compared to other strains and the parent.

Table 3.8 also shows that the short filament strains resulted in substantially higher gibberellic acid content. It was reported that the oxygen availability causes a major change in proportion of the metabolites produced by *F. fujikuroi* (Giordano and Domenech, 1999). In the present study, the decreased mycelial length presumably resulted in increased oxygen transfer in the submerged cultures of these mutant strains. In turn they may have channelled more carbon through the gibberellin pathway resulting in higher concentration of gibberellic acid. The total GA₃ produced by improved mutants was almost two-fold higher as compared to the parent strain.

A considerable amount of sugar was utilized by these cultures in their stationary phase. Except for mutant Mut65 and Mut189 the sugar uptake was nearly equal in all the liquid cultures of the strains studied. It can be also seen from Table 3.8 that mutant Mut189 produced 434 mg/l GA₃, which was considerably higher than that of other mutants and parent *Fusarium* strain. The growth of all the strains in the basal medium was almost similar and this showed that the specific gibberellin productivity of Mut189 was also highest (22.03 mg GA₃/g dry cell weight).

The actual rates of GA₃ production by these mutants at different time interval were also studied and are depicted in Fig. 3.12

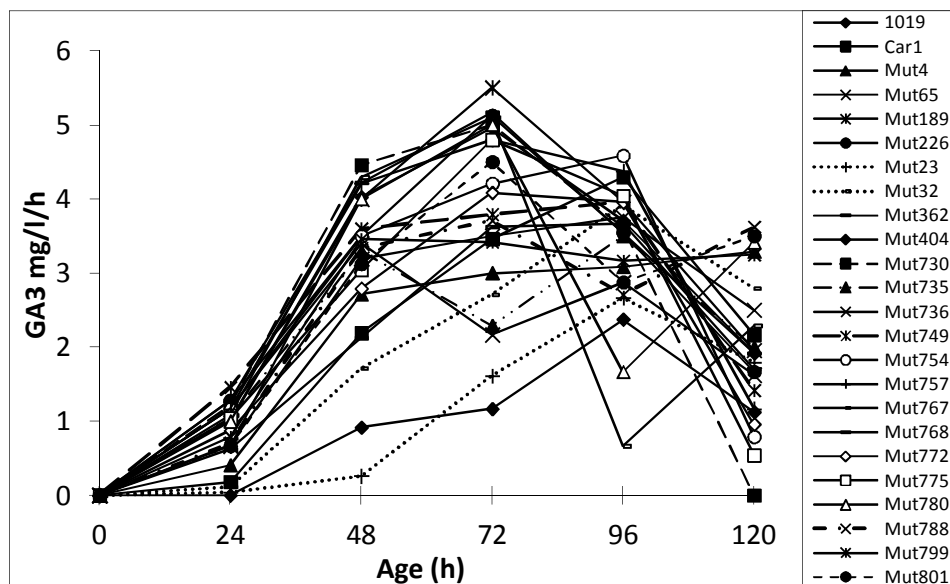

Figure 3.12 Comparison of GA₃ production rates of selected mutants

The data presented in Fig. 3.12 show that the rate of gibberellic acid production by different mutants varied considerably. The rate of GA₃ production reached a peak between 48-72 h in selected mutants while in parent strain it was higher during 72-96 h. This showed that as compared to the parent, selected mutants grew faster and reached production phase earlier. However, GA₃ production rate declined later irrespective of the mutant and concentration of GA₃ in the fermentation broth. The production rate of gibberellic acid by mutant Mut189 was higher compared to others.

3.3.8 Comparison of selected mutants

The selection of mutants also depended on their growth characteristics and viscosity of the liquid cultures in shake flasks when they were grown in shake flasks at constant speed and temperature. Comparison of five strains namely *F. fujikuroi* NCIM 1019 (parent strain) and its four mutant strains Car1, Mut4, Mut65 and Mut189 with respect to viscosity and oxygen transfer were studied. To study this in the first experiment, the medium volumes in 250 ml Erlenmeyer flask were varied. In the second experiment, the concentration of individual ingredients in the medium was increased keeping the volume constant. Increase in nutrient concentration as well as medium volume in Erlenmeyer flasks causes increase in oxygen demand in the shake flask culture because of increase in the cell mass. The results of effect of

increased volume and increased strength of medium on GA₃ production illustrated in Fig. 3.13 and Fig. 3.14 respectively.

The data presented in Fig. 3.13 show that increase in medium volume in 250 ml Erlenmeyer flask adversely affected GA₃ production in the mycelial parent strain *F. fujikuroi* NCIM 1019 and intermediate parent Car1. There was drastic decrease in GA₃ concentration in case of mycelial parent and mutant Car1 when the volume of medium in 250 ml flask was increased from 30 to 60 ml. The change was proportional to the increase in the medium volume. This was likely to be because of decreased oxygen availability for their growth and GA₃ production. On the contrary, in case of the strains with altered morphology the GA₃ production were least affected. The mutant strains Mut65 and Mut189 are morphologically modified mutants and irrespective of medium volume their morphology remained same. They grew with short, thick and branched mycelial filamentous form in liquid cultures and exhibited lower apparent viscosity and better oxygen transfer rate as compared to mycelial strain. In these mutants GA₃ production did not decrease like mycelial mutants presumably because of higher availability of oxygen. This supports our choice of the mutants with short mycelial filament length. In general the oxygen availability has profound effect on gibberellic acid production because in all cases the increased volume in the shake flask decreased the GA₃ concentration.

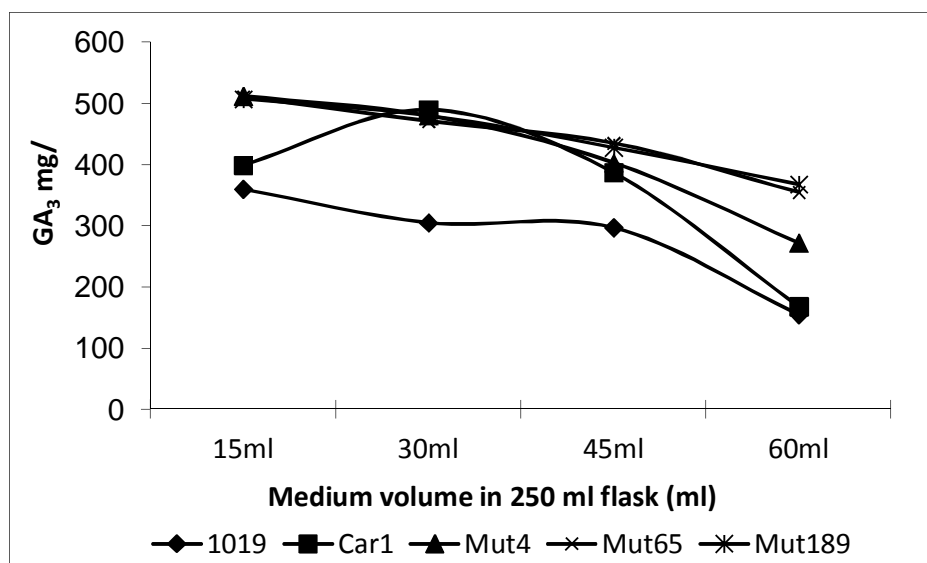

Figure 3.13 Effect of different medium volume in 250 ml Erlenmeyer flasks on GA₃ production by morphological mutants of *F. fujikuroi*

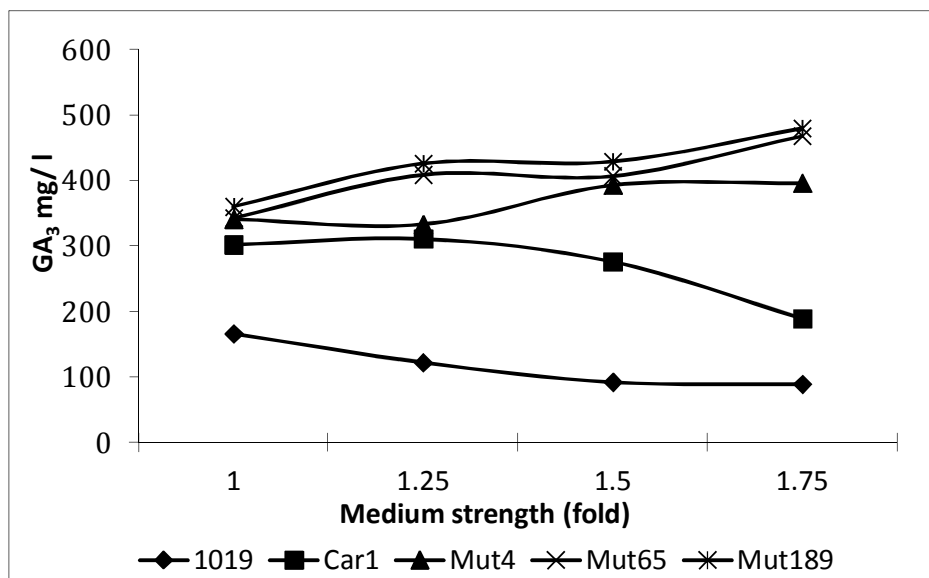

Figure 3.14 Effect of medium strength in 250 ml Erlenmeyer flasks on GA₃ production by morphological mutants of *F. fujikuroi*

To increase gibberellic acid concentration in fermentation broth, efforts were made to increase biomass in shake flasks. Selected mutants were studied in 50 ml LMF medium with different strengths, in 250 ml Erlenmeyer flasks. The result presented in Fig. 3.14 show that in case of the mycelial mutant increase in medium strength adversely affected the GA₃ production. Increase in medium strength beyond 1.25 fold, decreased the GA₃ content for mycelial mutants but not in the case of mutants with short filament length. Similar to the above results, this is mainly due to the decreased oxygen availability for the growth and GA₃ production by mycelial strains. In the present investigation selection and evaluations of mutants of *F. fujikuroi* that have altered morphology in terms of filament length and increased production of gibberellic acid clearly indicated that the current objective of obtaining a morphological mutant for enhanced GA₃ production was appropriate.

The rate of growth of *F. fujikuroi* and production of GA₃ in fermenter is governed to a considerable extent by oxygen transfer in the fermenter. It is also reported that *F. fujikuroi* cultures enter a linear growth phase after initial logarithmic phase (Borrow *et al.* 1964) presumably because of the oxygen limitation. During stationary phase of *F. fujikuroi* culture several products like bikaverin, carotenoids, gibberellic acid, fusaric acid are produced from a common precursor, acetyl-CoA (Bruckner *et al.*,

1989; Avalos and Cerda-Olmedo, 1987; Kjaer *et al.*, 1971; Avalos, *et al.*, 1991). Giordano and Domenech (1999) have described how the aeration affects the fate of acetate in *F. fujikuroi* during secondary metabolism. They also studied different levels of aeration using different volumes of medium in 125 ml Erlenmeyer flasks. They concluded that higher aeration increased the concentration of gibberellins and bikaverin while lower aeration resulted in increased accumulation of fatty acids and fusarin C. Overall concentrations and ratio of secondary metabolites of *F. fujikuroi* are governed by the availability of oxygen in the liquid cultures.

Hydrodynamics, mass transfer and rheology of gibberellic acid production by *F. fujikuroi* in an airlift bioreactor were studied by Silva *et al.*, (2007). They studied the growth kinetics of *F. fujikuroi* during fermentation and explained the culture medium rheological behaviour in terms of changes in the morphology of the fungus. In case of mycelial cultures, as the biomass concentration increased the broth became more viscous and non-Newtonian; leading to substantial decreased oxygen transfer rates. This effect is often important since for many aerobic processes involving oxygen supply is the limiting factor determining bioreactor productivity (Al-Masry and Dukkan, 1998).

3.3.9 Characterization of selected mutant Mut189 of *F. fujikuroi*

3.3.9.1 Morphology

Phase contrast and scanning electron micrographs (Fig. 3.15 and Fig. 3.16) illustrate that mutant Mut189 had morphological difference compared to its parent *F. fujikuroi* NCIM 1019. The parent mycelia were long filamentous with less thickness and branching. The mycelia of mutant were short, highly branched hyphae, curly at tips with thick, swollen cells as compared to parent as visualized under 5000 X magnification.

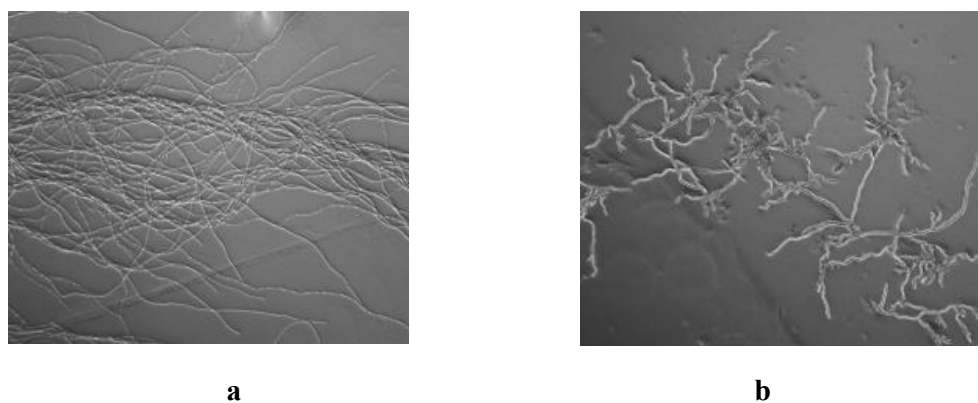

Figure 3.15 Phase contrast micrographs a) *F. fujikuroi* NCIM 1019 b) Mutant Mut189

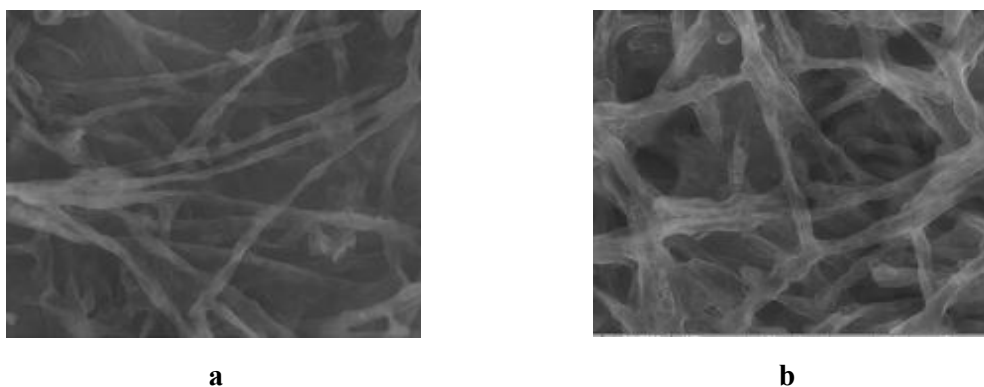
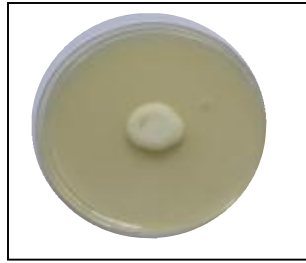

Figure 3.16 Scanning electron micrographs a) *F. fujikuroi* NCIM 1019 b) Mutant Mut189

3.3.9.2 Carbohydrate utilisation by mutant Mut189

Mutant Mut189 showed carbohydrate utilization pattern similar to the parent *F. fujikuroi* NCIM 1019. It could utilize all studied carbohydrates for its growth. There was distinct difference in growth characteristics with the studied carbohydrate between parent and mutant strain as shown in Fig. 3.17a and 3.17b. The growth of parent *F. fujikuroi* NCIM 1019 was a large, circular, soft cottony colony with regular margin and reddish purple pigmentation. In comparison with fructose pigmentation was more intense observed visually on RA plate. The growth of mutant Mut189 was small, circular, compact and hard colony with irregular margin. There was no pigmentation with use of glucose and sucrose by mutant Mut189. Except glucose and sucrose although Mut189 showed pigment with other studied carbohydrates as compared to parent pigmentation was low.



Arabinose



Xylose



Glucose



Fructose



Glycerol



Galactose



Maltose

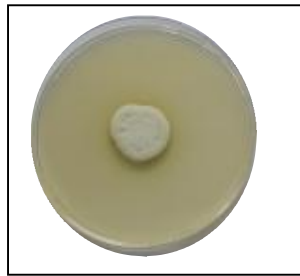

Sucrose



Mannose



Raffinose

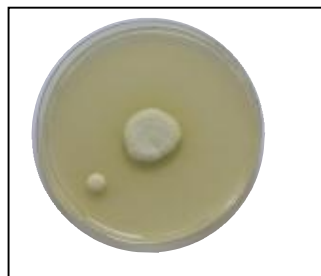

Rhamnose

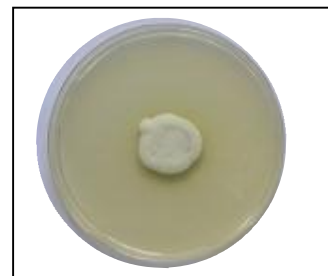

Sorbitol



Cellobiose



Starch

Figure 3.17a Carbohydrate utilization by *F. fujikuroi* NCIM1019

Chapter 3

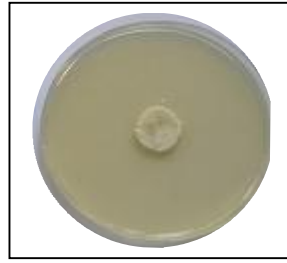

Arabinose

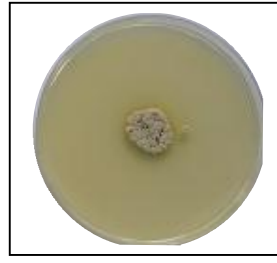

Xylose

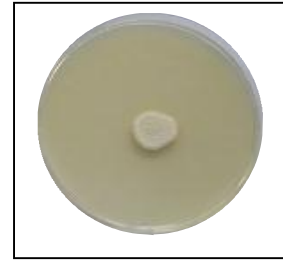

Glucose



Fructose



Glycerol



Galactose



Maltose



Sucrose



Mannose



Raffinose



Rhamnose



Sorbitol



Cellobiose



Starch

Figure 3.17b Carbohydrate utilization by Mutant Mut189

3.3.10 Protoplast fusion

3.3.10.1 Optimization of protoplast formation

The physiological age of the culture markedly influences protoplast yield (Peberdy, 1979). In present study the culture age suitable for the release of maximum protoplasts for two types of cells was standardized by growing the Mut32, a mutant strain of *F. fujikuroi* and a yeast strain *Trichosporon cutaneum* NCIM 3352 for 24 h in PDB broth. The result depicted in Fig. 3.18 illustrate that the number of protoplasts increased with increase in age of both the cultures. In case of *T. cutaneum* NCIM 3352 number of protoplasts release was maximum (10×10^5) in 16 h old culture. While for fungal mutant culture Mut32, number of protoplasts reached a high count (7×10^7) at 18 h old culture indicating the optimum age of the culture. Further yield of protoplasts in both the cultures were declined with increasing age of the cultures. This indicated that older cells are more resistant to enzymatic hydrolysis.

In general, young cells from exponential cultures are readily converted to protoplasts but cells from stationary phase cultures are resistant to lysis (Peberdy, 1980; Okanishi *et al.*, 1974) and resistance developed rapidly in the transitional period from exponential to stationary phase (Deutch and Parry, 1974). In present study similar findings were obtained. The optimum age of the culture suitable for the formation of protoplasts was 16 h for *T. cutaneum* NCIM 3352 and 18 h for Mut32.

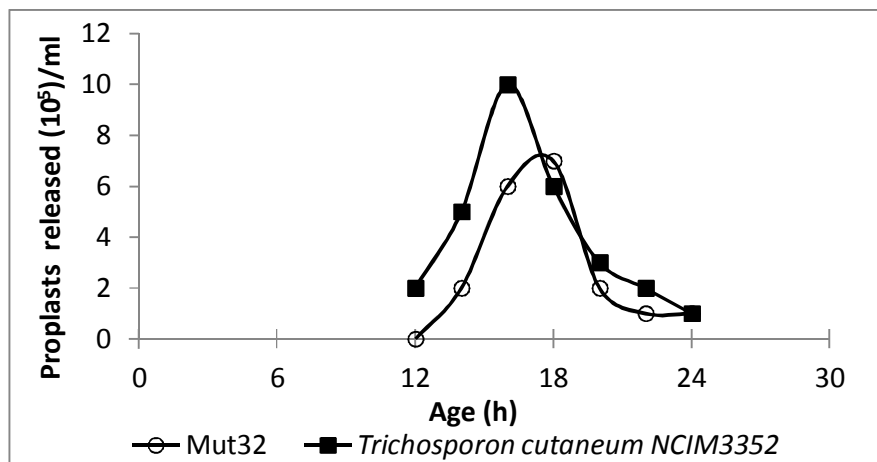

Figure 3.18 Effect of age of the mycelium on the release of protoplasts from *T. cutaneum* NCIM 3352 and Mut32

The isolation of protoplasts from fungi using lytic enzyme is now a well established technique. Novozyme234 was reported to be the most effective enzyme for high yields of protoplasts in fungi as well as for yeast (Hamlyn *et al.*, 1981). The protoplasts yield also significantly affected by the concentrations of lysing enzyme (Lalitikumari and Balasubramanian, 2008). In the present study to examine optimal concentration of lysing enzyme for the formation of protoplasts, 16 h old cells of *T. cutaneum* NCIM 3352 and 18 h old Mut32 mycelium were treated with different concentrations (2, 5, 10, 15 mg/l) of Novozyme234 and results presented in Fig. 3.19.

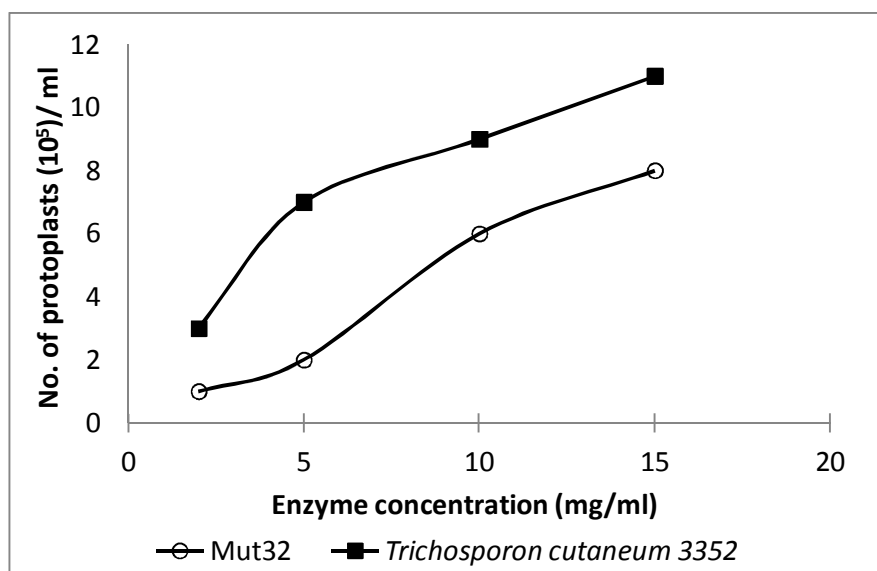

Figure 3.19 Effect of enzyme concentration on the release of protoplasts from *T. cutaneum* NCIM 3352 and Mut32

As shown in Fig. 3.19, for both cells the rate of protoplasts formation was increased with the increase of enzyme concentration indicating a better digestion of cell walls with more enzyme concentration. At high enzyme concentration of Novozyme234 (15 mg/ml) the fungal mycelium of Mut32 as well as *T. cutaneum* NCIM 3352 yeast cells lysed effectively yielding large numbers of protoplasts (11×10^5 and 8×10^5 respectively). But they get bursted immediately after release and disintegrated. Thus exposure to excessive Novozyme234 irreversibly destroyed the protoplasts. These results also suggest that the cell wall lysis depends on the concentration of used lytic enzyme Novozyme234.

Among different concentrations of lysing enzymes tested, Novozyme 234 at 10 mg/ml was found to be suitable for preparation of protoplasts and was decided to use the optimal concentration for further protoplast fusion experimental study.

Osmotic stabilizer plays an important role in the release and maintenance of protoplasts (Hocart *et al.*, 1987; Mukherjee and Sengupta, 1988). They protect the nascent protoplasts in different environments and support the protoplasts from being lysed. In present investigation four osmotic stabilizers were tested and result illustrated in Fig. 3.20

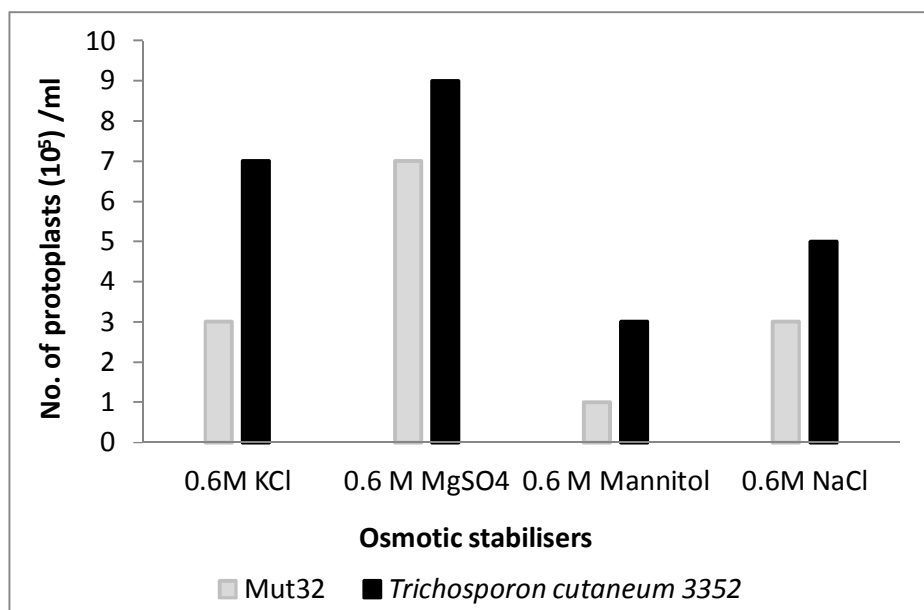

Figure 3.20 Effect of osmotic stabilisers on release the of protoplasts from *T. cutaneum* NCIM 3352 and Mut32

It can be seen from Fig. 3.20 that among the studied four different stabilizers, yield of protoplasts in the presence of 0.6 M Mannitol was low while maximum with 0.6 M MgSO₄. Maximum protoplasts from yeast *T. cutaneum* NCIM 3352 ($3 \times 10^8 \text{ ml}^{-1}$) and Mut32 mycelial cells ($4 \times 10^6 \text{ ml}^{-1}$) was obtained in presence of 0.6 M MgSO₄.

An extensive range of inorganic salts, sugars, and sugar alcohols have been successfully used to stabilize released protoplasts by the various researchers. There is no one universal stabilizer suitable to all. The type and concentration of stabilizer can influence yield and stability of protoplasts (Gokhale, 1992). In general inorganic salts have proved more effective with filamentous fungi while sugars or sugar alcohols are

more effective with yeasts. The present study indicated that MgSO_4 followed by KCl was suitable to isolate more protoplasts, whereas NaCl and organic stabilizer mannitol were not suitable for both the cultures since proplast formation started after the end of 2 h and low numbers of protoplasts were released. Thus the inorganic stabilizers supported protoplast formation of both the cultures.

The use of MgSO_4 as osmotic stabiliser has also been found more effective for protoplast isolation in other filamentous fungi (Deshpande *et al.*, 1987; Curragh *et al.*, 1992). The beneficial effect of Mg^{2+} for preventing lipid release from the plasmatic membrane has been speculated by Kavanagh and Whittaker (1991).

In the present study, it was also recorded that protoplasts released in the early hours (until 2-3h) of incubation were smaller in size and moderately uniform and large size protoplasts after prolong incubation. The maximal yield of protoplasts from both the cultures was obtained after 3 h incubation at 28 °C with gentle shaking at 100-120 rpm. 3 h incubation was optimum for maximum release of protoplasts as the numbers of protoplasts get decreased after 3h incubation due to busting and prolonged incubation caused the protoplasts to lyse (autolysis) also reported by (Lalitkumari and Balasubramanian, 2008).

3.3.10.2 Protoplast Fusion and Selection of fusant

When the protoplasts were mixed with PEG solution, they stuck together and pairs of protoplasts were observed seen under microscope. The protoplasts were attracted each other fused together. Although aggregation of more than two protoplasts was seen, fusion was observed between only two protoplasts. The fused protoplasts became larger in size and later spherical in shape. Selection of fusant was based on colony morphology and pigmentation. Regeneration was started after 2-3 days and colony development was observed after 4 days on RA agar media. After 9-10 days of incubation a regenerated colony looking like yeast with pigmentation was selected. The growth of selected fusant strain and parent strains exhibited variation in growth, pigmentation and morphology on solid and liquid media.

As shown in Fig. 3.21 on RA media Mut32 (parent fungus) was grown as a large, circular and cottony colony with irregular margin and pink pigmentation. Parent yeast *T. cutaneum* NCIM 3352 was grown as medium large, circular, rubbery, moist

colony with irregular margin and without pigmentation. While selected fusant was grown comparatively small, circular, soft colony with regular margin and pink pigmentation.



Parent fungus

Fusant

Parent yeast

Figure 3.21 Growth of parent fungus, parent yeast and suspected fusant on regeneration agar

Microscopic observations of these three cultures were given in Fig. 3.22. The mycelia of parent fungal culture Mut32 were long filamentous, branched with less thickness. Oval shaped yeast parent cells with few pseudomycelium were observed. While selected yeast like hybrid was with mixed morphology. Morphologically it was thin mycelia getting fragmented to oval shaped cells resembles similar morphology like parent yeast strain.

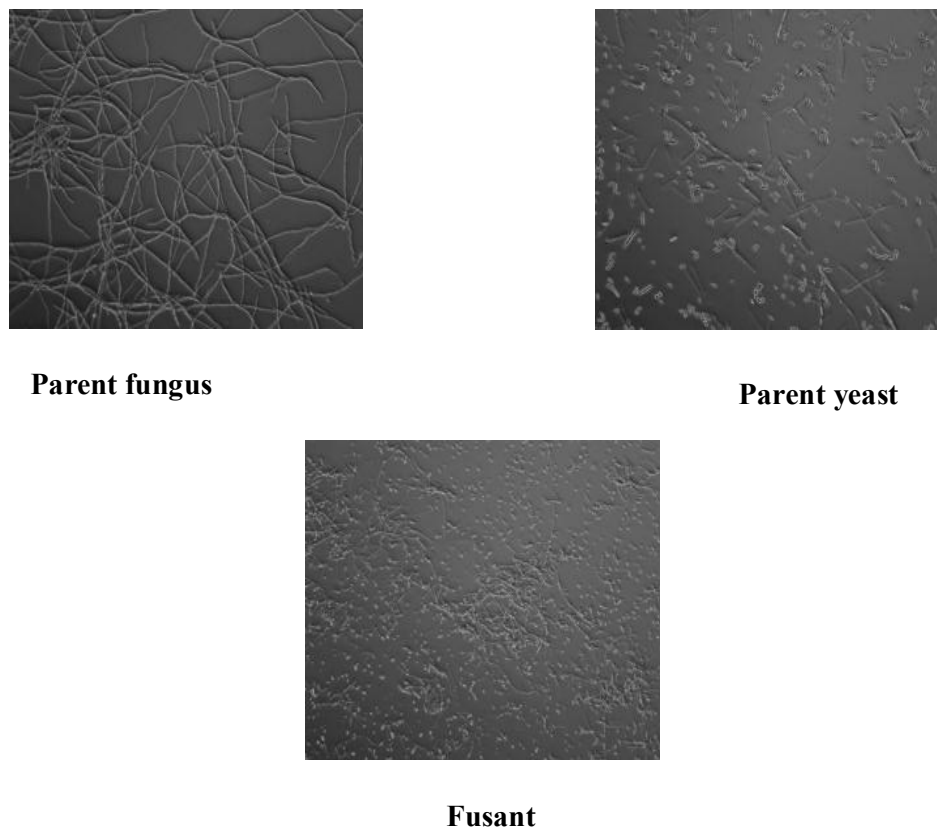
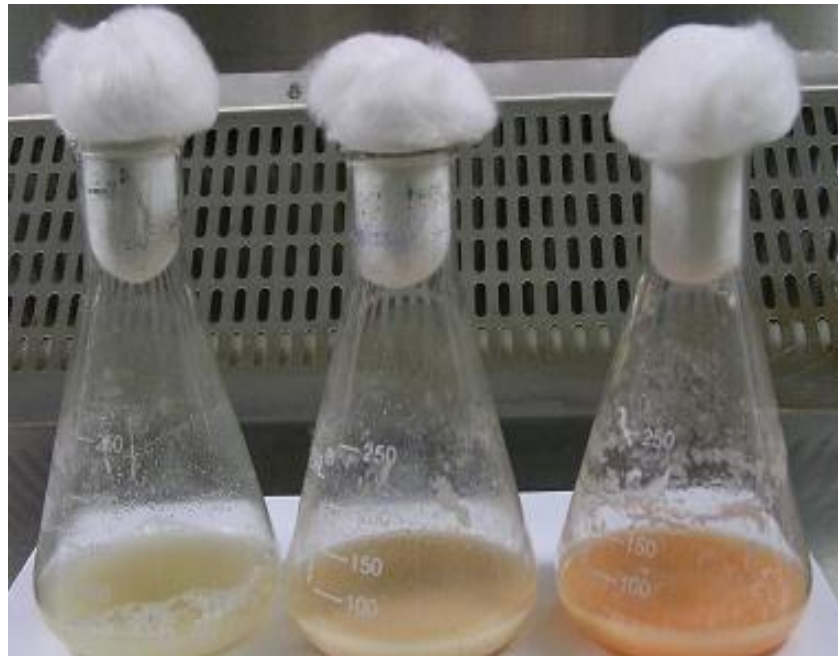

Figure 3.22 Micrographs of parent fungus, parent yeast and selected fusant

3.3.10.3 Production of GA₃ by Selected Fusant

The fusant was repeatedly selected during transfer and incubation period. The stable fusant was obtained after about 5 transfers for two months and was not reverted to their primary forms. The selected fusant was studied for GA₃ production in shake flask cultures. When fusant, parent fungus Mut32 and yeast *T. cutaneum* NCIM3352 were grown in 50 ml LMF in 250 ml flasks, they grew well and exhibited different growth characteristics from each other as discussed earlier. The liquid culture of Parent Mut32 was highly viscous. The apparent viscosity of liquid cultures of selected fusant was very low as compared to parent fungus Mut32. Parent fungus produced GA₃ (252 mg/l). Parent yeast did not produce GA₃. While selected yeast-like hybrid produced GA₃ (61 mg/l) and was confirmed by LC-MS. All fermentation tests were done with pure cultures. The cultures were periodically monitored for the presence of fungal contamination and none was found. Thus present invention successfully obtained yeast hybrid producing GA₃.



**Parent
Yeast**

**Yeast like
Fusant**

**Parent
Fungus**

Figure 3.23 Photograph of shake flask cultures of parent yeast, parent fungus and selected fusant

3.4 CONCLUSIONS

On screening *F. fujikuroi* strains from NCIM, *F. fujikuroi* 1019 that produced higher GA₃ concentration (76 mg/l) and showed highest specific GA₃ productivity (8.36 mg GA₃/g dry cell weight) was selected for further investigations. Studies on initial culture conditions illustrated that, glucose was the best carbon source for GA₃ production by *F. fujikuroi*. It could utilize a wide variety of inorganic and organic nitrogen sources studied for growth and GA₃ production. Among inorganic nitrogen source based media, ammonium compounds although helped growth, the production of gibberellic acid was rather low. In general, organic nitrogen sources were found to be superior for the growth and GA₃ production. Defatted soyabean meal was choice of nitrogen source for the growth and gibberellic acid production of *F. fujikuroi* strain. A suitable fermentation liquid medium was arrived at and used subsequently.

Filamentous nature of *F. fujikuroi* NCIM 1019 leads to excessive viscosity in the fermentation broth and demands higher agitation and aeration to maintain satisfactory levels of dissolved oxygen (DO₂). The expenditure on energy for aeration and agitation of such viscous broths is considerably high. GA₃ production was found to be mainly dependent on oxygen availability and also quality and quantity of nitrogen content in the medium.

The problems associated with *F. fujikuroi* filamentous fungus during fermentation such as viscosity, low oxygen availability can be overcome by using culture with modified morphology. From this point of view intergeneric protoplast fusion between protoplasts of *F. fujikuroi* mutant and yeast protoplasts was attempted.

Mutants of *F. fujikuroi* NCIM1019 were generated by UV irradiation and EMS treatment for desired improvement. In all, 1056 survived mutant colonies were developed through 38 mutagenesis series. Mutants were randomly selected based on their modified colony characteristics and with low or no pigmentation. Mutant colonies showed 10-15% improved GA₃ in tube level screening as compared to their respective parent culture were studied in shake flask cultures. Mut189 selected based on its distinct morphology. The colonies on regeneration agar plates were small, compact and dry. In liquid medium, mutant Mut189 grew in a micro-pelleted form. The mycelium was short, highly branched hyphae, curly at tips with thick, swollen cells. It grew rapidly in a medium containing defatted soyabean meal glucose and

salts. In media with higher nutrient concentrations as well as larger volumes it produced twofold more gibberellic acid than the parent. The mutant Mut189 did not produce soluble bikaverin or intracellular carotenoids to any considerable extent. The culture filtrate was clear and pale yellow. Such mutants that do not produce coloured by-products will be beneficial for the production of GA₃ because the efforts to remove such undesired compounds during purification of the product can be saved.

The yeast-like fusant obtained in this work was able to produce GA₃. The hybrid obtained could be exploited further for enhanced GA₃ production. Intergeneric protoplast fusion seems to be promising technique in strain improvement of *F. fujikuroi* for GA₃ production. This is the first report on an attempt for intergeneric protoplast fusion in *F. fujikuroi* for GA₃ production not reported earlier.

Thus present invention found that mutants with altered morphology resulted in higher GA₃ production. Growth of un-pigmented, morphological mutants of *F. fujikuroi* that led to lower viscosity in fermentation broth resulted in increased production of gibberellic acid. The use of morphological mutants that have lower viscosity in liquid cultures for gibberellic acid production is not reported earlier. Similar mutants can be useful for other types of fungal fermentations also.

3.5 REFERENCES

- Adrio, J., Demain, A. 2006. Genetic improvement of processes yielding microbial products. *FEMS microbiology reviews*, **30**(2), 187-214.
- Al-Masry, W.A., Dukkan, A.R. 1998. Hydrodynamics and mass transfer studies in a pilot-plant airlift reactor: non-Newtonian systems. *Industrial and Engineering Chemistry Research*, **37**, 41-48.
- Avalos, J., Cerda-Olmedo, E. 1987. Carotenoid mutants of *Gibberella fujikuroi*. *Current Genetics*, **11**, 505-511.
- Avalos, J., Cerda-Olmedo, E., Domenech C.E., Fernandez-Martin, R., Reyes, F., Cabrera E., Bramley, P.M., Barrero, A.F. 1995. Gibberellin biosynthesis in gib mutants of *Gibberella fujikuroi*. *Journal of Biological Chemistry*, **270** (25), 14970-14974.
- Avalos, J., Fernandez-Martin R., Prado M.M., Cerda-Olmedo, E. 1999. Gibberellin biosynthesis in *Gibberella*. *Acta Botanica Gallica : Botany Letters*, **146**, 55-65.
- Bearder, J. R., MacMillan, J., Wels, C. M., Chaffey, M. B., Phinney, B. O. 1974. Position of the metabolic block for gibberellins biosynthesis in mutant B1-41a of *Gibberella fujikuroi*. *Phytochemistry*, **13**, 911-917.
- Bearder, J.R. 1983. In vivo diterpenoid biosynthesis in *Gibberella fujikuroi*: the pathway after ent-kaurene. In: The biochemistry and physiology of gibberellins. Crozier A Ed. Praeger, New York.
- Berdy, J. 2005. Bioactive microbial metabolites a personal view. *Journal of Antibiotics* **58**, 1-26.
- Borrow, A., Brown, S., Jeffreys, E.G., Kessell, R.H.J., Lloyd, P.B., Rothwell, A., Swait, J.C. 1964. The kinetics of metabolism of *Gibberella fujikuroi* in stirred culture. *Canadian Journal of Microbiology*, **10**, 407-444.
- Bruckner, B., Blechschmidt, D. 1991. The gibberellin fermentation. *Critical Reviews in Biotechnology*, **11**, 163-192.
- Candau, R., Avalos, J. Cerda-Olmedo, E. 1991. Gibberellins and carotenoids in the wild type and mutants of *Gibberella fujikuroi*. *Applied and Environmental Microbiology*, **57**, 3378-3382.

- Currangh, H. J., Mooibroek, H., Wessels J.G.H., Marchant, R., Mullan, E. 1992. Protoplast formation and DNA mediated transformation of *Fusarium culmorum* to hygromycin B resistance. *Mycological Research*, **97**, 313-317.
- Darken, M.A., Jensen A.L., Shu, P. 1959. Production of gibberellic acid by fermentation. *Applied Microbiology*, **7**, 301-303.
- Demain, A.L., Fang, A. 2000. The natural functions of secondary metabolites. In: *Advances in Biochemical Engineering/Biotechnology: History of Modern Biotechnology Volume I*, **69**, 2-39, Fietcher A Ed. Berlin: Springer.
- Demain, A.L., Adrio, J.L. 2008. Strain improvement for production of pharmaceuticals and other microbial metabolites by fermentation. *Natural Compounds as Drugs Volume I*, 251-289.
- Deshpande, M.V., Balkrishnan, H., Ranjekar, P. K., Shankar, V. 1987. Isolation and immobilization of *Sclerotium rolfsii* protoplasts. *Biotechnology Letters*, **9**, 49-52.
- Deutch, C. E., Parry, J.M. 1974. Sphaeroplast formation in yeast during the transition from exponential phase to stationary phase. *Journal of General Microbiology*, **80**, 259-268
- Elander, R.P. 2003. Industrial production of β -lactam antibiotics. *Applied Microbiology and Biotechnology*, **61**, (5-6), 385-392.
- Erokhina, L. I., Efremov, B. D. 1970. Biochemical mutants of *Fusarium moniliforme* (Sheld). *Genetika*, **6**, 170-172.
- Ferenczy, L., Pesti, M. 1982. Transfer of isolated nuclei into protoplasts of *Saccharomyces cerevisiae*. *Current Microbiology*, **7**, 157-160.
- Fuska, J., Khur, I., Podojil, M., Sevcik, V. 1961. The influence of the nitrogen source on the production gibberellic acid in submerged cultivation of *Gibberella fujikuroi* *Folia Microbiology*, **6**, 18-21.
- Gancheva, V., Dimova, T.S., Kamenov, K., Foutekova, M. 1984. Biosynthesis of gibberellins III. Optimization of nutrient medium for biosynthesis of gibberellins upon using mathematical methods for planning the experiments. *Acta Microbiologica Bulgarica*, **14**, 80-84.
- Giordano, W., Domenech, C.E. 1999. Aeration affects acetate destination in *Gibberella fujikuroi*. *FEMS Microbiology Letters*, **180**, 111-116.

- Giordano, W., Avalos, J., Cerda-Olmedo, E., Domenech, C.E. 1999. Nitrogen availability and production of bikaverin and gibberellins in *Gibberella fujikuroi*. *FEMS Microbiology Letters*, **173**, 389-393.
- Gohlwar, C.S., Sethi, R.P., Marwaha, S.S., Sehgal, V.K. 1984. Gibberellic acid biosynthesis from whey and simulation of cultural parameters. *Enzyme and Microbial Technology*, **6**, 312-316.
- Gokhale, D.V. 1992. Fungal protoplast fusion-A tool for breeding industrial strains. *Journal of Scientific and Industrial Research*, **51**, 497-506.
- Gonzalez, P.C., Delgado, G., Antigua, M., Rodriguez, J., Larralde, P., Viniegra, G., Pozo, L., Perez, M.del C. 1994. Some aspects of *Gibberella fujikuroi* culture concerning gibberellic acid production. *Advances in Bioprocess Engineering*, 425-430.
- Hamlyn, R., Paul, F., Bradshaw, E., Mellon, F.M., Santiago, C.M., Wilson, J.M., Peberdy, J. 1981. Efficient protoplast isolation from fungi using commercial enzymes. *Enzyme and Microbial Technology*, 321-325.
- Hersbach, G.J.M., van der Beck, C.P., van Dijck, P.W.M. 1984. The penicillins: properties, biosynthesis, and fermentation. In: *Biotechnology of Industrial Antibiotics*. EJ Vandamme Ed. Marcel Dekker, New York, 45-140.
- Hocart, M.J., Lucas, J.A., Peberdy, J. F. 1987. Production and regeneration of protoplasts from *Pseudocercospora herpotrichoides* (Fron) Deighton. *Journal of Phytopathology*, **119** (3), 193-205.
- Kavanagh, H.S., Whittaker, P.A. 1991. Effect of buffer viscosity on rate of protoplast formation in yeasts. *Biomedical Letters*, **46**, 57-62.
- Keller, U. 1983. Highly efficient mutagenesis of *Claviceps purpurea* by using protoplasts. *Applied and Environmental Microbiology*, **46**, 580-584.
- Khalaf, M.A., Samir, M.A., 2009. Biosynthesis of gibberellic acid from milk permeate in repeated batch operation by a mutant *Fusarium moniliforme* cells immobilized on loofa sponge. *Bioresource Technology*, **100**, 374-379.
- Kjaer, D., Kjaer, A., Pedersen, C., Bu'Lock, J.D., Smith, J.R. 1971. Bikaverin and norvikaverin, benzoxanthrone pigments of *Gibberella fujikuroi*. *Journal of Chemical Society, (C)*, 2792-2797.
- Lalithakumari, D. 2000. Fungal protoplasts- a biotechnological tool. India: Oxford & IBH Publishing Company Private Limited, New Delhi.

- Lalithakumari, D., Balasubramanian, N. 2008. Characteristics of protoplast inter, intra-fusant and regeneration of antagonistic fungi *Trichoderma harzianum* and *Trichoderma viride*. *African Journal of Biotechnology*, Volume 7, **18**, 3235-3243.
- MacMillan, J. 2002. Occurrence of gibberellins in vascular plants, fungi, and bacteria. *Journal of Plant Growth Regulators*, **20**, 387-442.
- Mukherjee, M., Sengupta, S. 1988. Isolation and regeneration of protoplasts from *Termitomyces clypeatus*. *Canadian Journal of Microbiology*, **34**, 1330-1332.
- Mukerji, K.G., Arora, D.K., Elander, R.P. 1992. Handbook of applied mycology. *Fungal Biotechnology*, Volume 4. Marcel Dekker, New York.
- Parekh, S., Vinci, V.A., Strobel, R.J. 2000. Improvement of microbial strains and fermentation processes. *Applied Microbiology and Biotechnology*, **54**(3), 287-301.
- Parekh, S. 2009. Strain Improvement. *Encyclopedia of Microbiology* 3rd Ed. 286-298.
- Peberdy, J. F. 1979. Fungal protoplasts: isolation, reversion, and fusion. *Annual Reviews in Microbiology*, **33**, 21-39.
- Peberdy, J.F. 1980. Protoplast fusion- a tool for genetic manipulation and breeding in industrial microorganisms. *Enzyme and Microbial Technology*, **2**, 23-29.
- Podojil, M., Ricicoca, A. 1964. Influence of the soyameal fractions on gibberellic acid and gibberellins A production in submerged cultivation of *G. fujikuroi*. *Folia Microbiologica*, **10**, 55-59.
- Podojil, M., Blumauerova, M., Culik, K., Vanek, Z. 1984. The tetracyclines: properties, biosynthesis and fermentation. In: *Biotechnology of Industrial Antibiotics*. EJ Vandamme Ed. Marcel Dekker, New York, 259-279.
- Rademacher, W. 1997. Gibberellins. In: *Fungal Biochemistry*. Anke T Ed. Chapman & Hall, London, 193-205.
- Sanchez-Marroquin, A. 1963. Microbiological production of gibberellic acid in glucose media. *Applied Microbiology*, **11**, 523-528.
- Shukla, R., Srivastava, A.K. Chand, S. 2003. Bioprocess strategies and recovery processes in gibberellic acid fermentation. *Biotechnology and bioprocess engineering*, **8**, 269-278.
- Silva, E.M.E, Chavez-Parga, M.C., Gonzalez-Ortega, O., Negrete-Rodriguez, M.L.X., Medina-Torres, L. 2007. Hydrodynamics, mass transfer and

rheological studies of gibberellic acid production in an airlift bioreactor.

World Journal of Microbiology and Biotechnology, **23**, 6156623.

Spector, C., Phinney, B.O., 1966. Gibberellin production: genetic control in the fungus *Gibberella fujikuroi*. *Science*, **153**, 1397-1398.

Tudzynski, B. 1999. Biosynthesis of gibberellins in *Gibberella fujikuroi*: biomolecular aspects. *Applied Microbiology and Biotechnology*, **52**, 298-310.

Tudzynski, B., Malonek, S., Christiane, B., Bornberg-Bauer, E., Rojas M. C., Hedden, P., Hopkins, P. 2005. Distribution of gibberellin biosynthetic genes and gibberellin production in the *Gibberella fujikuroi* species complex. *Phytochemistry*, **66**, 1296-1311.

Okanishi, M., Suzuki, K., Umezawa, H. 1974. Formation and reversion of Strptomycete protoplasts: cultural condition and morphological study. *Journal of General Microbiology*, **80**, 389-400.

Vinci, V.A., Byng, G. 1999. Strain improvement by nonrecombinant methods. In: *Manual of Industrial Microbiology and Biotechnology*. 2nd Ed. ASM Press, Washington, DC, 103-113.

Chapter 4

Gibberellin A₃ Production

Abstract:

This chapter describes a) optimization of medium components and culture conditions for *Fusarium fujikuroi* mutant Mut189 in shake flask cultures b) Evaluation of optimized medium in laboratory fermenter and c) purification and characterization of GA₃ from the fermentation broth.

The selected mutant strain of *F. fujikuroi* Mut189 has short mycelial filaments and grew rapidly in the fermentation medium. The fermentation broth had lower apparent viscosity. Optimization of medium components and culture conditions for the mutant Mut189 was carried out in shake flask by one factor at a time. Among the culture conditions tested in batch fermentation, dissolved oxygen was the key factor affecting GA₃ production. It was found that the higher DO₂ level is required for effective GA₃ production. Controlled glucose feed was necessary to maintain high DO₂ level and to avoid catabolite repression during fermentation. Use of optimized medium and control of DO₂ concentration around 70-80% of air saturation by fed-batch mode resulted in substantial increase in GA₃ concentration to 1440 g/l. The extraction process, in which solid phase extraction was used, resulted in production of crystalline GA₃ with above 93% purity.

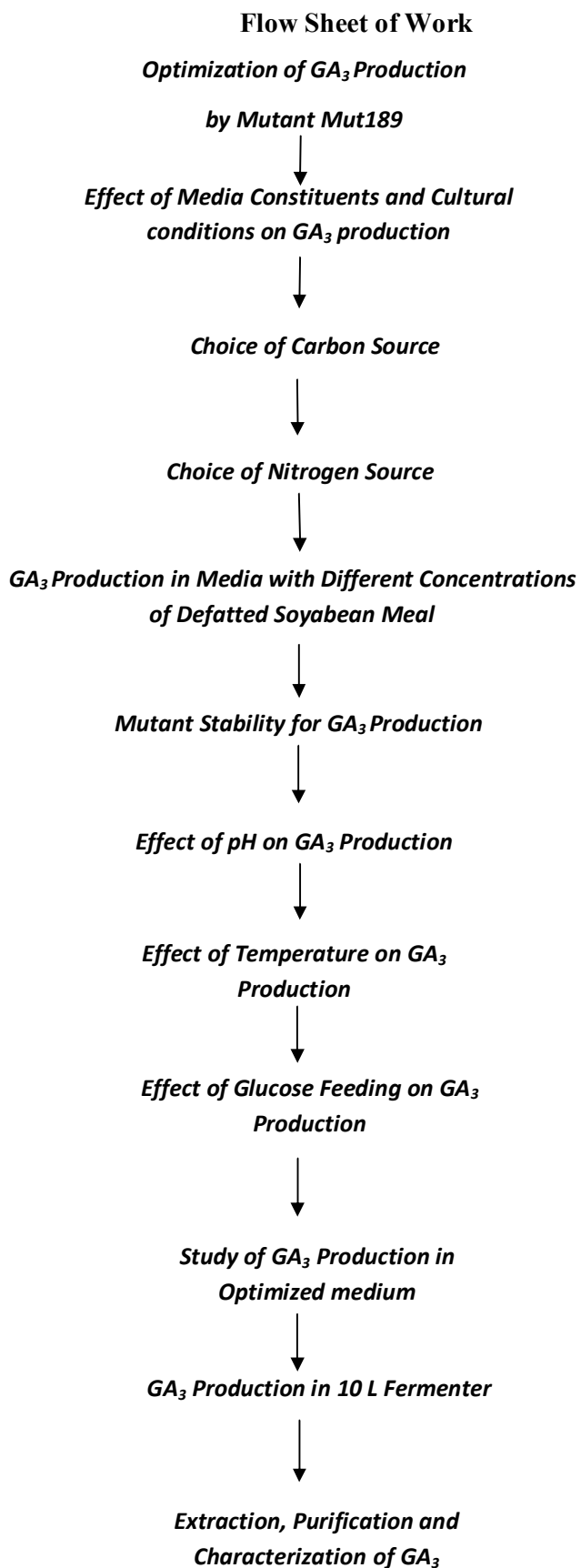

4.1 INTRODUCTION

In the previous chapter, selection of GA₃ producing *F. fujikuroi* strain and media constituents for its GA₃ production followed by strain improvement and selection of enhanced GA₃ producing mutant was presented. Glucose and defatted plant meal were identified as suitable medium components for GA₃ production. Growth of unpigmented, morphologically altered mutants of *F. fujikuroi* that led to lower viscosity in fermentation broth resulted in increased production of gibberellic acid. It was found that GA₃ production using *F. fujikuroi* NCIM1019 and its mutants Mut189 were strongly influenced by medium composition and oxygen availability. Hence it was necessary to optimize media and process parameters in shake flask cultures and their evaluation in a laboratory fermenter where control of process variables is possible. Since larger samples can be taken from laboratory fermenter, growth and production can be better analyzed.

Apart from strain selection and its improvement by chemical and physical mutagenesis, different studies have been carried out by earlier investigators, to increase GA₃ yield and also minimize its production and extraction cost using several approaches such as screening of fungi, optimization of the nutrients and cultural conditions, use of agro industrial residues as substrate, development of new processes based on immobilization cells and by fed-batch cultures fermentation. Chemical synthesis (Corey *et al.*, 1978) and extraction of gibberellins from plant (Kende, 1967) was reported but these methods are not economically feasible. In earlier years, for production of GA₃, liquid surface fermentation was employed and continued till 1955. Surface cultures offer advantage of low energy requirement, absence of mechanical damage to the fungal mycelium due to agitation as compared to submerged fermentation. But due to disadvantages of surface fermentation like requirement of very large surface area, very low yield, prolonged incubation time and being prone to contamination, this technique was abandoned for GA₃ production and substituted by submerged fermentation (Kumar and Lonsane, 1989; Brucker and Blechschmidt, 1991).

In the patent literature, there have been claims that feeding precursor like mevalonic acid increased the concentration of GA₃ (Birch *et al.*, 1961). Holme and Zacharias

(1965) and Bu'Lock *et al.*, (1974) described the production of GA₃ in glycine-limited continuous culture. However, because of the low production rate and the long period of fermentation, the chemostat culture is of only theoretical importance.

Solid state fermentation has been investigated for production of GA₃ (Kumar and Lonsane, 1987; Pastrana *et al.*, 1995). In India, production of GAs was investigated in large-scale tray fermentors on solid substrates (Prema *et al.*, 1988). Although SSF technique has number of economic advantages in the production of GA₃ and utilization of agro industrial by-product, this fermentation technique has difficulty in controlling important parameters (temperature, water content of the medium), scale up of the production to an industrial level and maintaining aseptic culture conditions during the process (Robinson *et al.*, 2001). In recent time although use of immobilised cells of *F. fujikuroi*, has been reported, it encounters severe oxygen limitations and risk of strain mutation during continuous operations (Kumar and Lonsane, 1987; Nava-Saucedo *et al.*, 1989). These techniques therefore could not be practiced on a large scale and for a longer period.

The standard industrial fermentation for production of GA₃ until now is submerged fermentation under conditions of nitrogen limitation using genetically improved strains of *F. fujikuroi* (Tudzynski, 1999). Gibberellic acid is a typical secondary metabolite and its fermentative production can be distinguished and related to nutritional and environmental conditions operating in the fermenter. Borrow *et al.*, (1964) had extensively studied this process and established producing and non producing phases of gibberellins fermentation. The conventional lag phase in the nitrogen limited media which is undetectable as strain requires little or no adaptation. The balanced growth phase, in which growth is initially exponential, later becomes linear and gibberellin production does not take place in this phase. The following is storage phase in which accumulation of lipids leads to increase in dry cell weight. In this phase, gibberellin production begins and continues in the presence of available glucose. Next to this is maintenance phase operative between maximum mycelia formation and onset of terminal breakdown of mycelia components. This is the main gibberellin-producing phase and its continuation is important for industrial production. Finally, terminal phase sets in which is normally not allowable to occur

in fermentation and fermentation batch is terminated prior to the onset of this phase (Kumar and Lonsane, 1989; Brucker and Blechschmidt, 1991).

The submerged fermentation technique for the production of GA₃ is influenced by variety of physical (pH, temperature, aeration, agitation) and nutritional factors (carbon and nitrogen sources, C: N ratio *etc.*). Optimization of these factors is prerequisite for the enhanced GA₃ production and the development of commercial process (Kumar and Lonsane, 1989). Various researchers have optimized these factors for maximum production of GA₃. The effect of these parameters is mainly dependant on the strain employed. Incubation temperature between 25 °C and 34 °C is used for the growth and GA₃ production. The optimum temperature for growth is 30 °C -31 °C while the production of GA₃ was maximum at 29 °C. The pH values generally employed are in the range of 3.5-5.0. A good aeration of fermenter is essential for higher production of GA₃ as its biosynthesis involves many oxidative steps. Poor aeration rates in batch fermenters led to the introduction of fedbatch processes (Vass and Jeffereys, 1979).

Along with physical factors, nutrients in media also have significant impact on GA₃ biosynthesis. Besides nitrogen control, biosynthesis of gibberellins was indicated to be suppressed by high amount of glucose, which is the most commonly used carbon source for GA₃ production. The influence of C: N ratio is directly related to GA₃ production. The initial growth stage requires C: N ratio between 10:1 and 25:1. Besides carbon and nitrogen, magnesium, potassium, phosphate *etc.* are also needed for biosynthesis of secondary metabolites. But negligible information with respect to need of trace elements is available for microbial production of GA₃. Trace element requirement is often met by impurities in commercial media (Kumar and Lonsane, 1989; Brucker and Blechschmidt, 1991).

GA₃ levels reported in literature are significantly lower as reviewed by Kumar and Lonsane (1989). Sivakumar *et al.*, (2010) studied optimization of medium composition, especially the initial nitrogen and carbon concentrations, to increase GA₃ yield by *F. fujikuroi* SG2 isolated from bakanae diseased rice plant. They reported 1175 mg/l GA₃ in improved medium on 9th day of fermentation. It was reported that strain H-984 of *F. fujikuroi* when grown for 38 h in a shake flask and inoculated into a bioreactor with medium containing glucose 60 g/l, NH₄Cl 1 g/l, 3

g/l KH_2PO_4 , 1.5 g/l, 1 g/l MgSO_4 and 2.0 g/l rice flour, produced 1100 mg/l gibberellic acid (Silva *et al.*, 1999). It was suggested that like most of the organic acid fermentation, production of GA_3 is inhibited by itself (Hollmann *et al.*, 1995; Dockerill and Hanson, 1981). There is only one report of extractive fermentation in which solvent polyalkoxylate was used for extraction and thereby the yield of GA_3 could be increased to two fold as compared to conventional batch fermentation (Hollmann *et al.*, 1995).

Yield of GA_3 3.0 g/l was obtained from mussel processing waste by submerged fermentation (Pastrana *et al.*, 1993). Model based nutrient feeding strategies for improvement of GA_3 productivity showed improved product formation and productivity. A mathematical model was proposed for the first time for submerged cultivation to describe biomass growth, substrate consumption and product formation by Shukla *et al.*, (2005). They reported submerged cultivation of *F. fujikuroi* in a 3 l fermenter accumulated 12 g/l biomass in 50 h and 1 g/l GA_3 in 170 h cultivation. Shukla *et al.*, (2005) also developed an unstructured mathematical model based on batch kinetic data. By continuous feeding of both glucose and ammonium nitrate in the growth phase and only glucose feeding in the production phase, significant increase in biomass (29.4 g/l) and GA_3 production (1.68 g/l) in 100 h of cultivation time was reported. GA_3 produced in multiple fed-batch was reported to be 3.24 g/l as opposed to 1.8 g/l GA_3 in batch fermentation. The multiple fed-batch fermentation is a better option than batch fermentation as it reduces the non-productive downtime of the reactor for cleaning, refilling, sterilization, *etc.* (Shukla *et al.*, 2007). Highest yield reported in the literature is 5 g/l by submerged fermentation using a fed-batch cultivation mode under conditions of nitrogen limitation using genetically improved strain (BuøLock *et al.*, 1982).

Pseudomonas sp. isolated from wastes of processed olive has also been shown to produce GA_3 285 mg/l (Karakoc and Aksoz, 2006). The most significant GA_3 yield of 105 mg g^{-1} of moldy bran using *F. moniliforme* NCIM1100 and jatropha seed cake as a substrate in SSF was reported by Rangaswamy (2012). This is the first report on obtaining such high yields of GA_3 by any mode of fermentation. Besides SSF they also reported, 15 g/l yield of GA_3 in SmF which is about 3-fold higher than the highest yield reported in the literature by this mode. This is the first study reporting

such high yield of gibberellic acid and presenting a commercially viable production process using cheap substrates.

As described in chapter 3 in the present investigation, during mutagenesis programme of *F. fujikuroi* NCIM 1019 for improved gibberellic acid production, mutant Mut189 was selected as a morphological, non-pigmented and enhanced GA₃ producer as compared to parent. The objectives of the work described in the present chapter were to optimize medium constituents and culture conditions for the selected mutant Mut189 in shake flask cultures. Further, the objectives were to evaluate optimized medium in the laboratory fermentation 1) to develop fermentation strategy for effective GA₃ production and 2) to purify GA₃ from the fermentation broth and chemically characterize produced GA₃ in the fermentation broth.

4.2 MATERIAL AND METHODS

Medium ingredients, fungal strain and analytical methods used were the same as described in chapter 2 and 3 unless otherwise mentioned.

Defatted soyabean meal and cottonseed meal were purchased from Chandrasekhar Exports Pvt. Ltd. (Kolhapur, India) while defatted peanut meal was from local market. Silicone antifoam was procured from HICO, Khopoli. Liquid medium for fermentation (LMF) as described in chapter 3 was used for growth and GA₃ production by selected mutant Mut189. NPA-1 hydrophobic microporous matrix was purchased from Ion Exchange India, Mumbai.

4.2.1 Shake flask cultures

A small mycelial mat from fresh slant culture of Mut189 was suspended in 2 ml sterile physiological saline and teased with a straight inoculating wire and inoculated in 5 ml optimized liquid medium for fermentation (LMF) in 150 × 25 mm test tubes without rim. The tubes were incubated at 28 °C, 220 rpm, for 48 h. This 5 ml inoculum was aseptically transferred to 250 ml Erlenmeyer flasks containing 45 ml LMF. In place of glucose, other carbon sources were used at 60 g/l while in place of defatted soyabean meal alternative nitrogen sources were used on equal nitrogen basis. Carbon sources were autoclaved separately for all the experiments and later mixed with other media components. All shake flask experiments were performed in triplicate, with 250 ml Erlenmeyer flasks containing 50 ml fermentation broth

incubated at 28 °C, 220 rpm for 168 h, unless otherwise mentioned. At the end of the incubation period, final volume of the culture broth was adjusted to 50 ml by addition of sterile distilled water to compensate for evaporative loss of water during incubation. Care was taken that the shake flask cultures do not remain stationary, even for a few minutes, during sample withdrawal from the flasks.

4.2.2 Choice of carbon source for GA₃ production

Utilization of carbon sources namely glucose, sucrose, starch, glycerol and fructose was investigated for growth and GA₃ production by Mut189. Liquid medium for fermentation (LMF) containing different carbon sources were prepared with 9 g/l defatted soyabean meal as the nitrogen source. Separately autoclaved carbon sources were used on equal $\delta\text{C}\delta$ basis in different sets of flasks. The flasks were inoculated with 48 h seed culture grown in 5 ml liquid medium for fermentation with respective sugars. The flasks were incubated for 168 h at 28 °C, 220 rpm on rotary shaker. At the end of the incubation period, final volume of the culture broth was adjusted to 50 ml by addition of sterile distilled water. The culture broth was filtered over Whatman No 1 qualitative filter paper under vacuum. The filtrate was collected and stored. The cell mass residue was further washed with three volumes of distilled water, observed for pigmentation and used for dry cell weight (DCW) determination at 103 °C. The filtrate samples were analyzed for pH, residual sugars and GA₃ concentration by high performance liquid chromatography (HPLC) as described earlier in chapter 2.

4.2.3 Choice of nitrogen source for GA₃ production

The shake flask experiments were performed to evaluate the nitrogen sources that supported the maximum biomass growth and gibberellic acid production by mutant Mut189. The different nitrogen sources were used on equal $\delta\text{N}\delta$ basis and were added separately after sterilization. Nitrogen sources equivalent to 0.8 g/l $\delta\text{N}\delta$ were studied in the liquid medium for fermentation with glucose (24 g/l C) as carbon source. The effect of inorganic nitrogen sources *viz.* ammonium nitrate, ammonium sulphate, ammonium chloride and urea, as well as organic nitrogen sources *viz.* yeast extract, soya peptone, defatted cottonseed meal, defatted peanut meal and defatted soyabean meal were evaluated. The 45 ml media with respective nitrogen sources in 250 ml Erlenmeyer flasks were inoculated with 48 h grown, 5 ml respective seed

cultures. The flasks were incubated at 28 °C, 220 rpm for 168 h on rotary shaker. Samples were analyzed for pH, residual glucose, dry cell mass and GA₃ concentration as described previously.

4.2.4 Evaluation of growth and GA₃ production in media with different concentrations of defatted soyabean meal

On the basis of earlier study, a medium containing defatted soyabean meal as nitrogen and glucose as carbon source was designed and used. Effect of defatted soyabean meal concentration on growth and GA₃ production by *F. fujikuroi* mutant Mut189 was investigated. Different concentrations of defatted soyabean meal were studied to determine concentration of the meal that can result in highest GA₃ production rate. Study was carried out by inoculating the respective seed culture in media containing glucose 60 g/l and different quantities of defatted soyabean meal at 2, 4, 6, 8, 10, and 12 g/l in 250 ml Erlenmeyer flasks. The flasks were incubated; samples were withdrawn periodically and analyzed as described earlier.

4.2.5 Mutant stability for GA₃ production

Mutant Mut189 selected through the shake flask screening was studied for its constancy with respect to growth and GA₃ production.

Mutant stability was studied in the following way:

1. Fresh slants of maintenance agar medium were inoculated from the Mut189 culture. The slants were incubated at 28 °C for 4 days.
2. A reasonably equal quantity of mycelial mat from fresh slant culture of Mut189 was suspended in 2 ml sterile physiological saline and teased with a straight inoculating wire. It was then transferred to 5 ml LMF medium in 150 × 25 mm test tubes without rim and the tubes were incubated at 28 °C, 220 rpm for 48 h.
3. Simultaneously, a set of new maintenance agar slants were inoculated from Mut189 culture incubated at 28 °C for 4 days.

4. The liquid cultures in tubes were transferred to 45 ml LMF in 250 ml flasks and the flasks were incubated on shaker for 120 h. Samples were analyzed for dry cell weight, pH, residual glucose and GA₃ concentration.

The steps 1 to 4 were repeated five times thus giving stability through four repeats and four transfers and growth on maintenance agar. Non-uniformity was distinguished by change in GA₃ concentrations.

4.2.6 Time-course study of GA₃ production by Mut189 in optimized medium

Five ml seed cultures of mutant Mut189 were inoculated in 250 ml Erlenmeyer flasks with 45 ml optimized fermentation medium containing 9 g/l defatted soyabean meal and 60 g/l glucose as carbon source. The flasks were incubated at 28°C, 220 rpm for 168 h on rotary shaker. One flask was harvested every 24 h, the volume was corrected to 50 ml and samples were analyzed for dry cell weight, residual glucose, and GA₃ concentration using HPLC. Glucose uptake rate and GA₃ production rate were calculated.

4.2.7 Effect of control of pH on rate of GA₃ production

During the experiments described above, the rate of GA₃ production was found to be high in the beginning of stationary phase and declined as the age of culture progressed. During this period, pH of the broth also decreased to 2.5. Therefore to avoid possibility of decrease in GA₃ production due to decrease in pH the GA₃ production in shake flask was investigated by addition of 2 g/l calcium carbonate to the flask at the time of inoculation to avoid lowering of pH. Calcium carbonate powder was weighed in Erlenmeyer flask and autoclaved separately before addition of sterile liquid medium for fermentation. The shake flasks were incubated at 28°C, 220 rpm for 168 h on rotary shaker and samples were analyzed as described previously.

4.2.8 Effect of temperature on GA₃ production during stationary phase

Temperature of incubation may affect the growth and production of secondary metabolites in *F. fujikuroi* (Jefferys, 1970). The possible effect of shift of temperature on GA₃ production by Mut189 during stationary phase was studied. Five

ml seed cultures of mutant Mut189 were inoculated in 250 ml Erlenmeyer flasks with 45 ml optimized fermentation medium containing 9 g/l defatted soyabean meal and 60 g/l glucose as carbon source. The shake flask cultures of mutant Mut-189 were grown at 28 °C till 48 h. After 48 h one set of flasks was transferred to identical incubator shaker maintained at 23 °C for further incubation. A control set of flasks was maintained at 28 °C throughout the experiment. At the end 168 h incubation, volumes were corrected to 50 ml and samples were analyzed for dry cell weight, residual glucose, and GA₃ concentration using HPLC.

4.2.9 Effect of glucose feeding on GA₃ production

In an effort to maintain the high rate of GA₃ production for longer time, glucose feeding at regular interval was investigated. Sterile glucose solution was added to the shake flasks in different quantities (5, 7.5, 10, 12.5, 15 g/l for every 24 h) to avoid presence of excessive glucose and possible catabolite repression. Mut189 seed culture was inoculated in 50 ml LMF with initial glucose concentration of 20 g/l. The flask cultures were fed with 3 ml sterile concentrated (500 g/l) glucose solution, at 24 h interval, to achieve final glucose concentrations of 5, 7.5, 10, 12.5, 15 g/l d. In control flasks, all the desired glucose (30, 45, 60, 75, and 90 g/l) was added initially. Samples were withdrawn at interval of 24 h and analyzed for dry cell weight, sugar utilized and GA₃ concentrations using HPLC.

4.2.10 Evaluation of mutant Mut189 for GA₃ production in 14 L fermenter

All the fermentation experiments were performed in 14 L laboratory fermenter (New Brunswick Scientific, Bio-flow 110 USA) with a working volume of 10 L, equipped with devices for control and measurement of pH, temperature, dissolved oxygen and agitation speed.



Figure 4.1 Fermenter set up for GA₃ production

Temperature of the fermenter was maintained automatically at 28 °C by heating or by circulating chilled water. The pH of the medium was initially adjusted to 6.8 with 5 N NaOH. The DO₂ was measured with a dissolved oxygen probe (Mettler Toledo). The aeration rate was set at 0.5 volume per volume per minute (VVM) and agitation speed was adjusted between 300-700 rpm. On-line fermentation data of process parameters such as DO₂, pH, agitation and feeding strategy were acquired using NBS BioCommand Plus Software.

4.2.10.1 Batch fermentation for GA₃ production

A series of fermentation batches were carried out with the mutant Mut189 to evaluate fermentation conditions for GA₃ production in LMF medium. In order to initiate inoculum, a small mycelial mat of Mut189 from fresh slant culture was suspended in 2 ml sterile physiological saline, teased with a straight inoculating wire and inoculated into 5 ml liquid fermentation medium in 150 × 25 mm test tubes and the tubes were incubated at 28 °C, 220 rpm, for 48 h. This 5 ml seed culture was transferred into a 250 ml Erlenmeyer flask containing 45 ml LMF and incubated at 28 °C for 48 h. Twenty two such flasks, each with 45 ml LMF, were prepared and inoculated to produce inoculum necessary for inoculation of the 14 L fermenter. One

litre (10% v/v) of the above seed culture, grown in multiple flasks was then transferred into the fermenter aseptically.

For all the fermentation batches, defatted soyabean meal and salts was autoclaved in the fermenter. Concentrated (500 g/l) glucose solution was autoclaved separately in flask and later transferred to the fermenter aseptically. The DO₂ probe was polarized for at least four hours before calibration and fermenter inoculation. The DO₂ probe was calibrated between 0 and 100% air saturation. Zero was adjusted electronically by disconnecting the cable for 30 seconds, followed by saturating the medium with air by sparging air at 0.5 vvm and 700 rpm. This point was set as 100% air saturation. The fermentation batches were started by addition of 48 h grown inoculum. The foam formation was controlled by periodic addition of silicon antifoam. DO₂ was controlled at 50% air saturation using the DO₂ controller. Samples were analyzed at successive intervals for dry cell weight, pH, DO₂, residual glucose and GA₃ production.

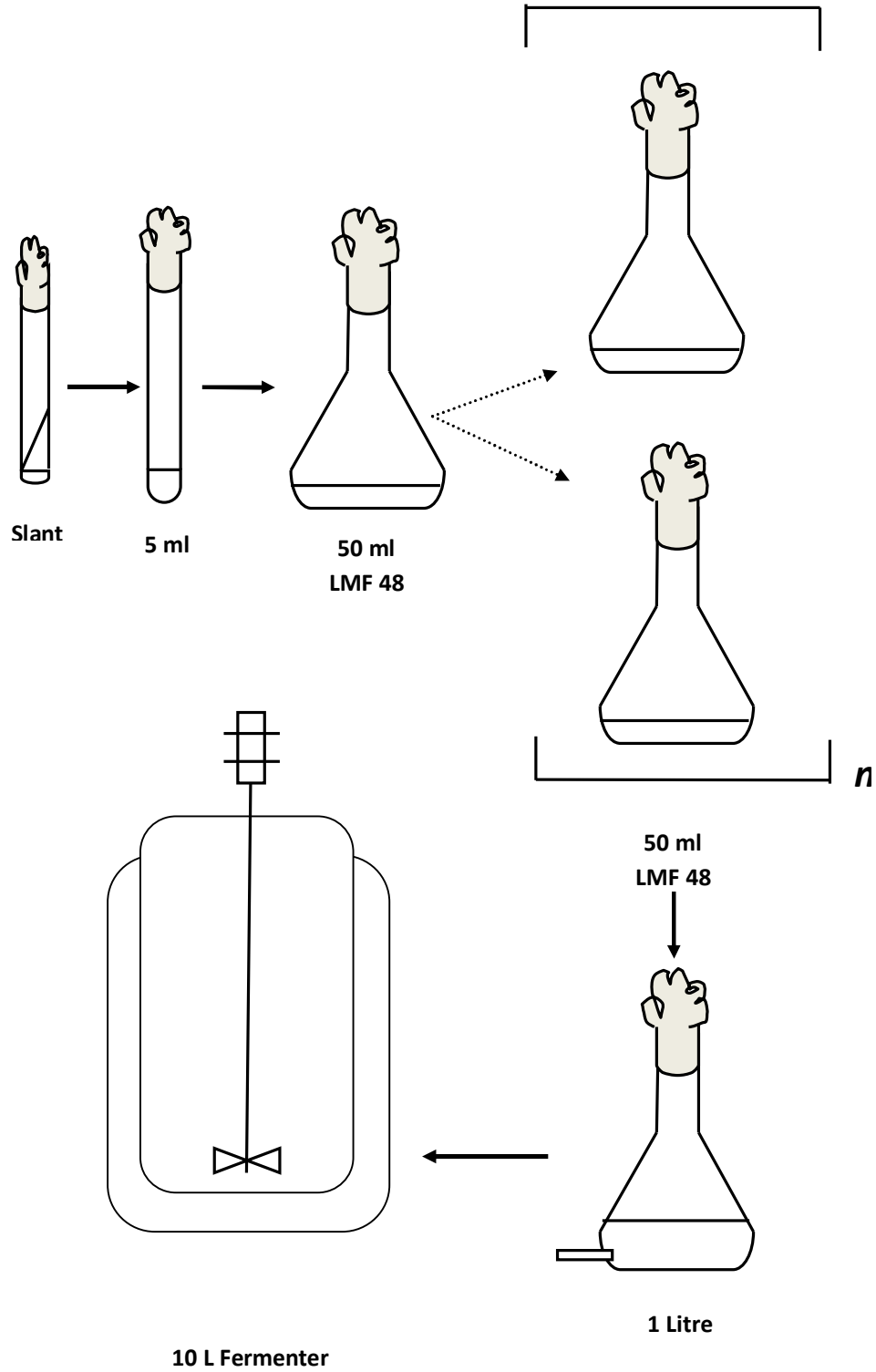

Figure 4.2 Schematic representation of inoculum preparation for 10 L laboratory fermenter

4.2.10.2 Extractive fermentation

On the basis of earlier shake flask study and while evaluating mutant in the fermenter it was observed that the rate of gibberellic acid production declines after reaching a peak at about 72 h. This decrease in the rate of GA₃ production could have been due to feed-back inhibition caused by accumulation of gibberellic acid (GA₃) in fermentation broth. To study the possible feed-back inhibition, extractive fermentation using a membrane-bioreactor was performed to maintain concentration of GA₃ within 350-400 mg/l range in 72-84 h.

A 14 L batch fermenter was initiated in the similar manner as described above and continued for a period of 40 h. A sterile 0.1 µm cross-flow membrane assembly was connected to the fermenter and the broth was subjected to tangential microfiltration through the membrane unit continuously to collect 7.5 L permeate per day (312 ml/h). A fresh medium containing half strength of the nutrients, without sugar and plant meal, was pumped into the fermenter to compensate the volume displaced. A concentrated, sterile glucose solution was fed to the fermenter directly proportionate with the prevailing sugar uptake rate of about 1 g/l/h during the stationary phase. A single core, ceramic membrane (Carbosep, France) was used to minimize the shear during microfiltration. The batch was continued for a total period of 157 h and a total of 30 L permeate was collected during the batch.

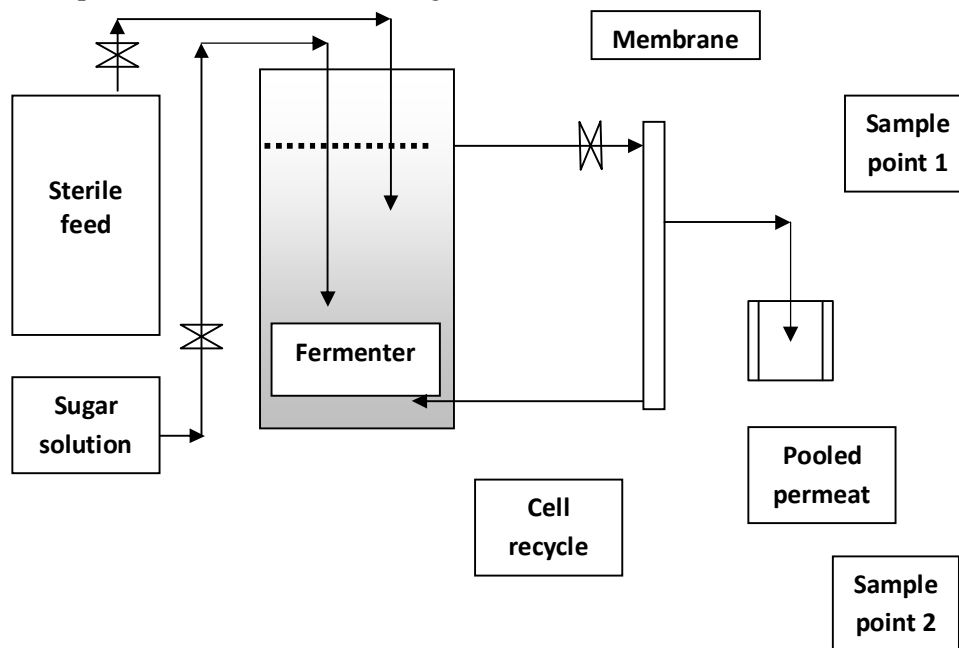

Figure 4.3 Schematic representation of Extractive Fermentation

Permeate samples were withdrawn on-line as well as from the permeate pooled for 24 h, coming out of the membrane unit and stored at 5 °C. The samples were analyzed for GA₃, pH and residual sugar.

4.2.10.3 Repeated batch fermentation

A fermenter batch similar to above in 4.2.3 was initiated. Samples were analyzed for GA₃ concentration during the batch time of 96 h. When the GA₃ concentration reached above 350 mg/l, 7.5 L of the fermented broth was rapidly withdrawn leaving 2.5 L broth behind in the fermenter. The fermenter was filled up with 7.5 L fresh, sterile LMF medium and allowed to proceed as second batch. The fermentation was monitored till the GA₃ concentration reached beyond 350 mg/l and again the withdraw-feed was repeated. Two sets of four repeated fed-batch runs were performed for verification of the concept.

4.2.10.4 Fed-batch fermentation for GA₃ production

In order to enhance GA₃ yield and productivity, fed-batch fermentation experiments were performed using optimized fermentation medium with Mut189 mutant strain. For all fed-batch experiments, 20 g/l glucose along with the remaining media components was used during the initial growth phase. A suitable feeding strategy is an important activity in fed-batch fermentation because nutrient feeding strategy determines cell growth and product formation. Fed-batch fermentation was performed in the 14 L fermenter under the same conditions as the batch fermentation. Experiments were aimed towards optimization of nutrient feeding strategy, particularly glucose feed rate, to avoid excess carbon and to maintain higher GA₃ productivity throughout fermentation. Feed solution consisted of glucose solution (500 g/l) was used.

Data analysis of shake flask experiments hypothesized that GA₃ production is mainly dependent on DO₂ concentration and not on the residual glucose during the production phase. To confirm this hypothesis in fed-batch run, feeding rate of glucose solution was controlled. The initial volume of the culture broth for all the experiments was 8 L which increased to 10 L on feeding glucose solution towards the end of fermentation. Agitation rates were adjusted during the course of fermentation depending upon the DO₂ profile.

For the fed-batch experiments F1 and F2, glucose was fed at the rate of 5 and 10 g/l/d respectively. DO₂ was controlled at 70-80% air saturation. The addition of feed solution was started on the onset of stationary phase, based on analysis of residual glucose and GA₃ production by HPLC. High agitation rate of 600-700 rpm was maintained during growth phase to avoid DO₂ limitation. After the growth phase of 24 h, agitation rate was reduced from 700 rpm to 500 rpm gradually. During the production phase it was adjusted depending upon the DO₂ profile.

4.2.11 Purification and characterization of GA₃ from the fermentation broth

The process of gibberellic acid extraction from the fermentation broth studied was based on adsorption of the gibberellic acid on polystyrene DVB NPA1 resin, a hydrophobic polymeric micro-porous matrix under acidic environment (Moghe *et al.*, 2001). The conditioning of resins before use was done as follows. First, resins were washed with distilled water and wetted in methanol for 2 h. The resin was then transferred to water. It was then sonicated for 15 minutes and boiled in water bath for 30 minutes for degassing. Finally, the resin was washed with water for three times by keeping on a shaker at 100 rpm, 30 °C for 30 minutes each.

Fed-batch fermentation experiment as described earlier was performed till all the residual glucose was consumed. The culture broth was filtered under vacuum to obtain fermentation broth. 3.5 L of the filtrate was acidified to pH 2 by addition of formic acid (1ml l⁻¹) and the precipitate formed was removed by filtration again.

To 1 L NPA-1 matrix, conditioned as described above and taken into a stirred tank, 3.5 L GA₃ fermentation broth filtrate at 2.5 pH was added and agitated for 1 h, gently. This allowed the adsorption of the gibberellins and related hydrophobic compounds from the fermentation broth onto the hydrophobic matrix. After the binding phase, the filtrate was decanted off and 3 L distilled water, acidified with formic acid as above was added to the matrix. The unbound compounds were thus washed out with distilled water by three times washing the resin and the washings were discarded. The gibberellic acid adsorbed to the NPA1 matrix was eluted using methanol. Methanol-water solution containing the gibberellic acid and other related minor impurities was dried completely on rotary vacuum evaporator at 60 °C. The residue containing extracted GA₃ was re-dissolved in ethyl acetate for fractionation of gibberellic acid and other impurities. The ethyl acetate solution was warmed so as

to dissolve all the gibberellic acid and then concentrated a little and held at room temperature for crystallization. GA₃ crystals formed were removed by filtration and further treated with petroleum ether (40-60 fraction) and chloroform, subsequently, to remove impurities and pigments adhering to the gibberellic acid crystals, if any.

The gibberellic acid powder obtained was dried under vacuum at 45 °C to constant weight before storage in glass containers. The quality of gibberellic acid was analyzed using HPLC and further confirmed by melting point analysis, LC-MS and NMR spectroscopy as described in chapter 2.

Steps involved in extraction and purification of gibberellic acid are summarized in Fig. 4.4.

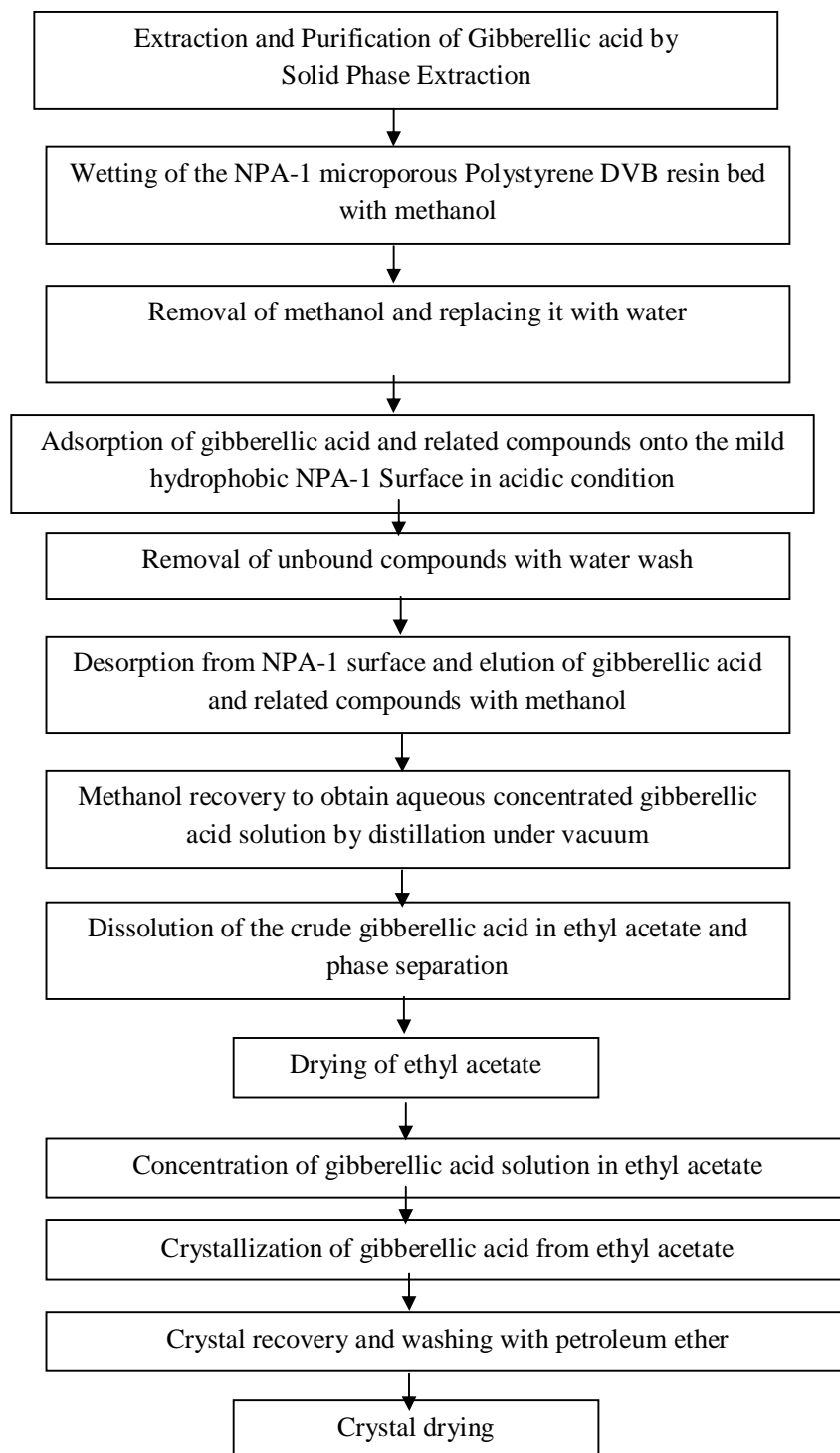

Figure 4.4 Steps involved in extraction and purification of gibberellic acid

4.3 RESULTS AND DISCUSSION

4.3.1 Choice of carbon source for GA₃ production

Mutant Mut189 utilized different carbon sources for its growth and GA₃ production. The result presented in Table 4.1 that irrespective of carbon source used, growth of Mut189 in terms of dry cell weight was almost similar. The cell mass ranged between 18.1 and 20.6 g/l with different carbon sources used. Morphologically, no distinct difference was observed. Also there was no pigment production by Mut189 with studied carbon sources. Table 4.1 also illustrates that glucose resulted in maximum production of GA₃ (411 mg/l). GA₃ production from glycerol (262 mg/l) was much lower compared to glucose. Mut189 produced almost similar quantity of GA₃ in liquid fermentation media containing sucrose and fructose as carbon source.

<i>Carbon source</i>	<i>Dry cell weight g/l</i>	<i>GA₃ mg/l</i>	<i>GA₃ mg/g DCW</i>
Glucose	18.54	411	22.17
Fructose	18.12	389	21.47
Sucrose	18.23	391	21.45
Soluble starch	20.16	330	16.37
Glycerol	20.66	262	12.68

Table 4.1 Effect of different carbon sources on GA₃ production by mutant Mut189

Gallazo and Lee (2001) reported that along with glucose, soluble starch was added as carbon source to prolong production phase of GA₃ fermentation and achieve higher GA₃ yield. In present study, although GA₃ production by mutant Mut189 was influenced by the different carbon sources, there was no correlation observed between slowly utilizable and rapidly utilizable carbon sources. Bruckner and Blechschmidt (1991) reported that although carbohydrates such as different sugars, plant oils and industrial residues are reported to be suitable sources of utilizable carbon in culture media, glucose and sucrose seem to be the commonly used carbon sources in large-scale fermentations. In the biotechnological industry, feeding glucose seems to be preferred in order to avoid a late onset of GA₃ production and the accumulation of fat and carbohydrate in the mycelium which is wastage of nutrients (Vass and Jefferys, 1979).

In the present investigation using Mut189, GA₃ production (411 mg/l) and specific gibberellic acid productivity (22.17 GA₃/g dry cell weight) was relatively higher in glucose containing medium. These results were similar to the initial shake flask study for parent *F. fujikuroi* NCIM 1019 discussed in chapter 3. Thus, glucose was found to be the most suitable carbon source for GA₃ production by Mut189 and was used in subsequent experiments.

4.3.2 Choice of nitrogen source for GA₃ production

Apart from the carbon source, the quality and quantity of nitrogen in the media normally plays important role on the growth and GA₃ production. Nitrogen limitation is the prerequisite for GA₃ formation as it starts after the exhaustion of nitrogen source from the medium (Borrow *et al.*, 1964; Tudzynski, 1999). A range of nitrogen sources, inorganic (ammonium salts and nitrate) and organic (digests prepared from vegetable or animal proteins and complex defatted plant meals different amino acids) were tested in the present study. The extent of growth and GA₃ production by mutant Mut189 was found to differ according to the nitrogen source in the medium as presented in Table. 4.2.

It can be seen from Table 4.2 that in comparison with organic nitrogen sources, inorganic nitrogen sources gave rise to relatively lower cell growth and GA₃ production. The lower concentration of GA₃ produced in the medium with ammonium chloride, sulphate and phosphate may have been because of the lowering pH of the fermentation medium in shake flasks. In general, organic nitrogen sources are reported to be better for growth and GA₃ production (Darken *et al.*, 1959; Fuska *et al.*, 1961). In the present study also, all of the organic nitrogen sources investigated were good nitrogen sources for the growth of mutant Mut189 because the levels of biomass in terms of dry cell mass obtained were between 15-18 g/l. Among the screened organic nitrogen sources, digests prepared from vegetable or animal proteins like beef extract, liver extract, yeast extract, soya peptone and peptone were relatively favourable to the growth of Mut189 than GA₃ production as presented in (Table 4.2).

Earlier Rademacher (1997) had reported that plant extracts might contain precursors or inducers of the gibberellin biosynthesis pathway that enhance gibberellins

biosynthesis. In the present study, the maximum growth of Mut189 as well as GA₃ production was achieved when organic nitrogen sources, mainly three different defatted plant meals, were employed as nitrogen source. These plant meals yielded almost similar quantities of GA₃ under identical conditions (Table 4.2). However, the broth in which peanut meal and cottonseed meal were used as nitrogen source were colored because of the presence of pigment. The pigment formation is undesirable in GA₃ fermentation as it may interfere with extraction and purification of gibberellic acid (Shukla *et al.*, 2003). Defatted soyabean meal was therefore selected and used as nitrogen source for further study.

<i>Nitrogen sources</i>	<i>Dry cell weight g/l</i>	<i>GA₃ mg/l</i>	<i>GA₃ mg/DCW</i>
Ammonium sulphate	6.68	34	5.09
Ammonium chloride	7.92	45	5.68
Ammonium nitrate	9.85	74	7.51
Potassium nitrate	8.27	0	0
Urea	5.92	0	0
Beef extract	18.49	48	2.84
Caesin enzyme digest	14.88	168	11.29
Cottonseed meal	17.85	390	21.85
Liver extract	16.21	46	2.6
Meat peptone	11.98	52	4.34
Peptone	16.41	56	3.41
Peanut meal	17.43	332	19.06
Soyabean meal	18.49	412	22.28
Soya peptone	15.95	122	7.65
Yeast extract	16.1	66	4.1

Table 4.2 Effect of different nitrogen sources on GA₃ production by Mut189

4.3.3 Evaluation of growth and GA₃ production in media with different concentrations of defatted soyabean meal

With regard to the influence of the nitrogen source organic and inorganic nitrogen compounds were studied in equimolar quantities. It was found that from three different plant meals, soyabean meal gave the best results. Its effect at different

concentrations was therefore studied. Results presented in Fig. 4.5 indicate that with the increase in defatted soyabean meal concentration from 2 to 12 g/l, cell mass of Mut189 gradually increased. This is because of the increased cell mass with higher nitrogen source. GA₃ production, its specific productivity and glucose utilized was almost directly proportional to the increased meal concentration.

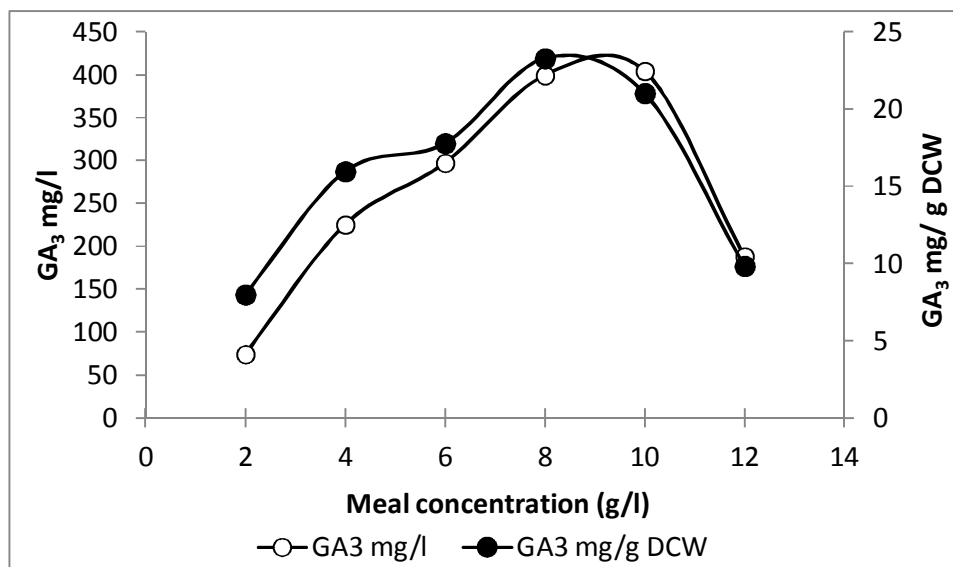

Figure 4.5 Effect of defatted soyabean meal on growth and GA₃ production

The quantity of defatted soyabean meal added to the fermentation medium had profound effect on production of gibberellic acid. With increase in meal concentration from 2 to 8 g/l in shake flask, the GA₃ concentration increased proportionally up to 399 mg/l. GA₃ concentration in 8 and 10 g/l meal was almost similar while it was reduced by 53 % in 12 g/l meal. Earlier researchers Giordano and Domenech (1999) described the level of aeration affecting the metabolism of *F. fujikuroi* during secondary metabolism. Under low-aeration conditions production of gibberellins reduced while this low aeration stimulated fatty acid and fusarin C synthesis. Similarly the thickening of broth tends to decrease oxygen transfer, and the resulting oxygen restriction drastically reduces gibberellin formation (Vass and Jefferys 1979). In the present investigation also, when meal concentration above 10 g/l was used, although all the sugar was consumed, GA₃ concentration and specific productivity were distinctly low. This is presumably due to the fact that at nutrient content beyond optimal, the broth would become oxygen limited. Thus higher cell mass could not be supported for GA₃ production. This would also be because of the

limitation of oxygen transfer capacity of the shake flask under this experimental set up (220 rpm, 28 °C, 50 ml volume in 250 ml Erlenmeyer flask). The experiments implied the need for careful control of the nitrogen concentration in the media so that linear proliferation occurs during the early production phase of GA₃, to reduce the storage of lipids, viscosity of the broth and increased dissolved oxygen concentration in the medium to obtain maximal GA₃ production.

4.3.4 Mutant stability for GA₃ production

Through the strain improvement program, shake flask screening and comparison of selected mutant strains, a morphologically altered mutant Mut189 was selected for enhanced GA₃ production as discussed earlier in chapter 3. The study of mutant stability was essential particularly due to the possible multi-cellular nature of the cell fragments used for mutant preparation during mutagenesis. To scrutinize this, mutant Mut189 was repeatedly transferred during growth and incubation period. In all 4 transfer cycles, Mut189 grew rapidly in LMF within 48 h of cultivation. Growth in terms of dry cell mass ranged between 17-18 g/l. Also morphologically it remained same as short, branched and thick mycelium exhibiting low viscosity in shake flask cultures. From first to fourth transfer cycles it was also observed that glucose was utilised completely during 168 h of fermentation in shake flask cultures. At the end of each cycle, production of gibberellic acid by the mutant Mut189 was similar as given in the Table 4.3. Strain maintained its ability to produce substantially more GA₃ as compared with the parent. The results presented in Table 4.3 show that selected mutant strain Mut189 did not lose its GA₃ production capacity during four transfers and growth on maintenance agar over a period of four weeks. Thus, the morphological mutant, Mut189, was stable and did not revert to its primary form.

<i>Transfer cycle</i>	<i>GA₃ mg/l</i>
First	398
Second	396
Third	399
Fourth	394

Table 4.3 Stability of mutant Mut189 during four transfers and culture in shake flasks

4.3.5 Time course study of GA₃ production by mutant Mut189 in optimized medium

On the basis of earlier experimentation, fermentation medium for GA₃ production by Mut189 was designed. LMF was formulated with glucose as carbon source and defatted soyabean meal as nitrogen source. Glucose was used at 60 g/l while meal concentration at 9 g/l in LMF for the growth and GA₃ production by a morphological mutant of *F. fujikuroi*, Mut189. Mut189 grew well in optimized fermentation medium. During first 48 h, growth in terms of dry cell mass increased rapidly and reached to 18.51 g/l towards the end of 48 h fermentation. It exhibited short, branched and thick mycelial morphology during the growth. Time course profile of GA₃ production by Mut189 in Erlenmeyer flask containing 50 ml optimized LMF medium is illustrated in Fig. 4.6.

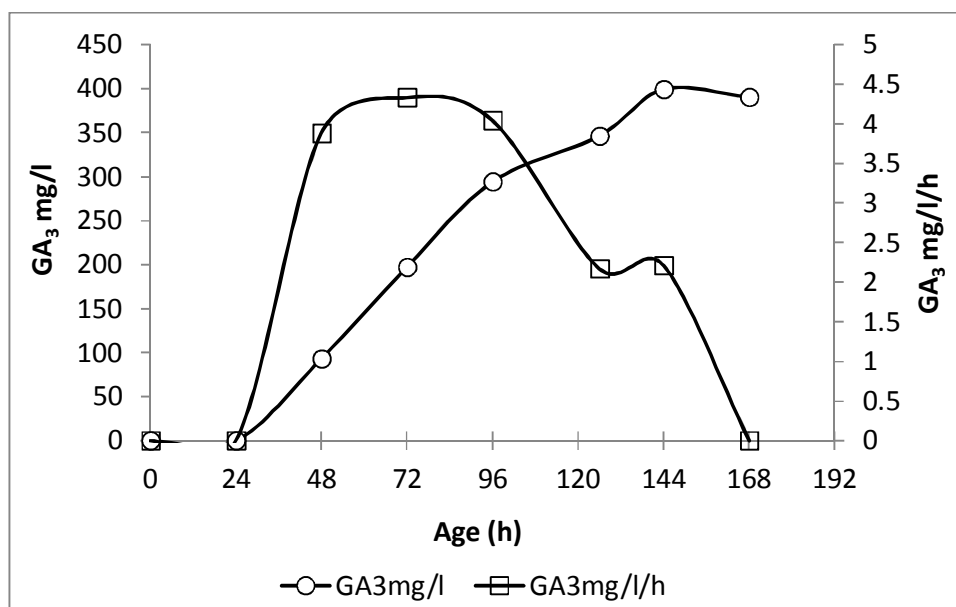

Figure 4.6 Time course profile of gibberellic acid production in shake flask culture

Fig. 4.6 shows the rate of gibberellic acid production and actual concentration during shake flasks study. Earlier, it was reported that *F. fujikuroi* does not produce any gibberellin until the nitrogen in the medium is depleted. The switch from growth phase to production phase has also been attributed to the arrest in growth caused by the depletion of nitrogen in medium (Borrow *et al.*, 1964; Candau *et al.*, 1992). In the present investigation also, the growth phase lasted till 24 h after which GA₃ formation occurred and reached up to 390 mg/l at the end of 168 h fermentation (Fig.

4.6) It can be also observed from time course profile of GA₃ production that initially, the rate of GA₃ production increased up to 4 mg/l/h but started to decline after 72 h. This decline was rapid and resulted in final lower GA₃ concentration than desired. For decline in GA₃ rate production different reasons could be responsible like change in pH, requirement of lower temperature during secondary metabolism, catabolite repression, change in oxygen demand, need of addition of specific precursors, shear of mycelium in fermenter *etc.* These parameters were examined in subsequent experiments.

4.3.6 Effect of pH on rate of GA₃ production

The rate of GA₃ production was found to be high in the beginning of stationary phase and declined as the age of culture progressed. During this period, it was also observed that pH of the broth decreased slowly to 3.0 to 3.5. Therefore decrease in GA₃ production rate and final concentration was likely to be due to decrease in pH during production phase. In shake flasks, it is normally difficult to control pH at any desirable point. To avoid the decrease in pH, an attempt was made to control pH with calcium carbonate in shake flask culture.

Growth of the studied Mut189 strain was almost similar in the shake flasks with or without CaCO₃, in terms of dry cell mass. Use of hydrochloric acid for dissolution of residual CaCO₃ helped in correct estimation of dry cell mass in the flask. The cultures showed similar growth characteristics and viscosity as discussed earlier. The pH values in the flasks with different quantities of CaCO₃ and the concentration of gibberellic acid are shown in Fig. 4.7 and Fig. 4.8 respectively.

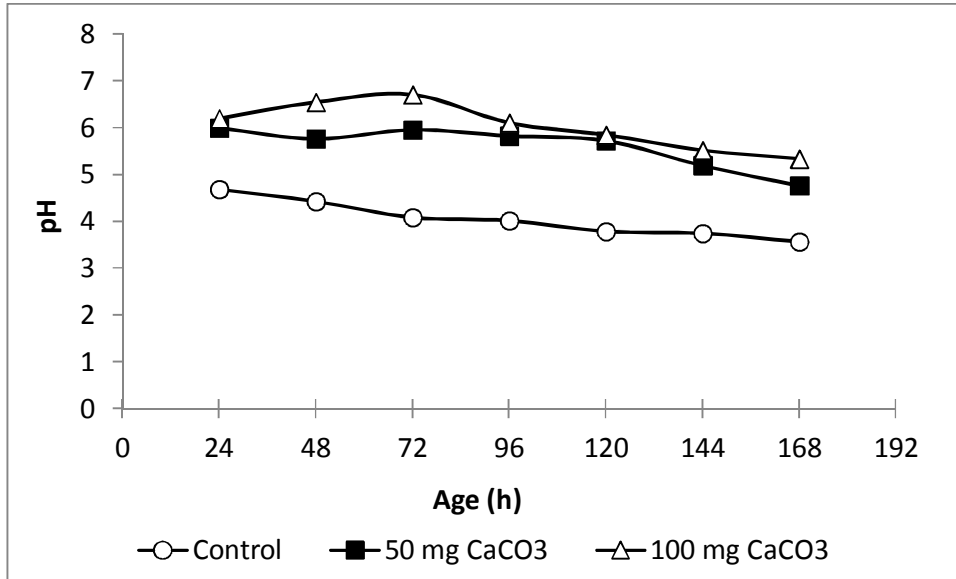

Figure 4.7 pH values in the flasks with different quantities of CaCO₃

From Fig. 4.7 it can be seen that the pH in control flask without CaCO₃ declined gradually with time and reached in range of 3.7 to 3.5. While the use of sterile CaCO₃ allowed maintenance of pH in the shake flask culture, above 5, all the time.

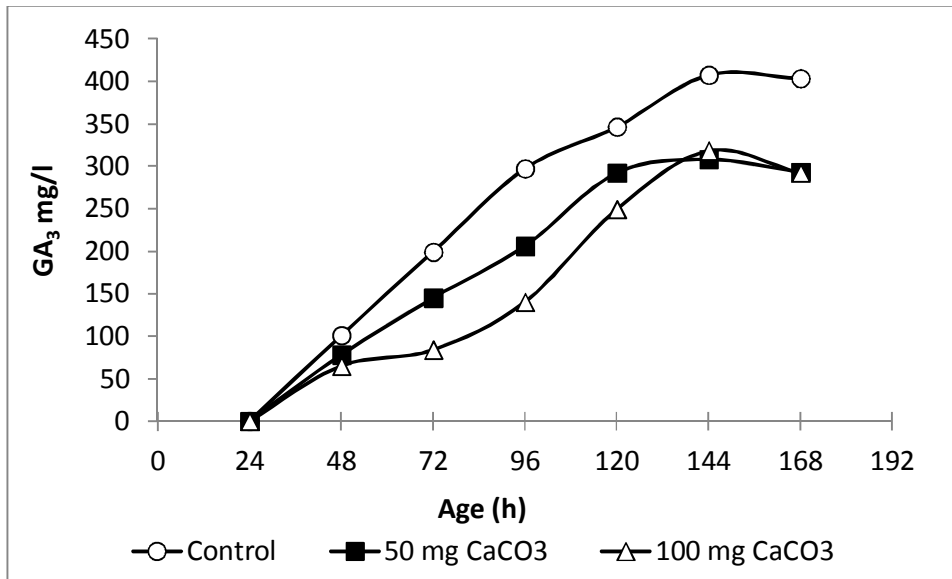

Figure 4.8 Effect of pH on GA₃ production by Mut189

Fig. 4.8 shows that GA₃ production by Mut189 was adversely affected in the presence of CaCO₃ as the neutralizing agent. It was observed that an attempt to control pH with calcium carbonate did not lead to increased GA₃ production.

Rangaswamy (2012) has noted that initial pH of the medium did not greatly influence the production of GA₃ and highest concentration of GA₃ was obtained on the 8th day of fermentation when the initial pH was adjusted to 7.0. Similar profile was reported for GA₃ production in *Pseudomonas* by Karakoc and Aksoz (2006). However, Borrow *et al.*, (1964) reported that the specific growth rate and gibberellin concentration were fairly constant over the pH range of 3.5 to 6.5. It was also reported that pH variation is one of the most influential factor in the composition of the produced gibberellins mixture. For GA₃ production, pH generally employed was between 3.5 and 5.8. The increase in pH led to enhanced production of GA₄ and GA₇ while pH below 3.5 caused increase in GA₁ production (Kumar and Losane, 1989). The present investigation also confirmed that initial pH of the medium did not greatly influence the production of GA₃ and a slow decrease in pH is necessary for the maximal production of GA₃ during production phase.

4.3.7 Effect of temperature on GA₃ production during stationary phase

To achieve higher GA₃ productivity by the mutant Mut189 there was need to maintain higher GA₃ production rate during GA₃ production phase. It is known that temperature of incubation affects the growth and production of secondary metabolites. The effect of temperature on the secondary metabolite production is dependent on the strain employed. Also it is widely accepted that secondary metabolism of microorganisms represents an important pathway for survival. A lower temperature could be viewed as one type of environmental stress and secondary metabolite production might therefore be enhanced (Lai *et al.*, 2005). Therefore impact of 5°C lower temperature during production phase of GA₃ by Mut189 was studied and results are given in Table 4.4.

<i>Mutant</i>	<i>Temperature during 48h incubation</i>	<i>Temperature during stationary phase</i>	<i>GA₃ concentration mg/l</i>
Mut189	28 °C	28 °C	432
	28 °C	23 °C	384

Table 4.4 Effect of shift in temperature on GA₃ production

The mutant culture Mut189 which was maintained at 28 °C and transferred to 23 °C during stationary phase did not show any visible difference. It can be seen from Table 4.4 that the GA₃ concentration was higher in the flasks maintained at 28 °C. This result is in harmony with previous studies reporting the maximum GA₃ production detected at 29 °C by Jefferys (1970) and 30 °C by Rangaswamy (2012).

4.3.8 Effect of glucose feeding on GA₃ production

Time profile study of GA₃ production by mutant Mut189 in shake flasks culture revealed the pattern of GA₃ production rate as the initial increase and subsequently decrease in GA₃ production rate. This led to final lower production of GA₃ than desired. There could be several reasons for the decline in GA₃ production rate. One of the reasons for decrease in GA₃ production rate can be catabolite repression due to presence of excess sugar present during production phase. To maintain low residual glucose and avoid catabolite repression, glucose solution was fed slowly to the shake flask cultures of Mut189 in desired concentration.

Glucose was fed at concentration ranging between 5 and 15 g/l/d to the shake flask cultures of Mut189 after every 24 h interval. Results of glucose feed are depicted in Fig. 4.9a and Fig 4.9b.

Results presented in Fig. 4.9a illustrate that when glucose (5 to 15 g/l/d) was fed at 24 h of incubation, there was almost similar concentrations of GA₃ at the end of 48 h of cultivation in all shake flask cultures of Mut189. While at 72 h of cultivation, marginal difference was observed in GA₃ concentration. However, from 72 h onward, difference in GA₃ concentration was noticeable. At the end of five day incubation period, a maximum of 312 mg/l GA₃ was obtained in flask, fed with 5 g/l/d glucose.

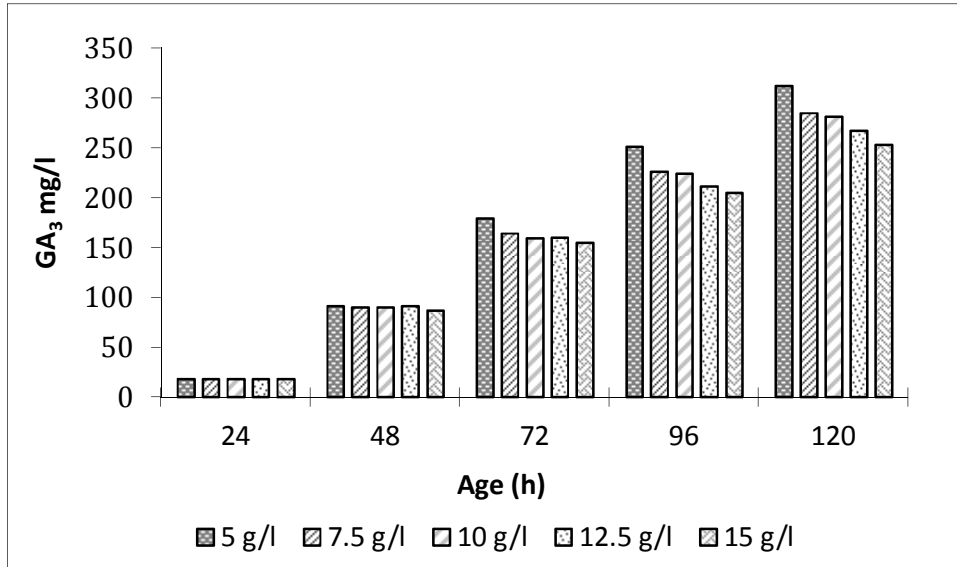

Figure 4.9a Effect of different glucose feed concentration on GA₃ production

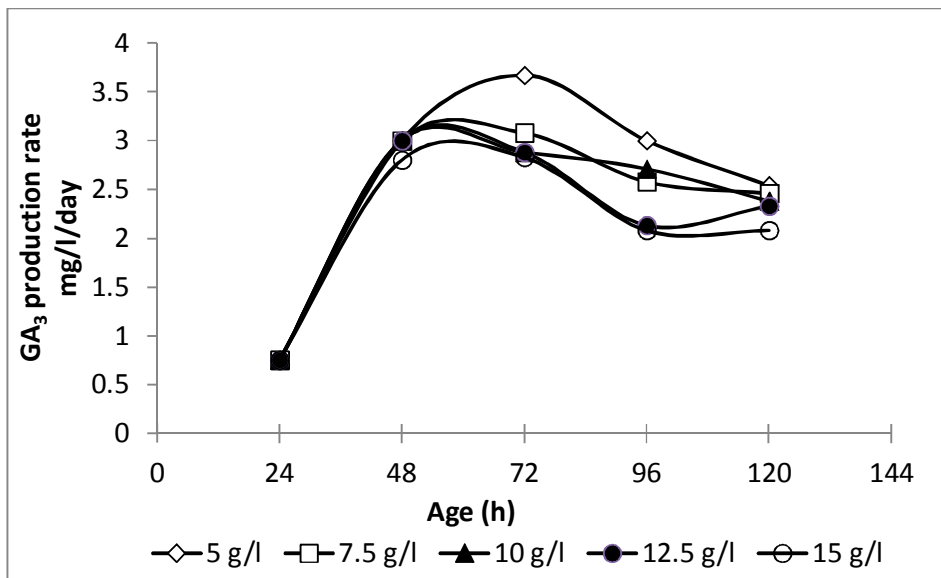

Figure 4.9b Effect of different glucose feed concentration on GA₃ production rate

From Fig. 4.9b it can be seen that GA₃ production rates were same in all the shake flask cultures of Mut189 from 24 to 48 h of cultivation and increased at 72 h in all flasks. Mut189 showed highest GA₃ production rate 3.67 mg/l/d in the flask fed with 5 g/l/d glucose. Irrespective of different quantity of glucose fed, GA₃ production rate started to decline beyond 2 h onwards as seen from Fig. 4.9b

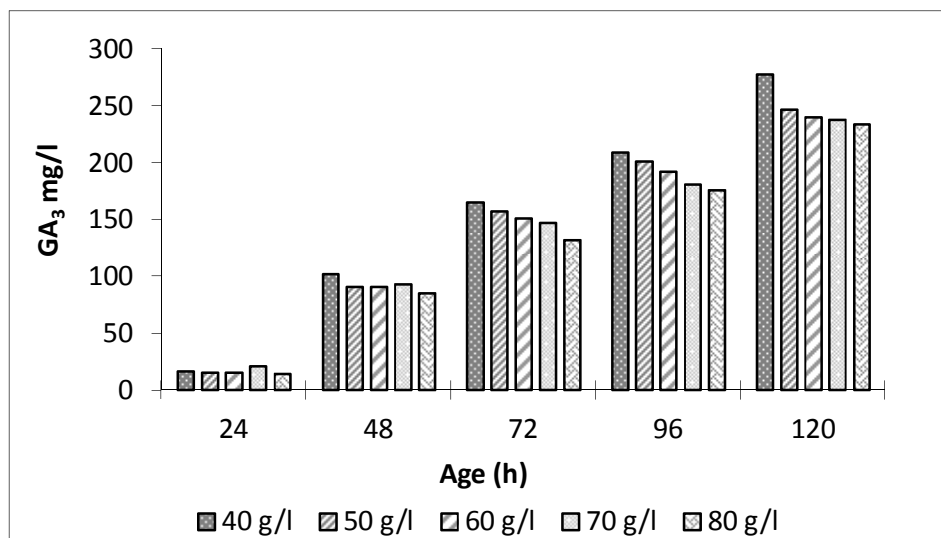

Figure 4.10 Control flasks: Total glucose addition

As compared to shake flask cultures in which 5 g/l/d glucose was fed, the decline in GA₃ production rate of Mut189 in other glucose fed flask cultures was sharp. This indicated that GA₃ production rate could be better maintained in shake flasks cultures with low (5 g/l/d) glucose feed.

From Fig. 4.10 it was also surveyed that in control flasks with high initial glucose concentration in the medium (40 to 80 g/l) there was decrease in GA₃ production presumably because of the excess concentration of glucose in the medium.

Glucose, although an excellent carbon source for growth, interferes with the biosynthesis of many secondary metabolites. Carbon source regulation of secondary metabolism exists in many fermentations (Demain, 1989). Repression by carbon source is commonly known as CCR (Hodgson, 2000; Bruckner and Titgemeyer, 2002; Titgemeyer and Hillen, 2002) and usually caused by glucose, but in different organisms, other rapidly metabolized carbon sources can cause repression and sometimes repress catabolism of glucose itself (Sanchez and Demain, 2002). Several mechanisms have been described in bacteria and fungi to explain the negative carbon catabolite effects on secondary metabolite production. These mechanisms show important differences depending on the type of microorganism being considered (Sanchez *et al.*, 2010). The well known case is the repression of penicillin and cephalosporin production by glucose. Carbon catabolite regulation of penicillin and

cephalosporin biosynthesis is bypassed when glucose is slowly fed to the culture (Martin *et al.*, 1984).

In case of gibberellin production, earlier researchers reported that high initial glucose concentrations were deleterious for the accumulation of gibberellins (Borrow *et al.*, 1964; Candau *et al.*, 1992). They also showed that a gradual supply of the carbon source improved gibberellin production and the productivity of young mycelia (aged 3-6 days) was negatively related to the glucose concentration present in the media. Results obtained in the present study are matching with earlier reports. Thus, the present study also elucidated that low glucose feed was necessary to increase and maintain GA₃ productivity during fermentation process and thus in turn to obtain higher GA₃ production at the end.

Because of the obvious importance of carbon catabolite repression, a molecular level analysis of carbon regulation of gibberellin biosynthesis was initiated by Tudzynski *et al.*, (2000). They described the isolation, sequencing and expression as well as initial functional analysis of the creA genes from *F. fujikuroi*. Although they reported CreA binding sites in some of the gibberellin biosynthetic genes, the exact mechanism and target gene(s) of glucose repression is not known yet.

Overall, it signifies that the knowledge of carbon catabolite repression mechanisms will provide rational strategies for production of gibberellic acid by selected gibberellins-overproducing fungal strains.

4.3.9 Evaluation of mutant Mut189 for GA₃ production in 10 L fermenter

4.3.9.1 Batch fermentation

On inoculating the fermenter with 10% v/v M189 inoculum, it was found that excellent growth of the strain with desired short, thick mycelium, similar to shake flask could be achieved in 10 L fermenter within 24 h of growth phase. Mycelium was colourless as appeared from filtered and washed cell mass. Fermentation profile of batch run is illustrated in Fig. 4.11a and time course profile of GA₃ production and glucose utilisation during fermentation depicted in Fig. 4.11b.

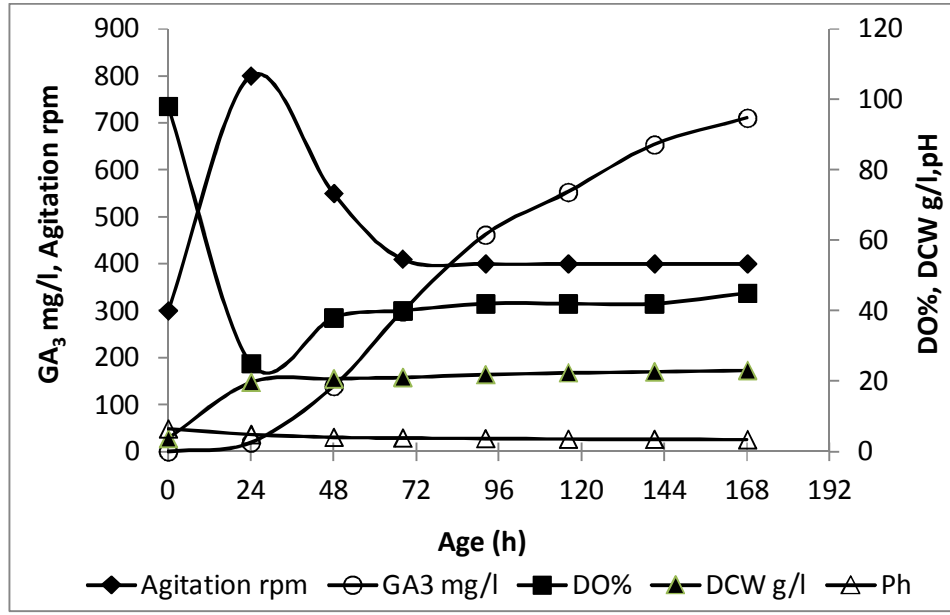

Figure 4.11a Fermentation profile of *F. fujikuroi* mutant Mut189 in LMF medium

It can be seen from Fig 4.11a that the major biomass growth was achieved in initial 24 h (19.7 g/l DCW) which later on increased to 23 g/l DCW towards the end of batch. During first 24 h, most of the glucose present in the medium was utilized for the growth of the fungus because gibberellins were not detected in first 24 h. The production of gibberellins began after 24 h toward end of the growth phase. It is known that gibberellins are produced by *F. fujikuroi* only after a strict nitrogen limitation in a nutrient medium (Borrow *et al.*, 1964; BuŁock *et al.*, 1974). In the present investigation also, the gibberellins could be detected only after the culture reached the stationary stage as seen from the stable dry cell mass.

Fig. 4.11a also show that the agitation rate between 300 and 800 rpm were found to be automatically adjusted depending upon the DO_2 status. In order to avoid DO_2 limitation, the agitation speed was increased to 800 rpm at 24 h, which was later reduced to 550 rpm till 48 h. On attaining the required biomass, the agitation speed was further reduced to 400 rpm at 72 h. The DO_2 remained around 50% air saturation during the run except some period of exponential growth. It was observed that there was DO_2 limitation in early growth phase and at 24 h, DO_2 concentration observed was only 25% of air saturation. This was because although the agitation rate reached 800 rpm, the DO_2 demand was even higher. The value of oxygen consumption for a growing mycelium in the exponential phase of growth remains constant but the

demand for oxygen increases more or less exponentially as described by Tudzynski (1999).

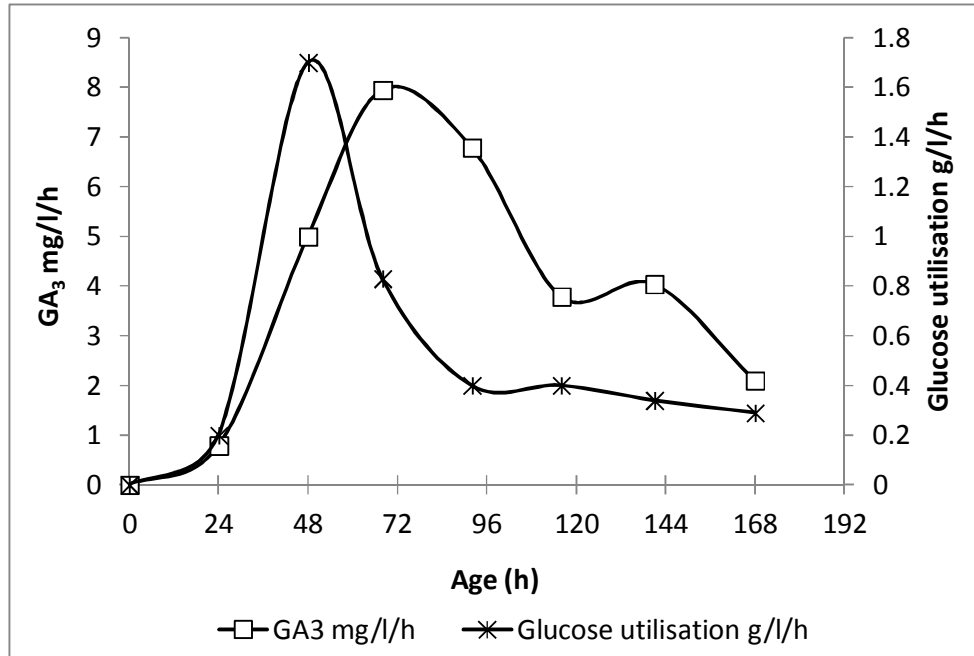

Figure 4.11b GA₃ production profile of *F. fujikuroi* Mut189 during batch fermentation

Fig 4.11b illustrates that the glucose uptake rate initially increased to 1.7 g/l/h at 48 h and later decreased slowly to 0.29 g/l/h at the end of the batch. GA₃ production rate increased to 7.95 mg/l/h at 68 h. It started to decline and reached to 2.1 mg/l/h at end of fermentation batch. Similar to shake flask study, declined rate of GA₃ production was observed in 14 L fermentation batch. Concentration of GA₃ finally reached 710 mg/l in 168 h.

In the second fermentation batch, during initial growth phase (from 0-24 h) pH was controlled at 6.5 and later allowed to drop up to 4.5 and controlled at 4.5. In order to avoid DO₂ limitation, fermentation was carried out with constant agitation and aeration at 700 rpm and 5 LPM, respectively. Results of fermentation run are depicted in Fig. 4.12.

It can be seen from Fig. 4.12 that DO₂ concentration above 50% of air saturation during the batch time except early growth phase and 90% of the biomass growth was achieved in initial 24 h which later on increased to 24 g/l DCW towards the end of batch. During fermentation, glucose utilisation rate and GA₃ production rate profile

was almost similar. On continuing the batch till 168 h, final GA₃ concentration 730 mg/l was achieved. Controlling pH at 4.5 during production phase, thus, did not improve GA₃ production by mutant Mut189.

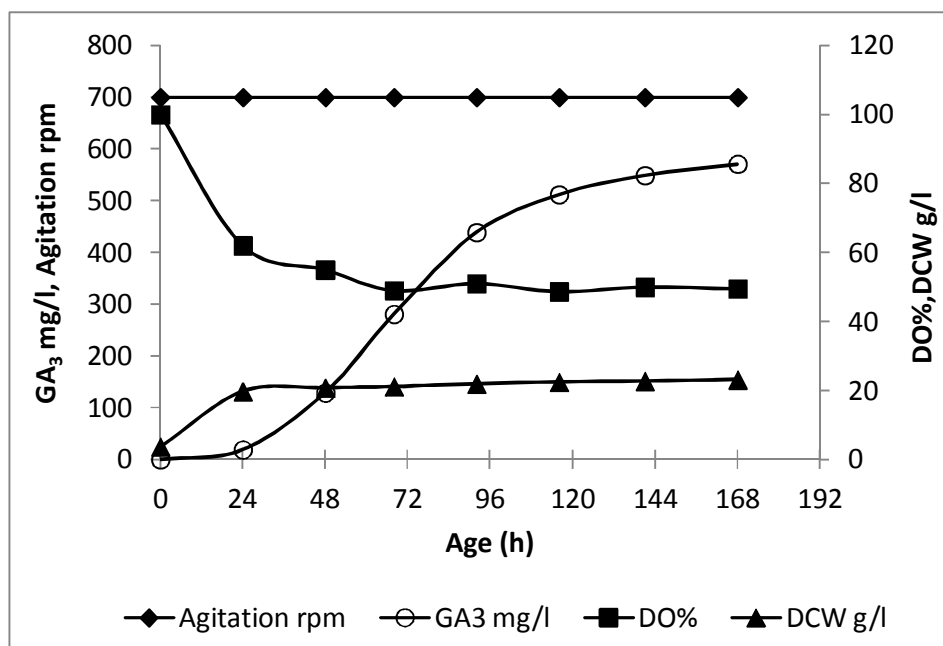

Figure 4.12 Fermentation profile of *F. fujikuroi* mutant Mut189 in LMF medium with controlled pH

In the third batch, in order to increase biomass increased quantity of nitrogen source in LMF was added. Instead of 9 g/l defatted soyabean meal concentration was increased to 12 g/l. Batch was started in similar manner as described earlier. The Mut189 grew well and the biomass concentration reached 29 g/l DCW within 30 h of growth phase. With increased biomass, to avoid DO₂ limitation, a mixture of oxygen and air was sparged into the fermenter. The DO₂ remained around 30-35% of air saturation during the run except some period of exponential growth. Although sugar was consumed completely, only marginal increase in GA₃ concentration was obtained. In this fermentation batch, when higher nitrogen content in the medium was used, more lipid accumulation was observed (288 mg lipid/g DCW) that accounted for 29% of the total biomass, but GA₃ concentration did not increase further.

Avalos *et al.*, (1991) have reported that *Gibberella fujikuroi* accumulates fatty acids and excretes fatty acid esters to the culture medium. The enhanced fatty acid

accumulation under low aeration conditions was also recorded by Giordano and Domenech (1999). In the present study with increased nutrients, biomass increased but GA₃ concentration did not increase proportionally. It seems that lower availability of oxygen diverted available carbon flow towards fatty acid synthesis.

In these fermentation batches, mycelial shear/fragmentation of mutant culture Mut189 was observed at 96 h of fermentation and loosening of broth was evidenced on 5th day onward. Thus, higher cell density of mutant Mut189, controlled pH during production phase and maintenance of DO₂ concentration in the range of 40-50% air saturation did not improve GA₃ production to the desired extent. This fermentation study indicated that along with DO₂, other possible reasons like feedback inhibition, culture aging and catabolite repression due to accumulation of sugar during fermentation may be important parameters in gibberellic acid production by fermentation.

4.3.9.2 Extractive Fermentation

Extractive fermentation is one of the techniques for *in situ* product recovery. It involves separation of products immediately after they are formed. The benefit of this recovery process, mainly yield improvement, may be obtained by the reduction of product inhibition or by prevention of product degradation. In the present investigation, to study the possible feed-back inhibition of GA₃ production, extractive fermentation using a membrane-bioreactor was performed. Batch was started under similar fermentation conditions as detailed in previous fermentation. Extractive fermentation was carried out in fed-batch mode. Glucose was fed to the fermenter, proportionate to the prevailing sugar uptake rate of about 1 g/l/h, during the stationary phase.

In comparison to the batch cultivation, the biomass and pH did not change significantly. Similarly, the production of GA₃ began after growth phase was over. Results of extractive batch fermentation are presented in Fig. 4.13.

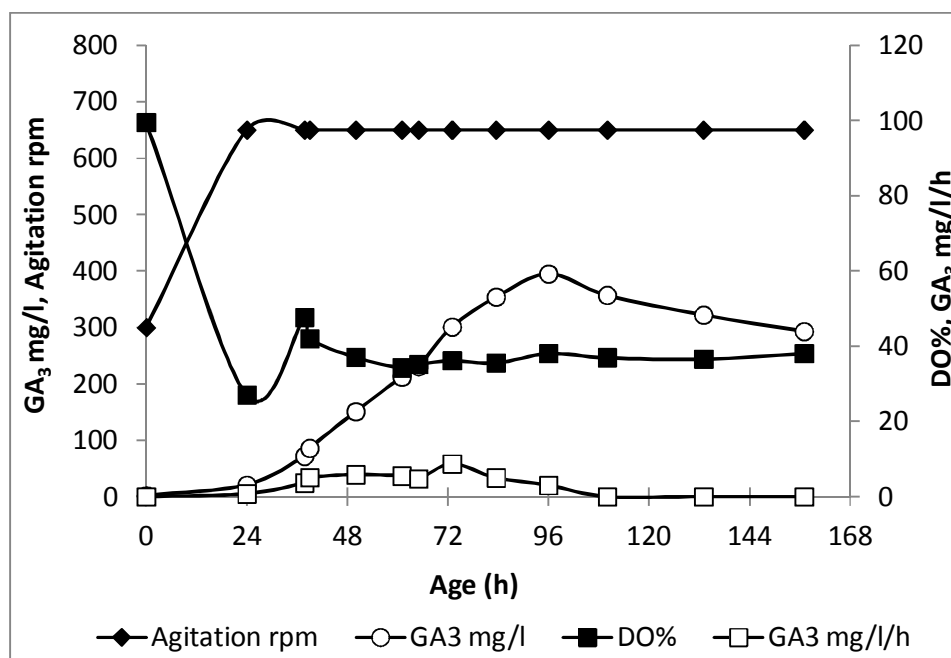

Figure 4.13 Extractive fermentation of GA₃ production by mutant Mut189 in LMF

The results presented in Fig. 4.13 show that DO₂ concentration remained between 35-40% of air saturation during the batch time except early growth phase. In order to avoid DO₂ limitation, the agitation speed was increased to 650 rpm at 24 h which was kept constant till end of the fermentation run. The maximum concentration of GA₃ 395 mg/l reached at about 96 h. The GA₃ came out from the selected membrane unit into permeate without any difficulty. At 96 h the maximal GA₃ was about 364 mg/l in permeate.

There is probably only one report by Hollmann *et al.*, (1995) which indicated the two-fold increased yield of GA₃ as compared to conventional batch fermentation by employing extractive fermentation using solvent polyalkkoxylate. In the present investigation, the maximum concentration of GA₃ 395 mg/l reached at about 96 h. Although glucose was available, GA₃ accumulation stopped further. It was also observed that similar to earlier fermentation batches the rate of GA₃ production started to decline even though the concentration of gibberellic acid in fermentation broth was less than inhibitory concentration. This also coincided with the maximal GA₃ production rate in a normal batch operation without any extraction of the liquid. This indicated that there was no or very little feed-back inhibition by GA₃ and

decrease in production rate was probably a function of aging of the culture or catabolite repression.

The results also explain that the culture did not have any requirement of the soluble organic nutrients (except sugar) present in the fermenting liquid after the initial growth phase was over because the broth was getting continuously replaced by sugar solution with mineral nutrients.

4.3.9.3 Repeated batch fermentation

The decline in the rate of GA₃ production was initially thought to be due to pH change during fermentation, depletion of an essential nutrient and a typical feedback inhibition caused by accumulation of the gibberellic acid. However, during the course of careful investigation on each of them either in shake flask or in fermenter, it became evident that this could be natural aging phenomena and needs to be tackled with suitable change in the fermentation procedures.

The fermentation batch was initiated in similar manner as described earlier. Mut189 grew with short, branched mycelial form. The growth in terms of dry cell mass was 20.7 g/l achieved in initial 24 h. The production of gibberellin began after 24 h toward end of the growth phase. GA₃ concentration continued to increase and at 96 h it reached to 384 mg/l. At this age of the culture, fermented broth (7.5 L) was rapidly withdrawn and the fermenter was filled with fresh separately sterilized LMF. At this point, second batch started. Overall three repeated batches were performed. The results presented in Table 4.5 indicate that the repeated batch operation resulted in consistent GA₃ production.

<i>Batch</i>	<i>Age h</i>	<i>GA₃ mg/l</i>
First	96	384
First Repeat	71.5	363
Second Repeat	72	413
Third Repeat	73	389

Table 4.5 The Repeated Batch operation and GA₃ production

Table 4.5 also shows that the first batch took longer time to reach the desired GA₃ concentration. It was presumably because of the difference in the inoculum that was

grown in the shake flasks and available in the fermenter for subsequent batches. Through the repeated batch fermentation, it is possible to reach a desired gibberellic acid concentration in the fermenter in a reasonably short cycle time.

This repeated batch approach has advantages as 1) the batch time is reduced to around 72 h, 2) the growth time is reduced to about 18 h and 3) the equipment is used to exploit the process only during the maximal activity of the culture. Thus, this proposed Repeated Batch can be an answer to the problem of decreasing rate of GA₃ production.

4.3.9.4 Fed batch fermentation

Fed-batch culture approach acts as powerful tool to overcome several restrictions on fermentations such as substrate inhibition, catabolic repression. It also provides an efficient mode for the extension of the product phase and decreasing the viscosity of broth. It allows the voluntary control of the concentration of nutrients fed into the fermenter which is not possible in batch fermentation. To study possible catabolic repression during GA₃ production by Mut189, fed-batch fermentation was performed in the 14 L fermenter under the same conditions as the batch fermentation. The glucose feeding was initiated at the beginning of stationary phase of the culture. In earlier fermentations, using mutant Mut189, glucose was fed in one shot. To avoid excess carbon and to maintain higher GA₃ productivity throughout fermentation, the same amount of glucose was fed continuously at predetermined rates. The results of fermentation profile of fed-batch run F1 is presented in Fig. 4.14.

The mutant Mut189 grew rapidly with desired short, thick, branched filament nature. It can be seen from Fig 4.14 that during logarithmic growth phase, growth in terms of high dry cell weight 20 g/l was achieved. The growth became linear later. Gibberellic acid is a secondary metabolite and its production began only when the logarithmic growth phase was over. The GA₃ accumulation continued throughout the batch time till 192 h to reach a concentration of 798 mg/l. There was a gradual decrease in pH, which remained stationary during the late stage of fermentation. Fig 4.14 also illustrate that the initial high agitation rate of 700 rpm was maintained to increase growth rate of mutant Mut189. After the growth phase, agitation rate was gradually

decreased to 650 rpm at 24 h. The DO₂ remained around 50% air saturation throughout the fermentation run. .

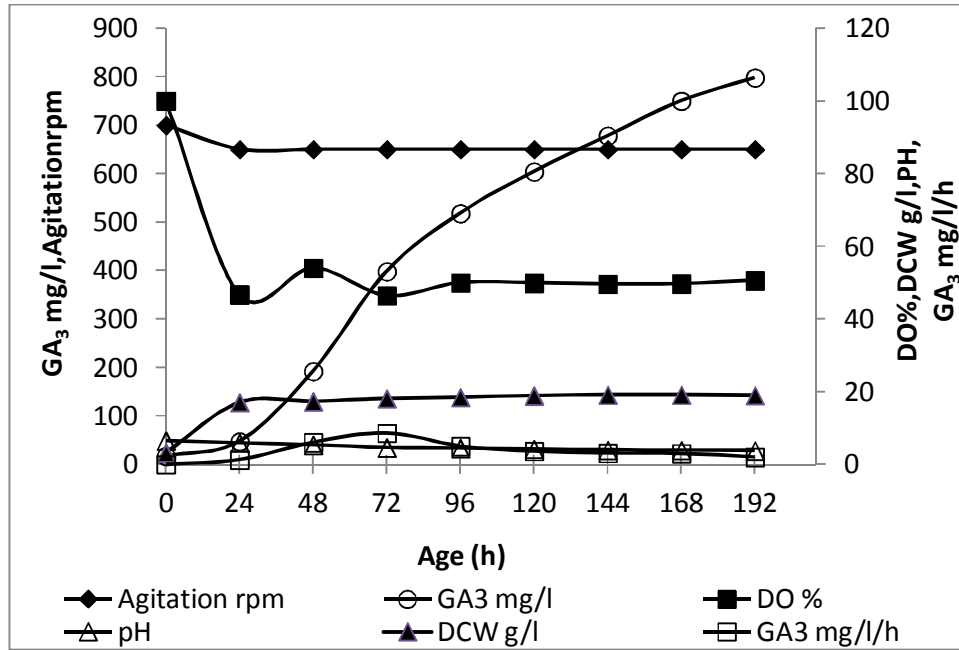

Figure 4.14 Fed-batch fermentation run F1 with mutant Mut189

Although the dry cell weight accumulation rate was very high during first 24 h, the sugar utilization rate was low indicating that most of the growth in the present medium was taking place at the cost of protein source provided. The highest sugar uptake rate (1.76 g/l/h) was observed during the changeover from logarithmic to stationary phase of the culture. The rate of GA₃ production increased along with the sugar utilization rate during initial stationary phase. The rate of sugar utilization decreased slowly and reached at 0.58 g/l/h. The rate of GA₃ production continued to be high till 72 h and reached to 10 mg/l/h. This rate, however, started to decline and decreased to 2 mg/l/h. At the same time, glucose got accumulated due to decreased glucose utilization rate. The decrease in the GA₃ production rate was thought to be due to catabolite repression. Similar to earlier fermentation batches, mycelial shear and fatty acid accumulation was obtained in this fermentation batch

In subsequent fed-batch fermentation F2, glucose was fed at 10 g/l/d. At every 12 h interval 5 g/l/d glucose was fed. Glucose utilization rate was 1.5 l/h. The results of F2 fed batch run are presented in Fig. 4.15a. Similar to earlier fed-batch, in F1, the mutant Mut189 grew rapidly with desired short, thick, branched filament nature.

Also, there was a gradual decrease in pH, which remained stationary during the late stage of fermentation. In comparison with F1 fed-batch, growth in terms of DCW was almost half 11.2 g/l and the DO₂ percentage was in the range of 75-80%. GA₃ concentration reached 980 mg/l in the same fermentation time.

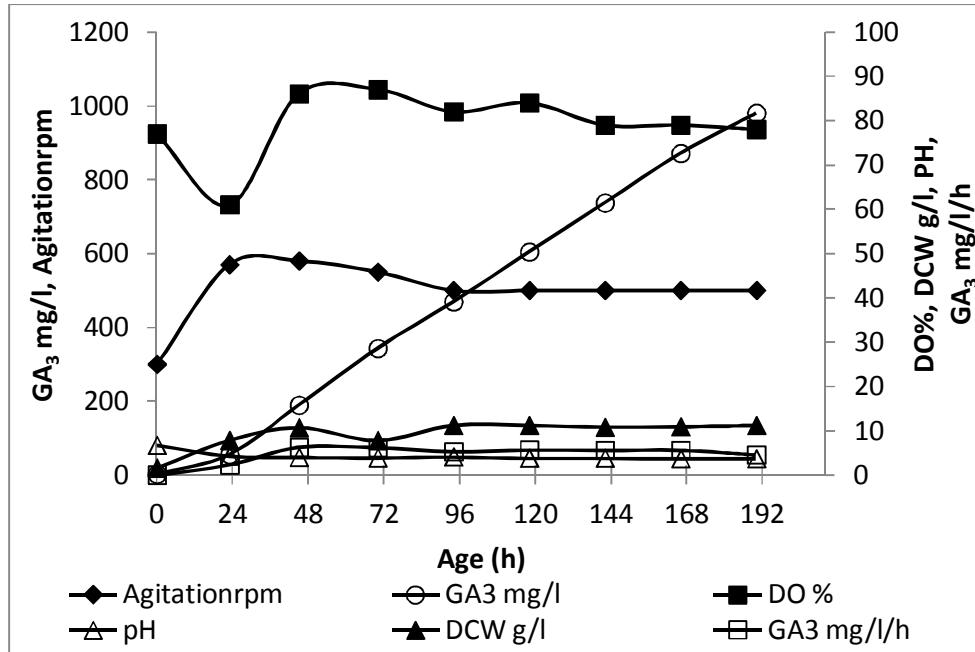

Figure 4.15a Fed-batch fermentation run F2 with mutant Mut189

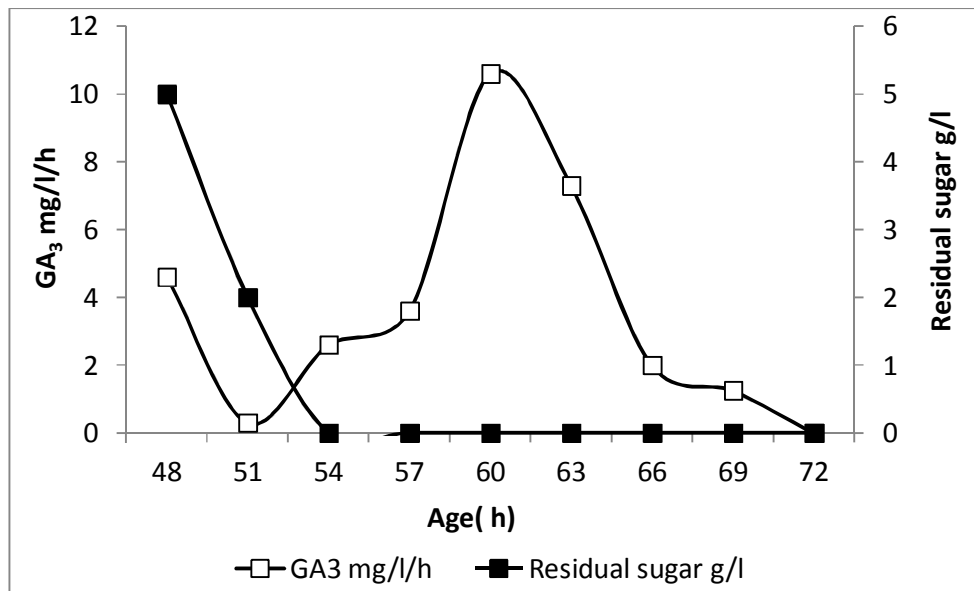

Figure 4.15b GA₃ production profile of Mut189 during fed batch F2

GA₃ production profile was studied between 48-72 h of fermentation. The results presented in Fig. 4.15b show that at 48 h, the rate of GA₃ production was 5 mg/l/h. After addition of glucose, the rate of GA₃ production declined. At the same time, it was observed that DO₂ slowly decreased to 40 % air saturation. When glucose was almost zero, DO₂ slowly increased to 70 % and the rate of GA₃ production reached to 10 mg/l/h. Later on, the rate of GA₃ production started to decline and reached to 1 mg/l/h.

This study revealed that to maintain GA₃ production rate, DO₂ should be in the range of 70-80 % air saturation. Glucose concentration should be controlled further to maintain GA₃ production rate.

Fed-batch fermentation F3 was performed to maintain DO₂ and higher GA₃ productivity throughout fermentation. To do so, once the cell growth was over (at age of 30 h), 5 g/l/d glucose was fed at the rate of 0.20 g/l/h. The results of F3 fed batch run are given in Fig. 4.15c. A representative screen view of online fermentation data of process parameters such as DO₂, pH, agitation and feeding strategy acquired by NBS BioCommand Plus Software of fed-batch run F3 is presented in Fig. 4.15d.

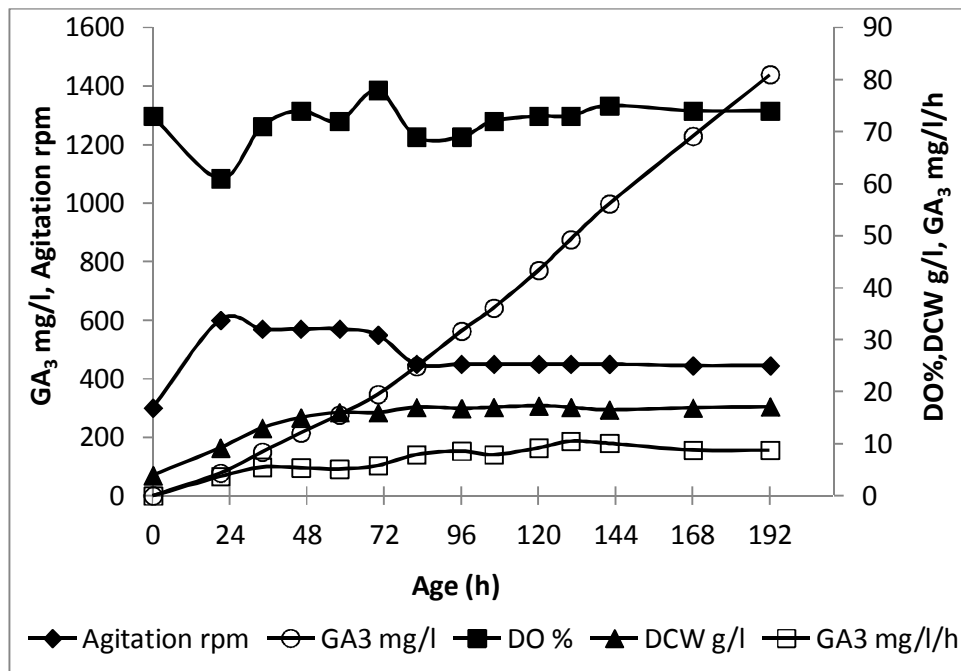

Figure 4.15c Fed-batch fermentation run F3 with mutant Mut189

The results presented in Fig. 4.15c indicate that DO₂ could be maintained in the range of 70-80 % air saturation. Controlled addition of glucose did not allow mycelial fragmentation and also caused very less turbidity in fermentation broth. Intact mycelium and maintenance of DO₂ level led to maintain GA₃ productivity (8 mg/l/h) during fermentation. In eight days of fermentation study, GA₃ concentration of 1440 mg/l could be achieved which was almost double of that obtained at the beginning of the fermentation studies.

In fed-batch fermentation sets F2 and F3, lipid extracted in chloroform and was measured gravimetrically after evaporating chloroform. 138-140 mg lipid/g DCW was obtained which accounts for 14% of the total biomass. These results suggest that the total lipid concentration from the mutant Mut189 was below the average lipid concentration present in fungus thus indicating that glucose was not substantially diverted to lipid formation in nitrogen limitation condition by mutant Mut189.

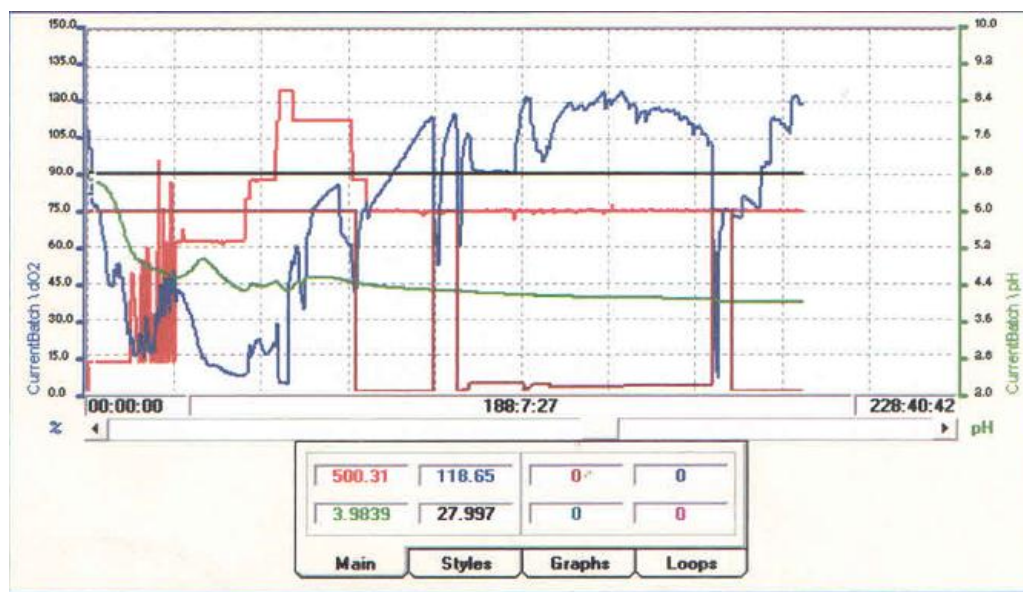

Figure 4.15d A screen view of online fermentation data of process parameters acquired by NBS BioCommand Plus Software of fed-batch run F3

The observations of other investigators also show similar findings. Giordano and Domenech (1999) had reported that the aeration affects the fate of acetate in *F. fujikuroi* during secondary metabolism. The higher oxygen availability increased production of gibberellic acid and bikaverin during the fermentation using *F. fujikuroi*. Along with dissolved oxygen requirement, production of gibberellic acid in

submerged batch cultivation was predominantly controlled by catabolic regulation which involves catabolite repression and substrate inhibition (Kumar and Losane 1989, Tudzynski, 1999). It was also reported that initial concentration of glucose higher than 20% decreased the rate of gibberellin production (Borrow *et al.*, 1964). To improve GA₃ productivity, fed-batch fermentations attempted using different arbitrary (trial & error) nutrient feeding strategies (Darken, 1959; Borrow *et al.*, 1964). Model-based nutrient feeding strategies for improvement of GA₃ productivity showed improved product formation and productivity (Shukla *et al.*, 2005). Shukla *et al.*, (2007) studied kinetics of gibberellic acid production in a multiple fed-batch cultivation process. They reported that application of four nutrient addition cycles of fed-batch mode of operation enhanced significantly the growth and production phase of the culture under non-limiting and non-inhibitory conditions.

In conclusion, low DO₂ and high glucose concentration during the growth phase adversely affected GA₃ production. For effective GA₃ production, it is important that how the culture is brought to the production phase. Adequate aeration and controlled glucose feed in the culture allowed increased GA₃ production and could overcome the catabolite repression which seemed to be an apparent regulation.

In the present investigation, an attempt to optimize fed-batch fermentation by separating growth phase from production phase was made by controlling glucose concentration during production phase. Fed-batch experiments using mutant Mut189 suggested that glucose concentration during the production phase is a critical parameter for GA₃ production. Using optimized fermentation medium in fed-batch fermentation, GA₃ production could be increased by 48 % as compared to the batch fermentation. Overall fermentation batches with mutant Mut189 are summarized in Table 4.6.

<i>Fermentation Mode</i>	<i>Fermentation protocol</i>	<i>GA₃ mg/l</i>
Batch fermentation		
B I	LMF with 9 g/l defatted soyabean meal and 90 g/l glucose	710
BII	Control of pH during production phase	730
BIII	LMF with 12 g/l defatted soyabean meal	701
Extractive fermentation	Glucose fed 1 g/l/h and use of Sterile membrane bioreactor assembly	
Repeated batch fermentation	7.5 L withdrawal of feed at 96 h and addition of 7.5 L fresh sterile LMF	
First batch		384
First Repeat		363
Second Repeat		413
Third Repeat		389
Fed-batch fermentation	After every 12 h glucose fed 5 g/l/d	798
F1		
F2	After every 24 h glucose fed 5 g/l/d	980
F3	After 30 h continuous glucose fed 0.2 g/l/h	1440

Table 4.6 Summary of fermentation batches performed using mutant Mut189

4.3.10 Analysis of fusaric acid and moniliformin

F. fujikuroi a species complex (MP-A to MA-I) produces a variety of secondary metabolites and differ in their ability to produce them (Malonek *et al.*, 2005). The toxicological interest in species of *Fusarium* arises as some strains produce significant quantities of mycotoxins such as fusaric acid and moniliformin (Marasas *et al.*, 1989). These mycotoxins are undesired toxic metabolites of species of *Fusarium*. The toxicity of these mycotoxins for animals, plants and human is well documented in literature and it was therefore essential that the strain of *F. fujikuroi* to be used for gibberellic acid production does not produce such mycotoxins. The fermentation broth of Mut189 was analyzed for presence of mycotoxin, fusaric

acid and moniliformin, at different time intervals. Analysis of fusaric acid and moniliformin was performed as detailed in chapter 2. There was no Fusaric acid or Moniliformin in the fermentation broth of mutant Mut189. Thus, there will be no need to design separation methods for these unwanted mycotoxins from the fermentation broth. Chromatograms of the reference compound fusaric acid and a sample of fermentation broth are presented in Fig. 4.16 and Fig. 4.16a respectively.

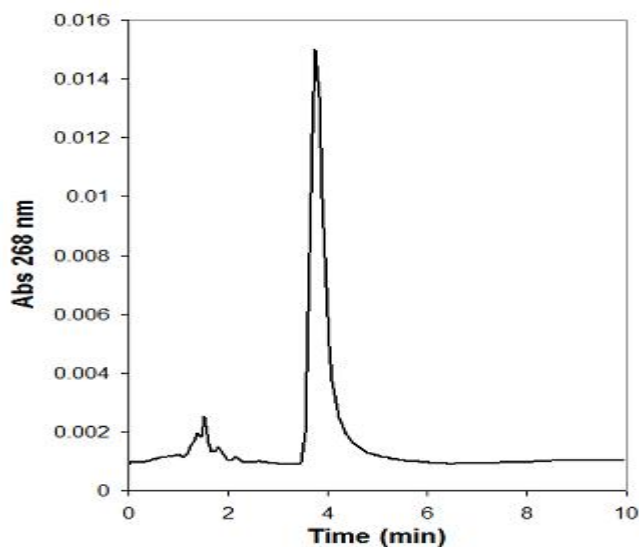

Figure 4.16 Reversed phase HPLC chromatogram of standard fusaric acid

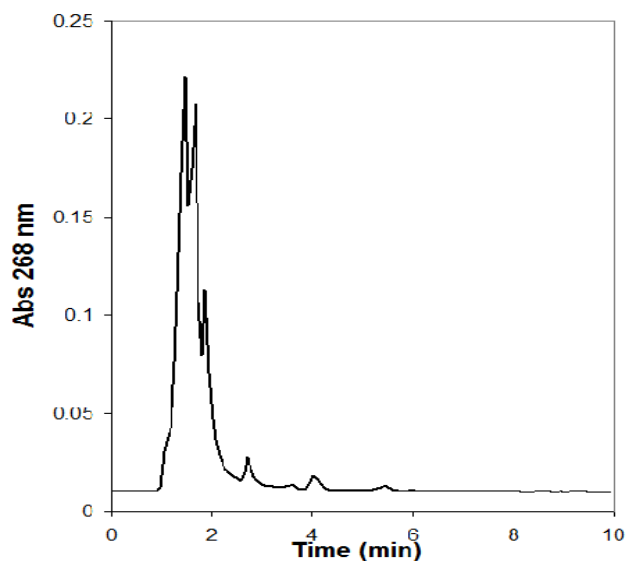

Figure 4.16a Reversed phase HPLC chromatogram of fermentation broth of *F. fujikuroi* mutant Mut189

Fig. 4.16 shows that the standard fusaric acid eluted at 3.75 min. While in the chromatogram of culture filtrate of mutant Mut189, two peaks eluted near this retention time (Fig. 4.16a). Although the retention times were close to that of fusaric acid, online spectral scanning of the sample chromatogram showed that these peaks had distinctly different spectral behaviour and were not fusaric acid.

4.3.11 Purification and characterization of GA₃ from the fermentation broth

A great deal of work with GA₃ is focused on its extraction and analysis from plant source. From the fermentation broth, GA₃ could be recovered either by adsorption (Neumann *et al.*, 1989, Heropolitanski *et al.*, 1994) or by solvent extraction (Li *et al.*, 1992, Rachev *et al.*, 1993) and then purified by repeated liquid-liquid partitioning and concentration under vacuum. Finally, an amorphous powder or crystalline GA₃ is obtained (Brucker and Blechschmidt 1991). Aroca *et al.*, (2010) described the applicability of emulsion membrane technology for the extraction of GA₃ from the fermentation broth that can be an alternative to conventional multi-stage extraction processes. Although several reports are available on the isolation of GA₃, its isolation in a pure state is a most challenging task for the researchers.

In the present investigation, extraction of GA₃ from the fermentation broth by adsorption of the gibberellic acid on a hydrophobic polymeric micro-porous resin under the acidic environment was performed (Moghe *et al.*, 2001). The process is simple and easy to monitor in open air container. Using adsorption-desorption technique, GA₃ from the fermentation broth was recovered and extracted in ethyl acetate. The colourless ethyl acetate solution was obtained that was concentrated and gibberellic acid was crystallized at room temperature. White crystals of GA₃ were obtained. The recovered GA₃ was 93% pure as analyzed by HPLC using standard solutions of GA₃ purchased from Sigma. HPLC chromatograms of the standard and purified GA₃ are presented in Fig. 4.17. On-line spectral scanning of the product showed absorption pattern identical to standard as shown in Fig. 4.18 and Fig. 4.19. Melting point of the purified GA₃ was found to be 227 °C which was equivalent to authentic GA₃.

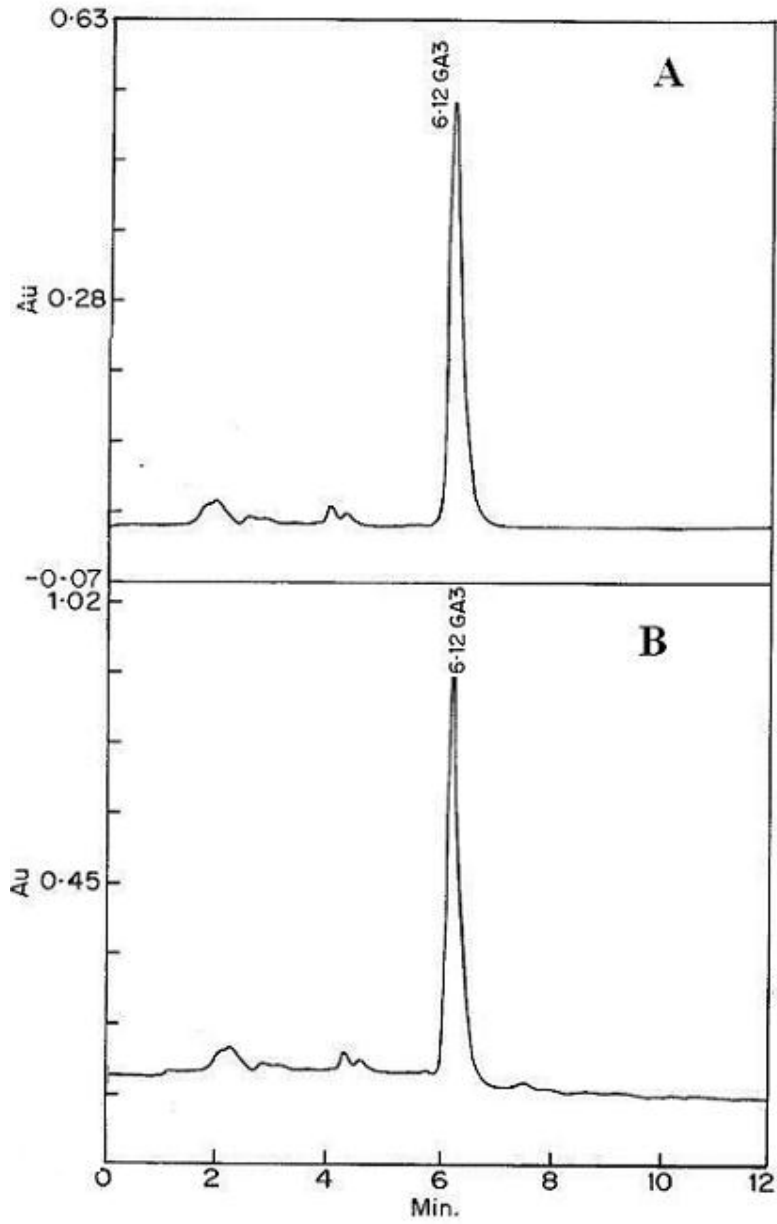

Figure 4.17 Reversed phase HPLC chromatogram of A) standard compound GA₃ B) Purified GA₃ from fermentation broth of Mut189

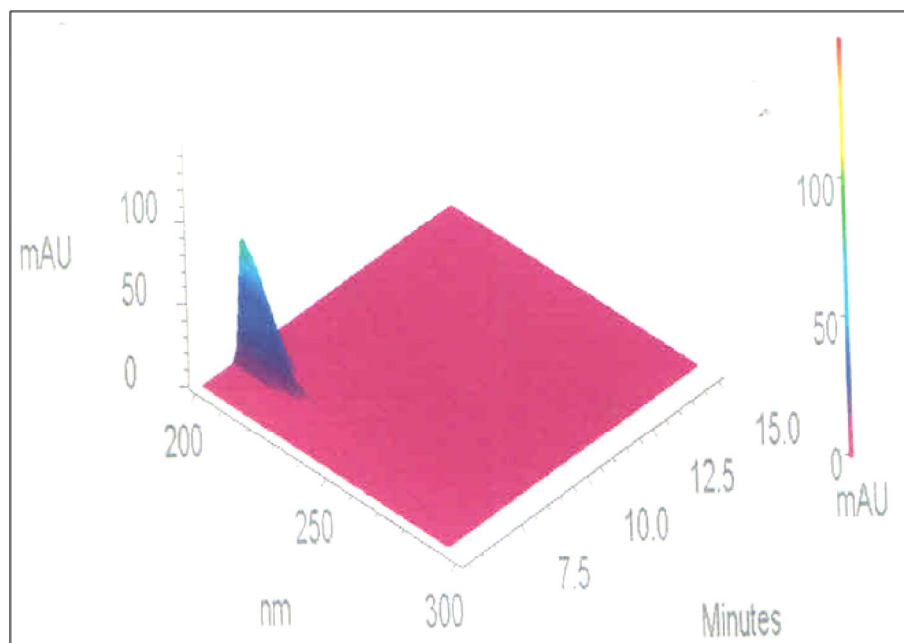

Figure 4.18 On-line spectral scanning of standard GA₃

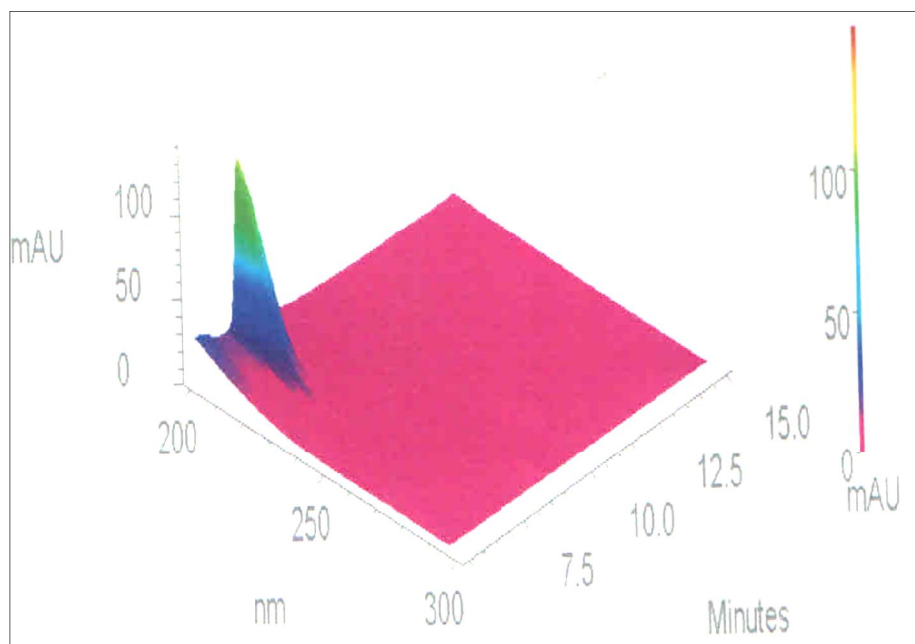

Figure 4.19 On-line spectral scanning of purified GA₃

Quality of purified, crystalline GA₃ was ascertained by LC-MS by comparison with mass spectra of authentic GA₃ standard from Sigma. LC-MS Mass spectra of authentic GA₃ from sigma and purified GA₃ are shown in Fig. 4.20 Along with (M - 1)

peak of purified sample showed (M + Na) ion spiked peaks (m/z) 239.45, 143.13. The molecular masses of GA₃ were determined by comparing (M - 1) ions. Analysis in ES negative mode gave (m/z) 345.14 *i.e.* (M - 1).

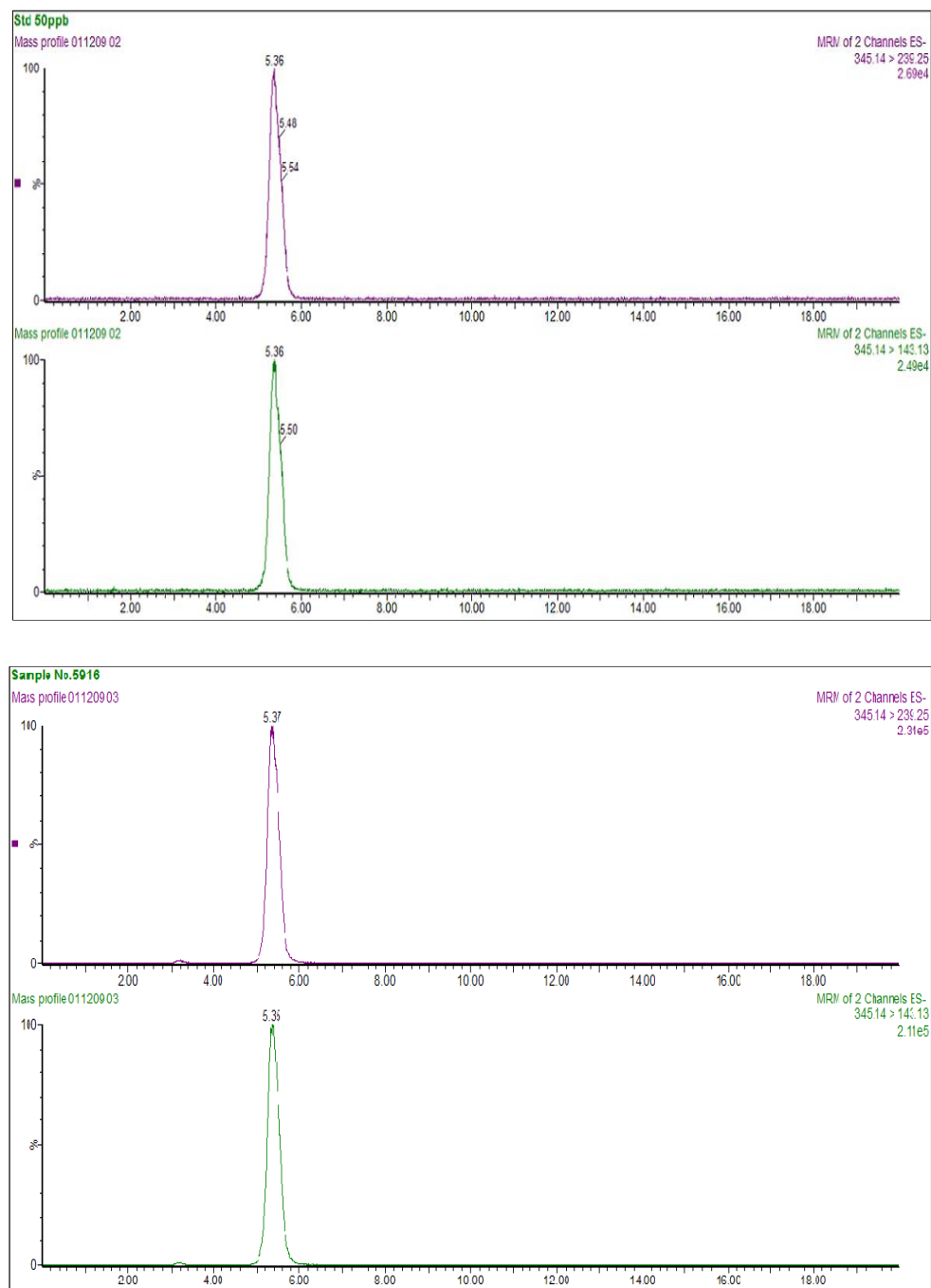

Figure 4.20 Mass spectra of authentic GA₃ and purified GA₃ from the fermentation broth

^1H NMR spectra of the standard and purified GA_3 were taken and both the spectra were comparable. The spectra are presented in Fig. 4.21 and Fig. 4.22 respectively.

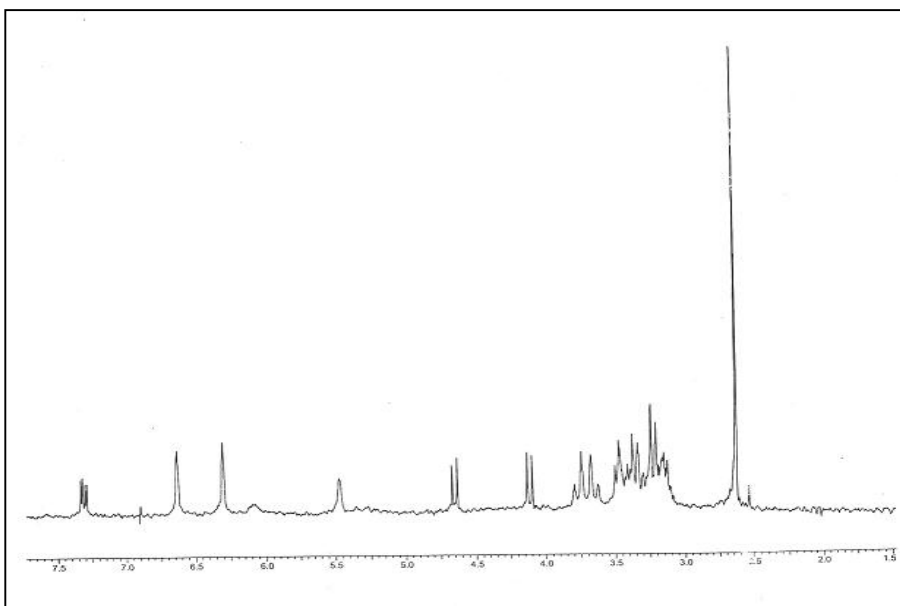

Figure 4.21 ^1H NMR spectra of the standard GA_3

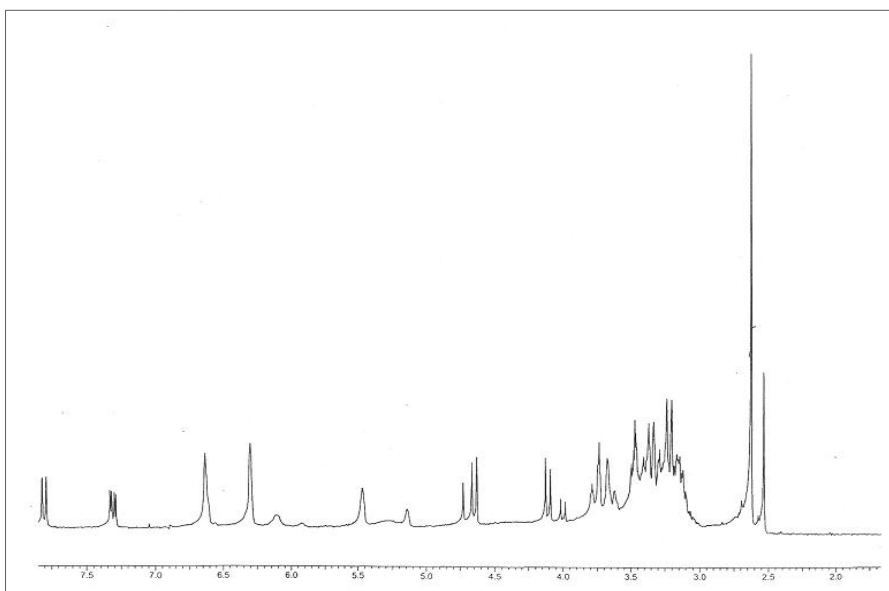

Figure 4.22 ^1H NMR spectra of the purified GA_3 from fermentation broth

4.4 CONCLUSIONS

Developing an optimal production process for GA₃ requires both genetic strain improvement and optimization of culture conditions such as media composition, pH, temperature, fermentation techniques. Mut189, a selected morphological mutant strain of *F. fujikuroi* was studied with respect to different nutritional and physiological factors affecting GA₃ production. Based on relatively higher specific gibberellic acid productivity, glucose was selected as suitable carbon source for the production of GA₃. The quality and quantity of nitrogen source played important role on the growth and GA₃ production by Mut189. Organic nitrogen sources supported excellent growth and GA₃ production. Media with complex organic sources such as different plant meals favoured GA₃ biosynthesis. Mut189 produced comparatively higher GA₃ (412 mg/l) without production of pigment in media with defatted soyabean meal. Mut185 did not produce any water soluble or cell bound pigment and this is beneficial for the production of GA₃ because the efforts to remove such undesired compounds during purification of the product can be saved.

Higher cell mass by addition of higher quantities of defatted soyameal did not support GA₃ production presumably due to oxygen limitation. The oxygen transfer is a capacity of a fermentation equipment, particularly the vessel diameter: impeller diameter ratio, number of blades, the number of impellers, the aeration sparger and finally the agitator speed. One has to use suitable medium composition and thus the cell concentration that can be supported by the equipment in terms of oxygen transfer rate. The biosynthesis of gibberellins involves many oxidative steps and therefore good oxygen transfer in the fermentor is critical for an optimal production process. A liquid fermentation medium was formulated so as to meet nutritional requirements and yet sufficient oxygen availability in an agitated fermenter for the growth of Mut185 and GA₃ production. Lower incubation temperature during production phase did not improve GA₃ production in Mut189 while slow decrease in pH was found to be beneficial for maximal GA₃ production.

Maximum GA₃ production obtained in shake flask by mutant Mut189 using optimized medium was 390 mg/l. This mutant was evaluated in a 14 L laboratory fermenter. In order to improve GA₃ production performance of the mutant Mut189,

different fermentation approaches such as batch, fed-batch, repeated batch and extractive fermentation using optimized fermentation medium were experimented.

During batch process, problems associated with maintenance of DO₂ level to higher side, shear of mycelium after 72 h, accumulation of sugar, decrease in productivity of GA₃, catabolite repression as well as increase in oil content were observed.

In batch cultivation in 14 L fermenter, after reaching a maximal GA₃ production rate, a drastic decrease in this activity was noticed. This sharp drop impedes the accumulation of GA₃ and led to lower GA₃ concentration than desired. The main finding in the present study is feeding of glucose in lower quantity (5 g/l/d) with predetermined rates contributes to the maintenance of maximum GA₃ production rate for an extended period of cultivation. Addition of glucose at a very low feed rate of 0.2 g/l/h during the stationary phase helped to run the fermenter in sugar limited condition that resulted in maintenance of higher DO₂ and high GA₃ productivity of 8 mg/l/h for a long time, during fermentation.. Adequate aeration and controlled glucose feed in the culture allowed increase in GA₃ production and could overcome the catabolite repression which seemed to be an apparent regulation.

Controlling DO₂ concentration at 70-80% of air saturation, in fed-batch mode, in the optimized medium resulted in 1440 mg/l GA₃ without formation of undesirable by products such as soluble or cell bound pigments and mycotoxins.

Moreover, by using purification protocol using solid phase extraction, comprising adsorption of the gibberellic acid on a hydrophobic polymeric micro-porous resin, elution with water miscible solvents, followed by solvent-solvent extraction and crystallization resulted in the yield of white, crystalline, gibberellic acid with more than 93% purity. The purified crystals of GA₃ were characterized by melting point, online spectral scanning, LC-MS and ¹H NMR.

The present study involving strain improvement followed by media and process optimization resulted in almost 3 fold increase in GA₃ production over the parent strain. Thus, in the present investigation, a morphological mutant Mut189 of *F. fujikuroi* was developed and the key process parameters for GA₃ production were optimized in 14 L laboratory fermenter.

4.5 REFERENCES

- Aroca, G., Berrios, J., Leo Pyle, D. 2010. Gibberellic acid extraction from aqueous solutions and fermentation broths by using emulsion liquid membranes. *Journal of Membrane Science*, **348**, 91698.
- Avalos, J., Barrero, A.F., Sanchez, J.F., Oltra, J.E., Tamayo, N., Cerda- Olmedo, E., Candau, R. (1991) Fusarin C and 8Z-fusarin C from *Gibberella fujikuroi*. *Phytochemistry*, **30**, 2259-2263.
- Birch, A.J., Manchester, Nixon, I.S., 1961. Process of producing gibberellic acid, *US 2977285*.
- Bruckner. B., Blechschmidt, D., 1991. The gibberellin fermentation. *Critical Reviews in Biotechnology*, **11**, 163-192.
- Bruckner, R., Titgemeyer, F. 2002. Carbon catabolite repression in bacteria: choice of the carbon source and autoregulatory limitation of sugar utilization. *FEMS Microbiology Letters*, **209**, 1416148.
- Borrow, A., Brown, S., Jeffreys, E.G., Kessell, R.H.J., Lloyd, P.B., Rothwell, A., Swait, J.C. 1964. The kinetics of metabolism of *Gibberella fujikuroi* in stirred culture. *Canadian Journal of Microbiology*, **10**, 4076444.
- Buđock, J.D., Detroy, R.W., Hostalek, Z., Munim-Al-Shakarchi, A. 1974. Regulation of secondary metabolism in *Gibberella fujikuroi*. *Transactions of the British Mycological Society*, **62**, 377-389.
- Buđock, J.D., 1982. Useful metabolites of *Fusarium*. In: The applied mycology of *Fusarium*. Moss MO, Smith JE Eds. University press, Cambridge, 1-12.
- Candau, R., Avalos, J., Cerda-Olmedo, E., 1992. Regulation of gibberellin biosynthesis in *Gibberella fujikuroi*. *Plant Physiology*. **100**, 1184-1188.
- Corey, E.J., Danheiser, R.L., Chandrasekaran, S., Siret, P., Keck, G.E., Gras, J.L. 1978. Stereospecific total synthesis of gibberellic acid. A key tricyclic intermediate. *Journal of the American Chemical Society*, **100** (25), 80316 8034.
- Darken, M.A., Jensen, A.L., Shu, P. 1959. Production of gibberellic acid by fermentation. *Applied Microbiology*, **7**, 301-303.
- Demain, A.L. 1986. Regulation of secondary metabolism in fungi. *Pure and Applied Chemistry*, **58**(2), 219-226.

- Demain, A.L. 1989. Carbon source regulation of idiolite biosynthesis. In: Regulation of secondary metabolism in *Actinomycetes*. Shapiro S Ed. Boca Raton, FL: CRC Press.127-134.
- Demain, A.L. 2000. Small bugs, big business:: The economic power of the microbe. *Biotechnology Advances*, **18**(6), 499-514.
- Duran-Paramo, E., Molina-Jimenez, H., Brito-Arias, M.A., Robles-Martinez, F., 2004. Gibberellic Acid Production by free and immobilized cells in different culture systems. *Applied Biochemistry and Biotechnology*, **113-116**, 381-388.
- Dockerill, B., Hanson, J.R. 1981. The effect of exogenous gibberellic acid on gibberellins biosynthesis by *Gibberella fujikuroi*. *Phytochemistry*, **20**, 2679-2681.
- Escamilla, E.M., Dendooven, L., Magana, I.P., Parra, R.S., De la Torre, M., 2000. Optimization of gibberellic acid production by immobilized *Gibberella fujikuroi* mycelium in fluidized bioreactors. *Journal of Biotechnology*. **76**, 1476155.
- Escamilla-Silva, E.M., Dendooven, L., Reynell, U.J.A., Ramirez, M.A.I., Alatorre, G.G.L., Martinez, M.T. 1999. Morphological development and gibberellin production by different strains of *Gibberella fujikuroi* in shake flasks and bioreactor. *World Journal of Microbiology and Biotechnology*, **15**, 753-755.
- Fuska, J., Kuhr, I., Podojil, M. Sevcik, V. 1961. The influence of nitrogen source on the production of gibberellic acid in submerged cultivation of *Gibberella fujikuroi*. *Folia Microbiologica*, **6**, 18-21.
- Giordano, W., Avalos, J., Cerda-Olmedo, E., Domenech, C.E. 1999. Nitrogen availability and production of bikaverin and gibberellins in *Gibberella fujikuroi*. *FEMS Microbiology Letters*, **173**, 3896393.
- Martin, J.F., Gloria, R., Lopez-Nieto, M. J., Luengo, J.M. 1984. Carbon catabolite repression of penicillin biosynthesis by *Penicillium chrysogenum*, *The Journal of Antibiotics* **37**(7), 781-789.
- Gallazzo, J.L., Lee, M.D. 2001. Production of high titers of gibberellins, GA₄ and GA₇ by strain LTB-1027, *US 6287800*.
- Giordano, W., Domenech, C.E. 1999. Aeration affects acetate destination in *Gibberella fujikuroi*. *FEMS Microbiology Letters*, **180**, 111-116.

- Heropolitanski, R., Kominiak, M.J., Machalowska, M. 1994. Method of isolating gibberellins from aqueous solutions, *PL 163608*.
- Hodgson, D.A. 2000. Primary metabolism and its control in Streptomycetes: a most unusual group of bacteria. *Advances in Microbial Physiology*, **42**, 47-238.
- Hollmann, D., Geipel, S., Switalski, J., Onken, U. 1995. Extractive fermentation of gibberellic acid by *Gibberella fujikuroi*. *Journal of fermentation and Bioengineering*, **79**, 594-600.
- Holme, T., Zacharias, B. 1965. Gibberellic acid formation in continuous culture. *Biotechnology and Bioengineering*, **7**: 405-415.
- Jefferys, E.G. 1970. The gibberellin fermentation. *Advances in Applied Microbiology*, **13**, 283-316.
- Karakoc, S., Aksoz, N. 2006. Some optimal cultural parameters for gibberellic acid biosynthesis by *Pseudomonas sp.* *Turk Journal of Biology*, **30**, 81-85.
- Kende, H. 1967. Preparation of radioactive gibberellin A1 and its metabolism in dwarf peas *Plant Physiology*, **42**, 1612-1618.
- Khalaf, M.A., Samir, A.M. 2009. Biosynthesis of gibberellic acid from milk permeate in repeated batch operation by a mutant *Fusarium moniliforme* cells immobilized on loofa sponge. *Bioresource Technology*, **100**, 3746379.
- Kumar, P.K.R., Lonsane, B.K. 1987. Gibberellic acid by solid state fermentation: Consistent and improved yields. *Biotechnology and Bioengineering*, **30**, 267-271.
- Kumar, P.K.P., Lonsane, B.K. 1988. Immobilized cells of *Gibberella fujikuroi* P3 for production of gibberellic acid and pigment in batch semi-continuous culture. *Applied Microbiology and Biotechnology*, **28**:537-542.
- Kumar, P.K.P., Lonsane, B.K. 1989. Microbial production of gibberellins: State of the art. *Advances in Applied Microbiology*, **34**, 29-138.
- Lai, L.S.T., Tsai, T.H., Wang, T.C., Cheng, T.Y. 2005. The influence of culturing environments on lovastatin production by *Aspergillus terreus* in submerged cultures. *Enzyme and Microbial Technology*, **36**, 737-748.
- Li, Z., Lei, J., Zhang, D. 1992. Solvent extraction of gibberellins from fermentation filtrate, *CN 1063309*.
- Malonek, S., Bomke, C., Bornberg, B.E., Rojas, M.C., Hedden, P., Hopkins, P., Tudzynski, B. 2005. Distribution of gibberellin biosynthetic genes and

- gibberellin production in the *Gibberella fujikuroi* species complex. *Phytochemistry*, **66**, 1296-1311.
- Marasas, W.F.O., Thiel, P.G., Rabie, C.J., Nelson, P.E., Toussoun, T.A. 1986. Moniliformin production in *Fusarium* section *Liseola*. *Mycologia*, **78**(2), 242-247.
- Martin, J.F., Gloria, R., Manuel, J.L.N., Luengo, J.M. 1984. Carbon catabolite repression of penicillin biosynthesis by *Penicillium chrysogenum*. *The Journal of Antibiotics*, **32**(7), 781-789.
- Moghe, P.P., Gadre, R.V., Pol, A.V., Kotasthane, M.G., Bahirat, P.K., Mane, M.V. 2001. An improved process for the separation of Gibberellic acid from the fermented broth containing other gibberellins, *IN184642*.
- Nava-Saucedo, J.E., Barbotin, J.N, Thomas, D. 1989. Physiological and morphological modification in immobilised *Gibberella fujikuroi* mycelia. *Applied and Environmental Microbiology*, **55**, 2377-2384.
- Neumann, E., Mueller, S., Butter, E., Fengler, B., Kramer, P., Koellner, H., Kuenstler, R., Ludwig, J., Haeckert, H. 1989. Isolation of gibberellins from culture filtrate, *DD 266591*.
- Pastrana, L.M., Gonzalez, M.P., Torrado, A., Murado, M.A. 1993. Production of gibberellic acid from mussel processing waste in submerged batch culture. *Bioresource Technology*, **45**, 213-221.
- Pastrana, L.M., Gonzalez, M.P., Torrado, A., Murado, M.A. 1995. A fed batch culture model for improved production of gibberellic acid from waste medium. *Biotechnology Letters*, **17**, 263-268.
- Prema, P, Thakur, M.S., Prapulla, S.G., Ramakrishna, S.V., Lonsane, B.K. 1988. Gibberellin preparation using *Gibberella fujikuroi*, *Fusarium moniliforme* or *Botryodiplodia theobromae*. *Indian Journal of Microbiology*, **28**, 78-84.
- Rademacher, W. 1997. Gibberellins. In: *Fungal biotechnology*, Anke T Ed. Chapman and Hall, London, 193-205.
- Sanchez, B., Sanchez, S., Sanchez, M., Chavez, B., Forero, A., Garcia, H.A., Romero, Y., Rocha, A., Rodriguez S.D., Langley, E. 2010. Production of microbial secondary metabolites: Regulation by the carbon source. *Critical Reviews in Microbiology*, **36**(2), 146-167.
- Sanchez, S., Demain, A.L. 2002. Regulation of fermentation processes. *Enzyme and Microbial Technology*, **31**, 895-906.

- Shivkumar, U., Karthikeyan, S., Sabarinathan, K.G. 2010. Gibberellic acid production by *Fusarium fujikuroi* SG2. *Journal of Scientific and Industrial Research*, 211-214.
- Shukla, R., Chand, S., Srivastava, A.K. 2007. Production of Gibberellic Acid by multiple fed-batch cultivation of *Gibberella fujikuroi* *Chemical and Biochemical Engineering*. **21** (2) 159-162.
- Shukla, R., Chand, S., Srivastava, A.K. 2005. Improvement of gibberellic acid production using a model based fed-batch cultivation of *Gibberella fujikuroi*. *Process Biochemistry*, **40**, 2045-2050.
- Shukla, R., Chand, S., Srivastava, A.K. 2005. Batch kinetics and modeling of gibberellic acid production by *Gibberella fujikuroi*. *Enzyme and Microbial Technology*, **36**, 492-497.
- Shukla, R., Srivastava, A.K., Chand, S. 2003. Bioprocess strategies and recovery processes in gibberellic acid fermentation. *Biotechnology and Bioprocess Engineering*, **8**, 269-278.
- Rachev, R.C., Rouseva, R.P., Bojkova, S.V., Gancheva, V.K. 1993. Isolation of gibberellic acid produced by *F. moniliforme*. *Journal of Natural Products*, **56**, 1168-1170.
- Rangaswamy, V. 2012. Improved Production of Gibberellic Acid by *Fusarium moniliforme* *Journal of Microbiology Research*, **2**(3), 51-55.
- Robinson, T, Singh, D., Nigam, P. 2001. Solid state fermentation a promising microbial technology for secondary metabolite production. *Applied Microbiology and Biotechnology*, **55**, 284-289.
- Titgemeyer, F., Hillen, W. 2002. Global control of sugar metabolism: a gramó positive solution. *Antonie van Leeuwenhoek International Journal of General and Molecular Microbiology*, **82**, 59-71.
- Tudzynski, B. 1999. Biosynthesis of gibberellins in *Gibberella fujikuroi*: biomolecular aspects. *Applied Microbiology and Biotechnology* **52**, 298-310.
- Tudzynski, B., Songjie, L., Kelly, J.M. 2000. Carbon catabolite repression in plant pathogenic fungi: isolation and characterization of the *Gibberella fujikuroi* and *Botrytis cinerea* creA genes. *FEMS Microbiology Letters*, **184**, 9-15.

Vass, R.C., Jefferys, E.G. 1979. Gibberellic acid. In: *Economic microbiology, Volume3*, Secondary products of metabolism. Rose AH Ed. Academic Press, London, 421-435.

Chapter 5

Gibberellin A₄ Production

Abstract:

This chapter describes screening of strains of *Fusarium fujikuroi* obtained from NCIM and mutants selected for higher gibberellin production, for their ability to produce GA₄. The basal medium used for screening of GA₄ producing strain was same as the medium (LMF), optimized for GA₃ production. Mut189, selected for maximal GA₃ production was subsequently chosen based on short filament morphology, relatively higher Gibberellin A₄ (GA₄), total gibberellin production and lack of pigmentation. Mutant Mut189 was investigated further to enhance GA₄ production by optimizing medium constituents and environmental conditions. Under two different culture conditions, Mut189 worked in two different ways. It produced GA₄ as the major metabolite and a small amount of GA₃ as co-metabolite in medium containing wheat gluten as nitrogen and glucose as carbon source. While it produced GA₃ as the major metabolite and small amount of GA₄ as co-metabolite in media containing defatted soyabean meal as nitrogen and glucose as carbon source. The type of gibberellin produced by the Mut189 was dependent on the type of organic nitrogen provided in the medium, in addition to the pH of the fermentation broth. This is the first report of use of wheat gluten for substantially high production of GA₄ by *F. fujikuroi*.

5.1 INTRODUCTION

Fusarium fujikuroi is the most prolific producer of the gibberellins and GA₃ is usually the major gibberellin produced. The most important bioactive gibberellins are GA₁, GA₃, GA₄ and GA₇. They belong to C₁₉-gibberellins group and exhibit their effect during different stages of plant growth like seed germination, stem and petiole elongation, leaf expansion, flower induction as well as growth of seed and fruit (Bruckner and Blechschmidt, 1991). At present, species belonging to *Fusarium*, *Spheceloma*, *Neurospora* and *Phaseosphaeria* have been reported to produce gibberellins. These fungi produce GA₃ and/or GA₄ as final metabolite (MacMilan, 2002). Production of gibberellins by bacteria has been reviewed by Bottini *et al.*, (2004) however; reported concentrations are very low and in the range of nanograms per liter (Kang *et al.*, 2009).

Ascomycetous fungus *F. fujikuroi* belonging to mating population C₀ is capable of producing gibberellins in industrially viable quantities (Takahashi *et al.*, 1991; Malonke *et al.*, 2005). Although the main product of gibberellin biosynthesis in *F. fujikuroi* is GA₃, it produces its precursors gibberellin A₄ (GA₄) and gibberellin A₇ (GA₇) also (Tudzynski, 1999). GA₄ and GA₇ are also important gibberellins because they possess bioactivities different than GA₃ and are immediate precursors of GA₃. Usually the published reports on gibberellin biosynthesis have been focused mainly on the screening of microbial strains which produce GA₃ with high yield and productivity followed by the optimization of process parameters in batch and fed-batch fermentation. Very few researchers have reported high GA₄ and GA₇ producing strains of *F. fujikuroi* that do not produce GA₃, indicating that the desaturase, for conversion of GA₄ to GA₇, and the 13-hydroxylase, for conversion of GA₇ to GA₃, are inactive or missing in these fungi (Rademacher, 1992).

During last few years, commercial interest for production of GA₄ has increased because of its horticulture uses. The requirement of the amount of GA₄ varies, depending on the crop but is generally applied in the range of 5 to 50 mg/l. Gibberellin A₄ (GA₄) was isolated and identified in culture filtrate of *Phaseosphaeria* sp. L487 by Sassa and Suzuki (1989). Improved gibberellin fermentation and biosynthetic gene study revealed that not GA₄ but GA₁ is the final metabolite in this species (Kawaide and Sassa, 1993). Another fungus *Sphaceloma manihoticola*,

causing 'super elongation' disease of cassava, produces GA₄ as the major gibberellin component (Zeigler *et al.*, 1979) without producing GA₃ and GA₇. The flanking genes of the *F. fujikuroi* gene cluster are absent in *Sphaceloma*. As a consequence, the biosynthetic pathway ends with GA₄ instead of being further converted to GA₇, GA₁, and GA₃, as occurs in *F. fujikuroi* (Bomke *et al.*, 2008)

The concentration of GA₄ in the fermentation broth of *Sphaceloma manihoticola* however, was only 7 mg/l (Graebe and Rademacher, 1979) and 20 mg/l (Rademacher, 1992) respectively. *Penicillium citrinum* KACC 43900, an endophytic fungus of cereal plants produces 6.03 microgram/l GA₄ (Khan *et al.*, 2008). Another fungus, *F. proliferatum* KGL0401 isolated from the root of *Physalis alkekengi var frencheti* produced 17.3 microgram l⁻¹ GA₄ after seven days of incubation in Hagemø medium (Rim *et al.*, 2005). A US patent (Gallazzo and Lee, 2001) describes production of GA₄ using *F. fujikuroi* LTB-1027 in which a mixture of equal quantities of GA₄ and GA₇ were obtained. This patent reports 800 mg/l total gibberellin concentration, in which the ratio of GA₄₊₇: GA₃ was 4:1. As GA₄ and GA₇ are produced in lower yield by commercial fermentations, these gibberellins are about 300 times expensive than GA₃ and therefore are not widely used in agriculture and horticulture. Commercially, they are available in the form of a mixture because their separation from each other is difficult and uneconomic (Gallazzo and Lee, 2001).

The mixture of GA₄₊₇ primarily stimulates flowering and elongation of fruit cells. Growers of apples, pears and grapes use mixture of GA₄ and GA₇ to produce larger fruits and an early harvest. GA₄₊₇ mixture is used on 'Golden Delicious' apples to effectively prevent abnormal cell divisions in the epidermal layer that lead to undesirable "russetting" (Bruckner and Blechschmidt, 1991). GA₄₊₇ in combination with benzyl-adenine enhance post-production quality of tulip flowers (Kim and Millar, 2009). It is reported that this mixture also increases yield of hot pepper (Batlang, 2008). Application of this mixture prevents cold-induced leaf chlorosis in Eastern and hybrid lilies. GA₄₊₇ mixtures also promote seed cone production in numerous *Pinaceae* species. This enables a better seed production for economically important forest trees. GA₄ promotes fruit set of apples and it is also used for fruit thinning, changing fruit shape and size, increasing weight of single fruit, thickening

skin and prolonging the shelf life. During last few years, commercial interest for production of GA₄ and GA₇ has increased because of their horticulture uses.

Amount and the type of gibberellins produced by *F. fujikuroi* is dependent on the genetic constitution of the strain and fermentation conditions like aeration, type of carbon and nitrogen source and pH of the fermentation medium. The main product of gibberellin biosynthesis in *F. fujikuroi* is GA₃, with traces of GA₄ and GA₇. Certain horticultural applications require specifically GA₄. Commercially it is available in the mixture form as GA₄₊₇ and highly expensive. Very little information has been published describing the production of GA₄ by *F. fujikuroi* and the fermentation conditions. Therefore strains that produce GA₄ in the absence of GA₃ and GA₇ would have considerable importance.

The present chapter describes screening of wild strains of *Fusarium fujikuroi* obtained from NCIM and mutants selected for higher GA₃ productivity for their ability to produce GA₄ and identification of medium constituents and environmental conditions for effective production of gibberellin A₄ (GA₄).

5.2 MATERIAL AND METHODS

5.2.1 Microorganisms

Four fungal strains namely *F. fujikuroi* NCIM 665, *F. fujikuroi* NCIM 850, *F. fujikuroi* NCIM 892, *F. fujikuroi* NCIM 1019 were obtained from National Collection of Industrial Microorganism (NCIM), National Chemical Laboratory, Pune, India. *F. fujikuroi* mutants, Car1, Mut4, Mut65, Mut189 and Mut226 which were generated during strain improvement programme for increased gibberellin production from glucose, were also used in the present investigation. During the course of study, these cultures were maintained on PDA agar slants (HiMedia Mumbai, India) supplemented with yeast extract at 2 g/l. All media ingredients and analytical methods were same as described in chapter 2 and 3 unless otherwise mentioned.

5.2.2 Media

All media ingredients were purchased from HiMedia, Mumbai India. Wheat flour was purchased locally.

1) Potato Dextrose agar (PDA)

Ingredient	Conc. g/l
Potato infusion	200
Yeast Extract	2
Dextrose	20
Agar	15

2) Liquid Medium for Fermentation (LMF)

Ingredient	g/l
KH_2PO_4	1.5
NaCl	0.5
$\text{MgSO}_4 \cdot 7\text{H}_2\text{O}$	0.2
$\text{Na}_2\text{MoO}_4 \cdot 2\text{H}_2\text{O}$	0.05
Glucose	30.0
Defatted soyabean meal	9.0
Trace mineral solution	1 ml
pH	6.8 before autoclaving

3) Trace Mineral Solution

Ingredient	g/l
$\text{CaCl}_2 \cdot 7\text{H}_2\text{O}$	1.0
$\text{MnCl}_2 \cdot 7\text{H}_2\text{O}$	0.1
$\text{CuCl}_2 \cdot 7\text{H}_2\text{O}$	0.05
FeCl_2	0.1
H_3BO_3	0.1
ZnSO_4	0.1

Dissolve the ingredients and add few drops of concentrated HCl till solution becomes clear

4) Liquid Fermentation Medium (LFM)

Ingredient	g/l
KH ₂ PO ₄	1.5
NaCl	0.5
MgSO ₄ ·7H ₂ O	0.2
Na ₂ MoO ₄ ·2H ₂ O	0.05
Glucose	30.0
Wheat gluten	20.0
Trace mineral solution	1 ml
pH	6.8 before autoclaving
CaCO ₃	3.0

Flow Sheet of Work

***Screening of Fusarium Strains and Mutants of F.
fujikuroi for Production of GA₄***



Effect of pH Control on GA₄ Production



***Screening of Different Nitrogen Sources
for GA₄ Production***



***Fractionation of Wheat Flour
by Laboratory- Scale Dough Process
for Wheat Gluten preparation***



***Utilization of Carbon Sources for Growth and
GA₄ Production***



GA₄ Production in 10 L Fermenter

5.2.3 Culture conditions

5.2.3.1 Tube cultures

In case of tube cultures, a small mycelial mat from fresh slant culture was suspended in 2 ml sterile physiological saline and teased with a straight inoculating wire and inoculated into 5 ml liquid media in 150 × 25 mm test tubes without rim and the tubes were incubated at 28 °C, 220 rpm, for 48 h.

5.2.3.2 Shake flask cultures

Throughout the experiments for shake flask cultures, 45 ml liquid fermentation medium in 250 ml Erlenmeyer flasks was used. Five ml seed culture grown, as above, was used to inoculate the 45 ml sterile medium thus making the total initial volume 50 ml. The basal medium used for GA₄ production was same as the medium optimized for GA₃ production. A variety of carbon sources were screened for their effect on type of gibberellin produced by the selected mutant and substituted for glucose at 60 g/l and other nitrogen sources substituted for defatted soyabean meal were on equal nitrogen basis. Carbon sources were autoclaved separately for all the experiments and later mixed with other media components. All shake flask experiments were performed in duplicate, for 168 h, unless otherwise mentioned. At the end of the incubation period, final volume of the culture broth was adjusted to 50 ml by sterile distilled water to compensate for evaporative loss of water during incubation. Care was taken that the shake flask cultures do not remain stationary even for a few minutes during sample withdrawal from the flasks.

5.2.4 Screening of cultures for production of GA₄

The cultures obtained from NCIM and the mutants selected for higher GA₃ production were studied for GA₄ production by inoculating respective cultures in 250 ml Erlenmeyer flasks with 50 ml LMF and incubating the flasks at 28 °C, for 168 h. At the end of 168 h incubation, volume of the broth was adjusted to 50 ml with distilled water. At the end of incubation, the culture broth was filtered over Whatman No 1 qualitative filter paper circle under vacuum. The filtrate was collected and stored. The cell mass residue was washed with three volumes of distilled water, observed for pigmentation and used for dry cell weight (DCW) determination at 103

°C. The fermented broth filtrate was analyzed for pH, residual sugar content and GA₄ and GA₃ concentration by two separate high performance liquid chromatography (HPLC) methods described earlier (Chapter 2).

5.2.5 Effect of pH on GA₄ production

During the experiments described above, pH of the broth decreased to 2.5. Therefore possibility of decrease in GA₄ production due to decrease in pH was investigated by addition of sterilized 3 g/l calcium carbonate to the flask at the time of inoculation to avoid lowering of pH. The flasks were incubated at 28 °C, for 168 h and samples were analyzed as described earlier. Calcium carbonate powder was weighed in Erlenmeyer flask and autoclaved separately before addition of sterile liquid medium for fermentation. The unutilized CaCO₃ was dissolved off by the addition of 10N HCL. This acid addition was also for the correct estimation of the dry cell mass and converting the Ca-gibberellic acid, if any, into free gibberellic acid.

5.2.6 Preparation of wheat gluten

Fractionation of wheat flour to recover wheat gluten was done by a conventional laboratory scale dough process (Borghet *et al.*, 2005). Wheat flour dough was made from very fine wheat flour and kept in cold water (10 °C) for 15 min. This allowed hydration and resulted in gluten agglomeration. A handful of dough was held under running tap water. This dough was squeezed repeatedly under running water until it became a rubbery mass. This rubbery mass was considered to be wheat gluten and the yield was about 10% (w/w). The wet wheat gluten was lyophilized, ground finely and used in the fermentation medium as nitrogen source. The nitrogen content of prepared gluten was determined by flash combustion method using Flash EA, 1112 series, Thermo Finnigan elemental analyser. Steps involved in preparation of wheat gluten are summarized in Fig. 5.1.

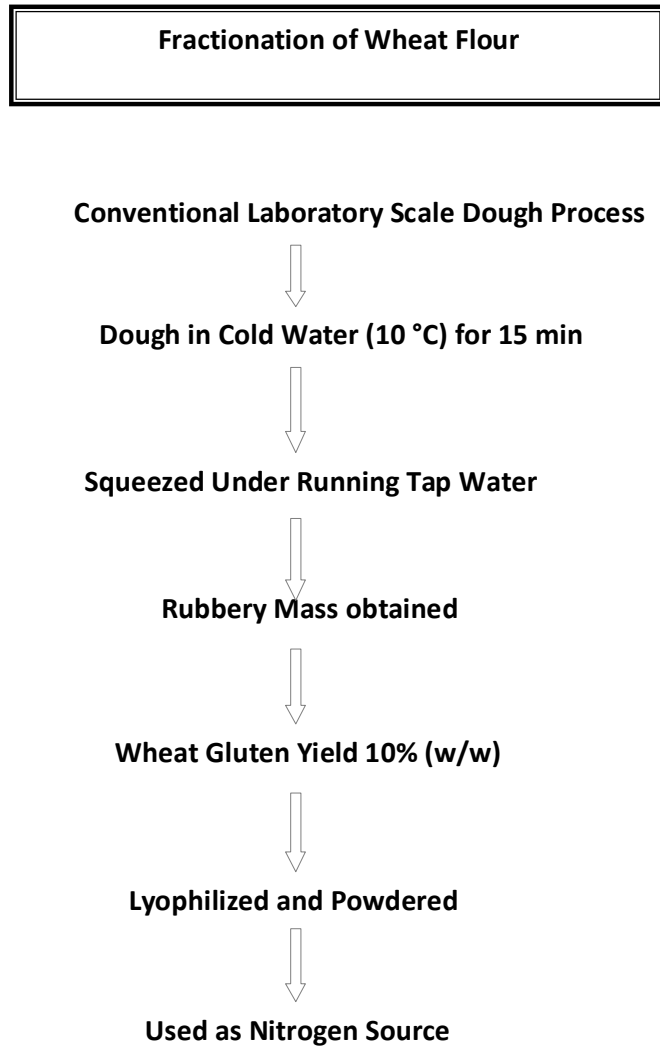

Figure 5.1 Preparation of wheat gluten by conventional laboratory scale dough process

5.2.7 Choice of carbon source for GA₄ production by mutant Mut189

Utilization of carbon sources namely glucose, sucrose, soluble starch, corn insoluble starch, dextrin, maltodextrin, amylase and amylopectin was investigated for growth and GA₄ production by mutant Mut189. LMF media containing different carbon sources were prepared with 20 g/l wheat gluten as the nitrogen source. The carbon sources (equivalent to 24 g l⁻¹ δCö) were autoclaved separately and later added to remaining constituents of LMF. To investigate effect of control of pH around 5, sterile CaCO₃ (150 mg) was added to the flasks. The flasks were inoculated with seed culture of selected mutant strain Mut-189, grown in 5 ml liquid fermentation

medium with respective sugars for 48 h at 28 °C, 220 rpm. The flasks were incubated for 168 h at 28 °C, 220 rpm. Samples were analyzed for dry cell weight (DCW), pH, residual sugar as well as GA₄ and GA₃ concentration by high performance liquid chromatography (HPLC).

5.2.8 Screening of different nitrogen sources for GA₄ production by Mut189

The shake flask experiments were performed to evaluate the nitrogen sources for gibberellin (GA₃ and GA₄) production by Mut189 strain. The effect of nitrogen source was studied in the LMF media with different inorganic and organic nitrogen sources on equal basis of nitrogen (equivalent to 0.55 g/1N) and glucose (24 g/1 C) as carbon source. The inorganic nitrogen sources *viz.* ammonium nitrate, ammonium sulphate, and ammonium chloride and organic nitrogen sources *viz.* yeast extract, soya peptone, wheat gluten, defatted cottonseed meal, peanut meal and soyabean were surveyed for mutant Mut189 on which it could grow and produce GA₄. Wheat gluten used was prepared as described above in 5.2.5. The 50 ml media with respective nitrogen sources in 250 ml Erlenmeyer flasks were inoculated with 48 h respective seed cultures described earlier. The shake flasks were incubated at 28 °C, 220 rpm on rotary shaker for 168 h. Samples were analyzed for pH, dry cell mass, GA₃ and GA₄ concentration by HPLC.

5.2.9 Evaluation of GA₄ production in 10 L fermenter by mutant Mut189

Fermentation batches were carried out with mutant Mut189 to evaluate fermentation conditions for GA₄ production in optimized liquid fermentation medium (LFM). A small mycelial mat of mutant Mut189 from fresh slant culture was suspended in 2 ml sterile physiological saline and teased with a straight inoculating wire and inoculated into 5 ml liquid media in 150 × 25 mm test tubes without rim and the tubes were incubated at 28 °C, 220 rpm, for 48 h. This 5 ml seed culture was transferred into a 250 ml Erlenmeyer flask containing 45 ml LFM and incubated at 28 °C for 48 h. Twenty two such flasks each with 45 ml LFM were prepared and inoculated to produce 1 L inoculum necessary for inoculation of the 10 L fermenter. Ten percent (v/v) of the above seed culture, grown in multiple flasks was then transferred into a fermenter.

The fermentation experiments were performed in 14 L laboratory fermenter (Bio-flow 110, New Brunswick Scientific, USA) with a working volume of 10 L, equipped with devices for control and measurement of pH, temperature, dissolved oxygen and agitation speed. Temperature was maintained at 28 °C by automatic heating or circulating chilled water. The DO₂ was measured with the help of a dissolved oxygen probe (Mettler Toledo). Online fermentation data of process parameters such as DO₂, pH, agitation and feeding strategy was acquired using NBS BioCommand Plus Software.

For the fermentation batches, glucose solution was autoclaved separately in flask and later transferred to the fermenter aseptically, as needed. During the fermentation, separately autoclaved glucose solution (500 g/l) was fed at predetermined sugar feed rate taking care that the culture continues in glucose-limiting condition. The pH was controlled at 7.0 by addition of 5 N NaOH. The DO₂ probe was polarized for four hours after autoclaving, before the fermenter was inoculated. It was calibrated between 0 and 100% air saturation. Zero was adjusted electronically by disconnecting the cable for 30 seconds, followed by saturating the medium with oxygen by sparging air at 0.5 vvm and 700 rpm, and this DO₂ point was set as 100% air saturation. The DO₂ was controlled using the automatic DO₂ controller that increased or decreased the agitation speed to maintain DO₂ at 40% air saturation. Aeration rate was 0.5 vvm unless otherwise mentioned. The foam formation was controlled by periodic addition of food grade silicon oil as antifoam agent. The fermentation was continued for 168 h. Samples were analyzed at successive intervals for dry cell mass, pH, sugar utilized, GA₄ and GA₃ concentration by Reversed Phase HPLC.

5.3 RESULTS AND DISCUSSION

5.3.1 Screening of cultures for production of GA₄

The endeavour was to identify GA₄ producing *Fusarium* strain, to study the strains using various culture conditions and process parameters for further desired improvements in GA₄ yield. GA₄ production using biological processes is becoming more important because of the growing demand of GA₄ in agriculture and horticulture field. Species belonging to *Fusarium*, *Speceloma*, *Neurospora* and

Phaseosphaeria have been reported to produce GA₃ and/or GA₄ as final metabolite (MacMilan, 2002). Amongst the fungi, ascomycetous fungus *F. fujikuroi* belonging to mating population $\delta C\delta$ is capable of producing gibberellins in industrially viable quantities (Takahashi *et al.*, 1991; Malonke *et al.*, 2005). Although the main product of gibberellin biosynthesis in *F. fujikuroi* is GA₃, it produces its precursors gibberellin A₄ (GA₄) and gibberellin A₇ (GA₇) also (Tudzynski, 1999).

On the basis of literature review the strains of *F. fujikuroi* obtained from NCIM and the GA₃ producing mutants generated during the mutagenesis programme of GA₃ production as described in Chapter 3 were screened for GA₄ production in LMF. A separate screening for GA₄ producing cultures became necessary because of the distinct difference in the HPLC analysis of GA₃ and GA₄. The four mutant strains namely Car1, Mut4, Mut65 and Mut189 selected for higher GA₃ production, less pigmentation and altered morphology as short, thick branched mycelium were re-evaluated for their GA₄ production ability using glucose as the carbon source. The type strains of *F. fujikuroi* obtained from NCIM and four mutant strains selected earlier grew well in the fermentation medium with soyabean meal as the nitrogen source and their dry cell mass reached about 17 g/l in all the studied cultures (Table 5.1). When the mutants, the parent strain and *Fusarium sp* from NCIM were grown in 50 ml the liquid fermentation medium, there were distinct differences in growth characteristics and products formed. Strains from NCIM grew profusely in a free, long mycelia form in liquid cultures making the broth very viscous. While mutant strains Mut65 and Mut189 grew with short, thick, highly branched mycelium in liquid culture and the broth had lower apparent viscosity as compared to other strains and the parent. The sugar uptake was nearly equal in all liquid cultures of the strains studied. On screening four *Fusarium* strains from NCIM and four GA₃ producing mutants, five cultures were found to produce GA₄ in LMF as detailed in Table 5.1. There was increase in GA₄ production by the mutants Mut65 and Mut189 as compared to the parent strain and other strains. It can be also seen from Table 5.1 that mutant Mut189 produced maximal GA₄ plus GA₃ (412 mg/l) and GA₄ accounted for 17% of the mixture. Mutant Mut189 produced 71 mg/l GA₄ which was considerably higher than that of other mutants and parent (Table 5.1). The growth of all the strains in the basal medium was similar and this showed that the specific gibberellin productivity of Mut189 was also highest (24.2 mg gibberellins g⁻¹ dry cell

weight). Mutant Mut189 produced 23-fold more GA₄ as compared to the parent *F. fujikuroi* NCIM 1019.

<i>Fusarium sp.</i>	Dry Cell Weight g/l	Total GAs mg/l	GA₃ mg/l	GA₄ mg/l	GA₄/Total GAs %
<i>F. fujikuroi</i> NCIM 1019	17	62	56	6	5
<i>F. fujikuroi</i> NCIM 862	18	29	29	0	0
<i>F. fujikuroi</i> NCIM 850	17	18	18	0	0
<i>F. fujikuroi</i> NCIM 665	16	5	5	0	0
Car1	18	206	194	12	5
Mut4	17	300	298	2	.6
Mut65	18	320	275	45	14
Mut189	17	412	341	71	17

Table 5.1 Screening of *Fusarium* strains from NCIM and selected mutants of *F. fujikuroi* NCIM1019 for GA₄ production in LFM

5.3.2 HPLC Analysis of GA₄

In the present investigation, GA₄ eluted at 12.20 min as shown in Fig. 5.2. The retention volume of GA₄ was 12.2 ml. In the sample broth, two peaks eluted at 10.38 and 12.26 min, respectively. Online spectral scanning performed between 200 and 350 nm at a difference of 5 nm showed peak purity index of 99 % for the standard GA₄ and had maximal absorbance at 205 nm. The peak at 12.26 min in the chromatogram of sample broth had identical spectral pattern to the standard GA₄ peak at 12.20 min. Barendse and Van de werken (1980) and Gallazzo and Lee (2001) have described chromatographic separation of GA₄ and GA₇. These investigators have mentioned that under the chromatographic conditions they used, GA₇ eluted just before GA₄ with the retention time difference of about a minute. The chromatographic conditions that we used in the present investigation like column, mobile phase, temperature and detector were similar to those described by these investigators. In the present investigation, GA₄ eluted at 12.20 min (Fig. 5.2) and there was no peak that could be considered to be GA₇ before GA₄ during the HPLC analysis of fermentation broth samples. A much smaller peak was observed at 10.38 min, which however did not show spectral behaviour like gibberellin during analysis

with on-line spectral analysis using UV-scanning detector and also was not found to be GA₇ with LC-MS. The fermentation broth was thus substantially free of GA₇.

The 3-D spectral scanning showed a peak purity index of 999 for the standard GA₄ peak and had maximal absorbance at 205 nm. GA₄ peak in the chromatogram of the fermentation broth had identical spectral pattern and peak purity index to that of the standard GA₄.

GA₄ was further confirmed by LC-MS by comparison with mass spectra of authentic GA₄ standard from Sigma. Mass spectra of authentic GA₄ from Sigma Chemical Corporation and a sample of fermentation broth are shown in Fig. 5.3 and Fig. 5.3a. Analysis in ES positive mode gave (m/z) 333.28 *i.e.* (M + 1), 315.18, 269.13.

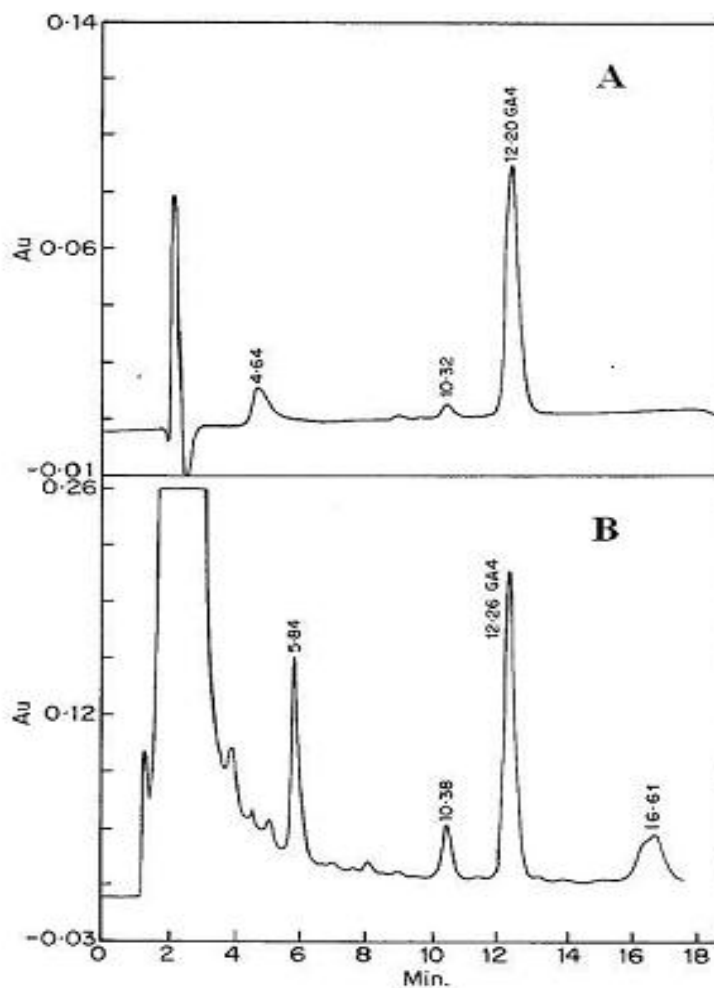

Figure 5.2 Reversed phase HPLC chromatogram of A) standard compound GA₄ B) a sample of fermentation broth

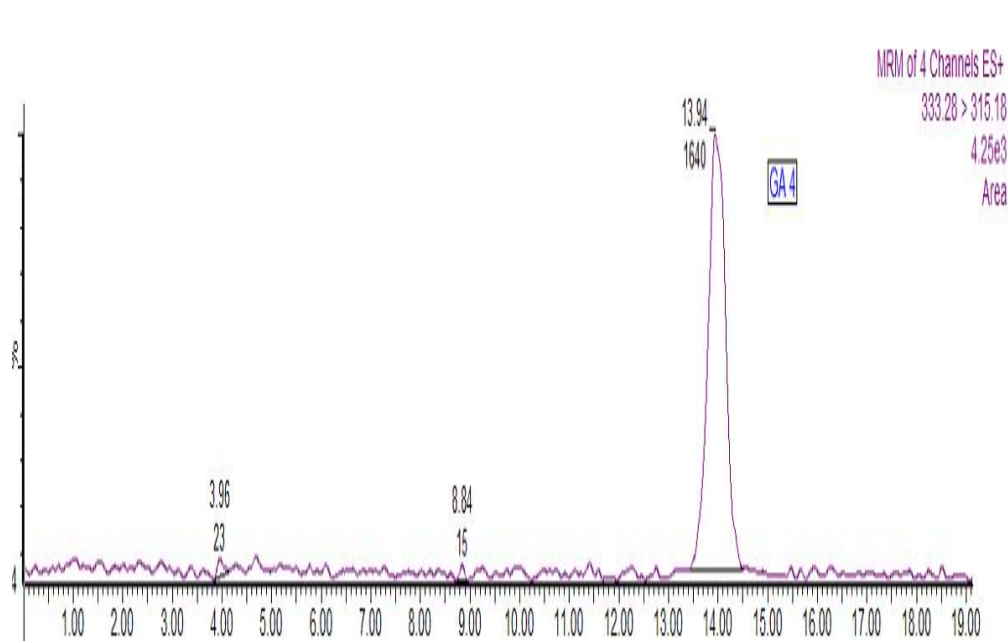

Figure 5.3 Mass spectra of authentic GA₄

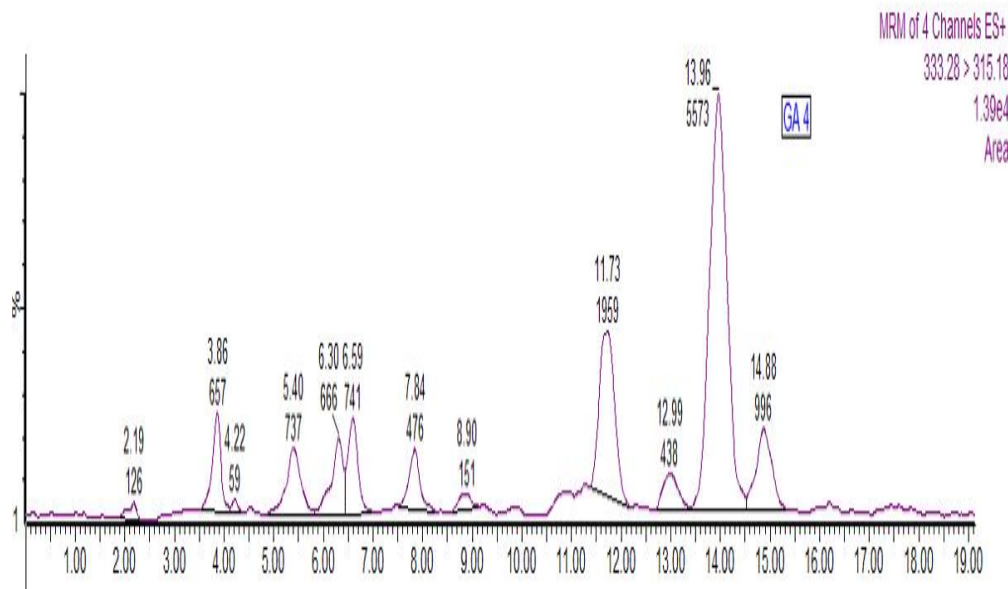

Figure 5.3a Mass spectra of GA₄ from the fermentation broth

5.3.3 Effect of pH control on GA₄ production

In shake flasks it is normally difficult to control pH at any desirable point. The use of sterile CaCO₃ in shake flasks allowed us to maintain pH in the shake flask culture above 5. While in control flasks, without CaCO₃ the pH declined gradually with time and reached in range of 3.0 to 2.5. Growth of all the studied strains was almost similar in the shake flasks with or without CaCO₃, in terms of dry cell mass. Use of hydrochloric acid for dissolution of residual CaCO₃ helped in correct estimation of dry cell mass in the flask. The cultures showed differences in growth characteristics and viscosity similar to that in earlier experiments.

Borrow and their co-workers (1964) had reported that growth and gibberellin production of *F. fujikuroi* were fairly constant over the pH range of 4 to 7 however; the composition of resulting gibberellin mixture significantly depended on the pH value. They reported that at lower pH, GA₃ was the main product while at neutral pH concentrations of GA₄ and GA₇ were higher. In present investigation also the maintenance of pH above 5 using CaCO₃ did not result in any increase in GA₃ production. GA₃ concentrations remained almost equal with and without CaCO₃ addition (Table 5.2). While Gallazzo and Lee (2001) reported the pH control at 5.6 beneficial for GA₄ production by mutants selected specifically for its production. In present study also similar results were obtained. It can be seen from Table 5.2 and Table 5.2a that control of pH around 5.5 exhibited a positive effect on GA₄ production by almost all the studied cultures. Therefore, in subsequent shake flask experiments, pH was controlled above 5 by addition of CaCO₃. This increase in GA₄ concentration was relatively higher in the mutants Mut65 and Mut189. Although percent ratio of GA₄ to total gibberellins was almost equal in these two mutants, GA₄ (94 mg/l) produced by Mut189 was relatively higher than the Mut4 (10 mg/l). The mutant strain Mut189 was used further to study gibberellin A₄ (GA₄) production.

<i>Culture</i>	<i>Dry cell weight g/l</i>	<i>Total GAs mg/l</i>	<i>GA₃ mg/l</i>	<i>GA₄ mg/l</i>	<i>GA₄/Total GAs %</i>
<i>F. fujikuroi</i> NCIM 1019	18	77	70	7	7.8
<i>F. fujikuroi</i> NCIM 862	17	80	52	28	35
<i>F. fujikuroi</i> NCIM 850	17	34	34	0	0
<i>F. fujikuroi</i> NCIM 665	15	5	5	0	0
Car1	17	220	200	20	9
Mut4	18	310	300	10	3.2
Mut65	18	380	300	80	21
Mut189	18	444	350	94	21

Table 5.2 GA₄ production in shake flask with CaCO₃

<i>Culture</i>	<i>Dry cell weight g/l</i>	<i>Total GAs mg/l</i>	<i>GA₃ mg/l</i>	<i>GA₄ mg/l</i>	<i>GA₄/Total GAs %</i>
<i>F. fujikuroi</i> NCIM 1019	17	59	54	5	8.5
<i>F. fujikuroi</i> NCIM 862	18	27	27	0	0
<i>F. fujikuroi</i> NCIM 850	17	20	20	0	0
<i>F. fujikuroi</i> NCIM 665	16	7	7	0	0
Car1	18	206	192	14	6.8
Mut4	17	301	298	3	0.99
Mut65	18	319	275	44	13.8
Mut189	17	413	340	73	17.7

Table 5.2a GA₄ production in shake flasks without CaCO₃

5.3.4 Choice of carbon source for GA₄ production by mutant Mut189

Results presented in Table 5.3 show that irrespective of carbon source used, growth of Mut-189 was almost similar. Growth of Mut189 in terms of dry cell mass was in the range of 17-18 g/l. Morphologically no distinct difference was observed in the mycelia of the cultures. Effect of various carbon sources on GA₄ production by mutant Mut189 revealed that gibberellin production pattern (*i.e.* relative concentration of GA₄ and GA₃) was dependent on the type of carbon source used. The ratio of GA₄ to total gibberellin varied from 2% to 30% depending upon the

carbon source used. Mut189 produced relatively more GA₄ when glucose, dextrin, starch, and sucrose were used in combination with soyabean meal. In media containing amylose, amylopectin and maltodextrin Mut189 produced very less GA₄, although the growth was almost equal. There was no correlation observed between the slow utilizable or rapid utilizable nature of the carbon source and the ratio of the two gibberellins produced. Although ratio of GA₄ to total Gibberellins was comparatively higher for dextrin, glucose was chosen as suitable carbon source as its use resulted in production of considerably higher total gibberellins (422 mg/l) and GA₄ (92 mg/l) .

<i>Carbon Source</i>	<i>Dry cell Weight g/l</i>	<i>Total GAs mg/l</i>	<i>GA₃ mg/l</i>	<i>GA₄ mg/l</i>	<i>GA₄/Total GAs %</i>
Amylose	17.5	310	300	10	3
Amylopectin	17.2	356	247	9	2
Cornstarch (insoluble)	18.0	318	248	70	22
Dextrin type II	17.9	293	211	82	28
Dextrin type III	16.9	289	200	89	30
Glucose	17.1	422	330	92	22
Maltodextrin	17.4	241	240	7	3
Starch	18.1	404	324	80	19
Sucrose	16.8	358	290	68	19

Table 5.3 Choice of carbon sources for GA₄ production by mutant Mut189

5.3.5 Screening of different nitrogen sources for GA₄ production by Mut189

Nitrogen limitation is the prerequisite for GA₄ formation because production of gibberellins starts towards the exhaustion of nitrogen source from the medium. The quality and quantity of nitrogen source used in the medium is known to strongly influence the gibberellin production investigate long ago by Borrow *et al.*, (1964) and therefore C:N of 100:1 was maintained in all the experiments. In the present study, different organic and inorganic nitrogen sources in combination with glucose as carbon source were investigated for the production of gibberellin A₄ (GA₄). Mut189 produced substantially higher quantities of GA₃ in most of the media tested

but the GA₄ proportion to total gibberellins remained below 10% (W/W). Results of effect of different nitrogen sources on GA₄ production by mutant Mut189 are illustrated in Table 5.4.

<i>Nitrogen Sources</i>	<i>Dry cell Weight g/l</i>	<i>Total GAs mg/l</i>	<i>GA₃ mg/l</i>	<i>GA₄ mg/l</i>	<i>GA₄/Total GAs %</i>
Ammonium chloride	14	242	240	2	0.8
Ammonium nitrate	13	214	205	9	4
Ammonium sulphate	13	207	200	7	3
Soyapeptone	19	64	61	3	4.5
Yeast extract	18	45	40	5	11
Soyabean meal	19	371	331	40	10.7
Peanut meal	18	334	308	26	7.8
Cottonseed meal	17	322	297	25	7.7
Wheat gluten	20	283	73	210	74

Table 5.4 Comparison of nitrogen sources for GA₄ production by mutant Mut189

Among the various organic and inorganic nitrogen sources screened, Mut189 showed good growth with complex organic nitrogen sources as presented in Table 5.4. The growth of Mut189 and production of GA₄ was comparatively less in inorganic nitrogen media (Table 5.4) presumably because some of the nutrients available in low quantity in complex media ingredients were not available in the medium with inorganic nitrogen sources. Organic nitrogen sources in the medium also resulted in rapid growth of Mut189. There was no difference in morphology or growth as estimated in terms of dry cell weight when different organic nitrogen sources were used on same nitrogen content basis.

Complex organic nitrogen sources are reported to enhance gibberellin production by *F. fujikuroi* (Fuska *et al.*, 1961). In the present study also, use of complex organic nitrogen sources like plant meals and wheat gluten were found to enhance gibberellin production by mutants of *F. fujikuroi*. However, there was major difference in GA₄ and GA₃ concentration ratio produced by Mut189. Defatted plant meals, yeast extract and soya peptone although resulted in rapid growth, did not support satisfactory GA₄ production. Under identical cultural conditions Mut189 produced 210 mg/l GA₄ in

the medium in which wheat gluten was used as nitrogen source and in this case, the ratio of GA₄: Total Gibberellins was 77% while ratio of GA₄: GA₃ was 3:1.

In the present study, mutant Mut189 produced substantially higher quantities of GA₃ in most of the media tested and the proportion of GA₄ to total gibberellins remained below 10% (W/W). Surprisingly, in a medium in which wheat gluten was used as the sole nitrogen source, the same mutant produced substantially higher quantities of GA₄ (210 mg/l). This was distinctly higher GA₄ concentration than all other experiments. The proportion of GA₄ in wheat gluten medium was 74% to total gibberellins. It was reported that the addition of a suitable nitrogen source reconstitutes the growth of *F. fujikuroi* and also inhibits gibberellin production (Borrow *et al.*, 1964). The genetics and biochemistry of gibberellin production in *F. fujikuroi* has been well characterized in recent years. It has been demonstrated that the expression of six genes including genes coding for desaturase involved in the conversion of GA₄ to GA₃ through GA₇ share a common regulation mediated by nitrogen catabolite regulatory protein AreA (Mihlan, 2003). Our results suggest that the increase in production of GA₄ in a medium composed of wheat gluten might not be an impaired activation of the gene by AreA but probably because of a substance present either in wheat gluten or produced from wheat gluten during growth of *F. fujikuroi* that inhibited activity of 1, 2 GA₄ desaturase converting GA₄ to GA₇. This inhibition was not an effect of oxygen availability in shake flasks because the total cell mass and mycelial morphology were similar in media with wheat gluten and other nitrogen sources.

Thus, wheat gluten was found to be suitable for the GA₄ production by Mut189. The study indicated that not only the pH of medium but the type and quality of nitrogen source played equal role in GA₄ production by mutant Mut189. Amongst all studied organic nitrogen sources wheat gluten was found to be the most suitable nitrogen source for rapid growth of Mut189 and production of higher GA₄ with less GA₃. This is the first report of use of wheat gluten for substantially high production of GA₄ by *F. fujikuroi*.

5.3.6 Evaluation of GA₄ production in 10 L fermenter by mutant Mut189

On inoculating the fermenter with 10% v/v Mut189 inoculum, it was found that the mutant Mut189 grew rapidly in the first 24 h. It grew in desired short mycelial form similar to that in the shake flasks. The mycelium grew in the form of short, thick filaments with very little pigmentation. The colour of fermentation broth was slightly brownish due to produced water soluble pigment. Mycelium was colourless as appeared from filtered and washed cell mass. Fermentation profile of fed-batch run is shown in Fig. 5.4

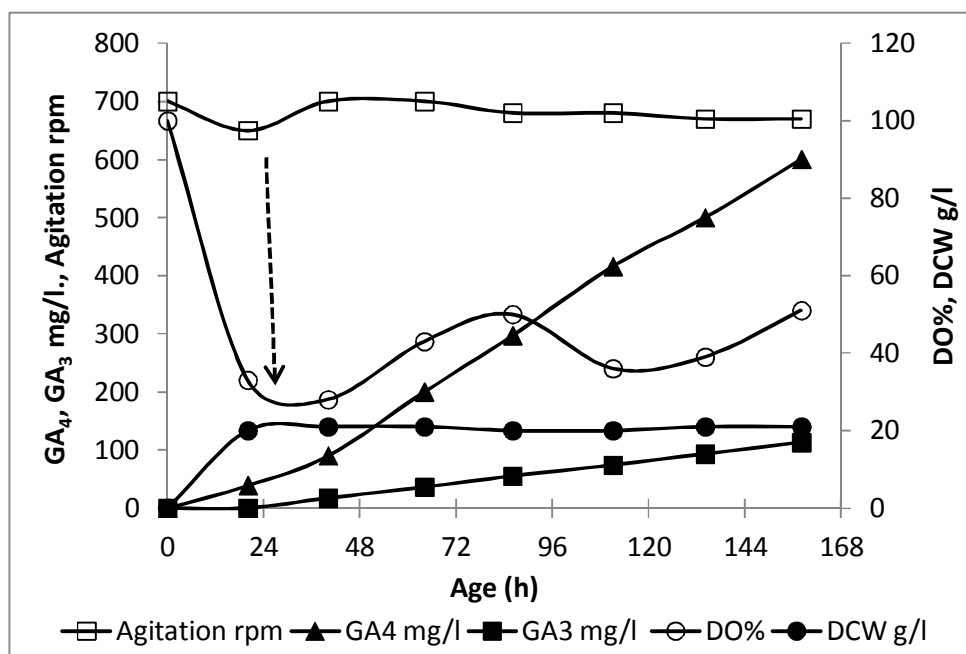

Figure 5.4 Fermentation profile of *F. fujikuroi* mutant Mut189 in LFM medium

In order to avoid DO₂ limitation, it became necessary to adjust the agitation speed so to maintain in the range of 40-50% air saturation during the batch time except early growth phase. It can be seen that most of the biomass growth was achieved in initial 24 h which later on increased to 21 g/l DCW towards the end of batch. In order to avoid DO₂ limitation, the agitation speed was increased from 600 to 700 rpm at 20 h, which was later maintained between 650 to 700 rpm.

Initial 20 g/l glucose was consumed for the biomass generation during first 20 h and glucose concentration reached zero. Most of the glucose in this period was utilized for the growth of the fungus because gibberellins were not detected in first 20 h. The

production of gibberellins began after 24 h toward end of the growth phase as indicated by arrow in Fig. 5.4. Gibberellins are produced by *F. fujikuroi* only after a strict nitrogen limitation in a nutrient medium is achieved (Borrow *et al.*, 1964; BuŁock *et al.*, 1974). In the present investigation also, the gibberellins could be detected only after the culture reached the stationary stage as seen from the stable dry cell mass (Fig. 5.4).

Glucose uptake and GA₄ production rate are illustrated in Fig. 5.5. The average glucose utilization rate by the mutant in the fermenter was 1.0 g/l/h. After 24 h, glucose was fed in the form of sterile, 500 g/l glucose solution in one pulse to achieve a concentration of 10 g/l.

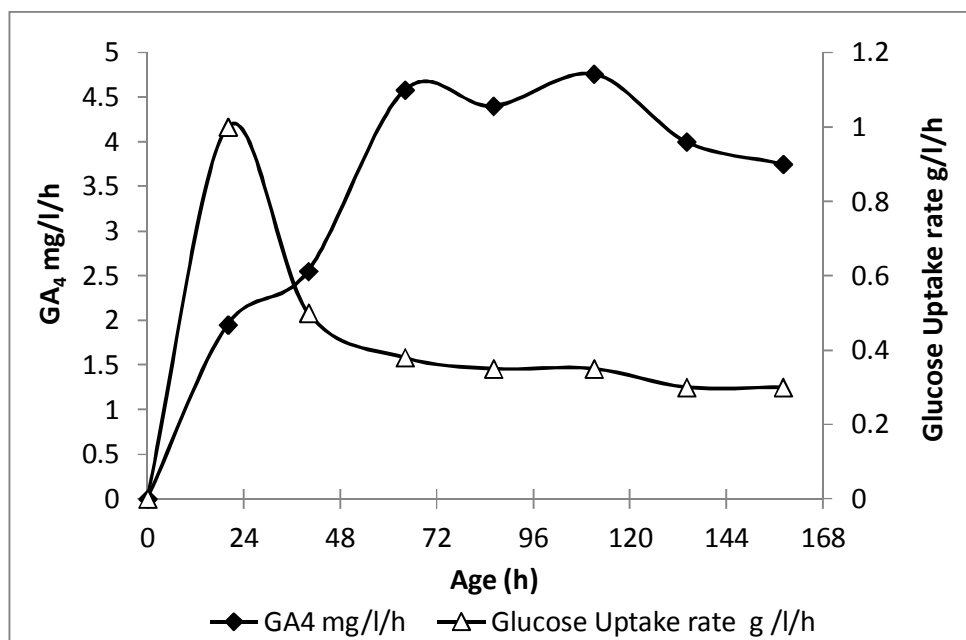

Figure 5.5 Glucose uptake and GA₄ production by mutant Mut189

It can be seen from Fig. 5.5 that between 24 and 40 h, the glucose uptake rate declined to 0.62 g/l/h. Glucose utilization later decreased slowly to 0.35 g/l/h at 65 h and then remained nearly constant till end of the batch. Irrespective of decline in glucose uptake rate, GA₄ production rate remained almost same and thus, there was no direct correlation between glucose utilization rate and GA₄ production rate. This is understandable considering that the overall yield of secondary metabolites per gram sugar fermented is normally very poor.

Between 20 to 40 h, GA₄ production rate was 2.6 mg/l/h. The rate increased to 4.6 mg/l/h at 60 h and remained nearly same till 120 h. This indicated that as the culture reached severe level of nitrogen limitation, the repression caused by nitrogen source decreased and led to increased rate of GA₄ production. As discussed in Chapter 3 it was observed that the GA₃ production rate increased immediately after the culture entered stationary phase and later the rate lowered considerably. The lowering of GA₃ production rate was assumed to be because of lowering pH, cell mass aging or catabolite repression. Similarly in present investigation, the rate of GA₄ production started to decline after five days and reached 3.8 mg/l/h. By controlling pH and with careful control of glucose feeding rate so as to achieve glucose limiting condition during stationary phase, it was possible to maintain the GA₄ production rate above 4 mg/l/h over a considerable length of time between 60 and 144 h this resulted in a very high GA₄ concentration.

Earlier report on the concentration of GA₄ in the fermentation broth of *Sphaceloma manihoticola* was only 7 mg/l (Graebe and Rademacher, 1979) and 20 mg/l (Rademacher, 1992). Recently, isolated endophytic fungus of cereal plants *Penicillium citrinum* KACC 43900, reported to produce 6.03 microgram/l GA₄ (Khan *et al.*, 2008) while another isolated fungus, *F. proliferatum* KGL0401 from the root of *Physalis alkekengi var frencheti* produced 17.3 microgram/l GA₄ after seven days of incubation in Hagemø medium (Rim *et al.*, 2005). A US patent (Gallazzo and Lee, 2001) described production of GA₄ using *F. fujikuroi* LTB-1027 in which a mixture of equal quantities of GA₄ and GA₇ were obtained. This patent reported 800 mg/l total gibberellin concentration, in which the ratio of GA₄₊₇: GA₃ was 4:1. In present study, concentration of GA₄ finally reached 600 mg/l in 168 h. Combined concentration of the two gibberellins, GA₄ and GA₃, obtained was 713 mg/l, with GA₄ accounting for 84% of the total gibberellins. The production of GA₄ by Mut189 in the fermenter was 2.8 times more compared to that in the shake flask although there was no visible increase in the dry cell mass. Thus present study reveals that higher production of GA₄ than reported earlier.

5.4 CONCLUSIONS

Amount and the type of gibberellins produced by *Fusarium fujikuroi* is dependent on the genetic constitution of the strain and fermentation conditions like aeration, type of carbon and nitrogen source and pH of the fermentation medium. A mutant strain Mut189 was selected based on relatively higher Gibberellin A₄ (GA₄), total gibberellin production and lack of pigmentation. Mut189 is also a morphological mutant and has advantage of lower viscosity because of short length of mycelium and increased gibberellin yield.

Complex organic nitrogen sources like plant meals and wheat gluten enhanced gibberellin production by mutants of *F. fujikuroi*. In a medium in which wheat gluten was used as the sole nitrogen source, the mutant Mut189 produced substantially higher quantities of GA₄ with its proportion increased to 74%. The increase in production of GA₄ is probably because of a substance present either in wheat gluten or produced from wheat gluten during growth of Mut189. The transfer of process from shake flask level to 10 L agitated fermenter allowed better control of the growth and GA₄ production by mutant Mut189. GA₄ concentration increased from 200 mg/l to 600 mg/l in the same fermentation time. It produced 2.8 times more GA₄ in wheat gluten medium after 168h fermentation.

This is the first report of use of wheat gluten for substantially high production of GA₄ by *F. fujikuroi*. The mutant strain of *F. fujikuroi* was successfully improved for gibberellin₄ (GA₄) production by optimization of culture conditions and media constituents. Along with the pH, nitrogen source was significant factor affecting GA₄ production by mutant Mut189.

In conclusion, a simple procedure for obtaining high quantities of GA₄ by incubating the Mut189, mutant strain of *F. fujikuroi* NCIM 1019 in a liquid fermentation medium containing wheat gluten as sole nitrogen source is developed. The biogenetic mechanisms responsible for the accumulation of GA₄ are as yet not fully understood, but may be related to substances contained in the medium and to particular characteristics of the regulation of gibberellin biosynthesis in this strain.

5.5 REFERENCES

- Barendse, G.W.M., Werken, P.H. 1980. High-performance liquid chromatography of gibberellins. *Journal of Chromatography A*, **198**, 449-455.
- Batlang, U. 2008. Benzyladenine plus gibberellins GA₄₊₇ increase fruit size and yield in greenhouse-grown hot pepper (*Capsicum annuum* L.). *Journal of Biological Science*, **8**, 659-662.
- Bomke, C., Rojas, M.C., Gong, F., Hedden, P., Tudzynki, B. 2008. Isolation and characterization of the gibberellin biosynthetic gene cluster in *Sphaceloma manihoticola*. *Applied and Environmental Microbiology*, **74**, 5325-5339.
- Borghet, A.V., Goesaert, H., Veraverbeke, W.S., Delcour, J.A. 2005. Fractionation of wheat and wheat flour into starch and gluten: overview of the main processes and the factors involved. *Journal of Cereal Science*, **41**, 221-237.
- Borrow, A., Brown, S., Jeffery, E.G., Kessell, R.H.J., Lloyd, E.C., Lloyd, R.B., Rothwell, A., Rothwell, B., Swait, J.C. 1964. The kinetics of metabolism of *Gibberella fujikuroi* in stirred culture. *Canadian Journal of Microbiology*, **10**, 407-444.
- Bottini, R., Cassan, F., Piccoli, P. 2004. Gibberellin production by bacteria and its involvement in plant growth promotion and yield increase. *Applied Microbiology and Biotechnology*, **65**, 497-503.
- Bruckner, B., Blechschmidt, D. 1991. The gibberellin fermentation. *Critical Reviews in Biotechnology*, **11**, 163-192.
- Buđock, J.D., Detroy, R.W., Hostalek, Z., Munim-Al-Shakarchi, A. 1974. Regulation of secondary metabolism in *Gibberella fujikuroi*. *Transactions of the British Mycological Society* **62**, 377-389.
- Fuska, J., Kuhr, I., Podojil, M., Sevcik, V. 1961. The influence of nitrogen source on the production of gibberellic acid in submerged cultivation of *Gibberella fujikuroi*. *Folia Microbiologica*, **6**, 18-21.
- Gallazzo, J.L., Lee, M.D. 2001. Production of high titers of gibberellins, GA₄ and GA₇ by strain LTB-1027, US 6287800.
- Graebe, J.E., Rademacher, W. 1979. Gibberellin A₄ produced by *Sphaceloma manihoticola* the cause of the superelongation disease of cassava (*Manihot esculenta*). *Biochemical Biophysical Research Communications*, **91**, 35-40.

- Graebe, J.E., Rademacher, W. 1981. Fermentation method for producing a plant growth modifying compound, *EP 0024951*.
- Kang, S.M., Joo, G.J., Hamayun, M., Na CI, Shin, D.H., Kim, H.Y., Hong, J.K., Lee, I.J. 2009. Gibberellin production and phosphate solubilization by newly isolated strain of *Acinetobacter calcoaceticus* and its effect on plant growth. *Biotechnology Letters*, **31**, 277-281.
- Kawaide, H., Sassa, T., 1993. Accumulation of gibberellin A₁ and metabolism of gibberellin A₉ to A₁ in a fungus *Phaeosphaeria sp.* culture. *Bioscience Biotechnology Biochemistry*, **57**, 1403-1405.
- Khan, S.A., Hamayun, M., Yoon, H., Kim, H., Suh, S., Hwang, S., Kim, J., Lee, I., Choo, Y., Yoon, U., Kong, W., Lee, B., Kim, J. 2008. Plant growth promotion and *Penicillium citrinum*. *BMC Microbiology*, **8**, 231.
- Kim, H.J, Millar, B.W. 2009. GA₄₊₇ plus BA enhances postproduction quality in pot tulips. *Postharvest Biology and Technology*, **51**, 272-277.
- MacMillan, J. 2002. Occurrence of gibberellins in vascular plants, fungi, and bacteria. *Journal of Plant Growth Regulation* **20**, 387-442.
- Malonek, S., Bomke, C., Bornberg-Bauer E., Rojas, M.C., Hedden, P., Hopkins, P., Tudzynski, B. 2005. Distribution of gibberellin biosynthetic genes and gibberellin production in the *Gibberella fujikuroi* species complex. *Phytochemistry*, **66**, 1296-1311.
- Mihlan, M., Homann, V., Liu, T.W.D., Tudzynski, B. 2003. AREA directly mediates nitrogen regulation of gibberellin biosynthesis in *Gibberella fujikuroi*, but its activity is not affected by NMR. *Molecular Microbiology*, **47**, 975-991.
- Rademacher, W. 1992. Occurrence of gibberellins in different species of the fungal genera *Sphaceloma* and *Elsinoe*. *Phytochemistry*, **31**, 4155-4157.
- Rim, S., Lee, J., Chol, W., Hwang, S., Suh, S., Lee, I., Rhee, I., Kim, J. 2005. *Fusarium proliferatum* KGL0401 as a new gibberellin producing fungus. *Journal of Microbiology and Biotechnology* **15**, 809-814.
- Sassa, T., Suzuki, K., Haruki, E. 1989. Isolation and identification of gibberellins A₄ and A₉ from a fungus *Phaeosphaeria sp.* *Agricultural Biological Chemistry*, **53**, 303-304.
- Takahashi, N., Phinney, B.O. 1991. Gibberellins. MacMillan J Eds. Springer-Verlag, New York.

Chapter 5

- Tudzynski, B. 1999. Biosynthesis of gibberellins in *Gibberella fujikuroi*: biomolecular aspects. *Applied Microbiology and Biotechnology*, **52**, 298-310.
- Zeigler, R.S., Powell, L.E., Thurston, H.D. 1979. Gibberellin A₄ production by *Sphaceloma manihoticola*, causal agent of cassava super elongation disease. *Physiology and Biochemistry*, **70**, 589-593.

Publications from thesis work

1. Lale, G., Jogdand, V.V., Gadre, R.V. 2006. Morphological mutants *Gibberella fujikuroi* for enhanced production of gibberellic acid. *Journal of Applied Microbiology*, **100**, 65-72.
2. Lale, G., Gadre, R.V. 2010. Enhanced production of gibberellin A₄ (GA₄) by a mutant of *Gibberella fujikuroi* in wheat gluten medium. *Journal of Industrial Microbiology and Biotechnology*, **37**, 297-306.
3. Lale, G., Gadre, R.V. 2007. Extractive fermentation of GA₃ production using *Gibberella fujikuroi* mutant. Abstract and poster presentation in International Conference on New Horizons in Biotechnology (NHBT-2007) NIST, Trivandrum, India, 26-29.

ORIGINAL ARTICLE

Morphological mutants of *Gibberella fujikuroi* for enhanced production of gibberellic acid

G. Lale, V.V. Jogdand and R.V. Gadre

Chemical Engineering Division, National Chemical Laboratory, Pune, India

Keywords

fusaric acid, gibberellic acid, high performance liquid chromatography, morphological mutant, viscosity.

Correspondence

R.V. Gadre, Chemical Engineering Division, National Chemical Laboratory, Pune, 411008, India. E-mail: rv.gadre@ncl.res.in

2005/0089: received 28 January 2005, revised 10 July 2005 and accepted 10 July 2005

doi:10.1111/j.1365-2672.2005.02754.x

Abstract

Aims: To examine the production of gibberellic acid by selected morphological mutants of *Gibberella fujikuroi* in liquid cultures.

Methods and Results: Mutants of *G. fujikuroi* having different morphological characteristics were selected after UV irradiation. The production of gibberellic acid by mutants that had different hyphal lengths was examined in shake flasks in media with different concentrations of nutrients as well as different volumes of the medium. Fed-batch fermenter study was performed to evaluate the mutant *Mor-25* for growth and production of gibberellic acid. The broth was analysed by high performance liquid chromatography for fusaric acid, the common mycotoxin produced by strains of *Fusarium*. A variety of morphological mutants having different mycelial and soluble pigmentation as well as colony morphologies were generated from *G. fujikuroi* upon exposure to UV radiation. A nonpigmented mutant (*Car-1*) was selected as intermediate parent and later, mutants *Mor-1* and *Mor-25* were selected based on their distinct morphology. The colonies on regeneration agar plates were small, compact and dry. In liquid medium, mutant *Mor-25* grew in a micro-pelleted form and the mycelium had short, highly branched hyphae, curly at tips with thick, swollen cells. Mutant *Mor-25* grew rapidly in a low-cost medium containing defatted groundnut flour, sucrose and salts. In media with higher nutrient concentrations as well as larger volumes, it produced twofold more gibberellic acid than the parent. Fusaric acid, the common mycotoxin, was absent in the fermentation broth of mutant *Mor-25*. The mutants have been deposited in National Collection of Industrial Microorganisms (NCIM), National Chemical Laboratory, Pune, India under following culture collection numbers (*Car-1*, NCIM 1323; *Mor-1*, NCIM 1322; and *Mor-25*, NCIM 1321).

Conclusions: Growth of unpigmented, morphological mutants of *G. fujikuroi* that led to lower viscosity in fermentation broth resulted in increased production of gibberellic acid.

Significance and Impact of the Study: The use of morphological mutants that have lower viscosity in liquid cultures for gibberellic acid production is not reported earlier. Similar mutants can be useful for other types of fungal fermentations also.

Introduction

Gibberellic acid is an important plant growth promoter. It is used on a large scale for growth of seedless varieties of grapes in India. It is also used for breaking dormancy of several seeds and germination of barley for malt pre-

paration. It is commonly produced by aerobic fermentation using selected strains of *Gibberella fujikuroi*. This secondary metabolite of fungal fermentation has been studied with respect to several aspects. Its production in submerged cultures (Borrow *et al.* 1964; Bandelier *et al.* 1997) in solid-state culture (Kumar and Lonsane 1987;

Pastrana *et al.* 1995) and by immobilized cells (Lu *et al.* 1995; Escamilla *et al.* 2000; Gelmi *et al.* 2000) has been described. The effect of a variety of carbon and nitrogen sources in nutrient medium on gibberellic acid (GA₃) production has been investigated (Gohlwar *et al.* 1984). The strains belonging to mating type 'C' produce less conidia and are prolific producers of gibberellins (Giordano *et al.* 1999). Mutants of *G. fujikuroi* have been investigated for pigment accumulation (Candau *et al.* 1991). Utilization of different nitrogen sources by mutants of *G. fujikuroi* and its effect on GA₃ production has been investigated (Sanchez-Fernandez *et al.* 1997). The biosynthetic pathway, bioconversion of intermediates, specific regulators, inhibitors, effect of nitrogenous compounds on production of GA₃, production of pigments like carotenoids and bikaverin, mutants with different pigment profiles and more recently, the genes encoding enzymes in biosynthesis of gibberellic acid by *G. fujikuroi* have been described and reviewed (Shukla *et al.* 2003).

In aerobic fermentations involving fungi, their filamentous nature commonly leads to excessive viscosity in the fermentation broth and demands higher agitation and aeration to maintain satisfactory levels of dissolved oxygen (DO). The expenditure on energy for aeration and agitation of such viscous broths is considerably high. It is a common observation that *G. fujikuroi* also grows in viscous, filamentous form in liquid medium and hence its submerged cultures often become oxygen limited. Rate of growth of *G. fujikuroi* and production of GA₃ in fermenter is governed to a considerable extent by oxygen transfer in the fermenter. It is also reported that *G. fujikuroi* cultures enter a linear growth phase after initial logarithmic phase (Borrow *et al.* 1964) presumably because of the oxygen limitation. Any change in morphology of the fungal strain that lowers the viscosity can result in improved oxygen transfer and in turn, increase the GA₃ production.

During stationary phase of *G. fujikuroi* culture several products like bikaverin, carotenoids, gibberellic acid, sterols and lipids are produced from a common precursor, acetyl-CoA. Their concentrations and ratio are governed by availability of oxygen in the culture (Giordano and Domenech 1999). A decrease in production of pigments like bikaverin and carotenoids by *G. fujikuroi* is likely to be beneficial for production of gibberellins because of the increased carbon flow through the gibberellin pathway as well as requirement of lesser steps during extraction and purification of the gibberellins from fermented broth.

Fusaric acid is a common mycotoxin produced by species of *Fusarium* that can affect animal and plant health. Strains of *Fusarium* and *Gibberella* were found to produce 200–1000 mg fusaric acid per gram of corn (Bacon *et al.* 1996). The strains of *G. fujikuroi* belonging to mating type 'C', that are prolific producers of gibberel-

lins also, were found to produce fairly high quantities of this toxic metabolite. It is necessary that the fungal strains to be used for production of gibberellins do not produce such mycotoxins.

The aim of the present investigation was to obtain mutant of *G. fujikuroi* that does not accumulate pigments, has decreased viscosity of the fermentation broth without compromising gibberellic acid productivity and does not produce fusaric acid.

Materials and methods

Micro-organism

Gibberella fujikuroi (NCIM 1019) was obtained from National Collection of Industrial Microorganisms (NCIM) National Chemical Laboratory, Pune 411008, India. This is a mycelial strain that produces intense coloured bikaverin in solid and liquid media. It also accumulates carotenoids intracellularly. This strain was used as the parent strain.

Media

The parent strain and subsequent mutants were maintained on potato dextrose agar (HiMedia Mumbai, India) supplemented with yeast extract at 2 g l⁻¹ concentration. Slants were incubated at 28°C for 3–4 days and later stored at 4°C.

The parent strain (NCIM 1019) was grown in a liquid medium containing (g l⁻¹) KH₂PO₄ 1.5, NaCl 0.5, MgSO₄·7H₂O 0.2, Na₂MoO₄·2H₂O 0.05, groundnut defatted cake 11, yeast extract 0.75, sucrose 90, trace mineral solution 1 ml, pH 6.8. The trace mineral solution contained (mg l⁻¹) H₃BO₃ 100, MnCl₂·4H₂O 100 mg, ZnSO₄·7H₂O 100, FeCl₃·6H₂O 100, CaCl₂·2H₂O 1000, CuCl₂·2H₂O 50. A few drops of HCl were added till the solution became clear.

The regeneration agar for growth of survivors after mutagenesis contained (g l⁻¹) KH₂PO₄ 1.5, NaCl 0.5, MgSO₄·7H₂O 0.2; Na₂MoO₄·2H₂O 0.05, yeast extract 3.0, glucose 30, soya peptone 3.0, bile salt 1.0, trace mineral solution 1 ml, agar 20.0, pH 6.8.

Reagents and chemicals

Gibberellic acid (G 7645) and fusaric acid (F 6513) were from Sigma Chemical Company, St Louis, MO, USA and were used as reference compounds for high performance liquid chromatography (HPLC). Reference gibberellic acid was considered to be 90% pure. Acetonitrile, ammonium dihydrogen phosphate and phosphoric acid (AR grade) were from E. Merck (Mumbai, India). The medium

ingredients were purchased from HiMedia (Mumbai, India). Groundnut defatted cake was from a local cattle-feed source.

Growth of the parent and mutagenesis

A tube containing 2.5 ml liquid medium was inoculated from a fresh slant of *G. fujikuroi* (NCIM 1019) and was incubated at 28°C for 48 h on a rotary shaker at 220 rev min⁻¹. A volume of 20 ml liquid medium in 250 ml Erlenmeyer flask was inoculated from this tube culture and the flask was incubated for 72 h as above. The mycelial culture was filtered over sterile sintered glass funnel G-0, (Borosil, Mumbai, India) to get short fragments in the filtrate. The filtrate was further passed through sterile cotton layer to remove larger fragments. The suspension of very small fragments (1–2 cells) was collected and used further. Fragments were counted using a haemocytometer and the cell number was adjusted to 1×10^5 per ml. A volume of 10 μ l of this suspension was spread on regeneration agar plates. The plates were exposed to UV radiation at 5 cm height for 3–10 s and incubated at 28°C, in dark, till colonies developed. The colonies that showed difference in characteristics in terms of shape, size, surface, colour and soluble pigment production than the parent were selected and transferred to maintenance agar slants.

Shake flask screening

Tubes containing 2.5 ml liquid medium were inoculated from fresh slants of the parent and the two selected mutants generated during mutagenesis. The tubes were incubated at 28°C for 48 h on a rotary shaker at 220 rev min⁻¹. Twenty ml liquid medium in 250 ml Erlenmeyer flask was inoculated from the tube culture and the flasks were incubated for 5 days. At the end of incubation, volume of the broth in the flasks was adjusted to 50 ml with distilled water and then the culture broth was filtered over qualitative filter paper circle under vacuum. The cell mass residue was further washed with three volumes of distilled water, observed for pigmentation and transferred to 104°C for determination of dry mass. The culture filtrates were analysed as described below. The experiments, done in duplicate, were performed twice.

Microscopic observations

The liquid cultures of three selected mutants (*Car-1*, *Mor-1* and *Mor-25*) in 250 ml Erlenmeyer flasks in single strength medium was observed microscopically for the filament length, cell wall thickness and other characteristics. The lengths of 50 terminal hyphal filaments were meas-

ured in shake flask cultures at 24 h age from the three strains and average terminal hyphal length was calculated.

Effect of larger volume and higher strength of medium on GA₃ production

The liquid medium was dispensed in 250 ml Erlenmeyer flasks in 15, 30, 45, 60 and 75 ml quantities and autoclaved. The flasks were inoculated with 10% (v/v) liquid cultures of three selected strains (with approximately 18 g l⁻¹ dry cell mass) grown for 48 h, uniformly, to evaluate the effect of increased medium volume in the flasks. In another set of experiment, they were grown in media with 1, 1.25, 1.5 and 1.75-fold higher nutrient concentrations to evaluate the effect of increased strength of fermentation medium on production of GA₃. The flasks were incubated on rotary shaker at 220 rev min⁻¹, at 28°C, for 5 days. The samples were analysed for dry mass, sugar and gibberellic acid content as described earlier. The experiments, done in duplicate, were performed twice.

Evaluation of mutant *Mor-25* in 10 l fermenter

A 10 l working volume fermenter (Bioflo 100; New Brunswick Scientific Co, NJ, USA) was used for evaluation of the *Mor-25* mutant. An inoculum grown for 48 h, in 1.25-fold medium was used. The liquid medium contained 1.25-fold concentration of the ingredients. The fermentation was continued for 188 h. DO was controlled at 50% air saturation level using the DO controller. The controller increased or decreased the agitation rate to maintain DO at 50% air saturation. The sugar was fed continuously at predetermined rates to avoid accumulation of the catabolite.

Sugar analysis

The residual sugar in the fermentation broth was estimated by dinitrosalicylic acid (DNS) method after suitable dilution.

HPLC analysis of gibberellic acid

The HPLC equipment was from ThermoSeparation Products, Fremont, CA, USA. A reversed phase, C18, Lichrospher100, 125 \times 4 mm, 5- μ m particle size column with a 4 \times 4 mm guard column obtained from Merck (Merck KGaA, Darmstadt, Germany), was used. The mobile phase composed of 20% acetonitrile in 5 mmol l⁻¹ ammonium dihydrogen phosphate, at pH 2.5 adjusted by H₃PO₄, was used at 0.6 ml min⁻¹. The detection of gibberellic acid was done at 205 nm. Standard graph of gibberellic acid

dissolved in 20% acetonitrile in water was prepared for 50 to 400 mg l⁻¹. If necessary, samples were diluted in water. All samples were filtered through 0.2 µm membrane filter before injection of 20 µl. The quantification was done by measurement of peak area. On-line spectral analysis of the GA₃ peak was performed for standard and selected samples for peak purity confirmation using UV3000 scanning detector (Thermo Separation Products, Fremont, CA, USA) with PC1000 and Spectacle software.

HPLC analysis of fusaric acid

Fusaric acid was analysed by a modification of the reversed phase HPLC method described by Amalfitano *et al.* (2002), using RP, C18, Lichrospher100, 125 × 4 mm column. The mobile phase contained 47.5% methanol in 5 mmol l⁻¹ dipotassium phosphate, pH 7.4. The flow rate was 0.6 ml min⁻¹. Standard fusaric acid solutions of 2 and 10 mg l⁻¹ were used for calibration. Fusaric acid solutions of 100–2000 µg l⁻¹ concentration were prepared and injected to determine limit of detection of the compound. The detection was carried at 268 nm. Fermented broth samples of the parent and mutants were filtered over filter paper under vacuum. The filtrates were centrifuged at 10 000 g for 10 min and then filtered through 0.2 µm membrane filter before analysis of fusaric acid. On-line spectral analysis of standard fusaric acid was performed using the detector and software described above to determine the spectral pattern of fusaric acid using UV3000 detector and Spectacle software. Spectral scan of the peaks in chromatograms of samples having elution time close to the standard fusaric acid peak were performed, similarly. The spectral scanning detector has an ability to determine the spectral behaviour of all the peaks in the chromatogram during the elution itself.

Results

Mutagenesis and screening

The parent strain *G. fujikuroi* (NCIM 1019) grew in a viscous filamentous form in shake flask. The filtered and washed mycelium looked orange in colour and the filtrate had a red–violet colour. A mutant (*Car-1*) obtained from the parent *G. fujikuroi* (NCIM 1019) had lost the pigmentation but was still a very mycelial strain that produced white, cottony, circular colony on regeneration agar. It grew profusely in a free, long mycelial form in liquid cultures making the broth very viscous. The carotenoid accumulation in the cells was negligible as appeared from filtered and washed cell mass. The culture filtrate, unlike parent, did not have the distinct bikaverin colour. Based on the loss of pig-

mentation, *Car-1* was selected and used as the parent in subsequent mutagenesis experiments.

The UV mutagenesis generated a wide variety of mutants. The survivors selected after mutagenesis of *Car-1* strain exhibited various morphological changes. The smaller colonies (2–3 mm) on regeneration agar plates that had crusty, uneven margins with rough surfaces and decreased pigmentation were selected because those were expected to have modified morphology in liquid cultures. The liquid cultures of some of these survivors showed growth with short mycelial length and increased cell thickness. These characteristics indicated that they might have morphology suitable for micro-pelleted mutants, when grown in liquid cultures. A mutant strain, *Mor-1*, found to grow with short and thicker mycelium, produced higher concentration of gibberellic acid and was thought to be advantageous for the fermentation because the problem associated with poor mixing and oxygen transfer in fermenter could be minimized. During subsequent mutations using *Mor-1* as a parent, a mutant *Mor-25* was selected in similar way that had still shorter hyphal length and increased cell thickness.

The average terminal hyphal length had distinct differences between the three strains. The average apical hyphal length of *Car-1* strain was 248 µm, that of *Mor-1* mutant was 173 µm, while that of the *Mor-25* strain was just 94 µm. These lengths were measured at 24 h in shake flask cultures when they were near the end of the logarithmic phase and therefore these lengths were of mature hyphae. The mutants have been deposited in National Collection of Industrial Micro-organisms (NCIM), National Chemical Laboratory, Pune, India under following culture collection numbers (*Car-1*, NCIM 1323; *Mor-1*, NCIM 1322; and *Mor-25*, NCIM 1321).

Production of GA₃ in single strength medium

When the three selected strains *Car-1*, *Mor-1* and *Mor-25* were grown in 20 ml single strength medium in 250 ml flasks simultaneously, they exhibited different growth characteristics from each other. The mutant *Car-1* had highly viscous growth while the mutant *Mor-25* had minimal viscosity as appeared from the culture broth in shake flasks. Table 1 shows that there was no major change in the extent of growth of these three mutant strains (*Car-1*, *Mor-1* and *Mor-25*) of *G. fujikuroi* in terms of dry cell mass. However, there were substantial differences in the sugar utilization, GA₃ concentration and productivity of these strains. Table 1 also shows that the short filament strain *Mor-25* resulted in substantially higher gibberellic acid content and had high yield, specific productivity and volumetric productivity. It is known that the oxygen availability causes a major change in proportion of the

Table 1 Growth and gibberellic acid production by three selected mutants of *Gibberella fujikuroi*

Mutant	Dry cell weight (g l ⁻¹)	Sugar utilized (g l ⁻¹)	GA ₃ (mg l ⁻¹)	Specific productivity GA ₃ /dry cell weight (mg g ⁻¹)	Yield GA ₃ /sugar (mg g ⁻¹)	Volumetric productivity (mg l ⁻¹ d ⁻¹)
<i>Car-1</i>	30	42	147	5	3	29
<i>Mor-1</i>	27	49	184	6	4	37
<i>Mor-25</i>	30	28	295	10	10	59

metabolites produced by *G. fujikuroi*. In the present study, the decreased mycelial length presumably resulted in increased oxygen transfer in the submerged cultures of mutant *Mor-25*. This, in turn must have further channelled more carbon through the gibberellin pathway resulting in higher concentration of gibberellic acid. A considerable amount of sugar is normally utilized by cultures of *G. fujikuroi* in their stationary phase. The strains that have highest GA₃ production per gram sugar utilized, would be preferred because these are the mutants that have higher flux of carbon towards gibberellic acid through its metabolic mechanism.

Production of GA₃ in larger volume media

The selection of mutants under investigation also depends on their growth characteristics and viscosity of the liquid cultures in shake flasks when grown in shake flasks at constant speed and temperature. In the first experiment, the medium volumes in 250 ml Erlenmeyer flask were varied. In the second experiment, the concentration of individual ingredients in the medium was increased keeping the volume constant. Increase in nutrient concentration as well as volume causes increase in oxygen demand in the shake flask culture because of increase in the cell mass. Figure 1 shows GA₃ concentration in the fermented

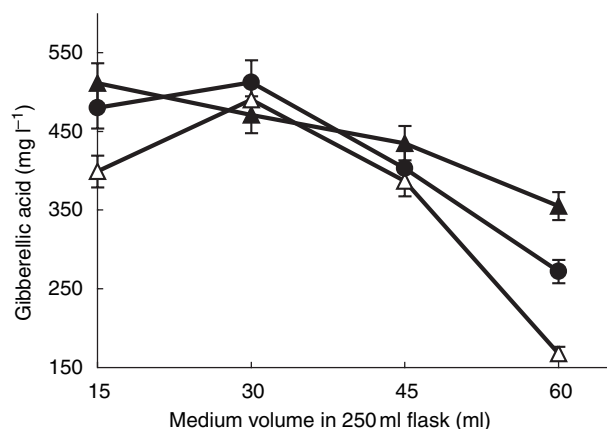
**Figure 1** Effect of different medium volumes in 250 ml Erlenmeyer flasks on GA₃ production by morphological mutants of *Gibberella fujikuroi*. Δ , *Car-1*; \bullet , *Mor-1*; \blacktriangle , *Mor-25*.

broth of three different mutants in shake flasks with different medium volumes, after 5 days incubation at 28°C and 220 rev min⁻¹. It shows that there was a drastic decrease in GA₃ concentration in case of mycelial mutant *Car-1* when the volume of medium in 250 ml flask was increased from 30 to 60 ml. The change was proportional to the increase in the medium volume. On the contrary, in case of the strain with short hyphae, *Mor-25*, the production of gibberellic acid was least affected.

Production of GA₃ media with increased strength

The results presented in Fig. 2 show that in case of the mycelial mutant *Car-1*, the increase in strength of medium adversely affected the GA₃ production. Similar to the above results, this is likely to be due to the decreased oxygen availability for the growth and GA₃ production by mutant *Car-1*. This effect was considerably decreased in case of mutants *Mor-1* and *Mor-25* that had altered morphology. The GA₃ production by *Mor-1* and *Mor-25* did not decrease unlike in the case of mycelial mutant, *Car-1*. On the contrary, with increased strength of the medium, the GA₃ concentration increased in the case of *Mor-25* mutant and it could be advantageous to use higher strength media with such mutants for GA₃ production.

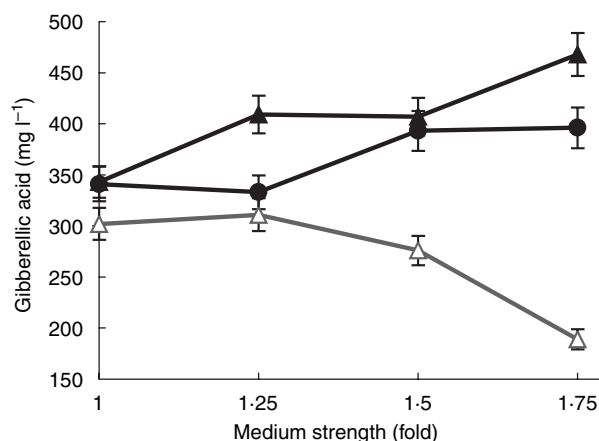
**Figure 2** Effect of medium strength in 250 ml Erlenmeyer flasks on GA₃ production by morphological mutants of *Gibberella fujikuroi*. Δ , *Car-1*; \bullet , *Mor-1*; \blacktriangle , *Mor-25*.

UV mutagenesis can generate mutants that result in higher product concentration because of alteration in metabolism. There was a possibility that *Mor-25* mutant also had a modification in metabolism that would result in increased gibberellic acid as compared with the parent *Mor-1* or *Car-1*. However, this effect would have been seen in all the flasks irrespective of the volume of the medium or concentrations of the medium ingredients. In the present case the liquid culture of the mutant *Mor-25* was visibly less viscous as routinely observed during the shake flask experiments and produced more gibberellic acid presumably because of lower viscosity of the culture broth.

Production of GA₃ in 10 l fermenter

Excellent growth of the mutant *Mor-25* with desired short-filament and micro-pellets could be achieved in 10 l fermenter. The agitation rate was found to be varied between 200 and 850 rev min⁻¹ depending upon the DO status. The DO remained around 50% air saturation during the run except some period of exponential growth. This was because of the fact that although the agitation rate reached 850 rev min⁻¹, the DO demand was even higher. Profiling the nitrogen source feeding can be optimised to avoid the decrease in DO tension. The volatile ester formation characterized by a typical smell during the normal fermentation (Gonzalez-Sepulveda and Agosin 2000) could be avoided by the DO control at 50% air saturation.

The results of fermentation batch using mutant *Mor-25* are presented in Figs 3 and 4. The mutant *Mor-25* grew rapidly during the logarithmic phase between 5 and 20 h reaching a high dry cell weight of about 20 g l⁻¹. The growth became linear later. Gibberellic acid is a secondary

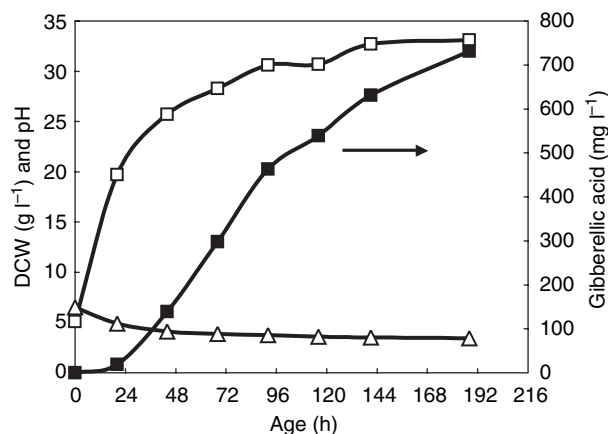

Figure 3 Bench scale fermentation batch using mutant *Mor-25* of *Gibberella fujikuroi*. □, dry cell weight g l⁻¹; ■, GA₃ mg l⁻¹; △, pH.

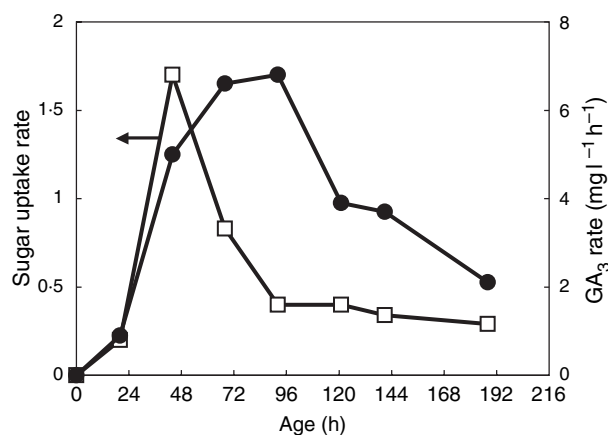

Figure 4 Sugar uptake and gibberellic acid production rates in fed-batch fermenter with *Mor-25* mutant of *Gibberella fujikuroi*. □, sugar uptake rate g l⁻¹ h⁻¹; ●, GA₃ production rate.

metabolite and its production began only when the logarithmic growth phase was over. The GA₃ accumulation continued throughout the batch time till 192 h to reach a concentration of 720 mg l⁻¹. There was a gradual decrease in pH, which remained stationary during the late stage of fermentation.

In the fermenter, during the logarithmic growth phase the sugar utilization was marginal and the sugar added to the medium did not contribute significantly to the vegetative cell mass. The rate of sugar uptake reached a maximal of 1.6 g l⁻¹ h⁻¹ at 48 h as could be seen in Fig. 4. The highest sugar uptake rate was observed during the changeover from logarithmic to stationary phase of the culture. The rate of GA₃ production although increased along with the sugar utilization rate during initial stationary phase, it did not coincide with sugar uptake rate between 72 to 96 h during which the GA₃ production rate remained above 6, irrespective of the rapid decrease in the sugar uptake rate.

Absence of mycotoxin

Figure 5 shows superimposed chromatograms of standard fusaric acid at 2 mg l⁻¹ and that of the fermentation broth of mutant *Mor-25*. The standard fusaric acid eluted at 3.86 min. In the sample, two peaks eluted at 3.64 and 4.13 min, respectively. On-line spectral scanning performed between 230 and 300 nm at a difference of 5 nm showed a peak purity index of 999.9 for the standard and had a maximal absorbance at 276 nm. On-line spectral scanning of chromatographic peaks is a very convenient technique for determination of peak purity. The limit of detection (LOD) of fusaric acid using the present HPLC method was 250 µg l⁻¹. The peaks near this retention time in the chromatogram of culture filtrate mutant

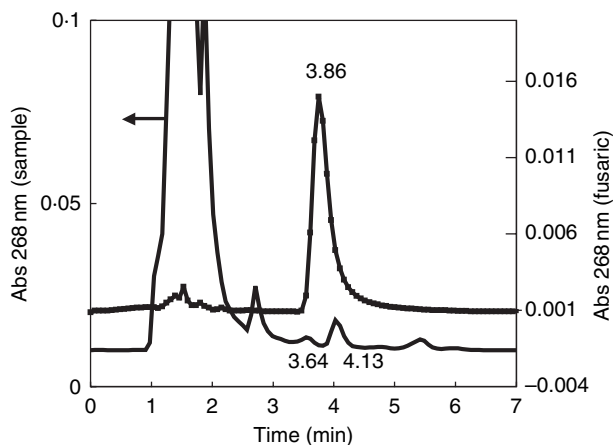

Figure 5 High performance liquid chromatography of standard fusaric acid at 2 mg l^{-1} and fermentation broth of *Gibberella fujikuroi* mutant *Mor-25*. Fusaric acid was absent. Retention time of fusaric acid was 3.86 min. Two peaks at 3.64 and 4.13 min in sample had different spectral pattern as describe in text.

Mor-25 had distinctly different spectral behaviour and were not fusaric acid although the retention time were close to that of fusaric acid as could be confirmed by on-line spectral scanning of the sample chromatogram.

Discussion

Gibberellic acid is commonly produced by fermentation using selected strains of *G. fujikuroi*. However, literature about such strains in terms of characteristics as well as fermentation conditions is rarely available. Although there are several excellent publications that deal with production of gibberellic acid and its control mechanism at cellular level, there are hardly any reports that describe use of mutants or procedure for selecting mutants for increasing the GA_3 production. Several patents worldwide cover production of gibberellic acid. However, the description of strains and processes in patent documents is also very sketchy. In the present investigation, mutants that had altered morphology and resulted in higher GA_3 production are described. The change in morphology in liquid medium was however, not always associated with increased production of gibberellic acid. Some of the small colonies that also had short filament length in liquid medium, resulted in very low gibberellic acid production. The pigmented colonies, presumably reverted to the parent form, generally led to decreased gibberellic acid concentration. Through careful selection it is possible to obtain the desired mutants that can affect productivity of expensive secondary metabolites. The mutant *Mor-25* used in the present investigation did not produce soluble bikaverin or intracellular carotenoids to any considerable

extent. The culture filtrate was clear and pale yellow. Such mutants that do not produce coloured by-products will be beneficial for the production of GA_3 because the efforts to remove such undesired compounds during purification of the product can be saved.

Giordano and Domenech (1999) have described how the aeration affects the fate of acetate in *G. fujikuroi* during secondary metabolism. They also had achieved different levels of aeration using different volumes of medium in 125 ml Erlenmeyer flasks. They concluded that higher aeration increased the concentration of gibberellins and bikaverin while lower aeration resulted in increased accumulation of fatty acids and fusarin C. It is evident that the higher oxygen availability increases production of gibberellic acid during the fermentation using *G. fujikuroi*.

It is well known that supplying sufficient quantity of oxygen to an actively growing fungal culture in large-scale fermenters is often a challenge. A variety of efforts to increase gibberellic acid content in fermentation broth have been published however, use of morphological mutants for GA_3 production has not been reported earlier. Selection and evaluations of mutants of *G. fujikuroi* that have altered morphology in terms of filament length and increase in the production of gibberellic acid in the present investigation clearly shows the benefits achieved in terms of production of gibberellic acid.

As seen during the evaluation of the selected mutant *Mor-25* in a 10 l laboratory fermenter, the production of gibberellic acid began in the stationary phase. Its production was governed strongly by available nitrogen source and was initiated only when the rate of cell mass formation declined after 24 h as seen from the Fig. 3. A variety of nitrogen sources have been investigated for the production of gibberellic acid. Although several investigators have used glycine or ammonium salts as nitrogen source for investigation of GA_3 production, organic nitrogen sources were found to enhance gibberellic acid production. In the present investigation, we used groundnut defatted cake as the main nitrogen source for the growth and was found to be suitable for the gibberellic acid production by the selected mutants of *G. fujikuroi*. The concentration of groundnut cake was selected on the basis of oxygen deliverability of the fermentation equipment used to avoid oxygen-depleted condition. The concentration of GA_3 achieved in the 192 h fermentation batch is considerably high as compared with several earlier publications.

Although the dry cell weight accumulation rate was very high during first 24 h, the sugar utilization rate was very low indicating that most of the growth in the present medium was taking place at the cost of protein source provided. The sugar uptake rate increased rapidly after first 24 h and coincided with the increasing rate of GA_3

production. But soon the rate of sugar utilization decreased considerably although the rate of GA₃ production continued to be high till 96 h and this indicated that only a small amount of sugar was actually getting converted to GA₃. The information can be used for further fine-tuning of the gibberellic acid fermentation.

The mutant of *G. fujikuroi* studied in the present investigation (*Mor-25*) did not produce fusaric acid, which is another undesired and toxic metabolite of species of *Fusarium*. As detailed by Bacon *et al.* (1996) all the 78 strains of *Fusarium* and *Gibberella* they examined, produced fusaric acid and the strains that belonged to mating type 'C' had consistently moderate to high concentration of fusaric acid in the culture medium. The toxicity of fusaric acid for animals, plants and human is well documented in literature and it was therefore essential that the strain of *G. fujikuroi* to be used for gibberellic acid production does not produce fusaric acid. The present RP HPLC method of analysis of fusaric acid had some difficulty because of presence of compounds that eluted close to the standard fusaric acid peak. The technique of on-line spectral scanning could solve the problem and eliminate doubts about peak identification.

The present investigation was thus successful in obtaining a mutant of *G. fujikuroi* that did not produce undesired metabolites and had morphological characters that helped in enhancement of gibberellic acid production.

Acknowledgment

The authors are thankful to the Department of Biotechnology, Government of India, New Delhi, India, for their financial support under grant number BT/PR2854/PID/06/145/2002.

References

- Amalfitano, C., Pengue, R., Andolfi, A., Vurro, M., Zonno, M.C. and Evidente, A. (2002) HPLC analysis of fusaric acid, 9,10- dehydrofusaric acid and their methyl esters, toxic metabolites from weed pathogenic *Fusarium* species. *Phytochem Anal* **13**, 277–282.
- Bacon, C.W., Porter, J.K., Norred, W.P. and Leslie, J.F. (1996) Production of fusaric acid by *Fusarium* species. *Appl Environ Microbiol* **62**, 4039–4043.
- Bandelier, S., Renaud, R. and Durand, A. (1997) Production of gibberellic acid by fed batch solid state fermentation in an aseptic pilot scale reactor. *Proc Biochem* **32**, 141–145.
- Borrow, A., Brown, S., Jeffrey, E.G., Kessell, R.H.J., Lloyd, P.B., Rothwell, A. and Swait, J.C. (1964) The kinetics of metabolism of *Gibberella fujikuroi* in stirred culture. *Can J Microbiol* **10**, 407–444.
- Candau, R., Avalos, J. and Cerda-Olmedo, E. (1991) Gibberellins and carotenoids in the wild type and mutants of *Gibberella fujikuroi*. *Appl Environ Microbiol* **57**, 3378–3382.
- Escamilla, E.M., Dendooven, L., Magana, I.P., Para, R. and De la Torre, M. (2000) Optimization of gibberellic acid production by immobilized *Gibberella fujikuroi* mycelium in fluidised bioreactors. *J Biotechnol* **76**, 147–155.
- Gelmi, C., Perez-Correa, R., Gonzalez, M. and Agosin, E. (2000) Solid substrate cultivation of *Gibberella fujikuroi* on an inert support. *Process Biochem* **35**, 1227–1233.
- Giordano, W. and Domenech, C.E. (1999) Aeration affects acetate destination in *Gibberella fujikuroi*. *FEMS Microbiol Lett* **180**, 111–116.
- Giordano, W., Avalos, J., Cerda-Olmedo, E. and Domenech, C.E. (1999) Nitrogen availability and production of bikaverin and gibberellins in *Gibberella fujikuroi*. *FEMS Microbiol Lett* **173**, 389–393.
- Gohlwar, C.S., Sethi, R.P., Marwaha, S.S. and Sehgal, V.K. (1984) Gibberellic acid biosynthesis from whey and simulation of cultural parameters. *Enzyme Microb Technol* **6**, 312–316.
- Gonzalez-Sepulveda, M. and Agosin, E. (2000) Capture of volatile metabolites for tracking the evolution of gibberellic acid in a solid-state culture of *Gibberella fujikuroi*. *Biotechnol Lett* **22**, 1849–1854.
- Kumar, P.K.R. and Lonsane, B.K. (1987) Gibberellic acid by solid state fermentation: Consistent and improved yields. *Biotechnol Bioeng* **30**, 267–271.
- Lu, Z., Xie, Z.C. and Kumakura, M. (1995) Production of gibberellic acid in *Gibberella fujikuroi* adhered on to polymeric fibrous carrier. *Proc Biochem* **30**, 661–665.
- Pastrana, L.M., Gonzalez, M.P., Torrado, A. and Murado, M.A. (1995) A fed batch culture model for improved production of gibberellic acid from waste medium. *Biotechnol Lett* **17**, 263–268.
- Sanchez-Fernandez, R., Avalos, J. and Cerda-Olmedo, E. (1997) Inhibition of gibberellin biosynthesis by nitrate in *Gibberella fujikuroi*. *FEBS Lett* **413**, 35–39.
- Shukla, R., Srivastava, A.K. and Chand, S. (2003) Bioprocess strategies and recovery processes in gibberellic acid fermentation. *Biotechnol Bioproc Eng* **8**, 269–278.

Enhanced production of gibberellin A₄ (GA₄) by a mutant of *Gibberella fujikuroi* in wheat gluten medium

Geetanjali Lale · Ramchandra Gadre

Received: 10 September 2009 / Accepted: 17 November 2009
© Society for Industrial Microbiology 2009

Abstract Mutants of *Gibberella fujikuroi* with different colony characteristics, morphology and pigmentation were generated by exposure to UV radiation. A mutant, Mor-189, was selected based on its short filament length, relatively high gibberellin A₄ (GA₄) and gibberellin A₃ (GA₃) production, as well as its lack of pigmentation. Production of GA₄ by Mor-189 was studied using different inorganic and organic nitrogen sources, carbon sources and by maintaining the pH of the fermentation medium using calcium carbonate. Analysis of GA₄ and GA₃ was done by reversed-phase high-performance liquid chromatography and LC-MS. The mutants of *G. fujikuroi* produced more GA₄ when the pH of the medium was maintained above 5. During shake flask studies, the mutant Mor-189 produced 210 mg l⁻¹ GA₄ in media containing wheat gluten as the nitrogen source and glucose as the carbon source. Fed-batch fermentation in a 14 l agitated fermenter was performed to evaluate the applicability of the mutant Mor-189 for the production of GA₄. In 7-day fed-batch fermentation, 600 mg l⁻¹ GA₄ were obtained in the culture filtrate. The concentration of GA₄ and GA₃ combined was 713 mg l⁻¹, of which GA₄ accounted for 84% of the total gibberellin. These values are substantially higher than those published previously. The present study indicated that, along with maintenance of pH and controlled glucose feeding, the use of wheat gluten as the sole nitrogen source considerably enhances GA₄ production by the mutant Mor-189.

Keywords *Gibberella fujikuroi* · GA₄ · Mutant · Wheat gluten · Fermentation

Introduction

Gibberellins are an important group of isoprenoid phytohormones that occur in minute amounts in higher plants. They are involved in the development and regulation of different growth processes throughout the life cycles of plants. Different gibberellins (GAs) selectively affect different parts of the plants. To date, 136 GAs have been identified in plants, fungi and bacteria [21], but only a few of them possess biological activity. The most important bioactive gibberellins are GA₁, GA₃, GA₄ and GA₇, which belong to the group of “C₁₉ gibberellins” and exhibit their effects during different stages of plant growth, such as seed germination, stem and petiole elongation, leaf expansion, flower induction, and growth of seed and fruit [6].

In addition to higher plants, certain fungi [21] and a few bacteria [13] also produce gibberellins. At present, species belonging to *Fusarium*, *Gibberella* (perfect stage of *Fusarium*), *Sphaceloma*, *Neurospora* and *Phaeosphaeria* have been reported to produce gibberellins. These fungi produce GA₃ and/or GA₄ as the final metabolite [21]. The production of gibberellins by bacteria was reviewed by Bottini et al. [5] but their reported concentrations are very low, normally in the range of nanograms per liter [14]. *G. fujikuroi* strains belonging to the mating population “C” are capable of producing gibberellins in industrially viable quantities [22, 28]. Although *G. fujikuroi* produces GA₃ as the main product, the fungus also produces its precursors gibberellin A₄ (GA₄) and gibberellin A₇ (GA₇) [29]. During the terminal steps of GA₃ biosynthesis, 1,2-GA₄ desaturase converts GA₄ to GA₇ [30] and a nonspecific P450 monooxygenase later oxidizes GA₇ to GA₃ [31]. Along with the gibberellins, *G. fujikuroi* produces other metabolites like sterols, carotenoids, bikaverin and lipids from acetyl-CoA, a common precursor.

G. Lale · R. Gadre (✉)
Chemical Engineering and Process Development Division,
National Chemical Laboratory, Pune 411008, India
e-mail: rv.gadre@ncl.res.in

Commercially, gibberellic acid (GA₃) is produced by selected strains of *G. fujikuroi* using aerobic submerged fermentation, although solid substrate fermentation has been investigated for its production [8, 19]. Production of GA₃ by *G. fujikuroi* is strongly influenced by dissolved oxygen [10], the type of nitrogen source, the carbon source and the pH of the fermentation medium [6].

GA₄ and GA₇ possess different bioactivities than GA₃ and are immediate precursors of GA₃. Commercially, GA₄ and GA₃ are available in the form of a mixture because it is difficult and uneconomic to separate them from each other [9], and they are more expensive than GA₃, probably because of lower yields in commercial fermentations.

The GA₄₊₇ mixture primarily stimulates the flowering and elongation of fruit cells. Growers of apples, pears and grapes use the mixture of GA₄ and GA₇ to produce larger fruits and an early harvest. The amount of GA₄ and GA₇ used varies depending on the crop, but it is generally applied at levels of 5–50 mg l⁻¹. GA₄₊₇ is used with “Golden Delicious” apples to effectively prevent abnormal cell divisions in the epidermal layer that lead to undesirable “russetting” [6]. Using GA₄₊₇ in combination with benzyladenine enhances the post-production quality of tulip flowers [18]. It is reported that this mixture also increases the yield of hot pepper [1]. Application of this mixture prevents cold-induced leaf chlorosis in Eastern and hybrid lilies. The mixture of GA₄₊₇ also promotes seed cone production in numerous *Pinaceae* species. This enables better seed production of economically important forest trees. GA₄ promotes fruit set of apples and it is also used for fruit thinning, to change fruit shape and size, to increase the individual fruit weight, to thicken skin and to prolong shelf life. During the last few years, commercial interest in the production of GA₄ and GA₇ has increased because of their horticulture uses.

A number of researchers have reported high GA₄- and GA₇-producing strains of *G. fujikuroi* that do not produce GA₃. Gibberellin A₄ (GA₄) was initially isolated and identified in culture filtrate of *Phaeosphaeria* sp. L487 [27]. However, a biosynthetic gene study revealed that GA₁ was the final gibberellin metabolite in *Phaeosphaeria* sp. L487 [15, 16]. Another fungus, *Sphaceloma manihoticola*, which causes superelongation disease in cassava [11, 33], produces GA₄ as the major gibberellin without any GA₃ and GA₇; however, the concentration of GA₄ in the culture filtrate of this fungus was less than 20 mg l⁻¹ [25]. *Penicillium citrinum* KACC 43900, a newly isolated endophytic fungus of cereal plants, produced 6 µg l⁻¹ GA₄ [17]. Another newly isolated fungus, *Fusarium proliferatum* KGL0401, from the root of *Physalis alkekengi* var. *frenchetii*, produced 17.3 µg l⁻¹ GA₄ after 7 days of incubation in Hagem’s medium [26]. A US patent [9] describes the production of GA₄ using *G. fujikuroi*

LTB-1027 in which a mixture of equal quantities of GA₄ and GA₇ was obtained. This patent reports a total gibberellin concentration of 800 mg l⁻¹, where the ratio of GA₄₊₇:GA₃ was 4:1. The main aim of the present study was to investigate the production of GA₄ by Mor-189, a mutant of *G. fujikuroi* selected on the basis of morphological differences and its high GA₄ production.

Materials and methods

Microorganisms

Gibberella fujikuroi 1019, *G. fujikuroi* 665, *G. fujikuroi* 850 and *G. fujikuroi* 1035 were obtained from the National Collection of Industrial Microorganisms (NCIM), National Chemical Laboratory (Pune 411008, India), and were maintained on potato dextrose agar (PDA) slopes and subcultured every 15 days.

Media

The parent strains and mutants were maintained on potato dextrose agar (HiMedia Mumbai, India) supplemented with 2 g l⁻¹ yeast extract. Slopes were incubated at 28°C for 3–4 days and stored at 4°C. The regeneration agar used to grow the survivors after mutagenesis was composed of (values in g l⁻¹) KH₂PO₄ 1.5, NaCl 0.5, MgSO₄·7H₂O 0.2, Na₂MoO₄·2H₂O 0.05, yeast extract 3.0, glucose 30, soya peptone 3.0, bile salt 1.0, trace mineral solution 1 ml, and agar 20.0 at pH 6.8. The trace mineral solution contained (values in mg l⁻¹) H₃BO₃ 100, MnCl₂·4H₂O 100, ZnSO₄·7H₂O 100, FeCl₃·6H₂O 100, CaCl₂·2H₂O 1,000, and CuCl₂·2H₂O 50, to which a few drops of HCl were added until the solution became clear.

The basal medium used for GA₄ production contained (values in g l⁻¹) KH₂PO₄ 1.5, NaCl 0.5, MgSO₄·7H₂O 0.2, Na₂MoO₄·2H₂O 0.05, defatted soyabean meal 9, glucose 60, and trace mineral solution 1 ml at pH 6.8. Other carbon sources substituted for glucose were used at 60 g l⁻¹, while nitrogen sources were substituted for defatted soyabean meal on an equal nitrogen basis.

Chemicals

GA₃ (G 7645) and GA₄ (G 7276) were purchased from Sigma Chemical Company (St. Louis, MO, USA), and were used as reference compounds for high-performance liquid chromatography (HPLC) and LC-MS analysis. The reference GA₄ and GA₃ were at least 90% pure. HPLC-grade acetonitrile, ammonium dihydrogen phosphate and phosphoric acid (AR grade) were from E. Merck (Mumbai, India). The media ingredients were from HiMedia

(Mumbai, India). Defatted soyabean meal and wheat flour were purchased locally.

Gibberellin analysis

GA₄ and GA₃ were analyzed using an HPLC purchased from Thermo Separation Products (Fremont, CA, USA). Reversed-phase C₁₈, Lichrospher 100, 5 µm particle size columns were used for analysis (Merck KGaA, Darmstadt, Germany). Detection was performed at 205 nm. Quantification was achieved by the external standard method using peak area. Samples were filtered through 0.2 µm membrane filters and directly injected into the HPLC using a 20 µl loop of a Rheodyne injector. If required, the samples were diluted to lower the concentration of GA₄ and GA₃ to below 300 mg l⁻¹. On-line spectral analysis of the GA₃ and GA₄ peaks was performed for the standard and the samples for peak purity confirmation using a UV3000 scanning detector (Thermo Separation Products) with PC1000 and Spectacle software.

A 125 × 4 mm RP C18 column was used to analyze the GA₃. The elution was performed using a mobile phase consisting of 20% acetonitrile in 5 mmol l⁻¹ ammonium dihydrogen phosphate at pH 2.5 and a flow rate of 0.6 ml min⁻¹. GA₄ analysis was done using 60% acetonitrile and 1% acetone in 5 mmol l⁻¹ ammonium dihydrogen phosphate at pH 2.5 and a flow rate of 1.0 ml min⁻¹, and a RP C18, 250 × 4 mm column. Identification of GA₄ was further confirmed by LC-MS (Waters Alliance 2695 separation module) under the following conditions: source temperature 150°C, desolvation temperature 350°C, collision energy 10 V, capillary voltage 3.51 kV, and polarity ES positive. The mobile phase used was 60% acetonitrile, 0.1% formic and 1% acetone at a flow rate of 1.0 ml min⁻¹. The same column was used for HPLC and LC-MS analysis. The reference Sigma GA₄ was injected at a concentration of 2 mg l⁻¹ for comparison during the LC-MS analysis.

Glucose analysis

The glucose in the fermentation broth was estimated by the dinitrosalicylic acid (DNS) method [24].

Selection of the strain for GA₄ production

Tubes containing 5 ml basal liquid medium with soyabean meal (9 g l⁻¹) and glucose (60 g l⁻¹) were inoculated from fresh slopes of *G. fujikuroi* NCIM 1019, *G. fujikuroi* NCIM 850, *G. fujikuroi* NCIM 665, and *G. fujikuroi* NCIM 1035. The tubes were incubated at 28°C for 48 h on a rotary shaker at 220 rpm. The 5 ml liquid cultures were then transferred to 45 ml liquid medium in 250 ml Erlenmeyer

flasks and incubated for 7 days as described above. At the end of incubation, the volume of the broth was adjusted to 50 ml with distilled water and filtered under vacuum. The filtrates were analyzed for pH, glucose, GA₃ and GA₄ as described above. The cell mass was washed with 50 ml distilled water under vacuum and the dry cell mass was estimated at 103°C. All of the experiments were done in triplicate.

Mutagenesis

The parent strain, *G. fujikuroi* (NCIM 1019), was grown in 25 ml liquid basal medium for 72 h, and then shaken at 220 rpm and 28°C. The mycelia were filtered over a sterile sintered glass funnel with a pore size of 50–100 µm (Borosil, Mumbai, India). The short mycelial fragments in the filtrate were counted using a hemocytometer, and 20 µl of this suspension were spread on regeneration agar plates, to which 250 mg l⁻¹ Pravastatin were added to exert selection pressure. Pravastatin inhibits the synthesis of secondary metabolites because it is a specific inhibitor of hydroxy methyl glutaryl CoA (HMG-CoA) reductase. The plates were exposed to UV radiation from a germicidal lamp (Sankyo Denki Co. Ltd., Japan) at a distance of 10 cm for different time intervals, such as 3, 5, 7 and 10 s. The plates were incubated at 28°C for 5–6 days in the dark until colonies developed. Colonies with different growth characteristics and pigmentations were selected and transferred to PDA slopes after re-isolation.

The mutant Mor-189 obtained during the experimentation was deposited in the National Collection of Industrial Microorganisms, National Chemical Laboratory (Pune, India) as NCIM 1343.

Shake flask screening of mutants for GA₄ production

G. fujikuroi NCIM 1019 was previously selected as the first parent through a screening experiment. Tubes containing 5 ml basal liquid medium were inoculated from fresh slopes of the parent culture and the selected mutants generated during mutagenesis. The tubes were incubated at 28°C for 48 h on a rotary shaker at 220 rpm. Erlenmeyer flasks 250 ml in capacity and containing 45 ml of liquid medium were inoculated from the tube cultures. The flasks were incubated for 7 days and analyzed as described for the earlier experiment.

Effect of pH control on GA₄ production

The parent culture and selected mutants were grown in shake flasks as before. The pH of the medium was adjusted to 5.6 before inoculation. Separately autoclaved 150 mg CaCO₃ powder was added to the flasks before inoculation

to maintain the pH at around 5. After 7 days of incubation at 28°C and 220 rpm, the filtrates were analyzed for GA₃ and GA₄, whereas the washed cell mass was used to determine the dry mass.

Effects of different carbon sources on GA₄ production by the mutant Mor-189

Media containing different carbon sources were prepared with 9 g l⁻¹ defatted soyabean meal as the nitrogen source. Separately autoclaved glucose, sucrose, soluble starch, insoluble corn starch, dextrin, maltodextrin, amylose, and amylopectin were used on an equal-carbon basis (equivalent to 24 g l⁻¹ C) in different sets of flasks. Sterile CaCO₃ (150 mg) was added to all of the flasks. The flasks were inoculated with liquid culture of the selected mutant strain, Mor-189, grown in 5 ml liquid medium with respective sugars for 48 h at 28°C, 220 rpm. The flasks were incubated for 7 days and the filtrates were analyzed.

Preparation of wheat gluten

Fractionation of wheat flour to recover wheat gluten was achieved via a conventional laboratory-scale dough process [4]. Wheat flour dough was made and kept in cold water (10°C) for 15 min. This allowed hydration and resulted in gluten agglomeration. A handful of dough was held under running tap water. This dough was squeezed repeatedly under running water until it became a rubbery mass. This rubbery mass was considered to be wheat gluten and the yield was about 10% (w/w). The wet wheat gluten was lyophilized, powdered, and used in the fermentation medium as the nitrogen source. The nitrogen content of the prepared gluten was determined by a flash combustion method using a ThermoFinnigan 1112 series Flash EA elemental analyzer.

Effects of different nitrogen sources on GA₄ production by Mor-189

Liquid basal media containing different inorganic and organic nitrogen sources with an equal basis of nitrogen (equivalent to 0.55 g l⁻¹ N) and glucose (24 g l⁻¹ C) as the carbon source were prepared in 250 ml Erlenmeyer flasks. The initial pH of the medium was 5.6, and it was maintained above 5 by the addition of CaCO₃. Inorganic nitrogen sources like ammonium nitrate, ammonium sulfate and ammonium chloride, as well as organic nitrogen sources like yeast extract, soya peptone, wheat gluten, defatted cottonseed meal, peanut meal and soyabean meal were used on an equal nitrogen basis. The sterile medium, in 250 ml flasks, was inoculated with 5 ml of a liquid culture of the mutant Mor-189 grown for 48 h, and was

incubated for 7 days at 28°C and 220 rpm. At the end of incubation period, the samples were analyzed for dry mass and GA₃ and GA₄ contents.

Fed-batch fermentation for GA₄ production by the mutant Mor-189

An agitated fermenter with a working volume of 10 l (Bioflow 110; New Brunswick Scientific Co., NJ, USA) was used for the production of GA₄ and GA₃ by the mutant Mor-189. Liquid basal medium with 4 g l⁻¹ wheat gluten and 20 g l⁻¹ initial glucose was used for fermentation. An inoculum (10% V/V, 18 g l⁻¹ dry cell weight) grown in the same medium for 48 h was used. The fermentation was continued for 168 h. Aeration was performed at 0.5 volume per volume per min (VVM). The agitation rate was varied between 600 and 700 rpm depending upon the dissolved oxygen (DO₂) status. The amount of DO₂ was controlled using the automatic DO₂ controller, which increased or decreased the agitation speed to maintain the DO₂ at 40% air saturation. The pH was maintained at 7.0 by the addition of sterile 5 N NaOH. A separately autoclaved glucose solution (500 g l⁻¹) was fed as the carbon source as required during the fermentation at a predetermined sugar feed rate in order to maintain glucose-limiting conditions in the culture. Samples were withdrawn every 24 h and analyzed for dry mass, residual glucose, and GA₄ and GA₃ contents.

Results

Mutagenesis and screening

The strains of *G. fujikuroi* obtained from NCIM grew well in the fermentation medium with soyabean meal used as the nitrogen source, and the dry cell mass reached about 17 g l⁻¹ in all of the cultures. The sugar uptakes in all of the liquid cultures of the four strains studied were similar. The strains produced between 5 and 62 mg l⁻¹ gibberellin (GA₃ + GA₄) in the basal medium in shake flask cultures in 7 days. *G. fujikuroi* NCIM 1019 produced the maximal total gibberellin (62 mg l⁻¹) and 6 mg l⁻¹ GA₄. *G. fujikuroi* 1019 produced only a few microconidia, while the other three strains produced large numbers of micro- and macroconidia on solid media as well as in liquid cultures. *G. fujikuroi* (NCIM 1019) was therefore selected as the parent to use to improve the strain used for GA₄ production. However, *G. fujikuroi* 1019 grew with long mycelial filaments that led to a highly viscous fermentation broth, accumulated a distinct orange water-insoluble pigment, and secreted a deep violet water-soluble pigment in the fermentation broth. During UV mutagenesis, colonies with a variety of morphological characteristics with respect to size,

margin, shape, surface appearance and pigmentation were generated. An exposure time of seven seconds was found to be suitable for achieving a 95% kill rate and was used in subsequent mutagenesis experiments. In our previous study [20] we reported on mutants that were selected based on their short filament length mycelia in the fermentation broth.

Gibberellin production by mutants

The selected mutant strains showed differences in their growth characteristics in the basal fermentation medium. Mor-25 and Mor-189 grew with short, thick, highly branched mycelia in liquid culture, and the broths had lower apparent viscosities than those for other strains and the parent. Table 1 shows that the mutant Mor-189 produced the maximal GA₄ plus GA₃ (412 mg l⁻¹), and that GA₄ accounted for 17% of this mixture. The GA₄ concentration (71 mg l⁻¹) in the broth of Mor-189 was considerably higher than those obtained for the other mutants and the parent. The growths of all of the mutants in basal medium were similar, and this showed that the specific gibberellin productivity of Mor-189 was also the highest (24.2 mg gibberellin g⁻¹ dry cell weight) among the mutants studied. The mutant Mor-189 produced sixfold more GA₃ and 23-fold more GA₄ as compared to the parent *G. fujikuroi* NCIM 1019. Mor-189 was therefore selected for further optimization of gibberellin production.

Effect of pH control on GA₄ production

The growths of all of the studied mutants were similar in the shake flasks with or without CaCO₃ in terms of dry cell

mass, although they showed differences in terms of growth characteristics and viscosity, similar to those seen in earlier experiments. The medium pH remained above 5 in the flasks to which CaCO₃ was added. It can be seen from Table 2 that maintaining the pH above 5 increased GA₄ production in all of the mutants studied. Table 2 also shows that maintaining the pH around 5.5 exerted a positive effect on the GA₄ production by almost all of the mutants without any increase in GA₃ production. This increase in GA₄ concentration was highest in the mutants Mor-25 and Mor-189. Although the ratio of GA₄ to total gibberellin was almost the same for all studied mutants, more GA₄ (94 mg l⁻¹) was produced by Mor-189 than the other mutants. Therefore, in subsequent shake flask experiments, the pH was maintained above 5 by adding CaCO₃.

Effects of different carbon sources on GA₄ production by the mutant Mor-189

The results presented in Table 3 show that changing the carbon source used hardly affected either the growth of Mor-189 or the GA₃ production. The ratio of GA₄ to total gibberellin varied from 2 to 30% depending upon the carbon source used. Mor-189 produced more GA₄ when glucose, dextrin starch, and sucrose were used in combination with soyabean meal, but produced much less GA₄ in media containing amylose, amylopectin and maltodextrin, although the growth remained relatively constant. There was no correlation between the nature (slowly utilizable or rapidly utilizable) of the carbon source and the ratio of the two gibberellins produced. Glucose was chosen as the best carbon source, as its use resulted in the production of

Table 1 GA₄ and GA₃ production by selected mutants of *G. fujikuroi* in 7-day shake flask experiments

Mutant	GA ₄ (mg l ⁻¹)	GA ₃ (mg l ⁻¹)	Total GA (mg l ⁻¹)	GA ₄ /total GA (%)	Dry cell mass (g l ⁻¹)
<i>G. fujikuroi</i> NCIM1019	3 ± 1	56 ± 2	59	5	18.1 ± 0.6
Car-1	12 ± 2.6	194 ± 4.5	206	5	18.2 ± 0.4
Mor-1	2 ± 0.6	298 ± 5.2	300	0.6	17.7 ± 0.4
Mor-25	45 ± 4.5	275 ± 6.5	320	14	18.2 ± 0.8
Mor-189	71 ± 4.3	341 ± 5.0	412	17	17.8 ± 0.3

Total GA refers to GA₃ + GA₄. Concentrations are averages of three flasks each ±SD

Table 2 GA₄ and GA₃ production by mutants of *G. fujikuroi* in medium with CaCO₃ for pH control in 7-day shake flask experiments

Mutant	GA ₄ (mg l ⁻¹)	GA ₃ (mg l ⁻¹)	Total GA (mg l ⁻¹)	GA ₄ /total GA (%)	Dry cell mass (g l ⁻¹)
<i>G. fujikuroi</i> NCIM 1019	6 ± 1.0	71 ± 3.6	77	7.7	19.1 ± 0.4
Car-1	20 ± 2.6	200 ± 6.5	220	9	17.8 ± 0.3
Mor-1	10 ± 1.7	300 ± 6.0	310	3.2	17.7 ± 0.2
Mor-25	80 ± 2.6	300 ± 5.0	380	21	18.2 ± 0.2
Mor-189	94 ± 3.6	350 ± 8.5	444	21	18.1 ± 0.3

Total GA refers to GA₃ + GA₄. Concentrations are averages of three flasks each ±SD

Table 3 Effects of different carbon sources on GA₄ and GA₃ production by mutant Mor-189 in 7 day shake flask experiments

Carbon source	GA ₄ (mg l ⁻¹)	GA ₃ (mg l ⁻¹)	Total GA (mg l ⁻¹)	GA ₄ /total GA (%)	Dry cell mass (g l ⁻¹)
Amylose	10 ± 3	300 ± 10	310	3	17.5 ± 0.2
Amylopectin	9 ± 2	247 ± 7.0	356	2	17.2 ± 0.2
Corn starch (insoluble)	70 ± 4.5	248 ± 9.1	318	22	18.0 ± 0.4
Dextrin type II	82 ± 3.4	211 ± 2.6	293	28	17.9 ± 0.1
Dextrin type III	89 ± 2	200 ± 4.5	289	30	16.9 ± 0.1
Glucose	92 ± 3	330 ± 6.0	422	22	17.1 ± 0.2
Maltodextrin	7 ± 1	240 ± 11.1	241	3	17.4 ± 0.3
Starch	80 ± 8.1	324 ± 10.4	404	19	18.1 ± 0.4
Sucrose	68 ± 1	290 ± 8.7	358	19	16.8 ± 0.3

Total GA refers to GA₃ + GA₄. Concentrations are averages of three flasks each ±SD

Table 4 Effect of different nitrogen sources on GA₄ and GA₃ production by the mutant Mor-189 in 7 day shake flask experiments

Nitrogen source	GA ₄ (mg l ⁻¹)	GA ₃ (mg l ⁻¹)	Total GA (mg l ⁻¹)	GA ₄ /total GA (%)	Dry cell mass (g l ⁻¹)
Ammonium chloride	2 ± 1.0	240 ± 5.5	242	0.8	14.3 ± 0.3
Ammonium nitrate	9 ± 1.0	205 ± 4.3	214	4	13.9 ± 0.3
Ammonium sulfate	7 ± 1.0	200 ± 4.5	207	3	14.1 ± 0.3
Soyapeptone	3 ± 1.0	61 ± 5.5	64	4.5	19.1 ± 0.4
Yeast extract	5 ± 1.0	40 ± 3.4	45	11	18.2 ± 0.2
Cottonseed meal	25 ± 2.0	297 ± 10.1	322	7.7	17.9 ± 0.3
Peanut meal	26 ± 1.7	308 ± 10.6	334	7.8	18.1 ± 0.3
Soyabean meal	40 ± 3.4	331 ± 7.2	371	10.7	19.1 ± 0.4
Wheat gluten	210 ± 8.7	73 ± 4.6	283	74	20.0 ± 0.3

Total GA refers to GA₃ + GA₄. Concentrations are averages of three flasks each ±SD

considerably higher levels of total gibberellin (422 mg l⁻¹) and GA₄ (92 mg l⁻¹), although the ratio of GA₄ to total gibberellin was 22%.

Effect of nitrogen sources on GA₄ production by Mor-189

The growth of Mor-189 and the production of GA₄ dropped slightly in inorganic nitrogen media (Table 4), presumably because some of the nutrients available in low quantities in complex media were not available in the medium with inorganic nitrogen sources. Although defatted plant meals, yeast extract and soya peptone resulted in rapid growth, they did not support satisfactory GA₄ production. It was observed that Mor-189 produced the highest level of GA₄ (210 mg l⁻¹) in wheat gluten medium, and the proportion of GA₄ in this medium to total gibberellin was 74%, which was significantly higher than seen in all other experiments. Amongst all of the studied nitrogen sources, the highest level of GA₄ was produced by Mor-189 using wheat gluten as the nitrogen source. This high GA₄ production was not simply an effect of differences in cell mass in the shake flasks, because the difference between the dry cell masses

generated with different organic nitrogen sources was only marginal. A liquid basal medium with wheat gluten and glucose was subsequently used for GA₄ production.

Fed-batch fermentation for GA₄ production by the mutant Mor-189

Mor-189 grew in the desired short mycelial form in the 10 l fermenter liquid broth in a similar manner to that observed in the shake flasks. The results of batch fermentation using the mutant Mor-189 are presented in Figs. 1 and 2. Mor-189 grew rapidly during the growth phase and reached a dry cell mass of 21 g l⁻¹ in 24 h, and then it leveled off until 168 h (when the fermentation was terminated). The mycelium grew in the form of short, thick filaments with very little pigmentation. The DO₂ was maintained in the range 40–50% air saturation during the fermentation time by adjusting the agitation rate. The production of gibberellins began after 20 h, when the increase in the cell mass slowed down. Gibberellins are produced by *G. fujikuroi* only after strict nitrogen limitation is achieved in the nutrient medium [7]. Also, in the present investigation, the gibberellins were only detected after the culture had

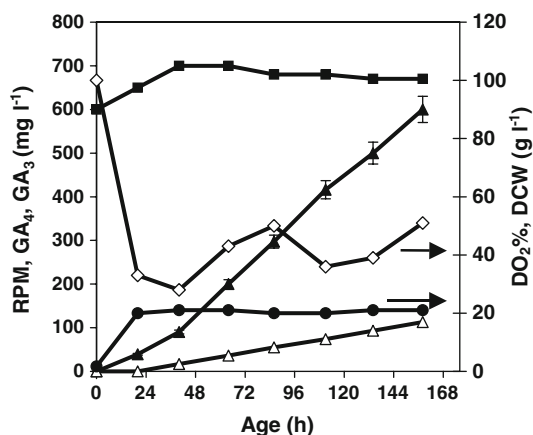

Fig. 1 Production of GA₃ and GA₄ by Mor-189 in a 14 l agitated fermenter. Filled squares, agitation speed in rpm; open diamonds, DO₂ in % air saturation; filled circles, dry cell weight in g l⁻¹; filled triangles, GA₄ concentration in mg l⁻¹; unfilled triangles, GA₃ concentration in mg l⁻¹

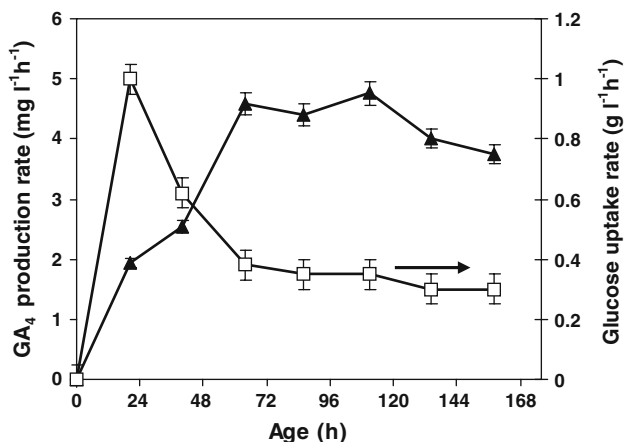

Fig. 2 Performance of mutant Mor-189 in terms of the glucose uptake rate and the GA₄ production rate in a 14 l agitated fermenter. Filled triangles, GA₄ in mg l⁻¹ h⁻¹; open squares, glucose uptake rate in g l⁻¹ h⁻¹

reached the stationary stage, as seen from the stable dry cell mass.

The glucose concentration reached zero from an initial level of 20 g l⁻¹ during the first 20 h, and the average glucose utilization rate in the fermenter was 1.0 g l⁻¹ h⁻¹. Most of the glucose used in this period was utilized for the growth of the fungus, because gibberellins were not detected during the first 20 h. After 24 h, a 500 g l⁻¹ glucose solution was fed in in one pulse to achieve a concentration of 10 g l⁻¹. The sugar feeding mode was changed to a continuous mode so that the culture experienced glucose-limiting conditions. Between 24 and 40 h, the glucose uptake rate declined to 0.62 g l⁻¹ h⁻¹. Glucose utilization later decreased slowly to 0.35 g l⁻¹ h⁻¹ at 65 h

and then remained nearly constant until the end of the batch fermentation. Irrespective of the decline in glucose uptake rate, the GA₄ production rate remained almost the same, and so there was no direct correlation between glucose utilization rate and GA₄ production rate. This is understandable considering that the overall yield of secondary metabolites per gram of sugar fermented is normally very poor. Between 20 and 40 h, the GA₄ production rate was 2.6 mg l⁻¹ h⁻¹, which increased to 4.6 mg l⁻¹ h⁻¹ at 60 h and remained nearly the same until 120 h. Presumably the culture reached high levels of nitrogen limitation and so the repression caused by the nitrogen source decreased further, which led to an increased rate of GA₄ production. The specific GA₄ productivity in the stationary phase of the culture was 0.2 mg g⁻¹ DCW h⁻¹, and the specific glucose uptake rate was 16 mg g⁻¹ DCW h⁻¹. However, the rate of GA₄ production started to decline after 5 days and reached 3.8 mg l⁻¹ h⁻¹, probably because of culture aging. The concentration of GA₄ finally reached 600 mg l⁻¹ in 168 h. The combined concentration of the two gibberellins GA₄ and GA₃ finally reached 713 mg l⁻¹, with GA₄ accounting for 84% of the total gibberellin. The production of GA₄ by Mor-189 in the fermenter was 2.8 times higher than that observed in the shake flask, although there was no visible increase in the dry cell mass. This can probably be attributed to better mass transfer in the agitated fermenter as compared to the shake flask.

Analysis of gibberellins

The methods used to analyze the gibberellins were able to satisfactorily resolve GA₃ and GA₄. A 250 mm column was more suited to the analysis of GA₄. Barendse et al. [2] and Gallazzo and Lee [9] have described the chromatographic separation of GA₇ and GA₄. These earlier investigators mentioned that, under the chromatographic conditions they used, GA₇ eluted just before GA₄, with a retention time difference of about a minute. The chromatographic conditions that we used in the present study were similar to those described by these investigators, and so we expected a peak from GA₇ just before the GA₄ peak.

In the present investigation, GA₄ eluted at 12.20 min (Fig. 3). The retention volume of GA₄ was 12.2 ml. In the sample broth, two peaks eluted at 10.38 and 12.26 min, respectively. Online spectral scanning performed between 200 and 350 nm in steps of 5 nm showed a peak purity index of 99% for the standard GA₄, and exhibited maximal absorbance at 205 nm. The peak at 12.26 min in the chromatogram of the sample broth had an identical spectral pattern to the standard GA₄ peak at 12.20 min. The small peak at 10.38 min in the chromatogram of the sample broth exhibited different spectral behavior and was probably not

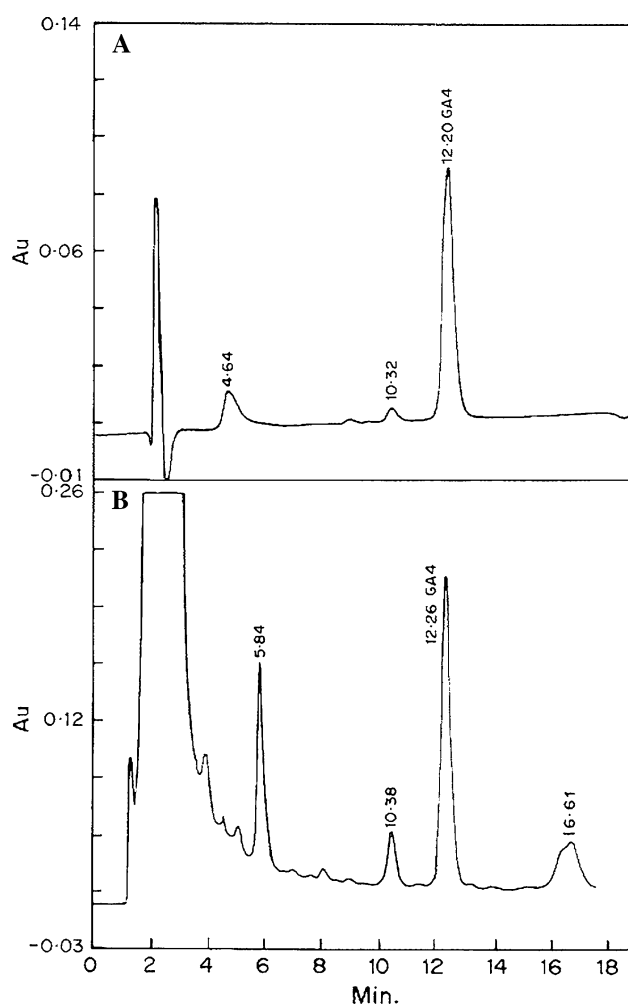

Fig. 3 a, b Analysis of fermentation broth for GA₄ by HPLC. The analysis was done on an RP C₁₈ Lichrospher 100, 250 × 4 mm column with a mobile phase consisting of 60% acetonitrile and 1% acetone in 5 mmol l⁻¹ ammonium dihydrogen phosphate at pH 2.5 and at a flow rate of 1.0 ml min⁻¹. Detection was performed at 205 nm. **a** Reference injection; **b** sample injection

a gibberellin. Thus, the fermentation broth was substantially free of GA₇.

The analysis of GA₄ was confirmed by LC-MS. Analysis in ES positive mode gave (*m/z*) 333.28 (*M* + 1), 269.13, 315.18.

Figure 4 shows chromatograms of the reference gibberellic acid (GA₃) and of the fermentation broth of mutant Mor-189. The GA₃ eluted at 6.12 min. The retention volume of the GA₃ peak was 3.6 ml under the present experimental conditions.

Discussion

GA₄ exhibits very high biological activity in terms of promoting fruit growth, appearance and shelf life in fruits

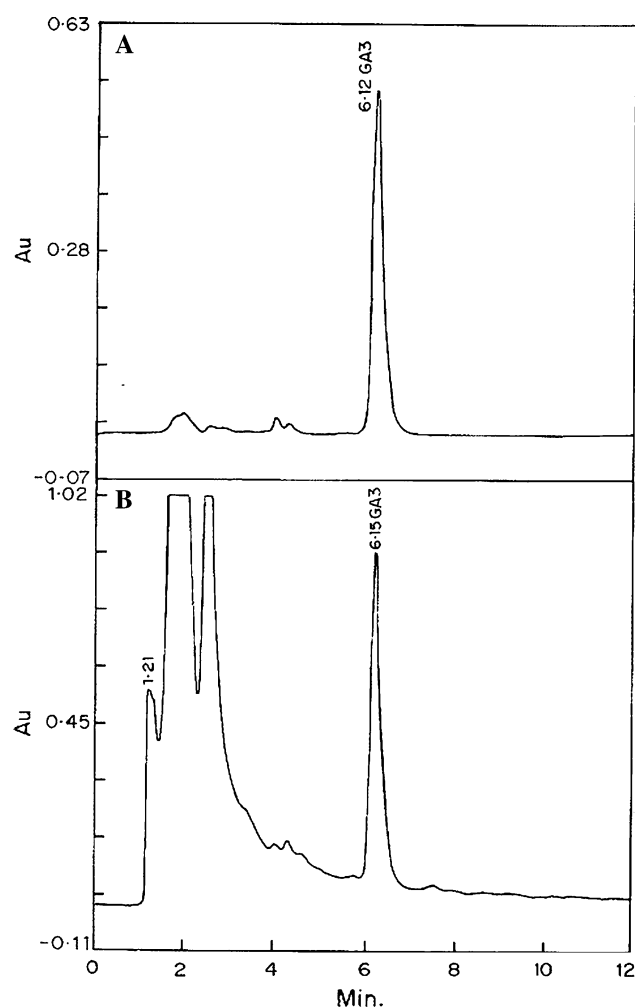

Fig. 4 a, b Analysis of the fermentation broth for GA₃ by HPLC. The analysis was done on an RP C₁₈ Lichrospher100, 125 × 4 mm column with a mobile phase consisting of 20% acetonitrile in 5 mmol l⁻¹ ammonium dihydrogen phosphate at pH 2.5 and at a flow rate of 0.6 ml min⁻¹. Detection was performed at 205 nm. **a** Reference injection; **b** sample injection

with high commercial value like apples, peas, and grapes. Although these biological activities of GA₄ are well documented, its commercial use in agriculture has remained rather limited compared to GA₃, presumably because of limited availability of the product and its very high cost in the market. Procedures for obtaining GA₄ and a mixture of GA₄ and GA₇ by fermentation using *G. fujikuroi* have been patented [9, 12, 32], but little information has been published regarding the production of GA₄ in sufficient quantities.

In our previous study [20], we reported on the use of morphological mutants that have short mycelial lengths in liquid cultures, which led to better oxygen transfer and increased production of GA₃. Mor-189, used in the present investigation, is also a morphological mutant, similar to the mutants described earlier, and has the advantages of a low

viscosity because of the short length of its mycelium and an increased gibberellin yield. Giordano and Domench [10] have described how oxygen availability causes differences in the biosynthesis of fats, pigments and gibberellins by *G. fujikuroi*. They reported that increased oxygen transfer increased the biosynthesis of gibberellins by *G. fujikuroi*. The use of mutants with short mycelial lengths and low viscosities permits the utilization of more concentrated media, and, in turn, a higher cell mass in the fermenter, which can result in a higher volumetric gibberellin productivity.

In shake flasks, it is normally difficult to maintain the pH at any desirable value. The use of sterile CaCO_3 in shake flasks allowed us to maintain the pH in the shake flask culture above 5. Borrow et al. [3] reported that the growth and gibberellin production of *G. fujikuroi* were fairly constant over the pH range 4–7, but the composition of resulting gibberellin mixture depended significantly on the pH value. They reported that, GA_3 was the main product at a low pH, while the concentrations of GA_4 and GA_7 were higher at neutral pH. Although maintaining the pH at 5.6 is reported to be beneficial in GA_4 production by mutants selected specifically for its production [9], in the present investigation, maintaining the pH above 5 resulted in marginal increase in the proportion of GA_4 produced by the parent and all the mutants studied. In our earlier investigation [20], we observed that the GA_3 production rate increased immediately after the culture entered the stationary phase, and that the rate lowered considerably later on. In the present investigation, a similar effect was also observed (data not shown). The drop in the GA_3 production rate was assumed to be due to the drop in pH, cell mass aging or catabolite repression. By controlling the pH and carefully controlling the glucose feeding rate so as to achieve glucose limiting conditions during the stationary phase, we could maintain the GA_4 production rate above $4 \text{ mg l}^{-1} \text{ h}^{-1}$ over a considerable length of time between 60 and 144 h, and this resulted in a very high GA_4 concentration in the fermentation broth, which has not been reported previously [9, 11, 17, 25, 26].

In the present study, organic nitrogen sources like plant meals and wheat gluten were found to enhance GA_3 and GA_4 production by mutants of *G. fujikuroi*. In a medium in which wheat gluten was used as the sole nitrogen source, the mutant Mor-189 produced substantially higher quantities of GA_4 , and its proportion increased to 74%. Thus, wheat gluten was found to be suitable for GA_4 production by Mor-189.

The genetics and biochemistry of gibberellin production in *G. fujikuroi* has been well studied in recent years. It has been demonstrated that the expression of genes coding for the desaturase involved in the conversion of GA_4 to GA_7

and then to GA_3 share a common regulation that is mediated by the nitrogen catabolite regulatory protein AreA [23]. Our results suggest that the increase in the production of GA_4 is probably due to a substance present either in wheat gluten or produced from wheat gluten during the growth of *G. fujikuroi*. This inhibition was not an effect of the oxygen availability, because in shake flask cultures, as well as in the fermenter, the dry cell masses and mycelial morphologies were similar in media with wheat gluten and other nitrogen sources. This is the first report of the use of wheat gluten to enable the substantially high production of GA_4 by *G. fujikuroi*. Transferring the process from the shake flask level to a 10 l agitated fermenter allowed better control over the growth and GA_4 production by the mutant Mor-189, and we successfully increased the GA_4 concentration from 200 mg to 600 mg l^{-1} in the same fermentation time.

The mutant Mor-189 is deposited in the National Collection of Industrial Microorganisms, National Chemical Laboratory (Pune, India) as NCIM 1343. The other mutants (Car-1, Mor-1 and Mor-25) have also been deposited in the NCIM, as described earlier [20].

Conclusion

In this study, we successfully improved the strain of *Gibberella fujikuroi* used for gibberellin (GA_4) production by mutagenesis and media optimization. The study indicated that, along with the pH, the nitrogen source used was a factor that significantly affects GA_4 production by the mutant Mor-189. 2.8-fold more GA_4 was produced in wheat gluten medium after 168 h of fermentation. Studies to define the exact role of wheat gluten in the enhanced GA_4 production exhibited by the Mor-189 mutant of *G. fujikuroi* are in progress.

Acknowledgments Ms. Geetanjali Lale would like to thank the Council of Scientific and Industrial Research, India for awarding a Senior Research Fellowship. Part of this work was supported financially by the Department of Biotechnology, Government of India.

References

- Batlang U (2008) Benzyladenine plus gibberellins GA_{4+7} increase fruit size and yield in greenhouse-grown hot pepper (*Capsicum annum* L.). J Biol Sci 8:659–662
- Barendse GWM, Werken PH (1980) High-performance liquid chromatography of gibberellins. J Chromatogr 198:449–455
- Borrow A, Brown S, Jeffery EG, Kessell RHJ, Lloyd EC, Lloyd RB, Rothwell A, Rothwell B, Swait JC (1964) The kinetics of metabolism of *Gibberella fujikuroi* in stirred culture. Can J Microbiol 10:407–444
- Borghet AV, Goesart H, Veraverbeke WS, Delcour JA (2005) Fractionation of wheat and wheat flour into starch and gluten:

- overview of the main processes and the factors involved. *J Cereal Sci* 41:221–237. doi:[10.1016/j.jcs.2004.09.008](https://doi.org/10.1016/j.jcs.2004.09.008)
5. Bottini R, Cassan F, Piccoli P (2004) Gibberellin production by bacteria and its involvement in plant growth promotion and yield increase. *Appl Microbiol Biotechnol* 65:497–503. doi:[10.1007/s00253-004-1696-1](https://doi.org/10.1007/s00253-004-1696-1)
 6. Bruckner B, Blechschmidt D (1991) The gibberellin fermentation. *Crit Rev Biotechnol* 11:163–192
 7. Bu'lock JD, Detroy RW, Hostalek Z, Munim-Al-Shakarchi A (1974) Regulation of secondary metabolism in *Gibberella fujikuroi*. *Trans British Mycol Soc* 62:377–389
 8. Chavez-Parga MC, Gonzalez-Ortega O, Negrete-Rodriguez MLX, Medina-Torres L, Escamilla-Silva EM (2007) Hydrodynamics, mass transfer and rheological studies of gibberellic acid production in an air-lift bioreactor. *World J Microbiol Biotechnol* 23:615–623. doi:[10.1007/s11274-006-9270-x](https://doi.org/10.1007/s11274-006-9270-x)
 9. Gallazzo JL, Lee MD (2001) Production of high titers of gibberellins, GA₄ and GA₇ by strain LTB-1027. US Patent 6287800 (11 Sept 2001)
 10. Giordano W, Domenech CE (1999) Aeration affects acetate destination in *Gibberella fujikuroi*. *FEMS Microbiol Lett* 180:111–116. doi:[10.1111/j.1574-6968.1999.tb08784.x](https://doi.org/10.1111/j.1574-6968.1999.tb08784.x)
 11. Graebe JE, Rademacher W (1979) Gibberellin A₄ produced by *Sphaceloma manihoticola* the cause of the super elongation disease of cassava (*Manihot esculenta*). *Biochem Biophys Res Commun* 91:35–40
 12. Graebbe JE, Rademacher W (1981) Fermentation method for producing a plant growth modifying compound. Eur Patent EP0024951
 13. Gutiérrez-Mañero F, Ramos-Solano B, Probanza A, Mehouchi J, Tadeo FR, Talon M (2001) The plant-growth-promoting rhizobacteria *Bacillus pumilus* and *Bacillus licheniformis* produce high amounts of physiologically active gibberellins. *Physiol Plant* 111:206–211. doi:[10.1111/j.1399-3054.2001.1110211.x](https://doi.org/10.1111/j.1399-3054.2001.1110211.x)
 14. Kang SM, Joo GJ, Hamayun M, Na CI, Shin DH, Kim HY, Hong JK, Lee IJ (2009) Gibberellin production and phosphate solubilization by newly isolated strain of *Acinetobacter calcoaceticus* and its effect on plant growth. *Biotechnol Lett* 31:277–281. doi:[10.1007/s10529-008-9867-2](https://doi.org/10.1007/s10529-008-9867-2)
 15. Kawaide H, Sassa T (1993) Accumulation of gibberellin A₁ and metabolism of gibberellin A₉ to A₁ in a fungus *Phaeosphaeria* sp. culture. *Biosci Biotechnol Biochem* 57:1403–1405
 16. Kawaide H (2006) Biochemical and molecular analysis of gibberellin biosynthesis in fungi. *Biosci Biotechnol Biochem* 70:583–590. doi:[10.1271/bbb.70.583](https://doi.org/10.1271/bbb.70.583)
 17. Khan SA, Hamayun M, Yoon H, Kim H, Suh S, Hwang S, Kim J, Lee I, Choo Y, Yoon U, Kong W, Lee B, Kim J (2008) Plant growth promotion and *Penicillium citrinum*. *BMC Microbiol* 8:231. doi:[10.1186/1471-2180-8-231](https://doi.org/10.1186/1471-2180-8-231)
 18. Kim H-J, Millar BW (2009) GA₄₊₇ plus BA enhances postproduction quality in pot tulips. *Postharvest Biol Technol* 51:272–277. doi:[10.1016/j.postharvbio.2008.07.002](https://doi.org/10.1016/j.postharvbio.2008.07.002)
 19. Kumar PKP, Lonsane BK (1987) Gibberellic acid production by solid state fermentation: consistent and improved yields. *Biotechnol Bioeng* 30:267–271. doi:[10.1002/bit.260300217](https://doi.org/10.1002/bit.260300217)
 20. Lale G, Jogdand VV, Gadre RV (2006) Morphological mutants of *Gibberella fujikuroi* for enhanced production of gibberellic acid. *J Appl Microbiol* 100:65–72. doi:[10.1111/j.1365-2672.2005.02754.x](https://doi.org/10.1111/j.1365-2672.2005.02754.x)
 21. MacMillan J (2002) Occurrence of gibberellins in vascular plants, fungi, and bacteria. *J Plant Growth Regul* 20:387–442. doi:[10.1007/s003440010038](https://doi.org/10.1007/s003440010038)
 22. Malonek S, Bomke C, Bornberg-Bauer E, Rojas MC, Hedden P, Hopkins P, Tudzynski B (2005) Distribution of gibberellin biosynthetic genes and gibberellin production in the *Gibberella fujikuroi* species complex. *Phytochem* 66:1296–1311. doi:[10.1016/j.phytochem.2005.04.012](https://doi.org/10.1016/j.phytochem.2005.04.012)
 23. Mihlan M, Homann V, Liu TWD, Tudzynski B (2003) AREA directly mediates nitrogen regulation of gibberellin biosynthesis in *Gibberella fujikuroi*, but its activity is not affected by NMR. *Mol Microbiol* 47:975–991. doi:[10.1046/j.1365-2958.2003.03326.x](https://doi.org/10.1046/j.1365-2958.2003.03326.x)
 24. Miller GL (1959) Use of dinitrosalicylic acid reagent for determination of reducing sugar. *Anal Chem* 33:426–428
 25. Rademacher W (1992) Occurrence of gibberellins in different species of the fungal genera *Sphaceloma* and *Elsinoe*. *Phytochemistry* 31:4155–4157
 26. Rim SO, Lee J, Chol W, Hwang S, Suh S, Lee I, Rhee I, Kim J (2005) *Fusarium proliferatum* KGL0401 as a new gibberellin producing fungus. *J Microbiol Biotechnol* 15:809–814
 27. Sassa T, Suzuki K (1989) Isolation and identification of gibberellins A₄ and A₉ from a fungus *Phaeosphaeria* sp. *Agric Biol Chem* 53:303–304
 28. Takahashi N, Phinney BO, MacMillan J (1991) *Gibberellins*. Springer, New York
 29. Tudzynski B (1999) Biosynthesis of gibberellins in *Gibberella fujikuroi*: biomolecular aspects. *Appl Microbiol Biotechnol* 52:298–310
 30. Tudzynski B, Mihlan M, Rojas MC, Linnemannstons P, Gaskin P, Hedden P (2003) Characterization of the final two genes of the gibberellin biosynthesis gene cluster of *Gibberella fujikuroi* *des* and *p450-3* encode GA₄ desaturase and the 1, 3-hydroxylase, respectively. *J Biol Chem* 278:28635–28643. doi:[10.1074/jbc.M301927200](https://doi.org/10.1074/jbc.M301927200)
 31. Yamaguchi S (2008) Gibberellin metabolism and its regulation. *Annu Rev Plant Biol* 59:225–251. doi:[10.1146/annurev.arplant.59.032607.092804](https://doi.org/10.1146/annurev.arplant.59.032607.092804)
 32. Yan F, Lin J (1999) *Gibberella fujikuroi* strain used for industrial fermentation production of gibberellin A₄ and A₇. Chin Patent CN1222575 (14 July 1999)
 33. Zeigler RS, Powell LE, Thurston HD (1979) Gibberellin A₄ production by *Sphaceloma manihoticola*, causal agent of cassava super elongation disease. *Physiol Biochem* 70:589–593