

**DESIGN AND SYNTHESIS OF BILE ACID BASED
CONJUGATES, DIMERS, OLIGOMERS AND THEIR
PHARMACOLOGICAL AND SUPRAMOLECULAR
APPLICATIONS**

**Mr. NILKANTH G. AHER
(RESEARCH STUDENT)**

**Dr. Mrs. VANDANA S. PORE
(RESEARCH SUPERVISOR)**

**ORGANIC CHEMISTRY DIVISION
NATIONAL CHEMICAL LABORATORY
PUNE 411 008, INDIA**

JANUARY 2009

**DESIGN AND SYNTHESIS OF BILE ACID BASED CONJUGATES,
DIMERS, OLIGOMERS AND THEIR PHARMACOLOGICAL AND
SUPRAMOLECULAR APPLICATIONS**

THESIS
SUBMITTED TO THE
UNIVERSITY OF PUNE
FOR THE DEGREE OF
DOCTOR OF PHILOSOPHY
IN
CHEMISTRY

BY
Mr. NILKANTH GANPAT AHER
ORGANIC CHEMISTRY DIVISION
NATIONAL CHEMICAL LABORATORY
PUNE 411 008, INDIA



Dedicated To
My Family...



राष्ट्रीय रासायनिक प्रयोगशाला
(वैज्ञानिक तथा औद्योगिक अनुसंधान परिषद)
डॉ. होमी भाभा मार्ग पुणे - 411 008. भारत
NATIONAL CHEMICAL LABORATORY
(Council of Scientific & Industrial Research)
Dr. Homi Bhabha Road, Pune - 411 008. India.



Dr. (Mrs.) Vandana S. Pore
Scientist-EII
Organic Chemistry Division

Phone: +91-20-25902320
Fax: +91-20-25902624
E-mail: vs.pore@ncl.res.in
Website: <http://www.ncl-india.org>

January 20, 2009

CERTIFICATE

This is to certify that the work incorporated in the thesis entitled “*Design and Synthesis of Bile Acid Based Conjugates, Dimers, Oligomers and Their Pharmacological and Supramolecular Applications*” which is being submitted to the *University of Pune* for the award of *Doctor of Philosophy in Chemistry* by *Mr. Nilkanth Ganpat Aher* was carried out by him under my supervision at the National Chemical Laboratory, Pune. Such material as has been obtained from other sources has been duly acknowledged in the thesis.

Dr. Mrs. Vandana S. Pore
Research Guide
Organic Chemistry Division
National Chemical Laboratory
Pune 411008, India

	☎	FAX	WEBSITE
Communication Channels	NCL Level D/D : 2590 NCL Board No. : +91-20-25902000 EPABX : +91-20-25893300 +91-20-25893400	Director's Office : +91-20-25893355 COA's Office : +91-20-25893619 COS&P's Office : +91-20-25893008	www.ncl-india.org



National Chemical Laboratory, Pune (India)

CANDIDATE'S DECLARATION

I hereby declare that the thesis entitled “*Design and Synthesis of Bile Acid Based Conjugates, Dimers, Oligomers and Their Pharmacological and Supramolecular Applications*” submitted by me for the degree of *Doctor of Philosophy in Chemistry* to the *University of Pune* is the record of work carried out by me during the period *April, 2004 to December, 2008* and has not been submitted by me for a degree to any other University or Institution. This work was carried out at Organic Chemistry Division, National Chemical Laboratory, Pune, India.

Nilkanth G. Aher
Organic Chemistry Division
National Chemical Laboratory
Pune 411008, India

January 2009

ACKNOWLEDGEMENTS

It gives me great pleasure to express my deep sense of gratitude to my mentor and guide Dr. Mrs. Vandana S. Pore for her constant and generous support and guidance. I am grateful to her for giving me a great opportunity to flow in such an ocean of chemistry and motivating me in steroid chemistry and appreciate her able guidance, wholeheartedly. Working with her was really a great pleasure and fetched me a lot of learning experience.

It is really a great help and guidance rendered by Dr. P. K. Shukla, and his group at Division of Fermentation Technology, Central Drug Research Institute, Lucknow, Dr. M. K. Bhat and his group at National Centre for Cell Science, Pune University Campus, Pune for biological activity of new molecules, without their help it would be an incomplete research. I express my gratitude to all of them.

I am grateful to Dr. B. G. Hazra, and Dr. Mrs. V. A. Kumar, for their advice, guidance, support and encouragements during every stage of this research work.

My thanks are due to Dr. K. N. Ganesh, Director Indian Institute of Science Education and Research, Pune (former Head, OCS Division) for his constant support. It is my privilege to thank Dr. Ganesh Pandey, Head, OCD, Dr. S. Sivaram (Director, NCL) for permitting me to work in NCL, UGC-CSIR, New Delhi for fellowship. I am also grateful to Dr. H. B. Borate, Dr. P. L. Joshi, Dr. D. D. Dhavale, Dr. N. P. Argade, Dr. S. P. Chavan, Dr. U. R. Kalkote, Dr. Mrs. R. D. Wakharkar, Dr. R. A. Joshi, Dr. Mrs. R. R. Joshi, for their help and encouragement.

I would also like to acknowledge all the staff members of GC, HPLC, IR, NMR, Mass, Microanalysis, X-ray analysis, Library, Administration and technical divisions of NCL for their assistance during the course of my work.

I feel great sense of gratitude for Dr. V. B. Gaikwad (Dean of Science faculty, University of Pune and Principal K.T.H.M. college Nashik) for his inspirational teaching, ethics and discipline. He has introduced me to this fascinating subject and inspired me to move towards the research. I take this opportunity to thank my teachers, Prof. S. R. Ahire, Dr. G. H. Jain, D. D. Kajale, Y. R. Baste, P. Kulkarni, Art. Comm & Sci, College Nandgaon (Nashik), Dr. Awachat, Dr. Bhagwat, Dr. Mrs. Deshpande (S. P. College, Pune) for their encouragements and motivation during my B. Sc. and M. Sc. studies.

Most importantly, I am very much thankful to my lab-friends Namdev, Bapu, Deepak, Sudhir, Sachin, and Khandekar for helping me in various capacities throughout my work and maintaining cheerful atmosphere with humor in the lab. Thanks are due to Sheetal, Minakshi, Anurag, and Richa for the help during their project tenure in our laboratory.

I take this opportunity to thank to my present labmates Dr. Moneesha, D'costa, Mrs. Anita Gunjal, Khirud, Sachin, Madhuri, Seema, Namrata, Venu, Kiran, Parmeshwar, Harshid, Mrs. Mane and Bhumkar. They made working in the lab enjoyable.

No words will be sufficient to express my thanks to my friends Arun, Navnath, Rajabhau, Amit, Mahesh, Manoj, Motikar, Sachin, Vinayak, Shekhar, Prashant, Nagendra (NB), Kulbhushan, Sachin Narute, Lalit, Pankaj, Patwa, Mahesh, Awadhut, Pandurang, Amol, Shriram, Ganesh, Sharad, Abasaheb, Suleman, Manmat, Ravi, Kishor, Prasanna, Ramesh, Vishal Mahajan, Vilas, Lakshman, Sanjay, Taterao, Shafi, Kiran, Kishan, Mrs. Ajit Malwade, Pawar, Umesh, Dr. Sada, Dr. Anil, Dr. Modani and Milind Dumbare all my friends of NCL as well as out of NCL during my long stay in NCL, who helped me whenever it was needed; be it personal or research related.

I owe my deepest gratitude and affection to my parents Nana and Tai. No word would suffice to express my gratitude and love to Yogesh (brother), Minakshi, Shidhi, Aruna (sister), Mahendra, Lalit, Satish, Chhaya, Shivali, Surekha, Harshali, Yogesh, Bhushan, Rani, father in law, mother in law, Savita Shingote, Sandhya, Sonali, Sphurti, Sheetal, Prerna, Alka, Kalpana, Arnav, Tanu, Anushka, Sonu, all other relatives and friends for their continuous showering of boundless affection on me and supporting me in whatever I chose or did. The warmth and moral value of my parents have stood me in good stead throughout my life and I would always look up to them for strength no matter what I have to go through. This Ph. D. thesis is a result of the extraordinary wills, efforts and sacrifices of my parents. My successes are dedicated to them now and always.

The love and support from my wife MANISHA who walked along with me, sharing every ups and downs and I am highly indebted to them for their sacrifice, help and encouragement for the healthy and inspiring environment with out whom I would not been able to stand out as a person and my deep sense of gratitude remains forever. The thesis is a form to pay respect to their attributes. I thank my son OM (Sharvil) for making my life more beautiful than it was. I dedicate this achievement to my parents and wife Manisha and son Om.

Finally, my acknowledgement would not be completed without thanking the God Shiva, for giving me the strength and the determination to overcome the hardship faced in my life.

Nilkanth

CONTENTS

General remarks	i	
Abbreviations	iii	
Abstract	vi	
Chapter 1	Synthesis of bile acid based dimers, oligomers to study their micelle like properties and studies towards the synthesis of cholaphanes.	
1.1	Abstract	1
1.2	Introduction	2
1.3	Review of literature	2
1.4	Present work	14
1.4.1	Objective	14
1.4.2	Results and discussion	16
1.5	Conclusion	28
1.6	Experimental section	28
1.7	Selected spectra	47
1.8	References	77
Chapter 2	Synthesis of bile acid-fluconazole conjugates, new fluconazole analogues using click reaction, bile acid based amino alcohols and their bioevaluation.	
Section I	Synthesis of bile acid-fluconazole conjugates and new fluconazole analogues using click reaction and their bioevaluation.	
2.1.1	Abstract	86
2.1.2	Introduction	87
2.1.3	Review of literature	87
2.1.4	Present work	99
2.1.4.1	Objective	99
2.1.4.2	Result and discussion	100
2.1.5	Conclusion	107

2.1.6	Experimental section	108
2.1.7	Selected spectra	119
2.1.8	References	132
Section II Synthesis and bioevaluation of bile acid based amino alcohols.		
2.2.1	Abstract	137
2.2.2	Introduction	138
2.2.3	Review of literature	138
2.2.4	Present work	143
2.2.4.1	Objective	143
2.2.4.2	Results and discussion	143
2.2.5	Conclusion	148
2.2.6	Experimental section	149
2.2.7	Selected spectra	159
2.2.8	References	174
Chapter 3 Stereoselective synthesis of steroidal side chain from 16-dehydropregalone acetate.		
3.1	Abstract	177
3.2	Introduction	178
3.3	Review of literature	180
3.4	Present work	193
3.4.1	Objective	193
3.4.2	Results and discussion	193
3.5	Conclusion	200
3.6	Experimental section	200
3.7	Selected spectra	207
3.8	References	221
List of Publications		226
Erratum		228

GENERAL REMARKS

- Independent reference and compound numbering have been employed for abstract, as well as each chapter (Chapter 1-3).
- All the solvents used were purified using the known literature procedures.
- Petroleum ether used in the experiments was of 60-80 °C boiling range.
- Column chromatographic separations were carried out by gradient elution using silica gel (60-120 mesh/230-400 mesh) or neutral deactivated alumina with light petroleum ether-ethyl acetate mixture, unless otherwise mentioned.
- TLC was performed on E-Merck pre-coated silica gel 60 F₂₅₄ plates and the spots were rendered visible by exposing to UV light, iodine, charring or staining with ninhydrin, *p*-anisaldehyde or phosphomolybdic acid solutions in ethanol.
- Microwave irradiation was carried out in an open glass vessel using a domestic microwave oven (800 watt, BPL-make).
- Usual work up: organic layer was washed with H₂O and brine, dried over anhydrous Na₂SO₄ and concentrated in *vacuo*.
- Crystallization: Single crystals of the compounds were grown from a hot saturated filtered solution of these compounds in particular solvent. Suitable crystals were obtained by slow evaporation of the solvent at room temperature (RT).
- All the melting points reported are uncorrected and were recorded using an electrothermal melting point apparatus or with Buchi Melting Point apparatus B-540.
- Ultraviolet (UV) spectra were performed using Perkin-Elmer instrument, Lambda 35 UV/VIS Spectrometer.
- IR spectra were recorded on Shimadzu FTIR instrument, for solid either as nujol mull or in chloroform solution and neat in case of liquid compounds.
- NMR spectra were recorded on Bruker ACF 200 and AV200 (200.13 MHz for ¹H NMR and 50.03 MHz for ¹³C NMR), MSL 300 (300.13 MHz for ¹H NMR and 75.03 MHz for ¹³C NMR), AV 400 (400.13 MHz for ¹H NMR and 100.03 MHz for ¹³C NMR) and DRX 500 (500.13 MHz for ¹H NMR and 125.03 MHz for ¹³C NMR) spectrometers. Chemical shifts (δ) reported are referred to internal reference tetramethylsilane (TMS). The following abbreviations were used: s = singlet, d = doublet, t = triplet, q = quartet, m = multiplet, bs = broad singlet, dd = doublet of doublet, dt = doublet of triplet and ddd = doublet of doublet of doublet.

- Mass spectra were recorded on Finnigan-Mat 1020C mass spectrometer and were obtained at an ionization potential of 70 eV or on LC-MS/MS-TOF API QSTAR PULSAR spectrometer, samples introduced by infusion method using Electrospray Ionization Technique. EI and CI mass spectra were recorded on an AEI MS-50 and AEI MS-9 spectrometer, respectively.
- Micro analytical data were obtained using a Carlo-Erba CHNS-O EA 1108 Elemental Analyzer. Elemental analyses observed for all the newly synthesized compounds were within the limits of accuracy ($\pm 0.4\%$).
- Optical rotations were obtained on Bellingham & Stanley ADP-220 Polarimeter. Specific rotations ($[\alpha]_D$) are reported in deg/dm, and the concentration (c) is given in g/100 mL in the specific solvent.
- All the compounds previously known in the literature were characterized by comparison of their R_f values on TLC, IR and NMR spectra as well as melting point with authentic samples.
- Starting materials were obtained from commercial sources or prepared using known procedures.

ABBREVIATIONS

AIDS	Acquired Immunodeficiency Syndrome
Amp B	Amphotericin B
Aq.	Aqueous
AZT	Azidothymidine
9-BBN	9-Borabicyclononane
BER	Borohydrate exchange resin
Boc	<i>tert</i> -Butoxycarbonyl
Bzl	Benzyl
Cat.	Catalytic
CCDC	Cambridge Crystallographic Data Centre
CFU	Colony forming units
CSA	Cationic Steroid Antibiotics
CSD	Cambridge Structural Database
CR	Cresol red
DCM	Dichloromethane
DCR	1,3-Dipolar cycloaddition reaction
DEAD	Diethylazodicarboxylate
DECP	Diethyl cyanophosphonate
DEPT	Distortionless Enhancement by Polarization Transfer
DMAP	4-(Dimethylamino) pyridine
DMF	Dimethylformamide
DMSO	Dimethyl Sulphoxide
DNA	Deoxyribonucleic acid
16-DPA	16-dehydropregalone
DTPA	Diethylenetriamine pentaacetic acid
EC	Effective Concentration
ED	Effective Dose
EDCI	1-(3-Dimethylaminopropyl)-3-Ethylcarbodiimide Hydrochloride
ee	Enantiomeric Excess
EF2	Elongation Factor 2
equiv.	Equivalent(s)
ER	Endoplasmic Reticulum

EtOH	Ethanol
5-FC	5-fluorocytosine
FIC	Fractional Inhibition Concentration
FL	Fluorescence
5-FU	5- fluorouracil
gp	Glycoprotein
GR	Glucocorticoid Receptor
h	Hour(s)
HGO	Hepatic glucose output
HIV	Human immunodeficiency virus
HMPA	Hexamethylphosphoric triamide
HPLC	High Performance Liquid Chromatography
HSD	Hydroxysteroid Dehydrogenase
Hz	Hertz
IC	Inhibitory Concentration
IR	Infra Red
LAH	Lithium Aluminum Hydride
LPS	Lipopolysaccharide
MeOH	Methanol
MEM	Methoxyethoxymethyl ethers
MIC	Minimum Inhibitory Concentration
min.	Minute(s)
mL	Millilitre(s)
μM	Micromolar
mmol	Millimole(s)
Mp	Melting Point
MS	Mass Spectrum
MS 4Å	Molecular Sieves (4Å)
MsCl	Mesyl Chloride
MW	Microwave
NCCLS	National Committee for Clinical Laboratory Standard
NCIM	National Collection of Industrial Micro-Organisms
NMR	Nuclear Magnetic Resonance

ORTEP	Orthogonal Thermal Ellipsoid Plots
PCR	Polymerase Chain Reaction
PE	Petroleum Ether
PMB	Polymyxin B
PTB	Pyridinium Tribromide
PTFE	Polytetrafluoroethylene
<i>p</i> -TSA	<i>p</i> -Toluenesulfonic acid
<i>p</i> -TsCl	<i>p</i> -Toluenesulfonyl chloride
Py	Pyridine
RNA	Ribonucleic Acid
rt	Room Temperature
RT	Reverse Transcription
SAR	Structure Activity Relationships
SCP	Sterol Carrier Proteins
S _N ¹	Unimolecular Nucleophilic Substitution
S _N ²	Bimolecular Nucleophilic Substitution
TBAB	Tetrabutylammonium bromide
Temp.	Temperature
TFA	Trifluoroacetic acid
THF	Tetrahydrofuran
TLC	Thin Layer Chromatography
TMSCl	Trimethylchlorosilane
TMSOI	Trimethyl Sulfoxonium Iodide
TPP	Triphenylphosphine
UV-VIS	UV-VIS spectrometer.
W	watt

Research Student: Nilkanth G. Aher
Research Guide: Dr. Mrs. Vandana S. Pore
Title of the Thesis: “Design and Synthesis of Bile Acid Based Conjugates, Dimers, Oligomers and Their Pharmacological and Supramolecular Applications”
Registration Number: EI/67/Ph.D/2005 Dated March 24, 2005
Date of Registration: 21.04.2004
Place of Work: Organic Chemistry Division,
National Chemical Laboratory,
Pune 411 008.

ABSTRACT

The thesis entitled “**Design and Synthesis of Bile Acid Based Conjugates, Dimers, Oligomers and Their Pharmacological and Supramolecular Applications**” has been divided into three chapters.

Chapter 1: Synthesis of bile acid based dimers, oligomers to study their micelle like properties and studies towards the synthesis of cholaphanes.

Chapter 2: Synthesis of bile acid-fluconazole conjugates, new fluconazole analogues using click reaction, bile acid based amino alcohols and their bioevaluation.

Chapter 3: Stereoselective synthesis of steroidal side chain from 16-dehydropregalone acetate.

Chapter 1: Synthesis of bile acid based dimers, oligomers to study their micelle like properties and studies towards the synthesis of cholaphanes.

Introduction

Bile acids are versatile building blocks for the design and synthesis of macrocyclic and open chain supramolecular hosts due to their large, rigid, and curved steroidal skeletons, chemically different hydroxy groups, enantiomeric purities, and their unique amphiphilicity, together with their availability and low cost.¹ Bile acids and their derivatives are also important compounds from the pharmaceutical point of view. In their

dimeric form, bile acids or their derivatives show inclusion of methanol, carbohydrate, perylene, and DNA. Such dimers also act as artificial ionophores and are found to be potential receptors for neutral molecules or metal cations.² The configuration of dendritic structures based on steroidal moieties may give rise to potential molecular assemblies with many interesting nano-scale applications, including organ-targeted drug carriers, artificial ion channels, organogelators and molecular switches.

In this chapter we present our studies on the synthesis of bile acid dimers and oligomers based on Cu (I) catalyzed 1,3 dipolar cycloaddition of terminal alkyne and azide (click reaction).³ Their micelle like properties have been studied by encapsulation of hydrophilic dye (cresol red) in non polar solvent (chloroform) using solid liquid extraction protocol and efforts towards the synthesis of cholaphanes.

Synthesis of terminal alkynes:

Terminal alkynes were synthesized by esterification of bile acids **1** and **2** using an excess of propargyl alcohol and a catalytic amount of *p*-TSA (*para*-toluenesulfonic acid) to get compounds **3** and **4** (Scheme 1).

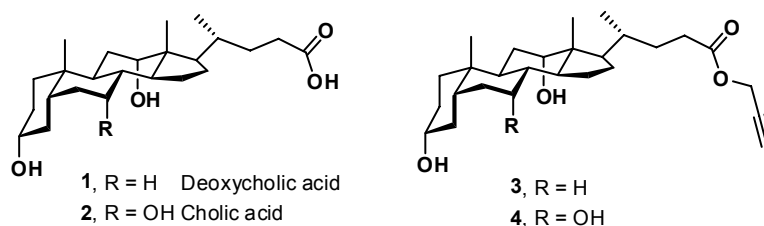

Scheme 1: Reagents and Conditions: *p*-TSA (10 mol %), Propargyl alcohol, 55-60 °C, 7 h, **3** (96%), **4** (95%).

Synthesis of azides:

Azides at C-3 and C-24 positions of bile acids were synthesized (Scheme 2). Esterification of deoxycholic acid **1** and cholic acid **2** using excess methanol and catalytic amount of *p*-TSA afforded methyl esters **5** and **6**. These esters on reduction with LAH followed by selective mesylation and nucleophilic substitution of mesyl with sodium azide gave C-24 azido compounds **7** and **8**. C-3 α -azides **9** and **10** were synthesized using Mitsunobu reaction, while C-3 β -azides **11** and **12** were synthesized by mesylation followed by nucleophilic substitution of mesyl with sodium azide from compounds **5** and **6**.

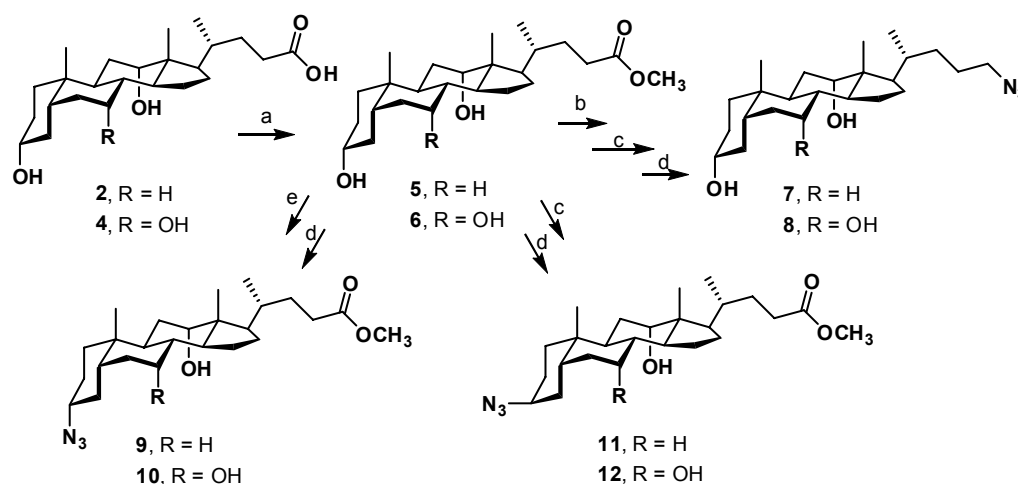

Scheme 2: Reagents and conditions: (a) *p*-TSA/MeOH, 25 °C, 24 h, 95-96%; (b) LAH/THF, 25 °C, 2 h, 93-97%; (c) MsCl, Et₃N, CH₂Cl₂, 0 °C, 10 min; (d) NaN₃, DMF, 60 °C, 3 h, 93-94%; (e) Ph₃P, Et₃N, MeSO₃H, DEAD, THF, 45 °C, 24 h.; 75-78 % (overall in 2 steps).

Synthesis of Dimers:

Bile acid dimers **13-18** (Figure 1) linked with 1,2,3 triazole were synthesized on 1,3-dipolar cycloaddition of terminal alkynes **3** or **4** (Scheme 1) with terminal azides **7-12** (Scheme 2). General graphical representation is depicted in Scheme 3. In our earlier report⁴ this reaction was carried out in *t*-BuOH/H₂O using catalytic amount CuSO₄·5H₂O and sodium ascorbate at 60-65 °C for 3-12 h. Same reaction under microwave irradiation in DMF/H₂O was completed in less reaction time (5-10 min).

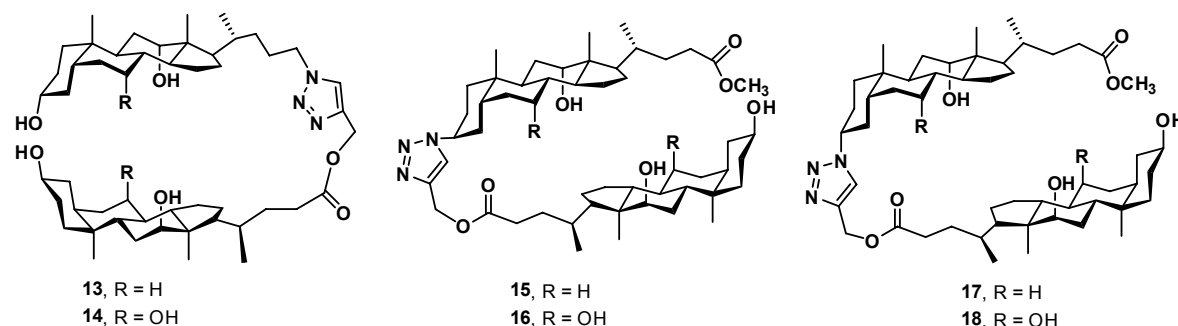
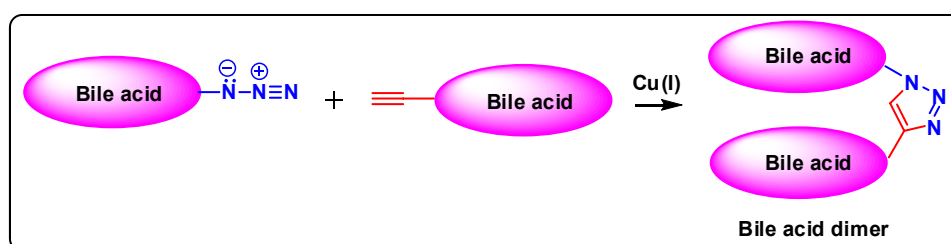

Figure 1: Bile acid dimers



Scheme 3: Reagents and conditions: CuSO₄·5H₂O (5 mol %), Sodium ascorbate (40 mol %), DMF:H₂O (4:1), Microwave, 5 min, 90-96%.

Synthesis of oligomers:

Hydroxyl groups of bile acids were esterified using chloroacetyl chloride (Scheme 4). Transformation of chloro functionality of compound **19** and **20** into azides **21** and **22** was carried out using sodium azide in DMF at 75 °C. These two azides on cycloaddition reaction with propargyl ester **3** and **4** afforded trimer **23** and tetramer **24** respectively.⁵

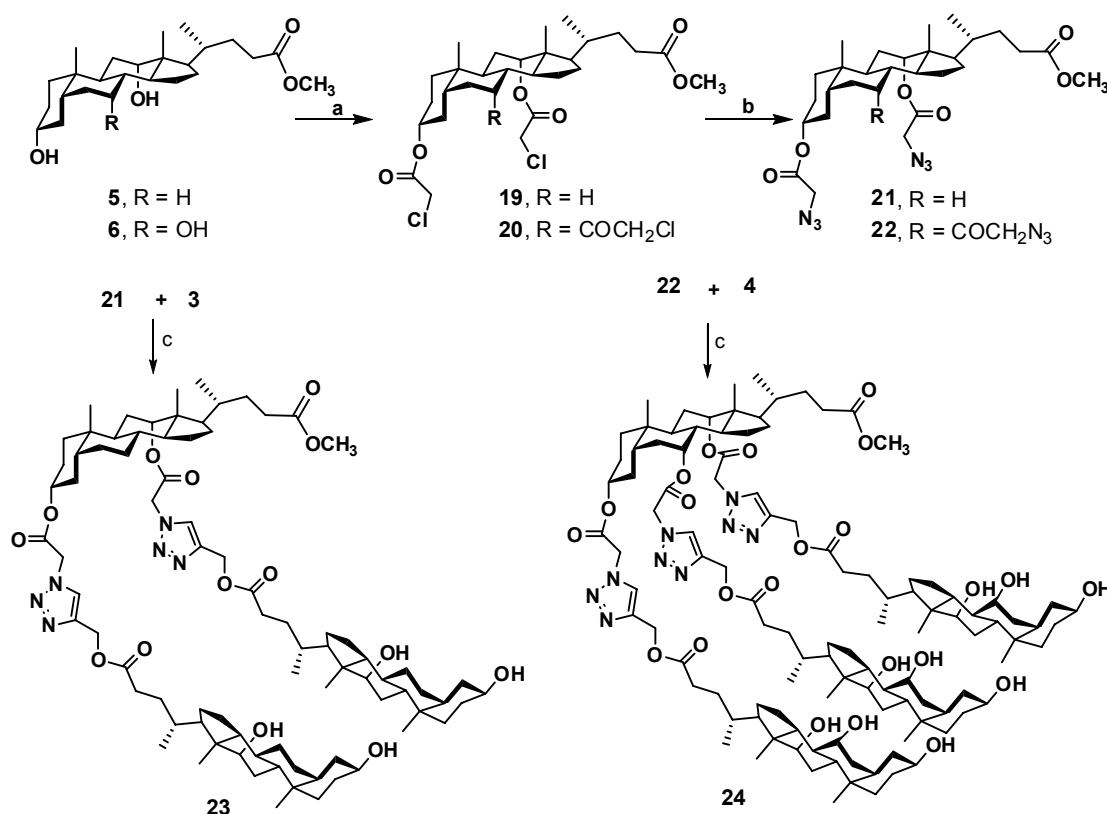

Scheme 4: Reagents and conditions: (a) CaH₂, ClCH₂COCl, TBAB, toluene (reflux), 3 h, 78-86%; (b) NaN₃, DMF, 75 °C, 12 h, 79-82%; (c) CuSO₄·5H₂O (5 mol %), Sodium ascorbate (40 mol%), DMF:H₂O (4:1), Microwave, 5 min, **23** (85%), **24** (82%).

Dye solubilisation study:

Bile acid dendrons can adopt a reverse micelle-like conformation in nonpolar solvent with the hydrophobic face turned outwards (towards the solvent).⁶ In this chapter, the study of micellar properties of newly synthesized dimers **13-18** and oligomers **23** and **24** was carried out by solid liquid extraction protocol of the sodium salt of cresol red dye (hydrophilic dye) in nonpolar solvent, chloroform. We found that dimeric and oligomeric compounds of methyl cholate as well as methyl deoxycholate show linear increase in dye solubilisation with increasing concentrations of the dimer, trimer and tetramer (Figure 2).

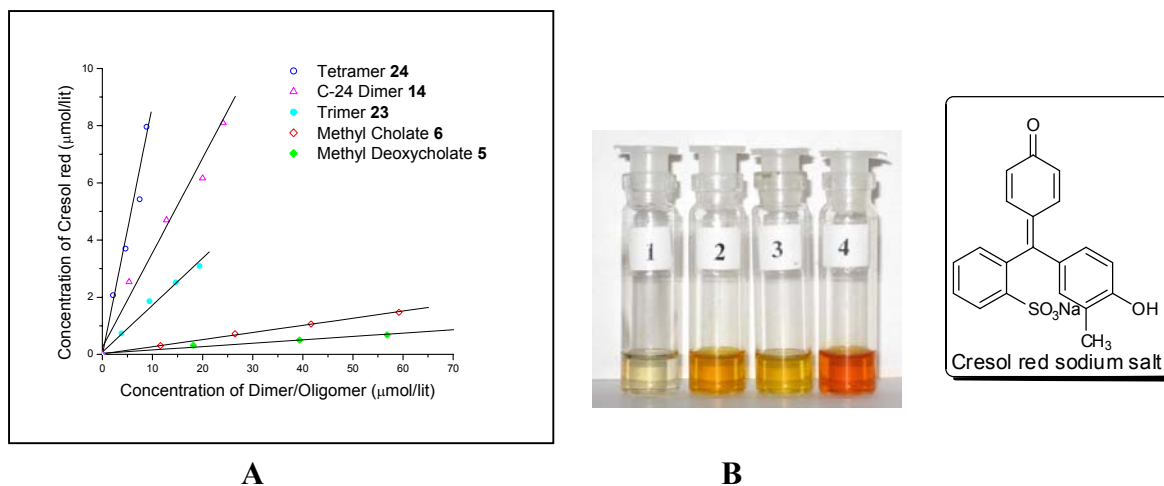
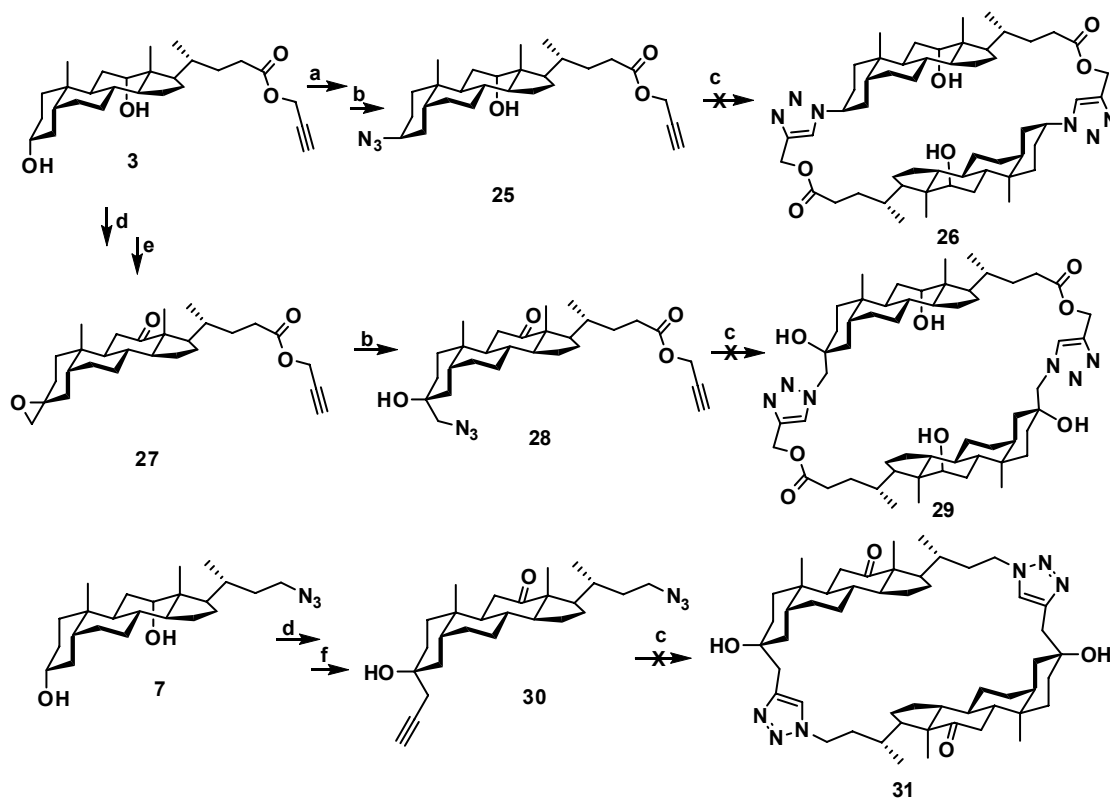

Figure 2: Solubilisation of cresol red (CR) in chloroform tetramer **24**, C-24 dimer **14**, trimer **23**, and monomers **5**, **6**. Straight lines (**A**) are linear fit lines of experimental data; Cresol red sodium salt solubilisation in chloroform having a ratio of chloroform: cresol red: oligomer (1 mL : 5 mg : 5 mg) each sample was stirred for 12 h and filtered through 0.5 µ PTFE membrane. **vial 1** has no additive, **vial 2** has C-24 dimer **14**, **vial 3** has trimer **23** and **vial 4** has tetramer **24** (**B**).

Synthesis of cholaphanes:

The design of novel macrocyclic synthetic receptors with molecular cavities is one of the most important fields in supramolecular chemistry. These host molecules can serve as model compounds for more complex biological systems and are important for molecular recognition of substrates in enzymatic processes. Typical macrocycles bind substrates in their defined cavity. The steroid nucleus can make unique contributions to this area owing to its size, chirality, and rigid polycyclic framework. The bile acids, such as cholic acid or deoxycholic acid, have proved especially useful, because of their availability and useful levels of functionalization. On one hand, the presence of functionality at both ends of these units suggests the construction of macrocyclic structures which may possess a high level of inward-directed polar functionality. On the other, the codirected hydroxyl groups present in most bile acids may be exploited (directly or indirectly) in podand-type receptors, linear dimeric hosts, or “facial amphiphiles”.⁷ Here, we tried to synthesize cholaphanes using click chemistry approach. Starting from propargyl ester of deoxycholic acid **3**, we synthesized compounds **25**, **28** and **30** which contain both azide and acetylene groups in the same molecule (Scheme 5). 1,3-Dipolar cycloaddition of **25** under various conditions failed to give cholaphane **26**. This reaction led to uncharacterized solid material. In the next attempt, we increased the chain length at C-3 position.



Scheme 5: Reagents and conditions: (a) MsCl, Et₃N, CH₂Cl₂ 0 °C, 10 min.; (b) NaN₃, DMF, 60-65 °C, 3 h, 90%; (c) CuSO₄·5H₂O (5 mol%), Sodium ascorbate (40 mol%), DMF:H₂O (4:1), Microwave, 5 min. (d) Jones reagent, acetone, 5 min, 96%. (e) Trimethyl sulfoxoniumiodide, NaH, DMSO-THF, rt. 2 h, 91%; f) Propargyl bromide, Zn, DMF/THF 25 °C, 5 h.

Under cycloaddition reaction conditions these bifunctional compounds **28** and **30** again led to uncharacterized solid material instead of cholaphanes **29** and **31**. Efforts to synthesize cholaphane by changing the positions of alkyne and azide group as in **30** remained unsuccessful.

Chapter 2: Synthesis of bile acid-fluconazole conjugate, new fluconazole analogues using click reaction, bile acid based amino alcohols and their bioevaluation.

Section I: Synthesis of bile acid-fluconazole conjugates and new fluconazole analogues using click reaction and their bioevaluation.

Introduction

The incidence of life threatening fungal infections has tremendously increased in last two decades due to greater use of immunosuppressive drugs, prolonged use of broad-spectrum

antibiotics, wide-spread use of indwelling catheters and also in cancer and AIDS patients. The presently marketed antifungal drugs are either highly toxic (amphotericin-B) or are becoming ineffective due to appearance of resistant strains (flucytosine and azoles). Azole antifungals (Figure 3) are strong inhibitors of lanosterol 14 α -demethylase, which is major component of fungal cell membrane.⁸

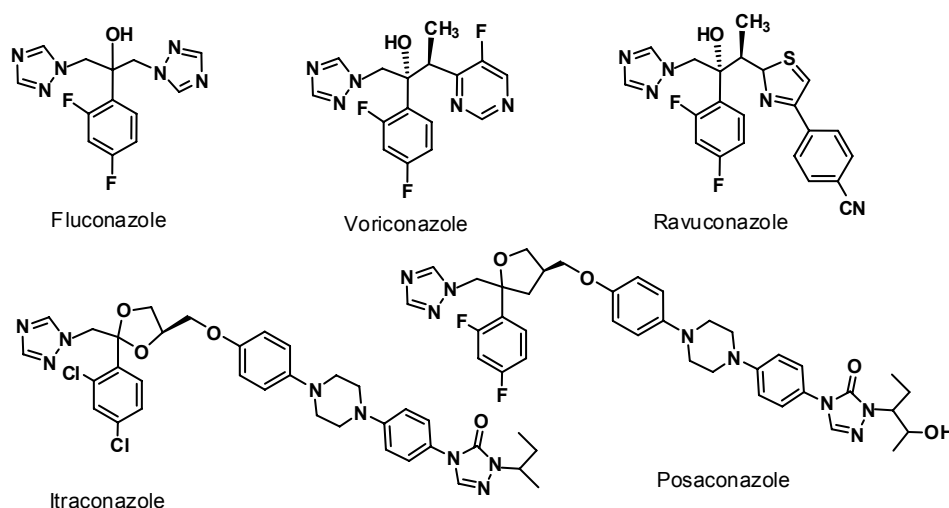

Figure 3: Azole based antifungal drugs.

Fluconazole is an orally effective, potent and safe triazole based antifungal drug, with favorable pharmacokinetic characteristics and low toxicity. Due to the emergence of new fungal pathogens, development of resistance to fluconazole, great efforts have been made to modify the chemical structure of fluconazole, in order to broaden its antifungal activity and increase its potency.⁹

Bile acid transporters have been shown to accept and carry a variety of drugs that are attached at different positions of bile acids. A common feature of bile acid derived antimicrobials is its potential to exhibit facially amphiphilic nature due to polar hydroxyl groups on one face and nonpolar hydrophobic methyl groups on the other face. Polyene macrolide amphotericin B, peptide antimicrobial agent polymixin B and squalamine in the cyclic form show such amphiphilicity and function as ionophores.¹⁰

Herein we designed bile acid- fluconazole conjugates (Scheme 6) in which one of the 1,2,4 triazole ring of fluconazole has been modified as substituted 1,2,3 triazole ring using click reaction.¹¹ In our approach to synthesize these new molecules **35-38** (Scheme 6) we considered performing click reaction to connect fluconazole part containing terminal alkyne **34** and bile acid containing azides **7, 8, 11, and 12** (Scheme 2).

Accordingly, we synthesized 2-(2,4-difluorophenyl)-1-(1*H*-1,2,4-triazol-1-yl)pent-4-yn-2-ol **34** by propargylation of the corresponding ketone **33** by using propargyl bromide and zinc dust to obtain racemic compound **34** (Scheme 6).

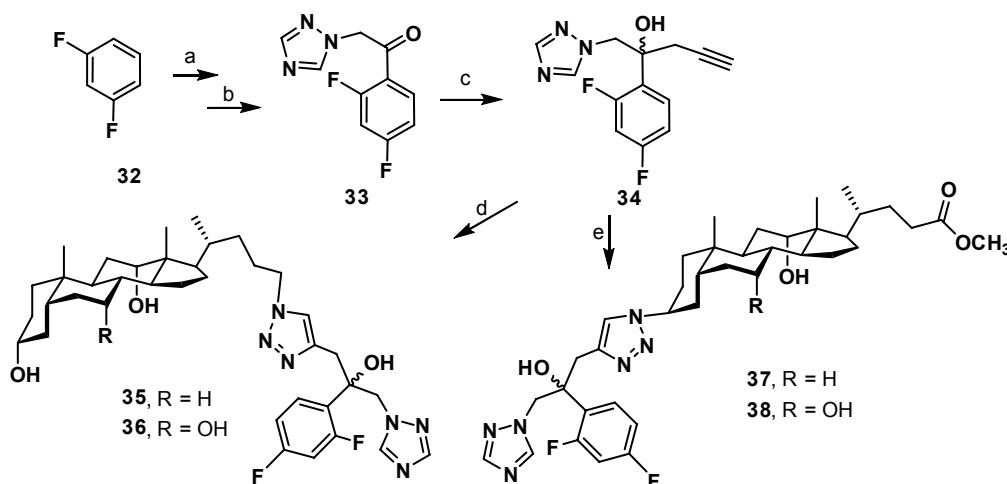

Scheme 6: Reagents and conditions: (a) AlCl_3 , 1,2-dichloroethane, chloroacetyl chloride, 25 °C, 7 h; (b) 1,2,4-triazole, NaHCO_3 , toluene, reflux, 4 h, (overall 55% in two steps); (c) Zn, Propargyl bromide, DMF/THF, 25 °C, 5 h, 95%; (d) $\text{CuSO}_4 \cdot 5\text{H}_2\text{O}$ (5 mol%), Sodium ascorbate (40 mol%), DMF:H₂O (9:1), Microwave, 5 min, 90-95%.

Under microwave irradiation, compound **34** was reacted with C-24 azide **7** (Scheme 2) in DMF/H₂O using catalytic amount of Cu(I) to give fluconazole-bile acid conjugate **35** as a diastereomeric mixture in 92% yield. We then extrapolated the ligation protocol successfully to other bile acid derived azides **8**, **11** and **12** (Scheme 2) and synthesized fluconazole-bile acid conjugates **36**, **37** and **38**.

The rationale for this drug design approach was based on the expectation that in these conjugates bile acid part would be useful to permeabilize the fungal cell membrane as well as transporter of the pharmacophore of fluconazole because of its amphiphilic nature and hence the conjugates were predicted to be more active than fluconazole itself. But all these fluconazole bile acid bioconjugates showed moderate antifungal activity against *Candida* species (MIC ranging from 3.12 to 6.25 $\mu\text{g}/\text{mL}$).

In order to find out the role of bile acid, we then synthesized two compounds **23** and **24** in which fluconazole part was attached with ester linkage. Accordingly, oxirane **39** was synthesized from the corresponding ketone **33** (Scheme 7). Opening of oxirane **39** with sodium azide gave racemic azido alcohol **40**. Microwave assisted copper catalyzed 1,3-dipolar cycloaddition of the azido alcohol **40** with propargyl esters **3** and **4** (Scheme 1), afforded diastereomeric mixture of compounds **41** and **42** in high yields. Compounds **41** and **42** showed much better antifungal activity against *Candida* species than

compounds **35-38**. We thought that ester functionality in these molecules may be hydrolyzing at physiological pH and the compounds having 1,4-substituted 1,2,3-triazole may be more active.

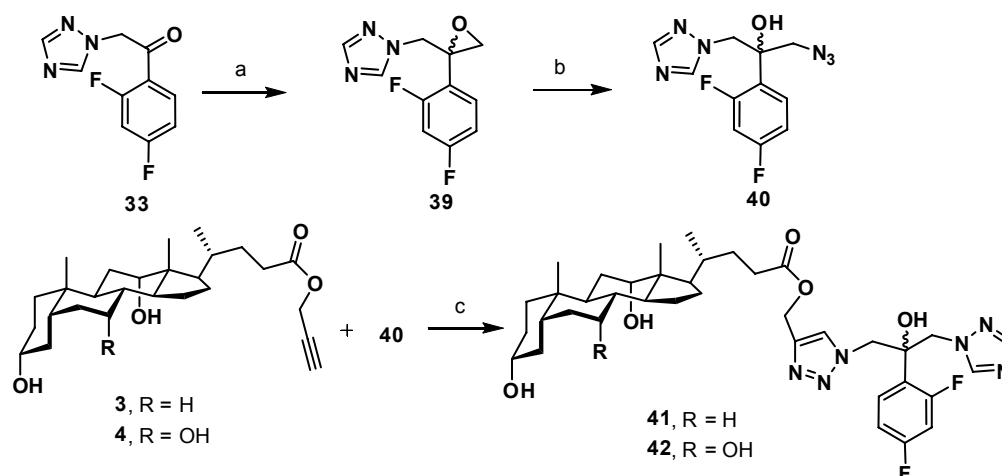

Scheme 7: Reagents and conditions: (a) Trimethylsulfoxonium iodide, NaH, DMSO-THF, rt, 2 h, 91%; (b) NaN₃, DMF, 60-65 °C, 12 h, 75%; (c) CuSO₄·5H₂O (5 mol %), Sodium ascorbate (40 mol %), DMF:H₂O (4:1), Microwave 10 min.

Encouraged by these biological results we synthesized fluconazole analogues containing monosubstituted (**43, 45**) and 1,4-disubstituted (**44, 46** and **47**) 1,2,3-triazoles from two common intermediates **34** and **40** as described in (Scheme 8) and studied their biological activity.

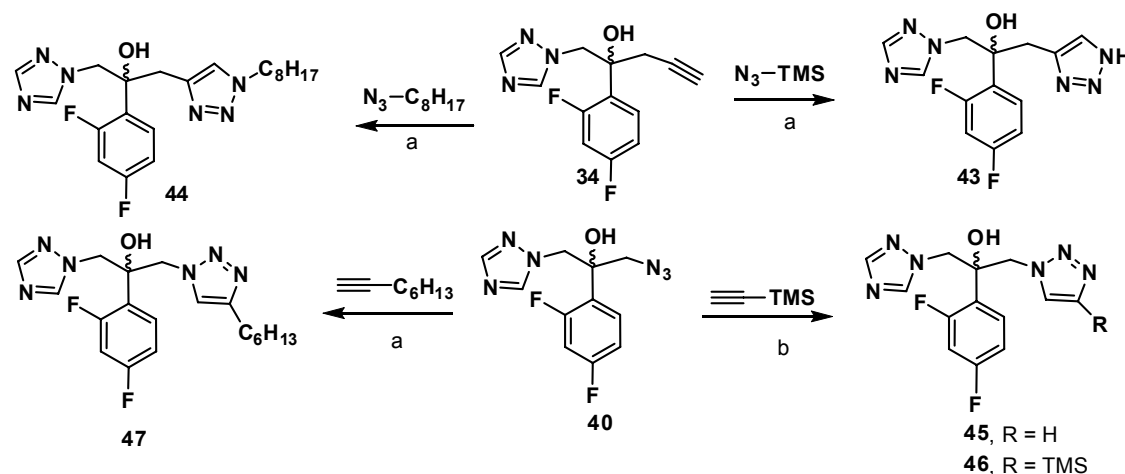

Scheme 8: Reagents and conditions: (a) CuSO₄·5H₂O (5 mol%), Sodium ascorbate (40 mol%), DMF:H₂O (4:1), Microwave (245 W), 10 min; (b) CuSO₄·5H₂O (5 mol%), Sodium ascorbate (40 mol%), DMF:H₂O (4:1), Microwave (175 W), 10 min.

All these newly synthesized compounds were found to show good antifungal activity. From the biological data, it was observed that compounds **43** and **45** having monosubstituted 1,2,3-triazole ring which are isosteres of fluconazole and compound **46**

containing trimethylsilyl group, showed good *in vitro* antifungal activity against fungal pathogens *C. albicans*, *C. neoformans* and *S. schenckii*, which was comparable with fluconazole but these compounds were less active than amphotericin B and ketoconazole. 1,4-disubstituted 1,2,3-triazole compounds **44** and **47** with long alkyl chains showed very good antifungal activity against all the tested fungal pathogens. Compound **44** showed much better activity for *C. albicans* (IC_{50} 0.001 $\mu\text{g/mL}$), *C. neoformans* (IC_{50} <0.006 $\mu\text{g/mL}$) and *C. parapsilosis* (IC_{50} 0.002 $\mu\text{g/mL}$) as compared with fluconazole, amphotericin B and ketoconazole, while compound **47** was found to be less active than compound **44** but showed better activity against *C. albicans* (IC_{50} 0.018 $\mu\text{g/mL}$), *C. neoformans* (IC_{50} <0.01 $\mu\text{g/mL}$) and *C. parapsilosis* (IC_{50} 0.043 $\mu\text{g/mL}$) as compared with fluconazole and amphotericin B. Hence the lead compounds **44** and **47** were tested for *in vivo* activity against *C. albicans* intravenous challenge in Swiss mice. Antiproliferative activities of these molecules were tested against human hepatocellular carcinoma Hep 3B and human epithelial carcinoma A431 cell lines.

Section II: Synthesis and bioevaluation of bile acid based amino alcohols.

Introduction

The medicinal chemistry of steroids covers a large and interesting series of structures and biological activities.¹² Although the number of steroidal natural products is limited, millions of hybrids steroid conjugates can be prepared. This new approach seems to be very promising in the development of lead molecule. The sterol-polyamine conjugates as a new class of antibiotics have attracted much interest in recent years. Squalamine is the first sterol-polyamine conjugate having broad spectrum antimicrobial activity. Due to the low availability of squalamine from natural resources, several groups are working on the synthesis of squalamine and its analogs (Figure 4).

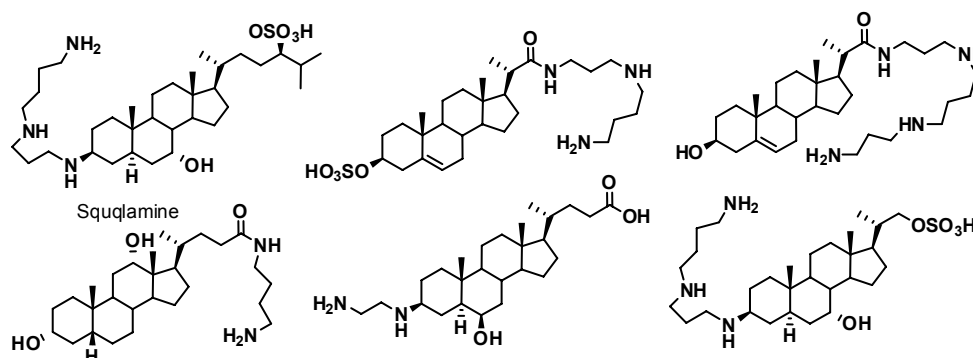
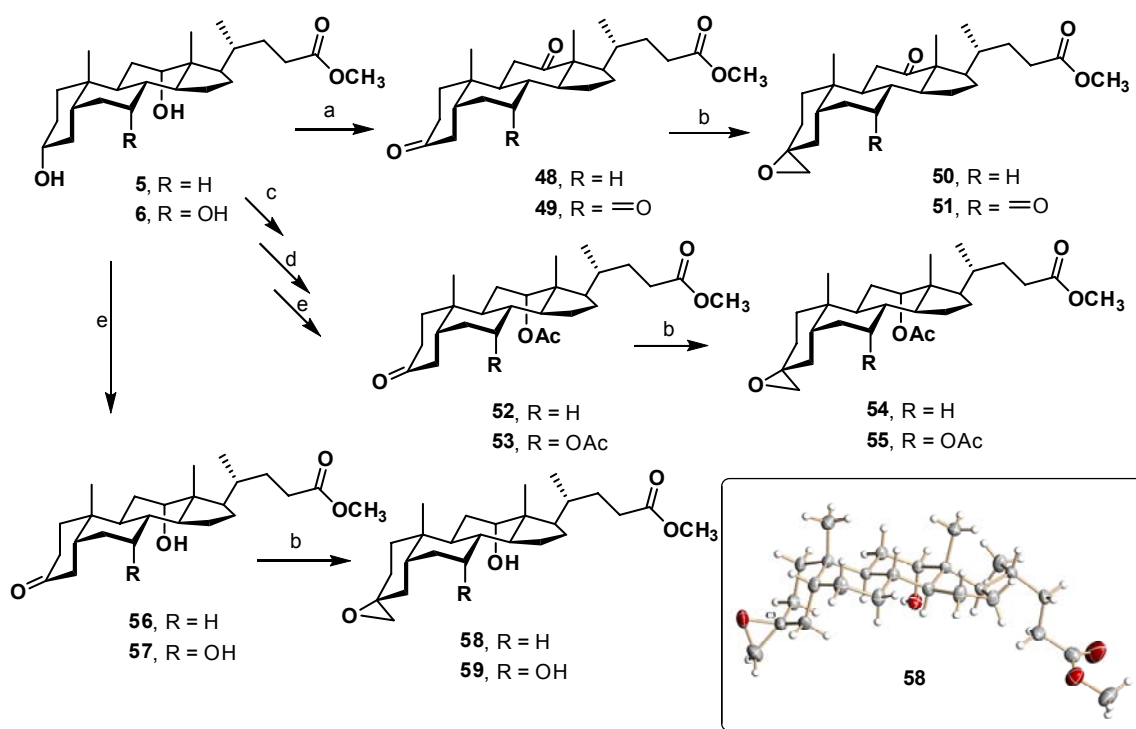

Figure 4: Sterol-polyamine conjugates.

Some of the analogues show better activity than squalamine.¹³

Variations in the structure of the analogues led to changes in the spectrum of activity against variety of bacteria and yeasts. From the literature studies it is observed that three common elements are required for their characteristic activity (i) long and rigid hydrophobic unit; (ii) a flexible hydrophilic chain which is linked to hydrophobic unit; (iii) a pendant polar head group. The precise structure of the polyamine is not important. The sulfate groups can be replaced by a carboxylate or hydroxyl or even removed altogether. The structure of the rigid hydrophobic unit i.e. steroid can also be varied.

In our approach we synthesized new steroidal amino alcohol having short linker at C-3 position of bile acids. For this synthesis C-3 oxiranes **50** and **51** were the key intermediates. These oxiranes were prepared from methyl esters **5** and **6** of bile acids (Scheme 2) by oxidation followed and regioselective epoxidation using dimethylsulfonium methylide to obtain oxiranes **50** and **51** (Scheme 9). Stereochemistry at C-3 was assigned by ¹H-NMR studies of oxiranes **50**, **51**, **54**, **55** and confirmed by single crystal X-ray of compound **58**.



Scheme 9: Reagents and conditions: (a) CrO₃, H₂SO₄, acetone, 0-10 °C, 10 min; (b) Trimethyl sulphoxonium iodide, NaH, DMSO-THF, rt, 2 h; (c) Ac₂O, DMAP, Et₃N, CH₂Cl₂, 25-28 °C, 24 h; (d) K₂CO₃, MeOH, 3 h; (e) Ag₂CO₃, toluene, reflux, 5 h.

Opening of oxiranes **58** and **59** with sodium azide (Scheme 10) gave azido alcohols which on further hydrogenation on Pd-C gave amino alcohols **62** and **63**. Ethylene diamine derivatives **66** and **67** were synthesized by opening of oxiranes with N1-(Boc)-1,2-diaminoethane followed by deprotection. These new molecules containing amino alcohols with a small linker at C-3 are under biological evaluation.

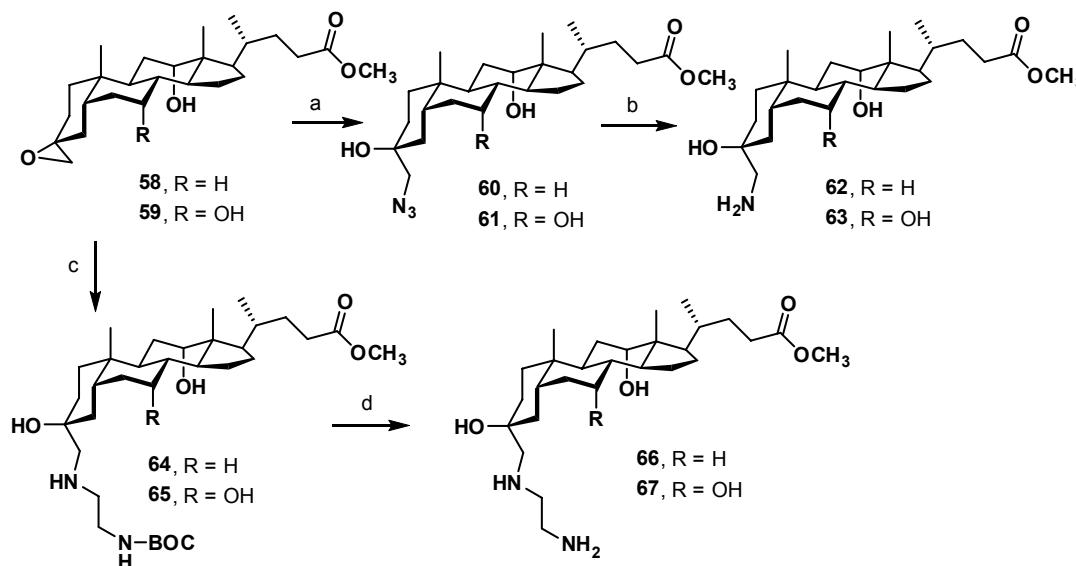

Scheme 10: Reagents and conditions: (a) NaN_3 , DMF, 60-65 °C, 12 h; (b) H_2 / Pd-C, MeOH; (c) N1-(Boc)-1,2-diaminoethane, MeOH reflux 2 h; (d) 50% TFA/ CH_2Cl_2 .

Chapter 3: Stereoselective synthesis of steroidal side chain from 16-dehydropregalone acetate

Introduction

Steroid is a large class of natural products and widely distributed in animals and plants. A wide variety of steroids are known having modified side chains and is attached to the tetracyclic rigid unit at C-17 with both natural C-20(R) and unnatural C-20(S) stereochemistry.¹⁴ The introduction of steroid side chain onto tetracyclic steroidal starting material to yield product with the natural C-20(R) configuration has been the subject of investigation by several research groups.¹⁵ There are several reports for the stereoselective side chain synthesis at C-20 using ene reaction, catalytic hydrogenation, deoxygenation, Wittig rearrangement, aldol condensation, Michel addition, sigmatropic rearrangement and also using organometallic reagents such as organocopper, organoborane, organopalladium, organozirconium, organoruthenium reagent. In this chapter we report a short stereoselective synthesis of cholanic acid derivative starting from commercially available C-20 oxo steroid 16-dehydropregalone acetate (16-DPA) **68** (Scheme 11). Palladium catalyzed carbon-

carbon bond forming Heck reaction between C-20 vinyl iodide **70** with methyl acrylate to form unsaturated compound **71** and transfer hydrogenation with triethylsilane and Pd/C are the key steps for stereoselective side chain synthesis.

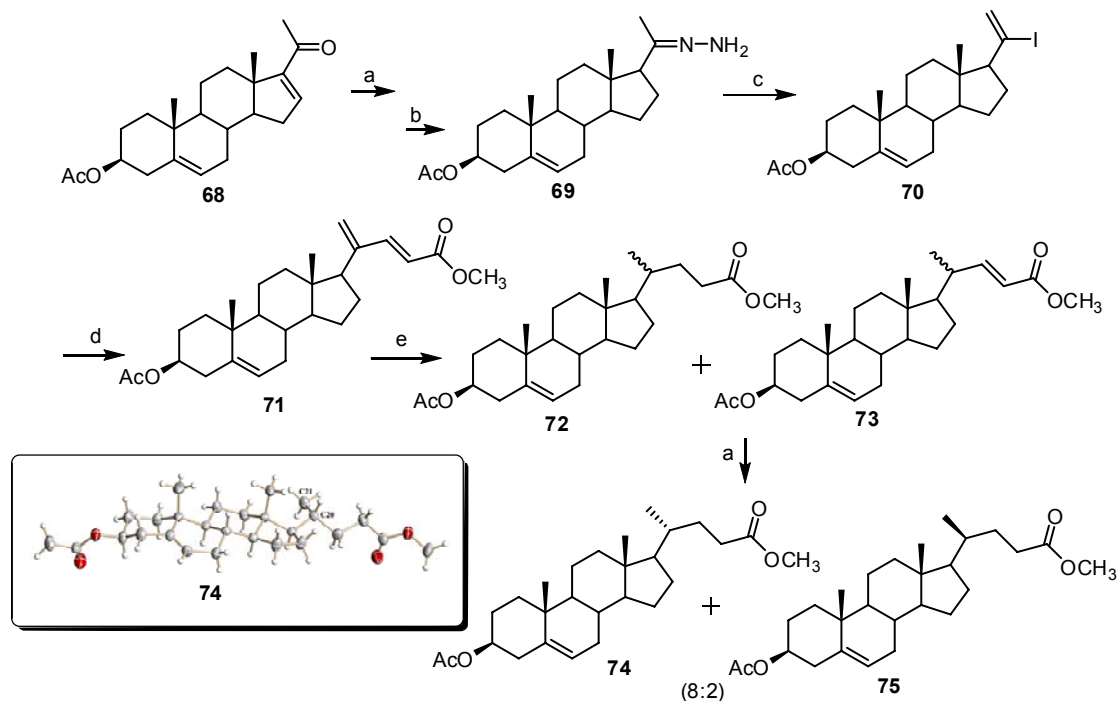

Scheme 11: Reagent and condition: (a) 10% Pd/C, H₂, EtOAc, 45 psi, 25-30 °C, 12 h, 98%; (b) Hydrazine hydrate, NEt₃, MeOH, 25-30 °C; (c) I₂, NEt₃, THF, 25-30 °C; (d) Pd(OAc)₂ (0.04%), K₂CO₃, methyl acrylate, DMF, 25-30 °C, 12 h; (e) 10-20% Pd-C (by weight), MeOH, triethylsilane (excess), 10-20 min.

Chemoselective catalytic hydrogenation of compound **68** with 10% Pd-C in ethyl acetate followed by reaction with hydrazine hydrate afforded C-20 hydrazone **69**. Oxidation of hydrazone **69** with iodine in the presence of organic base gave vinyl iodide **70** in good yield. Heck coupling of vinyl iodide **70** with methyl acrylate, afforded unsaturated carbonyl compound **71**. There are some reports for the reduction of C-20(21) or C-20(22) double bond by using different catalysts such as PtO₂, (Ph₃P)₃ RhCl with less selectivity at C-20. Pd-Carbon induced catalytic transfer hydrogenation with triethylsilane of compound **71** afforded compounds **72** and **73** as an epimeric mixture at C-20. Hydrogenation of this mixture using H₂/Pd-C in ethylacetate gave a mixture of compounds **74** and **75** in 8:2 ratio. On crystallization in methanol:dichloromethane (9:1) gave pure cholanolic acid derivative **74**. The stereochemistry of compound **74** at C-20(R) was confirmed by single crystal X-ray. Cholanolic acid is a key intermediate for the synthesis of large number of biologically active steroids having natural C-20(R) configuration.

References:

1. Virtanen, E.; Kolehmainen, E. *Eur. J. Org. Chem.* **2004**, 3385-3399.
2. Davis, A. P. *Coordination Chemistry Reviews* **2006**, *250*, 2939-2951
3. Rostovtsev, V. V.; Green, L. G.; Fokin, V. V.; Sharpless, K. B. *Angew. Chem. Int. Ed.* **2002**, *41*, 2596-2599.
4. Aher, N. G.; Pore, V. S. *Synlett* **2005**, 2155–2158
5. Aher, N. G.; Pore, V. S.; and Patil, S. P. *Tetrahedron* **2007**, *63*, 12927-12934
6. Ghosh, S.; Maitra, U. *Org. Lett.* **2006**, *8*, 399-402.
7. Kolehmainen, E.; Tamminen, J. *Molecules* **2001**, *6*, 21-46
8. Asai, K.; Tsuchimori, N.; Okonogi, K.; Perfect, J. R.; Gotoh, O.; Yoshida, Y. *Antimicrob. Agents Chemother.* **1999**, *43*, 1163-1169.
9. Gao, P. -H.; Cao, Y. -B.; Xu, Z.; Zhang, J. -D.; Zhang, W. -N.; Wang, Y.; Gu, J.; Cao, Y. -Y.; Li, R.; Jia, X. -M.; Jiang, Y. -Y. *Biol. Pharm. Bull.* **2005**, *28*, 1414-1417. and references cited therein.
10. Savage, P. B. *Exp. Opin. Invest. Drugs.* **2000**, *9*, 263-271.
11. Pore, V. S.; Aher, N. G.; Kumar, M.; Shukla, P. K. *Tetrahedron* **2006**, *62*, 11178-11186;
12. Salunke, D. B.; Hazra, B. G.; Pore, V. S. *Curr. Med. Chem.* **2006**, *13*, 813-847.
13. Brunel, J. M.; Letourneux, Y. *Eur. J. Org. Chem.* **2003**, 3897-3907.
14. Piatak, d. M.; Wicha, J. *Chem. Rev.* **1978**, *78*, 199-224.
15. Redpath, J.; Zeelan, F. J. *Chem Soc. Rev.* **1983**, *12*, 75-98.

Chapter 1

Synthesis of bile acid based dimers, oligomers to study their micelle like properties and studies towards the synthesis of cholaphane.

1.1 Abstract

New steroidal dimers and oligomers with varying numbers of bile acid units were synthesized with 1,2,3-triazole as linker *via* ‘click chemistry’ in very good yields. All these dimers **59-64** and oligomers **80** and **81** exhibited reverse micellar characteristics and were able to solubilize hydrophilic dye-cresol red, in nonpolar solvent. Cholic acid based molecules were able to encapsulate greater amounts of hydrophilic dye than deoxycholate based molecules. Dimeric compounds were also able to encapsulate hydrophilic dye which may be due to the formation of the *cis*-conformation in the presence of guest molecule. There may be additional hydrogen bonding due to the 1,2,3-triazole ring.

1.2 Introduction

Synthesis of rationally designed frameworks has attracted many organic chemists due to their theoretical or practical applications. Such compounds are able to recognize and bind other molecules, catalyze transformations, reproduce themselves or otherwise store and process information at the molecular level.¹ In recent years, bile acids and their derivatives have been used extensively in number of fields, such as pharmacology, biomimetic, supramolecular chemistry, and in nanotechnology.

1.3 Review of literature

During last decade number of reviews on bile acids and other steroidal compounds as architectural components in diverse areas of chemistry are available in the literature.¹⁻¹⁸ These include supramolecular host-guest systems, molecular and ionic receptors, chiral dendritic species, artificial light harvesting systems, foldamers/protein mimics, low mass organo/hydrogelators, templates/chiral auxiliaries for asymmetric synthesis, drug transport systems etc. A brief introduction on role of bile acids, their dimers, oligomers and cholaphanes in constructing molecular, supramolecular assemblies and metabolism of bile acids is presented.

Biosynthesis of bile acids

Bile salts are biosynthesized from cholesterol in the liver and stored in the gall bladder. The human liver produces 600-800 mL of bile per day. After food intake and subsequent gall bladder emptying, bile is secreted into the small intestine, where the bile acids perform their essential function in the digestion and resorption of fat, fatty acids and lipid-soluble vitamins. These nutrients are insoluble in water which dispersed in micelles of bile acids and lipids. The bile acids recirculate to the liver *via* the portal vein, undergoing this enterohepatic circulation 6-15 times per day. Bile acids are synthesized from cholesterol in hepatocytes. This catabolic pathway represents the major metabolic fate of cholesterol (Figure 1). The most abundant primary bile salts in humans are cholate, chenodeoxycholate and deoxycholate, and they are normally conjugated with either glycine (75%) or taurine (25%). Conjugation increases the aqueous solubility of bile salts under physiological conditions. All primary bile acids appear to have three features in common: (i) they are the major end-products of cholesterol metabolism, (ii) they are secreted into the bile largely in a conjugated form, and (iii) these conjugates are

membrane-impermeable, water-soluble, amphiphilic molecules having a powerful ability to transform lamellar arrays of lipids into mixed micelles.^{19,20}

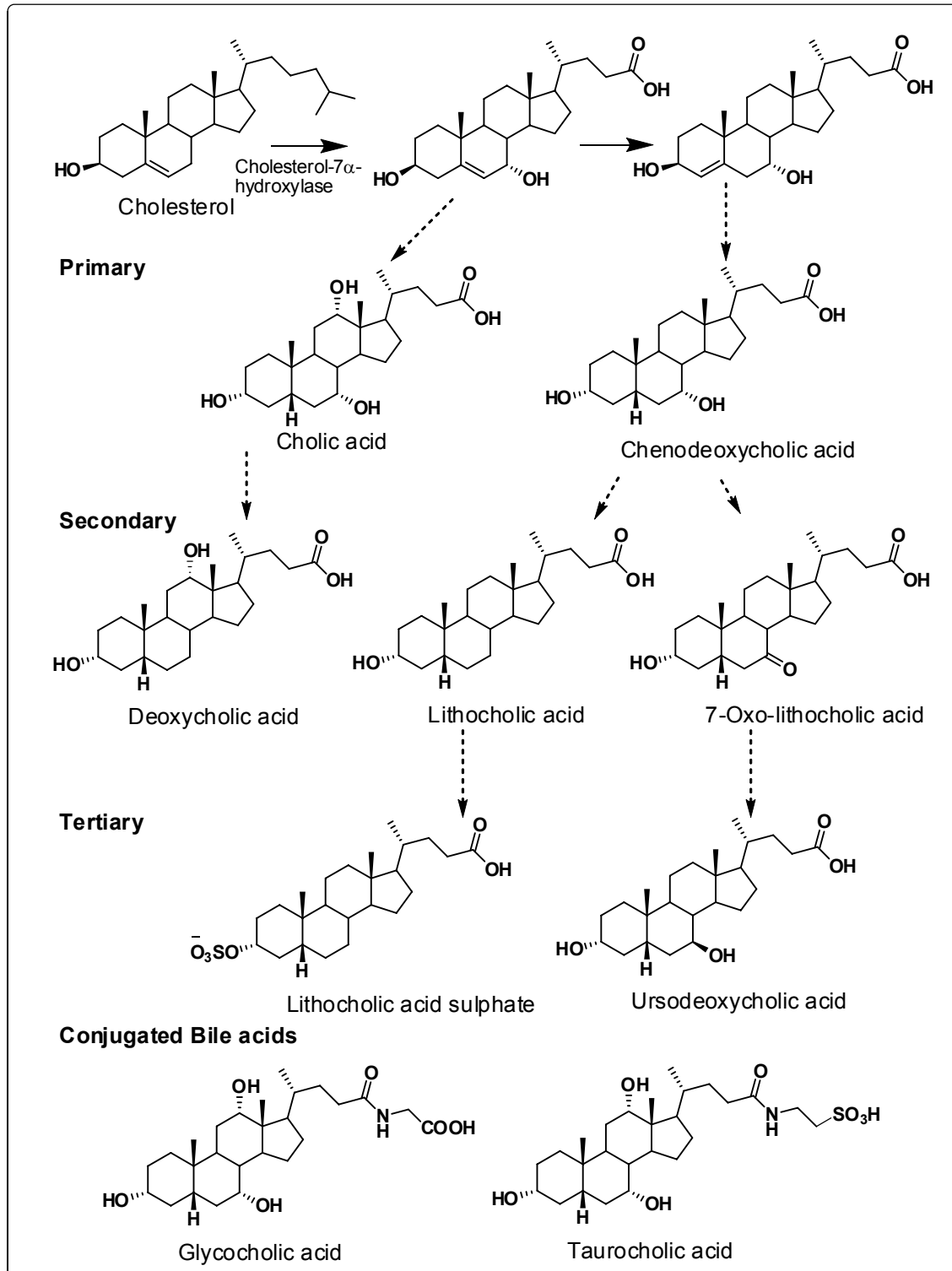

Figure 1: Bile acid metabolism-production of primary, secondary and tertiary bile acids occurs in the liver and by intestinal bacteria. Structures of conjugated bile acids: glycocholic acid and taurocholic acid.

Chemical structures of bile acids

All bile acids consist of two connecting units, a rigid steroid nucleus and a short aliphatic side chain (Figure 2).²⁰ The steroid nucleus of bile acids has the saturated tetracyclic hydrocarbon perhydrocyclopentanophenanthrene, containing three six-member rings (A, B and C) and a five member ring D. In addition, there are angular methyl groups at positions C-18 and C-19. The bile acid nucleus in higher vertebrates is curved (beaked) because rings A and B are *cis* fused. Some bile acids in lower vertebrates, known as *allo*-bile acids, are flat because of an *A/B trans*-fusion (5α -stereochemistry). The most abundant mammalian bile acids are hydroxy derivatives of cholanoic acid (5β -cholan-24-oic acid), (Figure 2, compound **1**).¹⁹

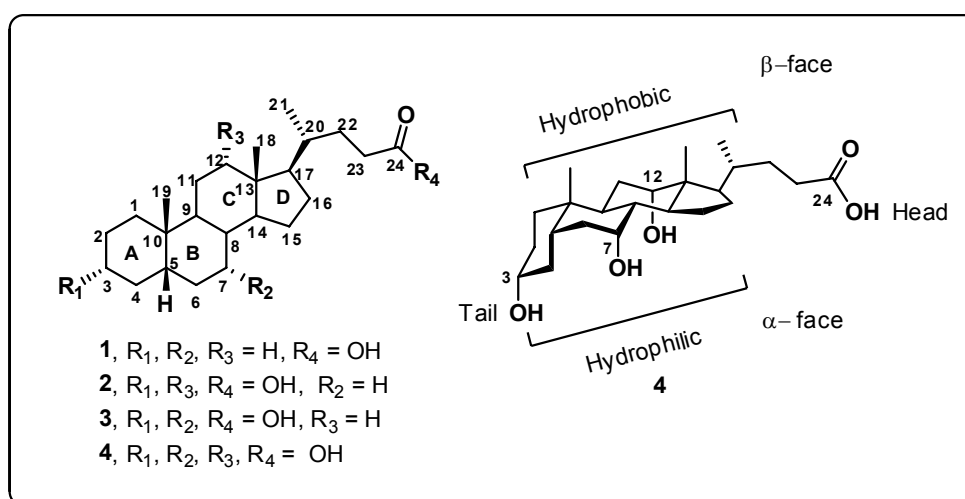

Figure 2: Chemical structures of different Bile acids.

The human bile acid pool consists mainly (~90%) of cholic acid, **4** ($3\alpha,7\alpha,12\alpha$ -trihydroxy- 5β -cholan-24-oic acid), chenodeoxycholic acid, **3** ($3\alpha,7\alpha$ -dihydroxy- 5β -cholan-24-oic acid), and deoxycholic acid, **2** ($3\alpha,12\alpha$ -dihydroxy- 5β -cholan-24-oic acid). The bile acid nucleus possesses angular methyl groups at positions C-18 and C-19 on the convex hydrophobic β -face and the hydroxyl groups on the concave hydrophilic α -face which makes these compounds facially amphipathic.^{6,13}

Bile acid based molecular and supramolecular assemblies

Bile acids are a valuable architectural unit in supramolecular chemistry. These are useful in the synthesis of different types of compounds due to their large, rigid and curved steroidal skeletons, chemically different hydroxy groups, enantiomeric purities and their unique amphiphilicity, together with their availability and low cost. Davis, *et al.*

described how a single molecule of bile acid creates podand-type architecture (“cholapod” **5**) (Figure 3).

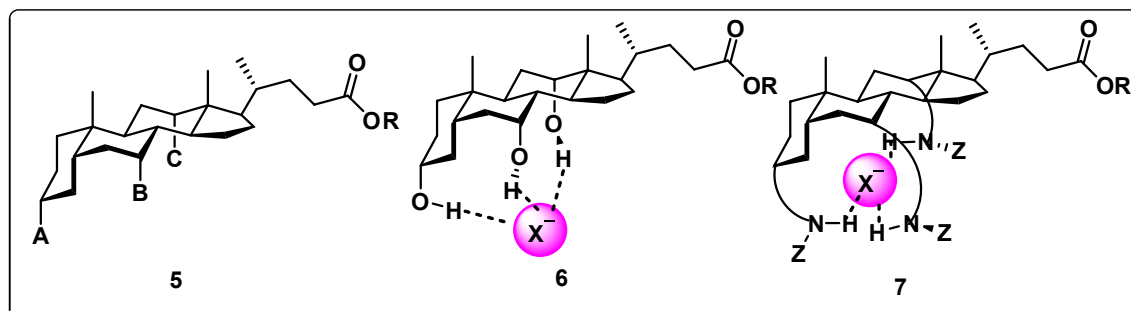

Figure 3: Anion binding by cholic acid derivatives. H-bond donor strength can be tuned (eg. OH changed to NHZ or NHCONHR) to generate more powerful receptor)

The binding site is formed by “legs” A-C (**5** in Figure 3), while the solubility can be controlled by ester group R. This type of work was earlier reported by Kahne,²¹ and by Still, who realized that receptors of this type could be varied combinatorially.²² Cholate esters of **2** can themselves act as weak anion receptors.²³ Davis *et al.* have contributed in anion recognition, by changing different A-C group and positions, where A-C contain H-bond donors (**6**, **7** in Figure 3), and also their donor strength (for example, by adjusting Z groups).^{11, 14}

Molecular tweezers are the molecules synthesized by two similar or dissimilar “sticky arms” separated by a rigid or a semi-rigid spacer. Maitra *et al.* have reported first bile acid based molecular tweezers such as **8**, as receptors for a number of electron deficient aromatic molecules (Figure 4).²⁴ Two aromatic groups attached to the hydroxyl group at C-3 and the C-12, thus, act as the arms of the tweezers. The complexation with aromatic nitro compounds was monitored by using NMR titration experiments. They have also reported a bile acid based adenine and biotin receptors.²⁵

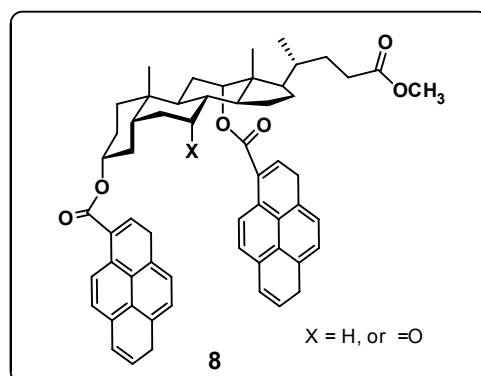

Figure 4: Bile acid based molecular tweezers.

Irie *et al.* designed and synthesized carbamoyloxa-bridged regioisomeric cyclophanes using dimethyl $\alpha,\alpha,\alpha',\alpha'$ -tetramethyl-*m*-xylene dicarbamate.²⁶ The double *trans*-esterification of methyl cholate resulted in the formation of both the regioisomeric cyclophanes **9** and **10** (Figure 5). Pandey, *et al.* have also reported cyclic and acyclic bisimidazolium, bisbenzimidazolium receptors derived from deoxycholic acid for binding of fluoride and chloride anions.²⁷

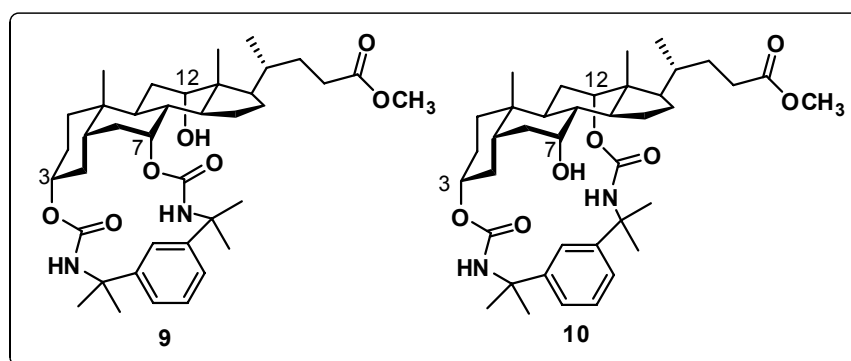

Figure 5: Bile acid based cyclophane.

An asymmetric transformation is a challenging area in organic chemistry. Use of the chiral auxiliary to introduce chirality in the substrate is most common. Bile acids were also found as an excellent chiral template in asymmetric synthesis.²⁸ Maitra *et al.* have employed new bile acid based molecular scaffold, a suitably placed aromatic group at C-7 position, thereby introducing a new element of steric control and an additional restriction to the transition state of various reactions like Diels-Alder reaction,^{29a} synthesis of α -hydroxy carboxylic acids,^{29b} diastereoselective synthesis of 1,1'-binaphthyl-2,2'-diol,^{29c,29d} and asymmetric epoxidation reactions with oxone.³⁰

Organogels find applications in a wide variety of areas, including medicine, pharmacology, cosmetics, hardeners of spilled toxic solvents and environmental clean-up. Miyata *et al.* reported that cholic acid and its derivatives, such as *N*-isopropylcholamide was able to form gels in aromatic solvents in the presence of methanol.³¹ Maitra *et al.* reported³² the ability of some bile acids, substituted with aromatic donors at the C-3 position, to gelate certain organic solvents (primarily alcohols) in the presence of trinitrofluorenone as an acceptor. The electron donor-acceptor interaction was established as a requirement for the gelation process. They also reported first bile acid-based cationic surfactant-gelators.³³ This study revealed that the presence of a hydrophilic functionality on the side chain of deoxycholic acid may result in thickening of aqueous liquids, and that

the number of hydroxy groups on the bile acid backbone, as well as the presence of the amide linkage, may play an important role in gelation. Kolehmainen *et al.* reported that 2-hydroxyethylamides of lithocholic **11** and deoxycholic acids **12** (Figure 6) are effective gelators in chlorinated organic solvents, whereas the corresponding 3-hydroxypropylamides form gels in aromatic solvents.³⁴ They also reported the synthesis of a novel bile acid-aminoacid conjugate, *N*-deoxycholyl-L-tryptophan.³⁵

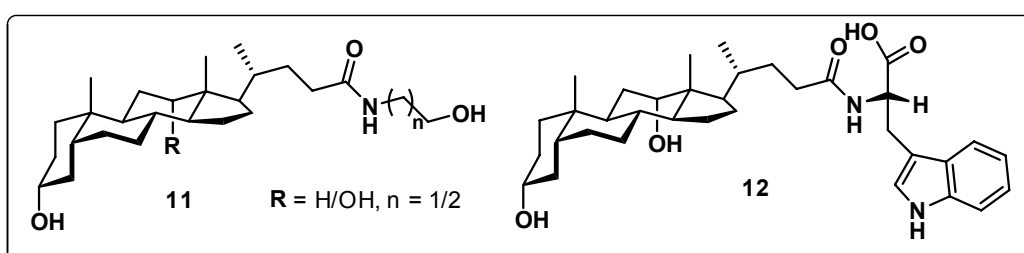

Figure 6: Bile acid based organogelators.

Savage *et al.*³⁶ described the synthesis of anionic facial amphiphiles derived from cholic acid. They utilized these molecules for solubilisation of hydrophobic molecules, permeabilisation of membranes and as structural components in supramolecular frameworks.

Miyata *et al.* studied the inclusion complexation of bile acids and their derivatives.³⁷ They prepared bile acid-based multinuclear inclusion compounds with a variety of organic substances. The channels in the crystal structures of some of these inclusion compounds can perform as efficient chiral recognition of some substrates, such as lactones.^{37b} Gdaniec *et al.* also investigated bile acid-based inclusion complexes and found optical activity in formally achiral guest molecules, aromatic ketones, included in the crystal lattice of bile acids.³⁸ They also reported enantioselective inclusion complexation of *N*-nitrosopiperidines by bile acids.³⁹

Bile acid based dimers, cholaphanes and oligomers

Two bile acid units linked through spacer group are called as dimers. Such molecules show versatile applications in supramolecular as well as pharmacological fields. Head-to-head, head-to-tail, and tail-to-tail dimers of bile acids have been reported⁴ in the literature. Burrows and Sauter reported synthesis and conformational studies of a new host system **13** (Figure 7) incorporating two molecules of cholic acid linked by a rigid diamine. Proton NMR studies indicated that the compounds exist in a rigid conformation with the steroid hydroxyl groups intramolecularly hydrogen bonded. Heat

or addition of methanol leads to conformational isomerism due to insertion of methanol into the cavity.⁴⁰ Later, they reported an unusual example of binding of a carbohydrate derivative (amyl glucoside) to a synthetic molecular receptor (compound **14**)⁴¹ and DNA binding of steroidal tetramine dimer **15**.⁴²

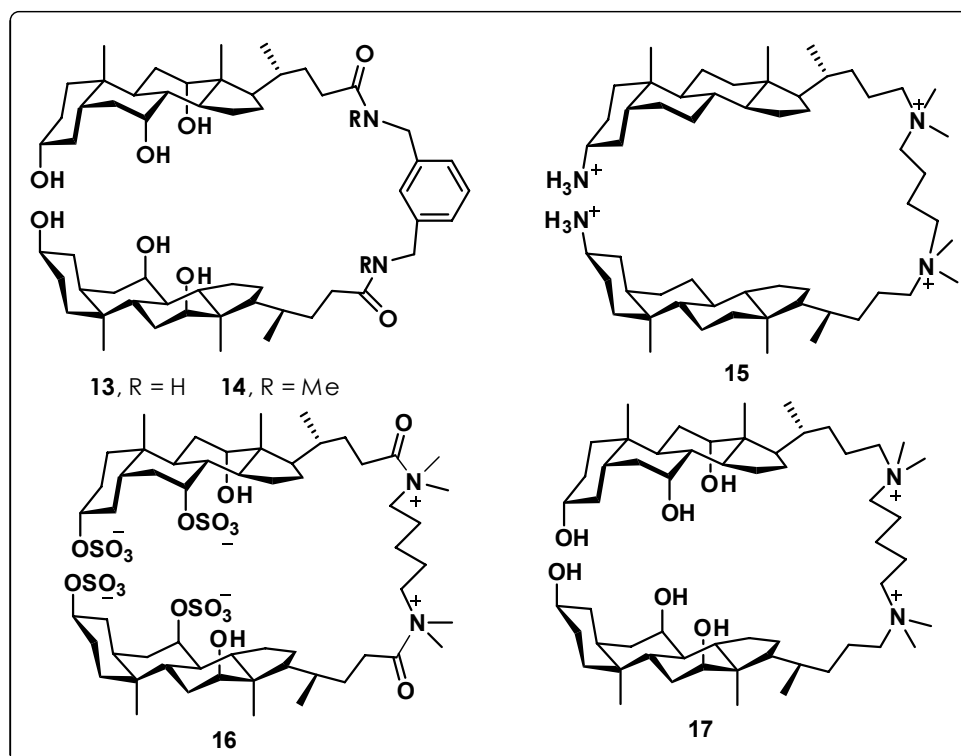

Figure 7: Structure of some bile acid dimers

McKenna *et al.* synthesized head-to-head dimers **16** and **17** (Figure 7) of cholic acid with a linker at C-24. This type of dimers were found to solubilise perylene in aqueous solution without micelle formation.⁴³

Bile acid based dimers and oligomers have potential applications in the area of drug design and delivery. Janout and co-workers⁴⁴ synthesized compound **18** (Figure 8). This type of molecular umbrella can cover an attached agent and shield it from an incompatible environment. Regen and co-workers synthesized⁴⁵ persulfated molecular umbrellas **19** as anti-HIV and anti-HSV agents on the basis of the facts that, (i) a di-walled molecular umbrella, bearing three sulfate groups on each of two cholyl moieties, is capable of crossing phospholipid bilayers and (ii) anionic polymers such as dextran/dextrin sulfate and cellulose sulfate are known to inhibit cellular binding of HIV and HSV by competing for viral envelope glycoproteins. Based on the similar concepts, chlorambucil, aromatic nitrogen mustard, has been conjugated to putrescine and

spermidine based scaffolds bearing one, two and four persulfated cholic acid units. Conjugate **20** bearing two sterols show improved hydrolytic stability and water solubility relative to chlorambucil. Synthesis of a series of molecular umbrella conjugates, derived from cholic acid, deoxycholic acid, spermidine, lysine, and 5-mercapto-2-nitrobenzoic acid have been reported which are capable of transporting an attached 16-mer oligonucleotide (S-dT16) across liposomal membranes.⁴⁶

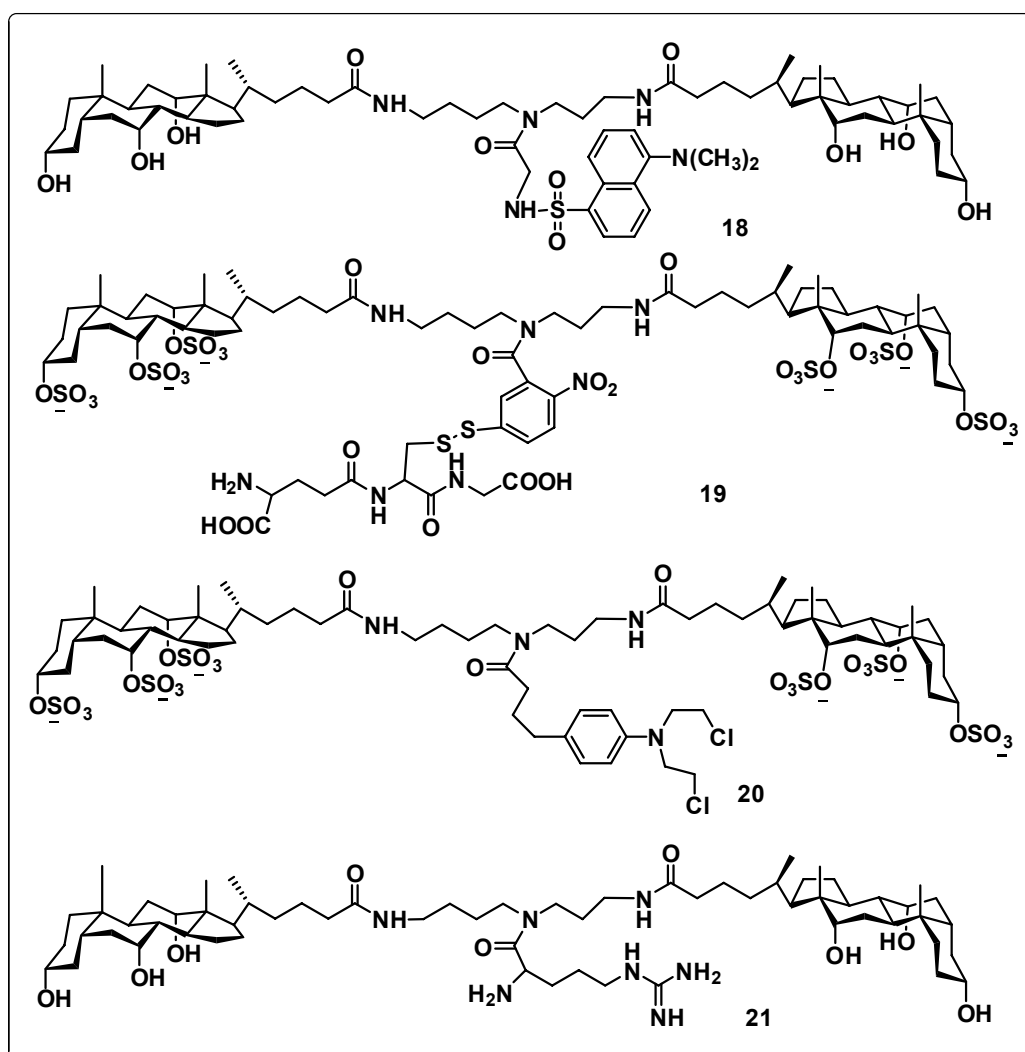

Figure 8: Structures of molecular umbrellas capable for transporting drugs across phospholipid bilayers.

Kobuke *et al.* synthesized bile acid based transmembrane ion channels **22** and **23** (Figure 9) by linking two units of amphiphilic cholic acid dimethyl ether by biscarbamate.⁴⁷ Compounds **22** and **23** showed stable single ion channel currents with the voltage-dependent property. They also synthesized artificial ion channels **24** and **25**⁴⁸ cholic acid derivatives connected through a *m*-xylylene dicarbamate unit at 3-hydroxyl groups. Asymmetries were introduced by terminal hydrophilic groups, carboxylic acid

and phosphoric acid for **24** and hydroxyl and carboxylic acid for **25**. They found that these head groups dissociate easily under basic conditions. Compounds **24** and **25** are the first stable single ion channels having a rectification property except peptidic channels. Recently Kobuke *et al.* also synthesized bischolic acid derivatives **25a** and **25b** and examined their single ion channel properties.⁴⁹

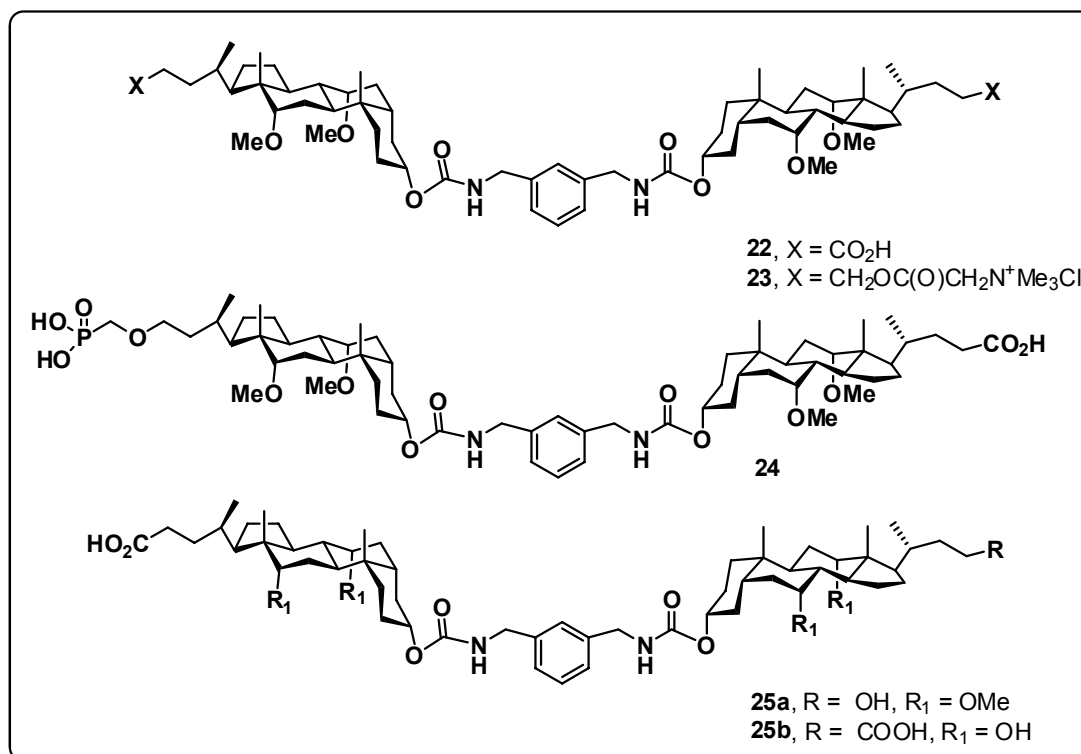

Figure 9: Transmembrane bis (cholic acid) channels **22-25**.

Bile acid dimers also act as artificial ionophores and are found to be potential receptors for neutral molecules or metal cations.⁵⁰ There are several reports⁵¹⁻⁵³ on the synthesis of bile acid dimers and their conversion to cyclophanes. Syntheses of cleft-type bile acid derivatives⁵⁴ have been reported in the literature. Dimers at other positions than C-3 and C-24, also have been rarely reported.⁵⁵

There is a report⁵⁶ from our group on synthesis of bile acid based novel topology for a series of steroidal dimers e.g. **26** with different linkers (Figure 10). The results suggested that the compound **26** has a potential as antifungal agent. We have reported synthesis of bile acid dimers and oligomers linked through 1,2,3-triazole and their micellar properties were investigated through hydrophilic dye solubilisation studies in non polar media.^{57,58} Synthesis of bile acid dimer linked through 1,2,3-triazole and bis-β-

lactam **27 (a-d)** has been recently reported from our group⁵⁹ which exhibited significant antifungal as well as antibacterial activity.

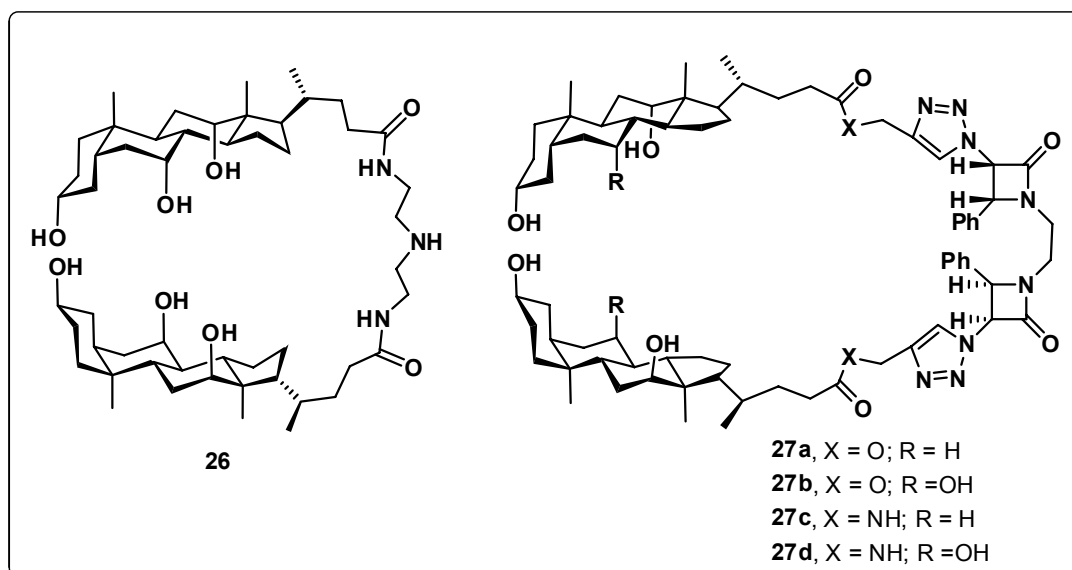

Figure 10: Bile acid dimers linked through diethylenetriamine **26** and bile acid bis- β -lactam conjugates **27(a-d)** showed antifungal, antiproliferative and antibacterial activity.

Soon after our report⁵⁸ Zhang *et al.* reported six new 1,2,3-triazole-containing bile acid dimers via click chemistry and studied their micellar properties through hydrophilic dye solubilisation studies in non polar media.⁶⁰

Bile acid based cholaphanes and oligomers

Cholaphanes are bile acid-derived macrocycles consisting of two to four bile acid units attached with different spacer molecules forming a cyclic structure. The cholaphanes can be arranged either head-to-tail **28** or head-to-head **29** (Figure 11). Bonar-Law and Davis *et al.* investigated the carbohydrate-binding properties of cholaphanes by their NMR and molecular modelling characterization.⁶¹⁻⁶⁴ Davis *et al.* continued the studies of cholaphanes by preparing some cyclocholamides⁶⁵⁻⁶⁷ as well as by reducing the conformational freedom and improving the solubility of the compounds by creating a new class of cholaphanes with externally directed alkyl chains and truncated side chains.⁶⁸ Albert and Feigel prepared steroidal cyclopeptides.⁶⁹⁻⁷¹ There are several reports on the synthesis of cholaphanes and their binding properties.⁷²⁻⁹¹

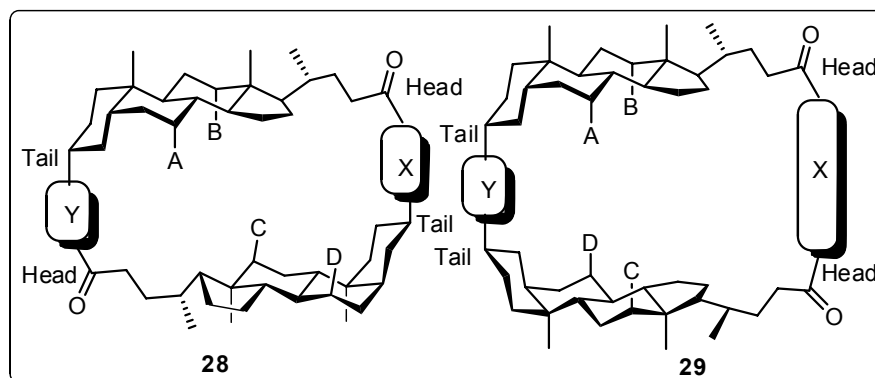

Figure 11: The structures of head-to-tail **28** and head-to-head or tail-to-tail **29** cholaphanes (A-D = binding/catalytic functionality, X, Y-spacer).

The configuration of dendritic structures and steroidal moieties in the same molecule gives rise to potential molecular assemblies with many interesting nano-scale applications, including organ-targeted drug carriers, artificial ion channels, molecular switches, hydrogel formation and in artificial light harvesting systems etc. Kohmoto *et al.* reported the first synthesis of the steroidal triply-bridged cyclophanes **30** (Figure 12) using cholic acid derivatives as bridge units.⁹²

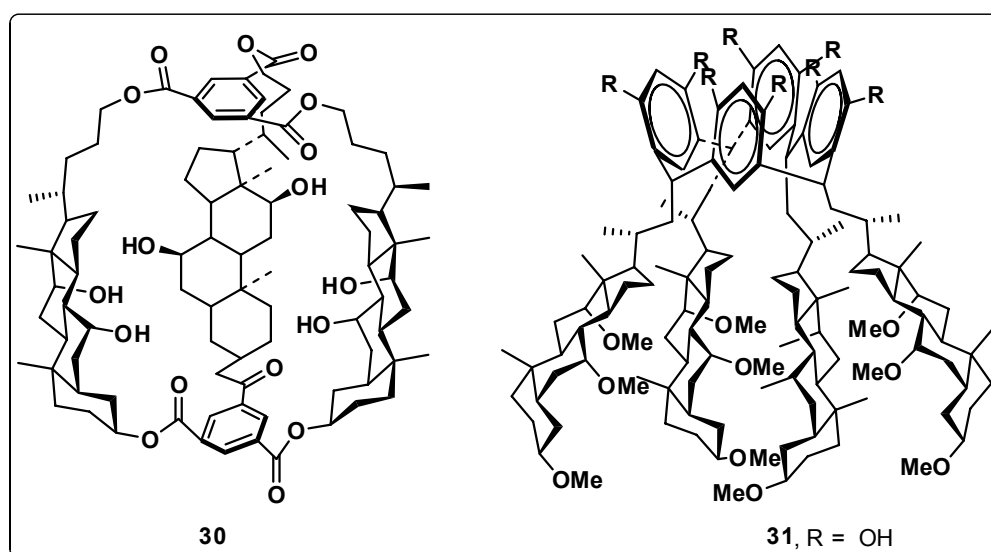

Figure 12: Structure of steroidal triply-bridged cyclophane **30** and structure of an artificial ion channel **31** containing bile acid moieties

This flexible macrocyclic hexaol binds to several organic guest molecules, such as nitrophenols, glycopyranosides, and alanines. Kikuchi and Murakami synthesized artificial cell-surface receptors bearing four bile acid moieties covalently placed on a tetra-azaparcyclophane skeleton which bind effectively to several naphthalene derivatives in both bilayer membranes and aqueous solutions.⁹³ Maitra *et al.* reported first

bile acid-based chiral dendrons⁹⁴ by using acetoxy-functionalized cholic acid and deoxycholic acid as starting materials in the preparation of heptamer, nonamer, and decamer. In their recent review¹⁸ design, synthesis and various applications of dendritic bile acids has been discussed. Kobuke and co-workers introduced a novel artificial ion channel consisting of a macrocyclic resorcin [4] arene and four amphiphilic cholic acid-derived moieties **31** (Figure 12).⁹⁵ In a bilayer membrane these molecules formed a tail-to-tail coupled pair to afford a transmembrane channel with a long-lasting open state.

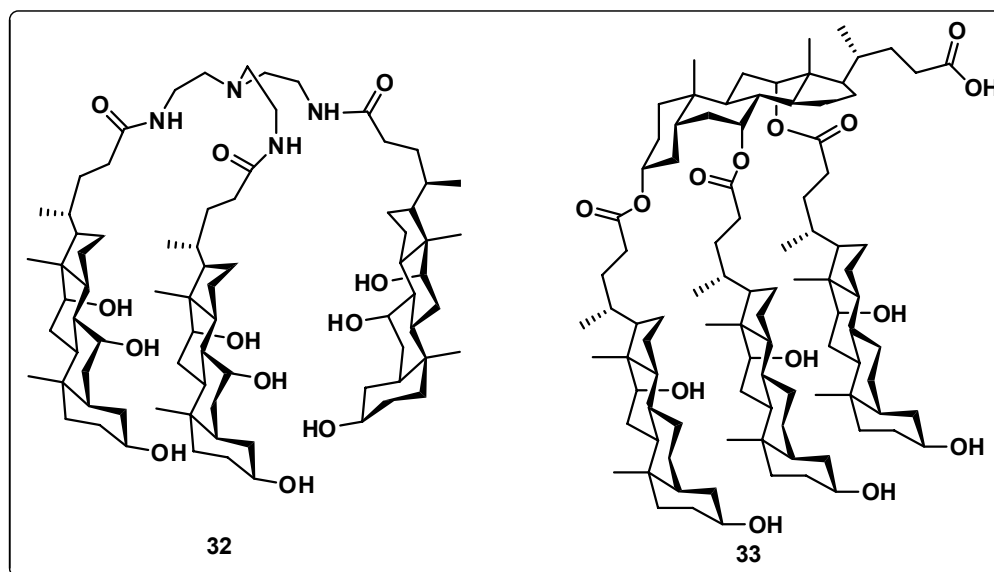

Figure 13: The structure of the tripodal cholic acid derivative **32** with organogelator properties and Bile acid based tetramer **33**.

Bonar-Law and Sanders⁹⁶ reported a bile acid-based ionophore having a MEM-protected cholaphane, which was found to bind alkali metal ions. Later on they reported a range of porphyrin-conjugated cyclocholates⁹⁷ and porphyrin bowls.⁹⁸ Maitra *et al.* reported the ability of a novel tripodal cholic acid derivative **32** (Figure 13) to form gels in aqueous media and the gelation process creates highly hydrophobic pockets⁹⁹ with potential to be utilized for selective chemical transformations. They investigated the rotational dynamics of polarity-sensitive fluorescent dyes in a gel derived from the tripodal cholic acid derivative.¹⁰⁰ Recently, Kolehmainen, *et al.* synthesized bile acid-based dendrons from 2,2-bis(hydroxymethyl) propionic acid (bis-MPA) and lithocholic acid by a convergent method.¹⁰¹ These molecules acts as potential drug carriers. Bile acid oligomer **33** (Figure 13) exhibited reverse micellar characteristics in an organic solvent and were able to encapsulate hydrophobic and hydrophilic dyes.¹⁰²

1.4 Present Work

1.4.1 Objective

As can be seen from the above discussion, there are several reports on synthesis of bile acid dimers, cholaphanes, and oligomers using various linkers. These molecules have vast applications in various fields of chemistry and medicine. This chapter deals with synthesis of bile acid-based dimers at C-3 α , C-3 β , C-11 and C-24 positions of bile acids and novel trimer and tetramer having 1,2,3-triazole ring. These molecules were studied for their micellar properties using hydrophilic dye, Cresol Red (CR). Click reaction (1,3-dipolar cycloaddition reaction of organic azide to terminal acetylene) is the key reaction used for the synthesis of these 1,2,3-triazole containing molecules. A brief account of Click Chemistry is given in the following section.

Click chemistry:

The 1,3-dipolar cycloaddition reaction (1,3-DCR) of a 1,3-dipole to a dipolarophile (i.e. an acetylene or alkene) for the synthesis of five membered heterocycles are well known transformations in synthetic organic chemistry.¹⁰³ This reaction gives rise to two regioisomers namely 1,4 and 1,5-disubstituted 1,2,3-triazole products in 1:1 ratio. Recently, Sharpless^{104a} and Meldal^{104b} groups have reported the dramatic rate enhancement (up to 10^7 times) and improved regioselectivity of the Huisgen 1,3-DCR of an organic azide to terminal acetylene to afford, regioselectively, the 1,4-disubstituted, 1,2,3-triazole in the presence of Cu(I) catalyst (Scheme 1). The Cu (I)-catalyzed 1,3 DCR has successfully fulfilled the requirement of “click chemistry” as prescribed by Sharpless and within the past few years has become a premier component of synthetic organic chemistry.¹⁰⁵

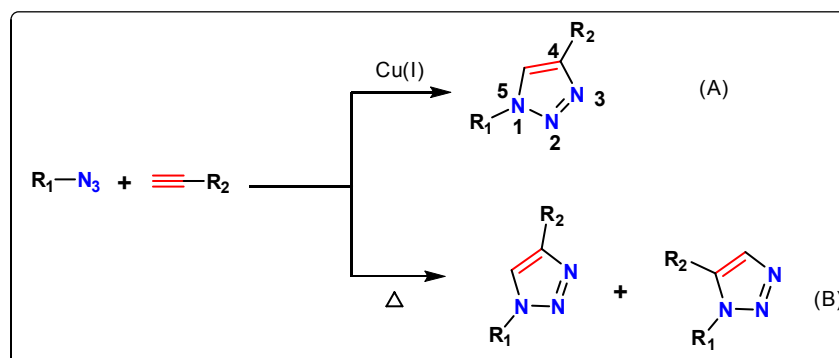

Scheme 1: 1,3-dipolar cycloaddition between organic azides and terminal alkynes

The classical non-catalyzed process proceeds by concerted mechanism under thermal conditions to afford a mixture 1,4- and 1,5-disubstituted, 1,2,3-triazole regioisomers. The relative proportion of regioisomers and rate can be predicted from electronic and steric effects.¹⁰⁶

The Cu(I)-catalysed (“click”) process has been postulated to occur by a step wise mechanism on the basis of recent thermal and kinetic studies.¹⁰⁶ Substantial rate increase of the Cu(I)-catalysed process in the aqueous solvents is rationalized in terms of stepwise process which lowers the activation barrier relative to that of the non-catalysed process by as much as 11.8 kcal/mol.^{109a,112} The proposed catalytic cycle involves several postulated and transient Cu(I)-acetylide complexes, starting with complexation of the alkyne to the Cu(I) metal centre to form a Cu(I)-alkyn π -complex (A) (Scheme 2).¹⁰⁷

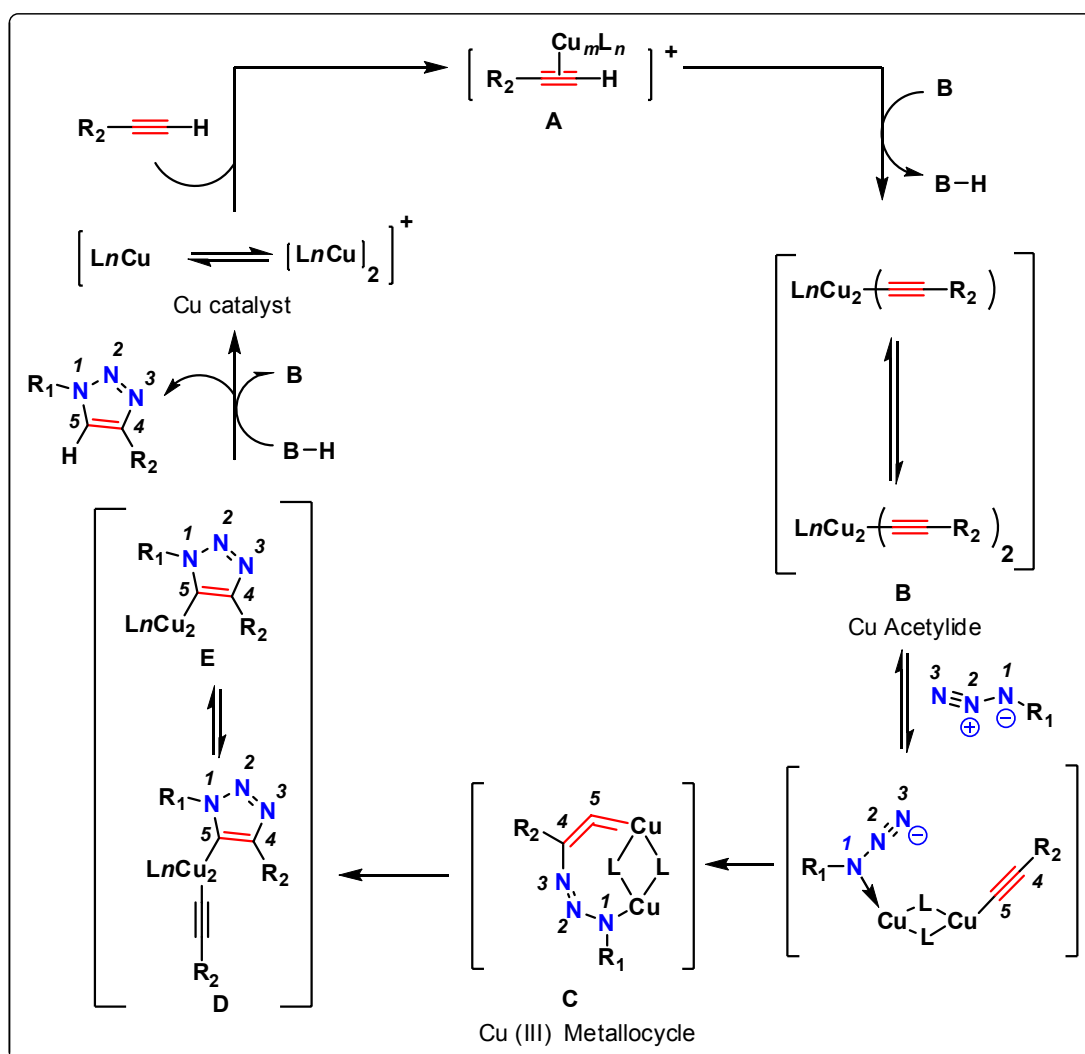

Scheme 2: Outline of plausible mechanisms for the Cu(I) catalyzed reaction between organic azides and terminal alkynes.

The enhanced reaction rate in water relative to organic solvents can be rationalized in terms of the endothermic ligand dissociation in organic media, for example acetonitrile (endothermic by $0.9 \text{ kcal mol}^{-1}$) relative to water (exothermic by $11.8 \text{ kcal mol}^{-1}$).¹⁰⁷ The formation of the Cu(I) acetylide complexes is also water-assisted, since water lowers the pK_a of the acetylene C-H by 9.8 pK_a units.¹¹² Formation of the Cu(I)-acetylide species allows for subsequent ligand displacement with azide and results in a dimeric copper species (**B**). Complexation with azide activates it towards nucleophilic attack at the N-3 with the acetylide C-4 (The numbering is given according to triazole nomenclature). The resulting metallocycle (**C**) undergoes facile ring contraction *via* transannular association of the N-1 lone pair with the C5-Cu π^* orbital to give the copper-triazole complex (**D**). Protonation of the triazole species, possibly with water and disassociation of the labile copper complex affords the 1,4-disubstituted 1,2,3-triazole (**E**), thus, regenerating the catalyst and ending the cycle.

Within a short time-frame, click chemistry has proven to be of remarkable utility and broad scope, not only in organic synthesis, but in chemical biology and drug discovery.¹⁰⁸ Azides and acetylenes are by definition kinetically stable entities possessing high built-in energy and are tolerant to a wide range of synthetic conditions.¹⁰⁶ Click chemistry is highly modular and simplifies difficult syntheses, thus, enabling a more cost-effective and efficient surveillance of structural space. The biocompatibility of the reaction, tolerance towards a broad range of pH and relative inertness of acetylenes and azides within highly functionalized biological milieus has allowed click chemistry to become a viable bioconjugation strategy for labeling biomolecules and for *in situ* lead discovery applications.¹⁰⁹ The 1,2,3-triazole moiety is a potential pharmacophore owing to its moderate dipole character and rigidity and can therefore be readily incorporated into a design strategy, rather than used as passive linker between two respective fragments of structural space.¹¹⁰ Indeed several examples exist within the literature which describe the biological activity of 1,2,3-triazole, including anti HIV-1,¹¹¹ antibacterial,¹¹² herbicidal, fungicidal,¹¹³ antiallergic,¹¹⁴ selective β_3 adrenergic receptor inhibition,¹¹⁵ anti-platelet activity,¹¹⁶ and anti-inflammatory¹¹⁷ agent.

1.4.2 Results and Discussion

Synthesis of dimers

In our study, for the synthesis of dimers, we have utilized 1,2,3-triazole as a linker. We visualized ‘Click reaction’ of bile acid-based terminal alkyne and azides to get

dimers with this linker. Accordingly, we have carried out *para*-toluene sulfonic acid (*p*-TSA) catalyzed esterification of bile acids **2** or **4** with propargyl alcohol to give the corresponding propargyl esters **34** (95%) and **35** (96%) respectively (Scheme 3). The formation of propargyl esters **34** and **35** was confirmed by their spectroscopic data. IR spectrum of these compounds showed a characteristic acetylenic C-H absorption band at 3300 cm^{-1} . The $^1\text{H-NMR}$ spectrum of **34** and **35** showed a typical chemical shifts for acetylenic proton as triplet at δ 2.47 and methylene (OCH_2) as doublet at δ 4.68.

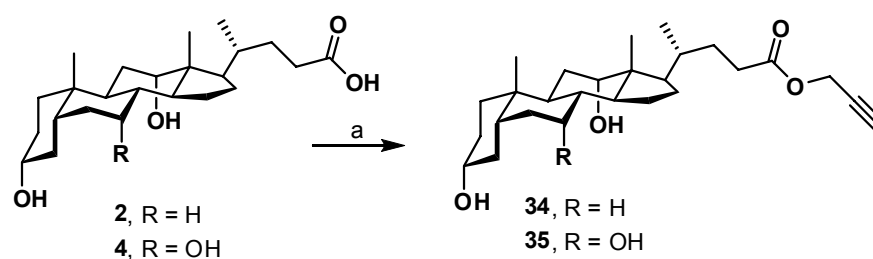

Scheme 3: Reagents and Conditions: (a) *p*-TSA (10 mol %), Propargyl alcohol (5-10 mL), 55-60 °C, 7 h, **34** (96%), **35** (95%).

For the synthesis of C-24 azides **44** and **45**, a synthetic route is depicted in Scheme 4. Accordingly, *p*-TSA catalyzed esterification of deoxycholic acid **2** was carried out with methanol to obtain methyl ester **36** in 95% yield.

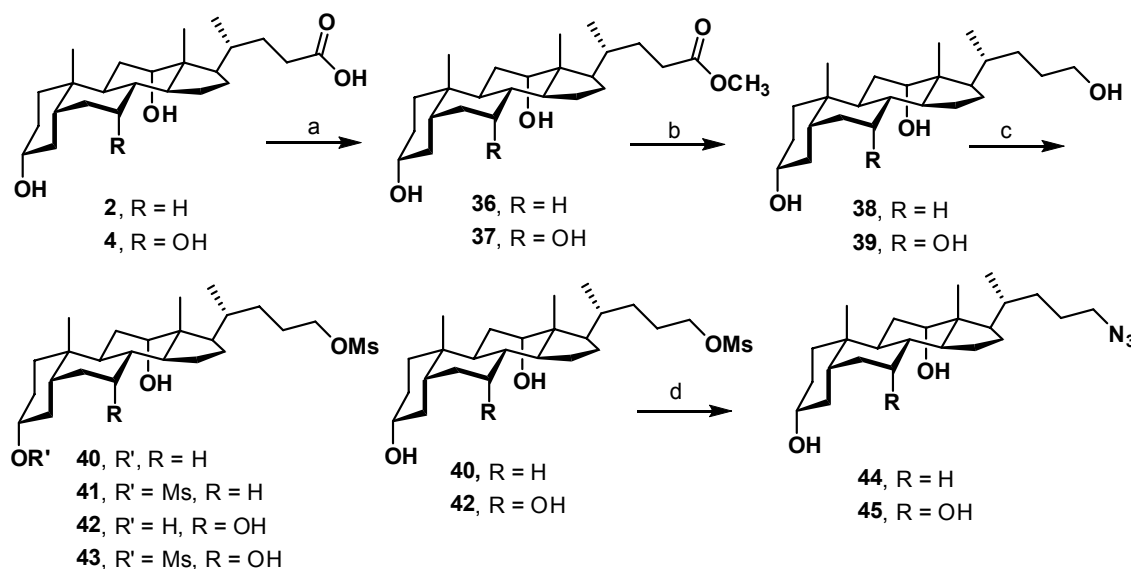

Scheme 4: Reagents and conditions: (a) *p*-TSA/MeOH, 25 °C, 24 h, 95-96%; (b) LAH/THF, 25 °C, 2 h, 93-97%; (c) (i) **38**, MsCl, Et₃N, CH₂Cl₂, 0 °C, 10 min; or (ii) **39**, MsCl, Pyridine, 0 °C, 10 min; d) NaN₃, DMF, 60 °C, 3 h, 93-94%.

Subsequently, reduction of ester moiety in **36** with LiAlH_4 was carried out to provide trihydroxy compound **38** in 93% yield. Under the identical reactions sequences, cholic acid **4** gave tetrahydroxy compound **39** in high yield (Scheme 4). Primary hydroxyl function in triol **38** was mesylated (Et_3N , CH_2Cl_2) to give C-24 monomesylate **40** and C-3, C-24 dimesylate **41** with poor regioselectivity. When reaction was carried out under high dilution and less reaction time, expected regioisomer **40** was formed as major isomer along with **41** (regioselectivity 7:3). These compounds were easily separated by column chromatography. The $^1\text{H-NMR}$ spectrum of **40** showed chemical shifts at δ 4.21 (t, $J = 6.66$ Hz, 2H) and 3.01 (s, 3H) corresponding to the C-24 methylene (CH_2OMs) and methyl (CH_3SO_2^-) protons respectively. However, tetrol **39** was monomesylated using pyridine as a solvent (less solubility of tetrol **39** in CH_2Cl_2) to give monomesylate **42** and dimesylate **43**. Further, monomesylates **40** and **42** were subjected to nucleophilic substitution of mesyl group with azide anion (NaN_3 in DMF) which gave the corresponding C-24 azides **44** (94%) and **45** (93%) respectively. Formation of azides **44** and **45** was confirmed by IR spectroscopy which showed a characteristic absorption band at 2100 cm^{-1} due to azido functionality. The $^1\text{H-NMR}$ spectrum of azides **44** and **45** showed chemical shifts at δ 3.24 (t, $J = 6.57$ Hz, 2H) corresponding to the C-24 methylene protons (CH_2N_3).

Synthesis of C-3 α and C-3 β azides

For the synthesis of 3 α -azides (**48-49**), mesylation of hydroxyl function in methyl esters **36** or **37** at C-3 position was carried out under Mitsunobu reaction condition¹¹⁸ using methane sulfonic acid (Ph_3P , Et_3N , DEAD, THF) to give the corresponding C-3 β mesylates **46** and **47** with inversion of configurations (Scheme 5). Subsequently, without purification mesylates **46** and **47** were subjected to nucleophilic substitution with azide anion (NaN_3 in DMF) to get azides **48** and **49** in 75-78% overall yields in two steps. The $^1\text{H-NMR}$ spectrum of azide **48** showed a chemical shifts at δ 3.33 (m) and azide **49** at δ 3.19 (m) corresponding to the C-3 β protons.

Mesylation of hydroxyl function in methyl esters **36** and **37** at C-3 position was carried out (MsCl , Et_3N , CH_2Cl_2) to give the corresponding C-3 α mesylates **50** and **51** and subsequent nucleophilic substitution with azide anion (NaN_3 in DMF) gave 3 β -azido compounds **52** and **53** in high yields (Scheme 5). The $^1\text{H-NMR}$ spectrum of azide **52**

showed a chemical shifts at δ 3.94 (bs) and azide **53** at δ 3.86-3.89 (bs) corresponding to the C-3 α protons.

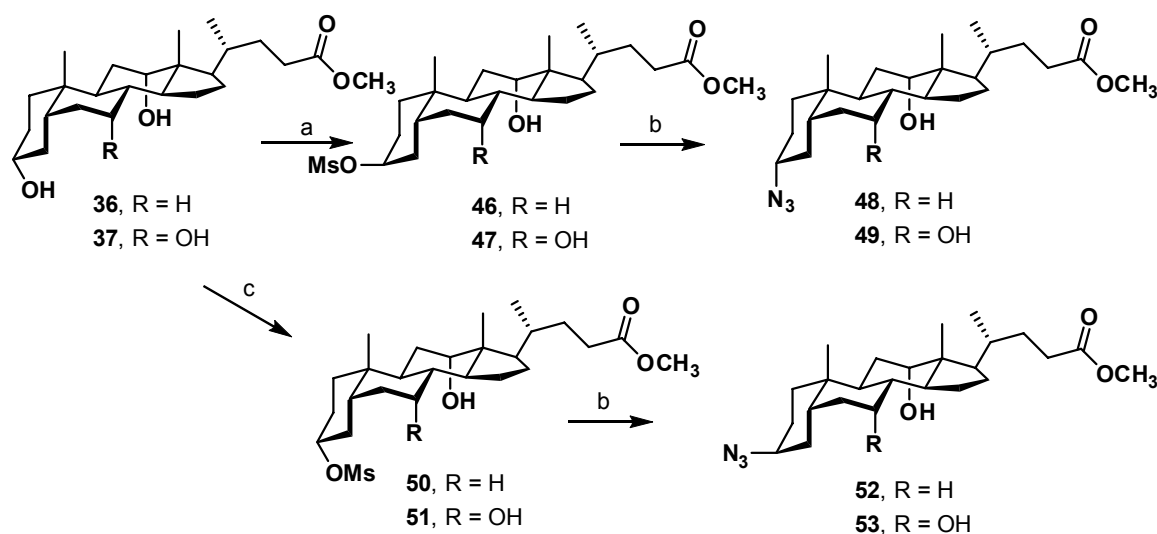

Scheme 5: Reagents and conditions: (a) Ph_3P , Et_3N , MeSO_3H , DEAD, THF, 45 °C, 24 h; (b) NaN_3 , DMF, 60-65 °C, 24 h, 75-78% (overall in 2 steps); (c) MsCl , Et_3N , CH_2Cl_2 , 0 °C, 10 min.

11 α -azido compound **58** was synthesized according to our earlier reported method (Scheme 6).¹¹⁹ Selective acetylation of methyl cholate **37** was carried out using acetic anhydride to obtain diacetoxy methyl ester **54** in good yield. Oxidation of hydroxyl group at C-12 position in **54** using Jones reagent ($\text{CrO}_3/\text{H}_2\text{SO}_4/\text{H}_2\text{O}$) in acetone afforded C-12 ketone **55** (98%) in 5 min.

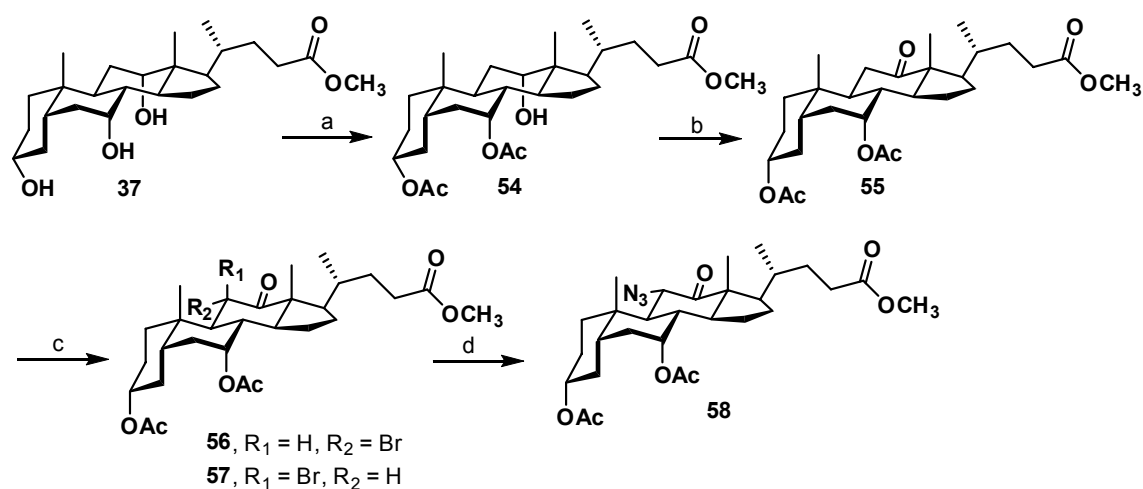

Scheme 6: Reagents and conditions: (a) Ac_2O , DMAP, Et_3N , CH_2Cl_2 , 28 °C, 4-5 h; (b) CrO_3 , H_2SO_4 , Acetone, 10 °C, 5 min; (c) Br_2 , Benzene, 28 °C, 6 days; (d) NaN_3 (5 equiv.), DMF, 60 °C, 16 h.

Subsequent, α -bromination of ketone **55** (Br_2 in Benzene, 6 days) gave mixture of 11 α -bromo and 11 β -bromo derivatives **56** and **57** in 65% and 19% respectively. Treatment of both epimeric α -bromo ketones **56** and **57** with NaN_3 in DMF at 60 °C for 16 h produced 11 α -azide **58** as a single product in 98% yield. The $^1\text{H-NMR}$ spectrum of azide **58** showed a chemical shift for methine proton (CHN_3) at δ 4.06 (d, $J = 10.8$ Hz) due to *trans* diaxial coupling between C-11 and C-9 protons. The presence of azide group was confirmed by IR Spectroscopy (2108 cm^{-1}).

Synthesis of dimers:

Having the azides and alkynes in hand, we used 'Click' reaction for the synthesis of dimers. 1,3-Dipolar cycloaddition reaction of terminal alkyne **34** with C-24 azido compound **44** was attempted using catalytic amount of copper sulfate and sodium ascorbate in *t*-BuOH/ H_2O (Scheme 7). This reaction gave dimer **59** containing 1,2,3-triazole at C-24 in 95% yield.

When the same coupling reaction was carried out under microwave conditions (418 W), the rate of the reaction was found to be much enhanced ($\text{DMF}/\text{H}_2\text{O}$) and the reaction was completed within 5 min. This dimer **59** showed ester carbonyl at 1728 cm^{-1} in IR spectrum. The formation of the dimer was confirmed by $^1\text{H-NMR}$ which showed singlet at δ 7.60 (triazole C-H), a triplets at 4.31 ($\text{CH}_2\text{-N}$) and 5.21 (s, 2H) corresponding to the methylene protons ($\text{CH}_2\text{-O}$). Also, ^{13}C NMR showed three characteristic signals at δ 174.1, 142.7 and 123.6 corresponding to the ester carbonyl and two triazole carbons respectively. Alkyne **35** and azide **45** when subjected to cycloaddition reaction under microwave condition gave C-24 choic acid dimer **60** in 93% yield. Under similar reaction conditions, we synthesized various dimers **61-64** in 90-96% from the corresponding alkynes **34/35** and C-3 α azides **48/49** and C-3 β azides **52/53** as shown in Scheme 7. Formation of 1,2,3-triazole in all dimers was confirmed by appearance of aromatic proton at δ 7.6-7.8 (bs) in $^1\text{H-NMR}$ and appearance of carbon peaks around 123 and 142 ppm corresponding to the triazole carbons in ^{13}C NMR.

More interestingly, sterically hindered azide **58** on reaction with propargyl cholate **35** under similar reaction conditions gave C-24 to C-11 dimer **65** having 1,2,3-triazole at C-11 position in 93% yield. This dimer **65** showed a characteristic chemical shift at $\delta = 7.83$ (bs) due to the triazole H and $\delta = 5.91$ (bs) C-11 β proton (CH-N-triazole) due to the deshielding effect of the triazole ring. ^{13}C NMR showed signals at $\delta = 204.1$ (C-12 keto

carbonyl), 174.3 and 174.0 (both for ester carbonyls), 170.5 and 169.8 (both for acetate carbonyls) as well as 142.7 and 126.0 (both for triazole carbons), respectively.

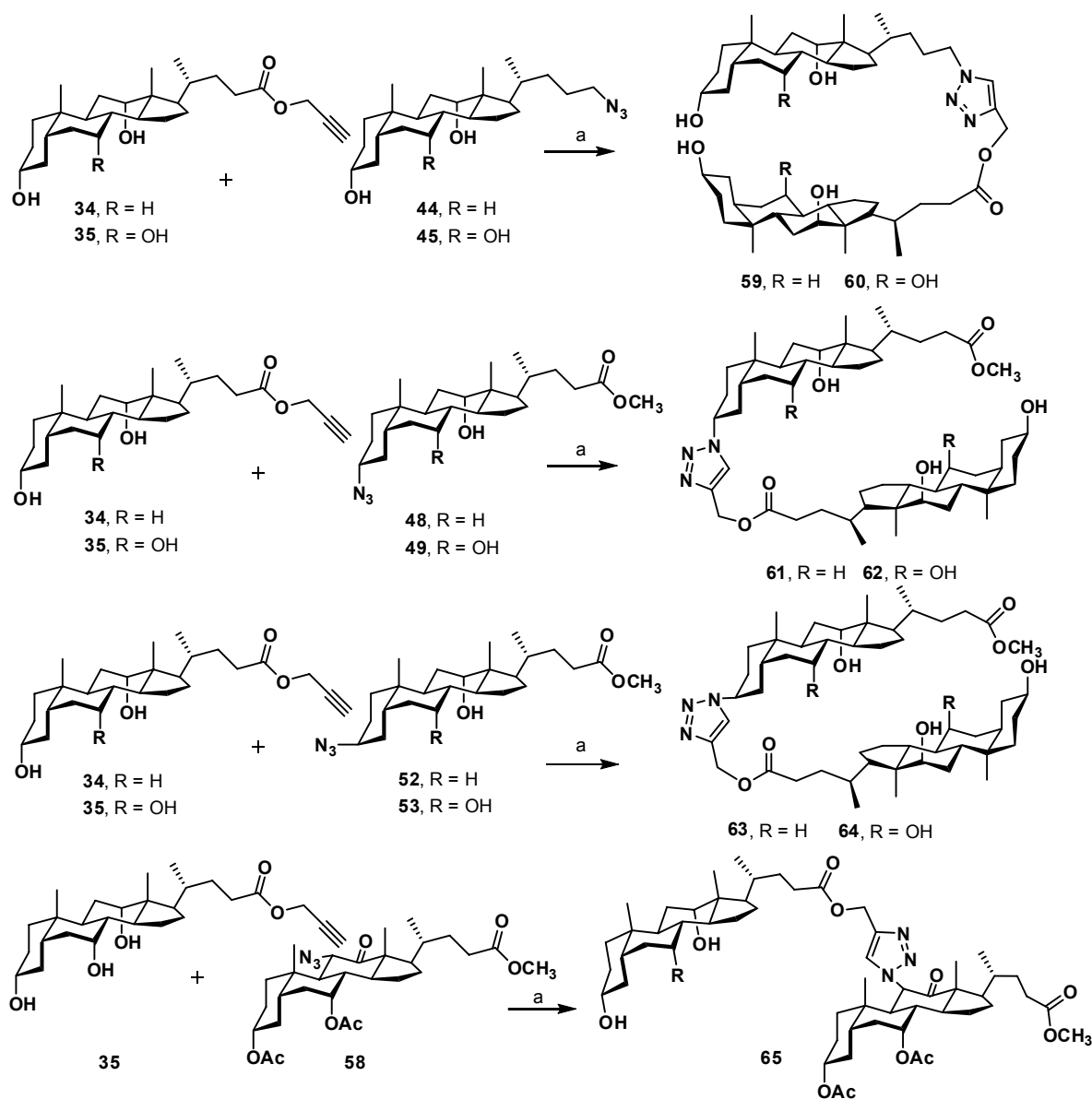

Scheme 7: Reagents and conditions: (a) $\text{CuSO}_4 \cdot 5\text{H}_2\text{O}$ (5 mol %), Sodium ascorbate (20 mol %), $t\text{-BuOH}:\text{H}_2\text{O}$ (9:1), 60–65 °C, 3–12 h; or $\text{CuSO}_4 \cdot 5\text{H}_2\text{O}$ (5 mol %), Sodium ascorbate (40 mol %), $\text{DMF}:\text{H}_2\text{O}$ (4:1), Microwave, 5 min.

Synthesis of cholaphanes

In continuation to our studies for the synthesis of macromolecules *via* Click reaction, we became interested in synthesizing cholaphanes, linked through rigid 1,2,3 triazole unit. Our synthetic route for the preparation of cholaphanes is presented in Scheme 8. The C-3 hydroxyl functionality in **34** was subjected for mesylation (MsCl , Et_3N in CH_2Cl_2) to give mesylate **66**, followed by its nucleophilic substitution with azide anion

(NaN₃ in DMF) gave C3 β -azide **67** in high yield. IR spectrum of azide **67** showed characteristic bands at 1730, 2098, 3307cm⁻¹ corresponding to the ester carbonyl, azido group and acetylenic CH respectively. Its ¹H-NMR spectra showed a characteristic signal at δ 3.96 ppm due to the C3 α -proton. Intermolecular cycloaddition reaction of **67** failed to obtain cholaphane **68** under different conditions using CuSO₄, CuI and Cu powder and trying different solvents such as acetonitrile, DMF, DMSO. Instead of cholaphane **68** we obtained uncharacterized polymeric material.

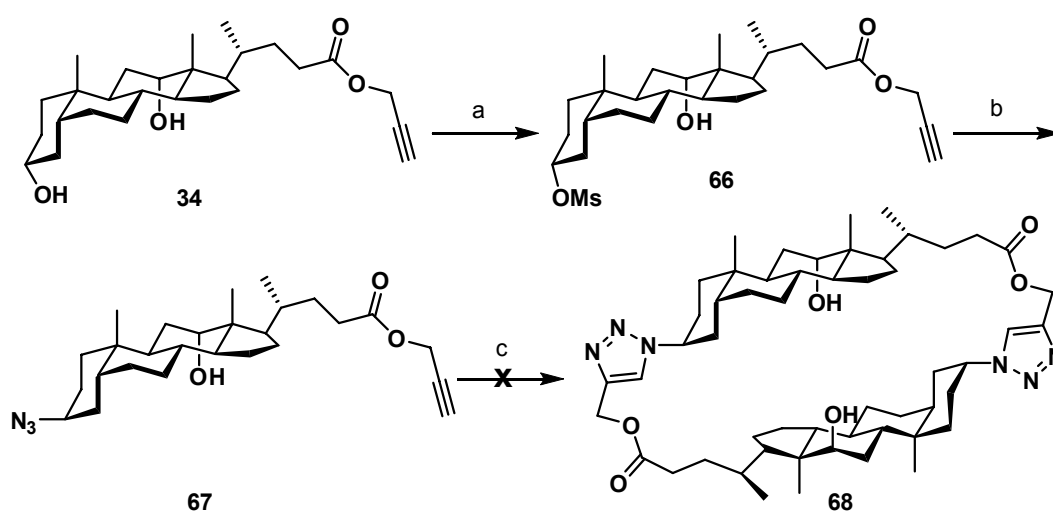

Scheme 8: Reagents and conditions: (a) MsCl, Et₃N, CH₂Cl₂ 0 °C, 10 min.; (b) NaN₃, DMF, 60-65 °C, 3 h, 90%; (c) CuSO₄·5H₂O (5 mol %), Sodium ascorbate (40 mol %), DMF:H₂O (4:1), Microwave, 5 min.

As the desired cholaphane was not obtained, we thought of increasing the chain length at C-3 position by one carbon unit so that azide functionality become little flexible. Accordingly, oxidation of **34** was carried out using Jones reagent to get diketone compound **69** in good yield (Scheme 9). Its formation was confirmed by ¹³C-NMR which showed signals at δ 213.7, 211.7 and 172.8 due to C-3 and C-12 keto carbonyls and ester carbonyl respectively. Diketone **69** underwent regioselective spiro-oxirane formation at C-3 position (Trimethyl sulfoxoniumiodide, NaH in DMSO:THF) to give C3 α -oxirane **70** in 91% yield. The ¹H-NMR showed typical signal at δ 2.62 due to epoxide methylene(CH₂O) and ¹³C-NMR showed only two carbonyl signals at δ 214.6 and 172.8 and appearance signal at δ 53.8 (CH₂O) corresponding to the oxirane ring carbons. (Discussion of stereochemistry of C3 α -oxirane is discussed in chapter 2, section II). Nucleophilic opening of oxirane **70** with azide anion (NaN₃ in DMF) was carried out to get azido alcohol **71** having acetylenic and azide both functionality in a single bile acid

unit. Under cycloaddition reaction conditions, these bifunctional compound **71** again led to uncharacterized solid material, instead of cholaphanes **72**.

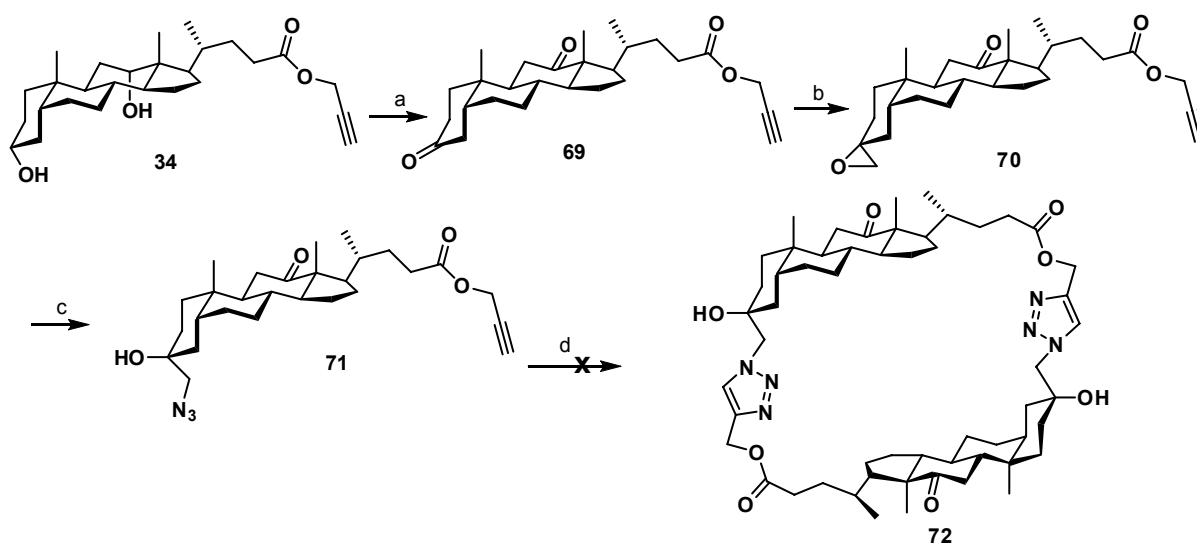

Scheme 9: Reagents and conditions: (a) CrO_3 , H_2SO_4 , acetone, 5 min, 96%. (b) Trimethyl sulfoxoniumiodide, NaH, DMSO-THF, rt. 2 h, 91% (c) NaN_3 , DMF, 60-65 °C, 3 h, 90 %; (d) $\text{CuSO}_4 \cdot 5\text{H}_2\text{O}$ (5 mol %), Sodium ascorbate (40 mol %), DMF: H_2O (4:1), Microwave, 5 min.

At this stage we thought of interchanging the positions of alkyne and azide groups i.e. azide group in the side chain and acetylene near to C-3 position as in compound **74** (Scheme10).

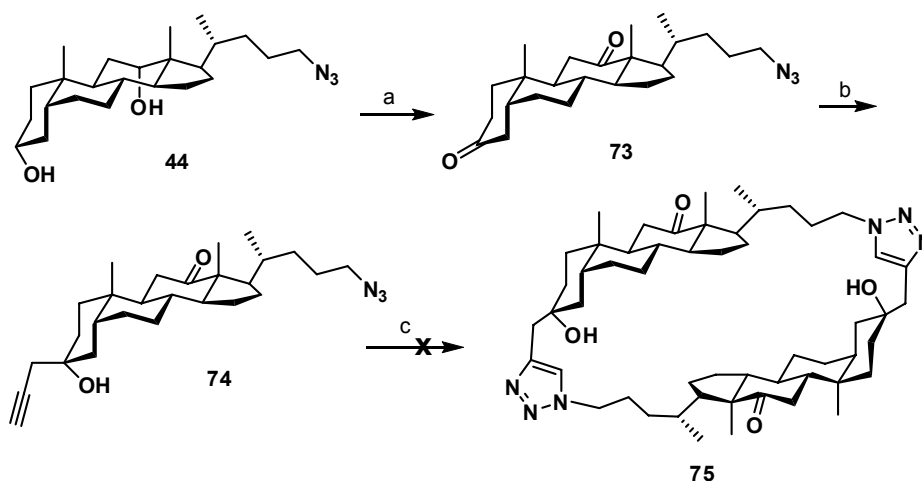

Scheme 10: Reagents and conditions: (a) CrO_3 , H_2SO_4 , acetone, 5 min, 96%. (b) Propargyl bromide, Zn, DMF/THF 25 °C, 5 h, (c) $\text{CuSO}_4 \cdot 5\text{H}_2\text{O}$ (5 mol %), Sodium ascorbate (40 mol %), DMF: H_2O (4:1), Microwave, 5 min.

Jones oxidation of C-24 azide **44** gave diketo compound **73**, followed by regioselective Reformatsky type reaction (Zn, Propargyl bromide in DMF:THF) gave homopropargyl alcohol derivative **74**. However, intramolecular cycloaddition of **74** led to uncharacterized polymeric material. All our efforts to synthesize cholaphanes were unsuccessful. This may be because the azide-alkyne cycloaddition reaction in bile acid compounds is faster to give polymeric material than cyclic dimerization.

Synthesis of oligomers

In continuation to our studies towards synthesis of bile acid based macromolecules, we also tried to synthesize of oligomers *via* 'Click' reaction. Methyl deoxycholate **36** and methyl cholate **37** were treated with chloroacetyl chloride in the presence of CaH_2 and tetrabutylammonium bromide (TBAB) in refluxing toluene to form bis (chloroacetylated) compound **76** and tris (chloroacetylated) compound **77** respectively (Scheme 11).

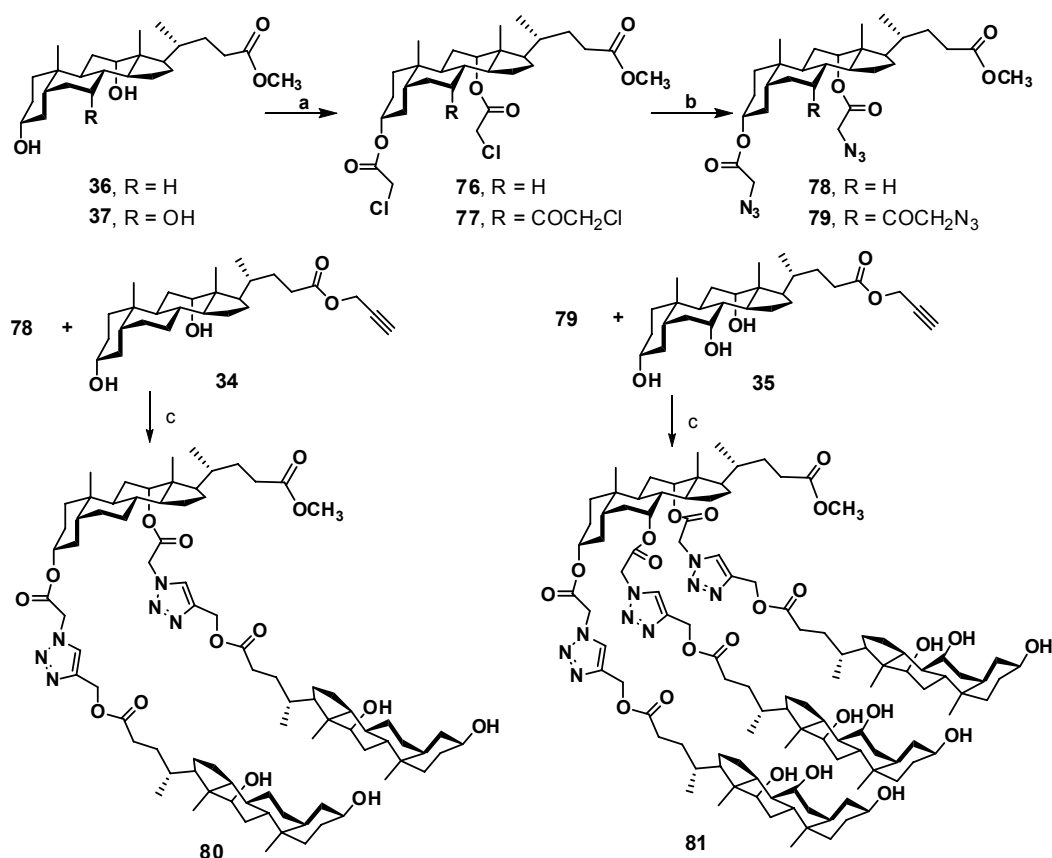

Scheme 11: Reagents and conditions: (a) CaH_2 , ClCH_2COCl , tetrabutylammonium bromide (TBAB), toluene (reflux), 3 h, 78-86% (b) NaN_3 , DMF, 75 °C, 12 h, 79-82%; (c) $\text{CuSO}_4 \cdot 5\text{H}_2\text{O}$ (5 mol%), Sodium ascorbate (40 mol%), DMF:H₂O (4:1), Microwave, 5 min, **23** (85%), **24** (82%).

Formation of these compounds was confirmed $^1\text{H-NMR}$ and $^{13}\text{C-NMR}$. These two compounds, on further reaction with sodium azide in dry DMF at $75\text{ }^\circ\text{C}$ for 12 h, afforded methyl 3,12-bis(azidoacetoxy)-5 β -cholan-24-oate **78** and methyl 3,7,12-tris(azidoacetoxy)-5 β -cholan-24-oate **79**. Conversion of all the chloro atoms to azido was confirmed by LC-MS and also by upfield shift of all the protons attached to azido groups. Cycloaddition reaction of **78** with propargyl deoxycholate **34** gave trimeric compound **80**. Similarly compound **79** on cycloaddition reaction with propargyl cholate **35** gave tetramer **81** having nine hydroxyl groups in a single molecule at the periphery. Thus, by using a simple synthetic route, trimer **80** and tetramer **81** with varying numbers of bile acid units and hydroxyl groups were synthesized in good yield. Both the compounds **80** and **81** were confirmed by their spectroscopic data.

Dye solubilisation Study

Having the six dimers and two oligomers in hand, our next target was to study the micellar properties of these compounds by using hydrophilic dye Cresol Red (CR). There are two recent reports¹⁰² that bile acid dendrons can adopt a reverse micelle-like conformation in nonpolar solvent with the hydrophobic face turned outwards (towards the solvent). Steroidal trimeric, tetrameric and dendritic compounds are known to show encapsulation of hydrophilic and hydrophobic dye. In the trimer two bile acid units are attached to the α face (C-3 α and C-12 α) while in the tetramer three bile acid units are attached to the α face (C-3 α , C-7 α and C-12 α) of rigid steroidal unit. This may form a cage like structure which can easily adopt a reverse micelle-like conformation in polar and nonpolar solvents and encapsulation of hydrophobic and hydrophilic dye may take place. While in case of dimers, both '*syn*' and '*anti*' forms are possible (Figure 14) due to the flexible side chain. Hence for adaptation of guest molecule there must be interaction between guest-host system in such a way that two bile acid units come closer (*syn* conformation).

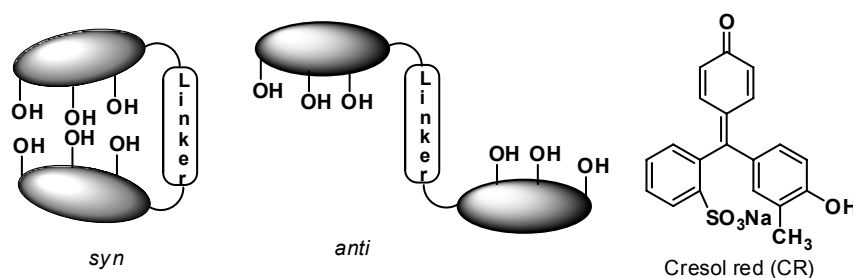

Figure 14: Two stable conformations (*syn* and *anti*) of bile acid dimers.

Our aim was to study the micellar properties of these newly synthesized compounds. We carried out a study of the extraction of the sodium salt of cresol red dye (hydrophilic dye) in nonpolar solvent, chloroform. The solubilisation of dye by dimer, trimer and tetramer was carried out by solid liquid extraction protocol.^{102c}

The dimers **59-64** and oligomers **80** and **81** were soluble in chloroform. In four different vials, 4.1-26.0 mg of dimer (4.58–28.44 μM)/oligomers (2.14-19.39 μM), were dissolved in chloroform (1 mL each). Cresol red sodium salt (5.0 mg) was added to each vial, the vials were sealed and the mixture was stirred at 22-28 $^{\circ}\text{C}$ for 12 h. The resulting solution was diluted to 5 mL chloroform. The solutions were filtered through 0.5 μm PTFE membrane filters in a round bottom flask. Chloroform was evaporated completely and the residue was dissolved in methanol and diluted with methanol to 10 mL. From this stock solution, 1 mL was diluted to 100 mL with methanol and the absorption spectra were recorded at 420 nm on UV-VIS spectrometer. The concentration of cresol red in methanol (in the presence of monomer, dimer and oligomer) was calculated using the molar extinction coefficient (15812) at 420 nm in methanol. The same experiment was carried out without adding dimer/oligomer for blank reading.

We found that dimeric compounds of methyl cholate as well as methyl deoxycholate show dye solubilisation which increases linearly with an increase in concentration of dimer (Figure 15).

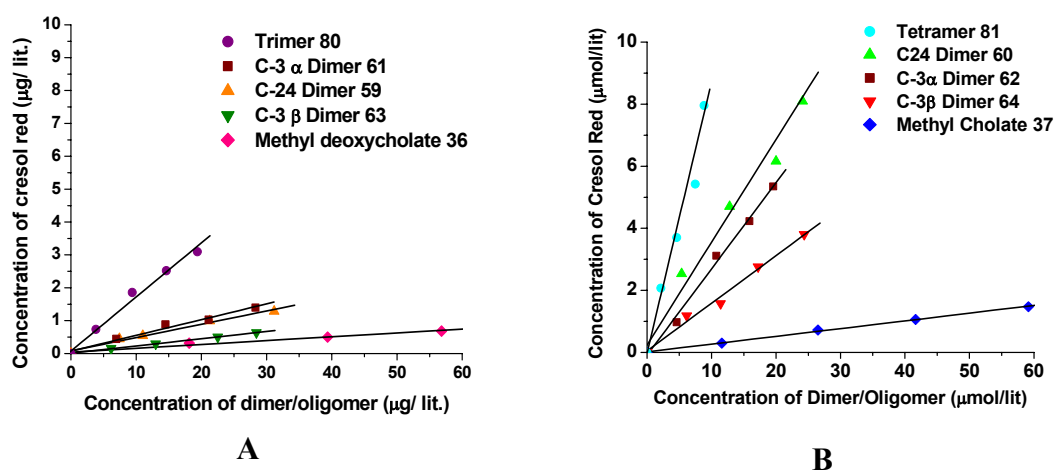

Figure 15: Solubilisation of cresol red (CR) in chloroform by Trimer **80**, Dimers **59**, **63**, **61** and monomer **36** (graph A); Tetramer **81**, and dimers **60**, **64**, **62** and monomer **37** (graph B);

It is observed that dye solubilisation by methyl deoxycholate **36** in which C-7 OH group was absent showed poor encapsulation of cresol red and in dimeric forms **59**, **61**

and **63**, there was only a 2-5 fold increase in the encapsulation than monomeric unit methyl deoxycholate **36** (Figure 15A). On the other hand dimers of cholic acid **60**, **62** and **64** (Figure 15B), which have additional OH group at C-7 position showed better encapsulation than its monomeric unit methyl cholate **37**. C-3 β dimer **64** and C-3 α dimer **62** showed 10 fold increase in dye solubilisation while C-24 dimer **60** showed 13 fold increase in dye solubilisation compared with the monomeric unit **37**. The same experiments were carried out with trimer **80** and tetramer **81**. Interestingly, tetramer **81** showed a 45 fold increase in the encapsulation of cresol red in comparison with methyl cholate, C-24 dimer of cholic acid **60** showed more encapsulation as compared to trimer **80** (Figure 16A).

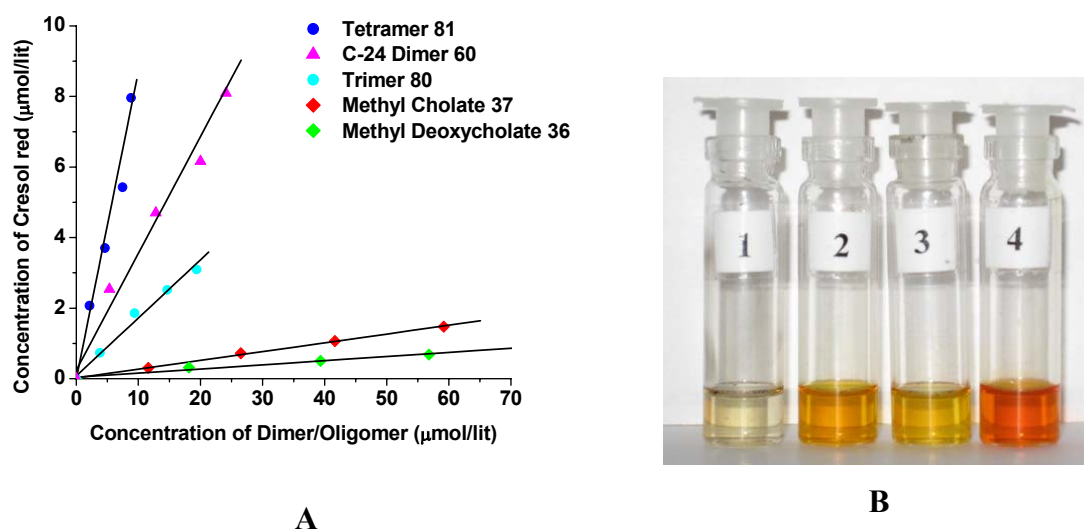

Figure 16: (A) Solubilisation of cresol red (CR) in chloroform by tetramer **81**, C-24 dimer **60**, trimer **80**, and monomers **36**, **37**. Straight lines are linear fit lines of experimental data; (B) Cresol red sodium salt solubilisation in chloroform having a ratio of chloroform:cresol red:oligomer (1 mL:5 mg:5 mg) each sample was filtered through 0.5 micron nylon membrane after 12 h. vial 1 has no additive, vial 2 has C-24 dimer **60**, vial 3 has trimer **80** and vial 4 has tetramer **81**.

Visual expression of these results confirmed the same order of dye extraction; tetramer **81** > C-24 cholic dimer **60** > trimer **80** (Figure 16B). This may be because of the peripheral cholate units in tetramer. In C-24 dimer **60** there are two additional C-7 α hydroxy groups which induce additional hydrogen bonding with cresol red. The extraction efficiencies of cholate based dimers and oligomers were found to be much better than that of deoxycholate.

This clearly shows that these dimers adopt a *syn* conformation in nonpolar solvent and then hydrogen bonding helps them to encapsulate dye. Trimeric compound **80** and

tetrameric compound **81** are also found to encapsulate hydrophilic dye cresol red in nonpolar solvent.

1.5 Conclusion

Cu (I) catalyzed 1,3-dipolar cycloaddition of terminal acetylene with organic azides have been utilized for the synthesis of new steroidal dimers **59-64** and oligomers **80, 81** with varying numbers of bile acid units linked with 1,2,3-triazole in very good yields. Efforts were made intermolecular cyclization to synthesize cholaphanes from bile acids containing both the functionality (alkyne and azide group) in the same molecule. All these dimers and oligomers exhibited reverse micellar characteristics in nonpolar solvent. Cholic acid based molecules were able to encapsulate greater amounts of hydrophilic dye (cresol red) than deoxycholate based molecules. Dimeric compounds were also able to encapsulate hydrophilic dye in nonpolar solvent which may be due to the formation of the *cis*-conformation in the presence of dye which helps hydrogen bonding. There may be additional hydrogen bonding due to the 1,2,3-triazole ring.

1.6 Experimental Section

Synthesis of terminal acetylenes

Propargyl 3 α ,12 α -dihydroxy-5 β -cholan-24-oate (34) and Propargyl 3 α ,7 α ,12 α -trihydroxy-5 β -cholan-24-oate (35):

To a solution of **2/4** (5 mmol) in propargyl alcohol (5-10 mL), a catalytic amount (10 mole %) of *para*-toluene sulfonic acid (*p*-TSA) was added. The reaction mixture was then heated at 55-60 °C for 7 h. It was then poured on crushed ice and extracted with EtOAc (3 \times 25 mL). The extract was washed with water (3 \times 25 mL), brine (25 mL) and dried over Na₂SO₄. Solvent was evaporated under reduced pressure to afford crude products; purification by column chromatography on silica gel (2% MeOH/CH₂Cl₂) gave compound **34/35** as white solid.

Propargyl 3 α ,12 α -dihydroxy-5 β -cholan-24-oate (34): White solid, Yield: 96%; mp 160-161 °C; $[\alpha]_D^{25} = +43.5$ (CHCl₃, c 2.2); IR (cm⁻¹): 3430, 3305, 1730; ¹H NMR (300 MHz, CDCl₃): δ 0.67 (s, 3H, CH₃-18), 0.91 (s, 3H, CH₃-19), 0.97 (d, *J* = 5.9 Hz, 3H, CH₃-21), 2.47 (t, *J* = 2.2 Hz, 1H), 3.60 (m, 1H, CH-3), 3.98 (bs, 1H, CH-12), 4.68 (d, *J* = 2.2 Hz, 2H); ¹³C NMR (CDCl₃, 75 MHz): δ 12.6, 17.1, 22.9, 23.6, 26.0, 27.1, 27.4, 28.5, 30.2,

30.7, 30.9, 33.5, 34.0, 35.1, 35.2, 35.9, 36.3, 42.0, 46.4, 47.1, 48.1, 51.6, 71.5, 72.9, 74.6, 77.7, 173.2; Anal. Calcd for C₂₇H₄₂O₄: C, 75.31; H, 9.83; Found: C, 75.18; H, 10.02; MS (LCMS) *m/z*: 453.14 (M + 23 for Na).

Propargyl 3 α ,7 α ,12 α -trihydroxy-5 β -cholan-24-oate (35): White solid, Yield: 95%; mp 112-114 °C; $[\alpha]_D^{25} = +26.15$ (CHCl₃, *c* 1.3); IR (cm⁻¹): 3404, 3307, 1737; ¹H NMR (200 MHz, CDCl₃): δ 0.68 (s, 3H, CH₃-18), 0.89 (s, 3H, CH₃-19), 0.98 (d, *J* = 5.8 Hz, 3H, CH₃-21), 2.47 (t, *J* = 2.5 Hz, 1H), 3.45 (m, 1H, CH-3), 3.85 (bs, 1H, CH-7), 3.97 (bs, 1H, CH-12), 4.68 (d, *J* = 2.5 Hz, 2H); ¹³C NMR (CDCl₃, 50 MHz): δ 12.3, 17.2, 22.3, 23.1, 26.1, 27.4, 28.0, 29.6, 30.2, 30.6, 30.9, 34.7, 35.1, 39.3, 41.4, 46.3, 46.8, 51.6, 68.3, 71.7, 73.0, 74.7, 77.7, 173.4; Anal. Calcd for C₂₇H₄₂O₅: C, 72.61; H, 9.48; Found: C, 72.25; H, 9.57; MS (LCMS) *m/z*: 469.15 (M + 23 for Na).

Methyl 3 α ,12 α -dihydroxy-5 β -cholane-24-oate (36) and Methyl 3 α ,7 α ,12 α -trihydroxy-5 β -cholane-24-oate (37):

To a solution of deoxycholic acid **2** (0.3 g, 0.74 mmol) in dry methanol (10 mL) was added *p*-TSA (0.03 g, 0.17 mmol). The mixture was stirred at 28 °C for 24 hrs. Methanol was evaporated and the residue was extracted with CH₂Cl₂ (3x50 mL). The organic extract was washed with cold H₂O (2x10 mL), 10 % NaHCO₃ (2x10 mL), brine (2x10 mL) and dried over Na₂SO₄. Solvent was evaporated under reduced pressure to afford crude product. Purification by column chromatography on silica gel (5 %, MeOH/CHCl₃) afforded compound **36** (0.3 g, 98 %) as a white solid.

Methyl 3 α ,12 α -dihydroxy-5 β -cholane-24-oate (36): white solid; mp 82-105 °C (lit.^{120a} mp 70-108 °C); IR (cm⁻¹): 3385, 1728; ¹H NMR (CDCl₃, 500 MHz): δ 0.68 (s, 3H, CH₃-18), 0.91 (s, 3H, CH₃-19), 0.98 (d, *J* = 6.4 Hz, 3H, CH₃-21), 3.62 (m, 1H, CH-3), 3.67 (s, 3H) 3.98 (bs, 1H, CH-12); ¹³C NMR (CDCl₃, 125 MHz): δ 12.6, 17.1, 23.0, 23.6, 26.0, 27.1, 27.4, 28.4, 29.6, 30.1, 30.8, 31.0, 33.4, 34.0, 35.2, 35.9, 36.2, 42.0, 46.3, 47.0, 48.0, 51.4, 71.4, 72.9, 174.7.

Methyl 3 α ,7 α ,12 α -trihydroxy-5 β -cholane-24-oate (37): white solid; mp 155-156 °C (lit.^{120b} mp 155-156 °C); $[\alpha]_D^{28} = +31.33$ (CHCl₃, *c* 1.0); IR (cm⁻¹): 3376, 1731; ¹H NMR (CDCl₃, 200 MHz): δ 0.68 (s, 3H, CH₃-18), 0.89 (s, 3H, CH₃-19), 0.98 (d, *J* = 5.7 Hz,

3H, CH₃-21), 3.57 (m, 1H CH-3), 3.67 (s, 3H) 3.89 (bs, 1H, CH-7), 4.01 (bs, 1H, CH-12); ¹³C NMR (CDCl₃, 50 MHz): δ 12.8, 17.7, 22.8, 23.6, 26.6, 27.7, 28.5, 30.0, 31.4, 31.5, 35.2, 35.2, 35.7, 35.8, 39.9, 39.9, 42.0, 42.0, 46.8, 47.3, 51.8, 68.8, 72.2, 73.4, 175.2.

Synthesis of azides

3α,12α,24-Trihydroxy-5β-cholane (38) and 3α,7α,12α,24-Tetrahydroxy-5β-cholane (39):

Compounds **38** and **39** were synthesized in overall good yield starting from methyl esters **36** and **37** of deoxycholic acid **2** and cholic acid **4** using the literature procedure.^{120c}

To a stirred suspension of LiAlH₄ (0.076g, 2mmol) in dry THF (10 mL), compound **36** (0.406 g, 1 mmol) in dry THF (20 mL) was added dropwise at 25 °C. After 2h saturated NH₄Cl solution was added to the ice cooled reaction mixture. It was filtered through celite and residue was washed with THF (25 mL). Solvent was evaporated under reduced pressure and it was extracted with EtOAc (3x50 mL). Extract was washed with water (2x25 mL) and brine (25 mL) and dried over Na₂SO₄. Solvent was evaporated under reduced pressure to afford crude product which was purified by column chromatography on silica gel (5% MeOH/CH₂Cl₂) to produce compound **38** as white solid (0.363g, 96%).

3α,12α,24-trihydroxy-5β-cholane (38): white solid; mp 123-124 °C (lit.^{120d} mp 107-114 °C, lit.^{120e} mp 123 °C); IR (cm⁻¹) 3257; ¹H NMR (CDCl₃, 200 MHz): δ 0.69 (s, 3H), 0.91 (s, 3H), 0.99 (d, *J* = 6.9 Hz, 3H), 3.61 (m, 3H), 4.00 (bs, 1H), ¹³C NMR (CDCl₃, 50 MHz): δ 12.7, 17.7, 23.1, 23.7, 26.2, 27.2, 27.6, 28.5, 29.4, 30.4, 31.8, 33.6, 34.1, 35.3, 35.4, 36.1, 36.4, 42.1, 46.5, 47.5, 48.2, 63.4, 71.8, 73.3. Anal. Calcd for C₂₄H₄₂O₃: C, 76.14; H, 11.18; Found: C, 75.85 H, 10.87; MS (LCMS) *m/z*: 379.61 (M + 1).

3α,7α,12α,24-Tetrahydroxy-5β-cholane (39): mp 236-238 °C (lit.^{120c} mp 236.5-238 °C); IR (cm⁻¹) 3258; ¹H NMR (CDCl₃, 200 MHz): δ 0.69 (s, 3H), 0.89 (s, 3H), 1.01 (d, *J* = 6.5 Hz, 3H), 3.39 (bs, 1H), 3.57 (t, *J* = 6.5 Hz, 2H) 3.83 (bs, 1H), 3.97 (bs, 1H), ¹³C NMR (CDCl₃, 50 MHz): δ 12.1, 17.1, 22.1, 22.9, 26.1, 27.3, 27.7, 28.9, 29.6, 31.6, 34.2, 34.5, 34.9, 35.4, 38.8, 39.1, 41.1, 41.3, 46.0, 46.9, 62.6, 68.0, 71.2, 72.8.; Anal. Calcd for C₂₄H₄₂O₄: C, 73.05; H, 10.73; Found: C, 74.85 H, 10.57; MS (LCMS) *m/z*: 395.22 (M + 1).

3 α ,12 α -Dihydroxy 24-mesyloxy-5 β -cholane (40) and 3 α ,24-Dimesyloxy-12 α -hydroxy-5 β -cholane (41):

To a solution of **38** (2.0 g 5.28 mmol) in dry CH₂Cl₂ (20 mL), was added triethylamine (1.5 mL, 0.56 mmol) at 0 °C. Methane sulfonyl chloride (0.53 mL, 6.86 mmol in 10 mL CH₂Cl₂) was added dropwise in 10 min at 0 °C, ice was added to the reaction mixture immediately after addition was complete. The reaction mixture was extracted with CH₂Cl₂. Organic layer was washed with NaHCO₃, water and brine. Solvent was evaporated under reduced pressure. The crude product was purified by column chromatography (0.5% MeOH/CH₂Cl₂) to obtain pure products **40** (1.805 g) and **41** (0.615 g).

3 α ,12 α -Dihydroxy 24-mesyloxy-5 β -cholane (40): White solid; mp 78 °C; [α]_D²⁶ (CHCl₃, c 0.2) = + 93.04; IR (cm⁻¹): 3419, 1416, 1448 cm⁻¹; ¹H NMR (CDCl₃, 300 MHz): δ 0.68 (s, 3H, CH₃-18), 0.91 (s, 3H, CH₃-19), 0.99 (d, J = 6.3 Hz, 3H, CH₃-21), 3.00 (s, 3H) 3.60 (m, 1H, CH-3), 3.97 (s, 1H, CH-12), 4.19 (t, J = 6.7 Hz, 2H); ¹³C NMR (CDCl₃, 75 MHz): δ 12.6, 17.4, 23.0, 23.6, 25.9, 26.0, 27.0, 27.5, 28.6, 30.3, 31.4, 33.5, 34.0, 35.0, 35.2, 35.9, 36.3, 37.3, 42.0, 46.4, 47.3, 48.1, 70.5, 71.6, 73.0; Anal. Calcd for C₂₅H₄₄O₅S: C, 65.75; H, 9.71; S, 7.02; Found: C, 65.45; H, 9.53; S, 7.28; MS (LCMS) m/z : 457.19 (M + 1), 479.13 (M + 23 for Na).

3 α ,24-dimesyloxy-12 α -hydroxy-5 β -cholane (41): White solid; mp 67-68 °C; [α]_D²⁷ (CHCl₃, c 2.7) = + 43.25; IR (cm⁻¹): 3566; ¹H NMR (CDCl₃, 300 MHz): δ 0.68 (s, 3H, CH₃-18), 0.92 (s, 3H, CH₃-19), 1.00 (d, J = 6.3 Hz, 3H, CH₃-21), 3.00 (s, 3H), 3.01 (s, 3H), 4.00 (s, 1H, CH-12), 4.21 (t, J = 6.7 Hz, 2H), 4.65 (m, 1H, CH-3); ¹³C NMR (CDCl₃, 75 MHz): δ 12.6, 17.4, 22.7, 23.4, 25.7, 25.8, 26.6, 27.4, 27.5, 28.5, 31.2, 33.1, 33.4, 33.7, 34.7, 34.9, 35.7, 37.2, 38.7, 41.9, 46.3, 47.1, 47.9, 70.6, 72.7, 82.7; Anal. Calcd for C₂₆H₄₆O₇S₂: C, 58.39; H, 8.67; S, 11.99; Found: C, 58.22; H, 8.39; S, 12.16; MS (LCMS) m/z : 557.32 (M + 23 for Na).

3 α ,7 α ,12 α -Trihydroxy-24-mesyloxy-5 β -cholane (42) and 3 α ,24-Dimesyloxy-7 α ,12 α -dihydroxy-5 β -cholane (43):

To a solution of **39** (0.394 g, 1 mmol) in dry pyridine (5 mL), methane sulfonyl chloride (0.12 mL, 1.5 mmol) was added. After 10 min, ice was added to the reaction mixture and it was extracted with EtOAc. Combined organic layer was washed with cold water, aq. HCl (5%), water, brine and dried over Na₂SO₄. Solvent was evaporated under reduced pressure and the crude product was purified by column chromatography (10% MeOH/CH₂Cl₂) to obtain pure **42** (0.329 g) and pure **43** (0.125 g).

3 α ,7 α ,12 α -Trihydroxy 24-mesyloxy-5 β -cholane (42): White solid; mp 79-81 °C; [α]_D²⁶ (CHCl₃, c 0.9) = + 68.49; IR (cm⁻¹): 3408; ¹H NMR (CDCl₃, 200 MHz): δ 0.68 (s, 3H, CH₃-18), 0.89 (s, 3H, CH₃-19), 0.99 (d, *J* = 6.5 Hz, 3H, CH₃-21), 3.01 (s, 3H), 3.44 (m, 1H, CH-3), 3.84 (s, 1H, CH-7), 3.97 (s, 1H, CH-12) 4.21 (t, *J* = 6.6 Hz, 2H); ¹³C NMR (CDCl₃, 50 MHz): δ 12.3, 17.5, 20.8, 22.3, 23.1, 25.8, 26.2, 27.5, 28.0, 29.6, 30.1, 31.3, 34.5, 34.7, 35.1, 37.4, 39.2, 39.3, 41.3, 41.5, 46.3, 46.9, 68.4, 70.8, 71.9, 73.1; Anal. Calcd for C₂₅H₄₄O₆S: C, 63.52; H, 9.38; S, 6.78; Found: C, 63.21; H, 9.12; S, 6.53; MS (LCMS) *m/z*: 473.91 (M + 1), 495.89 (M + 23 for Na).

3 α , 24-Dimesyloxy-7 α ,12 α -dihydroxy-5 β -cholane (43): White solid; mp 82-84 °C; [α]_D²⁵ (CHCl₃, c 0.8) = + 29.85; IR (cm⁻¹): 3434; ¹H NMR (CDCl₃, 200 MHz): δ 0.69 (s, 3H, CH₃-18), 0.91 (s, 3H, CH₃-19), 0.99 (d, *J* = 6.5 Hz, 3H, CH₃-21), 2.99 (s, 3H), 3.01 (s, 3H), 3.87 (bs, 1H), 4.00 (s, 1H, CH-12), 4.21 (t, *J* = 6.7 Hz, 2H), 4.51 (m, 1H, CH-3); ¹³C NMR (CDCl₃, 50 MHz): δ 12.3, 17.5, 22.1, 22.7, 23.0, 26.3, 27.4, 27.8, 28.0, 31.3, 34.2, 34.4, 34.7, 35.1, 35.9, 37.2, 38.7, 39.2, 41.3, 41.6, 46.3, 47.1, 68.0, 70.7, 72.8, 83.0; Anal. Calcd for C₂₆H₄₆O₈S₂: C, 56.70; H, 8.42; S, 11.64; Found: C, 56.84; H, 8.26; S, 11.81; MS (LCMS) *m/z*: 573.51 (M + 23 for Na).

3 α ,12 α -dihydroxy 24-azido-5 β -cholane (44) and 3 α ,7 α ,12 α -trihydroxy 24-azido-5 β -cholane (45):

To a solution of **40** (0.300 g, 0.66 mmol) in dry DMF (10 mL), sodium azide (0.214 g, 3.28 mmol) was added and the reaction mixture was stirred at 60-65 °C for 3-5h. The reaction mixture was then allowed to cool to room temperature, poured into ice-cold water (30 mL) and extracted with EtOAc. The organic extract was washed with cold water and brine. Solvent was evaporated under reduced pressure to afford crude product

which was purified by column chromatography on silica gel (10% EtOAc/hexane) to give pure compound **44** as white solid (0.247 g).

3 α ,12 α -Dihydroxy-24-azido-5 β -cholane (44): White solid, yield 94%; mp 126 °C; $[\alpha]_D^{28}$ (CHCl₃, c 1.4) = + 40.57; IR (cm⁻¹): 2090, 3409; ¹H NMR (CDCl₃, 200 MHz): δ 0.69 (s, 3H, CH₃-18), 0.91 (s, 3H, CH₃-19), 0.99 (d, J = 6.7 Hz, 3H, CH₃-21), 3.24 (t, J = 7.1 Hz, 2H), 3.62 (m, 1H, CH-3), 4.00 (bs, 1H, CH-12); ¹³C NMR (CDCl₃, 50 MHz): δ 12.7, 17.6, 23.1, 23.6, 25.6, 26.1, 27.1, 27.5, 28.7, 30.5, 32.9, 33.7, 34.1, 35.3, 36.1, 36.5, 42.2, 46.5, 47.5, 48.3, 51.9, 71.7, 73.2; Anal. Calcd for C₂₄H₄₁N₃O₂: C, 71.42; H, 10.24; N, 10.41; Found: C, 71.19; H, 10.46; N, 10.38; MS (LCMS) m/z : 404.88 (M + 1), 426.83 (M + 23 for Na).

3 α ,7 α ,12 α -Trihydroxy 24-azido-5 β -cholane (45): Compound **45** was prepared by similar procedure from compound **42**. White solid; yield 93%; mp 160 °C; $[\alpha]_D^{25}$ (CHCl₃, c 0.8) = + 31.46; IR (cm⁻¹): 2098, 3410; ¹H NMR (CDCl₃, 200 MHz): δ 0.68 (s, 3H), 0.89 (s, 3H), 0.99 (d, 3H, J = 6.3 Hz), 3.25 (t, 2H, J = 6.6 Hz), 3.52 (m, 1H), 3.87 (bs, 1H), 4.00 (bs, 1H), 4.50 (bs, 3H, OH); ¹³C NMR (CDCl₃, 50 MHz): δ 12.4, 17.6, 22.4, 23.1, 25.6, 26.2, 27.6, 28.1, 30.2, 32.8, 34.6, 34.7, 35.3, 35.3, 39.3, 39.4, 41.4, 41.5, 46.3, 47.1, 51.9, 68.4, 71.8, 73.1; Anal. Calcd for C₂₄H₄₁N₃O₃: C, 68.70; H, 9.85; N, 10.01. Found: C, 68.65; H, 9.69; N, 9.94; MS (LCMS) m/z : 420.24 (M + 1), 442.23 (M + 23 for Na).

Methyl-3 α -azido-12 α -hydroxy-5 β -cholane-24-oate (48) and Methyl-3 α -azido-7 α ,12 α -dihydroxy-5 β -cholane-24-oate (49):

To a solution of **36/37** (1 mmol), and triphenylphosphine (0.865 g, 3.3 mmol), in dry THF (20 mL) at 0 °C, triethylamine (0.3 mL, 2 mmol) and methane sulfonic acid (0.14 mL, 2.1 mmol) were added. The mixture was warmed to 45 °C and diethylazodicarboxylate (DEAD) (0.6 mL, 3.1 mmol) was added dropwise with stirring. Reaction was continued for 24 h, after which the solvent was removed under reduced pressure and the residue was purified by column chromatography (5% EtOAc/hexane) to give C-3 β mesyloxy compounds contaminated with DEAD residues. This material was redissolved in dry DMF (10 mL) and sodium azide (0.325 g, 5 mmol) was added and stirring was continued at 60-65 °C for 24 h. The reaction mixture was allowed to cool to room temperature and it was then poured into ice cold water (30 mL) and was extracted with EtOAc (3 \times 50 mL).

The organic extract was washed with cold water (3×50 mL), followed by brine (25 mL) and it was dried over Na₂SO₄. Solvent was evaporated under reduced pressure to afford crude product. Purification of the crude product by column chromatography on silica gel (10% EtOAc/hexane) produced compounds **48** or **49** as white solids.

Methyl 3 α -azido-12 α -hydroxy-5 β -cholan-24-oate (48): White solid, Yield: 75% (overall in two steps); mp 82 °C; $[\alpha]_D^{25} = +49.8$ (CHCl₃, c 0.44); IR (cm⁻¹): 3332, 2094, 1730; ¹H NMR (300 MHz, CDCl₃): δ 0.68 (s, 3H, CH₃-18), 0.93 (s, 3H, CH₃-19), 0.97 (d, $J = 5.9$ Hz, 3H, CH₃-21), 3.33 (m, 1H, CH-3), 3.67 (s, 3H), 3.98 (bs, 1H, CH-12); ¹³C NMR (75 MHz, CDCl₃): δ 12.7, 17.1, 23.0, 23.5, 25.9, 26.6, 26.9, 27.3, 28.6, 30.8, 30.9, 32.3, 35.5, 34.0, 34.9, 35.3, 35.8, 42.2, 46.4, 47.1, 48.0, 51.3, 61.1, 72.8, 174.5; Anal. Calcd for C₂₅H₄₁N₃O₃: C, 69.57; H, 9.57; N, 9.74; Found: C, 69.23; H, 9.53; N, 9.56; MS (LCMS) m/z : 454.64 (M + 23 for Na).

Methyl 3 α -azido-7 α ,12 α -dihydroxy-5 β -cholan-24-oate (49): White solid, Yield: 78% (overall in two steps); mp 107-109 °C (lit^{118b} 109-110 °C); $[\alpha]_D^{25} = +37.2$ (CHCl₃, c 0.86); IR (cm⁻¹): 3470, 2093, 1730; ¹H NMR (200 MHz, CDCl₃): δ 0.69 (s, 3H, CH₃-18), 0.91 (s, 3H, CH₃-19), 0.97 (d, $J = 6.3$ Hz, 3H, CH₃-21), 3.16 (m, 1H, CH-3), 3.67 (s, 3H), 3.86 (bs, 1H, CH-7), 3.98 (bs, 1H, CH-12); ¹³C NMR (50 MHz, CDCl₃): δ 12.3, 17.2, 22.3, 23.1, 26.3, 26.7, 27.4, 28.0, 30.7, 30.9, 34.7, 35.3, 35.4, 39.1, 41.6, 46.4, 47.1, 51.4, 61.2, 68.2, 73.0, 174.8; Anal. Calcd for C₂₅H₄₁N₃O₄: C, 67.08; H, 9.23; N, 9.39; Found: C, 66.86; H, 9.48; N, 9.25; MS (LCMS) m/z : 470.54 (M + 23 for Na).

Methyl-3 α -mesyloxy-12 α -hydroxy-5 β -cholane-24-oate (50) and Methyl-3 α -mesyloxy-7 α -12 α -dihydroxy-5 β -cholane-24-oate (51): Compounds **50** and **51** were prepared from compounds **36** and **37** by using similar procedure as used for the preparation of compound **40**.

Methyl-3 α -mesyloxy-12 α -hydroxy-5 β -cholane-24-oate (50): White solid, yield 89%; mp 62-63 °C; $[\alpha]_D^{27}$ (CHCl₃, c 4.1) = +45.77; IR (cm⁻¹): 1728, 3549; ¹H NMR (CDCl₃, 200 MHz): δ 0.67 (s, 3H), 0.91 (s, 3H), 0.97 (d, 3H, $J = 6.1$ Hz), 2.99 (s, 3H), 3.65 (s, 3H), 3.98 (bs, 1H), 4.64 (m, 1H); ¹³C NMR (CDCl₃, 50 MHz): δ 12.3, 16.8, 22.5, 23.3, 25.6, 26.5, 27.1, 27.3, 28.3, 30.5, 30.6, 32.9, 33.1, 33.5, 34.5, 34.8, 35.5, 38.4, 41.7, 46.1, 46.7,

47.6, 51.1, 72.3, 82.5, 174.3; Anal. Calcd for C₂₆H₄₄O₆S: C, 64.43; H, 9.15; S, 6.62; Found: C, 64.58; H, 9.02; S, 6.73; MS (LCMS) *m/z*: 485.23 (M + 1), 507.22 (M + 23 for Na).

Methyl-3 α -mesyloxy-7 α -12 α -dihydroxy-5 β -cholane-24-oate (51): White solid, yield 87%; mp 83-85 °C; $[\alpha]_D^{28}$ (CHCl₃, c 0.9) = + 29.98; IR (cm⁻¹): 1728, 3460; ¹H NMR (CDCl₃, 200 MHz): δ 0.69 (s, 3H), 0.91 (s, 3H), 0.99 (d, 3H, *J* = 6.1 Hz), 2.99 (s, 3H), 3.67 (s, 3H), 3.88 (bs, 1H), 4.00 (bs, 1H), 4.51 (m, 1H); ¹³C NMR (CDCl₃, 50 MHz): δ 12.4, 17.2, 22.1, 23.0, 26.3, 27.4, 27.8, 28.0, 30.7, 30.9, 34.1, 34.4, 34.7, 35.1, 35.9, 38.7, 39.3, 41.3, 41.6, 46.4, 47.0, 51.4, 68.0, 72.8, 82.9, 174.7; Anal. Calcd for C₂₆H₄₄O₇S: C, 62.37; H, 8.86; S, 6.40; Found: C, 62.23; H, 8.92; S, 6.23; MS (LCMS) *m/z*: 501.07 (M + 1), 523.17 (M + 23 for Na).

Methyl-3 β -azido-12 α -hydroxy-5 β -cholane-24-oate (52) and Methyl-3 β -azido-7 α ,12 α -dihydroxy-5 β -cholane-24-oate (53):

The compounds **50** and **51** were reacted with NaN₃ (3 equiv.) in DMF for 4 h at 80-90 °C to give compounds **52** and **53** respectively.¹²¹

Methyl-3 β -azido-12 α -hydroxy-5 β -cholane-24-oate (52): White solid, yield 91%; mp 127-128 °C (lit.^{122a} 128 °C); $[\alpha]_D^{27}$ (CHCl₃, c 0.8) = + 41.34; IR (cm⁻¹): 1728, 2102, 3503; ¹H NMR (CDCl₃, 200 MHz): δ 0.68 (s, 3H), 0.94 (s, 3H), 0.97 (d, 3H, *J* = 6.2 Hz), 3.66 (s, 3H), 3.94 (bs, 1H), 3.99 (bs, 1H); ¹³C NMR (CDCl₃, 50 MHz): δ 12.7, 17.3, 23.5, 23.5, 24.5, 25.9, 26.4, 27.4, 28.8, 30.1, 30.5, 30.8, 31.0, 33.2, 34.4, 35.0, 35.8, 37.2, 46.5, 47.3, 48.3, 51.4, 58.7, 73.1, 174.6; Anal. Calcd for C₂₅H₄₁N₃O₃: C, 69.57; H, 9.57; N, 9.74; Found: C, 69.47; H, 9.90; N, 9.66; MS (LCMS) *m/z*: 432.26 (M + 1), 454.25 (M + 23 for Na).

Methyl-3 β -azido-7 α ,12 α -dihydroxy-5 β -cholane-24-oate (53): White solid, yield 90%; mp = 169-170 °C (lit.^{122b} 157 °C); $[\alpha]_D^{27}$ (MeOH, c 1.16) = + 22.45 (lit.^{122b} + 23.7); IR (cm⁻¹): 1728, 2098, 3439; ¹H NMR (CDCl₃, 200 MHz): δ 0.70 (s, 3H), 0.93 (s, 3H), 0.97 (d, 3H, *J* = 6.1 Hz), 3.67 (s, 3H), 3.86-3.89 (bs, 2H), 3.99 (bs, 1H); ¹³C NMR (CDCl₃, 50 MHz): δ 12.4, 17.2, 22.7, 23.2, 24.5, 26.0, 27.4, 28.3, 30.4, 30.8, 31.0, 33.0, 34.2, 35.1, 35.2, 36.7, 39.3, 41.7, 46.5, 47.2, 51.5, 58.7, 68.4, 73.0, 174.7; Anal. Calcd for

C₂₅H₄₁N₃O₄: C, 67.08; H, 9.23; N, 9.39; Found: C, 67.21; H, 9.18; N, 9.31; MS (LCMS) *m/z*: 448.24 (M + 1), 470.22 (M + 23 for Na).

Synthesis of 11 α -azido compound (58)

Methyl 3 α ,7 α -diacetoxy-12 α -hydroxy-5 β -cholan-24-oate (54):

To a solution of methyl ester **37** (0.211 g, 0.5 mmol), DMAP (0.07 g, 0.06 mmol) and acetic anhydride (0.11 g, 1.05 mmol) in dry CH₂Cl₂ (10 mL) was added Et₃N (0.22 g, 2.13 mmol) at 0 °C. The reaction mixture was allowed to stir at 0-28 °C for 4-5 hrs, ice cooled water was added to the reaction mixture and it was extracted with CH₂Cl₂ (3x50 mL). The organic extract was washed with cold H₂O (2x10 mL), 5% aq. HCl (2x10 mL), 10 % NaHCO₃ (2x10 mL), brine (2x10 mL) and dried over Na₂SO₄. Solvent was evaporated under reduced pressure to afford crude product. Purification by column chromatography on silica gel (25 %, EtOAc/PE) afforded compound **54** (0.232 g, 92%) as a white crystalline solid.

mp 185-188 °C; [α]_D²⁸ + 20.78 (CHCl₃, *c* 0.56); IR (cm⁻¹) 3678, 1746, 1735; ¹H NMR (200 MHz, CDCl₃) δ 0.66 (s, 3H), 0.90 (s, 3H), 0.95 (d, *J* = 6.0 Hz, 3H), 2.02 (s, 3H), 2.04 (s, 3H), 3.64 (s, 3H), 3.98 (bs, 1H), 4.56 (m, 1H), 4.87 (bs, 1H); ¹³C NMR (50 MHz, CDCl₃) δ 12.4, 17.2, 21.3, 21.4, 22.8, 22.9, 26.6, 27.2, 27.8, 28.4, 31.0, 31.2, 34.5, 34.7, 34.8, 35.0, 38.0, 40.9, 42.0, 46.5, 47.6, 51.3, 70.8, 72.5, 74.0, 170.5, 174.5.

Methyl 3 α ,7 α -diacetoxy-12-oxo-5 β -cholan-24-oate (55):

To a solution of compound **54** (0.506 g, 1 mmol) in acetone (20 mL) Jones Reagent (1 mL) was added at 5-10 °C. The reaction mixture was stirred at this temperature for 5 min. Methanol (5 mL) was added, the solvent was evaporated and the crude solid material was dissolved in EtOAc/H₂O (5:1) mixture (100 mL). The organic layer was washed with cold H₂O (2x10 mL), 10% NaHCO₃ (2x10 mL), brine (2x10 mL) and dried over Na₂SO₄. Solvent was evaporated under reduced pressure to afford crude product. Purification by column chromatography on silica gel (20%, EtOAc/PE) afforded pure compound **55** (0.49 g, 98%) as a white crystalline solid.

mp. 175-176 °C; IR (cm-1) 1737, 1730, 1701; ¹H NMR (300 MHz, CDCl₃) δ 0.86 (d, *J* = 5.8 Hz, 3H), 1.03 (s, 3H), 1.04 (s 3H), 2.02 (s, 3H), 2.03 (s, 3H), 2.52 (t, *J* = 12 Hz, 1H), 3.66 (s, 3H), 4.57 (m, 1H), 4.98 (bs, 1H); ¹³C NMR (75 MHz, CDCl₃) δ 11.4, 18.4, 21.0, 22.0, 23.6, 26.5, 27.7, 30.2, 31.1, 31.2, 34.3, 34.4, 35.4, 37.7, 37.8, 40.5, 46.4, 51.2, 53.0,

57.0, 70.4, 73.4, 169.4, 170.3, 174.2, 213.3; Anal. Calcd. for C₂₉H₄₄O₇: C, 69.02; H, 8.79. Found: C, 69.34; H, 8.57; MS (LCMS) *m/z*: 527.3 (M + 23 for Na).

Methyl 11 α -bromo-3 α ,7 α -diacetoxy-12-oxo-5 β -cholan-24-oate (56), Methyl 11 β -bromo-3 α ,7 α -diacetoxy-12-oxo-5 β -cholan-24-oate (57):

To a solution of **55** (1.008 g, 2 mmol) in benzene (10 mL), bromine solution (1 mL, 2M in benzene) was slowly added with stirring, at 30 °C in the dark. After 6 days, TLC analysis showed the total consumption of the starting material. The solvent was evaporated and the crude solid material was dissolved in EtOAc (150 mL). The organic layer was washed with 10 % Na₂S₂O₅ (2x10 mL), cold H₂O (2x10 mL), brine (2x10 mL) and dried over Na₂SO₄. Solvent was evaporated under reduced pressure to afford crude product. The residue was chromatographed on flash silica gel (10%, EtOAc/PE) to yield the β -bromo compound **57** (0.22 g, 19%), followed by α -bromo compound **56** (0.76 g, 65%).

Methyl 11 α -bromo-3 α ,7 α -diacetoxy-12-oxo-5 β -cholan-24-oate (56): mp. 183-184 °C; [α]_D²⁵ + 19.20 (CHCl₃, *c* 1.25); IR (cm⁻¹) 2937, 1739, 1730, 1697; ¹H NMR (200 MHz, CDCl₃) δ 0.93 (d, *J* = 6.6 Hz, 3H), 1.36 (s, 3H), 1.38 (s, 3H), 2.03 (s, 6H), 2.64 (dd, *J* = 11.7 & 5.9 Hz, 1H), 3.67 (s, 3H), 4.42 (d, *J* = 5.9 Hz, 1H), 4.60 (m, 1H), 5.03 (bs, 1H); ¹³C NMR (50 MHz, CDCl₃) δ 15.5, 18.1, 21.1, 21.2, 23.7, 24.6, 26.9, 27.3, 30.4, 30.6, 31.1, 33.7, 34.6, 35.6, 35.8, 36.9, 39.9, 43.8, 47.4, 51.3, 52.0, 52.2, 56.3, 70.6, 73.1, 169.6, 170.3, 174.3, 203.4; MS (LCMS) *m/z* 605.2 (M + 23 for Na).

Methyl 11 β -bromo-3 α ,7 α -diacetoxy-12-oxo-5 β -cholan-24-oate (57): mp. 202-203 °C; [α]_D²⁵ + 43.3 (CHCl₃, *c* 1.20); IR (cm⁻¹) 2962, 1743, 1731, 1712; ¹H NMR (200 MHz, CDCl₃) δ 0.85 (d, *J* = 5.8 Hz, 3H), 1.04 (s, 3H), 1.22 (s, 3H), 2.04 (s, 3H), 2.05 (s, 3H), 2.79 (dd, *J* = 10.7 Hz, 1Hz), 2.90 (dt, *J* = 15.4 Hz & 3.0 Hz, 1H), 3.66 (s, 3H), 4.64 (m, 1H), 4.97 (bs, 1H), 5.01 (d, *J* = 10.7 Hz); ¹³C NMR (50 MHz, CDCl₃) δ 10.7, 17.9, 20.8, 22.3, 23.7, 26.6, 27.5, 29.8, 30.6, 31.3, 34.5, 35.0, 36.5, 37.5, 39.5, 41.7, 46.1, 47.6, 50.8, 55.9, 57.6, 70.3, 72.9, 169.4, 170.0, 173.8, 202.3; MS (LCMS) *m/z* 605.2 (M + 23 for Na).

Methyl 11 α -azido-3 α ,7 α -diacetoxy-12-oxo-5 β -cholan-24-oate (58):

To a solution of compound **56/57** (0.1 g, 0.172 mmol) in dry DMF (5 mL) was added solid sodium azide (0.056 g, 0.86 mmol). The reaction mixture was stirred at 60 °C for 16

h and allowed to cool to room temperature. It was then poured into H₂O (50 mL) and extracted with Et₂O (3x50 mL). The organic extract was washed with cold water (2x25 mL) followed by brine (20 mL) and it was dried over Na₂SO₄. Solvent was evaporated under reduced pressure to afford crude product. Purification by column chromatography on silica gel (10% EtOAc/PE) afforded compound **58** (0.092 g, 98%) as a white crystalline solid.

mp. 213 °C; $[\alpha]_D^{28} + 61.68$ (CHCl₃, *c* 1.07); IR (cm⁻¹) 2922, 2108, 1740, 1722; ¹H NMR (200 MHz, CDCl₃) δ 0.88 (d, *J* = 6.4 Hz, 3H), 1.02 (s, 3H), 1.15 (s, 3H), 2.02 (s, 3H), 2.04 (s, 3H), 2.48 (dt, *J* = 14.6 Hz & 3.0 Hz, 1H), 3.66 (s, 3H), 4.06 (d, *J* = 10.8 Hz, 1H), 4.58 (m, 1H), 4.96 (bs, 1H); ¹³C NMR (50 MHz, CDCl₃) δ 10.7, 18.3, 21.2, 21.2, 22.7, 23.9, 27.0, 27.4, 30.1, 30.9, 31.4, 35.2, 35.2, 37.0, 37.2, 37.9, 41.6, 42.9, 47.0, 51.3, 51.7, 56.1, 64.4, 70.4, 73.4, 169.8, 170.6, 174.1, 207.0; Anal. Calcd. for C₂₉H₄₃N₃O₇ C, 63.81; H, 7.96; N, 7.70 Found: C, 63.68; H, 7.91; N, 7.63.

Synthesis of Dimeric compounds (59-65):

General procedure for cycloaddition:

Method 1: A solution of azide (1.3 mmol) and propargyl ester of bile acid (1 mmol) in *t*-BuOH (10 mL) was stirred at 60 °C for 15 min. CuSO₄·5H₂O (5mol% in 0.5 mL of water) and sodium ascorbate (20 mol% in 0.5 mL of water) were added to the reaction mixture and it was stirred at 60-65 °C for 3-12 h. The solvent was evaporated under reduced pressure to afford a crude product, which on purification by column chromatography on silica gel gave pure dimeric compounds containing 1,2,3-triazole moiety in 92-96% yield.

Method 2: The alkyne (1 mmol) and the azide (1.3 mmol) were dissolved in DMF/H₂O 4:1 (10 mL). To this solution CuSO₄·5H₂O (5 mol%) and sodium ascorbate (40 mol%) were added. The reaction mixture was placed in a domestic microwave reactor and irradiated for 5 min at 415 W. The reaction mixture was cooled, ice was added and it was then extracted with EtOAc. The extract was washed with water and brine. Solvent was evaporated under reduced pressure and crude product was purified by column chromatography on silica gel using 5% MeOH/CH₂Cl₂ system to obtain dimers (90-96 %).

Dimeric compound (59): Yield: 96%; mp 136-138 °C; $[\alpha]_D^{31} = + 9.84$ (CHCl₃, *c* 0.61); IR (cm⁻¹) 3419, 1728; ¹H NMR (200 MHz, CDCl₃) δ 0.65 (s, 3H), 0.66 (s, 3H), 0.90-0.98

(12H), 3.59 (m, 2H), 3.96 (bs, 2H), 4.31 (t, $J = 7.1$ Hz, 2H, OCH₂), 5.21 (s, 2H), 7.60 (s, 1H, triazole H); ¹³C NMR (75 MHz, CDCl₃) δ 12.3, 17.1, 17.4, 23.0, 23.6, 26.0, 26.9, 27.1, 27.5, 28.4, 30.2, 30.6, 31.0, 32.4, 33.3, 33.9, 35.1, 35.8, 36.1, 42.0, 46.3, 46.8, 47.9, 50.7, 57.3, 60.3, 63.5, 71.4, 72.9, 123.6, 142.7, 174.1; Anal. Calcd for C₅₁H₈₃N₃O₆: C, 73.43, H, 10.03, N, 5.04. Found: C, 73.11, H, 9.82, N, 4.82; MS (LCMS) m/z 834.7 (M + 1), 856.7 (M + Na).

Dimeric compound (60): White solid, Yield: 93%; mp 148-150 °C; $[\alpha]_D^{25} = + 33.2$ (CHCl₃, c 0.73); IR (cm⁻¹): 3396, 1728 cm⁻¹; ¹H NMR (200 MHz, CDCl₃): δ 0.64 (s, 3H), 0.66 (s, 3H), 0.88 (s, 6H), 0.96 - 0.98 (6H), 3.41 (m, 2H), 3.82 (bs, 2H) 3.93 (bs, 2H), 4.34 (bs, 2H), 5.12-5.31 (dd, $J = 12.5$ and 24.0 Hz, 2H, OCH₂), 7.66 (s, 1H, triazole H); ¹³C NMR (100 MHz, CDCl₃): δ 12.0, 16.8, 17.1, 22.1, 22.8, 25.9, 26.5, 27.2, 27.7, 29.3, 29.6, 30.5, 30.9, 32.1, 34.2, 34.4, 34.9, 35.0, 38.9, 39.0, 41.2, 46.0, 46.4, 46.5, 47.9, 48.2, 48.4, 48.6, 48.8, 49.0, 49.2, 50.6, 54.8, 57.0, 68.0, 71.3, 72.7, 123.6, 142.4, 174.1; Anal. Calcd for C₅₁H₈₃N₃O₈: C, 70.71; H, 9.66; N, 4.85; Found: C, 70.35; H, 10.01; N, 4.63; MS (LCMS) m/z : 867.4 (M + 1), 889.4 (M + 23 for Na).

Dimeric compound (61): Yield: 92%; mp 100-102 °C; $[\alpha]_D^{31} = +11.0$ (CHCl₃, c 0.6); IR (cm⁻¹) 3431, 1728; ¹H NMR (200 MHz, CDCl₃) δ = 0.66 (s, 3H), 0.70 (s, 3H), 0.91-1.00 (12H), 3.61 (m, 1H), 3.66 (s, 3H, OCH₃), 3.96 (bs, 1H), 4.02 (bs, 1H), 4.47 (m, 1H), 5.20 (s, 2H), 7.68 (s, 1H, triazole H); ¹³C NMR (50 MHz, CDCl₃) δ = 12.6, 17.2, 23.0, 23.1, 23.6, 25.9, 26.1, 26.8, 27.0, 27.4, 27.9, 28.6, 30.3, 30.6, 30.8, 31.1, 33.5, 33.6, 33.8, 34.0, 34.2, 35.1, 35.6, 35.9, 36.3, 42.0, 42.6, 46.4, 46.5, 47.0, 47.2, 47.9, 48.2, 51.4, 57.5, 61.0, 71.6, 72.9, 122.1, 142.2, 174.1, 174.6; MS (LCMS) m/z 862.8 (M + 1), 884.8 (M + Na); Anal. Calcd for C₅₂H₈₃N₃O₇: C, 72.44, H, 9.70, N, 4.87. Found: C, 72.17, H, 10.02, N, 4.60.

Dimeric compound (62): White solid, Yield: 92%; mp 147-149 °C; $[\alpha]_D^{25} = + 38.5$ (CHCl₃, c 0.83); IR (cm⁻¹): 3433, 1731; ¹H NMR (200 MHz, CDCl₃): δ 0.63 (s, 3H), 0.69 (s, 3H), 0.86-0.97 (12 H), 3.53 (bs, 1H + OH), 3.65 (s, 3H, OCH₃), 3.84-3.86 (bs, 2H), 3.94 (bs, 1H), 4.00 (bs, 1H), 4.34 (m, 1H), 5.15 (bs, 2H), 7.83 (s, 1H, triazole H); ¹³C NMR (100 MHz, CDCl₃): δ 12.2, 12.3, 17.1, 22.3, 22.3, 22.5, 23.0, 26.1, 26.4, 27.4, 28.0, 29.5, 30.0, 30.5, 30.7, 30.8, 30.9, 34.2, 34.4, 34.5, 34.7, 35.2, 35.6, 36.2, 39.3, 41.4, 41.6,

41.9, 46.2, 46.3, 46.4, 46.7, 46.9, 51.4, 57.4, 61.1, 67.7, 67.8, 68.2, 71.6, 72.8, 121.8, 141.9, 174.2, 174.8; Anal. Calcd for $C_{52}H_{83}N_3O_9$: C, 69.84; H, 9.36; N, 4.70; Found: C, 69.93; H, 9.42; N, 4.61; MS (LCMS) m/z : 916.94 ($M + 23$ for Na).

Dimeric compound (63): White solid, Yield: 94%; mp 119-120 °C; $[\alpha]_D^{25} = + 42.1$ ($CHCl_3$, c 1.47); IR (cm^{-1}): 3402, 1728; 1H NMR (200 MHz, $CDCl_3$): δ 0.65 (s, 3H), 0.69 (s, 3H), 0.90 (s, 6H), 0.96-0.99 (m, 6H), 3.62 (m, 1H), 3.67 (s, 3H, OCH_3), 3.96 (bs, 1H), 4.02 (s, 1H), 4.68 (bs, 1H), 5.23 (s, 2H), 7.71 (s, 1H, triazole H); ^{13}C NMR (100 MHz, $CDCl_3$): δ 12.4, 12.5, 16.9, 17.0, 22.9, 23.3, 23.4, 23.5, 24.5, 25.6, 25.9, 26.1, 26.9, 27.2, 28.4, 28.5, 29.5, 30.3, 30.5, 30.6, 30.8, 30.9, 33.2, 33.8, 34.1, 34.8, 34.9, 35.0, 35.5, 35.7, 36.0, 37.0, 41.8, 46.2, 46.9, 47.9, 51.3, 56.7, 57.3, 71.2, 72.6, 123.0, 142.0, 174.0, 174.5; Anal. Calcd for $C_{52}H_{83}N_3O_7$: C, 72.43; H, 9.70; N, 4.87; Found: C, 72.10; H, 9.58; N, 4.72; MS (LCMS) m/z : 863.8 ($M + 1$), 885.8 ($M + 23$ for Na).

Dimeric compound (64): White solid, Yield: 90%; mp 138-141 °C; $[\alpha]_D^{25} = + 28.3$ ($CHCl_3$, c 1.27); IR (cm^{-1}): 3402, 1728; 1H NMR (200 MHz, $CDCl_3$): δ 0.63 (s, 3H), 0.68 (s, 3H), 0.87 (s, 6 H), 0.96-1.00 (6 H), 3.26 (bs, OH), 3.46 (bs, 1H), 3.66 (s, 3H, OCH_3), 3.84-3.99 (4H), 4.72 (bs, 1H), 5.22 (s, 2H), 7.79 (s, 1H, triazole H); ^{13}C NMR (100 MHz, $CDCl_3$): δ 12.1, 12.2, 17.0, 17.0, 22.2, 22.5, 23.0, 24.5, 26.1, 26.2, 27.3, 28.0, 28.1, 30.9, 32.3, 33.8, 34.5, 34.7, 35.0, 36.6, 39.2, 41.3, 46.1, 46.2, 46.7, 51.3, 56.8, 57.4, 67.9, 68.0, 71.5, 72.7, 123.1, 141.9, 174.1, 174.5; Anal. Calcd for $C_{52}H_{83}N_3O_9$: C, 69.84; H, 9.36; N, 4.70; Found: C, 69.56; H, 8.98; N, 4.82; MS (LCMS) m/z : 895.54 ($M + 1$), 917.57 ($M + 23$ for Na).

Dimeric compound (65): Yield: 92%; mp 156-157 °C; $[\alpha]_D^{31} = + 20.0$ ($CHCl_3$, c 0.61); IR (cm^{-1}) 3411, 1728, 1674; 1H NMR (200 MHz, $CDCl_3$) δ 0.67 (s, 3H), 0.73 (d, $J = 5.9$ Hz, 3H), 0.89 (s, 3H), 0.96 (d, $J = 5.69$ Hz, 3H), 1.18 (s, 3H), 1.27 (s, 3H), 2.00 (s, 3H), 2.10 (s, 3H), 3.45 (m, 1H), 3.66 (s, 3H, OCH_3), 3.84 (bs, 1H), 3.96 (bs, 1H), 3.40 (m, 1H), 5.02 (bs, 1H) 5.24 (d, $J = 2.0$ Hz, 2H, OCH_2), 5.91 (d, $J = 9.9$ Hz, C-11 H attached to triazole), 7.83 (s, 1H, triazole H); ^{13}C NMR (75 MHz, $CDCl_3$) δ 11.2, 12.4, 17.2, 18.4, 21.2, 21.3, 22.5, 23.2, 24.0, 26.5, 27.1, 27.4, 28.2, 29.5, 30.1, 30.3, 30.8, 30.9, 31.0, 31.2, 34.6, 34.7, 35.1, 35.2, 35.4, 37.4, 38.1, 39.6, 41.5, 41.7, 42.2, 44.2, 46.5, 46.8, 47.4, 51.4, 52.4, 56.5, 57.4, 65.7, 68.3, 70.4, 71.9, 72.9, 73.2, 126.0, 142.7, 169.8, 170.5, 174.0,

174.3, 204.1; Anal. Calcd for C₅₆H₈₅N₃O₁₂: C, 67.78; H, 8.63; N, 4.23. Found: C, 67.43; H, 8.71; N, 3.97; MS (LCMS) *m/z* 992.7 (M + 1), 1014.7 (M + Na).

Propargyl -3 α -mesyloxy-12 α -hydroxy-5 β -cholane-24-oate (66):

Compound **66** was prepared from compound **34** by using similar procedure as used for the preparation of compound **40**.

White solid, yield 90%; mp 71-73 °C; IR (cm⁻¹): 3430, 3305, 1730; ¹H NMR (CDCl₃, 200 MHz): δ 0.67 (s, 3H), 0.91 (s, 3H), 0.96 (d, 3H, *J* = 6.1 Hz), 2.47 (t, *J* = 2.5 Hz, 1H), 2.99 (s, 3H), 3.98 (bs, 1H), 4.64 (m, 1H), 4.66 (d, *J* = 2.4 Hz, 2H); ¹³C NMR (CDCl₃, 50 MHz): δ 12.6, 17.6, 22.8, 23.5, 25.8, 26.7, 27.3, 27.6, 28.5, 30.6, 30.9, 33.2, 33.4, 33.8, 34.7, 34.8, 35.8, 38.7, 42.0, 46.4, 47.1, 48.0, 51.6, 72.8, 74.7, 77.7, 82.6, 173.2; Anal. Calcd for C₂₈H₄₄O₆S: C, 66.11; H, 8.72; S, 6.30; Found: C, 65.88; H, 8.42; S, 6.03; MS (LCMS) *m/z*: 509.27 (M + 1), 631.32 (M + 23 for Na).

Propargyl -3 β -azido-12 α -hydroxy-5 β -cholane-24-oate (67):

Compound **66** was reacted with NaN₃ (3 equiv.) in DMF for 4 h at 80-90 °C to give compound **67**.

White solid, yield 90%; mp 135-138 °C; [α]_D²⁶ (CHCl₃, c 0.9) = + 39.34; IR (cm⁻¹): 1731, 2100, 3307; ¹H NMR (CDCl₃, 200 MHz): δ 0.69 (s, 3H), 0.95 (s, 3H), 0.97 (d, 3H, *J* = 6.2 Hz), 2.47 (t, *J* = 2.5 Hz, 1H), 3.95 (bs, 1H), 3.99 (bs, 1H), 4.68 (d, *J* = 2.4 Hz, 2H); ¹³C NMR (CDCl₃, 50 MHz): δ 12.7, 17.3, 23.4, 23.5, 24.5, 25.9, 26.4, 27.4, 28.7, 30.1, 30.5, 30.7, 31.0, 33.2, 34.4, 35.0, 35.8, 37.2, 46.5, 47.3, 48.3, 51.7, 58.7, 73.1, 74.7, 77.7, 173.2; Anal. Calcd for C₂₇H₄₁N₃O₃: C, 71.17; H, 9.07; N, 9.22; Found: C, 69.92; H, 8.83; N, 9.08; MS (LCMS) *m/z*: 478.21 (M + 23 for Na).

Propargyl -3,12 diketo-5 β -cholane-24-oate (69):

Compound **69** was synthesized from compound **34** using the procedure reported for compound **55**.

White solid, yield 96%; mp 156-158 °C; [α]_D²⁷ (CHCl₃, c 3.9) = + 48.77; IR (cm⁻¹): 1699, 1737, 3307; ¹H NMR (CDCl₃, 200 MHz): δ 0.85 (d, 3H, *J* = 6.5 Hz), 1.05 (s, 3H), 1.11 (s, 3H), 2.47 (t, *J* = 2.4 Hz, 1H), 4.67 (d, *J* = 2.5 Hz, 2H); ¹³C NMR (CDCl₃, 50 MHz): δ 11.4, 18.3, 21.8, 24.0, 25.1, 26.3, 27.2, 30.03, 30.9, 35.1, 35.2, 35.3, 36.4, 36.5, 38.0, 41.8, 43.4, 43.8, 46.2, 51.4, 57.2, 58.1, 74.5, 77.6, 172.8, 211.7, 213.7; Anal. Calcd for

$C_{27}H_{38}O_4$: C, 76.02; H, 8.98; Found: C, 75.81; H, 9.02; MS (LCMS) m/z : 427.24 (M + 1), 449.26 (M + 23 for Na).

Synthesis of Propargyl -3 β -oxirane-12keto-5 β -cholane-24-oate (70):

To a solution of trimethylsulfoxonium iodide (0.21 g, 1 mmol) in dry DMSO (5 mL) was added NaH (0.048 g, 2 mmol). After 1h, compound **69** (0.213 g, 0.5 mmol) was added to the reaction mixture. The reaction mixture was allowed to stir for 5h. Reaction was monitored by TLC (5% Methanol/DCM). Ice was added to the reaction mixture and the product was extracted with ethyl acetate (2 \times 50 mL). The organic layer was washed with water (4 \times 10 mL) and then with brine solution. Extract was dried over sodium sulfate. Solvent was removed under reduced pressure and the product was purified by column chromatography (4% Methanol/DCM) to get pure compound **70** (0.201 g).

White solid, yield 91%; mp 179-181 °C; IR (cm^{-1}): 1699, 1733, 3307; 1H NMR ($CDCl_3$, 200 MHz): δ 0.84 (d, 3H, $J = 6.4$ Hz), 1.03 (s, 3H), 1.08 (s, 3H), 2.47 (t, $J = 2.5$ Hz, 1H), 2.61 and 2.62 (two d, $J = 4.7$ Hz, 2H, oxirane CH_2), 4.67 (d, $J = 2.5$ Hz, 2H); ^{13}C NMR ($CDCl_3$, 50 MHz): δ 11.5, 18.4, 22.7, 24.2, 25.7, 26.3, 27.4, 27.7, 30.2, 30.1, 33.3, 33.9, 35.3, 35.4, 35.4, 38.3, 40.1, 43.7, 46.3, 51.6, 53.4, 57.4, 58.6, 58.7, 74.6, 77.7, 173.1, 214.6; Anal. Calcd for $C_{28}H_{40}O_4$: C, 76.33; H, 9.15; Found: C, 76.50; H, 9.41; MS (LCMS) m/z : 463.24 (M + 23 for Na).

Propargyl (3 α -azidomethane)-3 β -hydroxy-12keto-5 β -cholane-24-oate (71):

To a solution of **70** (0.220 g, 0.5 mmol) in dry DMF (10 mL), sodium azide (0.100 g, 1.5 mmol) was added and stirring was continued at 60-65 °C for 3h. The reaction mixture was allowed to cool to room temperature. It was then poured into ice-cold water (30 mL) and extracted with EtOAc. The organic extract was washed with cold water and brine. Solvent was evaporated under reduced pressure to afford crude product **71** which was purified by column chromatography on silica gel (10% EtOAc/hexane) to produce pure compound **71** as white solid (0.217 g).

White solid, yield 90%; mp 213-215 °C; IR (cm^{-1}): 1703, 1739, 2102, 3305; 1H NMR ($CDCl_3$, 200 MHz): δ 0.84 (d, 3H, $J = 6.5$ Hz), 1.01 (s, 3H), 1.05 (s, 3H), 2.47 (t, $J = 2.5$ Hz, 1H), 3.22 (s, 2H, CH_2), 4.67 (d, $J = 2.5$ Hz, 2H); MS (LCMS) m/z : 506.26 (M + 23 for Na).

3,12-Diketo-24-azido-5 β -cholane (73):

Compound **73** was synthesized from compound **44** by Jones oxidation using the procedure reported for compound **55**.

White solid, yield 96%; mp 173-175 °C; IR (cm⁻¹): 1704, 2096; ¹H NMR (CDCl₃, 200 MHz): δ 0.86 (d, J = 6.6 Hz, 3H), 1.06 (s, 3H), 1.11 (s, 3H), 3.24 (t, J = 6.6 Hz, 2H); ¹³C NMR (CDCl₃, 50 MHz): δ 11.6, 18.8, 22.0, 24.2, 25.3, 25.8, 26.5, 27.5, 32.3, 35.3, 35.5, 35.7, 36.7, 36.8, 38.2, 42.0, 43.6, 44.1, 46.5, 51.7, 57.4, 58.4, 211.9, 213.9; Anal. Calcd for C₂₄H₃₇N₃O₂: C, 72.14; H, 9.33; N, 10.52; Found: C, 71.79; H, 8.96; N, 10.43; MS (LCMS) m/z : 422.57 (M + 23 for Na).

3 α -hydroxy,(3 β -pro-2-yn). 12-keto-24-azido-5 β -cholane (74):

The ketone **73** (0.400 g, 1 mmol) and propargyl bromide (1.8 mL, 3 mmol) were dissolved in a mixed solvent DMF-THF 1:1 (10 mL). To this well stirred solution, activated zinc dust (washed with 2% HCl, water and dried in vacuum) (0.196 g, 3 mmol) was slowly added at room temperature. After 5 min exothermic reaction brought itself to reflux, which was allowed to cool to 25 °C. The whole reaction mixture was then stirred for 5 h at 25 °C. Ice-cold HCl (5%) was added to the reaction mixture and it was extracted with EtOAc. The extract was washed with water and brine. Solvent was evaporated under reduced pressure to afford crude product, which was purified by column chromatography on silica gel (5% MeOH/DCM) to give compound **74** (0.381 g).

White solid, yield 87%; mp 158-161 °C; IR (cm⁻¹): 1703, 2094, 3307; ¹H NMR (CDCl₃, 200 MHz): δ 0.86 (d, J = 6.3 Hz, 3H), 1.03 (s, 3H), 1.07 (s, 3H), 2.09 (t, J = 2.8 Hz, 1H), 2.32 (d, J = 2.6 Hz, 2H), 2.51 (t, J = 6.4 Hz, 1H), 3.24 (t, J = 6.6 Hz, 2H); MS (LCMS) m/z : 462.22 (M + 23 for Na).

Compounds 76 and 77: To a solution of compound **36/37** (1 mmol) in toluene (10 mL) were added CaH₂ (0.189 g, 4.5 mmol), tetrabutylammonium bromide (0.106 g, 0.33 mmol), and ClCH₂COCl (0.26 mL, 3.3 mmol). The reaction mixture was refluxed for 3 h, cooled, and it was then extracted with EtOAc (3x25 mL). The extract was washed with water and brine. Solvent was evaporated under reduced pressure and the crude product was purified by column chromatography on silica gel (10% EtOAc/hexane) to yield compounds **76/77**.

Methyl 3 α ,7 α -bis (chloroacetoxy)-5 β -cholan-24-oate (76): White solid, Yield: 86 %; mp 120 °C; $[\alpha]_D^{25} = + 81.2$ (CHCl₃, c 1.78); IR (cm⁻¹): 1733; ¹H NMR (CDCl₃, 200 MHz): δ 0.75 (s, 3H, CH₃-18), 0.82 (d, $J = 6.1$ Hz, 3H, CH₃-21), 0.92 (s, 3H, CH₃-19), 3.66 (s, 3H), 4.03 (s, 2H), 4.08 (s, 2H), 4.79 (m, 1H), 5.19 (bs, 1H); ¹³C NMR (CDCl₃, 50 MHz): δ 12.1, 17.3, 22.8, 23.2, 25.4, 25.7, 26.2, 26.6, 27.2, 30.6, 30.7, 31.8, 33.8, 34.1, 34.4, 34.5, 35.4, 41.0, 41.1, 41.6, 45.0, 47.2, 49.2, 51.4, 76.2, 77.9, 166.4, 166.6, 174.4; Anal. Calcd for C₂₉H₄₄Cl₂O₆: C, 62.25; H, 7.93; Found: C, 62.08; H, 8.15; MS (LCMS) m/z : 559.56 (M + 1), 561.57 (M + 1), 581.55 (M + 23 for Na), 583.55 (M + 23 for Na).

Methyl 3 α ,7 α , 12 α -tris (chloroacetoxy)-5 β -cholan-24-oate (77): White solid, Yield: 78%; mp 51-52 °C; $[\alpha]_D^{25} = + 69.9$ (CHCl₃, c 1.09); IR (cm⁻¹): 1737, 1731; ¹H NMR (CDCl₃, 200 MHz): δ 0.76 (s, 3H, CH₃-18), 0.84 (d, $J = 6.1$ Hz, 3H, CH₃-21), 0.94 (s, 3H, CH₃-19), 3.66 (s, 3H), 4.03 (s, 2H), 4.07 (d, $J = 2.2$ Hz, 2H, geminal coupling), 4.10 (s, 2H), 4.67 (m, 1H), 5.05 (bs, 1H) 5.20 (bs, 1H); ¹³C NMR (CDCl₃, 50 MHz): δ 11.9, 17.3, 22.1, 22.7, 25.0, 26.3, 26.9, 28.3 30.5, 30.6, 31.0, 34.1, 34.2, 34.3, 34.4, 37.7, 40.4, 40.9, 41.0, 42.7, 45.0, 47.0, 51.3, 72.9, 75.7, 77.1, 166.1, 166.4, 166.6, 174.2; Anal. Calcd for C₃₁H₄₅Cl₃O₈: C, 57.10; H, 6.96; Found: C, 56.87; H, 6.79; MS (LCMS) m/z : 675.48 (M + 23 for Na), 677.48 (M + 23 for Na).

Compounds 78 and 79: To a solution of **76/77** (1 mmol) in dry DMF (10 mL) sodium azide (0.390 g, 6 mmol) was added and stirring was continued at 75 °C for 12 h. The reaction mixture was allowed to cool to room temperature. It was then poured into ice-cold water (30 mL) and extracted with EtOAc. The organic extract was washed with cold water and brine. Solvent was evaporated under reduced pressure to afford crude product which on purification by column chromatography on silica gel (10% EtOAc/hexane) obtained pure compound **78/79**.

Methyl 3 α ,7 α -bis (azidoacetoxy)-5 β -cholan-24-oate (78): White solid, Yield: 82%; mp 93-95 °C; $[\alpha]_D^{25} = + 89.8$ (CHCl₃, c 2.56); IR (cm⁻¹): 2108, 1743, 1718; ¹H NMR (CDCl₃, 200 MHz): δ 0.76 (s, 3H, CH₃-18), 0.82 (d, $J = 6.1$ Hz, 3H, CH₃-21), 0.93 (s, 3H, CH₃-19), 3.66 (s, 3H), 3.84 (s, 2H), 3.89 (d, $J = 1.9$ Hz, 2H, geminal coupling), 4.83 (m, 1H), 5.26 (bs, 1H); ¹³C NMR (CDCl₃, 50 MHz): δ 12.1, 17.4, 22.7, 23.2, 25.5, 25.6, 26.3, 26.5, 27.1, 30.5, 30.7, 31.7, 33.8, 34.1, 34.4, 34.5, 35.3, 41.5, 44.9, 47.4, 49.3, 50.3, 50.7, 51.3,

75.7, 77.7, 167.3, 167.6, 174.3; Anal. Calcd for C₂₉H₄₄N₆O₆: C, 60.82; H, 7.74; N, 14.67; Found: C, 60.98; H, 7.53; N, 14.58; MS (LCMS) *m/z*: 595.60 (M + 23 for Na).

Methyl 3 α ,7 α ,12 α -tris (azidoacetoxy)-5 β -cholan-24-oate (79): Gum, Yield: 79%; $[\alpha]_D^{25} = +71.29$ (CHCl₃, c 1.01); IR (cm⁻¹): 2108, 1739; ¹H NMR (CDCl₃, 200 MHz): δ 0.77 (s, 3H, CH₃-18), 0.82 (d, *J* = 6.2 Hz, 3H, CH₃-21), 0.96 (s, 3H, CH₃-19), 3.66 (s, 3H, OCH₃), 3.84 (bs, 4H), 3.89 (d, *J* = 3.8 Hz, 2H, geminal coupling), 4.71 (m, 1H), 5.08 (bs, 1H), 5.27 (bs, 1H); ¹³C NMR (CDCl₃, 50 MHz): δ 11.7, 17.2, 22.0, 22.4, 25.1, 26.2, 26.7, 28.6, 30.3, 30.4, 30.8, 33.9, 34.0, 34.2, 37.4, 40.2, 43.0, 44.8, 47.0, 50.1, 50.4, 50.5, 51.2, 72.5, 75.1, 76.8, 167.2, 167.3, 167.4, 174.0; Anal. Calcd for C₃₁H₄₅N₉O₈: C, 55.43; H, 6.75; N, 18.77; Found: C, 55.05; H, 6.38; N, 18.39; MS (LCMS) *m/z*: 694.76 (M + 23 for Na).

Trimeric compound (80):

Trimer **80** was synthesized from azide **78** (0.772 g, 1 mmol) and terminal alkyne **34** (0.947 g, 2.2 mmol) using general procedure B and was purified by column chromatography on silica gel (5% MeOH/CH₂Cl₂) to give pure trimer **80** (1.217 g).

White solid, Yield: 85%; mp 139-142 °C; $[\alpha]_D^{25} = +69.3$ (CHCl₃, c 0.66); IR (cm⁻¹): 3498, 1737, 1731; ¹H NMR (CDCl₃, 400 MHz): δ 0.65-0.68 (bs, 6H), 0.72 (bs, 3H), 0.81-0.94 (m, 18H), 3.60 (m, 2H), 3.68 (s, 3H, OCH₃), 3.96 (bs, 2H), 4.78 (m, 1H, CH-3), 5.20-5.28 (m, 9H), 7.82 (bs, 1H, Triazole H), 7.90 (bs, 1H, Triazole H); ¹³C NMR (CDCl₃, 100 MHz): δ 12.2, 12.6, 12.7, 17.2, 17.7, 22.7, 23.1, 23.3, 23.6, 25.3, 25.9, 26.1, 26.6, 27.1, 27.2, 27.5, 28.6, 30.4, 30.7, 30.9, 31.1, 31.7, 31.8, 33.6, 33.9, 34.0, 35.5, 34.6, 35.1, 35.2, 35.4, 36.0, 36.4, 41.5, 41.8, 42.1, 45.1, 46.5, 47.1, 47.2, 47.4, 48.2, 49.3, 51.2, 51.3, 51.5, 57.3, 57.4, 71.7, 73.0, 74.0, 77.2, 78.5, 125.2, 125.4, 143.2, 143.3, 165.2, 165.9, 174.0, 174.1, 174.6; MALDI-TOF *m/z*: 1457.06 (M + 23 for Na) Calcd for C₈₃H₁₂₈N₆O₁₄, 1433.94.

Tetrameric compound (81):

Tetramer **81** was synthesized from azide **79** (0.671 g, 1 mmol) and terminal alkyne **35** (1.472 g, 3.3 mmol) using general procedure B to give crude compound which was purified by column chromatography on silica gel (5% MeOH/CH₂Cl₂) to give pure tetramer **81** (1.648 g).

White solid, Yield: 82%; mp 164-168 °C; $[\alpha]_D^{25} = +45.6$ (CHCl₃, c 0.48); IR (cm⁻¹): 3388, 1735, 1730; ¹H NMR (CDCl₃, 500 MHz): δ 0.62-0.77 (bs, 12H), 0.85-0.93 (m, 24H), 3.39 (bs, 3H), 3.68 (s, 3H, OCH₃), 3.80 (bs, 3H), 3.92 (bs, 3H), 4.58 (m, 1H, CH-3), 5.03 (bs, 1H), 5.10 (bs, 1H), 5.19-5.60 (m, 12H), 8.00-8.01 (bs, 3H, Triazole H); ¹³C NMR (CDCl₃, 125 MHz): δ 11.9, 12.4, 14.1, 17.2, 17.5, 20.9, 22.3, 22.4, 22.8, 23.2, 25.1, 26.4, 26.5, 27.0, 27.5, 28.1, 28.4, 30.3, 30.6, 30.7, 30.9, 31.0, 31.2, 34.2, 34.3, 34.5, 34.6, 34.7, 35.1, 35.4, 37.8, 39.5, 40.6, 41.5, 41.6, 42.5, 45.2, 46.4, 46.5, 46.6, 46.7, 47.3, 51.2, 51.5, 57.1, 57.3, 57.4, 57.5, 60.3, 68.3, 71.8, 72.9, 73.2, 76.2, 77.67, 125.5, 125.7, 125.8, 143.0, 143.1, 143.2, 165.5, 165.8, 166.2, 171.0, 174.1, 174.2, 174.4; MALDI-TOF *m/z*: 2035.41 (M + 23 for Na) Calcd for C₁₁₂H₁₇₁N₉O₂₃, 2011.60.

1.7 Selected Spectra

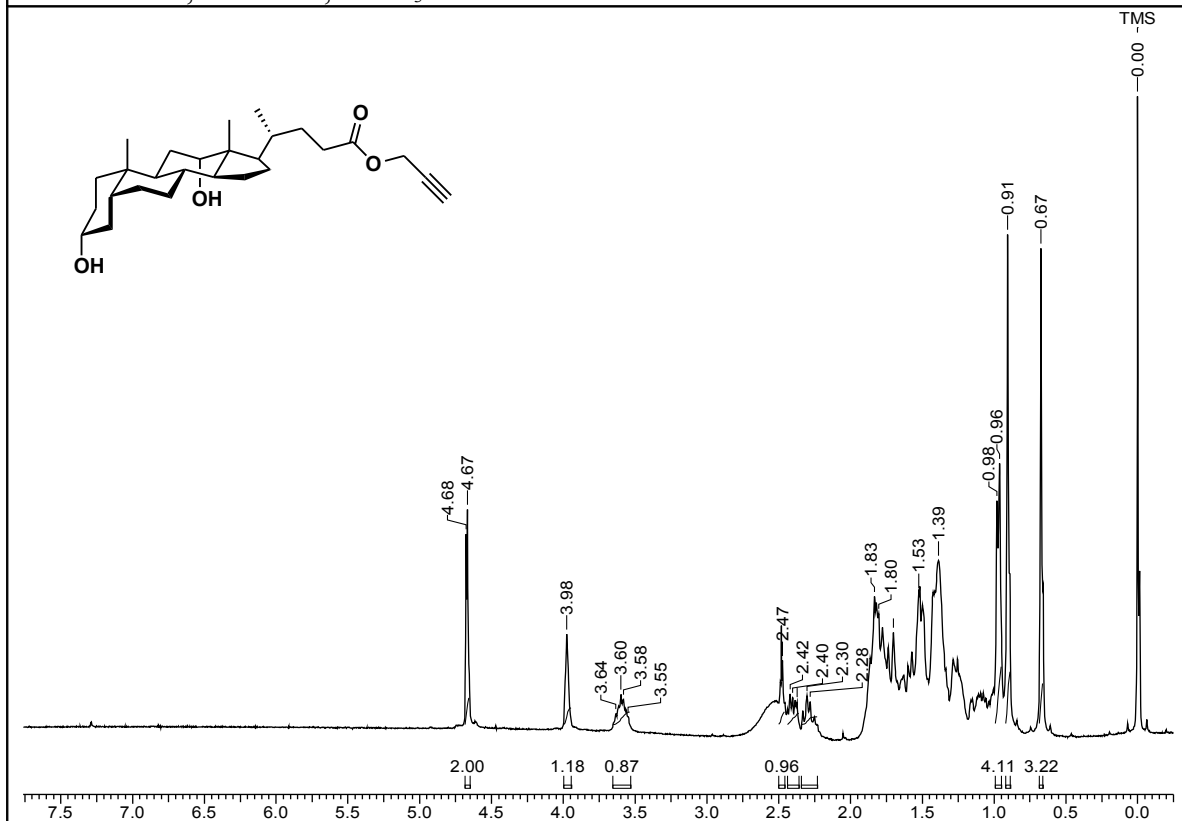
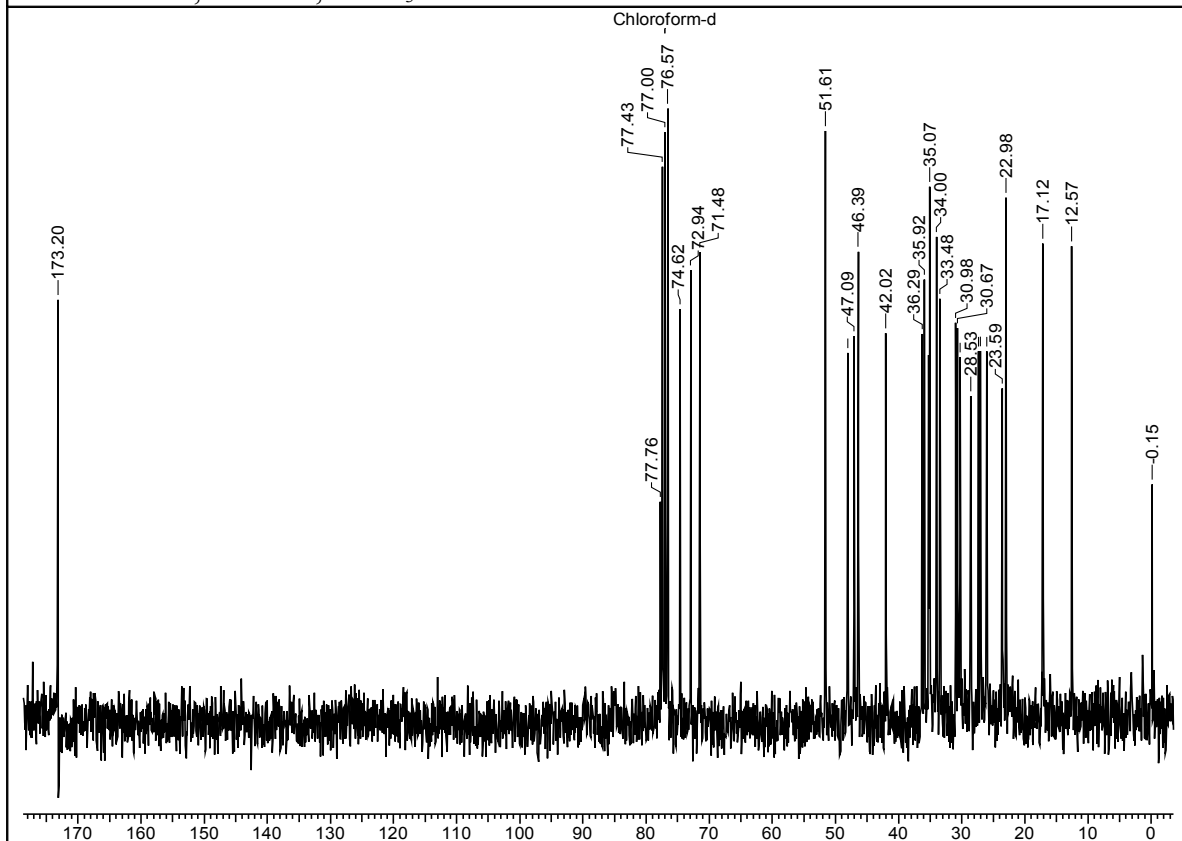
34: ^1H NMR, 300 MHz, CDCl_3 34: ^{13}C NMR, 75 MHz, CDCl_3 

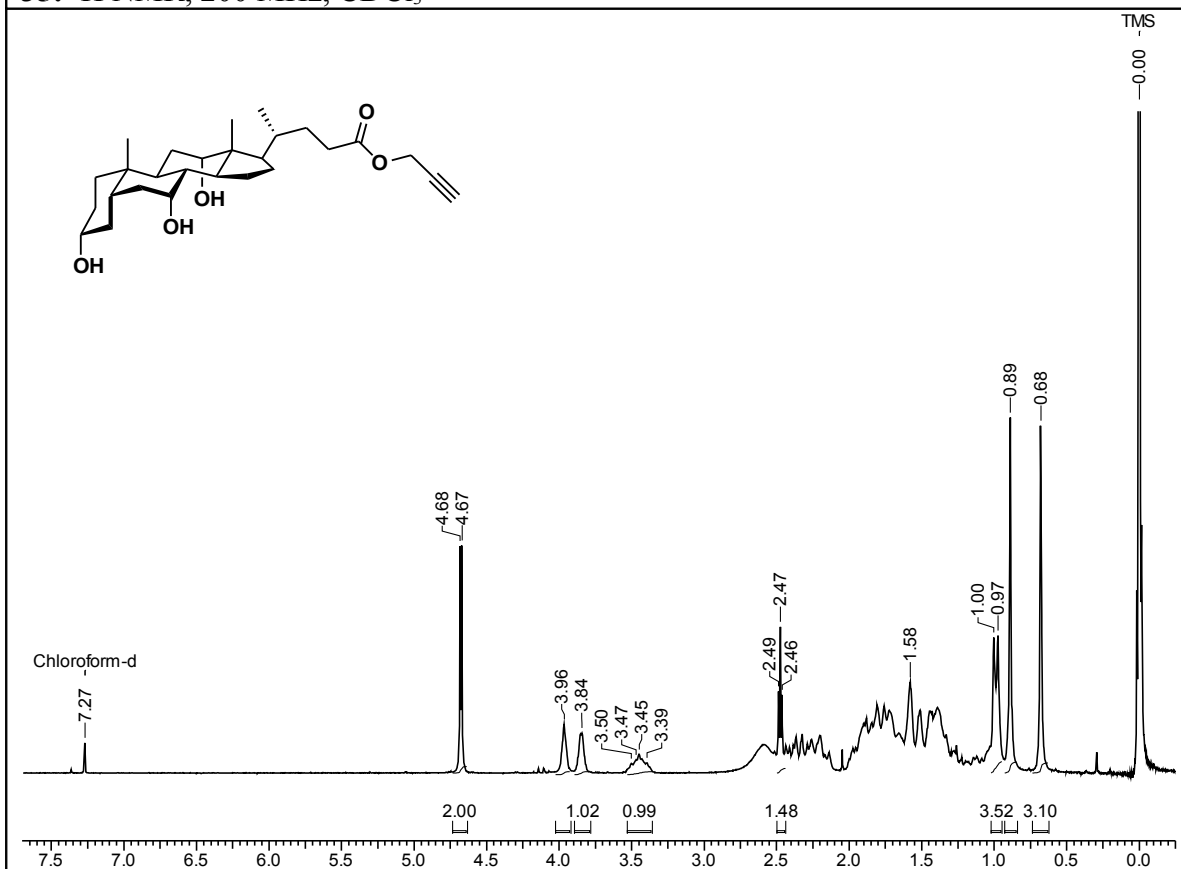
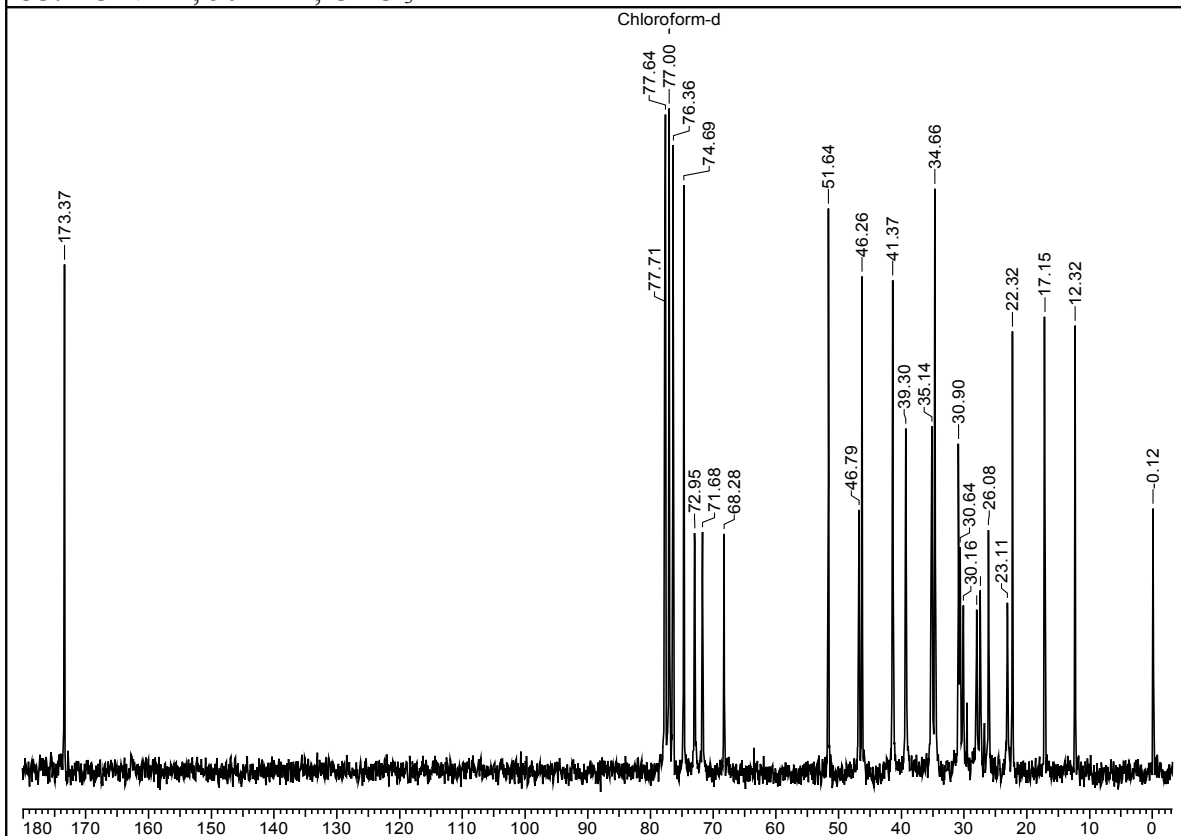
35: ^1H NMR, 200 MHz, CDCl_3 **35:** ^{13}C NMR, 50 MHz, CDCl_3 

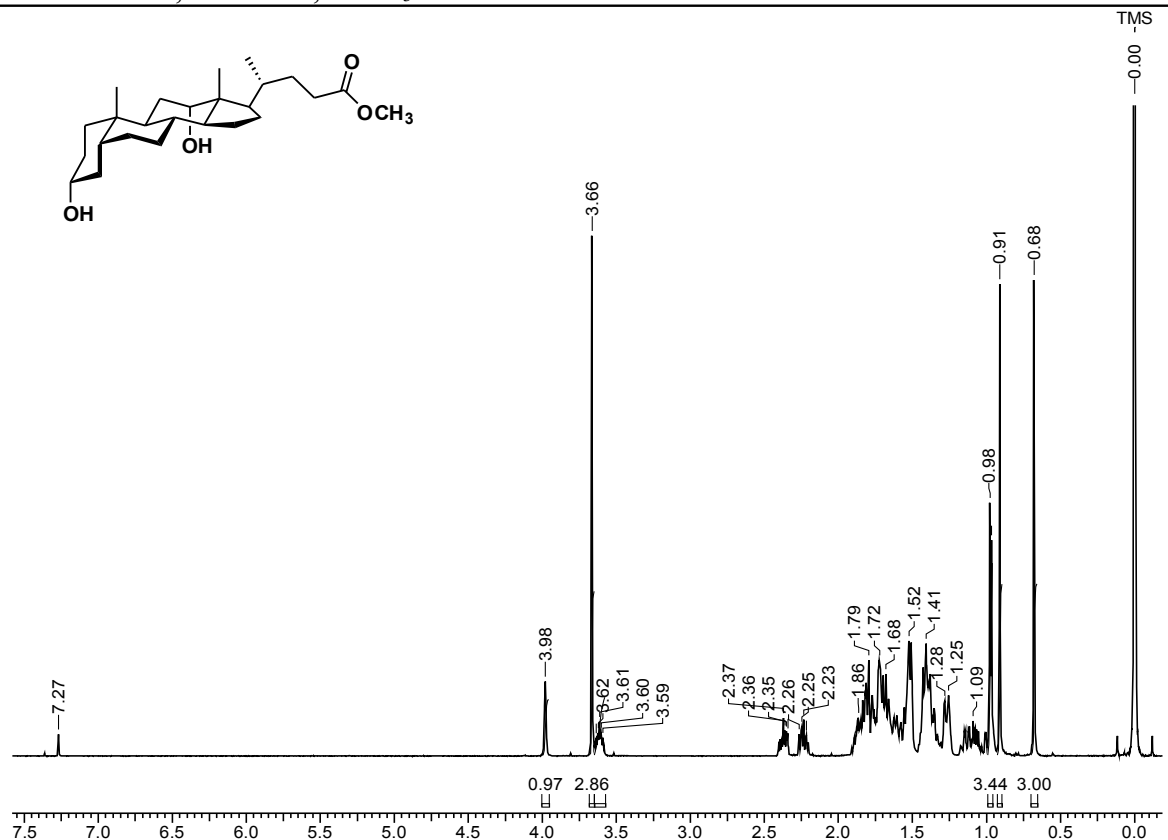
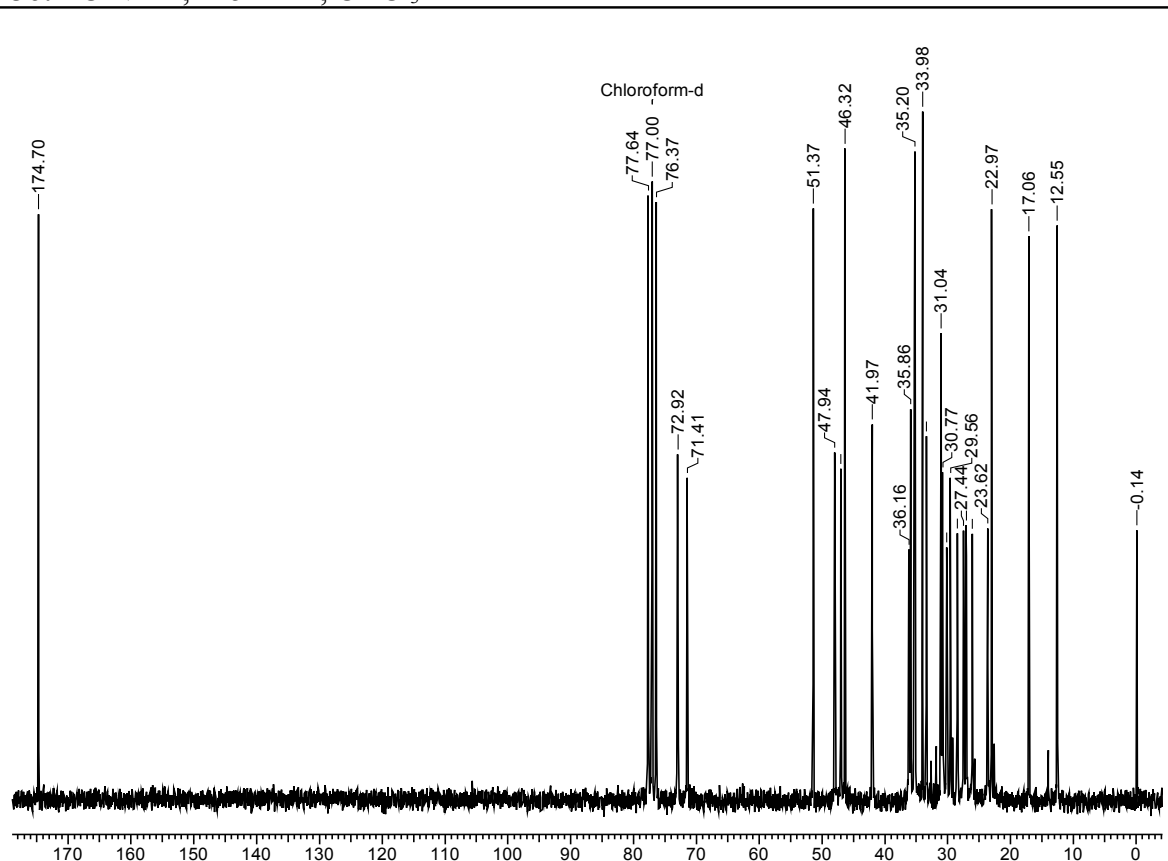
36: ^1H NMR, 500 MHz, CDCl_3 **36:** ^{13}C NMR, 125 MHz, CDCl_3 

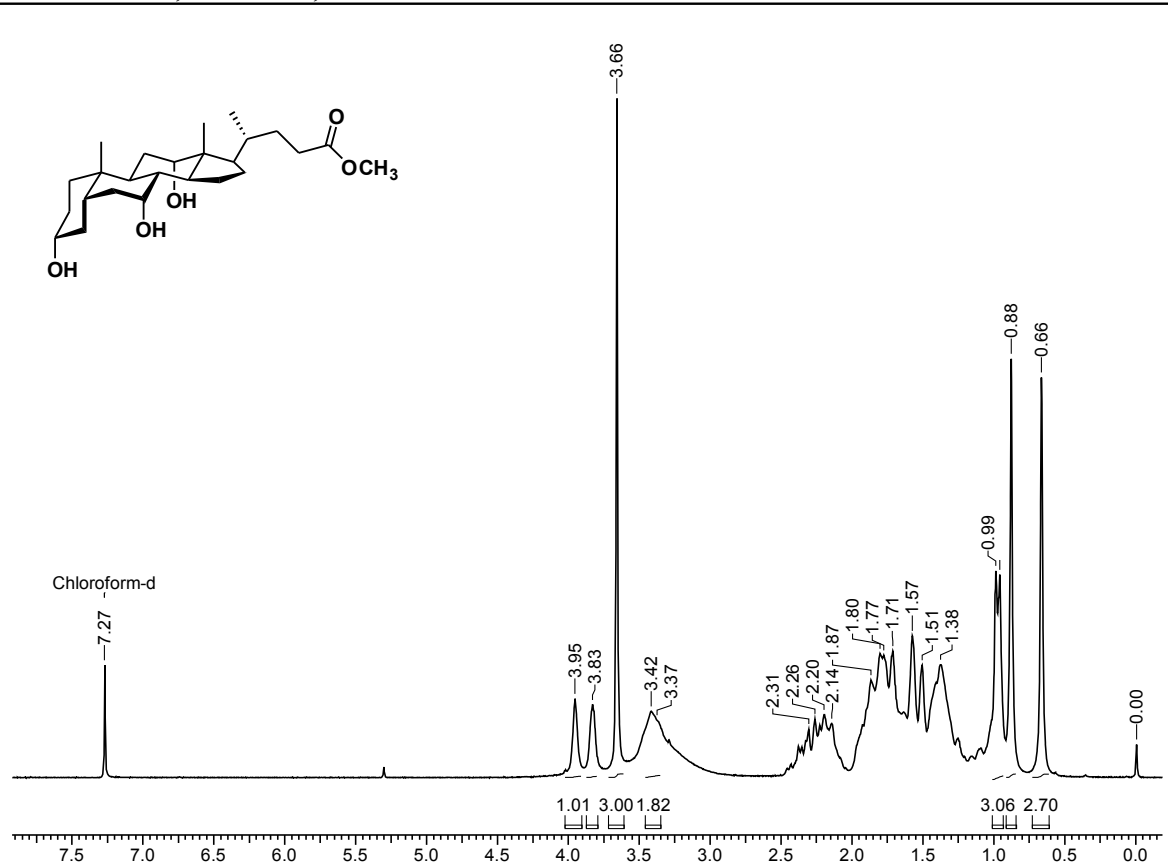
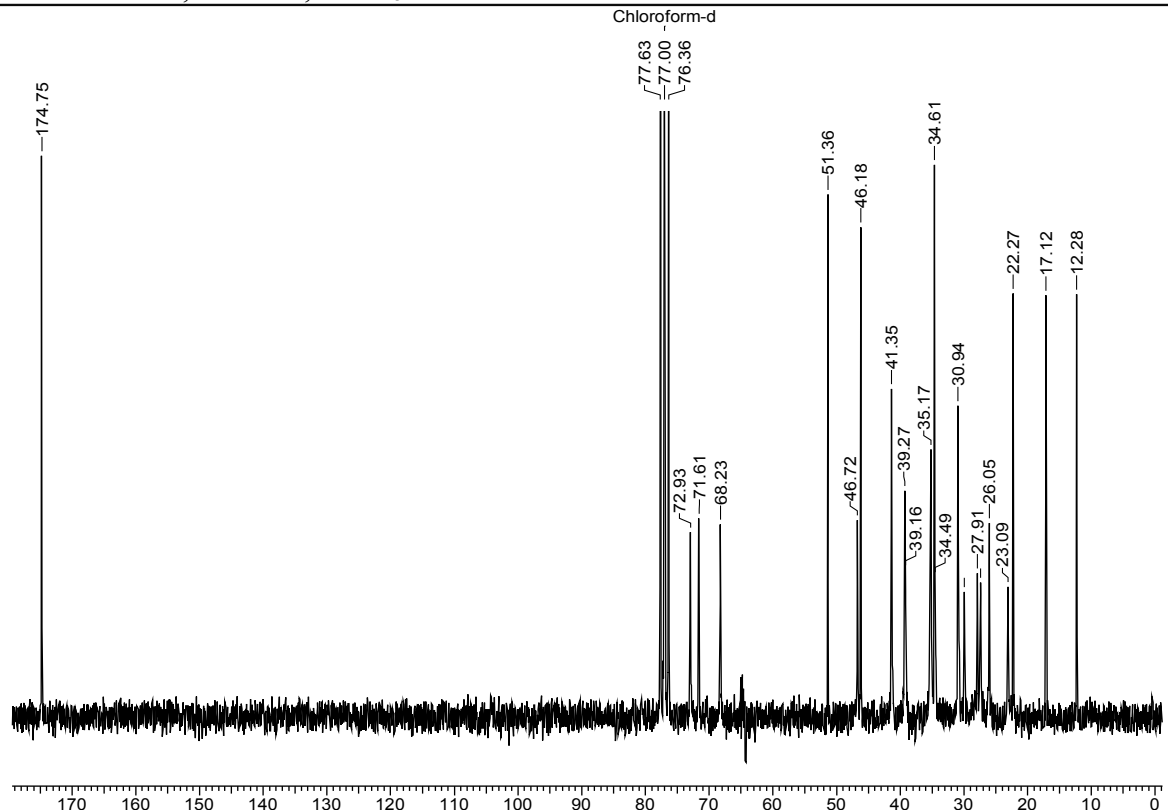
37: ^1H NMR, 200 MHz, CDCl_3 **37:** ^{13}C NMR, 50 MHz, CDCl_3 

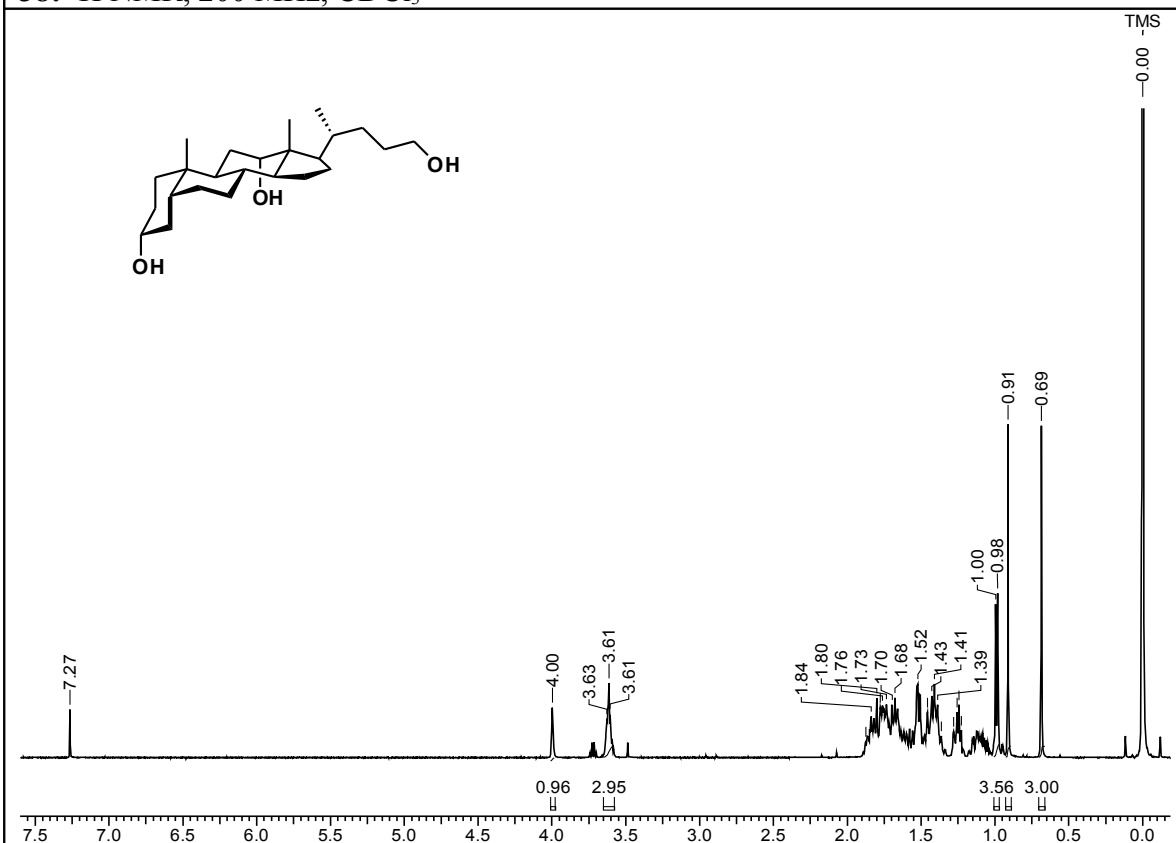
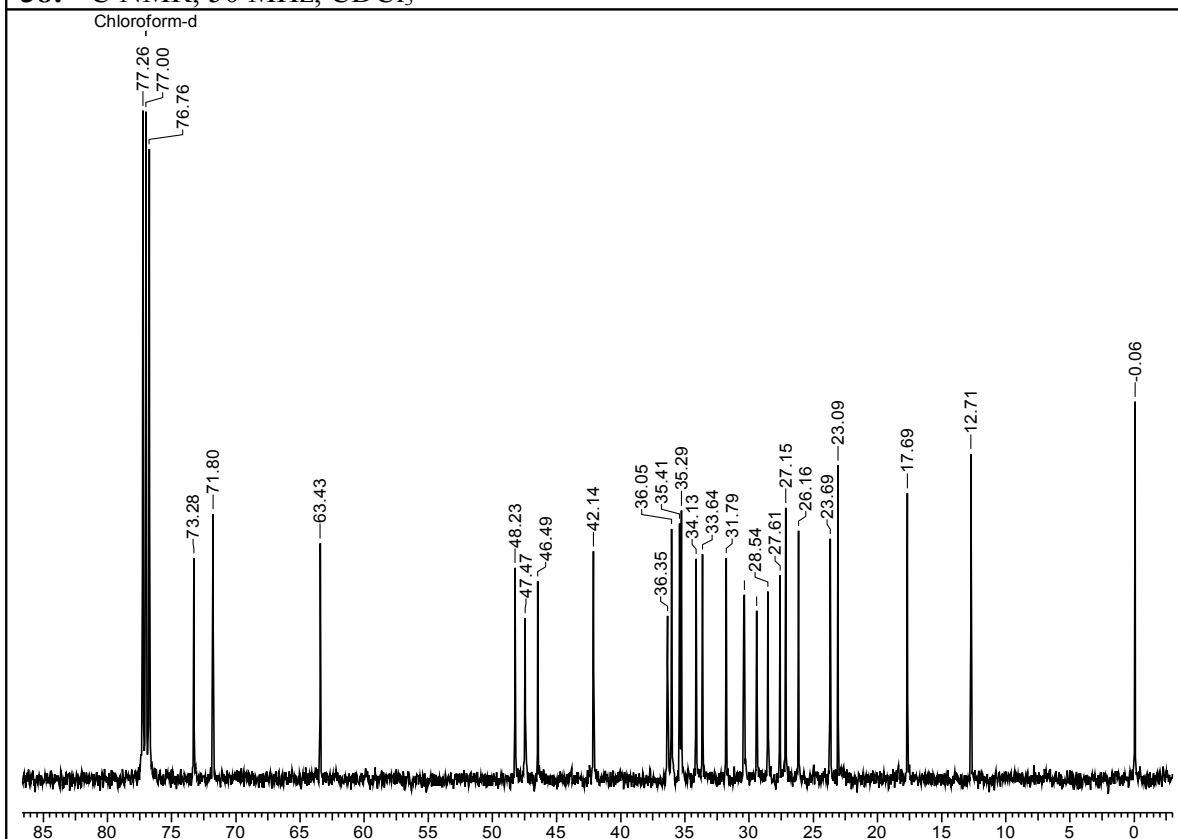
38: ^1H NMR, 200 MHz, CDCl_3 **38:** ^{13}C NMR, 50 MHz, CDCl_3 

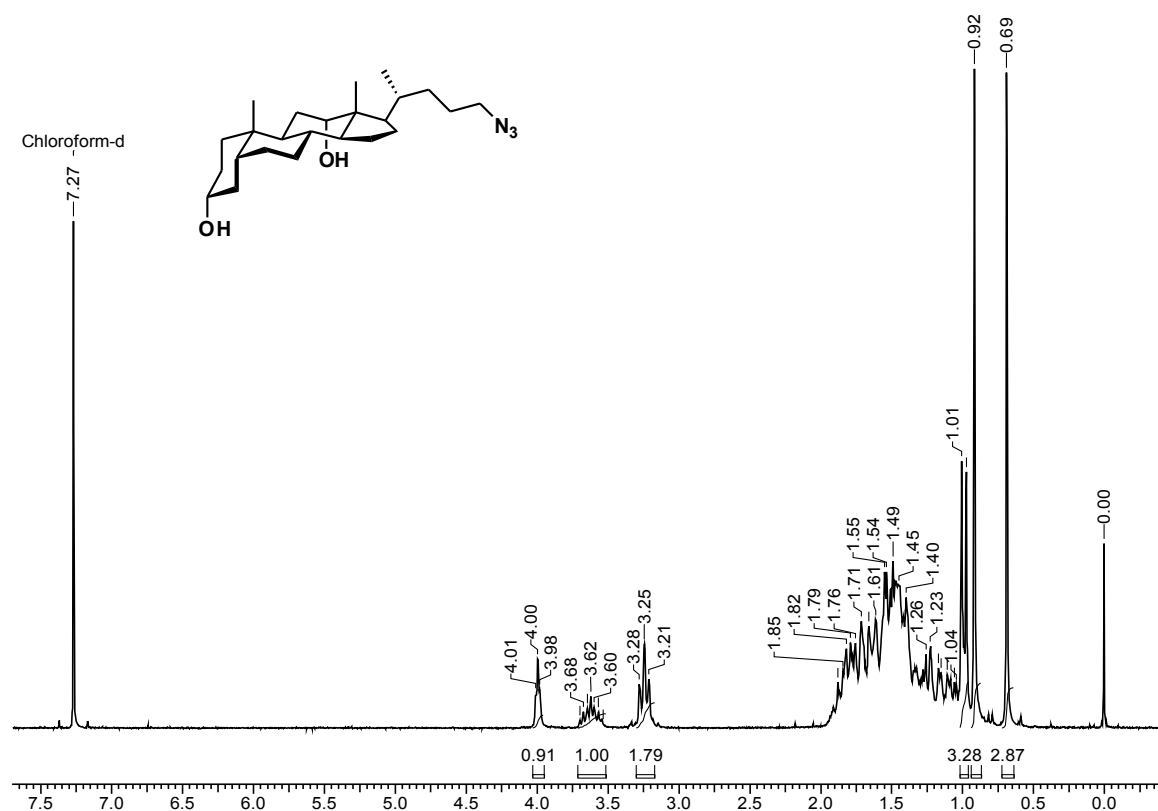
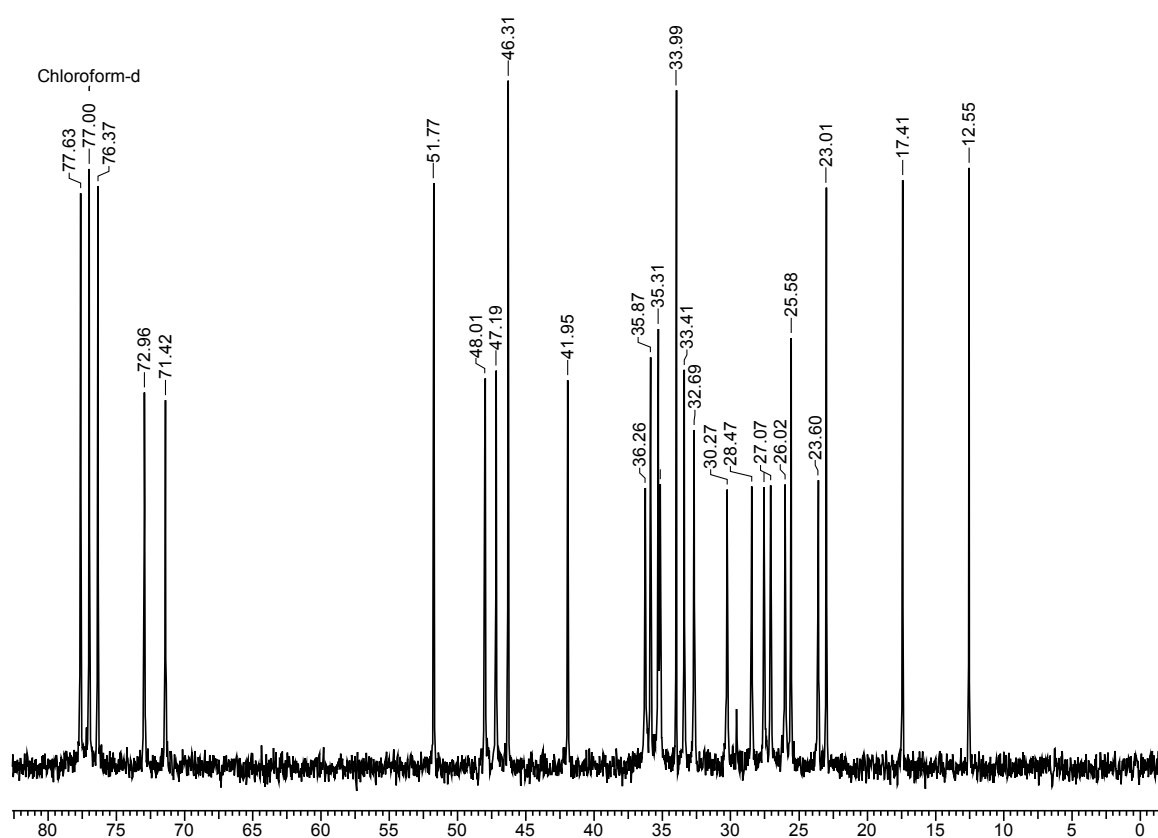
44: ^1H NMR, 200 MHz, CDCl_3 **44:** ^{13}C NMR, 50 MHz, CDCl_3 

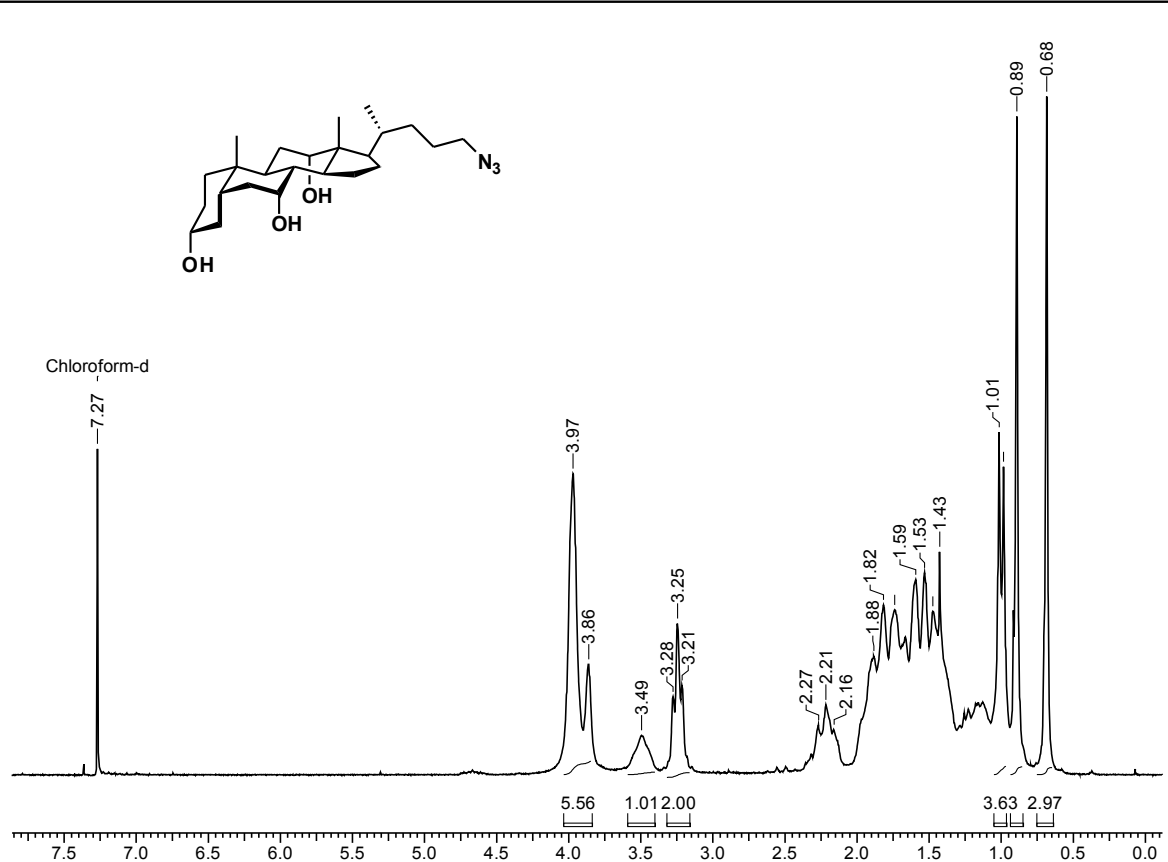
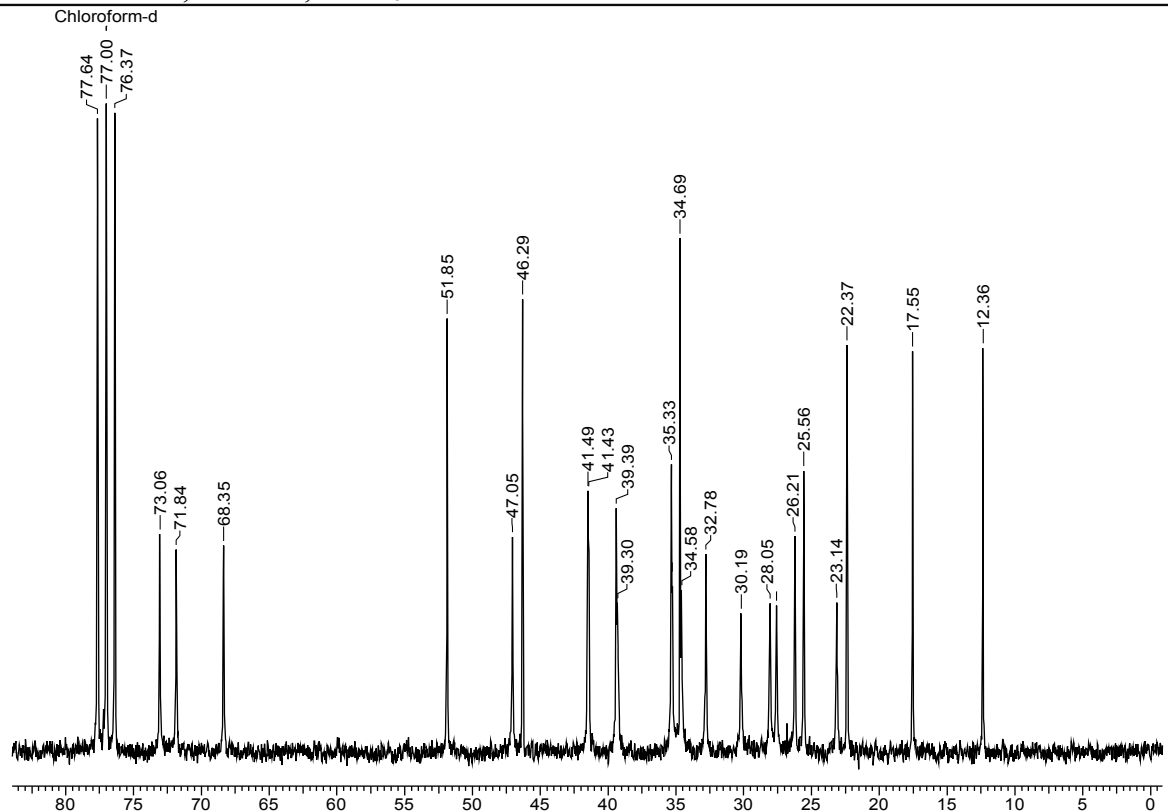
45: ^1H NMR, 200 MHz, CDCl_3 45: ^{13}C NMR, 50 MHz, CDCl_3 

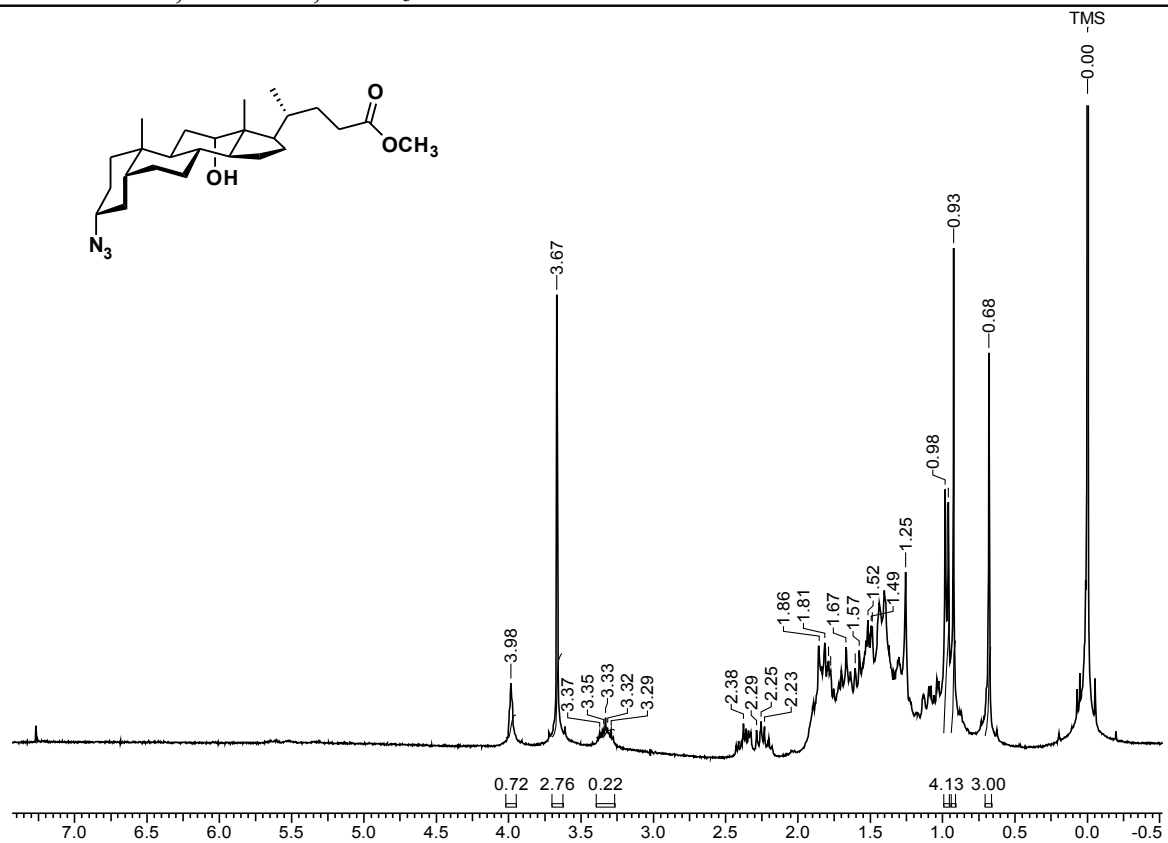
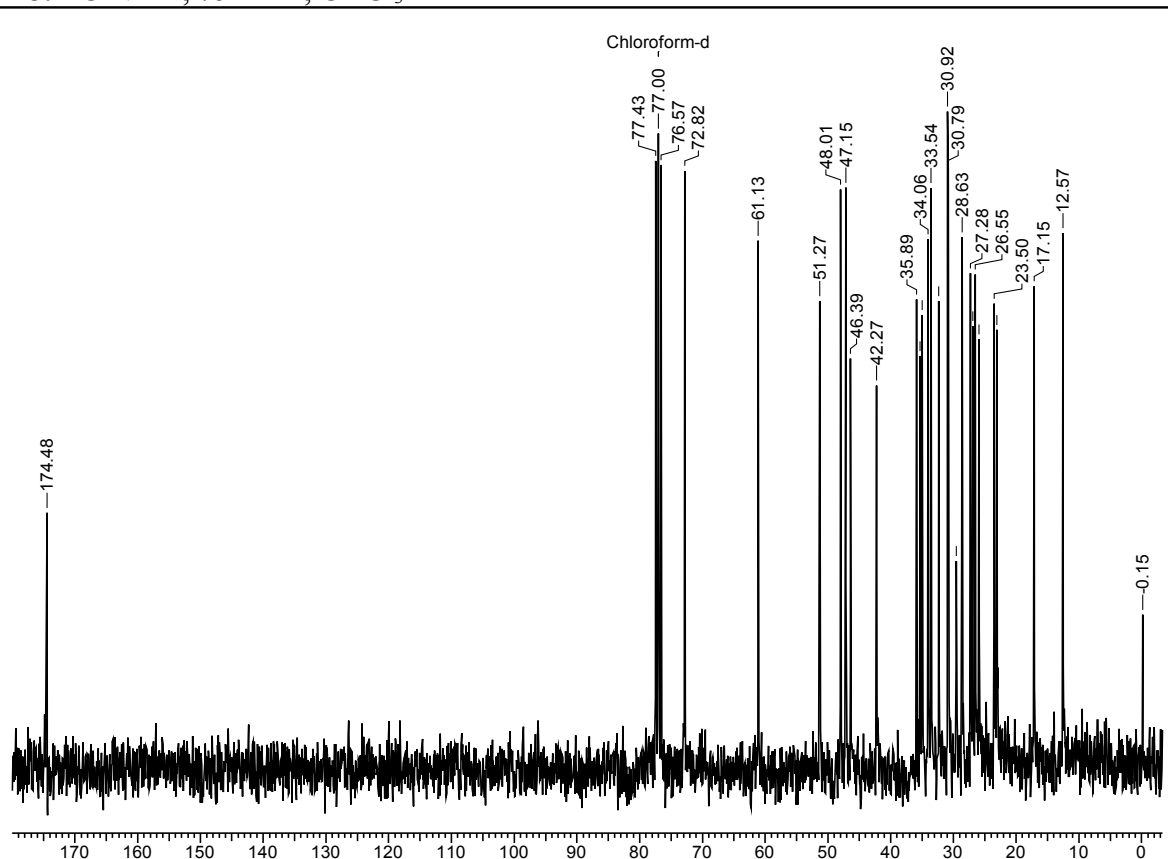
48: ^1H NMR, 300 MHz, CDCl_3 48: ^{13}C NMR, 75 MHz, CDCl_3 

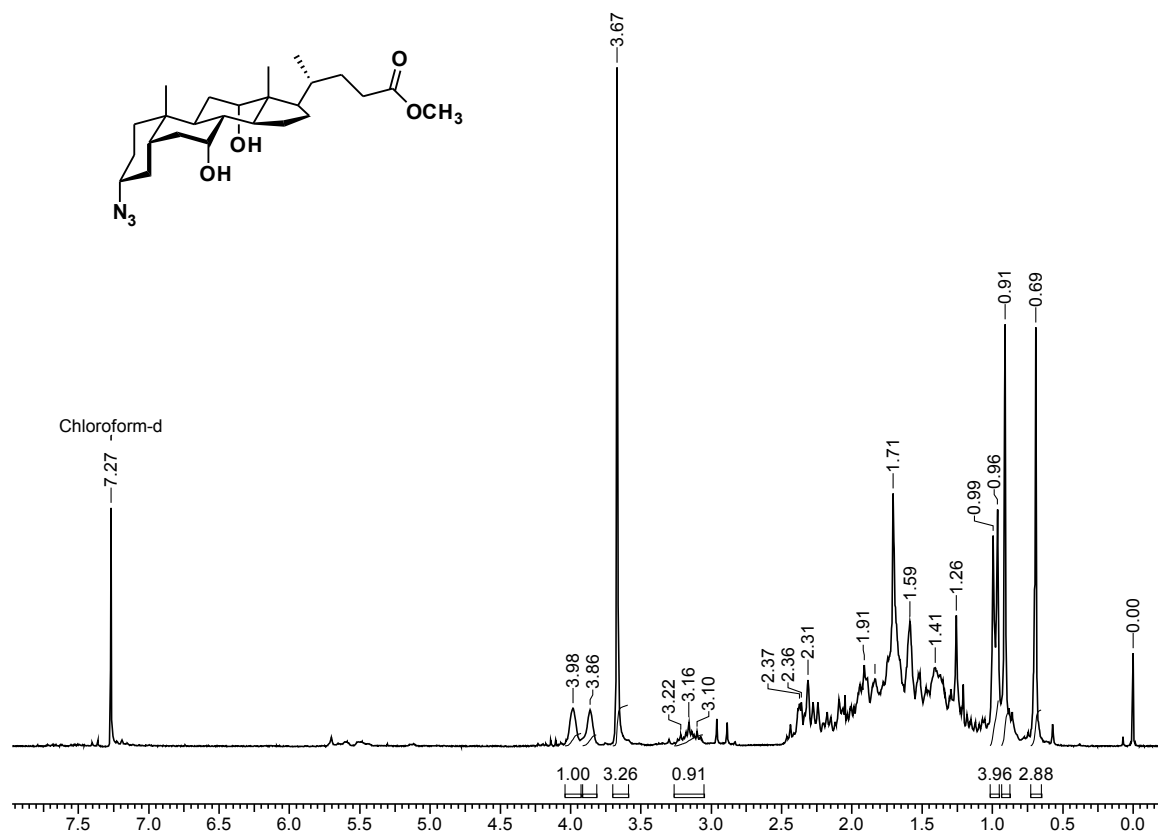
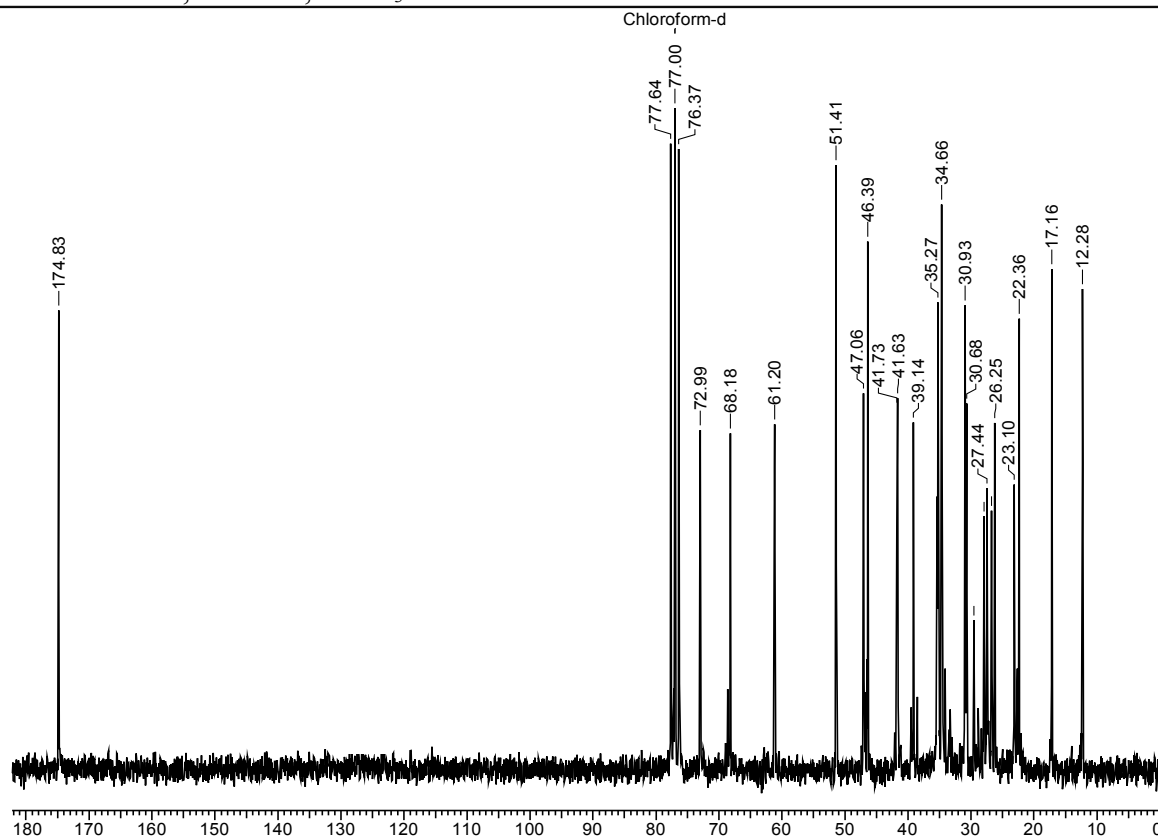
49: ^1H NMR, 200 MHz, CDCl_3 49: ^{13}C NMR, 50 MHz, CDCl_3 

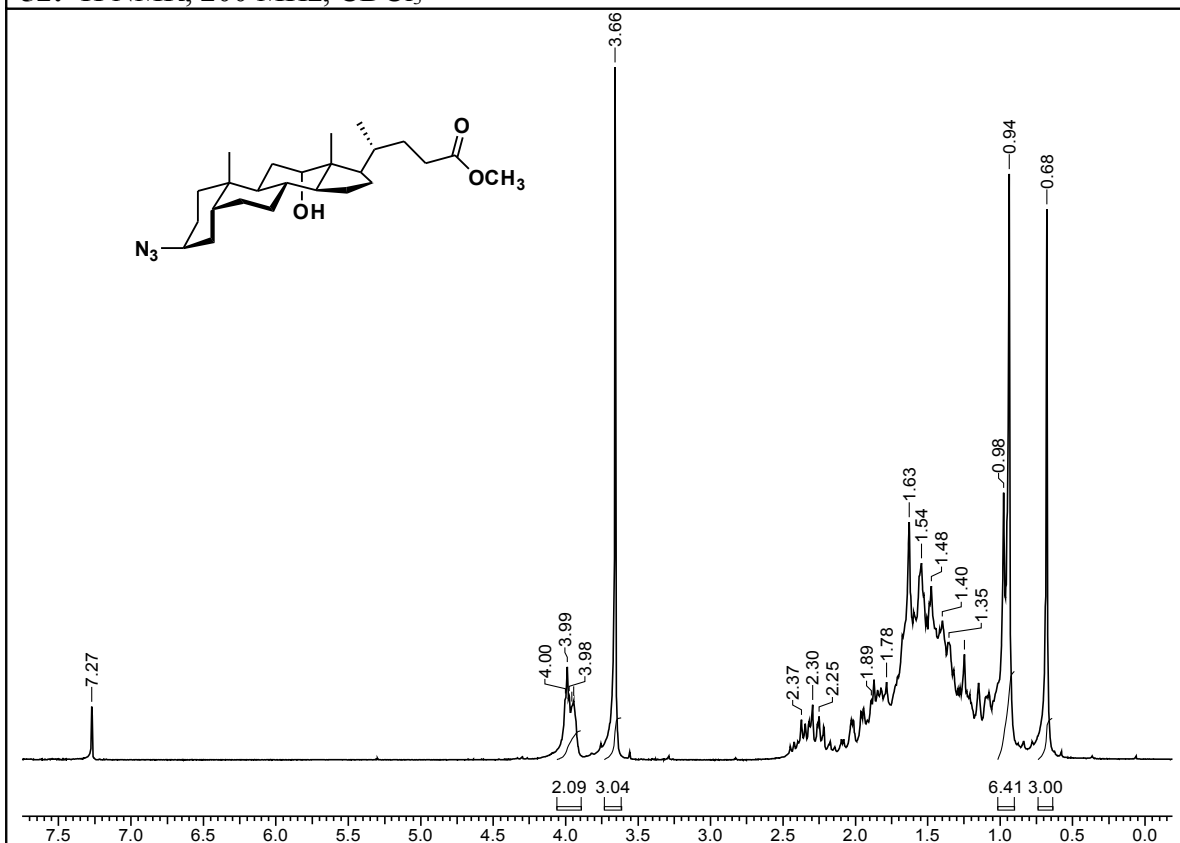
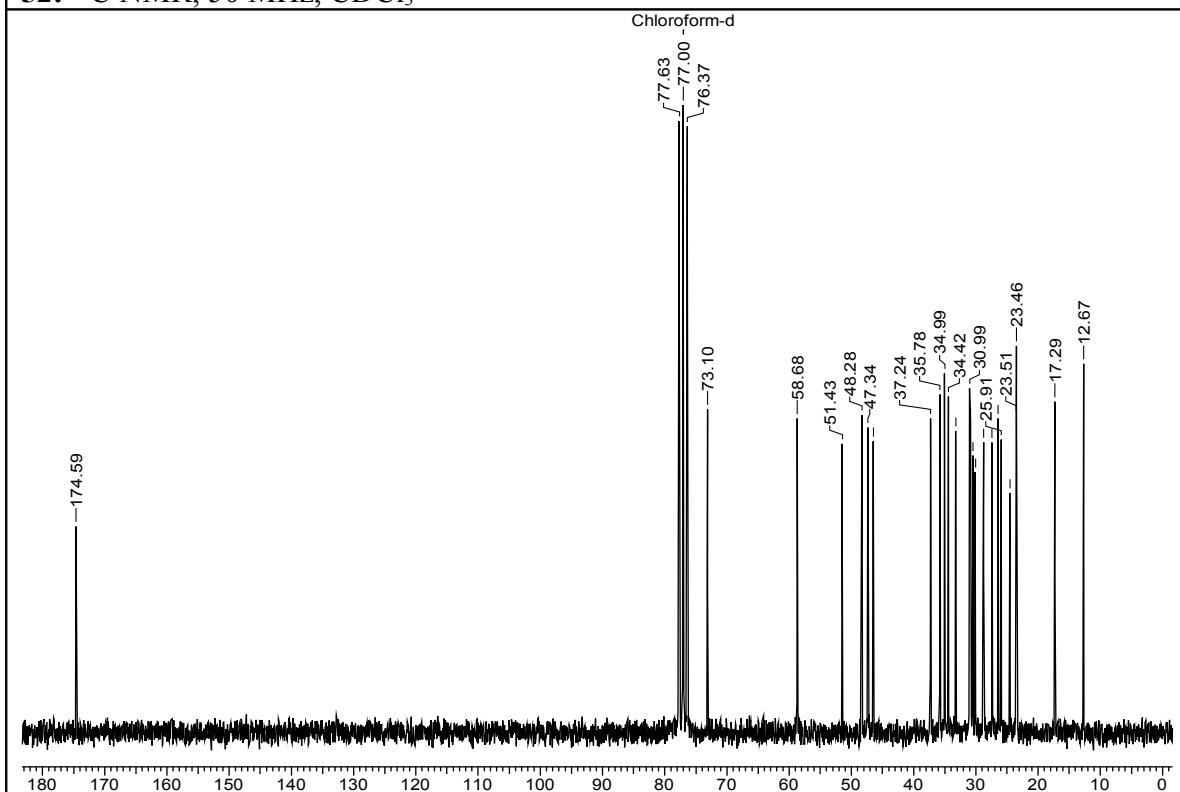
52: ^1H NMR, 200 MHz, CDCl_3 **52:** ^{13}C NMR, 50 MHz, CDCl_3 

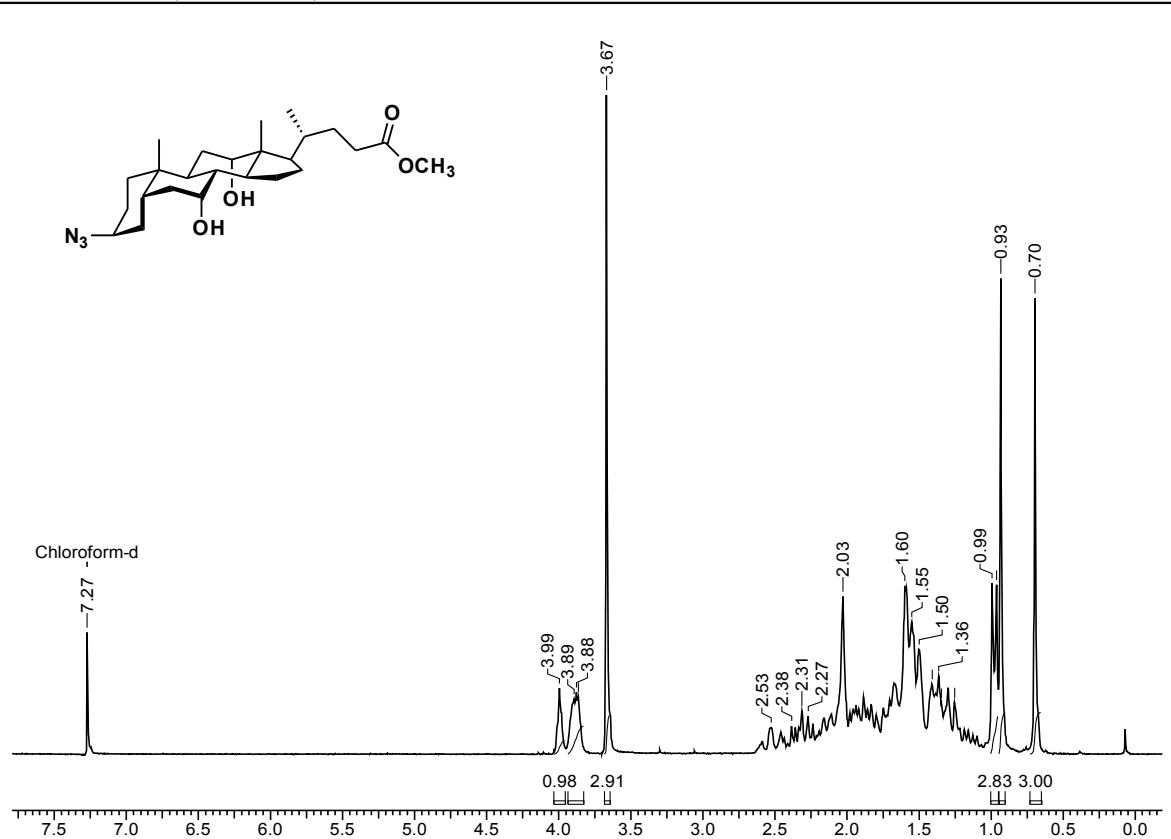
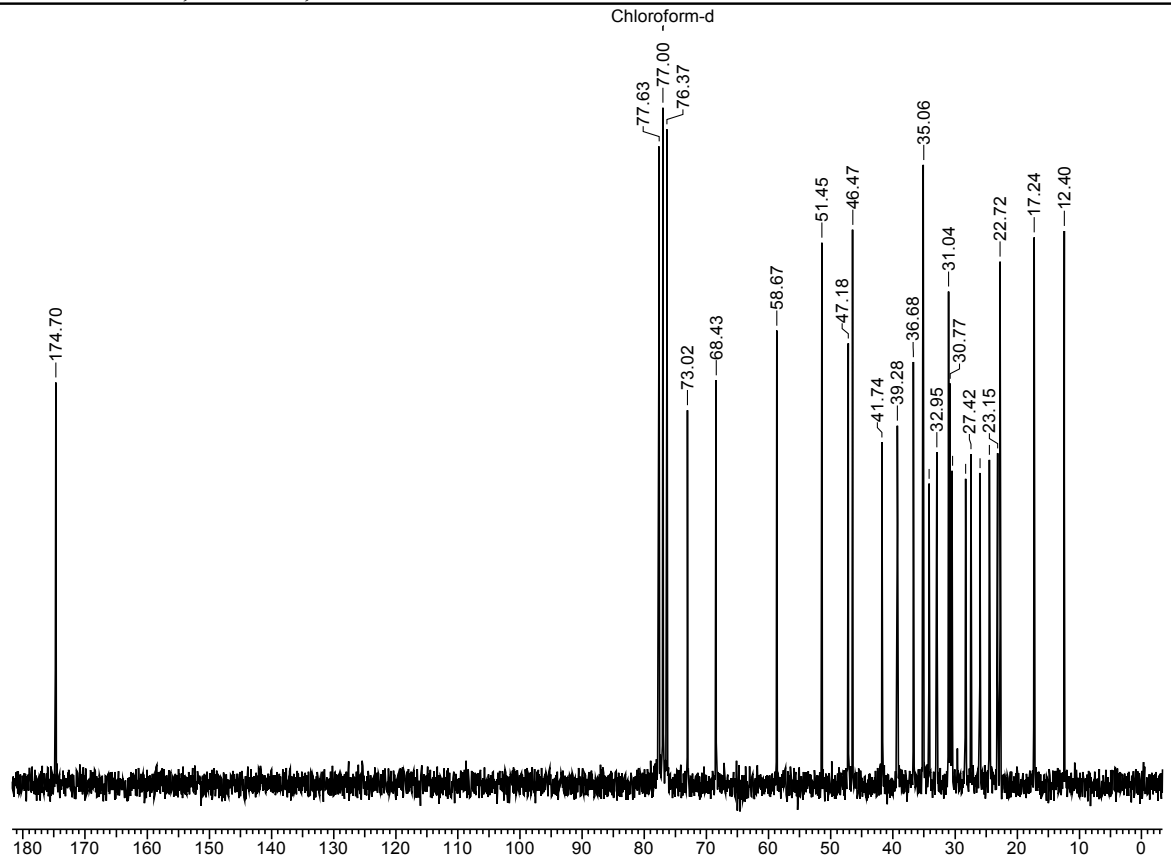
53: ^1H NMR, 200 MHz, CDCl_3 **53:** ^{13}C NMR, 50 MHz, CDCl_3 

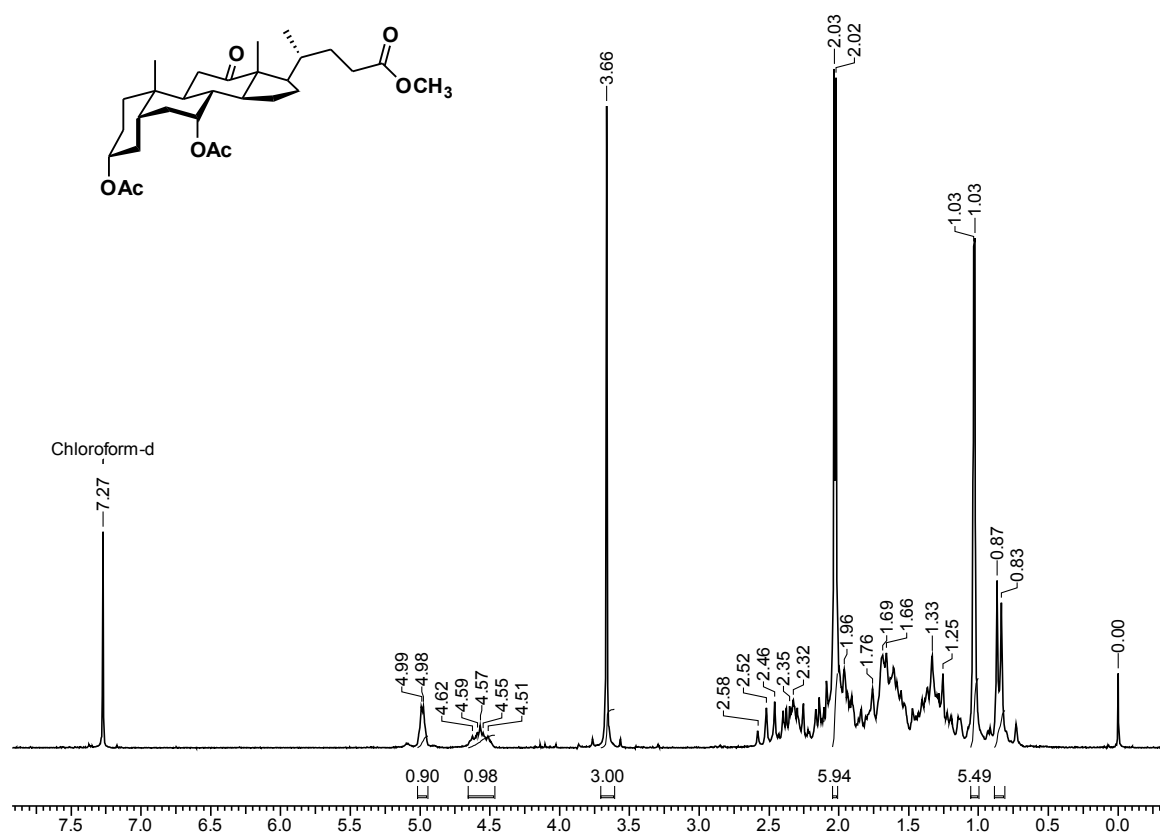
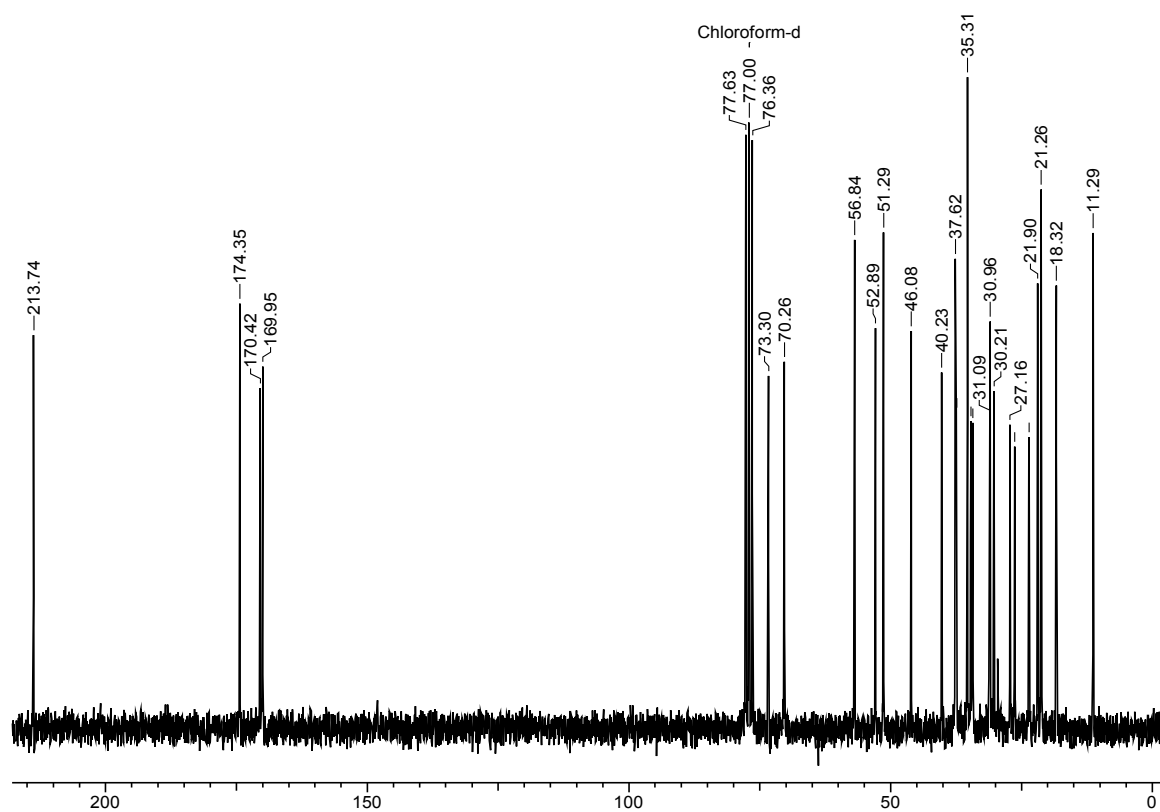
55: ^1H NMR, 300 MHz, CDCl_3 55: ^{13}C NMR, 75 MHz, CDCl_3 

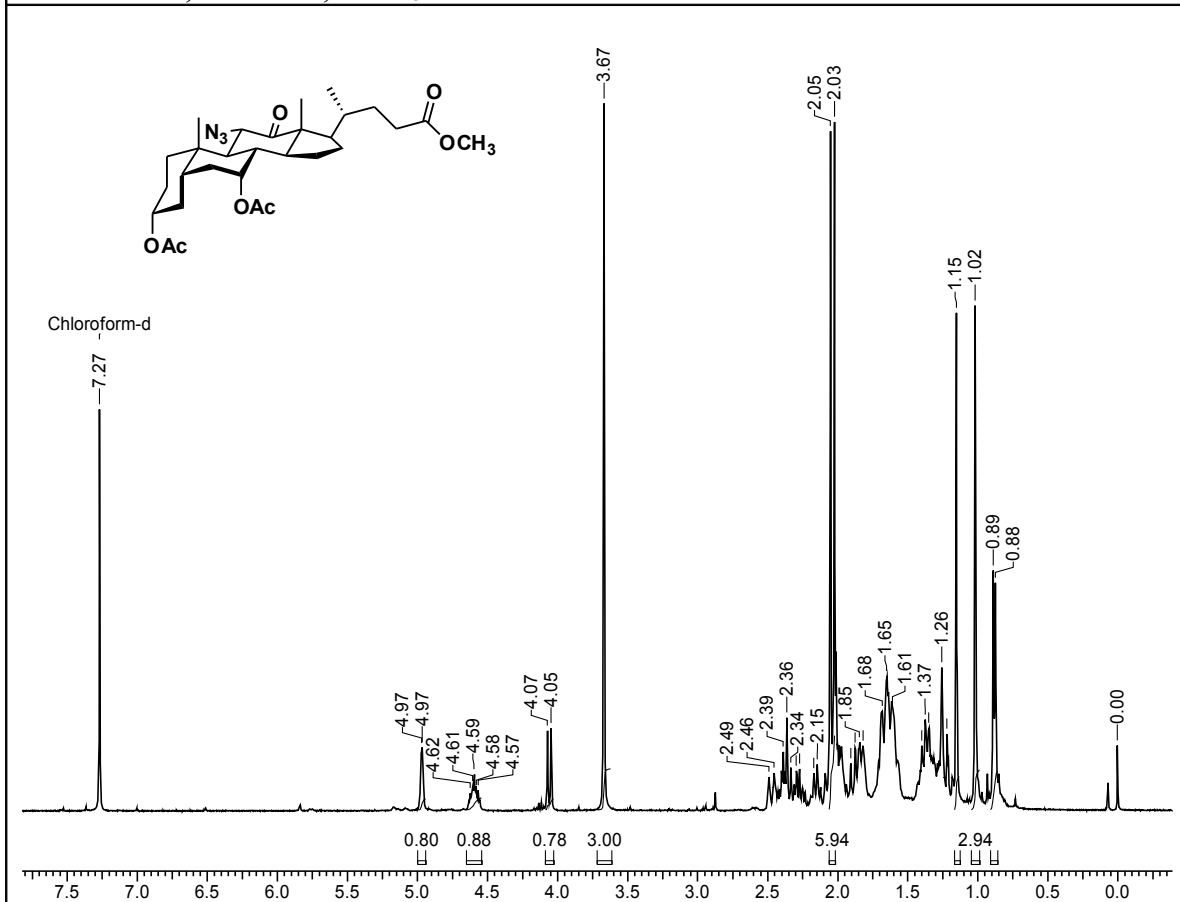
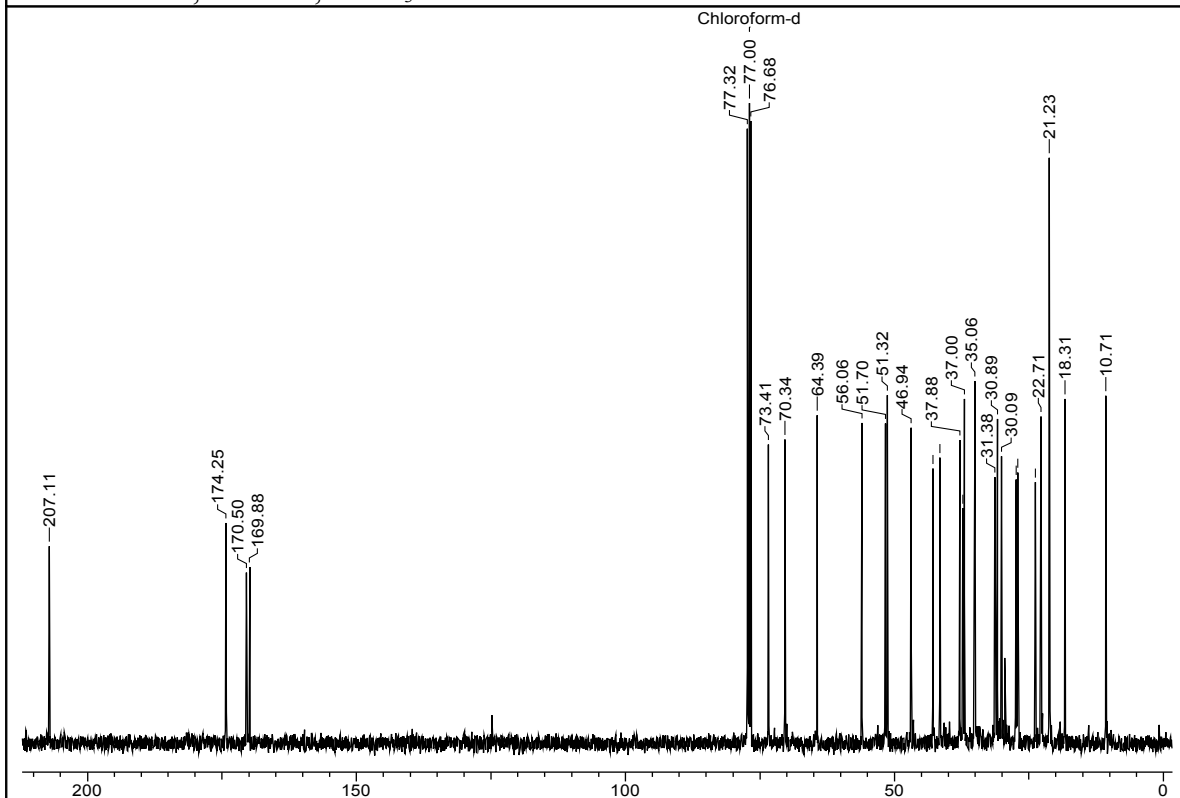
58: ^1H NMR, 200 MHz, CDCl_3 **58:** ^{13}C NMR, 50 MHz, CDCl_3 

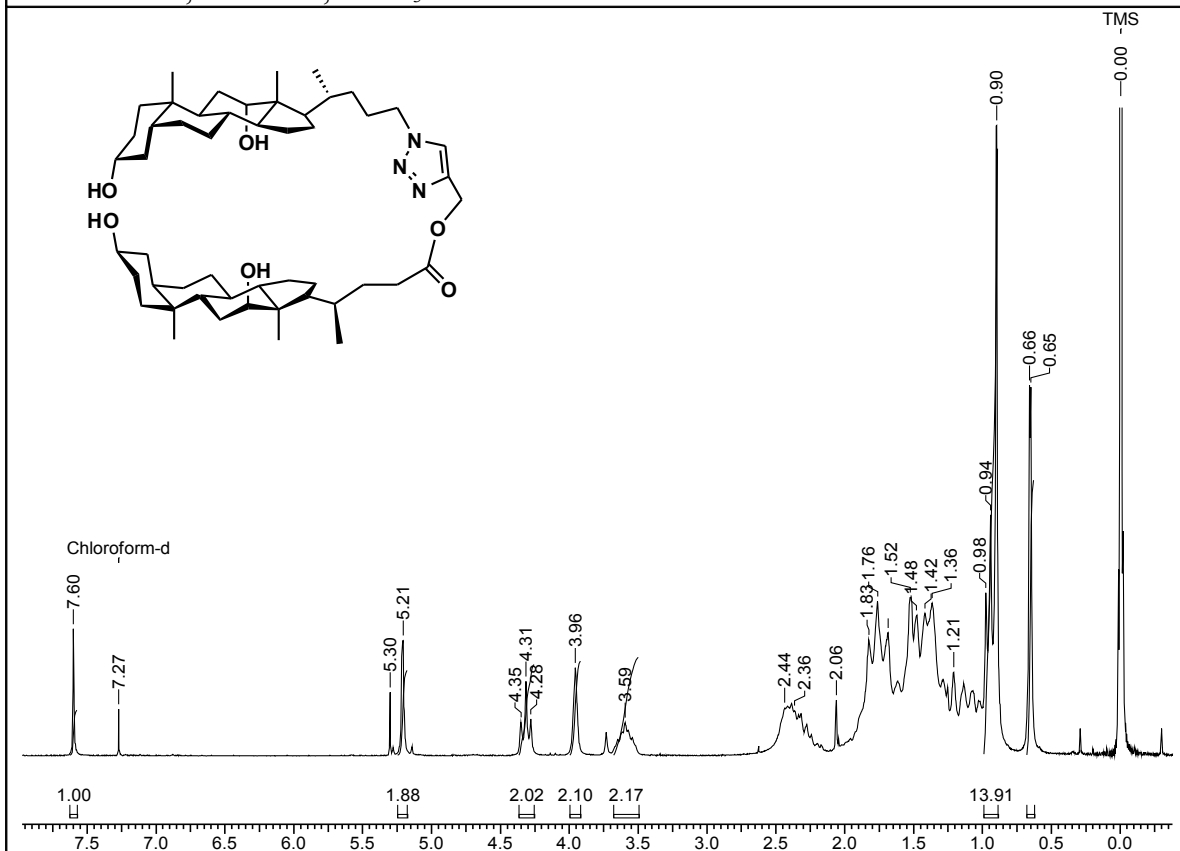
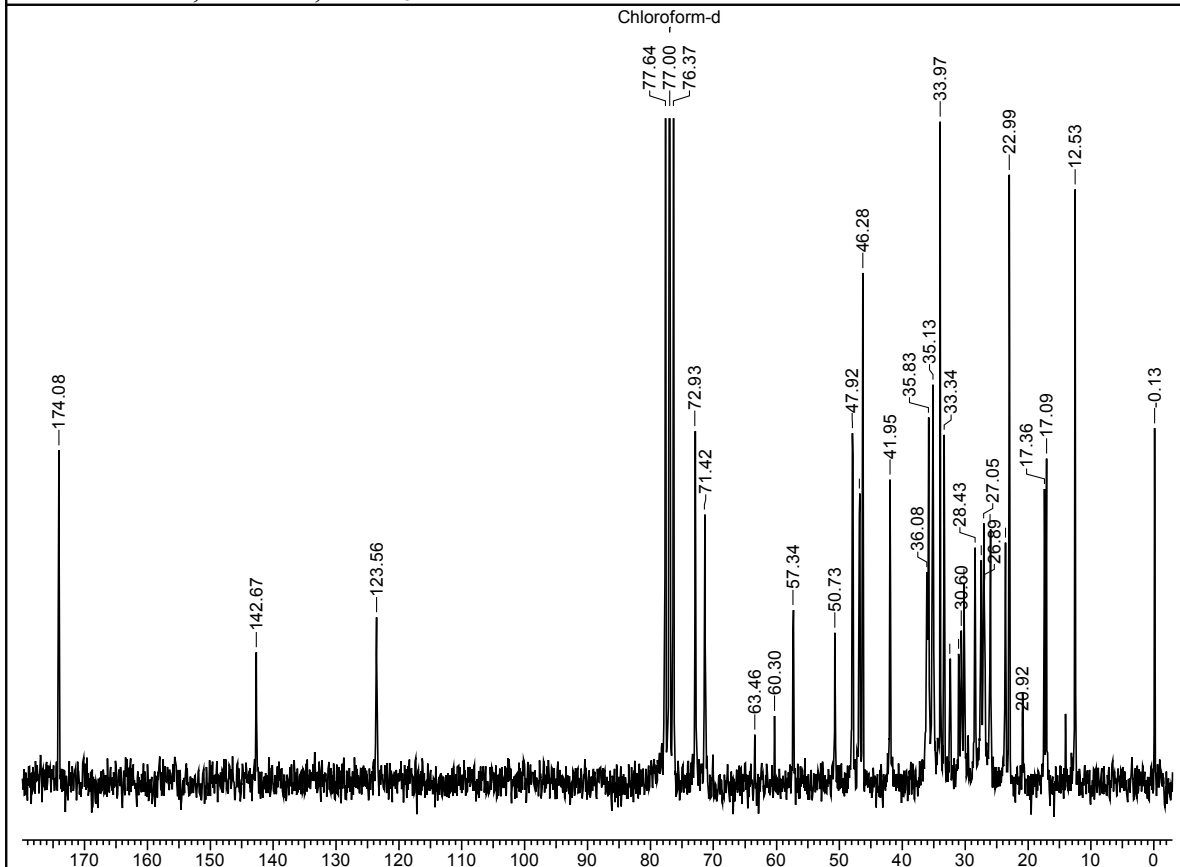
59: ^1H NMR, 200 MHz, CDCl_3 **59:** ^{13}C NMR, 75 MHz, CDCl_3 

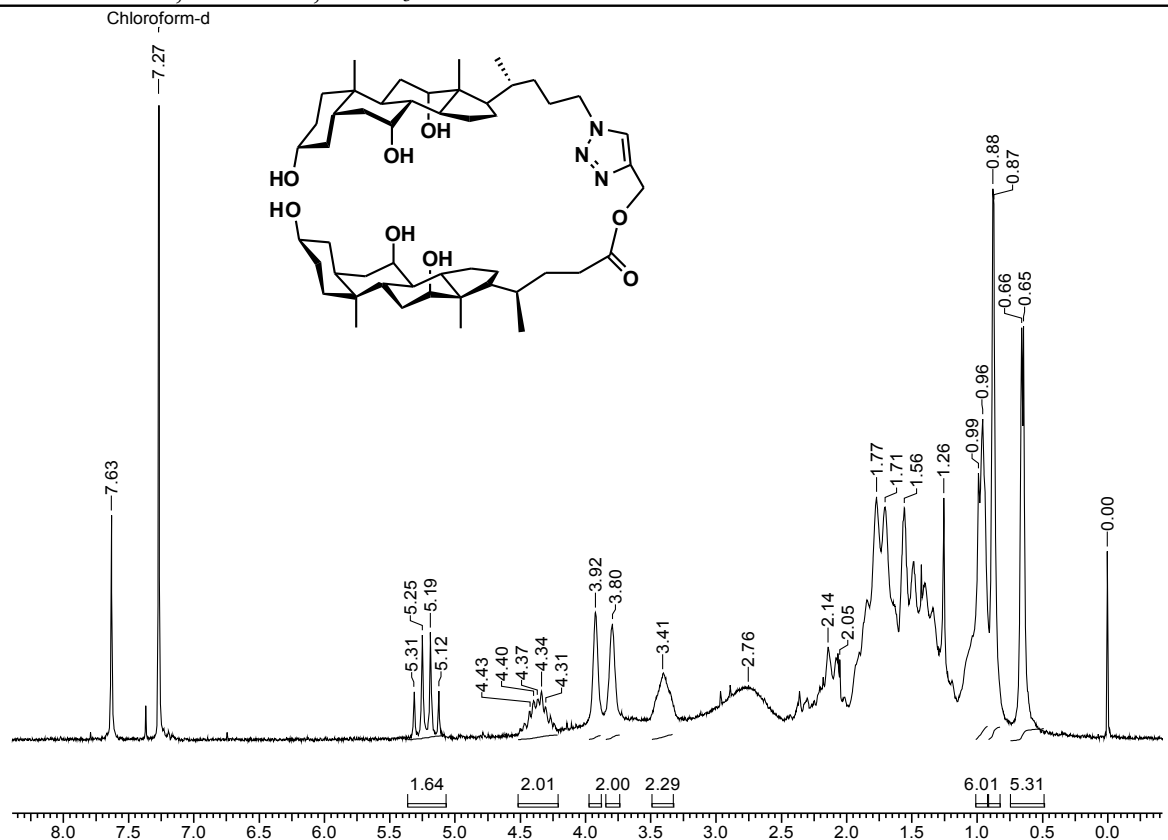
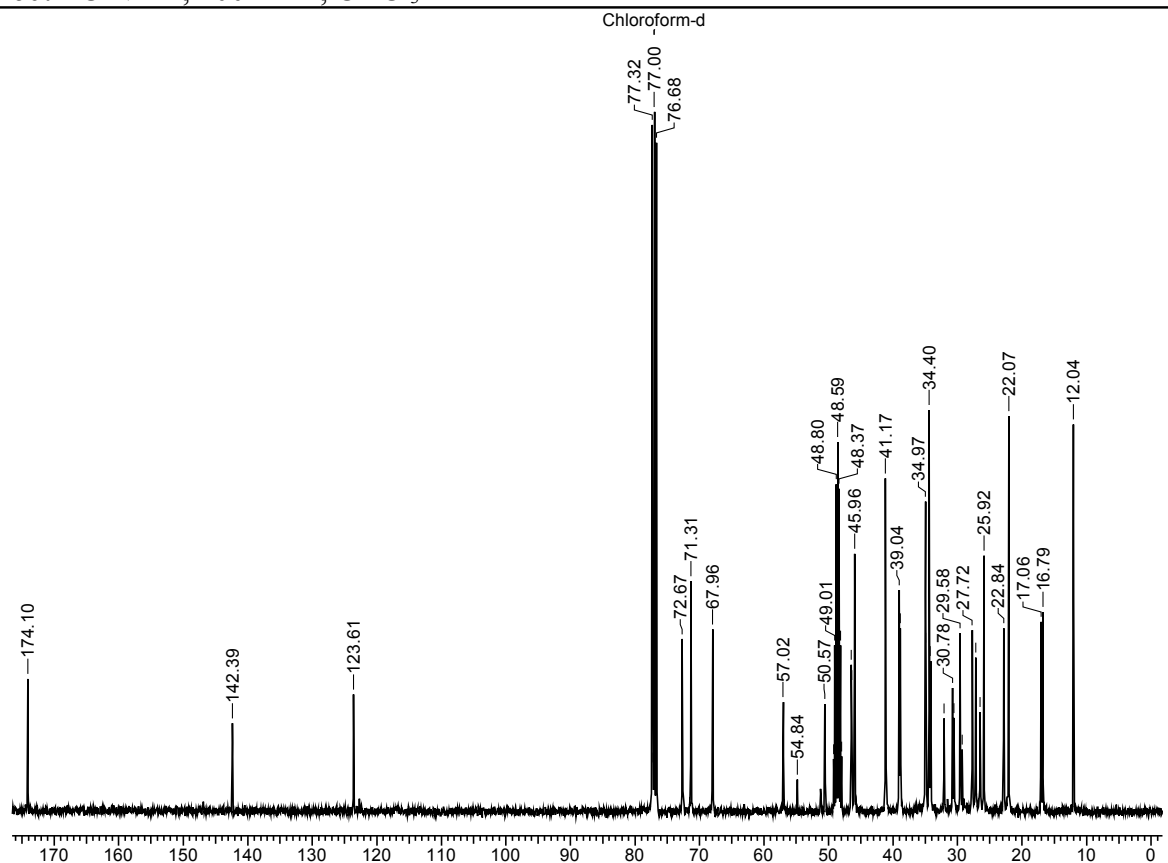
60: ^1H NMR, 200 MHz, CDCl_3 **60:** ^{13}C NMR, 100 MHz, CDCl_3 

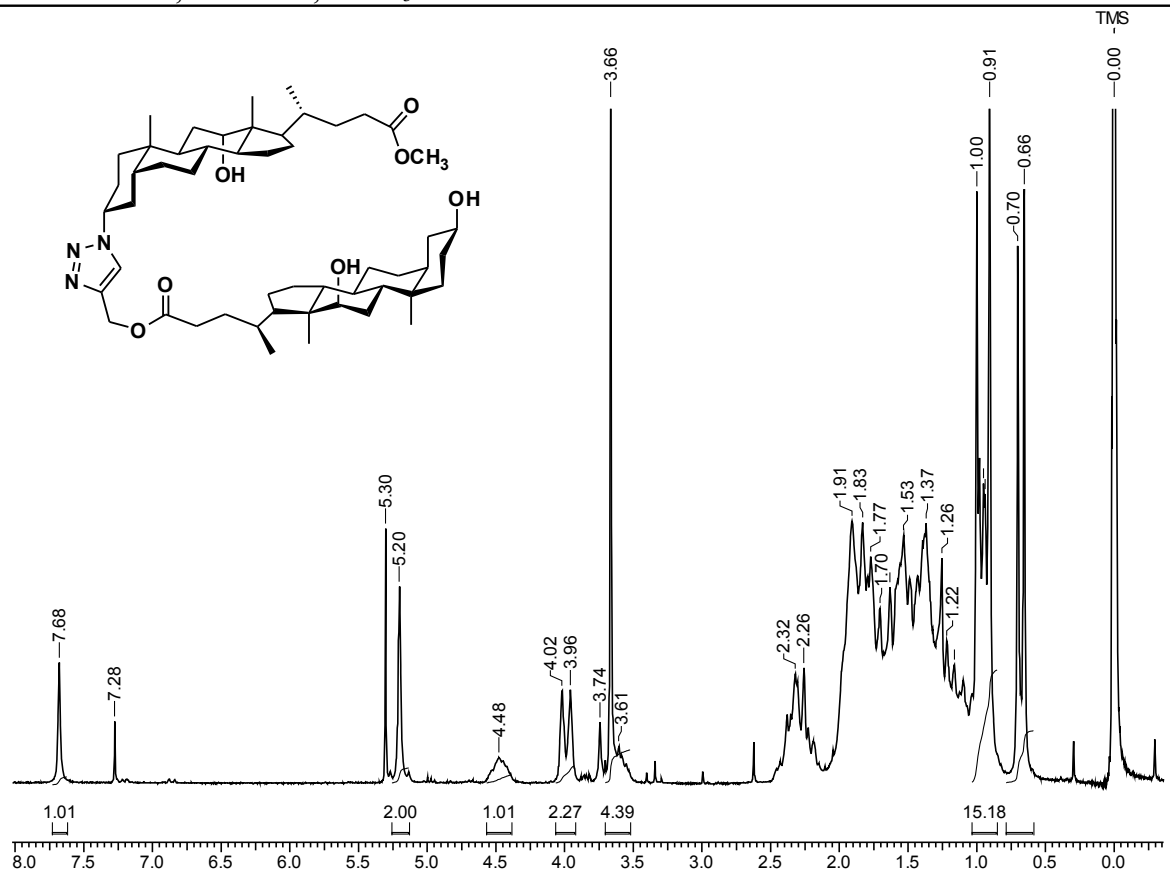
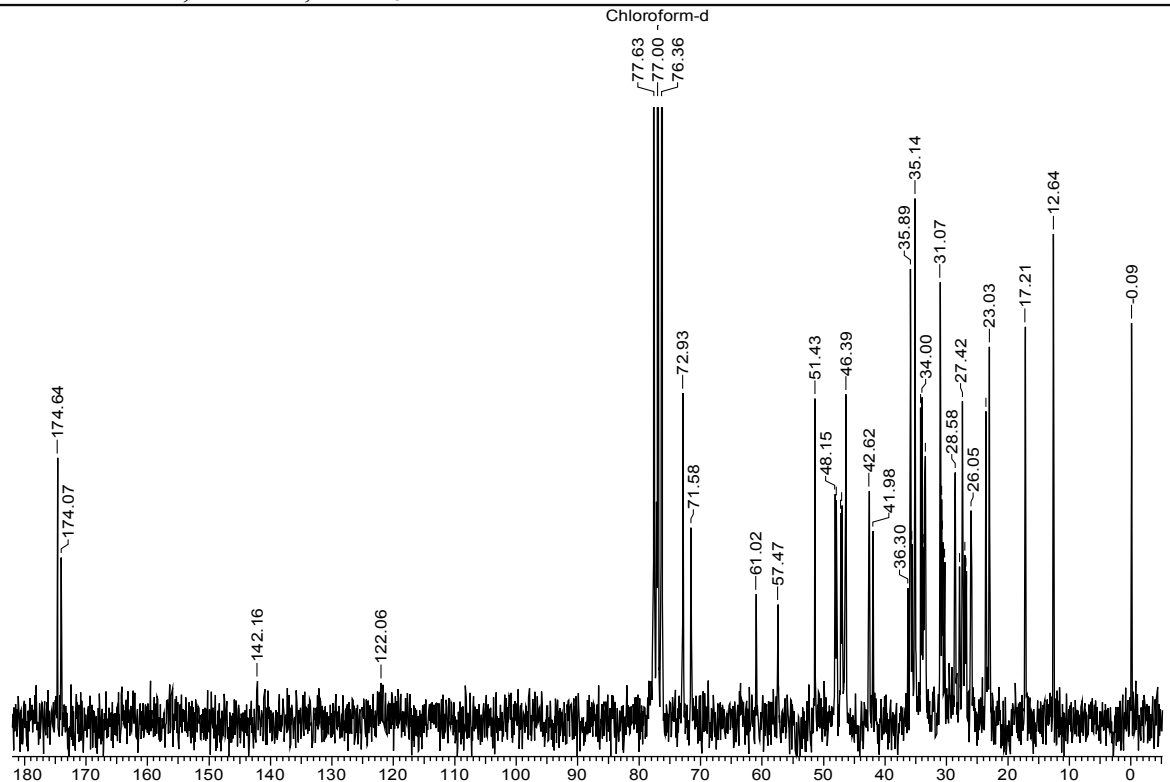
61: ^1H NMR, 200 MHz, CDCl_3 **61:** ^{13}C NMR, 50 MHz, CDCl_3 

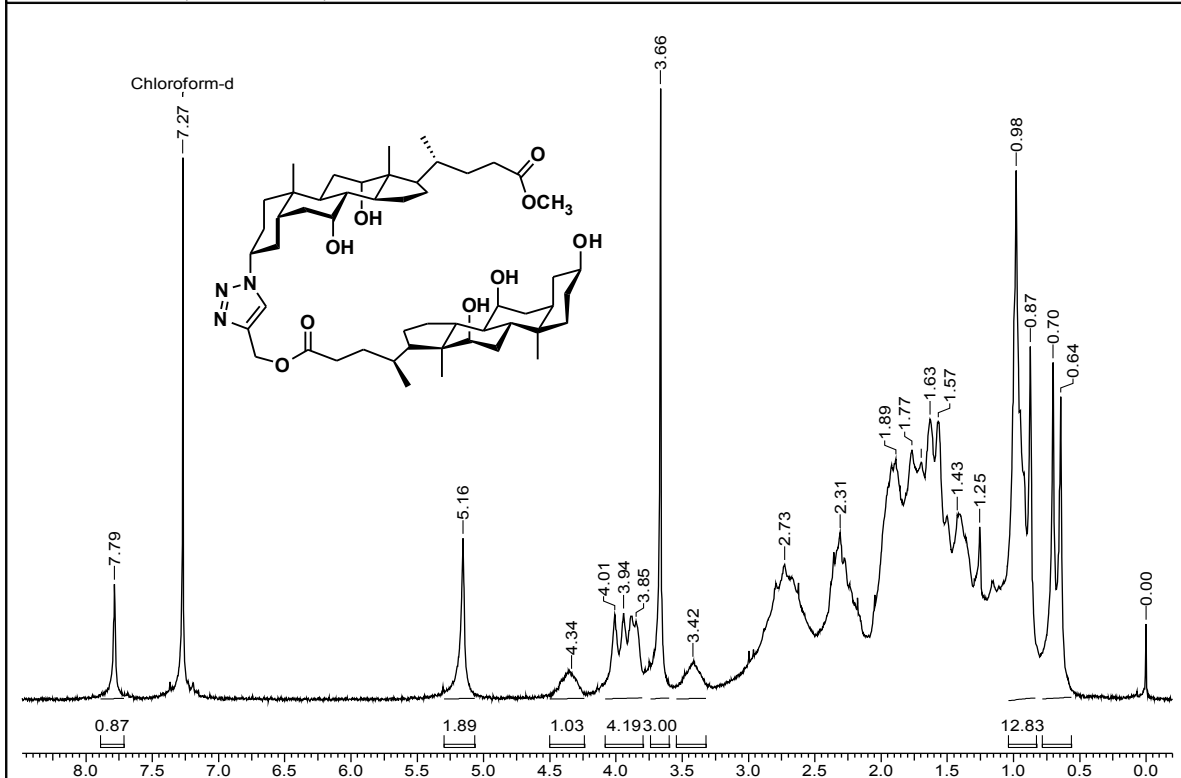
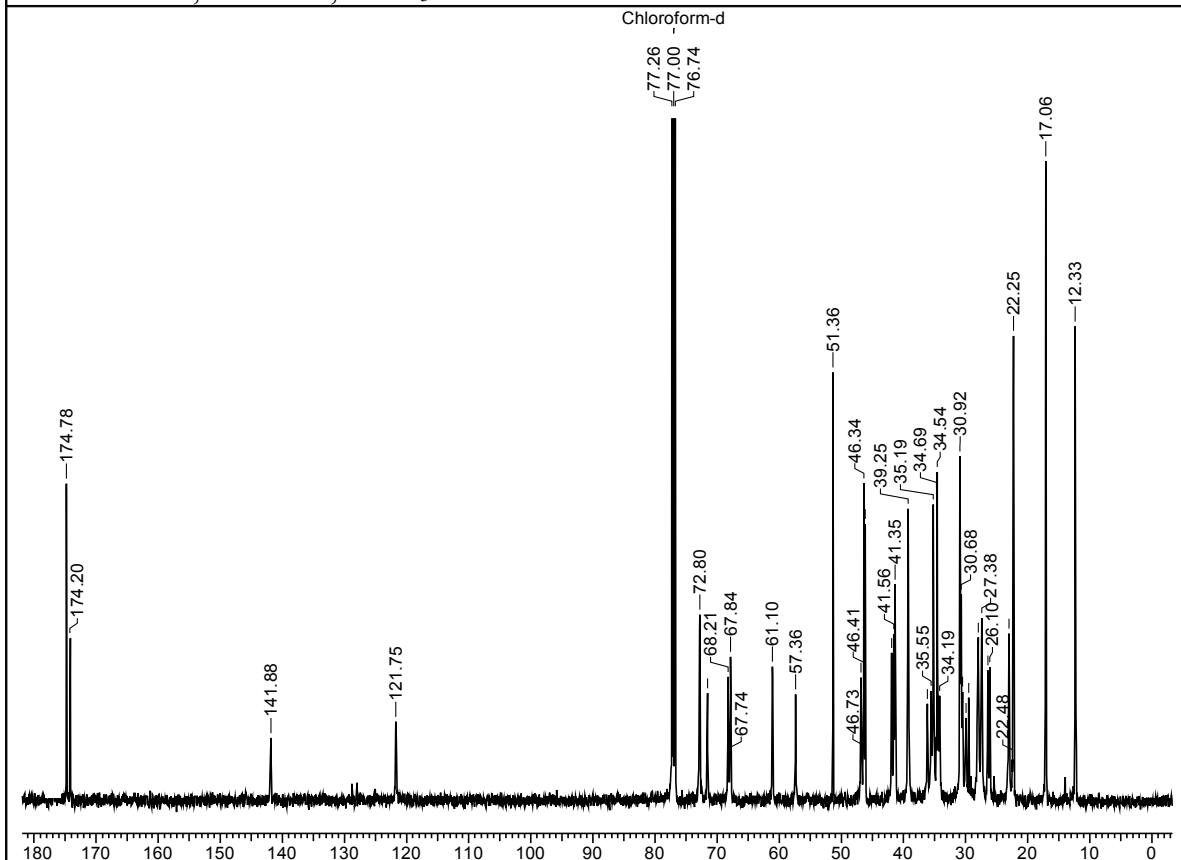
62: ^1H NMR, 200 MHz, CDCl_3 **62:** ^{13}C NMR, 100 MHz, CDCl_3 

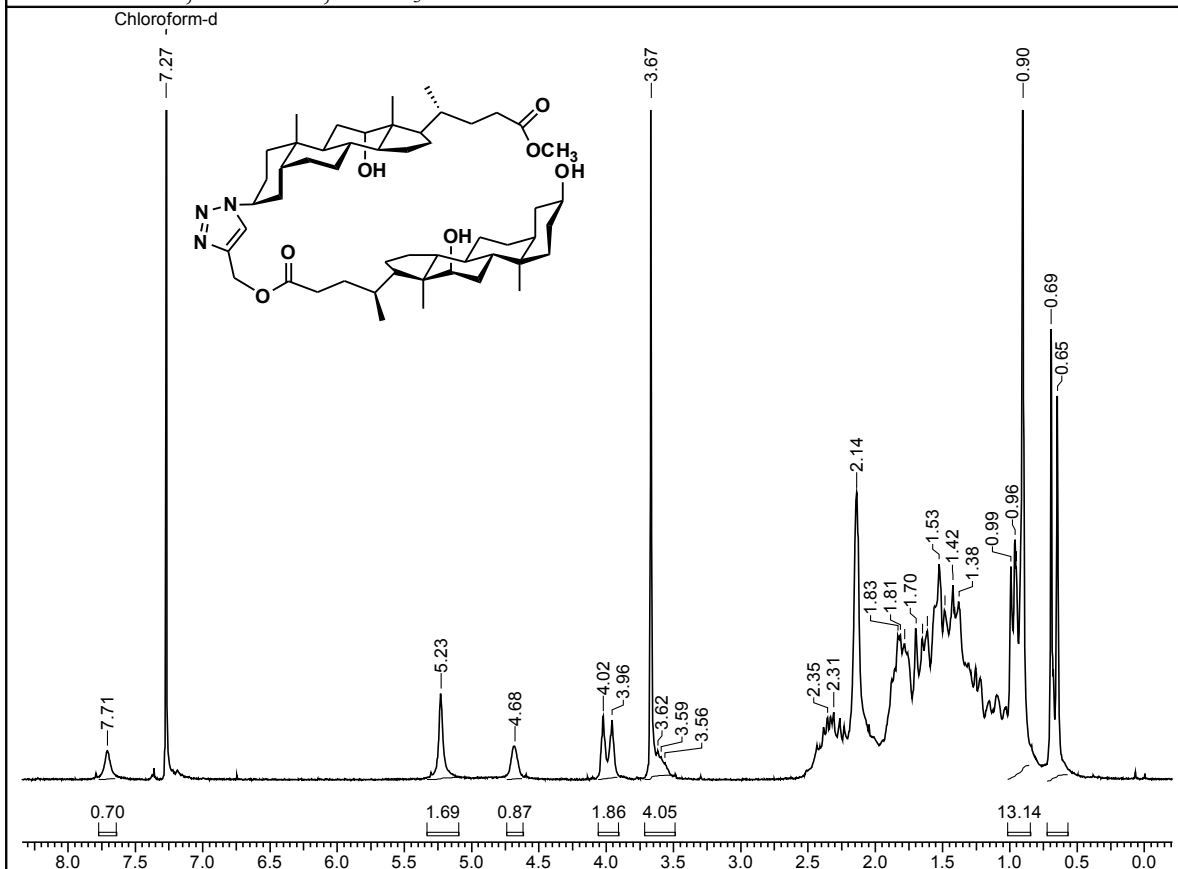
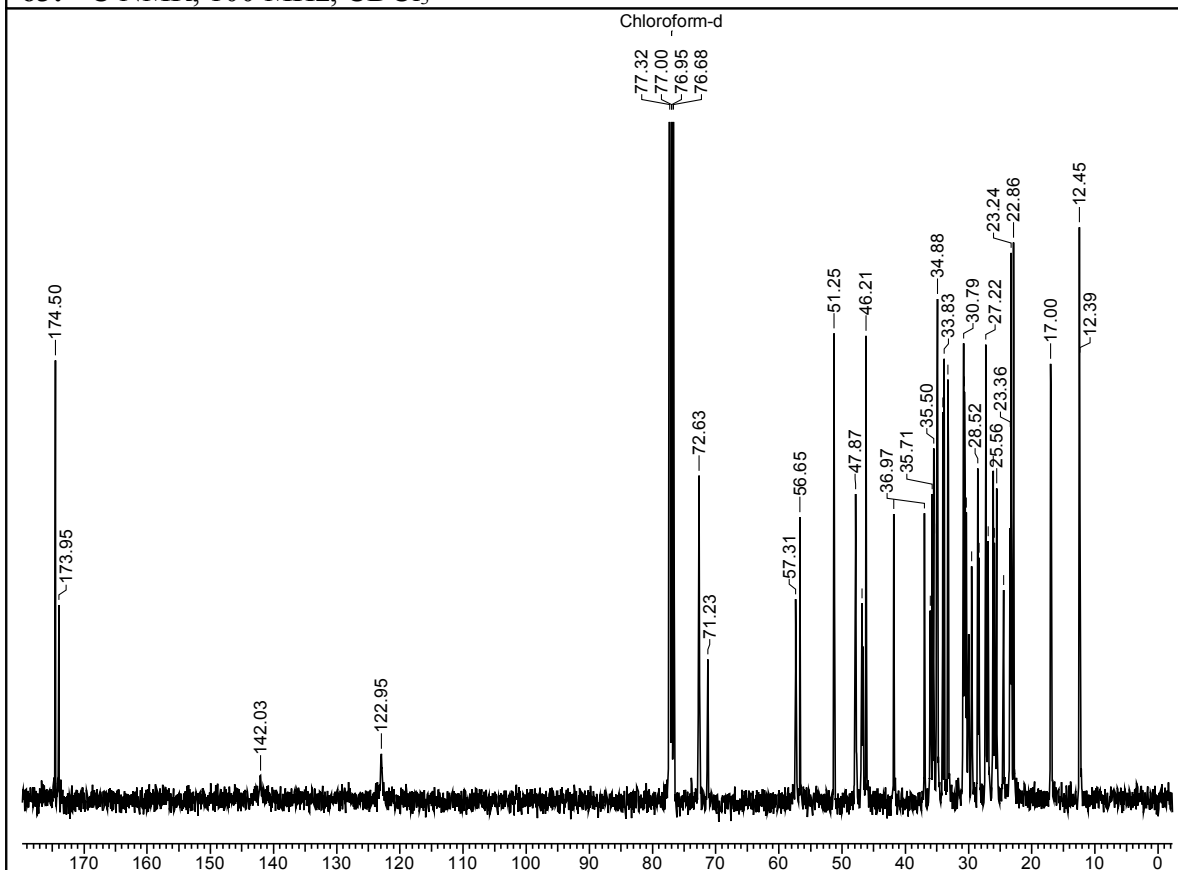
63: ^1H NMR, 200 MHz, CDCl_3 **63:** ^{13}C NMR, 100 MHz, CDCl_3 

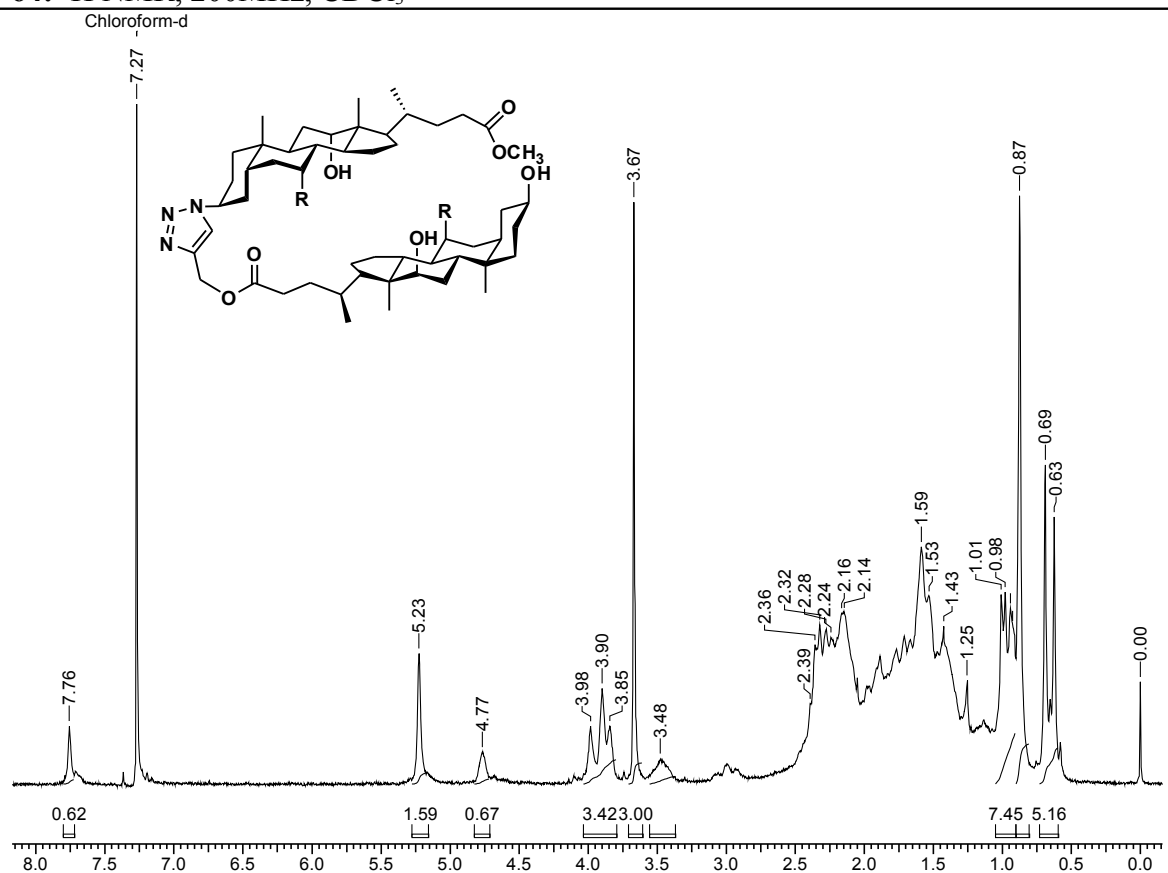
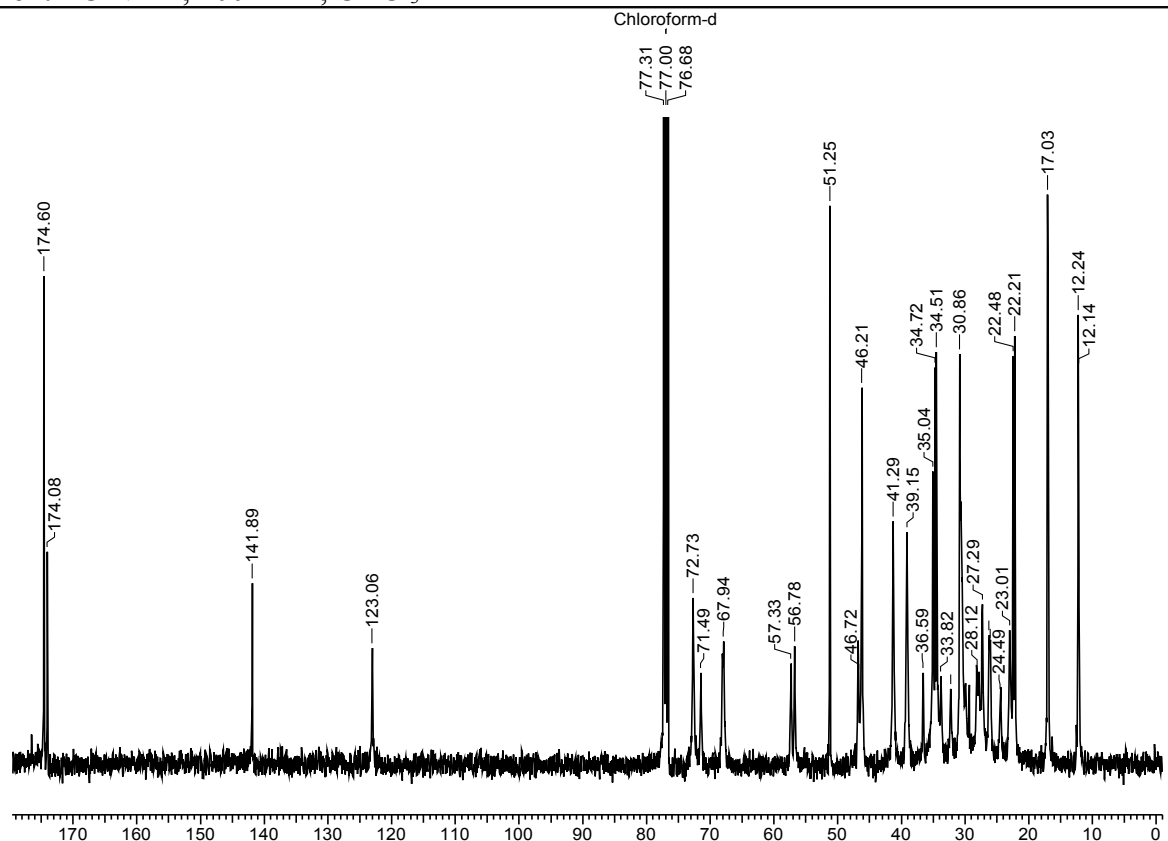
64: ^1H NMR, 200MHz, CDCl_3 **64:** ^{13}C NMR, 100 MHz, CDCl_3 

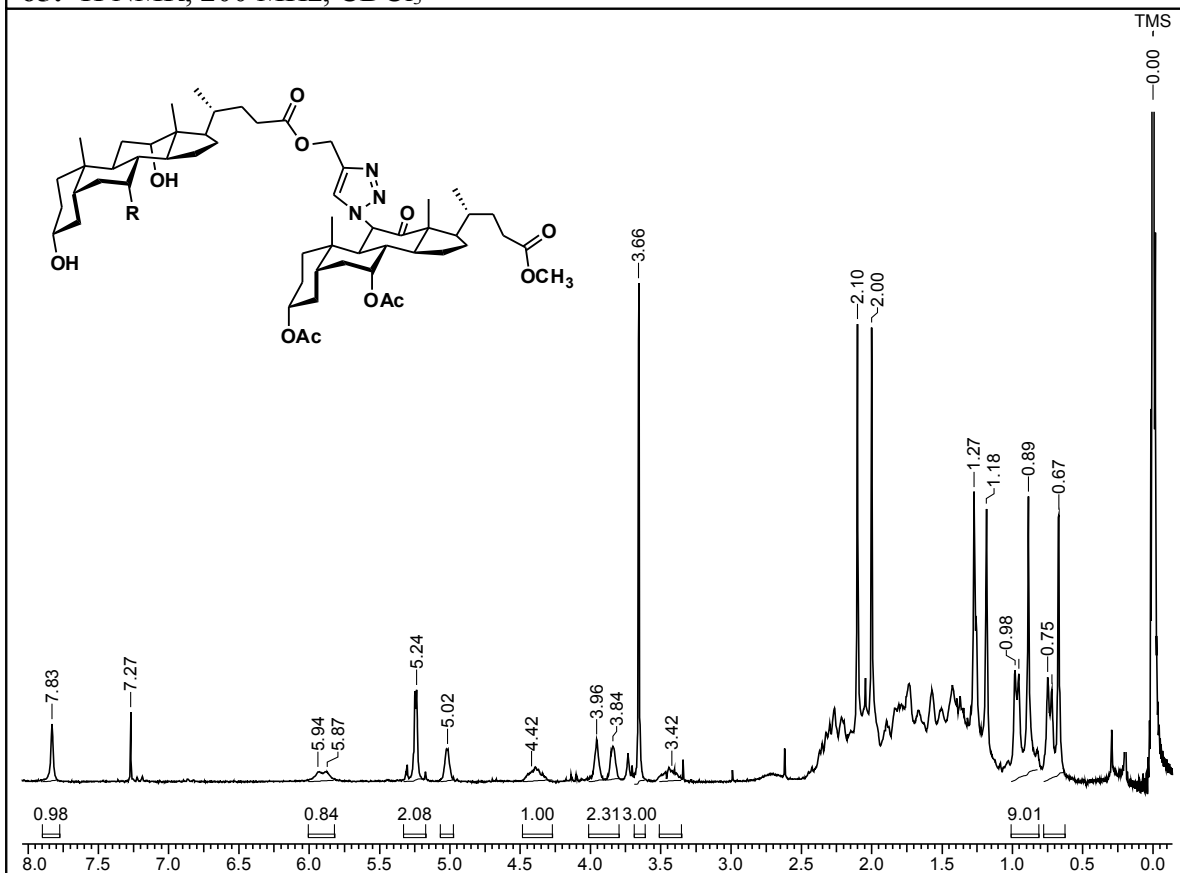
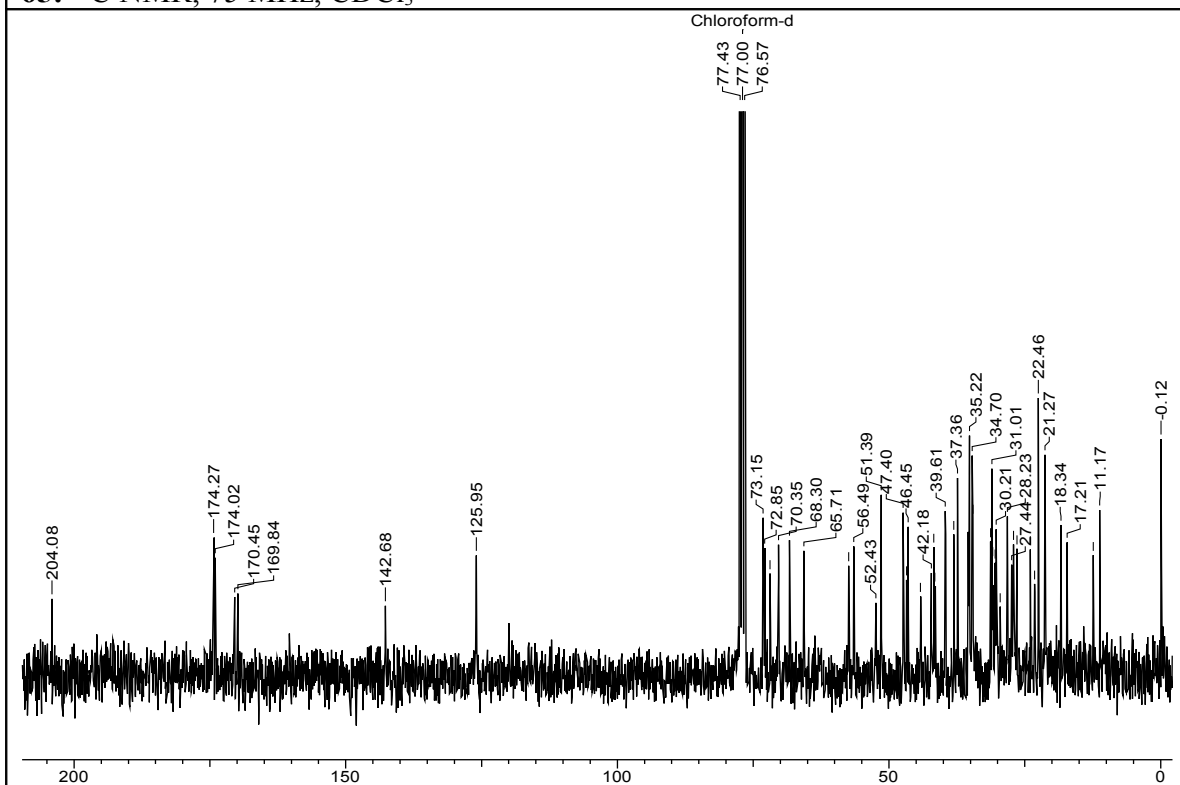
65: ^1H NMR, 200 MHz, CDCl_3 **65:** ^{13}C NMR, 75 MHz, CDCl_3 

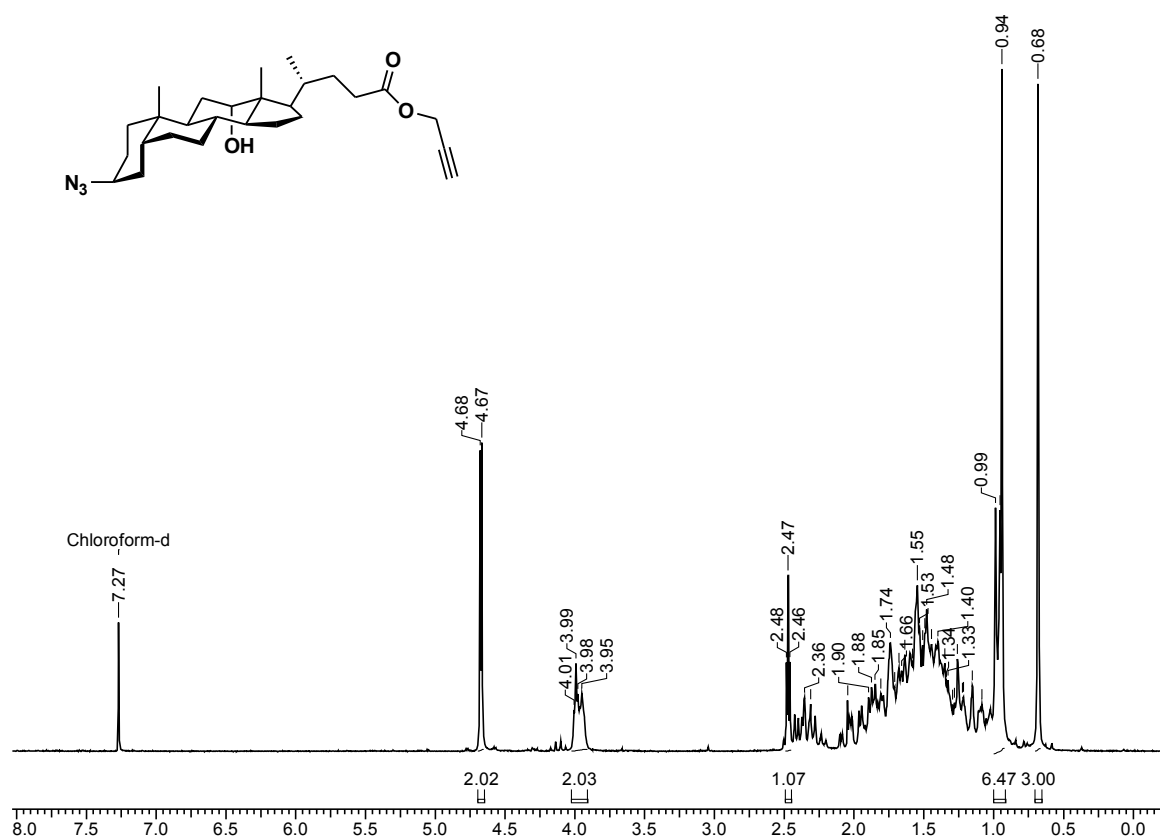
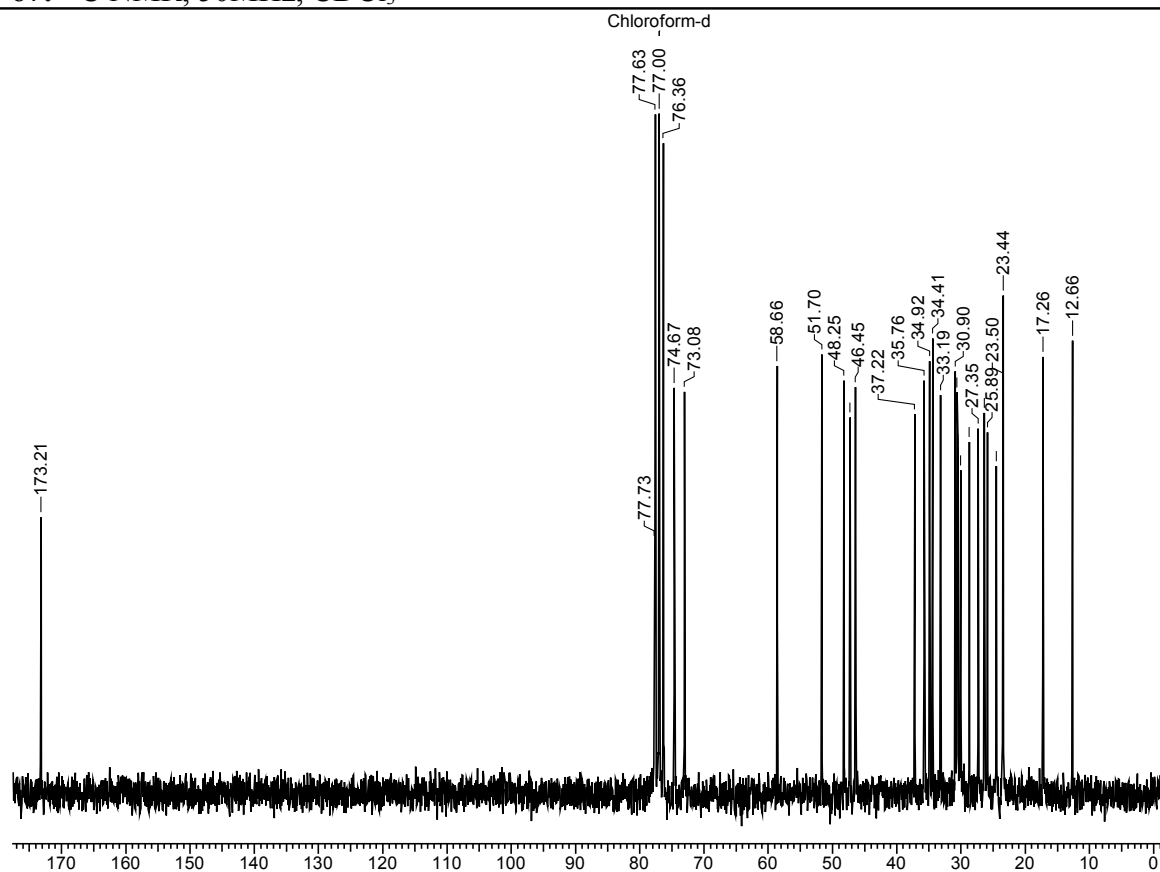
67: ^1H NMR, 200 MHz, CDCl_3 67: ^{13}C NMR, 50 MHz, CDCl_3 

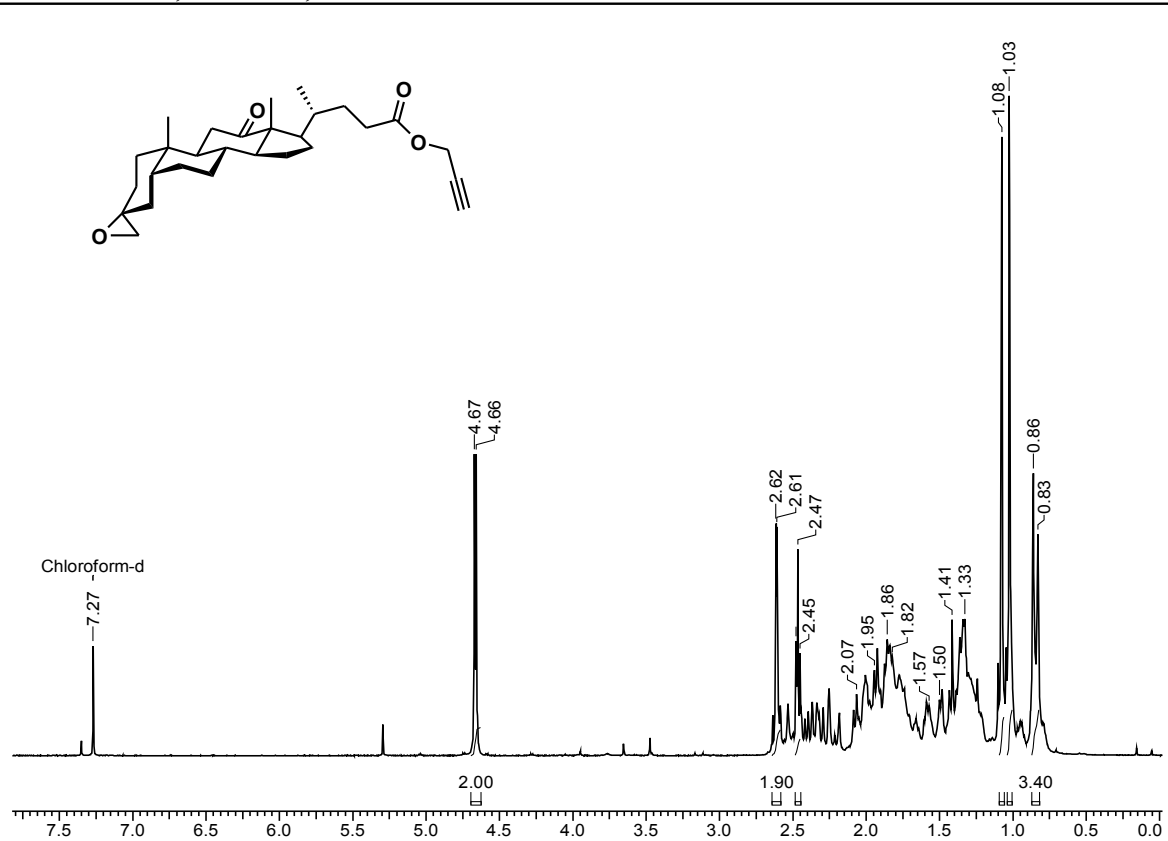
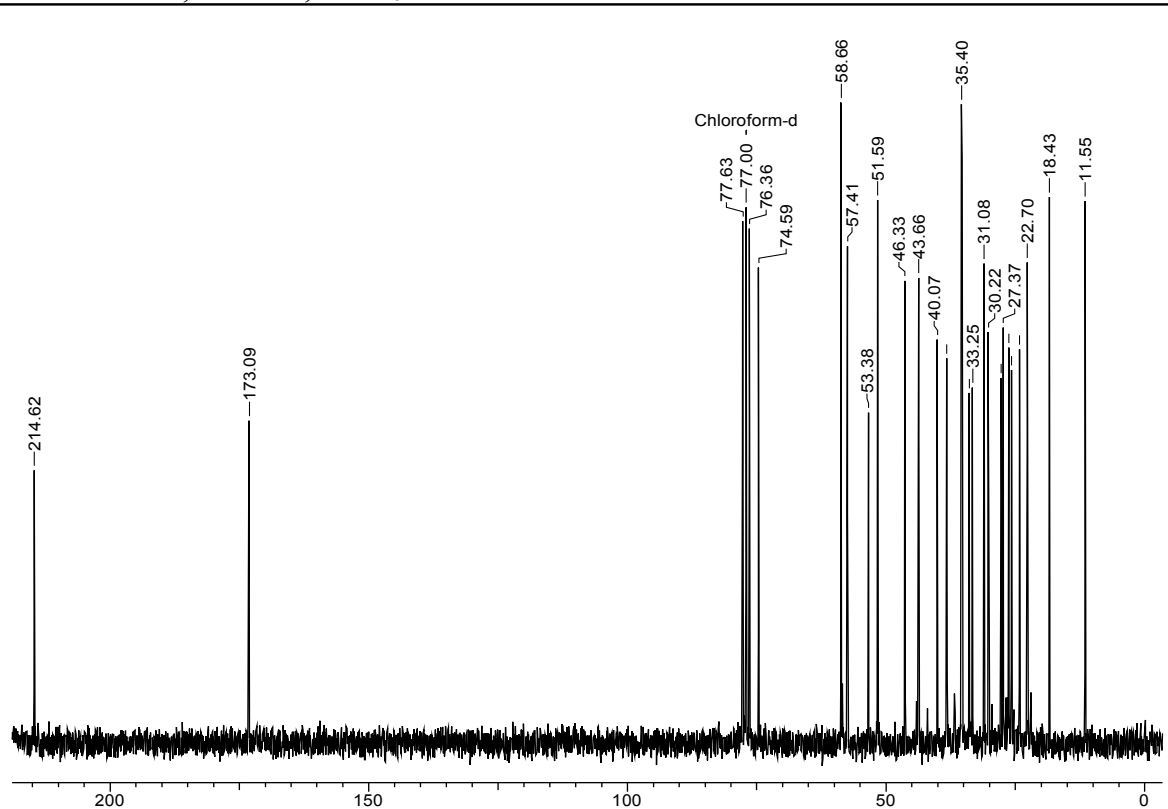
70: ^1H NMR, 200MHz, CDCl_3 70: ^{13}C NMR, 50 MHz, CDCl_3 

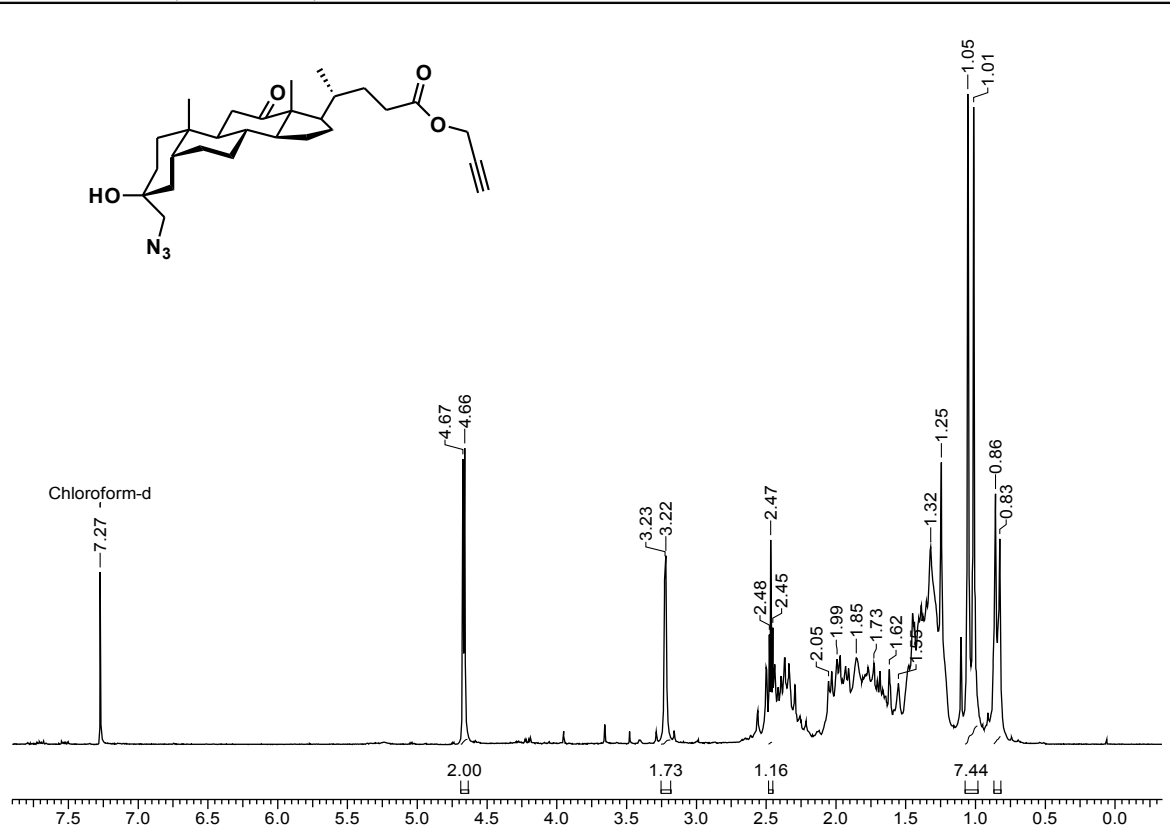
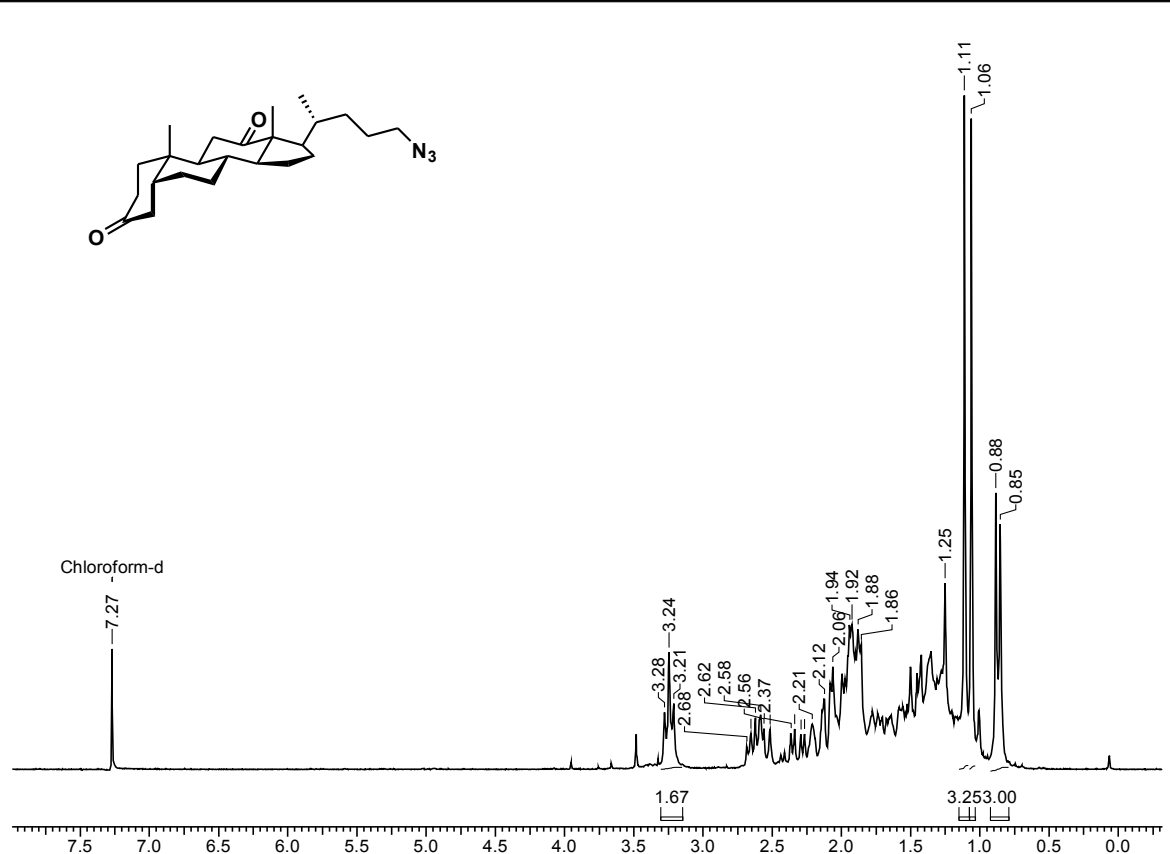
71: ^1H NMR, 200 MHz, CDCl_3 73: ^1H NMR, 200 MHz, CDCl_3 

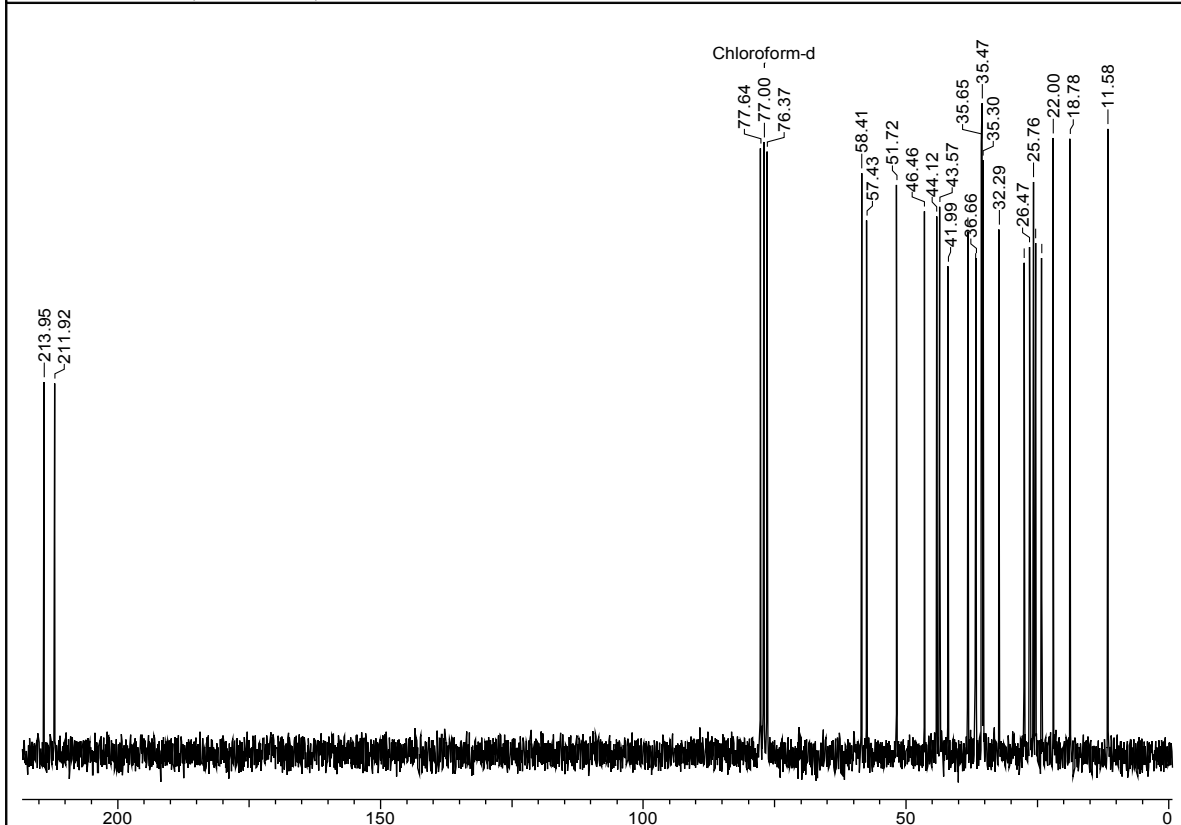
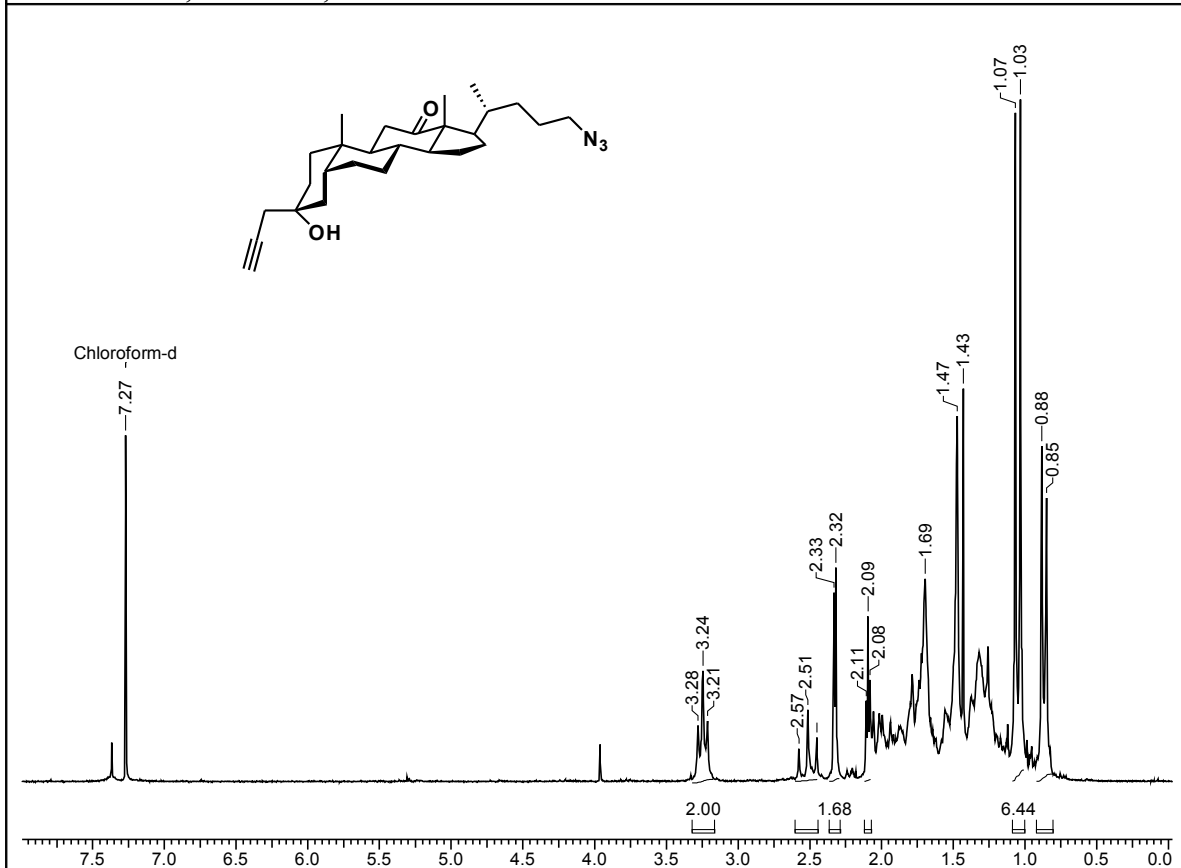
73: ^{13}C NMR, 50 MHz, CDCl_3 74: ^1H NMR, 200 MHz, CDCl_3 

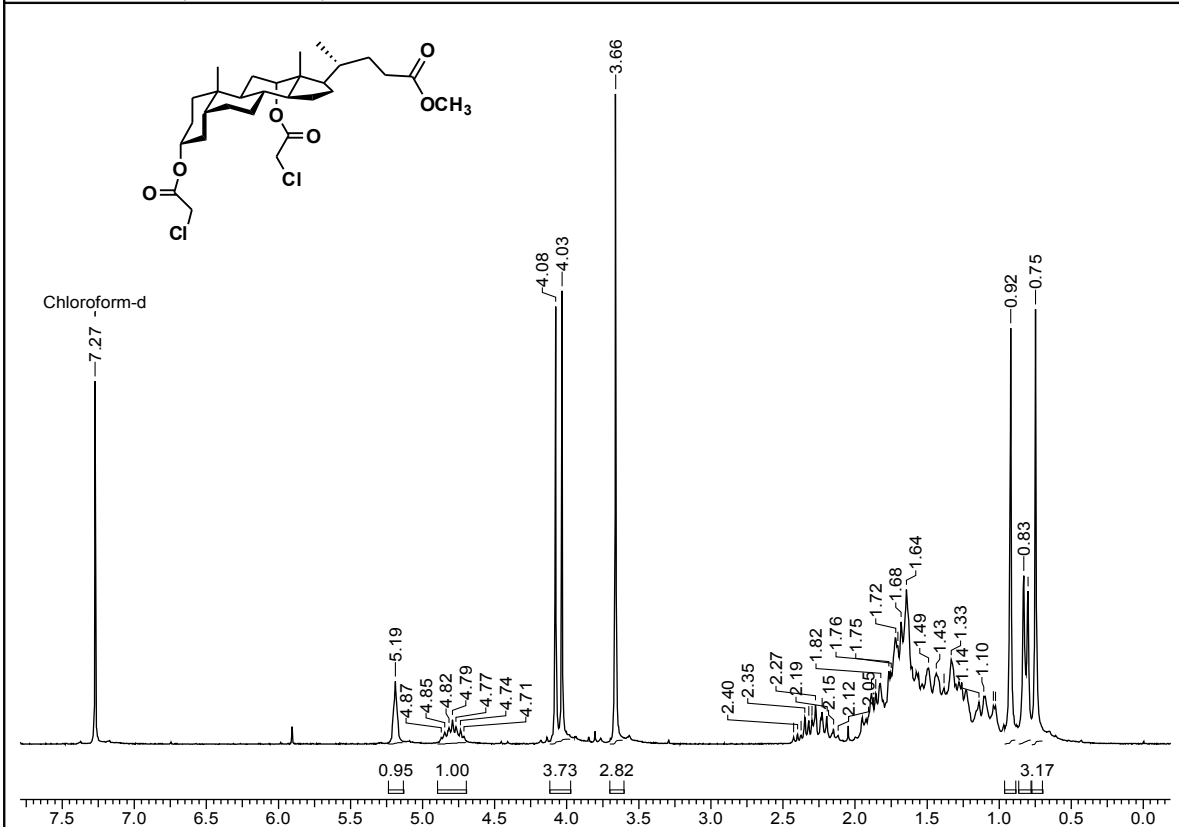
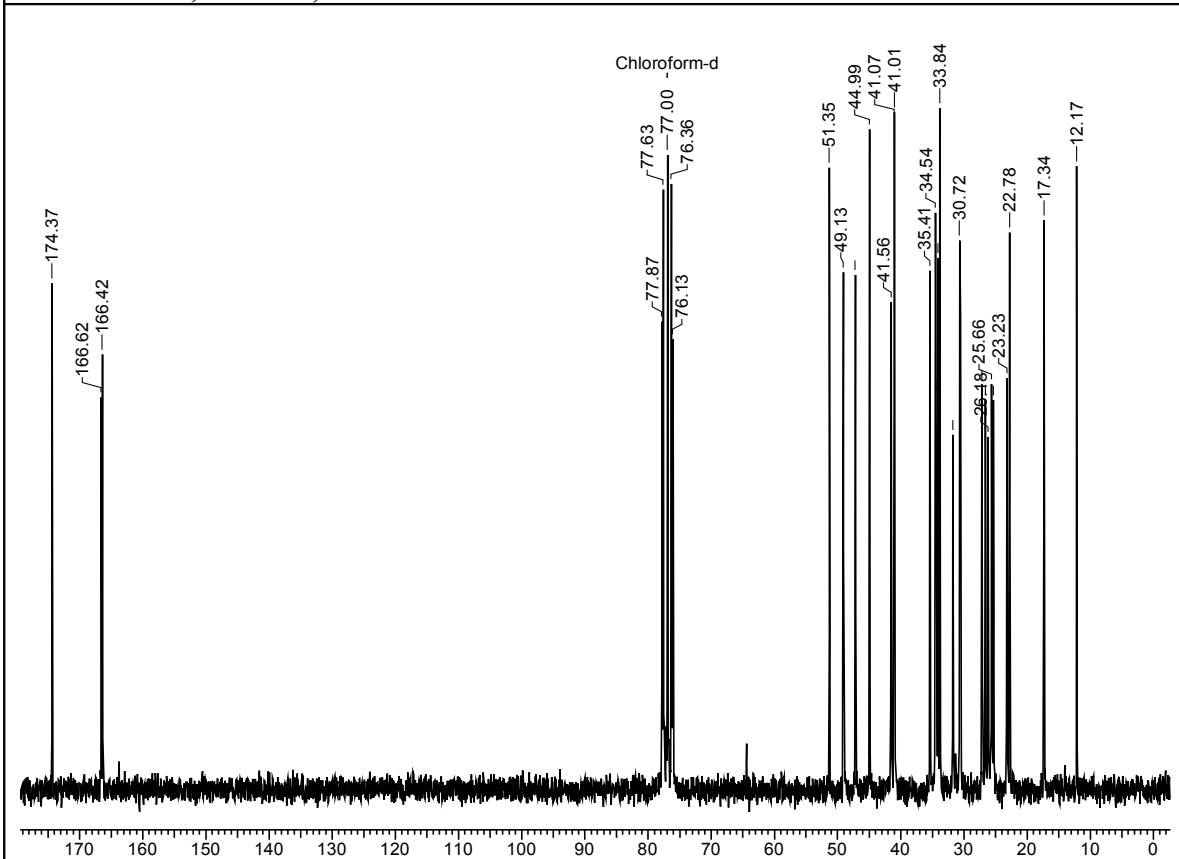
76: ^1H NMR, 200 MHz, CDCl_3 76: ^{13}C NMR, 50 MHz, CDCl_3 

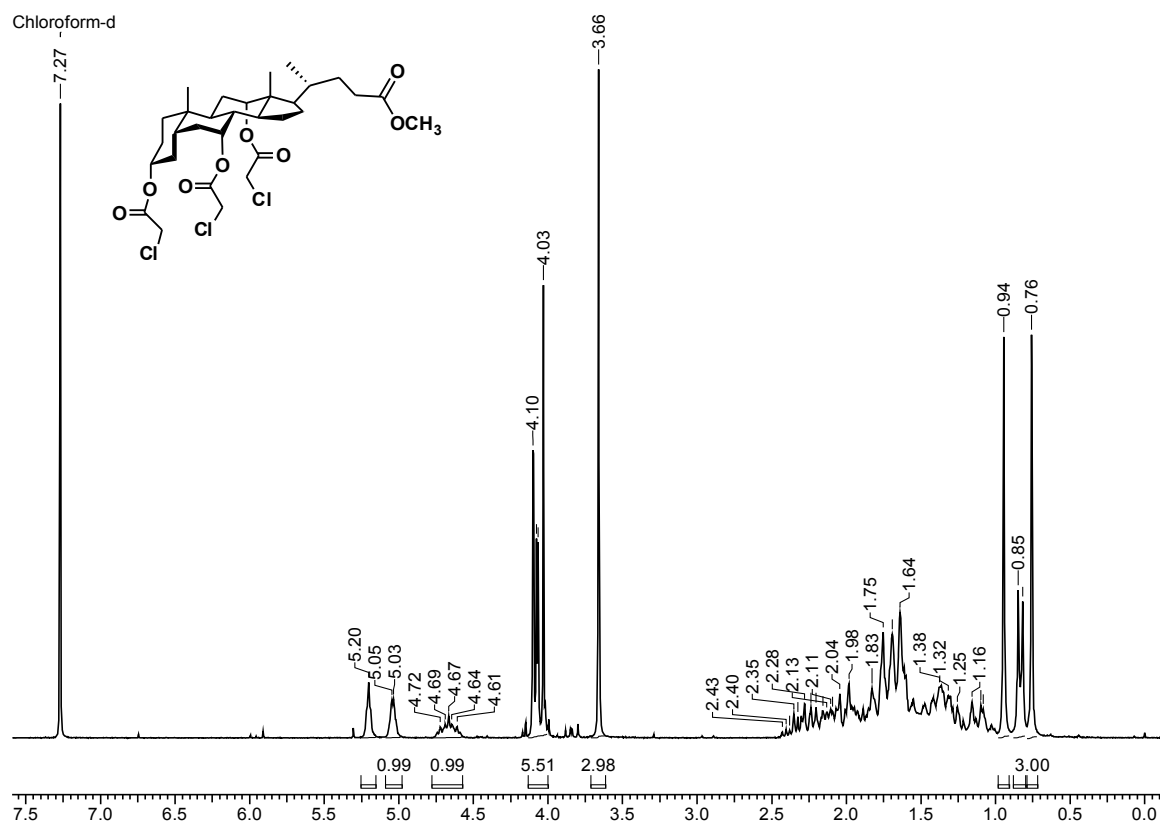
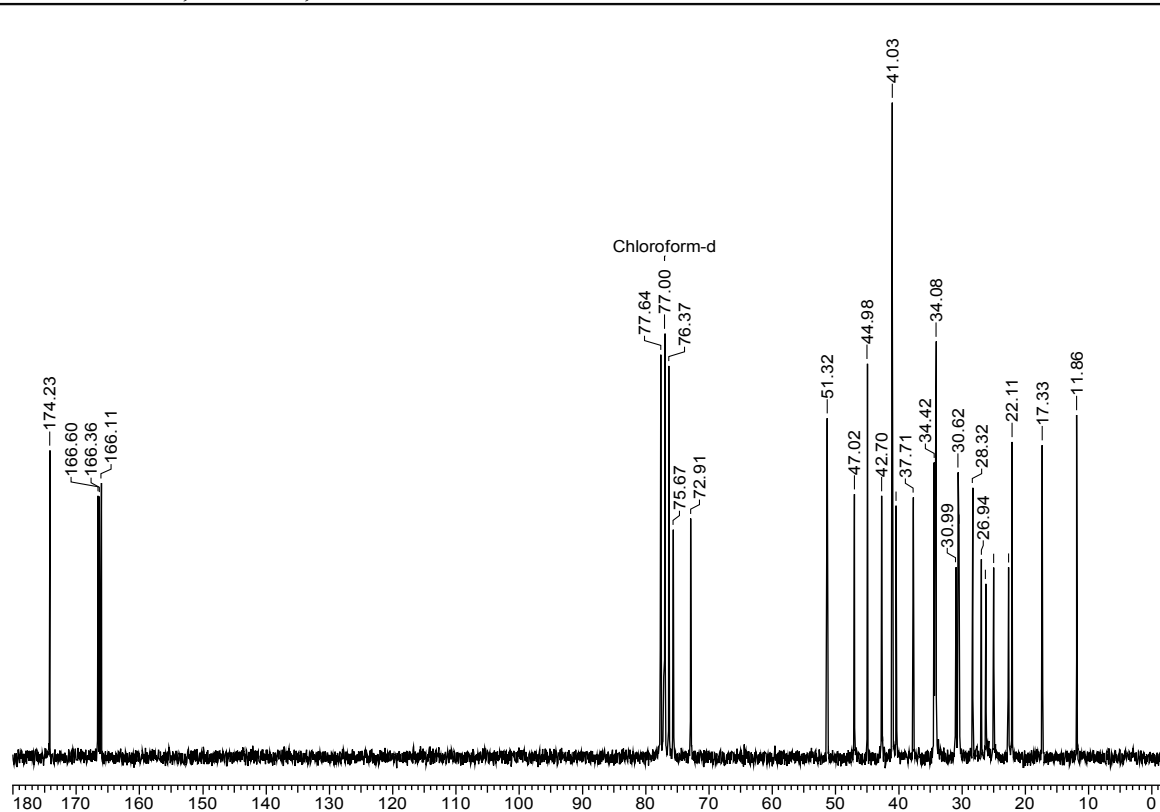
77: ^1H NMR, 200 MHz, CDCl_3 77: ^{13}C NMR, 50 MHz, CDCl_3 

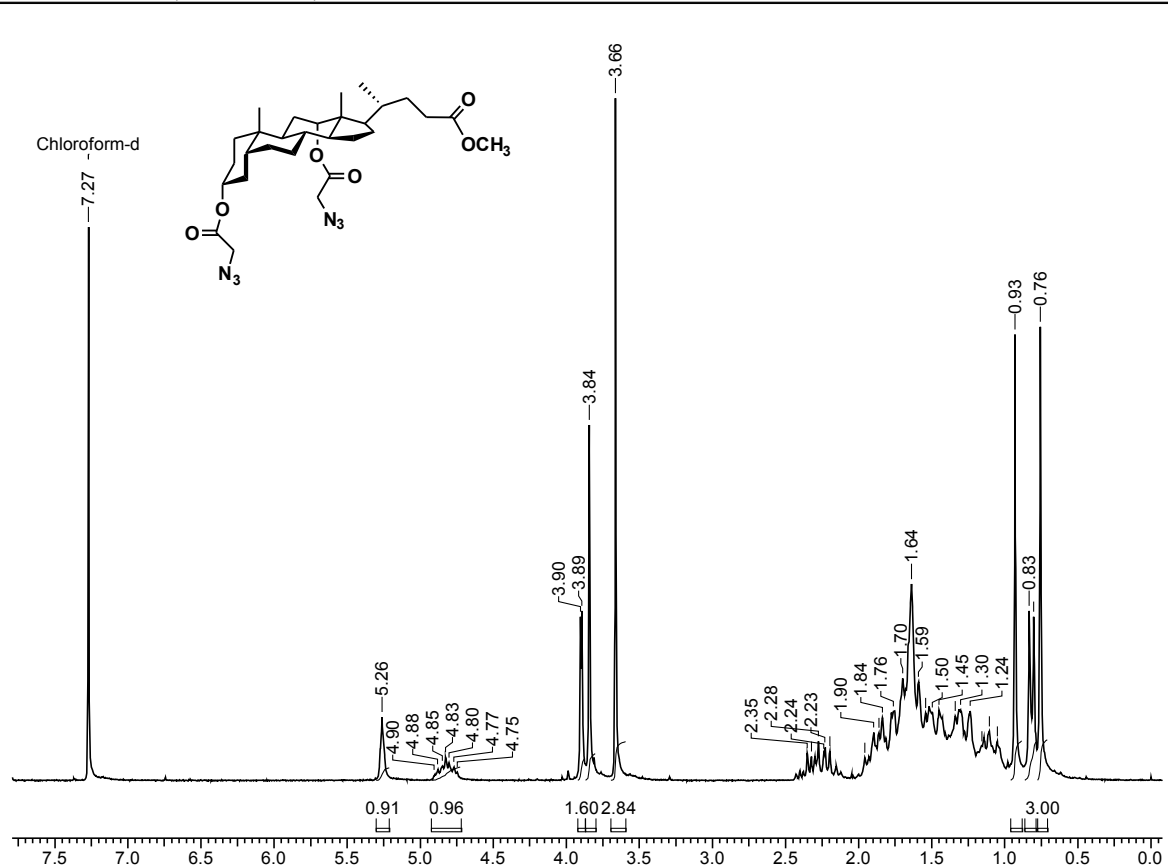
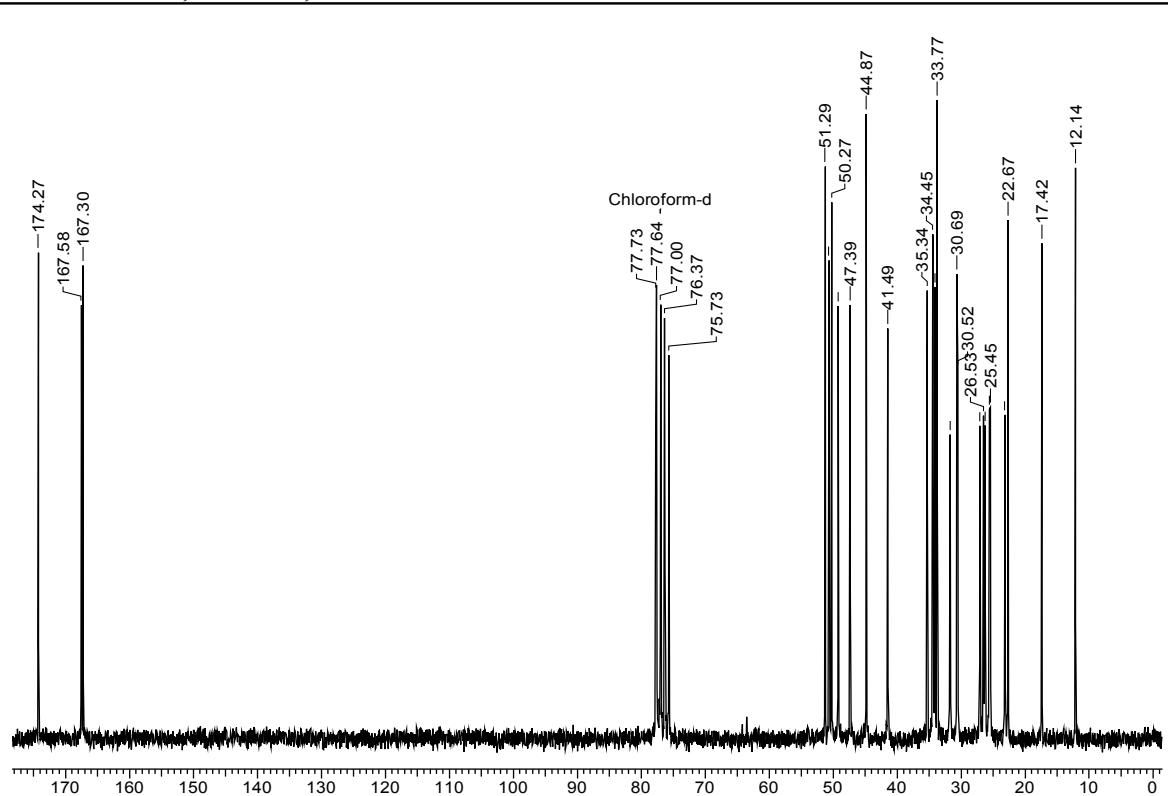
78: ^1H NMR, 200 MHz, CDCl_3 **78:** ^{13}C NMR, 50 MHz, CDCl_3 

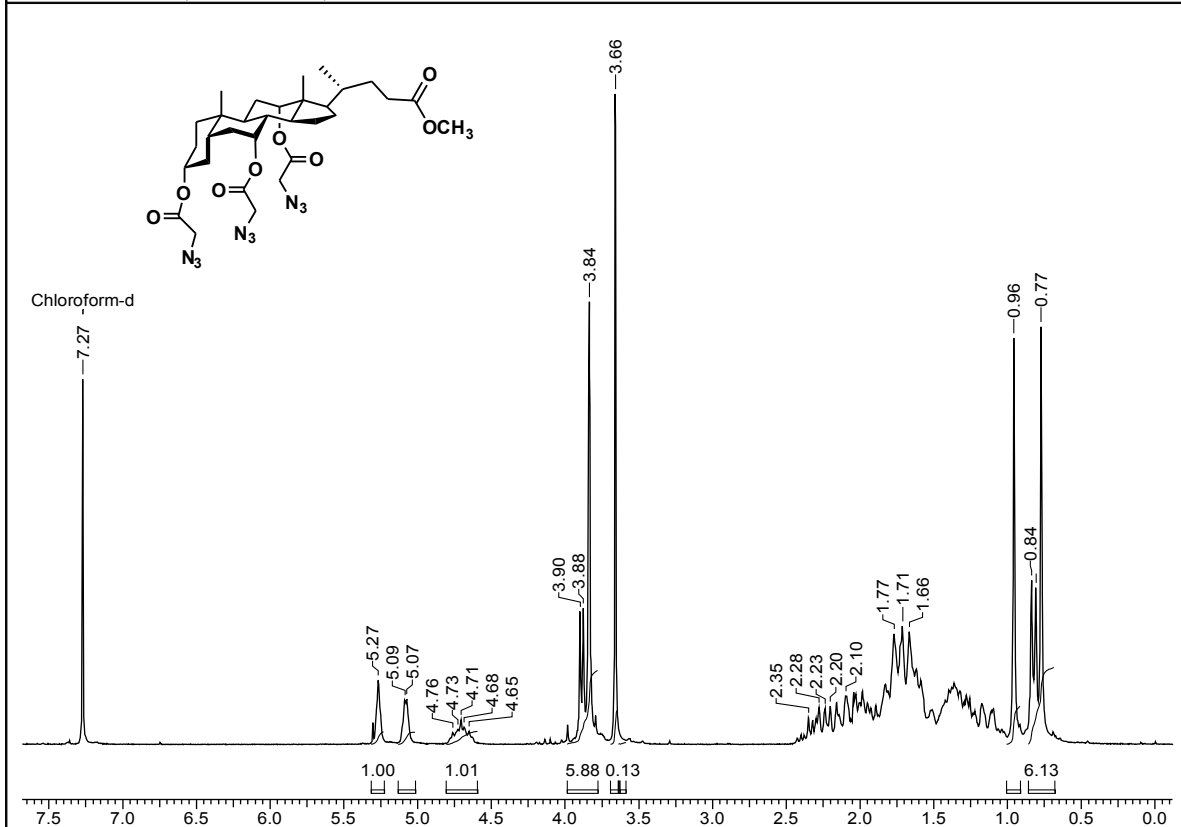
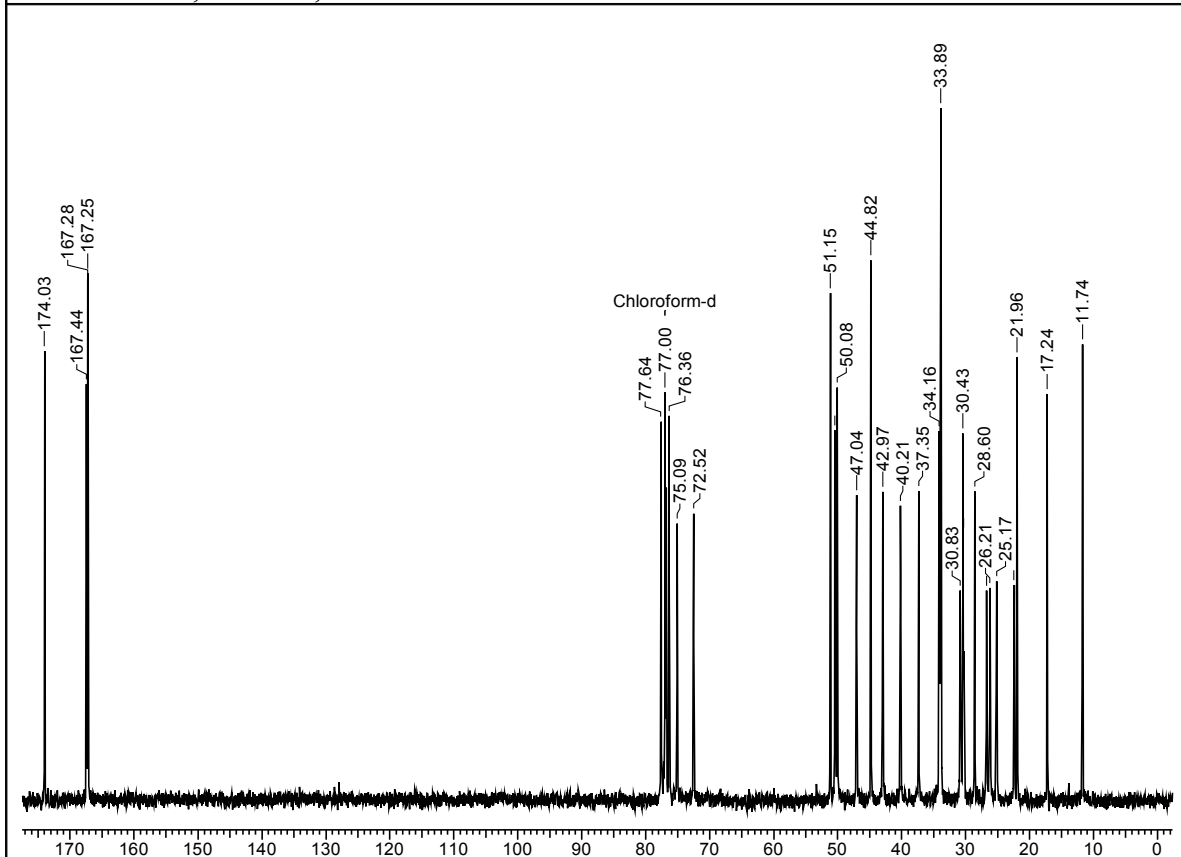
79: ^1H NMR, 200 MHz, CDCl_3 79: ^{13}C NMR, 50 MHz, CDCl_3 

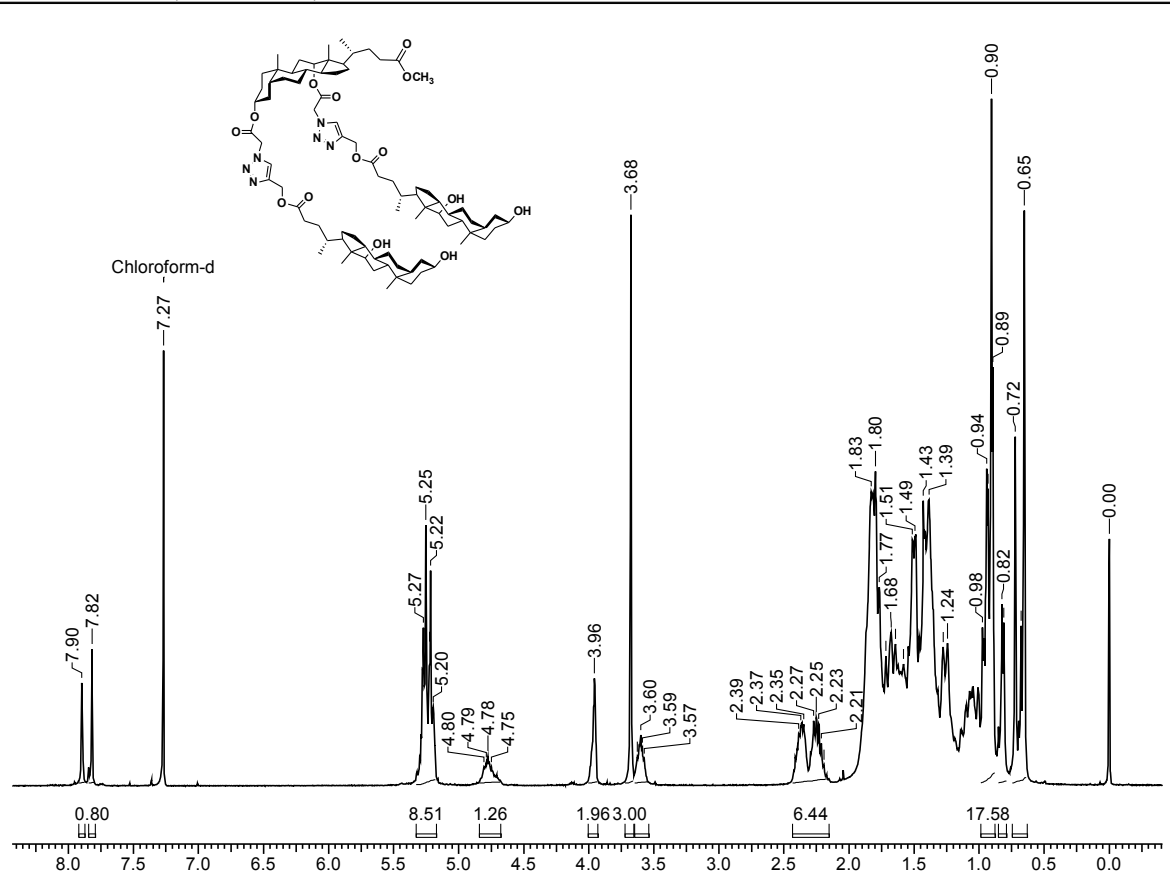
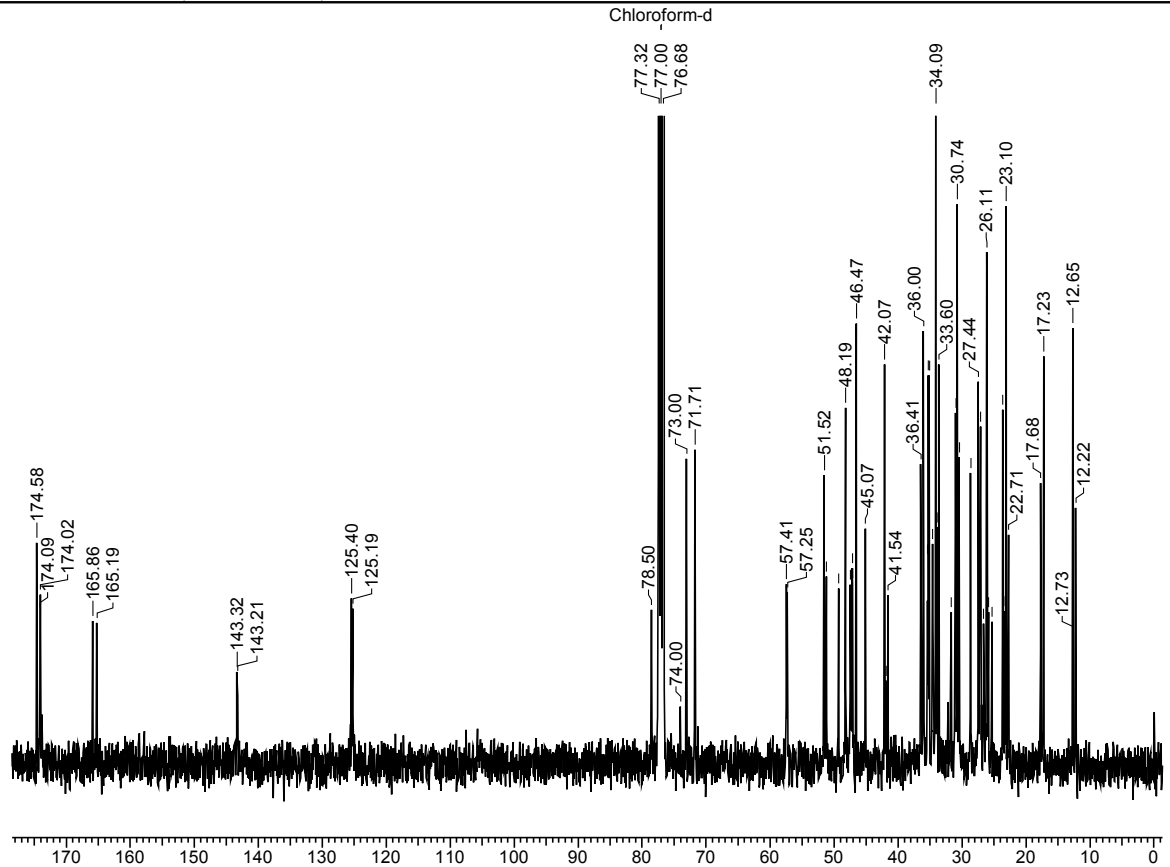
80: ^1H NMR, 400 MHz, CDCl_3 **80:** ^{13}C NMR, 100 MHz, CDCl_3 

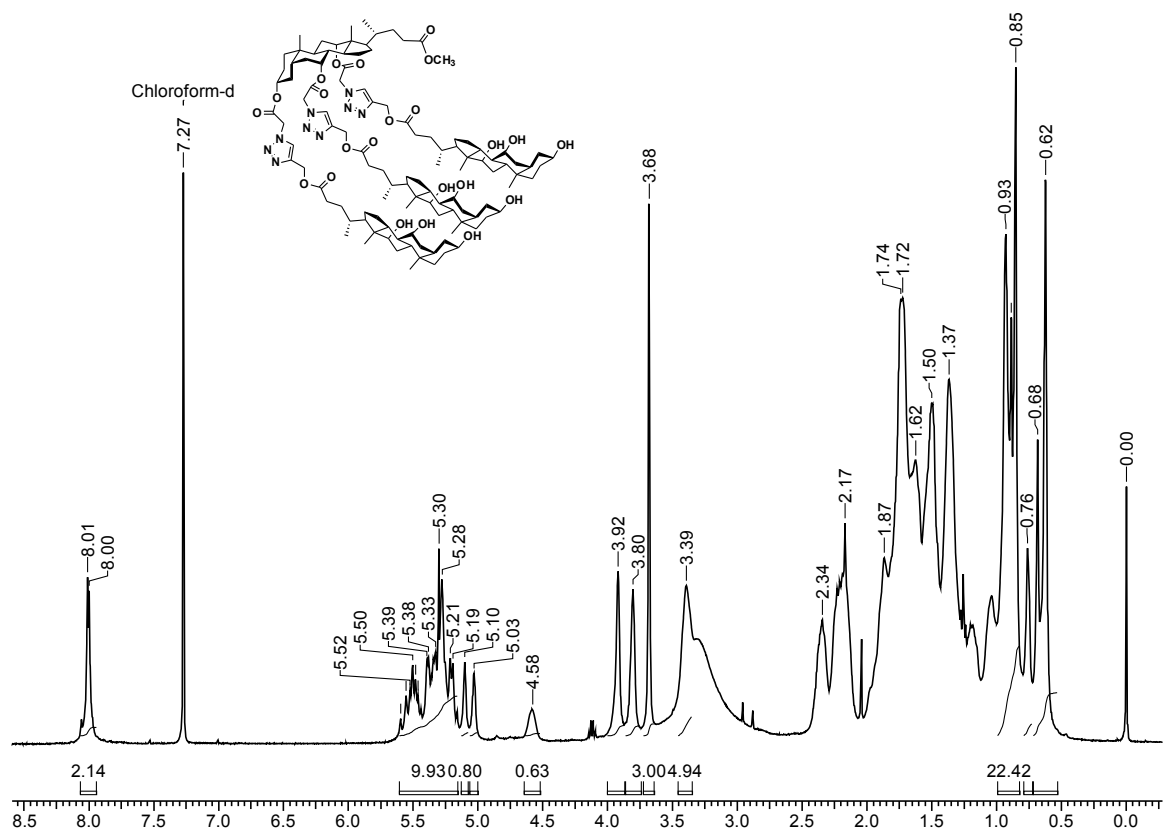
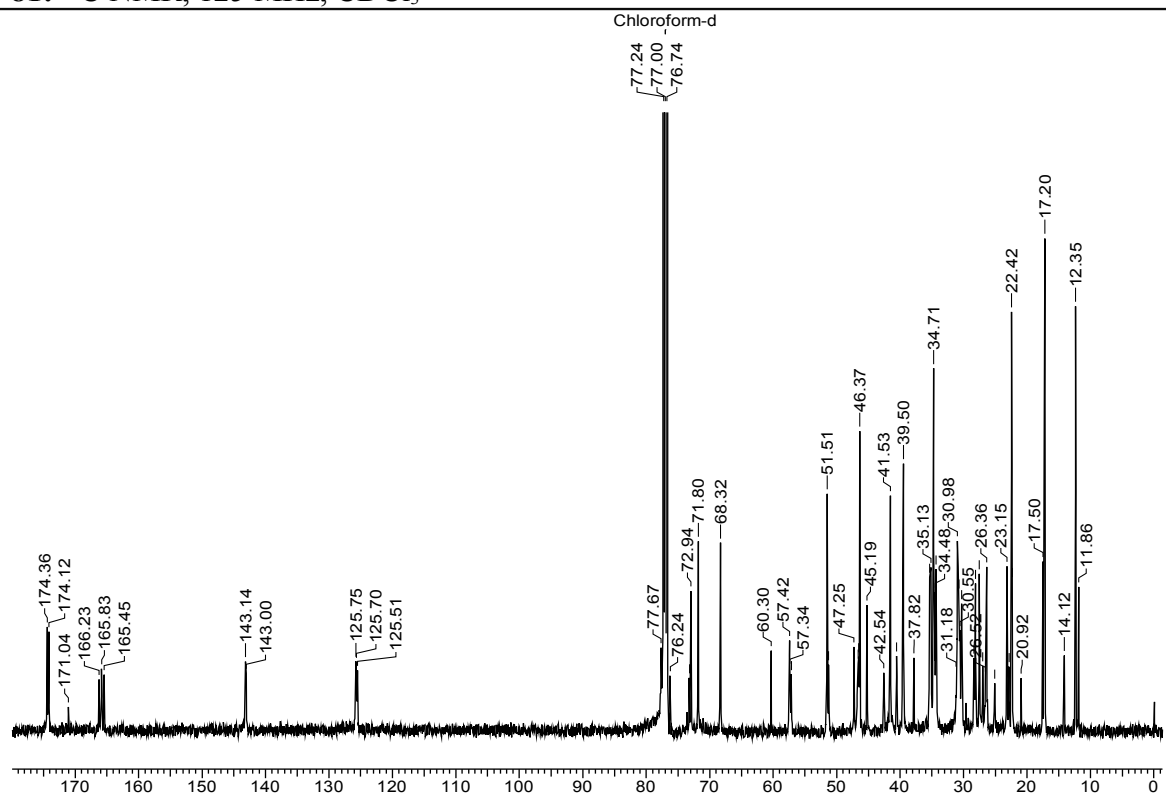
81: ^1H NMR, 500 MHz, CDCl_3 **81:** ^{13}C NMR, 125 MHz, CDCl_3 

1.8 References:

1. Davis, A. P. *Chem. Soc. Rev.* **1993**, 22, 243-253 and references cited therein.
2. Davis, A. P.; Bonar-Law, R. P.; Sanders, J. K. M. in *Comprehensive Supramolecular Chemistry* (Eds.: Atwood, J. L.; Davies, J. E. D.; MacNicol, D. D.; Vögtle, F.), Elsevier, Oxford, 1996, vol. 4, p. 257-286.
3. Miyata, M.; Sada, K.; in *Comprehensive Supramolecular Chemistry* (Eds.: Atwood, J. L.; Davies, J. E. D.; MacNicol, D. D.; Vögtle, F.), Elsevier, Oxford, 1996, vol. 6, p. 147-176.
4. Li, Y.; Dias, J. R. *Chem. Rev.* **1997**, 97, 283-304.
5. Wallimann, P.; Marti, T.; Fürer, A.; Diederich, F. *Chem. Rev.* **1997**, 97, 1567-1608.
6. Enhsen, A; Kramer, W.; Wess, G. *Drug Discovery Today* **1998**, 3, 409-418.
7. Hofmann, A. F. in *Bile Acids in Hepatobiliary Disease* (Eds.: Northfield, T. C.; Ahmed, H.; Jazwari, R.; Zentler-Munro, P.), Kluwer Academic Publishers, Lancaster, Hardbound, **2000**, vol. 110a, p. 303-332.
8. Tamminen, J.; Kolehmainen, E. *Molecules* **2001**, 6, 21-46.
9. Zhu, X. -X.; Nichifor, M. *Acc. Chem. Res.* **2002**, 35, 539-546.
10. Salunke, D. B.; Hazra, B. G.; Pore, V. S. *Arkivoc* **2003**, ix, 115-125.
11. Davis, A. P.; Joos, J. -B. *Coordination Chemistry Reviews* **2003**, 240, 143-156.
12. Virtanen, E.; Kolehmainen, E. *Eur. J. Org. Chem.* **2004**, 3385-3399.
13. Mukhopadhyay, S.; Maitra, U. *Curr. Sci.*, **2004**, 87, 1666-1683.
14. Davis, A. P. *Coordination Chemistry Reviews* **2006**, 250, 2939-2951.
15. Salunke, D. B.; Hazra, B. G.; Pore, V. S. *Curr. Med. Chem.* **2006**, 13, 813-847.
16. Davis, A. P. *Molecules* **2007**, 12, 2106-2122.
17. Sievänen, E. *Molecules* **2007**, 12, 1859-1889.
18. Nonappa; Maitra, U. *Org. Biomol. Chem.*, **2008**, 6, 657-669.
19. (a) Danielsson, H.; In *The Bile Acids: Chemistry, Physiology and Metabolism* (eds Nair, P. P. and Kritchevsky, D.), Plenum Press, New York, 1973, vol. 2, pp. 1-32; (b) *The Bile Acids: Chemistry, Physiology and Metabolism* (eds Nair, P. P. and Kritchevsky, D.), Plenum Press, New York, 1971-73, vol. 1-3; (c) Hofmann, A. F.; In *Bile Acids and Hepatobiliary Disease* (eds Northfield, T.; Zentler-Munro, P. L. and Jazrawi, R. P.), Kluwer, Boston, 1999, pp. 303-332 and references therein; (d) Carey, M. C.; In *Phospholipids and Atherosclerosis* (ed. Avogaro, P.), Raven Press, New York, 1983, pp. 33-63.

20. (a) Hofmann, A. F.; In *The Liver: Biology and Pathology* (eds Arias, I. M. *et al.*), Raven Press, New York, 1994, 3rd edn, p. 677; (b) Hofmann, A. F.; *News Physiol. Sci.*, **1999**, *14*, 24-29.
21. Cheng, Y.; Ho, D. M.; Gottlieb, C. R.; Kahne, D.; Bruck, M. A. *J. Am. Chem. Soc.* **1992**, *114*, 7319-7320.
22. Boyce, R.; Li, G.; Nestler, H. P.; Suenaga, T.; Still, W. C. *J. Am. Chem. Soc.* **1994**, *116*, 7955-7956.
23. Davis, A. P.; Perry, J. J.; Wareham, R.S. *Tetrahedron Lett.* **1998**, *39*, 4569-4572.
24. Maitra U.; D'Souza, L. J.; *J. Chem. Soc., Chem. Commun.* **1994**, 2793-2795; (b) Potluri, V. K.; Maitra, U.; *J. Org. Chem.* **2000**, *65*, 7764-7769.
25. Rao, P.; Maitra, U. *Supramol. Chem.*, **1998**, *9*, 325-328.
26. Irie, S.; Yamamoto, M.; Kishikawa, K.; Kohmoto, S.; Yamada, K. *Synthesis* **1996**, 1135-1138.
27. (a) Khatri, V.; Upreti, S.; Pandey, P. S. *Org. Lett.* **2006**, *8*, 1755- 1758. (b) Chahar, M.; Upreti, S.; Pandey, P. S. *Tetrahedron* **2007**, *63*, 171-176.; (c) Chahar, M.; Upreti, S.; Pandey, P. S. Khatri, V. K.; Chahar, M.; Pavani, K. ; Pandey, P. S. *J. Org. Chem*, **2007**, *72*, 10224-10226.
28. Maitra, U.; Bag, B. G. ; *J. Org. Chem.* **1992**, *57*, 6979-6981; (b) Maitra, U.; Bag, B. G.; Rao, P.; Powell, D. *J. Chem. Soc., Perkin Trans. 1* **1995**, 2049-2056.
29. (a) Maitra, U.; Mathivanan, P. *J. Chem. Soc., Chem. Commun.*, **1993**, 1469-1471.; (b) Maitra, U.; Mathivanan, P. *Tetrahedron: Asymmetry*, **1994**, *5*, 1171-1174.; (c) Maitra, U.; Bandyopadhyay, A. K. *Tetrahedron Lett.*, **1995**, *36*, 3749-3750; (d) Bandyopadhyaya, A. K.; Sangeetha, N. M. Maitra, U. *J. Org. Chem.*, **2000**, *65*, 8239-8244.
30. Bortolini, O.; Fantin, G. ; Fogagnolo, M. ; Forlani, R.; Maietti, S.; Pedrini, P. *J. Org. Chem.* **2002**, *67*, 5802-5806.
31. Hishikawa, Y.; Sada, K.; Watanabe, R.; Miyata, M.; Hanabusa, K. *Chem. Lett.* **1998**, 795-796 and references cited therein.
32. Maitra, U. ; Kumar, P. V.; Chandra, N.; D'Souza, L. J. ; Prasanna, M. D.; Raju, A. R. *Chem. Commun.* **1999**, 595-596.
33. Sangeetha, N. M.; Balasubramanian, R.; Maitra, U. ; Ghosh, S. ; Raju, A. R. *Langmuir* **2002**, *18*, 7154-7157.
34. Valkonen, A.; Lahtinen, M.; Virtanen, E.; Kaikkonen, S.; Kolehmainen, E. *Biosensors Bioelectronics*, **2004**, *20*, 1233-1241.

35. Virtanen, E.; Tamminen, J.; Linnanto, J.; Mänttari, P.; Vainiotalo, P.; Kolehmainen, E. *J. Inclusion Phenom. Macrocyclic Chem.* **2002**, *43*, 319-327.
36. Taotafa, U.; McMullin, D. B.; Lee, S. C.; Hansen, L. D.; Savage, P. B. *Org. Lett.* **2000**, *2*, 4117-4120.
37. (a) Sugahara, M.; Sada, K.; Miyata, M. *Chem. Commun.* **1999**, 293-284 and references cited therein; (b) Miyata, M.; Shibakami, M.; Chirachanchai, S.; Takemoto, K.; Kasai, N.; Miki, K. *Nature* **1990**, *343*, 446-447;
38. Gdaniec, M.; Polonski, T. *J. Am. Chem. Soc.* **1998**, *120*, 7353-7354.
39. Gdaniec, M.; Milewska, M. J.; Polonski, T. *Angew. Chem. Int. Edit. Engl.* **1999**, *38*, 392-395.
40. Burrows, C. J.; Sauter, R. A. *J. Inclusion Phenom.* **1987**, *5*, 117-121.
41. Kinneary, J. F.; Roy, T. M.; Albert, J. S.; Yoon, H.; Wagler, T. R.; Shen, L.; Burrows, C. J. *J. Inclusion Phenom.* **1989**, *7*, 155-168.
42. Hsieh, H. P.; Muller, J. G.; Burrows, C. J. *J. Am. Chem. Soc.* **1994**, *116*, 12077-12078.
43. McKenna, J.; McKenna, J. M.; Thornthwaite, D. W. *J. Chem. Soc., Chem. Commun.* **1977**, 809-811.
44. Janout, V.; Lanier, M.; Regen, S. L. *J. Am. Chem. Soc.* **1996**, *118*, 1573-1574.
45. (a) Vijayaraghavan, S.; Jing, B.; Vrablik, T.; Chou, T. -C.; Regen, S. L. *Bioconj. Chem.* **2003**, *14*, 667-671. (b) Jing, B.; Janout, V.; Herold, B. C.; Klotman, M. E.; Heald, T.; Regen, S. L. *J. Am. Chem. Soc.* **2004**, *126*, 15930-15931.
46. (a) Janout, V.; Jing, B.; Staina, I. V.; Regen, S. L. *J. Am. Chem. Soc.* **2003**, *125*, 4436-4437.; (b) Janout, V.; Jing, B.; Regen, S. L. *J. Am. Chem. Soc.* **2005**, *127*, 15862-15870.
47. Kobuke, Y.; Nagatani, T. *J. Org. Chem.* **2001**, *66*, 5094-5101.
48. Goto, C.; Yamamura, M.; Yoshino, N.; Satake, A.; Kobuke, Y. *J. Am. Chem. Soc.* **2001**, *123*, 12152-12159.
49. Yoshii, M.; Yamamura, M.; Satake, A.; Kobuke, Y. *Org. Biomol. Chem.* **2004**, *2*, 2619-2623.
50. (a) Riccardis, F. D.; Filippo, M. D.; Garrisi, D.; Izzo, I.; Mancin, F.; Pasquato, L.; Scrimin, P.; Tecilla, P. *Chem. Commun.* **2002**, 3066-3067; (b) Joachimiak, R.; Paryzek, Z. *J. Incl. Phenom. Macroc. Chem.* **2004**, *49*, 127-132.
51. a) Tamminen, J.; Kolehmainen, E.; Haapala, M.; Linnanto, J. *Synthesis* **2000**, 1464-1468; and references cited therein.; (b) Pandey, P. S.; Rai, R.; Singh, R. B. *J. Chem.*

- Soc.*, *Perkin Trans. 1* **2002**, 918-923.; and references cited therein.; (c) Pandey, P. S.; Singh, R. B. *Tetrahedron* **2002**, *58*, 355-362.
52. Davis, A. P.; Wareham, R. S. *Angew. Chem. Int. Edit.* **1999**, *38*, 2978-2996; and references cited therein.
53. Gouin, S.; Zhu, X. X. *Steroids* **1996**, *61*, 664-669.
54. (a) Kohmoto, S.; Sakayori, K.; Kishikawa, K.; Yamamoto, M. *J. Chem. Soc., Perkin Trans. 2* **1999**, 833-836.; (b) Potluri, V. K.; Maitra, U. *J. Org. Chem.* **2000**, *65*, 7764-7769; and references cited therein.
55. Bortolini, O.; Cora, V.; Fantin, G.; Medici, A. *Chem. Lett.* **1996**, 335-336.
56. Salunke, D. B.; Hazra, B. G.; Pore, V. S.; Bhat, M. K.; Nahar, P. B.; Deshpande, M. V. *J. Med. Chem.* **2004**, *47*, 1591-1594.
57. Aher, N. G.; Pore, V. S. *Synlett* **2005**, 2155-2159.
58. Aher, N. G.; Pore, V. S.; Patil, S. P. *Tetrahedron*, **2007**, *63*, 12927-12934.
59. Vatmurge, N. S.; Hazra, B. G.; Pore, V. S.; Shirazi, F.; Deshpande, M. V.; Kadreppa, S.; Chattopadhyay, S.; Gonnade, R. G. *Org. Biomol. Chem.*, **2008**, *6*, 3823-3830;
60. Zhang, Z.; Ju, Y.; Zhao, Y. *Chem. Letters* **2007**, *36*, 1450-1451.
61. Bonar-Law, R. P.; Davis, A. P. *J. Chem. Soc., Chem. Commun.* **1989**, 1050-1052.
62. Bonar-Law, R. P.; Davis, A. P.; Murray, B. A. *Angew. Chem. Int. Ed. Engl.* **1990**, *29*, 1407-1408.
63. Bhattarai, K. M.; Bonar-Law, R. P.; Davis, A. P.; Murray, B. A. *J. Chem. Soc., Chem. Commun.* **1992**, 752-754.
64. (a) Bonar_Law, R. P.; Davis, A. P. *Tetrahedron* **1993**, *49*, 9829-9844.; (b) Bonar_Law, R. P.; Davis, A. P. *Tetrahedron* **1993**, *49*, 9845-9854.; (c) Bonar_Law, R. P.; Davis, A. P.; Dorgan, B. J. *Tetrahedron* **1993**, *49*, 9855-9866.
65. Davis, A. P.; Wareham, R. S. *Angew. Chem. Int. Ed.* **1999**, *38*, 2978-2996.
66. Davis, A. P.; Walsh, J. J. *Chem. Commun.* **1996**, 449-451.
67. Davis, A. P.; Menzer, S.; Walsh, J. J.; Williams, D. J.; *Chem. Commun.* **1996**, 453-455.
68. Bhattarai, K. M.; Davis, A. P.; Perry, J. J.; Walter, C. J.; Menzer, S.; Williams, D. J. *J. Org. Chem.* **1997**, *62*, 8463-8473.
69. Albert, D.; Feigel, M. *Tetrahedron Lett.* **1994**, *35*, 565-568.
70. Albert, D.; Feigel, M. *Helv. Chim. Acta* **1997**, *80*, 2168-2181.

71. Albert, D.; Feigel, M.; Benet-Buchholz, J.; Boese, R. *Angew. Chem. Int. Ed.* **1998**, *37*, 2727-2729.
72. Inanaga, J.; Hirata, K.; Saeki, H.; Katsuki, T.; Yamaguchi, M. *Bull. Chem. Soc. Jpn.* **1979**, *52*, 1989-1993.
73. Kolehmainen, E.; Tamminen, J.; Lappalainen, K.; Torkkel, T.; Seppälä, R. *Synthesis* **1996**, 1082-1084.
74. Pandey, P. S.; Singh, R. B. *Tetrahedron Lett.* **1997**, *38*, 5045-5046.
75. Tamminen, J.; Kolehmainen, E.; Haapala, M.; Linnanto, J. *Synthesis* **2000**, 1464-1468.
76. Ra, C. S.; Cho, S. W.; Choi, J. W. *Bull. Korean Chem. Soc.* **2000**, *21*, 342-344.
77. Simpson, M. G.; Watson, S. P.; Feeder, N.; Davies, J. E., Sanders, J. K. M. *Org. Lett.*, **2000**, *10*, 1435-1438.
78. Haapala, M.; Kolehmainen, E.; Tamminen, J.; Kauppinen, R.; Linnanto, J.; Virtanen, E.; Suontamo, R.; Vainiotalo, P. *Mater. Sci. Eng., C* **2001**, *18*, 21-23.
79. Kikuchi, J.; Ariga, K.; Murakami, Y. *J. Supra. Chem. I* **2001**, 275-281.
80. Virtanen, E.; Tamminen, J.; Linnanto, J.; Mänttari, P.; Vainiotalo, P.; Kolehmainen, E. *J. Inclusion Phenom. Macrocyclic Chem.* **2002**, *43*, 319-327.
81. Pandey, P. S.; Rai, R.; Singh, R. B. *J. Chem. Soc., Perkin Trans. I* **2002**, 918-923.
82. Pandey, P. S.; Rai, R.; Singh, R. B. *Tetrahedron* **2002**, *58*, 355-362.
83. Virtanen, E.; Tamminen, J.; Haapala, M.; Mänttari, P.; Kauppinen, R.; Kolehmainen, E. *Magn. Reson. Chem.* **2003**, *41*, 567-576.
84. Virtanen, E.; Koivukorpi, J.; Tamminen, J.; Mänttari, P.; Kolehmainen, E. *J. Organomet. Chem.* **2003**, *668*, 43-50.
85. Ropponen, J.; Tamminen, J.; Lahtinen, M.; Linnanto, J.; Rissanen, K.; Kolehmainen, E. *Eur. J. Org. Chem.*, **2005**, 73-84.
86. Ghosh, S.; Choudhury, A. R.; GuruRow T. N.; Maitra, U.; *Org. Lett.*, **2005**, *7*, 1441-1444.
87. Averin, A. D.; Ranyuk, E. R.; Lukashev, N. V.; Beletskaya, I. P. *Chem. Eur. J.* **2005**, *11*, 7030-7039.
88. Wessjohann, L. A.; Rivera, D. G.; Coll, F. *J. Org. Chem.* **2006**, *71*, 7521-7526.
89. Ferhat Karabulut, H. R.; Rashdan, S. A.; Dias, J. R. *Tetrahedron* **2007**, *63*, 5030-5035.
90. Czajkowska, D.; Morzycki, J. W. *Tetrahedron Lett.* **2007**, *48*, 2851-2855.

91. Whitmarsh, S. D.; Redmond, A. P.; Sgarlata, V.; Davis, A. P. *Chem. Commun.* **2008**, 3669-3671.
92. Kohmoto, S.; Fukui, D.; Nagashima, T.; Kishikawa, K.; Yamamoto, M.; Yamada, K. *Chem. Commun.* **1996**, 1869-1870.
93. Kikuchi, J.-I.; Murakami, Y. *J. Inclusion Phenom. Mol. Recognit. Chem.* **1998**, *32*, 209-221.
94. Balasubramanian, R.; Rao, P.; Maitra, U. *Chem. Commun.* **1999**, 2353-2354.
95. Yoshino, N.; Satake, A.; Kobuke, Y. *Angew. Chem. Int. Ed.* **2001**, *40*, 457-459.
96. Bonar-Law, R. P. and Sanders, J. K. M., *Tetrahedron Lett.* **1992**, *33*, 2071-2074.
97. (a) Bonar-Law, R. P., Sanders, J. K. M., *J. Am. Chem. Soc.* **1995**, *117*, 259-271; (b) Bonar-Law, R. P. and Sanders, J. K. M., *J. Chem. Soc., Chem. Commun.* **1991**, 574-577.
98. (a) Bonar-Law, R. P., Mackay, L. G., Sanders, J. K. M. *J. Chem. Soc., Chem. Commun.* **1993**, 456-458; (b) Mackay, L. G., Bonar-Law, R. P. and Sanders, J. K. M., *J. Chem. Soc., Perkin Trans. 1*, 1993, 1377-1378.
99. Maitra, U.; Mukhopadhyay, S.; Sarkar, A.; Rao, P.; Indi, S. S. *Angew. Chem. Int. Ed.* **2001**, *40*, 2281-2283.
100. Mukhopadhyay, S.; Ira; Krishnamoorthy, G.; Maitra, U. *J. Phys. Chem. B* **2003**, *107*, 2189-2192.
101. Ropponen, J., Tamminen, J., Kolehmainen, E. and Rissanen, K., *Synthesis*, **2003**, 2226-2230.
102. (a) Vijayalakshmi, N.; Maitra, U. *J. Org. Chem.* **2006**, *71*, 768-774; (b) Ghosh, S.; Maitra, U. *Org. Lett.* **2006**, *8*, 399-402.; (c) Balasubramanian, R.; Maitra, U. *J. Org. Chem.* **2001**, *66*, 3035-3040.
103. (a) Huisgen, R. *Angew. Chem.* **1963**, *75* (13), 604-637.; (b) Huisgen, R. *J. Org. Chem.* **1976**, *41*, 403-419; (c) Gothelf, K. V.; Jørgensen, K. A. *Chem. Rev.* **1998**, *98*, 863-909.
104. (a) Rostovtsev, V. V.; Green, L. G.; Fokin, V. V.; Sharpless, K. B. *Angew. Chem. Int. Ed.* **2002**, *41*, 2596-2599; (b) Tornøe, C. W.; Christensen, C.; Meldal, M. *J. Org. Chem.* **2002**, *67*, 3057-3064.
105. Kolb, H. C.; Finn, M. G.; Sharpless, K. B. *Angew. Chem. Int. Ed.* **2001**, *40*, 2004-2021.
106. (a) Sustmann, R. *Tetrahedron Lett.* **1971**, *29*, 2717-2720.; (b) Bräse, S.; Gil, C.; Knepper, K.; Zimmermann, V. *Angew. Chem. Int. Ed.* **2005**, *44*, 5188-5240.

107. (a) Himo, F.; Lovell, T.; Hilgraf, R.; Rostovtsev, V. V.; Noodleman, L.; Sharpless, K. B.; Fokin, V. V. *J. Am. Chem. Soc.* **2005**, *127*, 210-216.; (b) Bock, V. D.; Hiemstra, H.; Van Maarseveen, J. H. *Eur. J. Org. Chem.* **2006**, 51-68.
108. (a) Kolb, H. C.; Sharpless, K. B. *Drug Discovery Today* **2003**, *8*, 1128-1136.
109. (a) Weber, L. *Drug Disc. Today* **2004**, *1*, 261-267.; (b) Meldal, M.; Tornøe, C. W. *Chem. Rev.* **2008**, *108*, 2952-3015.
110. (a) Oh, K.; Guan, Z. A. *Chem. Commun.* **2006**, *29*, 3069-3071.; (b) Horne, W. S.; Yadav, M. K.; Stout, C. D.; Ghadiri, M. R. *J. Am. Chem. Soc.* **2004**, *126*, 15366-15367.
111. (a) Alvarez, R.; Velazquez, S.; San-Felix, A.; Aquaro, S.; De Clercq, E.; Perno, C. F.; Karlsson, A.; Balzarini, J.; Camarasa, M. J. *J. Med. Chem.* **1994**, *37*, 4185-4194.; (b) Whiting, M.; Tripp, J. C.; Lin, Y. -C.; Lindstrom, W.; Olson, A. J.; Elder, J. H.; Sharpless, K. B.; Fokin, V. V. *J. Med. Chem.* **2006**, *49*, 7697-7710.; (c) Hosahudya, N.; Gopi, H. N.; Tirupula, K. C.; Baxter, S.; Ajiith, S.; Chaiken, I. W. *Chem. Med. Chem.* **2006**, *1*, 24-57; (d) Whiting, M.; Muldoon, J.; Lin, Y. -C.; Silverman, S. M.; Lindstrom, W.; Olson, A. J.; Kolb, H. C.; Fin, M. G.; Sharpless, K. B.; Elder, J. H.; Fokin, V. V. *Angew. Chem. Int. Ed.* **2006**, *45*, 1435-1439.
112. (a) Genin, M. J.; Allwine, D. A.; Anderson, D. J.; Barbachyn, M. R.; Emmert, D. E.; Garmon, S. A.; Graber, D. R.; Grega, K. C.; Hester, J. B.; Hutchinson, D. K.; Morris, J.; Reischer, R. J.; Ford, C. W.; Zurenko, G. E.; Hamel, C. J.; Schaadt, R. D.; Stapert, D.; Yagi, B. H. *J. Med. Chem.* **2000**, *43*, 953-970.; (b) Dabak, Ö.; Sezer, A.; Akar, O. *Eur. J. Med. Chem.* **2003**, *38*, 215-218.
113. Wamhoff, In *Comprehensive Heterocyclic Chemistry*, Katritzky, A. R., Rees, C. W.; Eds.; Pergamon: Oxford, **1984**; pp 669-732.
114. Buckle, D. R.; Rockell, C. J. M.; Smith, H.; Spicer, B. A. *J. Med. Chem.* **1986**, *29*, 2262-2267.
115. Brockunier, L. L.; Parmee, E. R.; Ok, H. O.; Candelore, M. R.; Cascieri, M. A.; Colwell, L. F.; Deng, L.; Feeney, W. P.; Forrest, M. J.; Hom, G. J.; MacIntyre, D. E.; Tota, L. Wyvratt, M. J.; Fisher, M. H.; Weber, A. E. *Bioorg. Med. Chem. Lett.* **2002**, *10*, 2111-2114.
116. Cunha, A. C.; Figueiredo, J. M.; Tributino, J. L. M.; Miranda, A. L. P.; Castro, H. C.; Zingali, R. B.; Fraga, C. A. M.; de Souza, M. C. B. V.; Ferreira, V. F.; Barreiro, E. J.; *Bioorg. Med. Chem.* **2003**, *11*, 2051-2059.

117. (a) Tullis, J. S.; VanRens, J. C.; Natchus, M. G.; Clark, M. P.; De, B.; Hsieh, L. C.; Janusz, M. J. *Bioorg. Med. Chem. Lett.* **2003**, *13*, 1665-1668.; (b) Kim, D.-K.; Kim, J.; Park, H.-J. *Bioorg. Med. Chem. Lett.* **2004**, *14*, 2401-2405.
118. (a) Davis, A. P.; Perez-Payan, M. N. *Synlett.* **1999**, *S1*, 991-993; (b) Lawless, Laurence J., Davis, A. P. *J. Chem. Soc., Perkin Trans. 1* **2001**, 1329-1341.
119. Salunke, D. B.; Hazra, B. G.; Gonnade, R. G.; Bhadbhade, M. M.; Pore, V. S. *Tetrahedron*, **2005**, *61*, 3605-361.
120. (a) Chang, F. C.; Wood, N. F.; Holton, W. G. *J. Org. Chem.* **1965**, *30*, 1718-1723.; (b) Cortese F. *J. Am. Chem. Soc.* **1937**, *59*, 2532-2534.; (c) Li, C.; Peters A. S.; Meredith E. L.; Allman G. W.; Savage P. B. *J. Am. Chem. Soc.* **1998**, *120*, 2961-2962.; (d) Blickenstaff, R. T.; Chang, F. C. *J. Am. Chem. Soc.* **1959**, *81*, 2835-2838.; (e) Ruzicka, L.; Goldberg, M. W. *Monatsh* **1951**, *82*, 437.
121. Sofia, M. J.; Kakarla, R.; Kagan, N.; Dulina, R.; Hui, Y. W.; Hatzenbuehler, N. T.; Lui, D.; Chen, A.; Wagler T. *Bioorg. Med. Chem. Lett.* **1997**, *7*, 2251-2254.
122. (a) Chen, A. K.; Kakarla, R.; Liu, D.; Sofia, M. J.; Zebovitz, T. C.; *Patent* **1996**, WO 9600230 A1; (b) Anelli, P. L.; Lattuada, L.; Uggeri, F. *Synth. Commun.* **1998**, *28*, 109-117.

Chapter 2

Synthesis of bile acid-fluconazole conjugates, new fluconazole analogues using click reaction, bile acid based amino alcohols and their bioevaluation.

Chapter 2

Section-I

Synthesis of bile acid-fluconazole conjugates and new fluconazole analogues using click reaction and their bioevaluation.

2.1.1 Abstract

Novel fluconazole-bile acid conjugates and fluconazole mimics were designed and synthesized in very high yield *via* Cu(I) catalyzed intermolecular 1,3-dipolar cycloaddition. The studies presented here provide structural modification of fluconazole to give 1,2,3-triazole containing molecules. These new molecules showed good antifungal activity. Their antifungal activities were evaluated *in vitro* by measuring the minimal inhibitory concentrations (MICs). Compounds **64**, **69** and **72** are more potent against *Candida* fungal pathogens than control drugs fluconazole and amphotericin B. Furthermore these molecules were evaluated *in vivo* against *C. albicans* intravenous challenge in Swiss mice and antiproliferative activities were tested against human hepatocellular carcinoma Hep3B and human epithelial carcinoma A431. It was found that compound **69** resulted in 97.4% reduction in fungal load in mice and did not show any profound proliferative effect at lower dose (0.001 mg/mL).

2.1.2 Introduction

Bioconjugation has generated significant research interest as it provides an easy way to couple two or more molecules with distinct properties thereby producing a novel complex structure (bioconjugate) that possesses the combined properties of its individual components.¹⁻³ Over the years, several bioconjugates have been prepared for use in research, therapeutics and diagnostics.⁴⁻⁶ The results from these studies show that bioconjugation indeed adds significant benefits to the biomolecules being conjugated. For instance, it may result in an increase in stability to chemical or proteolytic degradation, reduced immunogenicity, or improved pharmacokinetics, biodistribution and targeting.^{1,2,7} The conjugation of two or more biomolecules is mostly achieved by incorporating mutually reactive groups into the individual components, followed by their coupling in solution, leading to the formation of stable chemical linkages like amides, thioethers, disulfides or oximes.^{1,2} Such strategies have found wide acceptance because of the high coupling efficiency and ease of purification. Several such cross-coupling agents have been developed and studied earlier for the preparation of bioconjugates.⁸

In this context, we designed and synthesized new bile acid-fluconazole conjugates. In these bioconjugates one component is bile acid having amphiphilic nature like amphotericin-B and other component is pharmacophore of fluconazole (anazole based antifungal drug). These two components have been linked together with 1,2,3-triazole, by “Click reaction.” 1,2,3-Triazole is not only a passive linker but also viewed as an isoster of 1,2,4-triazole moiety of fluconazole.

2.1.3 Review of literature

Literature search revealed that number of bile acid conjugates has been reported.⁹ Due to their amphiphilic nature, rigid steroidal backbone, availability, and low cost, bile acids have become attractive tool in designing pharmacological hybrid molecules and prodrugs. These molecules have tremendous transport capacity and organ specificity of enterohepatic circulation. They also have versatile derivatization possibilities, improving intestinal absorption ability and increasing metabolic stability of pharmaceuticals. In this chapter a brief introduction on role of bile acids in bile acid-conjugates has been discussed. Mode of action of various antifungal agents used in clinic and structural developments inazole based antifungal agent, fluconazole have also been briefly discussed.

Bile acid based conjugates.

Bile acid transporters have been shown to accept and carry a variety of analogues that are derivatized at different positions of bile acids. Bile acids are essential for digestion and absorption of lipids and lipid soluble vitamins. Intestinal bile acid transporters are solute carrier transporters regulating the enterohepatic circulation of bile salts.¹⁰ The treatment of chronic diseases in most cases involves long-term use of drugs. For this a site-specific drug action without adverse side effects and noninvasive, preferably oral administration of drugs is necessary. The physiology of bile transport exclusively involves only liver and small intestine and hence use of bile acid as putative shuttles of pharmaceuticals should be ideal. Current research efforts are focused on specific drug targeting to the liver and on improving the intestinal absorption of poorly absorbed drugs. Large number of bile acid-drug conjugates, therefore have been synthesized^{9a} by Kramer and his coworkers, which include chlorambucil-bile acid conjugate **1**, peptide-bile acid conjugate **2**, HMG-CoA reductase inhibitor-bile acid conjugates **3** and **4**.

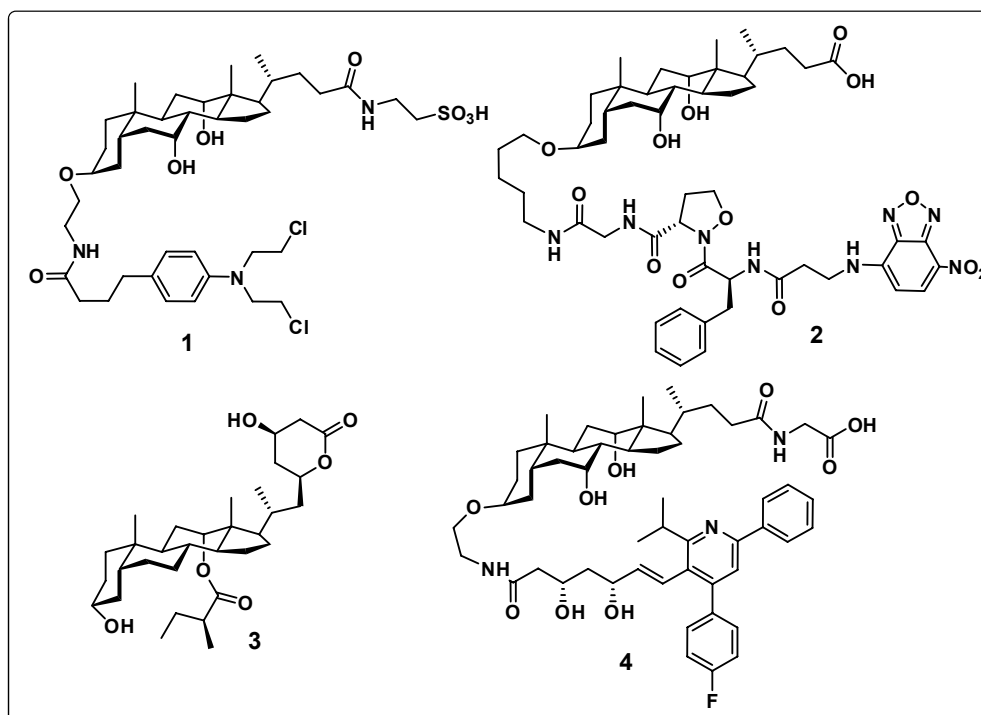

Synthesis of bile acid-oligonucleotide conjugates have been reported.¹¹ When used in vivo in rats, these conjugates resulted in an increased biliary excretion compared to unconjugated oligodeoxynucleotides.

Cosalane is an inhibitor of HIV replication with activity against both HIV-1 and HIV-2. The poor oral availability of cosalane is mainly attributed to its poor permeation across the intestinal epithelium due to its very high lipophilicity and membrane interacting nature. With the aim to retain the anti HIV activity and to enhance bioavailability of cosalane, Cushman *et al.* have synthesized¹² cosalane-bile acid conjugate **5**. Unfortunately this conjugate was found to be less potent than cosalane.

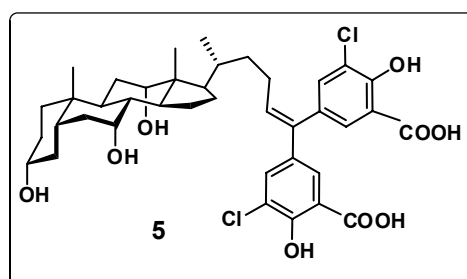

Mifepristone (RU-486) **6** was the first antiprogesterin,¹³ when used in combination with prostaglandin, effectively and safely terminates early pregnancies. From the structure activity relationship, design and synthesis of two new analogues, **7** and **8**, of mifepristone was reported by our group.^{14,15}

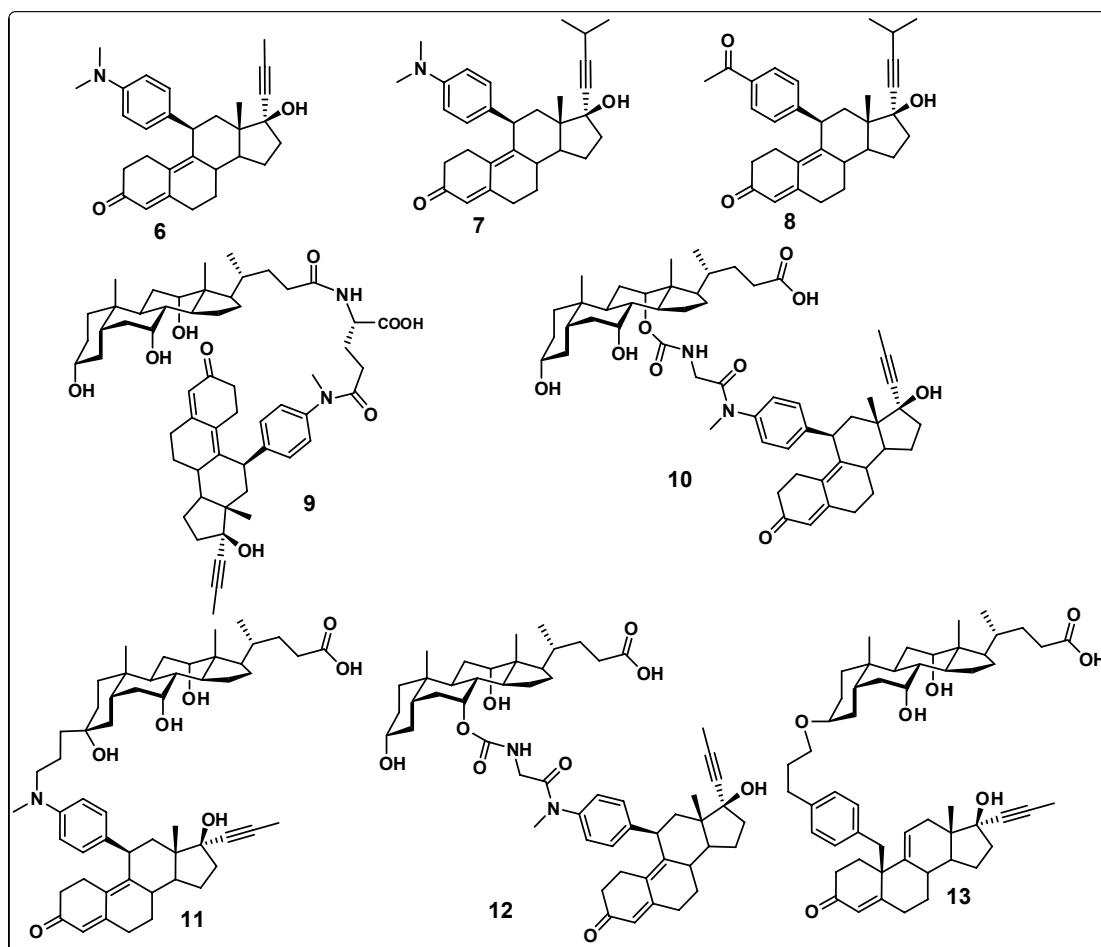

In comparison with mifepristone **6**, the relative binding affinity of compound **8** for the progesterone receptor was found to be more, whereas that of compound **7** was less. Glycemic control depends on a precise match between glucose inputs and outputs. Any disturbances in this balance can result in hypo or hyperglycemia. Glucocorticoid receptor (GR) antagonism has been validated as a strategy for regulating hepatic glucose output (HGO). Mifepristone (RU-486) **6** has been used for this validation study. Long-term systematic GR antagonism is not a viable approach for the treatment of type 2 diabetes. A liver specific derivative of mifepristone would be expected to decrease HGO and improve glucose metabolism without the risk of side effects. With this assumption Geldern *et al.* synthesized¹⁶ a number of bile acid conjugates e.g. **9-12** of mifepristone **6** attached at different positions of bile acid using linkers to provide novel drugs for type 2 diabetes. They have also synthesized bile acid-RU-43044 conjugate **13**, which is a selective GR antagonist.

It has been shown that bile acids can be used as carrier units for preparation of MRI contrast agents, which enter hepatocyte by means of active transport mechanism. A series of structurally different gadolinium conjugates incorporating bile acid moiety have been prepared.¹⁷ Polyaminopolycarboxylic acids such as diethylenetriaminepenta-acetic acid (DTPA) and 1,4,7,10-tetraazocyclododecane-1,4,7,10-tetraacetic acid (DOTA) have been selected as chelating subunits for the Gd (III) ion. These conjugates e.g. **14**, **15** showed high biliary elimination as well as good tolerability.

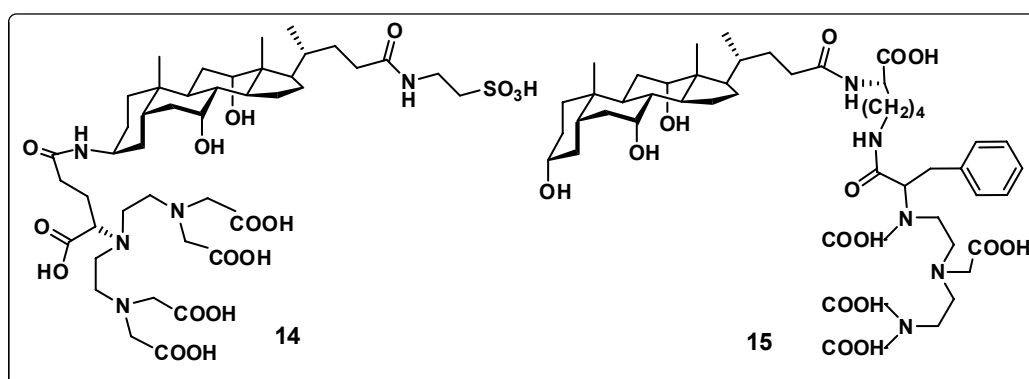

The 1,2,4,5-tetraoxacyclohexane (tetraoxane) moiety became an increasingly interesting pharmacophore since its antimalarial activity was found to be very similar to that of 1,2,4-trioxanes such as naturally occurring artemisinin. Saloja and his group synthesized¹⁸ cholic acid-derived 1,2,4,5-tetraoxanes **16**, **17** and mixed 1,2,4,5-tetraoxanes such as **18** in order to explore the influence of steroid carrier on its antimalarial, antiproliferative and antimicrobial activities.

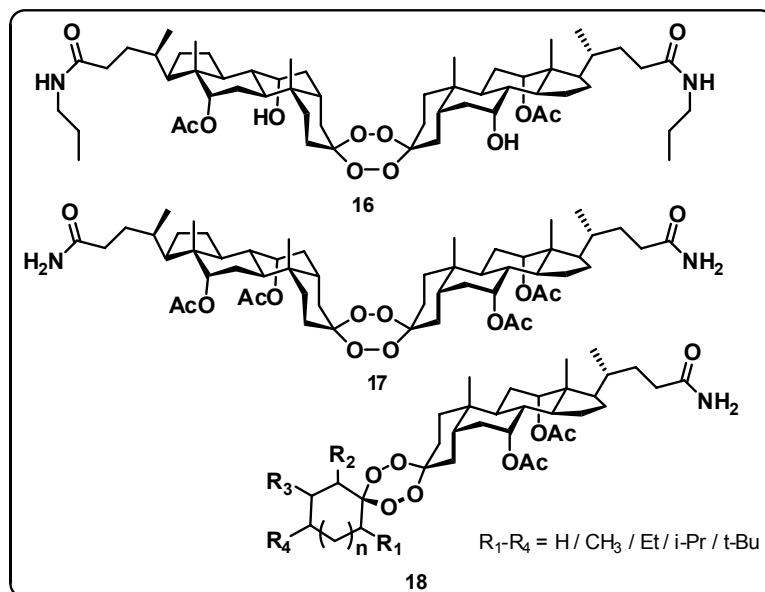

Various reports on bile acid based conjugates are available in the literature e.g. oligonucleotides-conjugates,^{19a} acetylcholine-conjugates,^{19b} pyrazole fused bile acids conjugated with anti-inflammatory drugs such as neproxen and drug surrogate^{19c} and a series of sulfonamides incorporating bile acid moieties as potent carbonic anhydrase inhibitors.^{19d,19e}

Recently there is a report²⁰ from our group on bile acid conjugates e.g. **19a** and **19b** from chiral amino alcohols based on a broad-spectrum antibiotic chloramphenicol. These conjugates showed antibacterial as well as antifungal activities. Synthesis of bile acid polyamide conjugates **20**²¹ and bile acid β -lactam conjugates **21**²² has been recently reported by our group.

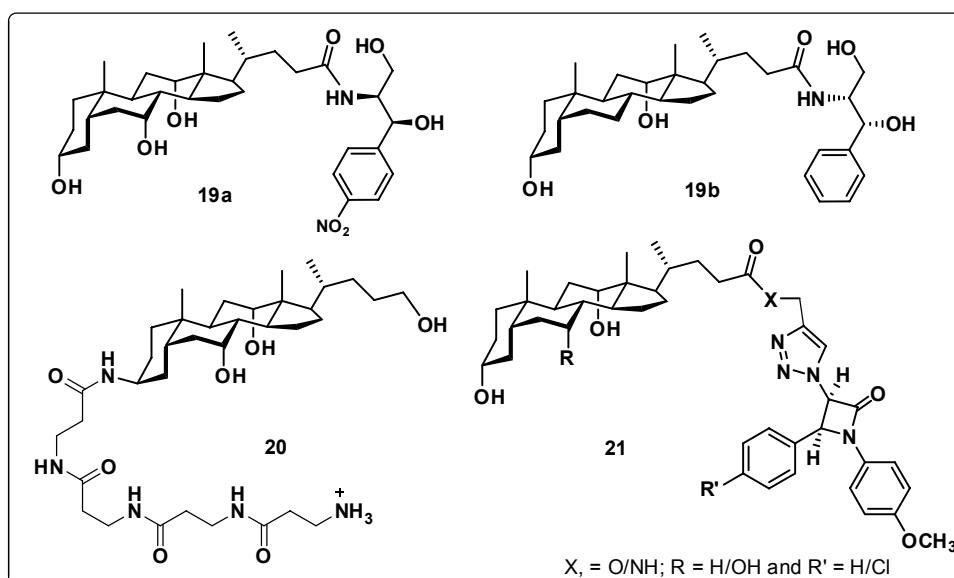

Antifungal agents

Fungi are plant-like organisms that lack chlorophyll and are one of the five kingdoms of life. There are over 1,500,000 species of fungi known.²³ Fungal infections have emerged as a significant clinical problem in recent years. Both the number of fungal infections and the number of fungal species causing them are increasing, as a result of the exponential increasing number of immunosuppressed and immunocompromised patients.²⁴ Clinically, candidosis, aspergillosis, cryptococcosis are the three major infections in the immunocompromised individuals.²⁵ Due to the increasing frequency of fungal infections and development of resistance to the current treatment,²⁶ mycology is today undergoing a true renaissance. Invasive fungal infections are nowadays a major cause of morbidity and mortality in patients such as with neutropenic, AIDS, organ transplantation, etc.²⁷ Infections can be superficial, that is situated at or close to the surface of the skin, or systemic, which means they can affect the body as a whole rather than individual parts or organs.²⁸ Mycoses are classified into five classes according to the tissue levels initially colonized:²⁸⁻³² 1) Superficial mycoses, 2) Cutaneous mycoses, 3) Subcutaneous mycoses, 4) Systemic mycoses due to primary pathogens and 5) Systemic mycoses due to opportunistic pathogens.

Factors Responsible for Development of Fungal Infections^{23, 27, 33}

- Use of drugs that suppress the immune system, ex. anticancer drugs, corticosteroids.
- Diseases and conditions, such as AIDS, kidney failure, diabetes, lung diseases, leukemia, organ transplantation etc.
- Fungal infections are extremely difficult to diagnose and therefore delays in initiation of treatment.

The fungal cell

Knowledge of fungal cell structure and function is essential for understanding the pharmacology of antifungal agents. Like mammalian cells and unlike bacteria, fungi are eukaryotes with chromosomes within the cell nucleus and have distinct cytoplasmic organelles including endoplasmic reticulum, golgi apparatus, mitochondria, and storage vacuoles.^{32b} This homology to mammalian cells also extends to biosynthetic pathways, where fungi share similar mechanisms for DNA replication and protein synthesis. The

similarity of fungal and mammalian cells creates a number of problems for designing drugs that are selectively toxic to fungal cells but not to the human host. Thus the issue of selectivity predominates in the search for safe and effective chemotherapeutic remedies for mycoses.

The cell membrane

Fungal and mammalian cells both contain a cell membrane that plays vital role in cell structure, division and metabolism. It is composed of complex lipids such as sterols, which account for approximately 25% of the weight of the cell membrane. In all pathogenic fungi, the principle sterol is ergosterol, whereas the mammalian cell membranes contain primarily cholesterol. Although the sterols are different, the principle route for the biosynthesis of ergosterol parallels with the biosynthesis of cholesterol, therefore selectivity plays a crucial role in the quest for safe and effective chemotherapeutic drugs.

The current therapeutic treatment of mycoses

Antifungal agents currently used for the treatment of mycoses and their targets in fungal pathogens and toxicities are as follows.²⁸

Polyene antifungals: Amphotericin B^{29a} **22** and Nystatin^{29b} **23** are currently used polyene antifungal drugs. The polyenes act by binding to ergosterol in the fungal cell membrane.

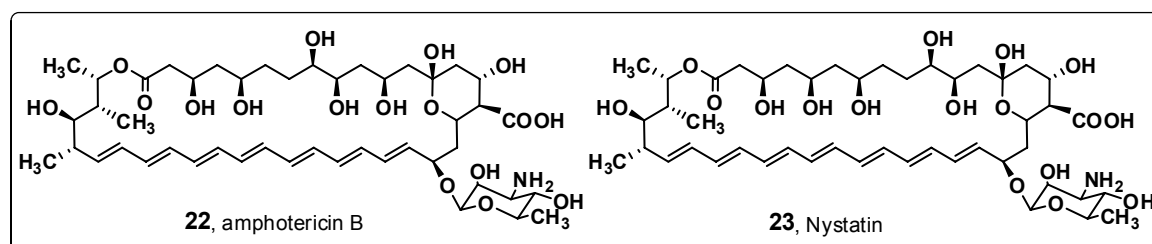

The binding results in depolarization of the membrane and formation of pores that causes leakage of cell contents, eventually leading to cell death. Although, amphotericin B binds approximately 10 times more strongly to fungal cell membrane components than mammalian cell membrane cholesterol, it definitely disrupts mammalian cell giving rise to adverse side effects. Therefore polyenes have greater toxicities for mammalian cells and cause nephrotoxicity that limits the clinical use of polyenes. Resistant strains have

also been isolated under laboratory conditions with alteration in the nature and amount of sterols present in the membrane.

Azole antifungals: Azole antifungals are the major class of drugs which are widely used clinically.³⁰ Miconazole **24**, ketoconazole **25**, clotrimazole **26** are the topical agents and fluconazole **27** and itraconazole **28** are useful in the treatment of systemic mycoses.

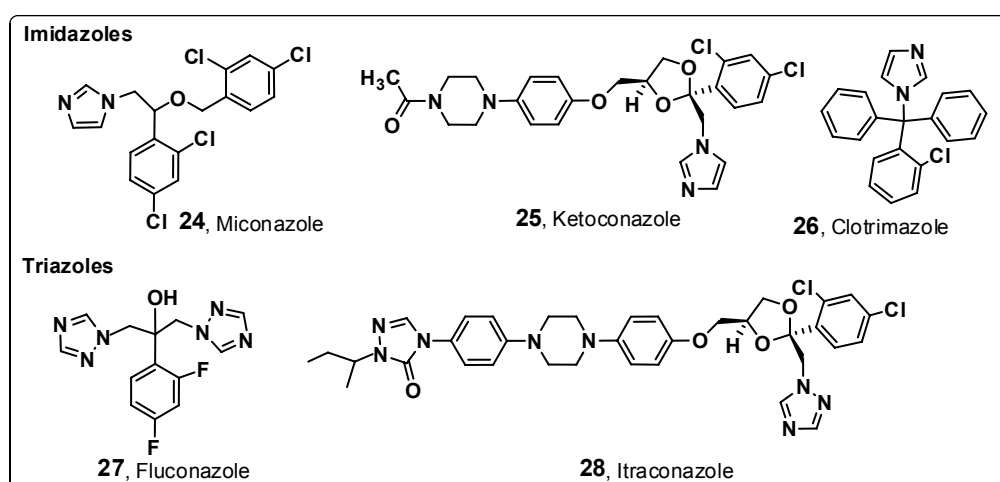

The mode of action of azole antifungals is inhibition of ergosterol biosynthesis by inhibiting the fungal cytochrome P-450 3-A dependent enzyme, lanosterol 14- α -demethylase, thereby interrupting the synthesis of ergosterol (Figure 1).^{30b,30c}

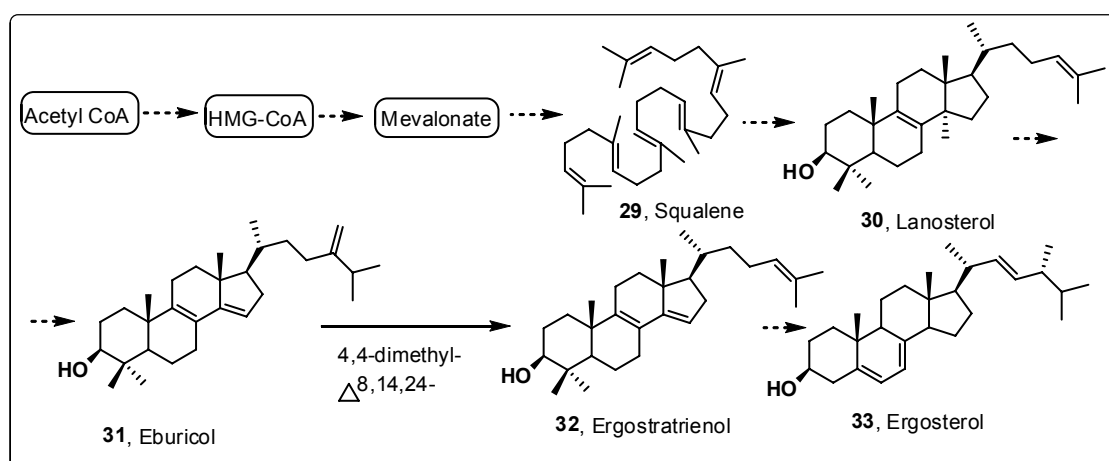
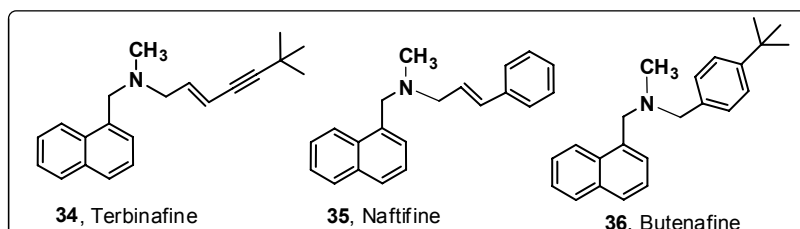

Figure 1: The steps illustrated for ergosterol synthesis at the endoplasmic reticulum: target for azoles, allylamines, phenyl-morpholines. These are the major steps found in all fungi.

Inhibition of the enzyme leads to the depletion of ergosterol in the cell membrane and accumulation of toxic intermediate sterols, causing increased membrane permeability

and inhibition of fungal growth. Azole antifungals can also inhibit mammalian cytochrome P450-dependent enzymes involved in hormone synthesis or drug metabolism. Therefore, azole antifungals cause hepatotoxicity. Azoles are only fungistatic.^{30d} Due to the increased administration of azole antifungals for the treatment of systemic fungal infections, pathogenic yeasts are developing resistance to these drugs. Target modification is a common factor contributing to clinical resistance to azole therapy. However, azole moiety itself has been proved to be effective pharmacophore.

Allylamines as antifungals: Allylamines are the other class of antifungals which also work in a similar fashion i.e. by inhibiting the synthesis of ergosterol.³¹ However, allylamines act at an earlier step in the ergosterol synthesis pathway by inhibiting the enzyme squalene epoxidase leading to the accumulation of intracellular squalene that causes fungicidal effect upon exposure to the drug. Like the azoles, terbinafine **34** causes hepatic toxicity and has the potential for drug interaction with other medications metabolized through the mammalian cytochrome P-450 pathway. Naftifine **35** and butenafine **36** have been used as antifungal drugs with the same mode of action.



Other class of medicinal interest: Besides above class of antifungals, there are few other classes of antifungals agents

Flucytosine: Flucytosine or 5-fluorocytosine, **37** (5-FC) was originally developed in the 1957 as a potential antineoplastic agent. It was found to have antifungal activity in 1968 to treat candida and cryptococcal infections in human. Flucytosine inhibits DNA synthesis by blocking the functions of a key enzyme thymidylate synthetase in the DNA replication. Flucytosine is also incorporated in fungal RNA, thereby disrupting transcription and translation. Selectivity is achieved because mammalian cells are unable to convert flucytosine to fluorouracil. But flucytosine can be converted to 5- fluorouracil (5-FU) by bacteria residing in the gastrointestinal tract.

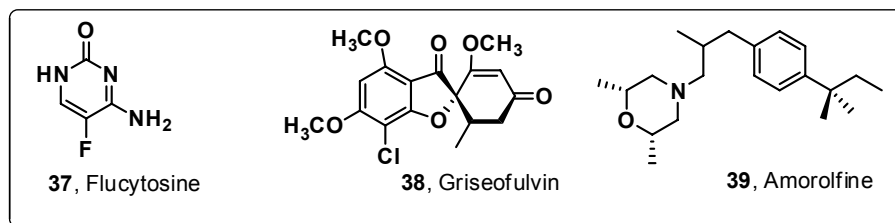

The most common adverse effects seen with flucytosine are similar to 5-FU chemotherapy (diarrhea, nausea and vomiting, bone marrow suppression) however with reduced intensity. The serious side effects associated with flucytosine are hematological, manifested as leucopenia and thrombocytopenia.²⁸

Griseofulvin: Griseofulvin, **38** is a natural product first isolated in 1939 from *Penicillium griseofulvum*. It inhibits fungal cell mitosis by disrupting mitotic spindle formation, a critical step in cellular division. Griseofulvin served as first line drug for treatment of dermatophytosis for many years. Because of its limited efficacy and untoward side effects, it is recently being replaced by itraconazole **28** and terbinafine **34**.

Amorolfine: Morpholine antifungal amorolfine, **39** is known to inhibit sterol synthesis.

There are also cell wall antagonist like echinocandins *e.g.* cilofungin or nikkomycins. The echinocandins are fungal secondary metabolites comprising a cyclic hexapeptide core with a lipid sidechain responsible for antifungal activity. Antifungal activity in the prototypes, echinocandin B and aculeacin A, was discovered by random screening in the 1970s. The target for the echinocandins is the complex of proteins responsible for synthesis of cell wall β -1,3 glucan polysaccharides.

The sordarin antifungal class, although not developed for clinical use, merits mention among the new mechanisms of action. Sordarins inhibit protein synthesis by blocking the function of fungal translation Elongation Factor 2 (EF2).

Need for further research in antifungal agents

There are mainly three challenging problems for antifungal researchers in development of an effective drug in combating severely invasive mycosis.

1. Toxicity of currently used antifungal agents: The currently administered drugs are only fungistatic and cause several side effects such as nephrotoxicity (polyenes) and hepatotoxicity (azole), as the fungi shares similar cellular components and mechanism, as that of mammalian cell.

2. Resistance of yeasts to clinically useful antifungal agents: The molecular basis of resistance to azole antifungals, there are three different resistance mechanisms are known in pathogenic yeasts.³⁴ (i) The reduced access of the agents to the target cytochrome P450 enzyme because of increased efflux of antifungals, caused by the action of resistance gene products. (ii) Over production of cytochrome P450 enzyme, possibly by gene amplification. (iii) Resistance mechanism a structural alteration in cytochrome P450 enzyme which results in lower susceptibility to azole antifungals.

3. Emergence of newer strains by mutation: The treatment of immunosuppressed and immunocompromised patients such as in cancer and AIDS patient needs long term administration of antifungal drugs to treat the invasive infection caused by opportunistic pathogenic fungi. The consequence leads to the development of resistance of fungi to these drugs by mutation in the genes leading to the birth of newer resistant strains.

The fungal cell wall: A unique target

The fungal cell wall is critical for the cell viability and pathogenicity. Beyond serving as a protective shell and providing cell morphology, the fungal cell wall is a critical site for exchange and filtration of ions and proteins, as well as metabolism and catabolism of complex nutrients. The fungal cell wall is a unique target because mammalian cells lack a cell wall; it represents an ideal, safe and specific target for antifungal therapy. Cell wall is present in all fungi, therefore cell wall biosynthesis inhibitors would exhibit broad spectrum of antifungal activity.^{26b, 32}

In spite of significant research on antifungal agents, the azoles remain the mainstay of therapy for systemic life threatening fungal infections as they have fungistatic, orally active and broad-spectrum activities against most yeasts and filamentous fungi. Azole antifungals are strong inhibitors of lanosterol 14 α -demethylase, which is major component of fungal cell membrane.³⁰

Fluconazole **27** is a 1,2,4-triazole based drug that has established an exceptional therapeutic record for *Candida* infections, including oropharyngeal and esophageal candidiasis, vulvovaginal candidiasis, candidemia and disseminated candidiasis. It is an antifungal agent of choice for the treatment of infections by *Candida albicans* and *Cryptococcus neoformans* due to its potent activity, excellent safety profile and favorable pharmacokinetic characteristics.³⁵ However, fluconazole is not effective against invasive aspergillosis and is not fungicidal. In addition, extensive use of fluconazole has increased

the number of fluconazole-resistant *C. albicans* isolates.³⁶ Itraconazole **28** is an improvement of fluconazole in its broad spectrum activity and better toleration but shows low bioavailability and oral absorption. Therefore, great efforts have been made to modify the chemical structure of fluconazole, in order to broaden its antifungal spectrum of activity and to increase its potency.³⁷ Several new azoles, containing 1,2,4-triazole and 1,3-difluorobenzene moieties, such as voriconazole^{37b} **40**, ravuconazole^{37c} **41**, posaconazole^{37d} **42**, albaconazole^{37e} **43** etc. are marketed or in the late stages of clinical trials. Other modified fluconazole analogues **44-47** are reported in literature (Figure 2).

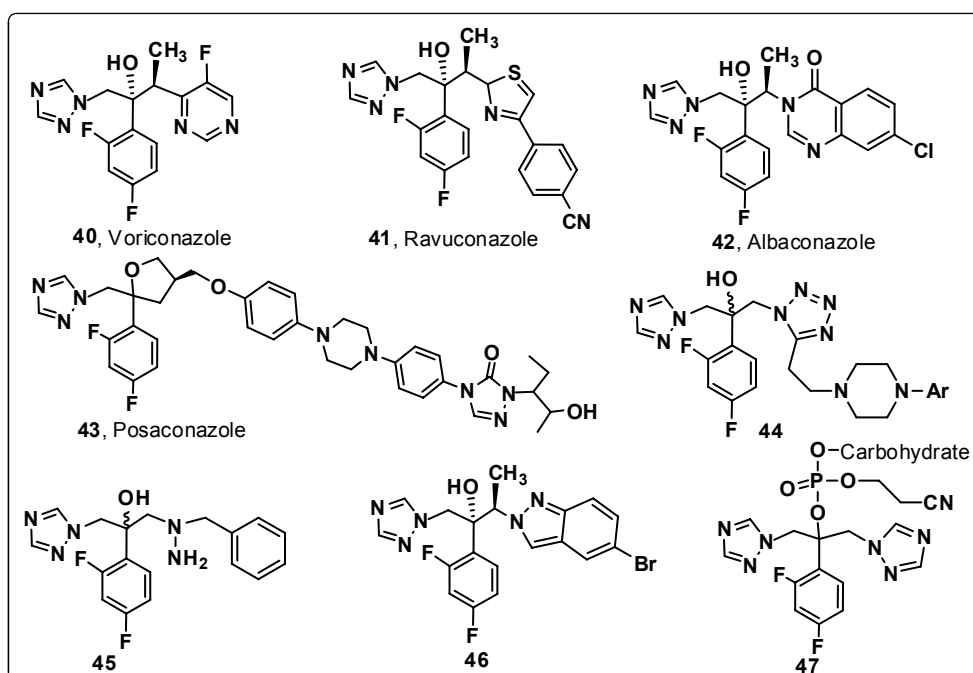

Figure 2: Azole antifungals containing 1,2,4-triazole

Azoles exert antifungal activity through inhibition of CYP51 by a mechanism in which the heterocyclic nitrogen (N-3 of imidazole or N-4 of 1,2,4-triazole) binds to the sixth coordination of heme iron atom of the porphyrin in the substrate binding site of the enzyme.³⁸ Based on the structure of the active site of CYP51 and the extensive investigation of the structure-activity relationships of azole antifungals, it was found that 1,2,4-triazole ring and 2,4-difluorophenyl group are essential for the high antifungal activity.³⁹ Several reports on the synthesis and biological activity of structurally modified new analogues of fluconazole are known in the literature.⁴⁰⁻⁴⁴

2.1.4 Present Work

2.1.4.1 Objective

It can be seen from above discussion that 1,2,4-triazole ring and 2,4-difluorophenyl group are essential for the high antifungal activity. We focused our attention on design and synthesis of new biconjugates (Figure 3) of bile acids having amphiphilic nature as amphotericin-B and pharmacophore of fluconazole, linked together with 1,4-disubstituted 1,2,3-triazole, which may be viewed as an isostere of one 1,2,4-triazole component of fluconazole.

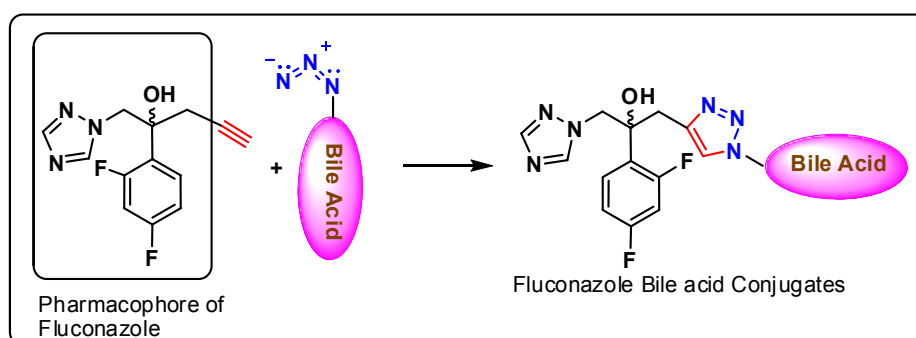
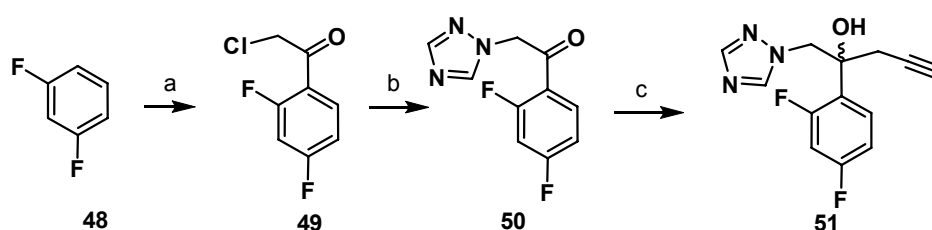

Figure 3:

Exact mechanism of fluconazole absorption in fungal cell is not known. We thought that bile acid may play a role of fluconazole absorption enhancers through fungal cell membrane. According to literature report,⁴⁵ common feature of bile acid derived antimicrobials is its potential to exhibit facially amphiphilic nature, due to polar hydroxyl groups on one face and nonpolar hydrophobic methyl groups on the other. Polyene macrolide amphotericin B, peptide antimicrobial agent polymixin B and squalamine in the cyclic form show such amphiphilicity and function as ionophores.⁴⁶ In these conjugates we thought that 1,2,3-triazole not only act as a passive linker but also can be viewed as an active component of fluconazole. 1,2,3-Triazole moiety is stable to metabolic degradation and is capable of hydrogen bonding, which can be favorable in binding of biomolecular targets and for solubility.⁴⁷ Molecules containing 1,2,3-triazole unit show diverse biological activities including antibacterial, herbicidal, fungicidal, antiallergic, and anti-HIV.⁴⁸ Cu(I) catalyzed 1,3-dipolar cycloaddition has been a method of choice for the synthesis of 1,4-disubstituted-1,2,3-triazoles.⁴⁹ (Detailed mechanism of this click reaction has been already discussed in chapter 1).

2.1.4.2 Results and Discussion

Accordingly, we synthesized ketone **50** from 1,3-difluorobenzene **48** through intermediate **49** using literature procedure.⁴³ Terminal acetylenic compound **51** was synthesized by propargylation of the corresponding ketone **50** by using propargyl bromide and zinc dust. This reaction gave racemic compound **51** (Scheme 1).



Scheme 1: Reagents and conditions: (a) AlCl_3 , 1,2-dichloroethane, chloroacetyl chloride, 25 °C, 7 h; (b) 1,2,4-triazole, NaHCO_3 , toluene, reflux, 4 h, (overall 55% in two step); (c) Zn, propargyl bromide, DMF/THF, 25 °C, 5 h, 95%.

In the proton NMR spectrum of compound **51**, the acetylenic proton was identified as triplet at δ 2.06 ppm and doublet of doublet at δ 2.87 ppm due to β methylene. In the ^{13}C -NMR spectrum it showed intricacies of various ^{19}F - ^{13}C coupling as in fluconazole molecule.⁵⁰ Presence of acetylenic group was also evident from IR spectrum wherein the absorption due to acetylenic group was observed at 3307 cm^{-1} .

For the synthesis of bile acid-fluconazole conjugates bile acid derivatives containing azido group at various positions have been used. Synthesis and characterization of azido bile acid derivatives **52-55** has been already discussed in Chapter 1 (Chapter1, Schemes 4 and 5).

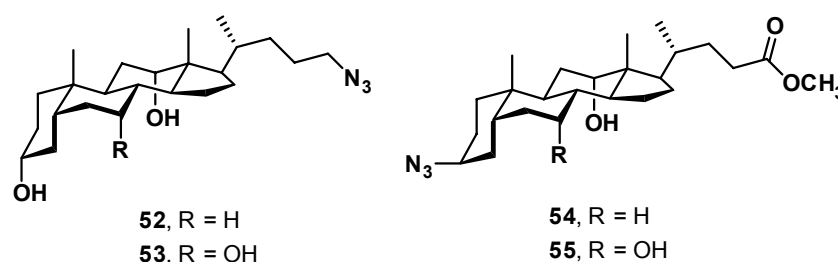

The cycloaddition of alkyne **51** to C-24 azido compound **52** was attempted using copper sulfate and sodium ascorbate in *t*-BuOH/ H_2O . This reaction failed at low temperature and at 50-60 °C, the reaction was very slow and after 3 days the conjugate **56** was obtained in 10% yield along with starting material. Under microwave irradiation

compound **51** was reacted with C-24 azide **52** in DMF/H₂O using catalytic amount of Cu(I) to give fluconazole-bile acid conjugate **56** as a diastereomeric mixture in 92% yield (Scheme 2).

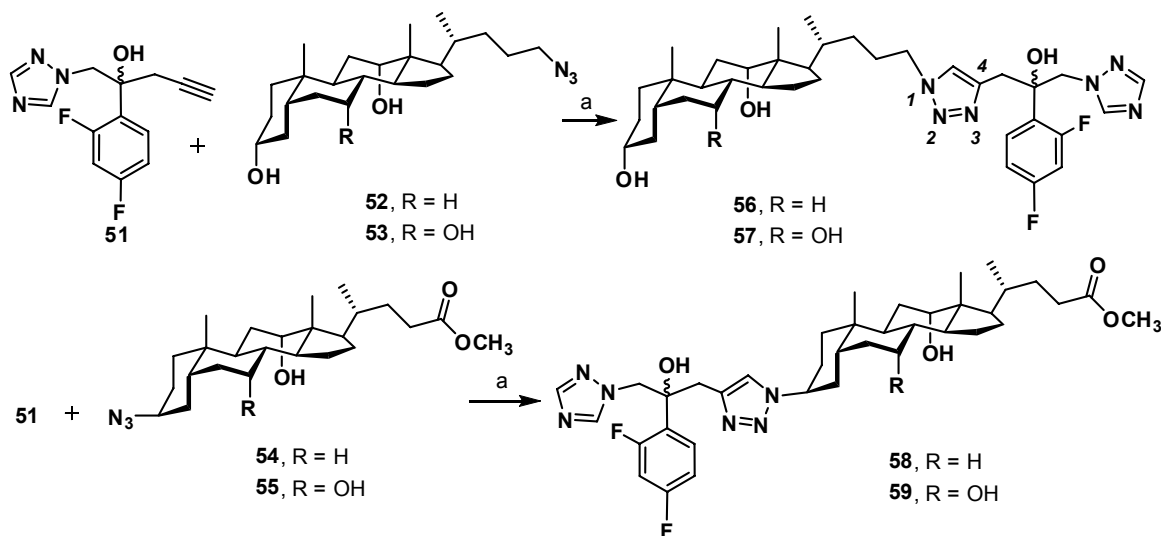

Scheme 2: Reagents and conditions: CuSO₄·5H₂O (5 mol%), Sodium ascorbate (40 mol%), DMF:H₂O (9:1), Microwave, 5 min, 90-95%

In the proton NMR spectrum of compound **56**, resonance corresponding to C-24 methylene protons of bile acid part was identified at δ 3.15 ppm and 3.48 ppm (two doublets) and the proton of 1,2,3-triazole was noticed at δ 7.19 ppm. Methylene at C-4 position of 1,2,3-triazole was identified at δ 4.20 ppm. In the IR spectrum, compound **56** showed absorption due to hydroxyl group at 3391 cm⁻¹. In addition, it gave satisfactory elemental analysis and in mass spectrum it showed molecular ion peak at 667.34 (M + 1). We then extrapolated the ligation protocol successfully to other bile acid derived azides, **53**, **54** and **55** and synthesized fluconazole-bile acid conjugates **57**, **58** and **59** (Scheme 2).

We also synthesized ester linked bile acid fluconazole conjugates from the intermediate **61** in which azide functionality is present in fluconazole component. Accordingly compound **61** was synthesized from ketone **50**.

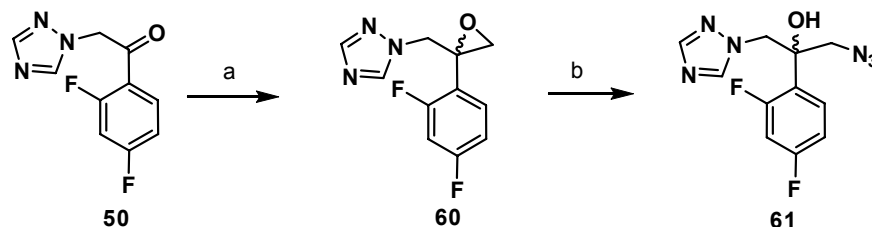

Scheme 3: Reagents and conditions: (a) Trimethylsulfoxonium iodide, NaH, DMSO/THF, 25 °C, 2 h, 91%; (b) NaN₃, DMF, 60-65 °C, 12 h, 75%.

Reaction of ketone **50** with trimethylsulfoxonium iodide (TMSOI) in the presence of sodium hydride afforded oxirane **60** in 91% yield.⁴³ Opening of oxirane **60** with NaN₃ in DMF at 60-65 °C resulted into azide **61** in 75% yield as a racemic mixture.⁵¹

Cycloaddition reaction of the azide **61** with propargyl ester **62** of deoxycholic acid which was synthesized according to our earlier report, (Chapter 1 Scheme 3) yielded diastereomeric mixture of bile acid-fluconazole conjugate **64** in 95% yield (Scheme 4). Similarly cycloaddition reaction of **61** with propargyl esters **63** of cholic acid yielded conjugate **65** in 94% yield. All the compounds **56-59**, **64** and **65** were characterized by spectroscopic data as well as elemental analysis.

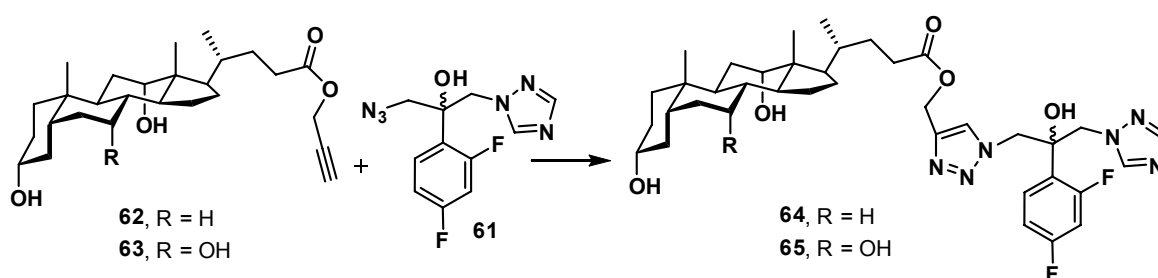

Scheme 4: Reagents and conditions: CuSO₄·5H₂O (5 mol%), Sodium ascorbate (40 mol%), DMF:H₂O (9:1), Microwave, 5 min.

For the comparison of biological activity we also synthesized bile acid azoles conjugates **67(a-d)** containing imidazole, benzimidazole, triazole, and benzotriazole at C-24 position from C-24 monomesyl compound **66** (Scheme 5). Compound **66** was synthesized from deoxycholic acid (Chapter 1, Scheme 4).

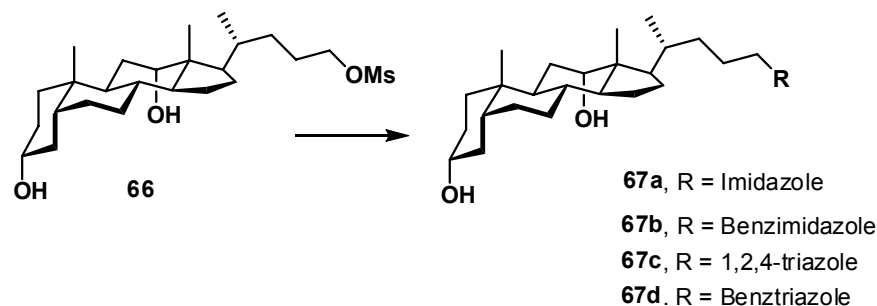

Scheme 5: Reagents and conditions: R, NaH, DMF, 25 °C, 12-20 h, 75-85%.

All the compounds **56-59**, **64**, **65** and **67(a-d)** were tested for the in vitro antifungal activity. The antifungal activity was evaluated against different fungal strains such as *C. albicans*, *C. neoformans*, *S. schenckii*, *T. mentagrophytes*, *A. fumigatus*, *C.*

parapsilosis (ATCC 22019). Minimum inhibitory concentration (MIC) and IC₅₀ values were determined using standard broth microdilution technique as per NCCLS guidelines.⁵²

Fluconazole, amphotericin B and ketoconazole were used as standard drugs for the comparison of antifungal activity. All the biological data of the tested compounds are depicted in Table 1 as MIC and IC₅₀ values.

Table 1: *In vitro* antifungal activity for compounds **56-59**, **64**, **65** and **67(a-d)**.

Comp.	Inhibitory concentration in µg/mL against											
	1		2		3		4		5		6	
	MIC	IC ₅₀	MIC	IC ₅₀	MIC	IC ₅₀	MIC	IC ₅₀	MIC	IC ₅₀	MIC	IC ₅₀
56	3.12	2.11	12.5	11.34	6.25	6.11	12.5	10.58	>50	>50	6.25	5.82
57	6.25	4.58	50	44.76	25	12.34	25	24.82	>50	>50	6.25	5.16
58	6.25	5.72	25	22.23	25	23.34	25	22.48	>50	>50	6.25	5.48
59	6.25	3.44	50	48.42	3.12	2.64	25	21.46	>50	>50	3.12	2.18
64	<0.001	<0.001	0.01	<0.001	0.84	0.76	>50	46.47	>50	6.24	0.396	0.38
65	0.442	0.35	0.19	0.03	12.56	11.27	18.41	8.90	>50	31.24	5.15	2.93
67a	>50	>50	>50	>50	>50	>50	>50	>50	>50	>50	>50	>50
67b	>50	>50	>50	>50	>50	>50	>50	>50	>50	>50	>50	>50
67c	>50	>50	>50	>50	>50	>50	>50	>50	>50	>50	>50	>50
67d	>50	>50	>50	>50	>50	>50	>50	>50	>50	>50	>50	>50
Amp.	0.12	0.09	0.06	0.04	0.12	0.08	0.12	0.09	0.5	0.38	0.12	0.11
Flu.	0.5	0.13	1.0	0.46	2.0	1.06	1.0	0.63	2.0	1.06	1.0	0.21
Keto.	0.002	0.001	0.001	0.001	0.031	0.026	4.0	2.12	2.0	0.008	0.031	0.024

Abbreviations: CA, *Candida albicans*; CA, *Cryptococcus neoformans*; SS, *Sporothrix schenckii*; TM, *Trichophyton mentagrophytes*; AF, *Aspergillus fumigatus*; CP, *Candida parapsilosis* (ATCC-22019); Flu., Fluconazole; Keto., Ketoconazole; Amp., Amphotericin B.

From these activity results we concluded that azole-bile acid conjugate **67(a-d)** are inactive against all tested fungal strains while the bile acid-fluconazole conjugate **56-59** having epimeric mixture at C-2 atom of fluconazole moiety showed moderate antifungal activity against *Candida* species (MIC ranging from 3.12 to 6.25 µg/mL).

Ester linked bile acid-fluconazole conjugates **64** and **65** were found to be more potent against *Candida* strains. Compound **64** showed much better activity for *C. albicans* (IC₅₀ <0.001 µg/mL), *C. neoformans* (IC₅₀ <0.001 µg/mL), *Sporothrix schenckii* (IC₅₀

<0.043 $\mu\text{g/mL}$), and *C. parapsilosis* (IC_{50} 0.12 $\mu\text{g/mL}$) as compared with fluconazole and amphotericin B.

Ester linked bile acid conjugates **64** and **65** were found to be more potent than fluconazole-bile acid conjugates **56-59**.

Encouraged by these biological results we synthesized fluconazole analogues containing monosubstituted (**68**, **70**) and 1,4-disubstituted (**69**, **71** and **72**) 1,2,3-triazoles from two common intermediates **51** and **61** as described in Scheme 6. Acetylenic compound **51** on cycloaddition reaction with azidotrimethylsilane under microwave irradiation at 245 W in DMF/ H_2O using catalytic amount of copper sulfate and sodium ascorbate gave trimethylsilyl deprotected⁵³ monosubstituted 1,2,3-triazole containing fluconazole analogue **68** in 87% yield (Scheme 6).

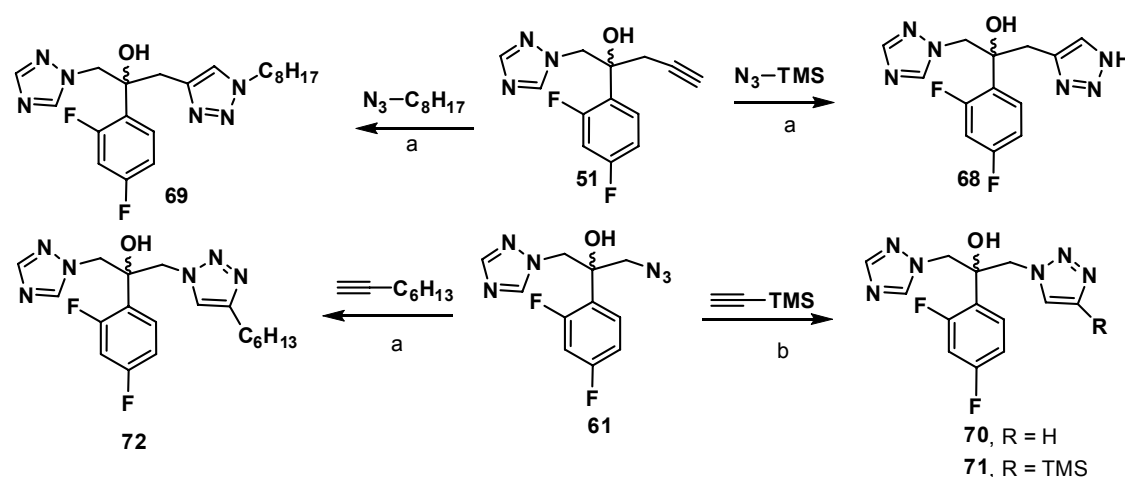

Scheme 6: Reagents and conditions: (a) $\text{CuSO}_4\cdot 5\text{H}_2\text{O}$ (5 mol%), Sodium ascorbate (40 mol%), DMF: H_2O (4:1), Microwave (245 W), 10 min; (b). $\text{CuSO}_4\cdot 5\text{H}_2\text{O}$ (5 mol%), Sodium ascorbate (40 mol%), DMF: H_2O (4:1), Microwave (175 W), 10 min.

The reaction of the same acetylenic compound **51** with 1-azidooctane, under similar reaction conditions afforded 1,4-disubstituted 1,2,3-triazole analogue **69** having long alkyl chain, in 94% yield. The azide **61** was reacted with trimethylsilyl acetylene (microwave irradiation at 175 W because of the low boiling point of trimethylsilyl acetylene) to give trimethylsilyl deprotected monosubstituted 1,2,3-triazole compound **70** in 74% yield along with trimethylsilyl containing compound **71** in 21% yield. Reaction of azide **61** with 1-octyne afforded compound **72** having long alkyl chain attached at C-4 of 1,2,3-triazole ring. Compound **68-72** were fully characterised by spectral analysis.

All the compounds **68-72** were tested for the in vitro antifungal activity. The antifungal activity was evaluated against different fungal strains. Biological data of the tested compounds is depicted in Table 2 as MIC and IC₅₀ values.

All these newly synthesized compounds were found to show good antifungal activity. From the biological data (Table 2), it was observed that compounds **68** and **70** having monosubstituted 1,2,3-triazole ring which are isosteres of fluconazole and compound **71** containing trimethylsilyl group, showed good in vitro antifungal activity against fungal pathogens *C. albicans*, *C. neoformans* and *S. schenckii*, which was comparable with fluconazole but these compounds were less active than amphotericin B and ketoconazole (imidazole based current antifungal drug). These molecules were found to be less active against *T. mentagrophytes*, *A. fumigatus*, *C. parapsilosis* (ATCC 22019).

Table 2. In Vitro antifungal activities of compounds **68-72** and standard antifungal drugs fluconazole, ketoconazole and amphotericin B (MIC and IC₅₀ in µg/mL).

Comp.	Inhibitory concentration in µg/mL against											
	1		2		3		4		5		6	
	MIC	IC ₅₀	MIC	IC ₅₀	MIC	IC ₅₀	MIC	IC ₅₀	MIC	IC ₅₀	MIC	IC ₅₀
68	3.16	2.74	3.12	0.69	12.4	4.43	49.03	46.99	>50	>50	29.10	16.83
69	0.002	0.001	0.002	<0.006	0.036	0.008	0.480	0.249	1.12	0.8	0.01	0.002
70	1.48	0.72	0.78	0.03	10.62	5.77	12.16	6.45	>50	>50	12.82	6.83
71	3.26	3.04	1.56	1.01	3.16	3.11	15.56	8.57	49.81	43.19	44.53	3310
72	0.032	0.018	0.02	<0.01	0.14	0.043	6.72	2.46	6.9	5.0	0.39	0.12
Amp.	0.12	0.09	0.06	0.04	0.12	0.08	0.12	0.09	0.5	0.38	0.12	0.11
Flu.	0.5	0.13	1.0	0.46	2.0	1.06	1.0	0.63	2.0	1.06	1.0	0.21
Keto.	0.002	0.001	0.001	0.001	0.031	0.026	4.0	2.12	2.0	0.008	0.031	0.024

Abbreviations: CA, *Candida albicans*; CA, *Cryptococcus neoformans*; SS, *Sporothrix schenckii*; TM, *Trichophyton mentagrophytes*; AF, *Aspergillus fumigatus*; CP, *Candida parapsilosis* (ATCC-22019); Flu., Fluconazole; Keto., Ketoconazole; Amp., Amphotericin B.

1,4-disubstituted 1,2,3-triazole compounds **69** and **72** with long alkyl chains showed very good antifungal activity against all the tested fungal pathogens. Compound **69** showed much better activity for *C. albicans* (IC₅₀ 0.001 µg/mL), *C. neopharmans* (IC₅₀ <0.006 µg/mL) and *C. parapsilosis* (IC₅₀ 0.002 µg/mL) as compared with fluconazole, amphotericin B and ketoconazole, while compound **72** was found to be less active than compound **69** but showed better activity against *C. albicans* (IC₅₀ 0.018

$\mu\text{g/mL}$), *C. neopharmans* ($\text{IC}_{50} < 0.01 \mu\text{g/mL}$) and *C. parapsilosis* ($\text{IC}_{50} 0.043 \mu\text{g/mL}$) as compared with fluconazole and amphotericin B.

We also evaluated the in vivo activity of more potent compound **69**, **72** and ester conjugate **64** against *C. albicans* intravenous challenge in Swiss mice (Table 3).

Table 3. In vivo efficacy of **69**, **72** and **64** against systemic challenge of *Candida albicans* in mouse.^a

Sr. No.	Animal Groups	Avarage CFU/gm Kidney tissue	% reduction in CFU load
1	Control	3.4×10^6	NIL
2	69 , 50mg/kg (O.D.)	8.8×10^4	97.4
3	69 , 25mg/kg (O.D.)	2×10^6	41.2
4.	72 , 50mg/kg (O.D.)	1.7×10^5	95.0
5.	72 , 25mg/kg (O.D.)	ND	ND
6.	64 , 50mg/kg (O.D.)	2.1×10^6	38.2

^a5 mice per group were used; the test compounds were given orally, once a day in PEG 200 for 7 days. On day 9 the mice were sacrificed and CFU in kidney tissue were determined; ND, not detected.

Compound **69** resulted in 97.4% reduction while compound **72** resulted in 95% reduction in fungal load in mice at a dose of 50 mg/kg po. Although the bile acid conjugate **64** showed good activity in vitro, it did not exhibit significant in vivo activity (38.2% reduction in fungal load) in this model.

The lead compounds **69**, **72** and ester conjugates **64**, **65** were tested for their antiproliferative activity against human cancer cells Hep3B and A431. All the four compounds as well as standard drugs fluconazole, amphotericin B and ketoconazole were less toxic at lower dose (0.001 mg/mL) while at higher dose (1 mg/mL), they were toxic to both Hep3B and A431 cells (Figure 4). All the four compounds **69**, **72**, **64** and **65** were more toxic than fluconazole and were less toxic than ketocanazole in both the cell lines. In Hep3B cell lines compound **72** was more toxic than fluconazole but less toxic than other compounds as well as amphotericin B and ketoconazole. Compounds **64** and **65** were comparable with amphotericin B in their toxicity.

In A431 cells, compounds **69** and **72** were found to be more toxic than fluconazole but were less toxic than other compounds as well as amphotericin B and

ketoconazole. The antiproliferative activities of compounds **64** and **65** were comparable to amphotericin B in A431 cells.

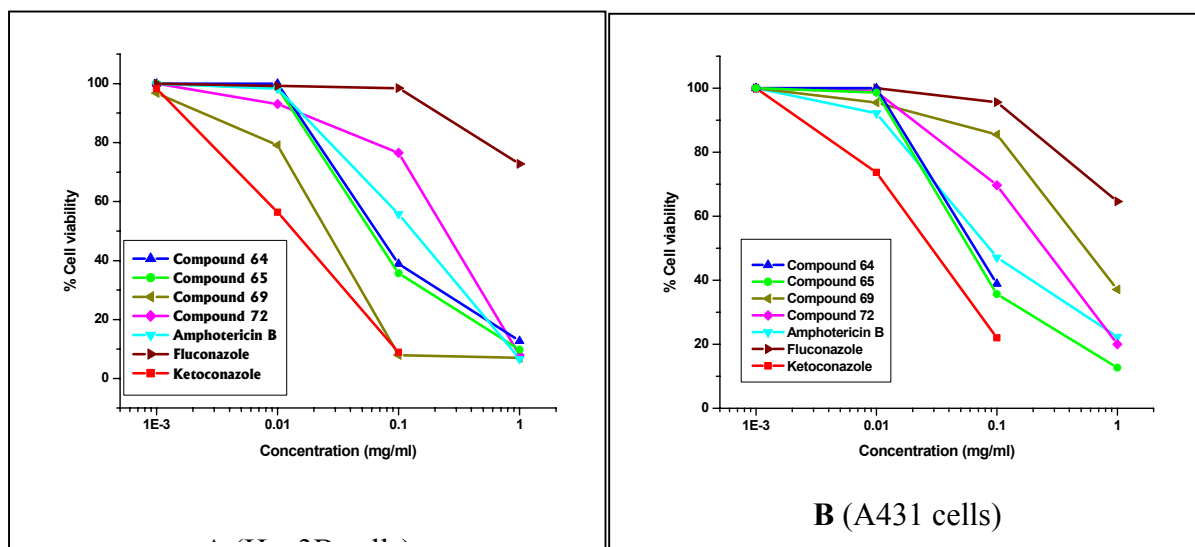

Figure 4: Graphical Representation for Antiproliferative Activities of compounds in Hep3B cells (A) and A 431 cells (B)

The results therefore suggest that the antiproliferative activity of compound **69** was similar to fluconazole in A431 cells, while it was toxic for Hep3B cells than fluconazole. The compound **72** was less toxic than ketoconazole and amphotericin B but moderately toxic than fluconazole in both the cell lines. Taken together, these results indicated that the lead compounds **69** and **72** do not have any profound effect on proliferation of human cancer cell lines at lower concentrations and moreover their activity is comparable to that of standard drugs.

2.1.5 Conclusion

Fluconazole based novel mimics containing 1,2,3-triazole were designed and synthesized. These molecules were tested for their antifungal activity. Out of these easily accessible molecules, 1,4-disubstituted-1,2,3-triazole compounds **69** and **72**, containing long alkyl chains, showed very good antifungal activity against *Candida* species when compared with the standard drugs fluconazole, ketoconazole and amphotericin B and did not show any profound proliferative effect. The in vivo assay also indicated that these lead molecules are very good candidates for drug design. A large library of compounds can be easily synthesized from the intermediates **51** and **61** for extensive structure-activity relation studies, so that one can reach to the more appropriate drug candidate. 1,2,3-triazole containing molecules may be considered as new entry to azole antifungals.

2.1.6 Experimental Section

2-Chloro-1-(2,4-difluorophenyl)ethanone (49):

To a solution of 1,3-difluorobenzene **48** (5.7 g, 50 mmol) in 1,2-dichloroethane (DCE, 30 mL), anhydrous aluminum chloride (7.98 g, 60 mmol) was added at 25-30 °C and stirred for 30 min. The reaction mixture was then cooled to 0 °C and chloroacetyl chloride (6.21 g, 54 mmol) in DCE (15 mL) was added to it over a period of 30 min at 0-10 °C. The reaction mixture was stirred at 25-30 °C for 7 h and diluted with the DCE (30 mL) and poured into 5% hydrochloric acid (50 mL) at 0-5 °C. The product was extracted with DCE (2x50 mL) and the combined organic layer was washed with 5% aqueous NaHCO₃ solution (20 mL), water (2 × 20 mL), brine (20 mL) and dried over anhydrous Na₂SO₄. The solvent was concentrated under reduced pressure to yield the product **49** (7.60 g).

Yellow solid, yield 80%; mp 47.5 °C (lit.⁴³ 46.5 °C); IR (cm⁻¹): 1703, 1614, 1593; ¹H NMR (CDCl₃, 200 MHz): δ 5.59 (d, *J* = 3.5 Hz, 2H), 6.93-7.10 (m, 2H), 7.99-8.11 (m, 2H), 8.21 (bs, 1H); ¹³C NMR (CDCl₃, 50 MHz): δ 58.2 (dd, ⁴*J*_{CF} = 14.1 Hz), 104.8 (dd, ²*J*_{CF} = 25.7 Hz), 112.9 (dd, ²*J*_{CF} = 21.6 Hz, ⁴*J*_{CF} = 3.0 Hz), 118.8 (dd, ²*J*_{CF} = 14.1 Hz, ⁴*J*_{CF} = 3.5 Hz), 132.9 (dd, ³*J*_{CF} = 4.5 Hz, 10.8 Hz), 144.8, 151.7, 163.0 (dd, ¹*J*_{CF} = 256.4 Hz, ³*J*_{CF} = 13.1 Hz), 166.6 (dd, ¹*J*_{CF} = 259.9 Hz, ³*J*_{CF} = 12.6 Hz), 187.6 (d, ³*J*_{CF} = 5.5 Hz); Anal. Calcd for C₁₀H₇F₂N₃O: C, 53.82; H, 3.16; N, 18.83; Found: C, 54.10; H, 3.02; N, 18.71; MS (LCMS) *m/z*: 191 (M + 1), 193 (M + 3).

1-(2,4-difluorophenyl)-2-(1H-1,2,4-triazol-1-yl)ethanone (50):

A mixture of **49** (9.05 g, 47.5 mmol), 1,2,4-triazole (3.93 g, 57.01 mmol), sodium bicarbonate (4.80 g, 57.00 mmol) in toluene (50 mL) was refluxed for 4 h. Cool the reaction mixture to rt. (25 °C) and ice was added and extracted with toluene (2x50 mL). The combined organic layer was washed with H₂O (2x20 mL), brine (20 mL) and dried over anhydrous Na₂SO₄. The solvent was concentrated under reduced pressure to yield compound **50** (7.30 g).

White solid, yield 69%; mp 104-106 °C (lit.⁴³ 103-105 °C); IR (cm⁻¹): 1703, 1614, 1593; ¹H NMR (CDCl₃, 200 MHz): δ 5.59 (d, *J* = 3.5 Hz, 2H), 6.93-7.10 (m, 2H), 7.99-8.11 (m, 2H), 8.21 (bs, 1H); ¹³C NMR (CDCl₃, 50 MHz): δ 58.2 (dd, ⁴*J*_{CF} = 14.1 Hz), 104.8 (dd, ²*J*_{CF} = 25.7 Hz), 112.9 (dd, ²*J*_{CF} = 21.7 Hz, ⁴*J*_{CF} = 3.0 Hz), 118.8 (dd, ²*J*_{CF} = 14.1 Hz, ⁴*J*_{CF} = 3.5 Hz), 132.9 (dd, ³*J*_{CF} = 4.5 Hz, 10.8 Hz), 144.8, 151.7, 163.0 (dd, ¹*J*_{CF} = 256.4 Hz, ³*J*_{CF} = 13.1 Hz), 166.6 (dd, ¹*J*_{CF} = 259.9 Hz, ³*J*_{CF} = 12.58 Hz), 187.6 (d, ³*J*_{CF} = 5.53 Hz);

Anal. Calcd for C₁₀H₇F₂N₃O: C, 53.82; H, 3.16; N, 18.83; Found: C, 54.10; H, 3.02; N, 18.71; MS (LCMS) *m/z*: 224.57 (M + 1), 246.57 (M + 23 for Na).

2-(2,4-difluorophenyl)-1-(1H-1,2,4-triazole-1-yl)pent-4-yn-2-ol (51): The ketone **50** (0.500 g, 2.24 mmol) and propargyl bromide (4 mL, 6.73 mmol) were dissolved in a mixed solvent DMF-THF 1:1 (10 mL). To this well stirred solution, activated zinc dust (washed with 2% HCl, water and dried in vacuum) (0.439 g, 6.73 mmol) was slowly added at room temperature. After 5 min exothermic reaction brought itself to reflux, which was allowed to cool to 25 °C. The reaction mixture was then stirred for 5 h at 25 °C. Ice-cold HCl (5%) was added to the reaction mixture and it was extracted with EtOAc. The extract was washed with water and brine. Solvent was evaporated under reduced pressure to afford crude product, which was purified by column chromatography on silica gel (5% MeOH/DCM) to furnish pure compound **51** (0.551 g) as white solid.

Yield 95%; mp 145-146 °C; IR (cm⁻¹): 3272, 3137; ¹H NMR (CDCl₃, 200 MHz): δ 2.06 (t, *J* = 2.6 Hz, 1H), 2.86 (dd, *J* = 16.0, 2.6 Hz, 1H ABX pattern), 2.92 (dd, *J* = 18.0, 2.6 Hz, 1H ABX pattern), 4.13 (bs, 1H, OH), 4.72 and 4.82 (Two d, *J* = 14.0 Hz, 2H AB pattern), 6.73-6.87 (m, 2H), 7.50-7.59 (m, 1H), 7.87 (s, 1H), 8.20 (s, 1H); ¹³C NMR (CDCl₃ + CD₃OD, 50 MHz): δ 29.1 (d, ⁴*J*_{CF} = 5.0 Hz), 56.3 (d, ⁴*J*_{CF} = 5.0 Hz), 71.9, 73.4 (d, ³*J*_{CF} = 4.5 Hz), 78.1, 103.9 (dd, ²*J*_{CF} = 26.2 Hz, 27.2 Hz), 111.1 (dd, ²*J*_{CF} = 20.6 Hz, ⁴*J*_{CF} = 3.5 Hz), 124.2 (dd, ²*J*_{CF} = 13.1 Hz, ⁴*J*_{CF} = 3.5 Hz), 129.6 (dd, ³*J*_{CF} = 6.0 Hz, 9.6 Hz), 144.2, 150.4, 158.6 (dd, ¹*J*_{CF} = 246.6 Hz, ³*J*_{CF} = 12.1 Hz), 162.6 (dd, ¹*J*_{CF} = 249.6 Hz, ³*J*_{CF} = 12.1 Hz); Anal. Calcd for C₁₃H₁₁F₂N₃O: C, 59.31; H, 4.21; N, 15.96; Found: C, 59.45; H, 4.13; N, 15.87; MS (LCMS) *m/z*: 264.06 (M + 1), 286.05 (M + 23 for Na).

Synthesis of azides 52-55 is described in Chapter 1.

General procedure for cycloaddition (56-59): The alkyne **51** (1 equiv.) and the C-24 azide **52** (1.3 equiv.) were dissolved in DMF/H₂O 4:1 (5 mL). To this solution CuSO₄·5H₂O (0.05 equiv) and sodium ascorbate (0.40 equiv.) were added. The reaction mixture was placed in a domestic microwave reactor and irradiated for 5 min at 415 W. The reaction mixture was cooled, ice was added and it was then extracted with EtOAc. The extract was washed with water and brine. Solvent was evaporated under reduced pressure and crude product was purified by column chromatography on silica gel using 5% MeOH/CH₂Cl₂ system to obtain fluconazole-bile acid conjugates **56** in 95% yield.

Using similar reaction condition we synthesized compounds **57**, **58** and **59** by cycloaddition of **51** with corresponding azides **53**, **54**, **55** respectively.

3 α ,12 α -Dihydroxy-24-[(4-(2-(2,4-difluorophenyl)-2-hydroxy-3-(1H-1,2,4-triazol-1-yl)propyl)-1H-1,2,3-triazol-1-yl)]-5 β -cholane (56**):** White solid, yield 95%; mp 169-171 °C; IR (cm⁻¹): 1597, 1618, 3391; ¹H NMR (CDCl₃, 200 MHz): δ 0.65 (s, 3H), 0.90-0.93 (6H), 3.15 and 3.48 (two doublets, J = 14.9 Hz, 2H, adjacent to C-4 end of 1,2,3-triazole), 3.62 (m, 1H), 3.95 (bs, 1H), 4.20 (t, J = 6.8 Hz, 2H), 4.53-4.74 (two doublets, J = 14.2 Hz, 2H), 5.55 (1H, OH), 6.70-6.80 (m, 2H), 7.19 (bs, 1H), 7.33-7.46 (m, 1H), 7.81 (bs, 1H), 8.16 (bs, 1H); Anal. Calcd for C₃₇H₅₂F₂N₆O₃: C, 66.64; H, 7.86; N, 12.60; Found: C, 66.81; H, 7.77; N, 12.55; MS (LCMS) m/z : 667.34 (M + 1).

3 α ,7 α ,12 α -Trihydroxy-24-(4-(2-(2,4-difluorophenyl)-2-hydroxy-3-(1H-1,2,4-triazol-1-yl)propyl)-1H-1,2,3-triazol-1-yl)-5 β -cholane (57**):** White solid, yield 93%; mp 118-121 °C; IR (cm⁻¹): 1597, 1618, 3404; ¹H NMR (CDCl₃, 400 MHz): δ 0.65 (s, 3H), 0.88 (s, 3H), 0.93 (d, J = 6.5 Hz, 3H), 3.17 (d, J = 14.2 Hz, 1H adjacent to 1,2,3-triazole), 3.42-3.49 (m, 2H, C3-H and 1H adjacent to 1,2,3-triazole), 3.83 (bs, 1H), 3.94 (bs, 1H), 4.19 (m, 2H), 4.58 and 4.72 (two doublets, J = 14.1 Hz, 2H, adjacent to 1,2,4-triazole), 6.69-6.78 (m, 2H), 7.20 (bs, 1H), 7.42 (m, 1H), 7.83 (bs, 1H), 8.20 (bs, 1H); Anal. Calcd for C₃₇H₅₂F₂N₆O₄: C, 65.08; H, 7.68; N, 12.31; Found: C, 64.93; H, 7.66; N, 12.45; MS (LCMS) m/z : 683.29 (M + 1), 705.27 (M + 23 for Na).

Methyl-3 β -[(4-(2-(2,4-difluorophenyl)-2-hydroxy-3-(1H-1,2,4-triazol-1-yl)propyl)-1H-1,2,3-triazol-1-yl)]-12 α -hydroxy-5 β -cholane-24-oate (58**):** White solid, yield 90%; mp 183-185 °C; IR (cm⁻¹): 1618, 1728, 3362; ¹H NMR (CDCl₃, 400 MHz): δ 0.67 (s, 3H), 0.80 (s, 3H), 0.96 (d, J = 5.9 Hz, 3H), 3.19 and 3.54 (two doublets, J = 16.3 Hz, 2H, adjacent to 1,2,3-triazole), 3.65 (s, 3H), 4.00 (bs, 1H), 4.54 (bs, 1H), 4.73 (bs, 2H, adjacent to 1,2,4-triazole), 6.63-6.80 (m, 2H), 7.23-7.35 (m, 2H), 7.86 (bs, 1H), 8.46 (bs, 1H); Anal. Calcd for C₃₈H₅₂F₂N₆O₄: C, 65.68; H, 7.54; N, 12.09; Found: C, 65.43; H, 7.67; N, 11.93; MS (LCMS) m/z : 695.35 (M + 1), 717.31 (M + 23 for Na).

Methyl-3 β -[(4-(2-(2,4-difluorophenyl)-2-hydroxy-3-(1H-1,2,4-triazol-1-yl)propyl)-1H-1,2,3-triazol-1-yl)]-7 α -12 α -dihydroxy-5 β -cholane-24-oate (59**):** White solid, yield 91%;

mp 172-174 °C; IR (cm⁻¹): 1618, 1730, 3420; ¹H NMR (CDCl₃, 400 MHz): δ 0.69 (s, 3H), 0.79 (s, 3H), 0.99 (d, *J* = 6.3 Hz, 3H), 3.12 and 3.51 (two doublets, *J* = 14.4 Hz, 2H, adjacent to 1,2,3-triazole), 3.66 (s, 3H), 3.87 (bs, 1H), 4.00 (bs, 1H), 4.46 (bs, 1H, C-3-H), 4.63- 4.72 (two doublets, *J* = 14.3 Hz, 2H, adjacent to 1,2,4-triazole), 6.66-6.75 (m, 2H), 7.21 (bs, 1H), 7.36 (bs, 1H), 7.83 (bs, 1H), 8.30 (bs, 1H); Anal. Calcd for C₃₈H₅₂F₂N₆O₅: C, 64.21; H, 7.37; N, 11.82; Found: C, 64.10; H, 7.29; N, 11.77; MS (LCMS) *m/z*: found 711.29 (M + 1), 733.26 (M + 23 for Na).

1-((2-(2,4-difluorophenyl)oxiran-2-yl)methyl-1H-1,2,4-triazole (60):

To a solution of **50** (7.30 g, 32.70 mmol) in toluene (60 mL) was added trimethylsulfoxonium iodide (8.64 g, 39.30 mmol) followed by the addition of 20% sodium hydroxide solution (8 mL). The reaction mixture was then heated at 60 °C for 4 h. After the reaction was over, it was diluted with toluene (40 mL) and poured into chilled water. The organic layer was washed with water (2×20 mL), brine (20 mL) dried over Na₂SO₄. The solvent was removed under reduced pressure to give compound **60**.

yield 91%; mp 73-74 °C; IR (CHCl₃, cm⁻¹): 1620, 1600; ¹H NMR (CDCl₃, 200 MHz): δ 2.89 and 2.96 (Two d, *J* = 4.7 Hz, 2H AB pattern), 4.53 and 4.86 (Two d, *J* = 14.8 Hz, 2H AB pattern), 6.76-6.89 (m, 2H), 7.12-7.24 (m, 1H), 7.90 (s, 1H), 8.19 (s, 1H); ¹³C NMR (CDCl₃ 50 MHz): δ 52.0, 53.4 (d, ⁴*J*_{CF} = 2.9 Hz), 56.1, 103.9 (dd, ²*J*_{CF} = 25.3 Hz, 25.3 Hz), 111.6 (dd, ²*J*_{CF} = 21.6 Hz, ⁴*J*_{CF} = 3.7 Hz), 119.4 (dd, ²*J*_{CF} = 14.6 Hz, ⁴*J*_{CF} = 3.7 Hz), 129.5 (dd, ³*J*_{CF} = 5.5 Hz, 9.9 Hz), 144.0, 151.7, 160.4 (dd, ¹*J*_{CF} = 249.2 Hz, ³*J*_{CF} = 12.08 Hz), 162.9 (dd, ¹*J*_{CF} = 251.0 Hz, ³*J*_{CF} = 11.7 Hz); Anal. Calcd for C₁₁H₉F₂N₃O: C, 55.70; H, 3.82; N, 17.71. Found: C, 55.48; H, 3.71; N, 17.61; MS (LCMS) *m/z*: 238.04 (M + 1).

1-azido-2-(2,4-difluorophenyl)-3-(1H-1,2,4-triazol-1-yl)propan-2-ol (61):

To a solution of **60** (0.237 g, 1 mmol) in dry DMF (10 mL), sodium azide (0.214 g, 3.3 mmol) was added and stirring was continued at 60-65 °C for 3-5 h. The reaction mixture was allowed to cool to room temperature. It was then poured into ice-cold water (30 mL) and extracted with EtOAc. The organic extract was washed with cold water and brine. Solvent was evaporated under reduced pressure to afford crude product which was purified by column chromatography on silica gel (10% EtOAc/hexane) to produce pure compound **61** in 75% yield. Spectroscopic data of this compound match with the literature data.⁵¹

yield 75%; mp 66-67 °C; IR (CHCl₃, cm⁻¹): 3353, 2106, 1618, 1596; ¹H NMR (CDCl₃, 200 MHz): δ 3.52 (Two d, *J* = 12.9 Hz, 2H, AB pattern), 4.68 and 4.79 (Two d, *J* = 14.3 Hz, 2H, AB pattern), 5.02 (bs, 1H, OH), 4.72 and 4.82 (Two d, *J* = 14.0 Hz, 2H AB pattern), 6.72-6.88 (m, 2H), 7.50-7.59 (m, 1H), 7.84 (s, 1H), 7.93 (s, 1H); ¹³C NMR (CDCl₃, 50 MHz): δ 54.6 (d, ⁴*J*_{CF} = 5.8 Hz), 56.8 (d, ⁴*J*_{CF} = 4.4 Hz), 76.1, (d, ³*J*_{CF} = 4.4 Hz), 104.2 (dd, ²*J*_{CF} = 25.6 Hz, 25.6 Hz), 111.8 (dd, ²*J*_{CF} = 20.9 Hz, ⁴*J*_{CF} = 2.9 Hz), 122.6 (dd, ²*J*_{CF} = 12.4 Hz, ⁴*J*_{CF} = 3.7 Hz), 130.0 (dd, ³*J*_{CF} = 5.9 Hz, 9.5 Hz), 144.2, 151.4, 158.5 (dd, ¹*J*_{CF} = 247.0 Hz, ³*J*_{CF} = 12.5 Hz), 162.9 (dd, ¹*J*_{CF} = 251.4 Hz, ³*J*_{CF} = 12.3 Hz); Anal. Calcd for C₁₁H₁₀F₂N₆O: C, 47.15; H, 3.60; N, 29.99. Found: C, 46.83; H, 3.85; N, 29.90; MS (LCMS) *m/z*: 281.2215 (M + 1).

Fluconazole-bile acid conjugates 64 and 65: Compound **64** was synthesized from cycloaddition reaction of compounds **61** with **62** and **65** was synthesized from **61** and **63** by using general procedure as described for the synthesis of compounds **56-59**.

Compound (64): yield 95%; mp 114-115 °C; IR (CHCl₃, cm⁻¹): 3411, 1731, 1618; ¹H NMR (CDCl₃, 400 MHz): δ 0.66 (s, 3H), 0.91 (s, 3H), 0.95 (d, *J* = 6.0 Hz, 3H), 1.01-2.45 (m) 3.62 (m, 1H), 3.96 (bs, 1H), 4.30 (d, *J* = 14.52 Hz, 1H), 4.70 and 4.85 (Two d, *J* = 14.2 and 14.3 Hz, 2H), 4.90 (d, *J* = 14.0 Hz, 1H) 5.2 (bs, 2H), 6.74-6.87 (m, 2H), 7.35-7.48 (m, 1H), 7.71 (s, 1H), 7.85 (s, 1H), 8.02 (bs, 1H); ¹³C NMR (CDCl₃, 100 MHz): δ 12.5, 17.0, 22.9, 23.5, 26.0, 26.9, 27.3, 28.3, 30.0, 30.5, 30.8, 33.3, 35.0, 35.1, 35.7, 36.0, 41.8, 46.2, 46.7, 47.9, 54.8, 57.0, 57.8, 71.3, 72.8, 74.7, 77.2, 104.2 (dd, ²*J*_{CF} = 25.7 Hz, 27.1 Hz), 111.7 (dd, ²*J*_{CF} = 20.6 Hz), 121.7 (dd, ²*J*_{CF} = 12.2 Hz, ⁴*J*_{CF} = 3.2 Hz), 125.7, 129.8 (dd, ³*J*_{CF} = 4.4 Hz, 8.1 Hz), 142.5, 151.4, 158.5 (dd, ¹*J*_{CF} = 248.0 Hz, ³*J*_{CF} = 13.2 Hz), 162.9 (dd, ¹*J*_{CF} = 252.4 Hz, ³*J*_{CF} = 13.2 Hz), 173.9; Anal. Calcd for C₃₈H₅₂F₂N₆O₅: C, 64.21; H, 7.37; N, 11.82. Found: C, 64.49; H, 7.28; N, 11.72; MS (LCMS) *m/z*: 711.6959 (M + 1).

Compound (65): yield 94%; mp 123-126 °C; IR (CHCl₃, cm⁻¹): 3379, 1731, 1618, 1598; ¹H NMR (CDCl₃, 400 MHz): δ 0.66 (s, 3H), 0.88 (s, 3H), 0.94 (bs, 3H), 1.01-2.45 (m) 3.45 (m, 1H), 3.85 (bs, 1H), 3.95 (bs, 1H), 4.85-4.93 (bs, 3H), 5.14 (bs, 2H), 6.74-6.81 (m, 2H), 7.73(m, 1H), 7.75 (bs, 1H), 7.95 (bs, 1H), 8.44 (bs, 1H); ¹³C NMR (CDCl₃, 100 MHz): δ 12.2, 14.0, 17.1, 20.9, 22.3, 23.0, 26.2, 27.3, 28.0, 30.0, 30.6, 30.8, 34.6, 35.1, 39.3, 41.3, 41.5, 46.2, 46.5, 53.3, 55.0, 55.8, 57.1, 60.2, 68.1, 71.5, 72.8, 74.7, 77.2, 104.2

(dd, $^2J_{CF} = 27.88$ Hz, 27.14 Hz), 111.7 (dd, $^2J_{CF} = 18.3$ Hz), 121.7 (dd, $^2J_{CF} = 13.9$ Hz, $^4J_{CF} = 2.9$ Hz), 125.7, 129.8, 142.5, 151.1, 158.6 (dd, $^1J_{CF} = 248.0$ Hz, $^3J_{CF} = 12.5$ Hz), 162.9 (dd, $^1J_{CF} = 250.9$ Hz, $^3J_{CF} = 13.2$ Hz); Anal. Calcd for $C_{38}H_{52}F_2N_6O_6$: C, 62.79; H, 7.21; N, 11.56. Found: C, 62.52; H, 7.48; N, 11.80; MS (LCMS) m/z : 727.6560 (M + 1).

General procedure for 67(a-d):

To a solution of benzimidazole (2 mmol) in dry DMF (3 mL), NaH (3 mmol) was added and the reaction mixture was stirred at 0 °C for 20 min. To this reaction mixture compound **66** (1 mmol) dissolved in DMF (2 mL) was added dropwise at 0 °C. The reaction mixture was allowed to warm to 25 °C, and was stirred for 24 h. Ice was added to the reaction mixture and it was extracted with EtOAc. The extract was washed with water, brine and solvent was evaporated under reduced pressure to afford crude product, which was purified by column chromatography on silica gel (5% MeOH/ CH_2Cl_2) to obtain compound **67a** in 75% yield. Using similar procedure we have synthesized **67(b-d)** in 75-95% yield from nucleophilic substitution of mesyl **66** with benzimidazole, 1,2,4-triazole, and benzotriazole respectively.

3 α ,12 α -Dihydroxy-24-(1H-imidazol-1-yl)-5 β -cholane (67a): White solid, 75%; mp 215-216 °C; $[\alpha]_D^{25}$ ($CHCl_3$, c 0.7) = + 50.30; IR (cm^{-1}): 3300, 1510; 1H NMR ($CDCl_3$, 200 MHz): δ 0.67 (s, 3H), 0.91 (s, 3H), 0.97 (d, $J = 6.3$ Hz, 3H), 3.62 (m, 1H), 3.90 (t, $J = 7.44$ Hz, 2H), 3.98 (bs, 1H), 6.91 (bs, 1H), 7.06 (bs, 1H), 7.48 (bs, 1H); ^{13}C NMR ($CDCl_3$ + CD_3OD , 50 MHz): δ 12.3, 17.1, 22.7, 22.7, 23.4, 25.9, 26.9, 27.3, 27.4, 28.4, 29.6, 32.4, 33.3, 33.9, 35.0, 35.0, 35.8, 41.9, 46.7, 47.4, 47.7, 48.6, 71.1, 72.6, 118.8, 128.1, 136.5; Anal. Calcd for $C_{27}H_{44}N_2O_2$: C, 75.65; H, 10.35; N, 6.54; Found: C, 75.77; H, 10.21; N, 6.43; MS (LCMS) m/z : 429.30 (M + 1), 451.26 (M + 23 for Na).

3 α ,12 α -Dihydroxy-24-(1H-benzof[d]imidazol-1-yl)-5 β -cholane (67b): White solid, yield 91%; mp 118 °C; $[\alpha]_D^{27}$ ($CHCl_3$, c 1.0) = + 42.77; IR (cm^{-1}): 3346, 1643, 1616; 1H NMR ($CDCl_3$, 300 MHz): δ 0.65 (s, 3H), 0.90 (s, 3H), 0.95 (d, $J = 6.6$ Hz, 3H), 3.60 (m, 1H), 3.96 (bs, 1H), 4.13 (t, $J = 6.6$ Hz, 2H), 7.26-7.32 (m, 2H), 7.38-7.41 (m, 1H), 7.79-7.82 (m, 1H), 7.90 (s, 1H); ^{13}C NMR ($CDCl_3$, 50 MHz): δ 12.5, 17.4, 23.0, 23.5, 26.0, 26.4, 27.0, 27.4, 28.7, 30.4, 32.9, 33.5, 34.0, 35.1, 35.2, 35.9, 36.3, 42.0, 45.4, 46.3, 47.0, 48.1, 71.4, 72.8, 109.5, 120.1, 121.9, 122.7, 133.7, 142.7, 143.5; Anal. Calcd for $C_{31}H_{46}N_2O_2$:

C, 77.78; H, 9.69; N, 5.85; Found: C, 77.64; H, 9.54; N, 5.77; MS (LCMS) m/z : 479.26 (M + 1), 501.20 (M + 23 for Na).

3 α ,12 α -Dihydroxy-24-(1H-1,2,4-triazol-1-yl)-5 β -cholane (67c): White solid, yield 95%; mp 196-197 °C; $[\alpha]_D^{26}$ (CHCl₃, c 0.7) = + 45.33; IR (cm⁻¹): 3421; ¹H NMR (CDCl₃, 200 MHz): δ 0.66 (s, 3H), 0.90 (s, 3H), 0.98 (d, J = 6.3 Hz, 3H), 3.61 (m, 1H), 3.97 (bs, 1H), 4.13 (t, J = 6.7 Hz, 2H), 7.94 (s, 1H), 8.05 (s, 1H); ¹³C NMR (CDCl₃, 50 MHz): δ 12.4, 17.1, 22.8, 23.4, 25.9, 26.2, 26.9, 27.4, 28.3, 26.6, 32.2, 33.3, 33.8, 35.0, 35.0, 35.7, 35.7, 41.8, 46.1, 46.8, 47.8, 50.1, 71.2, 72.7, 142.6, 151.0; Anal. Calcd for C₂₆H₄₃N₃O₂: C, 72.68; H, 10.09; N, 9.78; Found: C, 72.49; H, 10.00; N, 9.67; MS (LCMS) m/z : 430.49 (M + 1), 452.44 (M + 23 for Na).

3 α ,12 α -Dihydroxy-24-(1H-benzo[d][1,2,3]triazol-1-yl)-5 β -cholane (67d): White solid, yield 92%; mp 98-101 °C; $[\alpha]_D^{26}$ (CHCl₃, c 0.5) = + 47.82; IR (cm⁻¹): 3417; ¹H NMR (CDCl₃, 300 MHz): δ 0.65 (s, 3H), 0.90 (s, 3H), 0.95 (d J = 6.6 Hz, 3H), 3.61 (m, 1H), 3.95 (bs, 1H), 4.61 (t, J = 7.3 Hz, 2H), 7.34-7.40 (m, 1H), 7.46-7.55 (m, 2H), 8.06 (d, J = 8.06 Hz, 1H); ¹³C NMR (CDCl₃, 50 MHz): δ 12.6, 17.5, 23.0, 23.6, 26.1, 26.4, 27.1, 27.4, 28.6, 30.4, 32.8, 33.6, 34.0, 35.0, 35.2, 36.0, 36.4, 42.1, 46.4, 47.2, 48.1, 48.6, 71.6, 73.0, 109.2, 119.9, 126.0, 127.0, 132.9, 144.2; Anal. Calcd for C₃₀H₄₅N₃O₂: C, 75.11; H, 9.46; N, 8.76; Found: C, 75.26; H, 9.39; N, 8.71; MS (LCMS) m/z : 480.53 (M + 1), 502.49 (M + 23 for Na).

Synthesis of fluconazole analogues 68-72:

Compound **68** was synthesized from acetylenic compound **51** and azidotrimethylsilane using similar procedure as described for the synthesis of compound **56-59**. Similarly compound **69** was synthesized from **51** and 1-azidooctane while compound **72** was synthesized from azido compound **61** and 1-octyne. Similar reaction of compound **61** with trimethylsilyl acetylene at 175 W for 10 min gave a mixture of compounds **70** and **71** which was separated by column chromatography on silica gel.

2-(2,4-difluorophenyl)-1-(1H-1,2,4-triazole-1-yl)-3-(1H-1,2,3-triazol-4yl)propan-2-ol (68): yield 87% mp 92-94 °C; IR (CHCl₃, cm⁻¹): 3400, 1616, 1596; ¹H NMR (CDCl₃ + CD₃OD, 200 MHz): δ 3.16 (d, J = 14.9 Hz, 1H), 3.44 (d, J = 14.9 Hz, 1H), 4.53 and 4.70

(Two d, $J = 14.2$ and 14.3 Hz, 2H), 6.58-6.79 (m, 2H), 7.13-7.21 (m, 1H), 7.22 (s, 1H), 7.75 (s, 1H), 8.22 (s, 1H); ^{13}C NMR ($\text{CDCl}_3 + \text{CD}_3\text{OD}$, 100 MHz): δ 33.3 (d, $^4J_{\text{CF}} = 4.4$ Hz), 57.0 (d, $^4J_{\text{CF}} = 5.1$ Hz), 74.1 (d, $^3J_{\text{CF}} = 4.4$ Hz), 77.2, 103.7 (dd, $^2J_{\text{CF}} = 26.4$ Hz, 27.1 Hz), 110.9 (dd, $^2J_{\text{CF}} = 20.5$ Hz, $^4J_{\text{CF}} = 2.9$ Hz), 124.0 (dd, $^2J_{\text{CF}} = 12.5$ Hz, $^4J_{\text{CF}} = 3.7$ Hz), 129.0, 129.4 (dd, $^3J_{\text{CF}} = 5.9$ Hz, 8.8 Hz), 139.6, 144.2, 150.0, 158.4 (dd, $^1J_{\text{CF}} = 249.4$ Hz, $^3J_{\text{CF}} = 12.5$ Hz), 162.4 (dd, $^1J_{\text{CF}} = 246.5$ Hz, $^3J_{\text{CF}} = 11.7$ Hz); Anal. Calcd for $\text{C}_{13}\text{H}_{12}\text{F}_2\text{N}_6\text{O}$: C, 50.98; H, 3.95; N, 27.44. Found: C, 50.79; H, 3.81; N, 27.05; MS (LCMS) m/z : 307.3486 ($M + 1$).

2-(2,4-difluorophenyl)-1-(1-octyl-1H-1,2,3-triazol-4-yl)-3-(1H-1,2,4-triazole-1-yl)

propan-2-ol (69): yield 94% mp 119-120 °C; IR (CHCl_3 , cm^{-1}): 3176, 1618, 1596; ^1H NMR (CDCl_3 , 200 MHz): δ 0.87 (t, $J = 6.8$ Hz, 3H), 1.22 (bs, 10H), 1.77 (m, 2H), 3.13 (d, $J = 14.9$ Hz, 1H), 3.48 (dd, $J = 14.9$, 1.32 Hz, 1H ABX pattern), 4.22 (t, $J = 7.1$ Hz, 2H), 4.57 and 4.71 (Two d, $J = 14.2$ Hz, 2H AB pattern), 5.49 (bs, 1H, OH), 6.65-6.79 (m, 2H), 7.18 (s, 1H), 7.32-7.45 (m, 1H), 7.81 (s, 1H), 8.15 (s, 1H); ^{13}C NMR (CDCl_3 , 50 MHz): δ 13.8, 22.3, 26.0, 28.6, 28.8, 29.9, 31.5, 33.6 (d, $^4J_{\text{CF}} = 5.8$ Hz), 50.1, 57.0 (d, $^4J_{\text{CF}} = 3.8$ Hz), 74.0 (d, $^3J_{\text{CF}} = 3.8$ Hz), 103.7 (dd, $^2J_{\text{CF}} = 26.9$ Hz, 27.9 Hz), 111.1 (dd, $^2J_{\text{CF}} = 20.7$ Hz, $^4J_{\text{CF}} = 3.8$ Hz), 122.2, 123.8 (dd, $^2J_{\text{CF}} = 13.4$ Hz, $^4J_{\text{CF}} = 3.8$ Hz), 130.0 (dd, $^3J_{\text{CF}} = 5.8$ Hz, 7.7 Hz), 142.4, 144.5, 151.0, 158.4 (dd, $^1J_{\text{CF}} = 245.7$ Hz, $^3J_{\text{CF}} = 11.5$ Hz), 162.4 (dd, $^1J_{\text{CF}} = 249.5$ Hz, $^3J_{\text{CF}} = 13.4$ Hz); Anal. Calcd for $\text{C}_{21}\text{H}_{28}\text{F}_2\text{N}_6\text{O}$: C, 60.27; H, 6.74; N, 20.08. Found: C, 59.95; H, 6.89; N, 19.78; MS (LCMS) m/z : 419.5365 ($M + 1$).

2-(2,4-difluorophenyl)-1-(1H-1,2,3-triazol-1-yl)-3-(1H-1,2,4-triazole-1-yl)propan-2-ol

(70): yield 74% mp 131-132 °C; IR (CHCl_3 , cm^{-1}): 3224, 1618, 1596; ^1H NMR (CDCl_3 , 200 MHz): δ 4.31 (d, $J = 14.3$ Hz, 1H), 4.77 and 4.88 (Two d, $J = 14.4$ and 14.3 Hz, 2H), 4.89 (d, $J = 14.4$ Hz, 1H), 6.73-6.87 (m, 2H), 7.35-7.48 (m, 1H), 7.65 (bs, 1H), 7.66 (bs, 1H), 7.85 (bs, 1H), 8.06 (bs, 1H); ^{13}C NMR ($\text{CDCl}_3 + \text{CD}_3\text{OD}$, 100 MHz): δ 54.9 (d, $^4J_{\text{CF}} = 5.9$ Hz), 55.5 (d, $^4J_{\text{CF}} = 4.4$ Hz), 74.3 (d, $^3J_{\text{CF}} = 4.4$ Hz), 104.0 (dd, $^2J_{\text{CF}} = 26.7$ Hz, 27.2 Hz), 111.4 (dd, $^2J_{\text{CF}} = 21.3$ Hz, $^4J_{\text{CF}} = 2.2$ Hz), 121.6 (dd, $^2J_{\text{CF}} = 13.2$ Hz, $^4J_{\text{CF}} = 3.7$ Hz), 125.6, 129.4 (dd, $^3J_{\text{CF}} = 5.9$ Hz, 9.5 Hz), 133.0, 144.5, 150.5, 158.6 (dd, $^1J_{\text{CF}} = 247.2$ Hz, $^3J_{\text{CF}} = 11.7$ Hz), 162.8 (dd, $^1J_{\text{CF}} = 250.9$ Hz, $^3J_{\text{CF}} = 11.7$ Hz); Anal. Calcd for $\text{C}_{13}\text{H}_{12}\text{F}_2\text{N}_6\text{O}$: C, 50.98; H, 3.95; N, 27.44. Found: C, 50.68; H, 3.74; N, 27.71; MS (LCMS) m/z : 307.3445 ($M + 1$).

2-(2,4-difluorophenyl)-1-(1H-1,2,3-triazol-1-yl)-3-(4-(trimethylsilyl)-1H-1,2,4-triazole-1-yl) propan-2-ol (71): yield 21% mp 183-184 °C; IR (CHCl₃, cm⁻¹): 3124, 1616, 1595; ¹H NMR (CDCl₃, 200 MHz): δ 0.30 (s, 9H), 4.44 (d, *J* = 14.3 Hz, 1H), 4.80 and 4.93 (Two d, *J* = 14.3 and 14.2 Hz, 2H), 4.90 (d, *J* = 14.3 Hz, 1H), 6.72-6.87 (m, 2H), 7.33-7.46 (m, 1H), 7.64 (s, 1H), 7.86 (s, 1H), 8.21 (s, 1H); ¹³C NMR (CDCl₃, 100 MHz): δ -1.33, 54.7 (d, ⁴*J*_{CF} = 5.9 Hz), 55.4 (d, ⁴*J*_{CF} = 4.4 Hz), 75.14 (d, ³*J*_{CF} = 4.4 Hz), 104.2 (dd, ²*J*_{CF} = 26.4 Hz, 27.2 Hz), 111.9 (dd, ²*J*_{CF} = 21.3 Hz, ⁴*J*_{CF} = 2.9 Hz), 122.0 (dd, ²*J*_{CF} = 12.5 Hz, ⁴*J*_{CF} = 3.7 Hz), 130.0 (dd, ³*J*_{CF} = 5.1 Hz, 9.5 Hz), 131.2, 144.6, 146.3, 151.6, 158.5 (dd, ¹*J*_{CF} = 245.8 Hz, ³*J*_{CF} = 11.7 Hz), 163.1 (dd, ¹*J*_{CF} = 250.9 Hz, ³*J*_{CF} = 11.7 Hz); Anal. Calcd for C₁₆H₂₀F₂N₆OSi: C, 50.78; H, 5.33; N, 22.21. Found: C, 50.93; H, 5.20; N, 22.10; MS (LCMS) *m/z*: 379.3853 (M + 1).

2-(2,4-difluorophenyl)-1-(4-hexyl-1H-1,2,3-triazole-1-yl)-3-(1H-1,2,4-triazol-1-yl) propan-2-ol (72): yield 78% mp 112-113 °C; IR (CHCl₃, cm⁻¹): 3272, 1616, 1596; ¹H NMR (CDCl₃, 200 MHz): δ 0.87 (t, *J* = 6.7 Hz, 3H), 1.26 (bs, 6H), 1.58 (m, 2H), 2.64 (t, *J* = 7.7 Hz, 2H), 4.33 (d, *J* = 14.3 Hz, 1H), 4.72 (bs, 2H), 4.84 (d, *J* = 14.4 Hz, 1H), 5.40 (bs, 1H, OH), 6.72-6.85 (m, 2H), 7.32 (s, 1H), 7.36-7.49 (m, 1H), 7.84 (s, 1H), 8.03 (s, 1H); ¹³C NMR (CDCl₃, 100 MHz): δ 13.9, 22.4, 25.2, 28.5, 29.1, 31.3, 54.6 (d, ⁴*J*_{CF} = 5.1 Hz), 55.6 (d, ⁴*J*_{CF} = 4.8 Hz), 75.0 (d, ³*J*_{CF} = 4.8 Hz), 104.1 (dd, ²*J*_{CF} = 26.0 Hz, 27.4 Hz), 111.8 (dd, ²*J*_{CF} = 20.9 Hz, ⁴*J*_{CF} = 3.3 Hz), 121.9 (dd, ²*J*_{CF} = 12.8 Hz, ⁴*J*_{CF} = 3.7 Hz), 122.7, 129.9 (dd, ³*J*_{CF} = 5.5 Hz, 9.5 Hz), 148.1, 151.5, 158.5 (dd, ¹*J*_{CF} = 247.0 Hz, ³*J*_{CF} = 12.4 Hz), 162.9 (dd, ¹*J*_{CF} = 251.8 Hz, ³*J*_{CF} = 12.8 Hz); Anal. Calcd for C₁₉H₂₄F₂N₆O: C, 58.45; H, 6.20; N, 21.53. Found: C, 58.81; H, 5.97; N, 21.19; MS (LCMS) *m/z*: 391.2770 (M + 1).

The in vitro antifungal activity: materials and methods

Minimum inhibitory concentration (MIC) of compounds was tested according to standard microbroth dilution technique as per NCCLS guidelines.⁵² Briefly, testing was performed in flat bottom 96 well tissue culture plates (CELLSTAR Greiner bio-one GmbH, Germany) in RPMI 1640 medium buffered with MOPS (3-[N-morpholino] propanesulfonic acid) (Sigma Chem. Co., MO, USA). The concentration range of tested compounds was 50–0.001 and 32–0.0018 µg/mL for standard compounds. The plates

were incubated in a moist chamber at 35 °C and absorbance at 492 nm was recorded on VersaMax microplate reader (Molecular Devices, Sunnyvale, USA) after 48 h for *C. albicans* and *C. parapsilosis*, 72 h for *Aspergillus fumigatus*, *S. schenckii*, and *Cryptococcus neoformans*, and 96 h for *Trichophyton mentagrophytes*. MIC was determined as 80% inhibition of growth with respect to the growth control and IC₅₀ was the concentration at which 50% growth inhibition was observed by using SOFTmax Pro 4.3 Software (Molecular Devices, Sunnyvale, USA).

The in vivo antifungal activity: Materials and Methods

Three of the active compounds **64**, **69** and **72** were evaluated in vivo against *C. albicans* intravenous challenge in Swiss mice. The animals were inoculated with 4x10⁵ cells intravenously and randomly grouped (6 mice per group). The compounds dissolved in PEG 200 were given once a day through oral route. The treatment was given from zero hour to 7 days. Amphotericin B (5mg/kg/p.o.) was taken as positive drug control. On day 9 the mice were sacrificed and both the kidneys taken out and homogenized in physiological saline. The colony forming units (CFU) per gram kidney tissue were determined by 10 fold serial dilution and plating technique. Prior clearance from local animal ethics committee was obtained.

Antiproliferative Activity. Materials and methods:

Human hepatocellular carcinoma Hep3B and human epithelial carcinoma A431 cell lines were obtained from American Type Culture Collection (Manassas, VA, USA), and maintained in the in-house National Cell repository at National Centre for Cell Science. Cells were maintained as a monolayer in culture medium consisting of nutrient media DMEM supplemented with heat inactivated fetal bovine serum (10%), penicillin (100 U/mL) and streptomycin (100 µg/mL) (Invitrogen Life Technologies, MD, USA). The cells were grown at 37 °C in 5% CO₂ and humidified air atmosphere. Stock solutions of the compounds were prepared in DMSO at a concentration of 2 mg/ml and 1mg/ml depending on the solubility of the compound in the solvent and afterwards diluted to the required concentration. The 3-(4, 5-dimethylthiazol-2-yl)-2, 5-diphenyltetrazolium bromide (MTT) was dissolved (1 mg/mL) in DMEM (without phenol red). Hep3B and A431 cells were plated at a density of 7500 cells per well in 96 well tissue culture plates. Cells were allowed to adhere for 24 h at 37 °C and then treated with various

concentrations (0, 0.001, 0.01, 0.1, 1.0 mg/mL) of compounds diluted in culture medium, for additional 48 h. In the cells in control wells culture medium consisting of corresponding concentration of DMSO only was added. After 48 h of drug treatment growth medium was removed from each well containing cells and fresh culture medium was added to each well. Cells were allowed to grow for another 24 h. Thereafter, cell proliferation was assessed by replacing culture medium with 50 μ L DMEM media containing 1 mg/mL MTT and subsequently incubated for additional 4 h at 37 °C. Medium was then aspirated off and formazan crystals were solubilized in 100 μ L of isopropanol. The optical density was read on a microplate reader at 570 nm using 630 nm as a reference filter against a blank prepared from cell free wells. Absorbance given by cells treated with the carrier DMSO alone was taken as 100% cell growth.

2.1.7 Selected Spectra

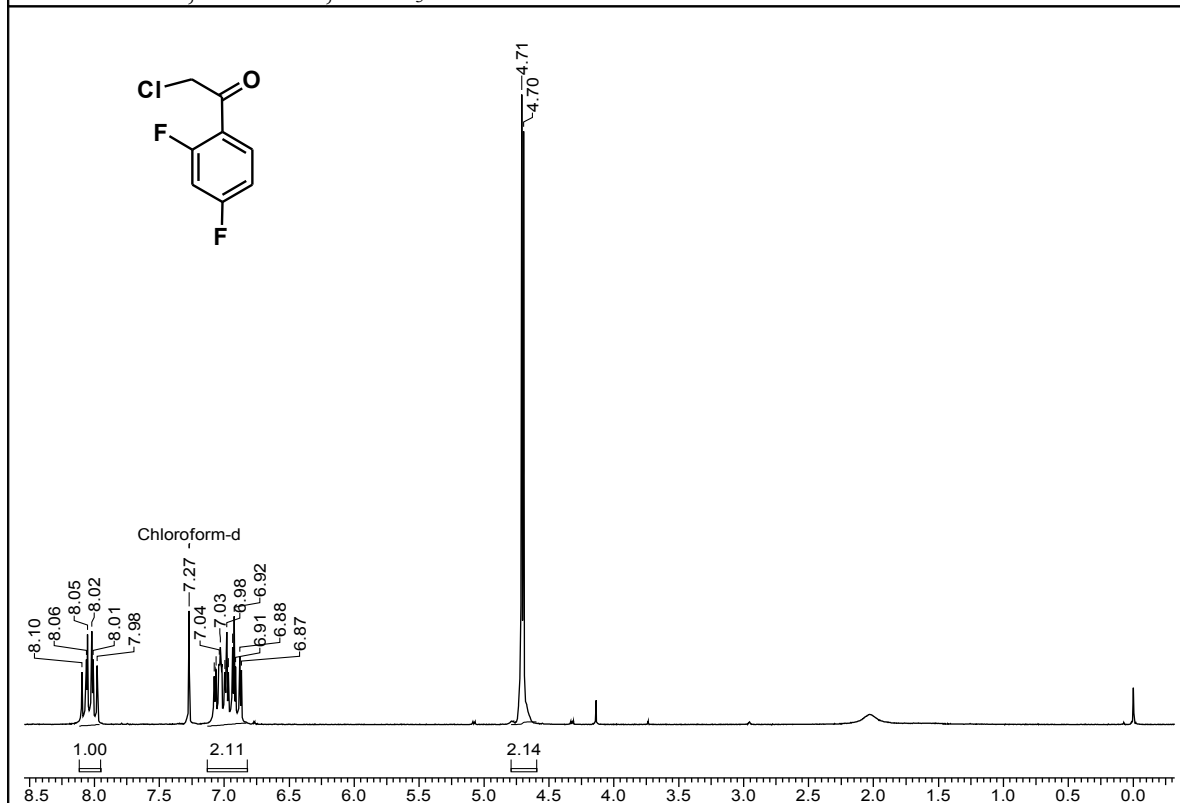
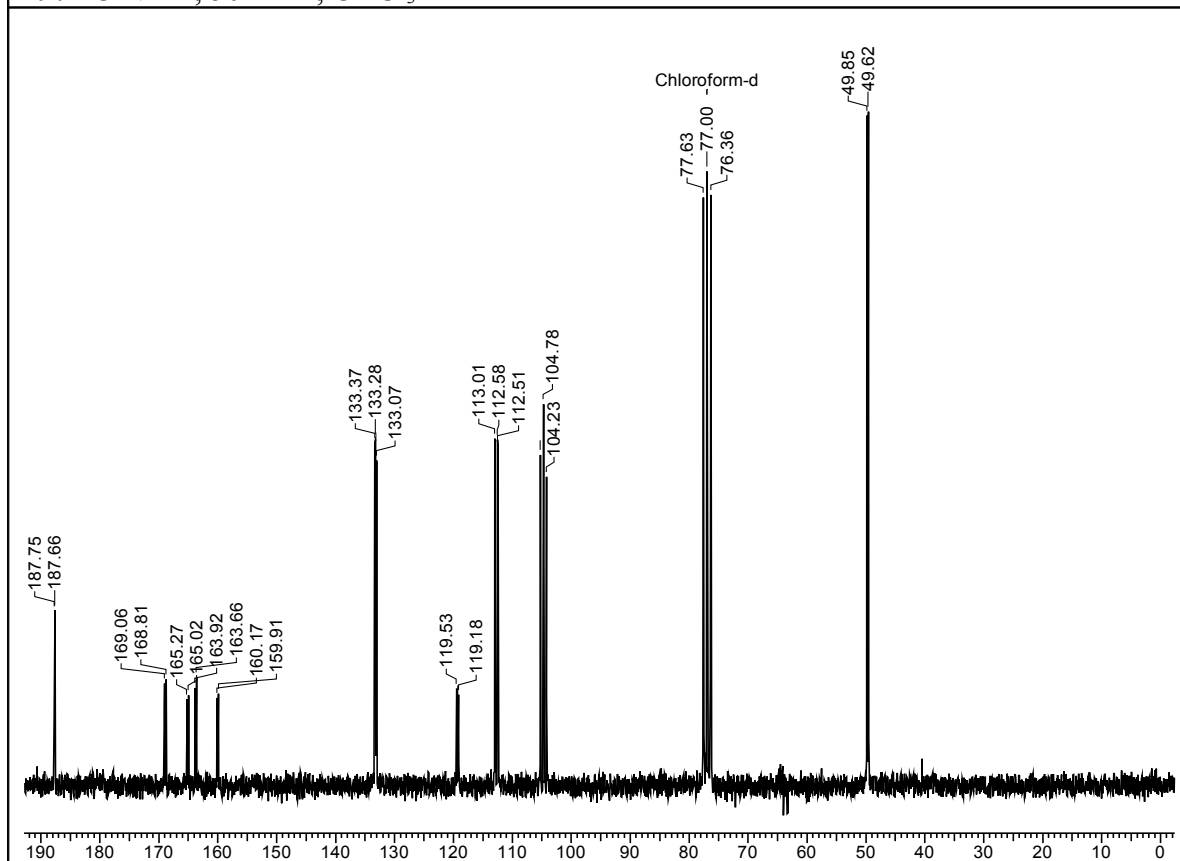
49: ^1H NMR, 200 MHz, CDCl_3 49: ^{13}C NMR, 50 MHz, CDCl_3 

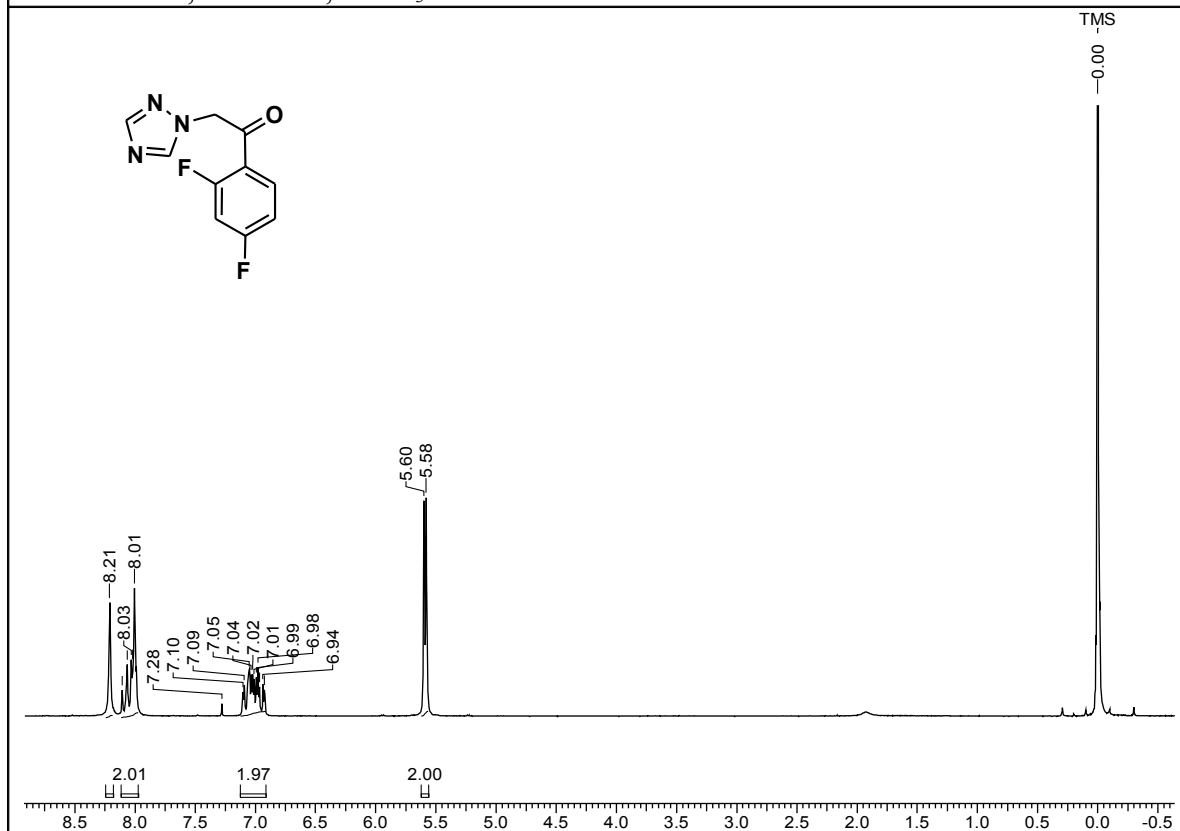
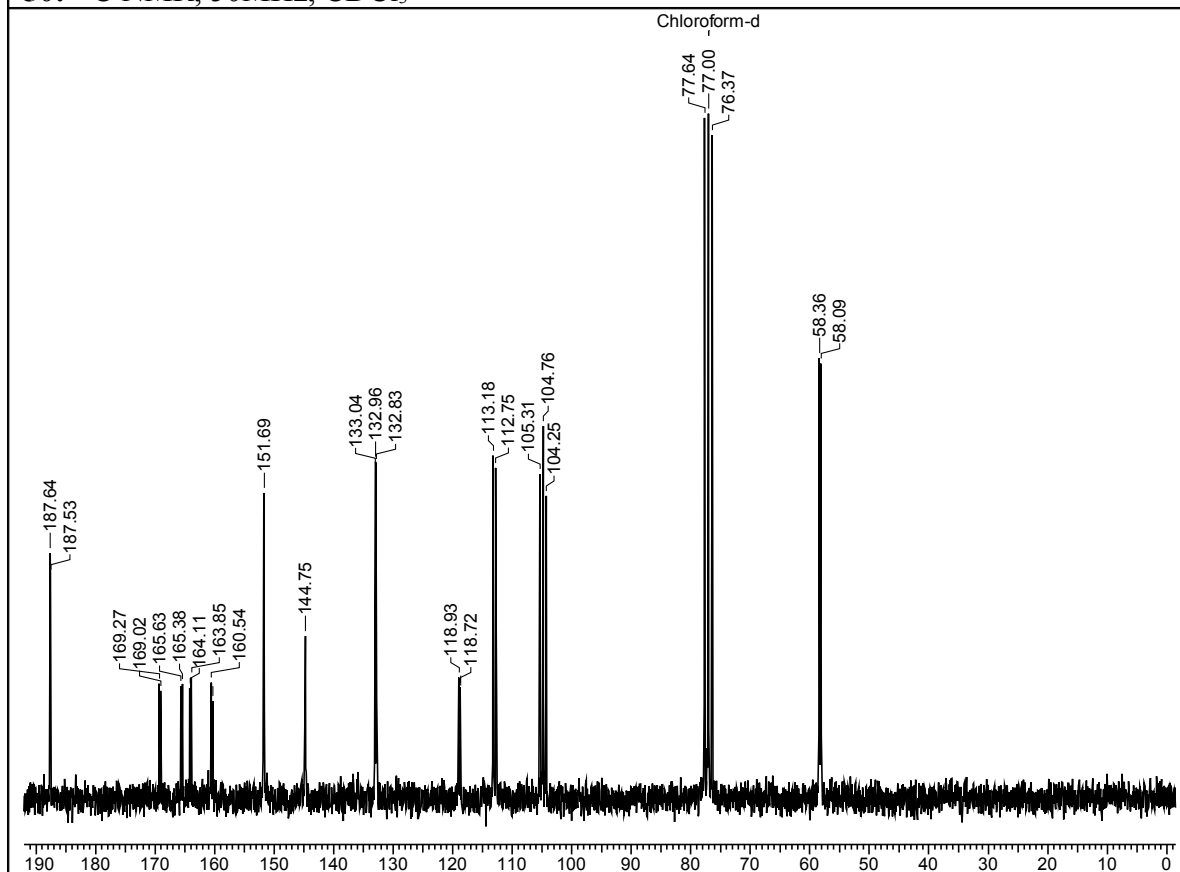
50: ^1H NMR, 200 MHz, CDCl_3 **50:** ^{13}C NMR, 50 MHz, CDCl_3 

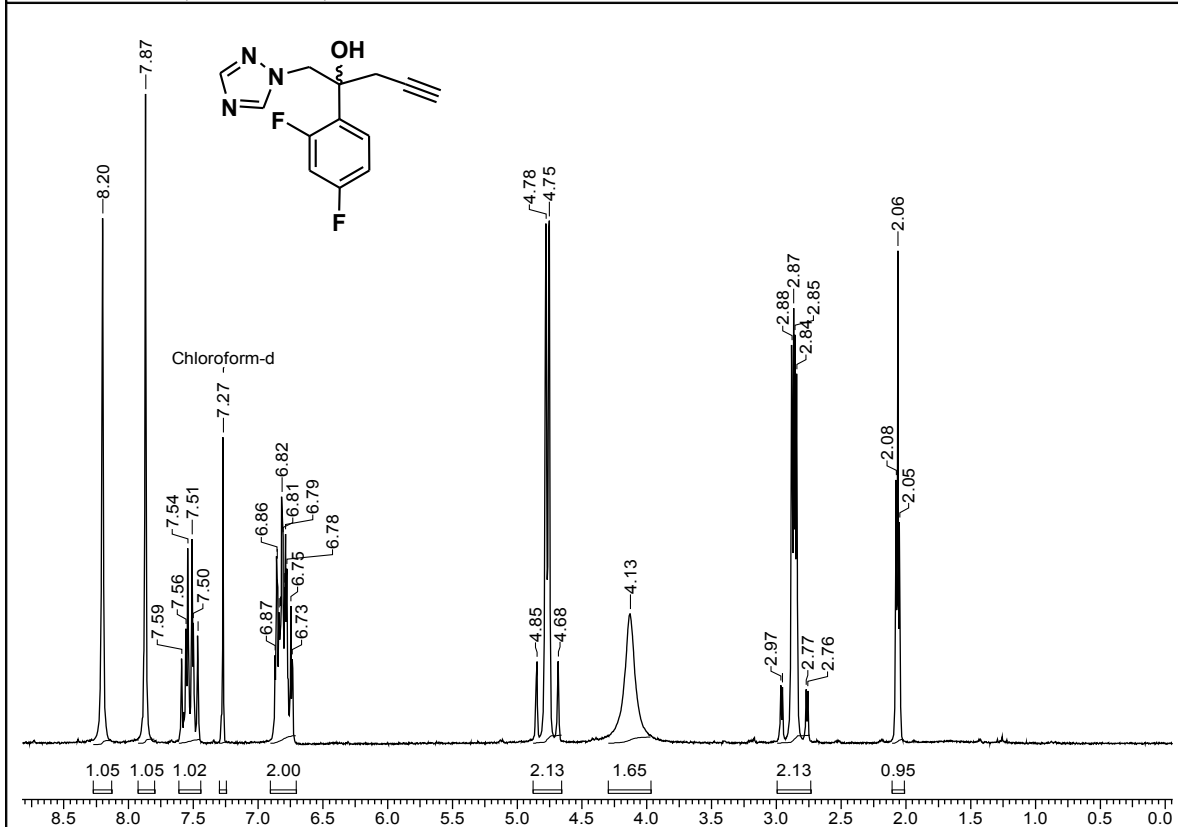
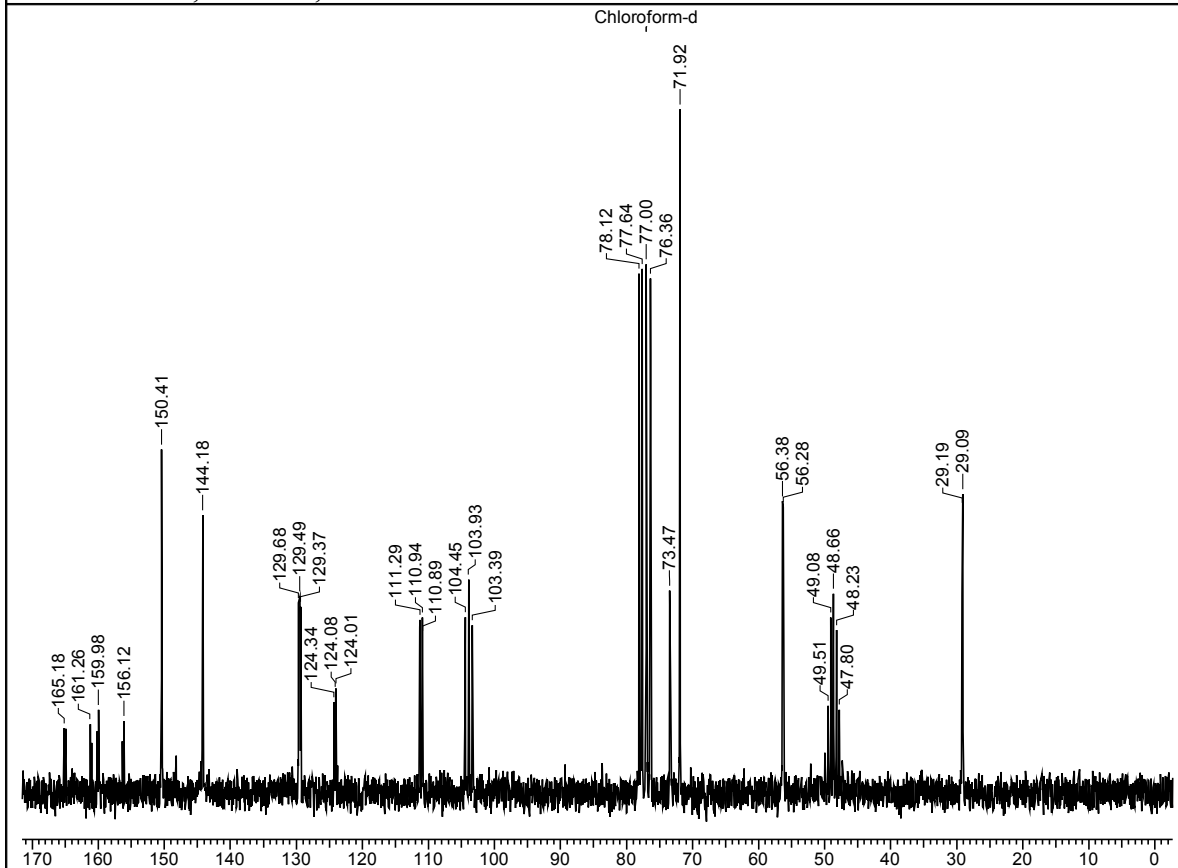
51: ^1H NMR, 200 MHz, CDCl_3 **51:** ^{13}C NMR, 50 MHz, $\text{CDCl}_3 + \text{CD}_3\text{OD}$ 

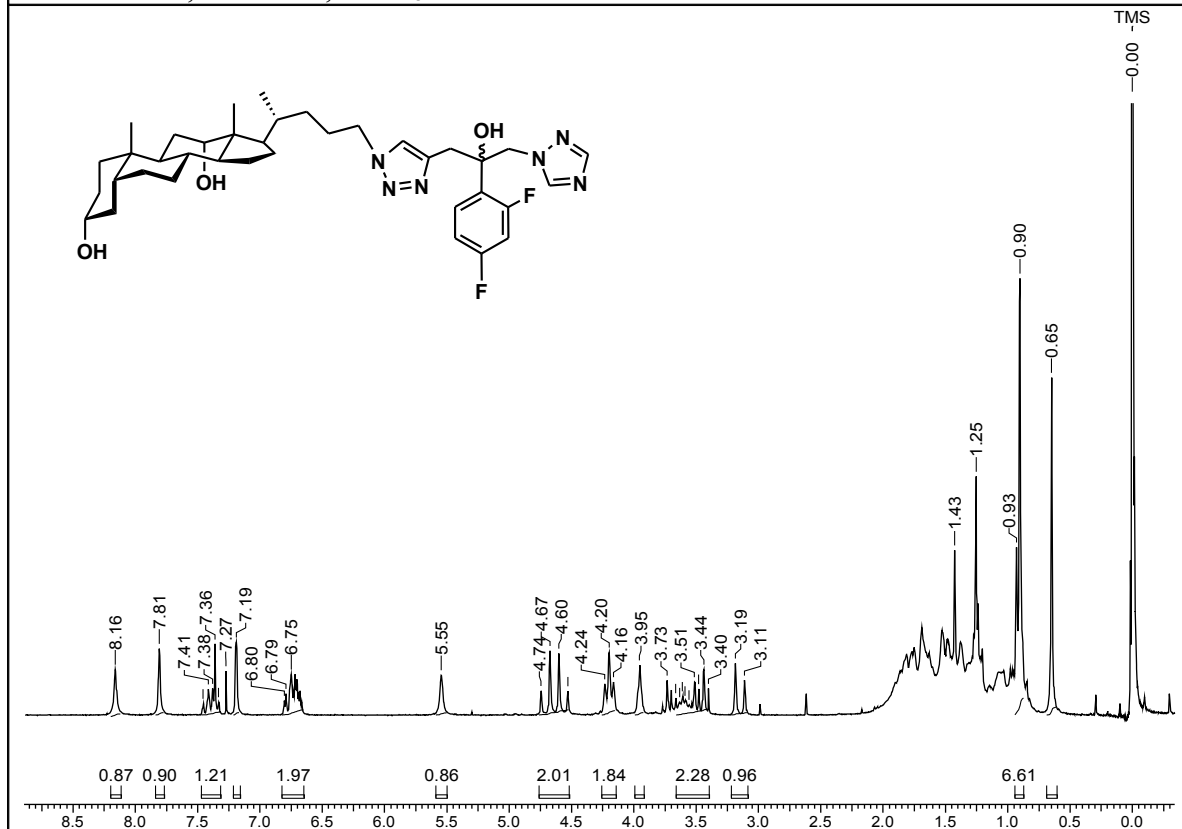
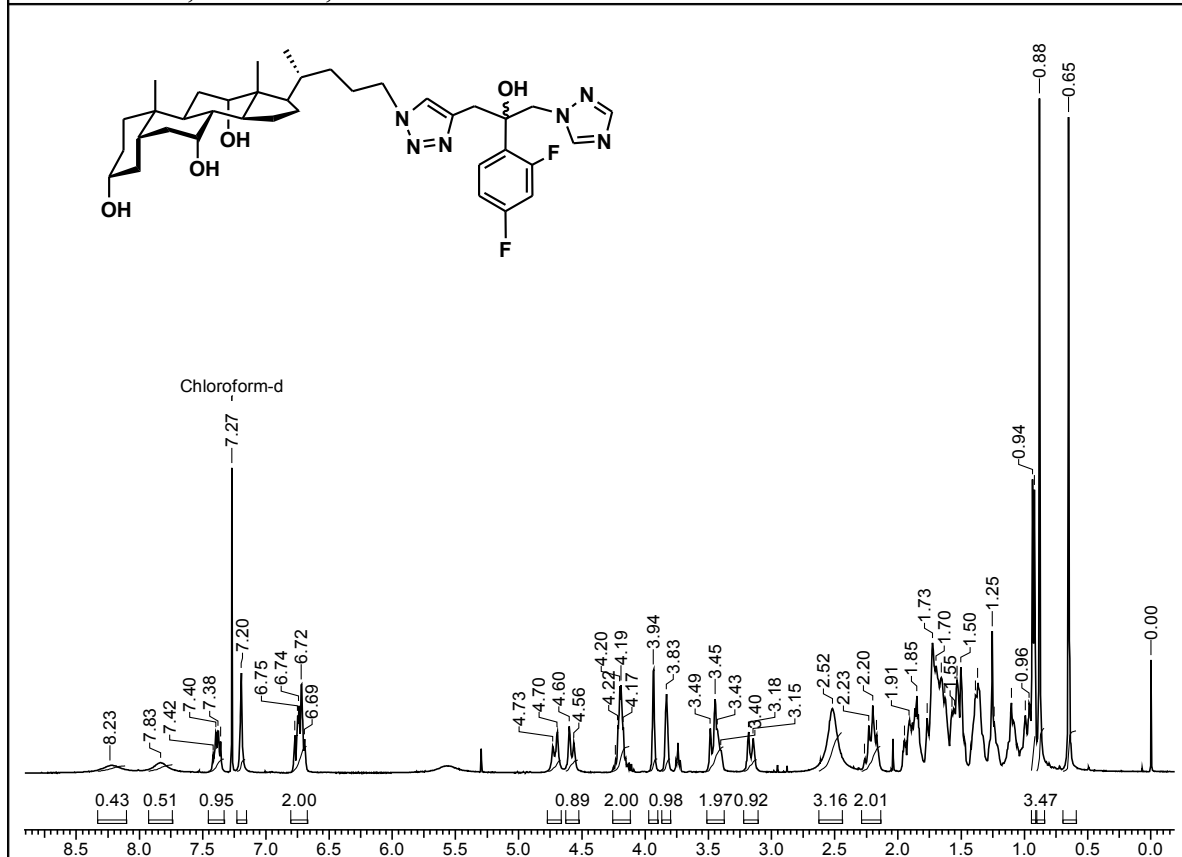
56: ^1H NMR, 200 MHz, CDCl_3 57: ^1H NMR, 400 MHz, CDCl_3 

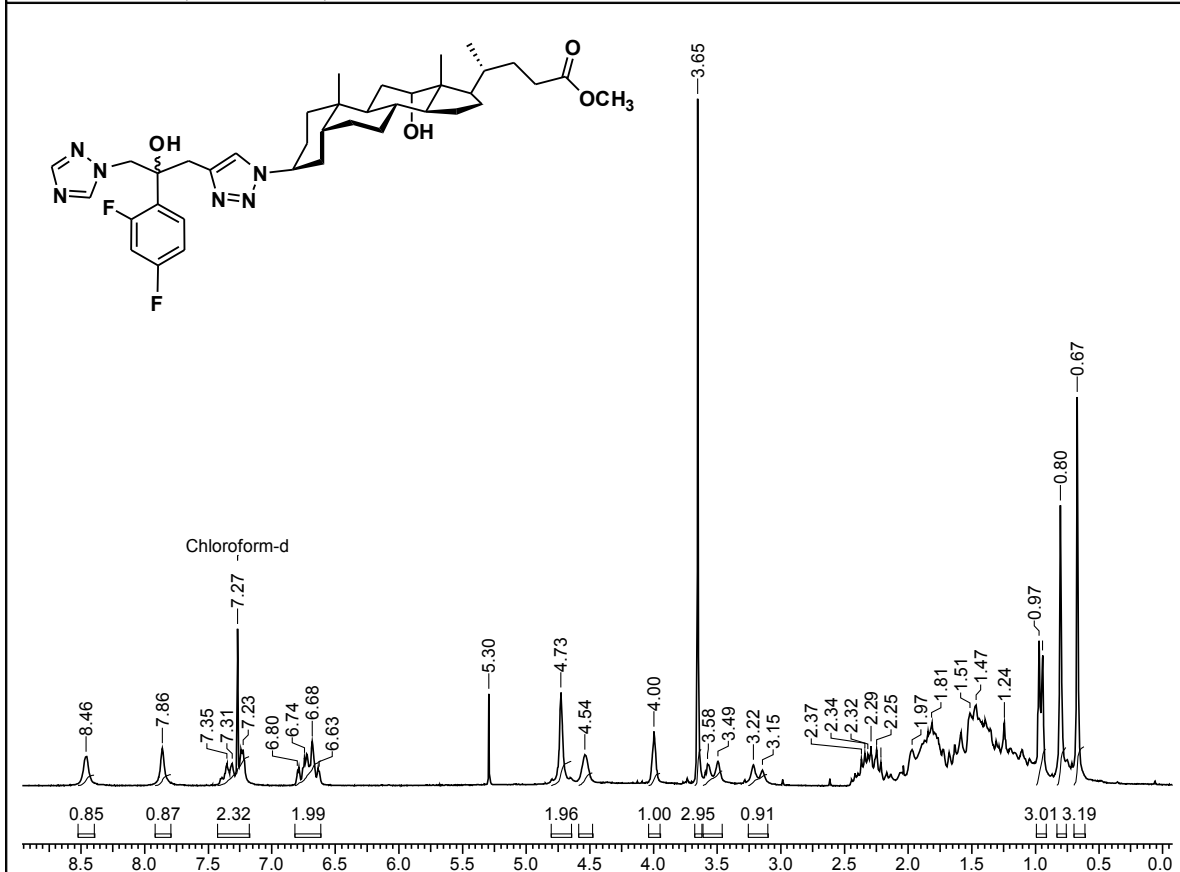
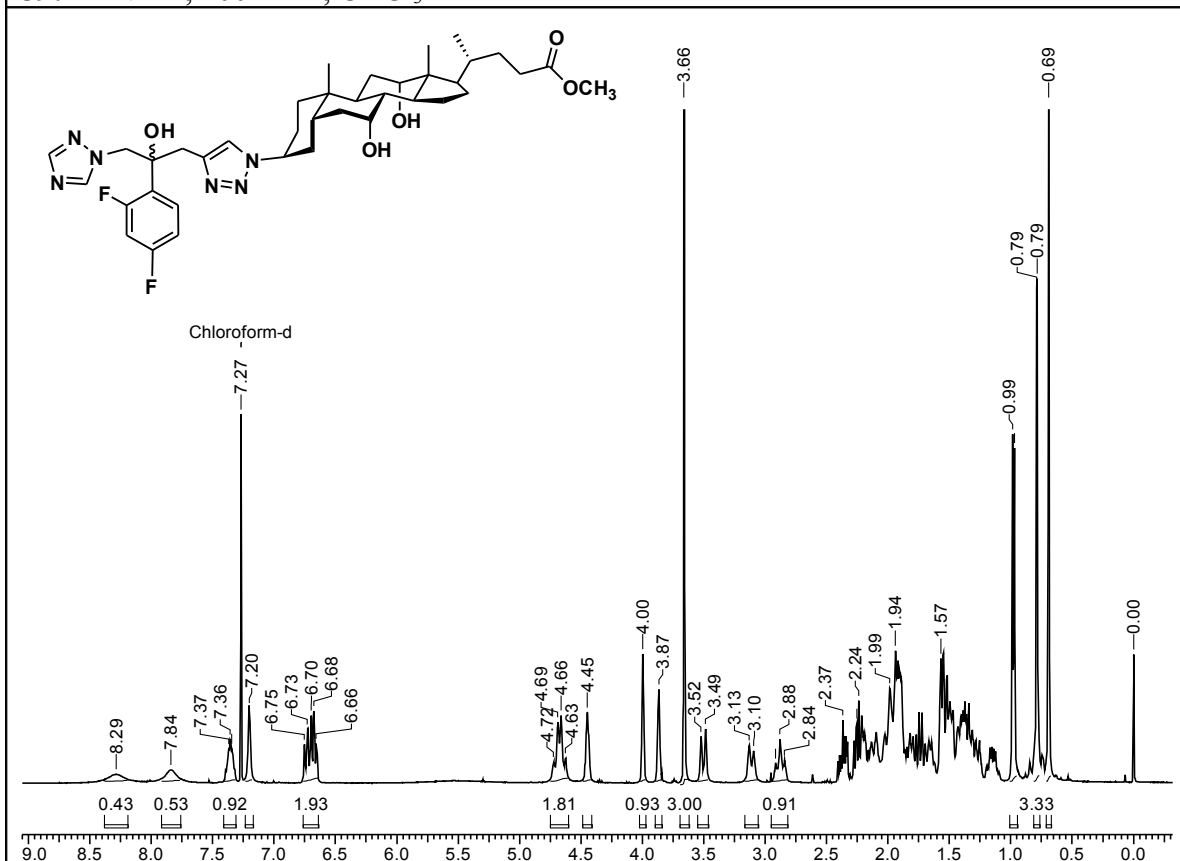
58: ^1H NMR, 400 MHz, CDCl_3 **59:** ^1H NMR, 400 MHz, CDCl_3 

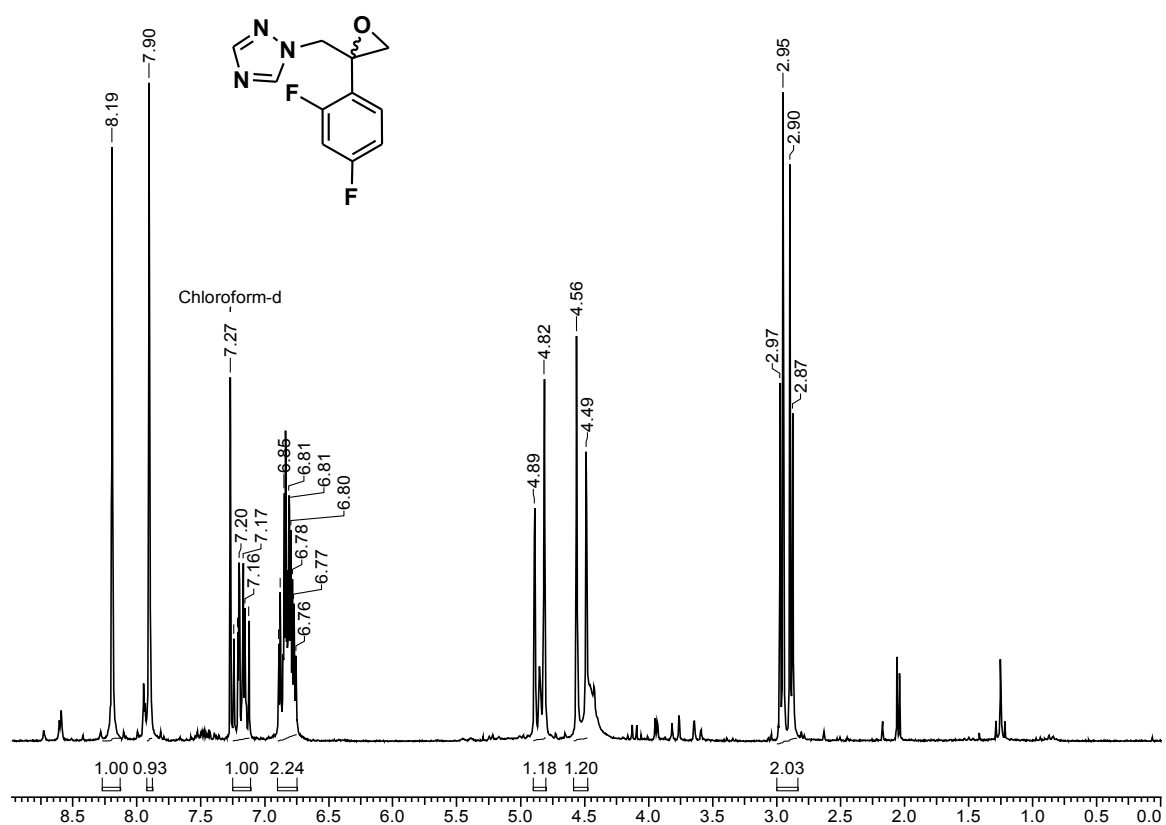
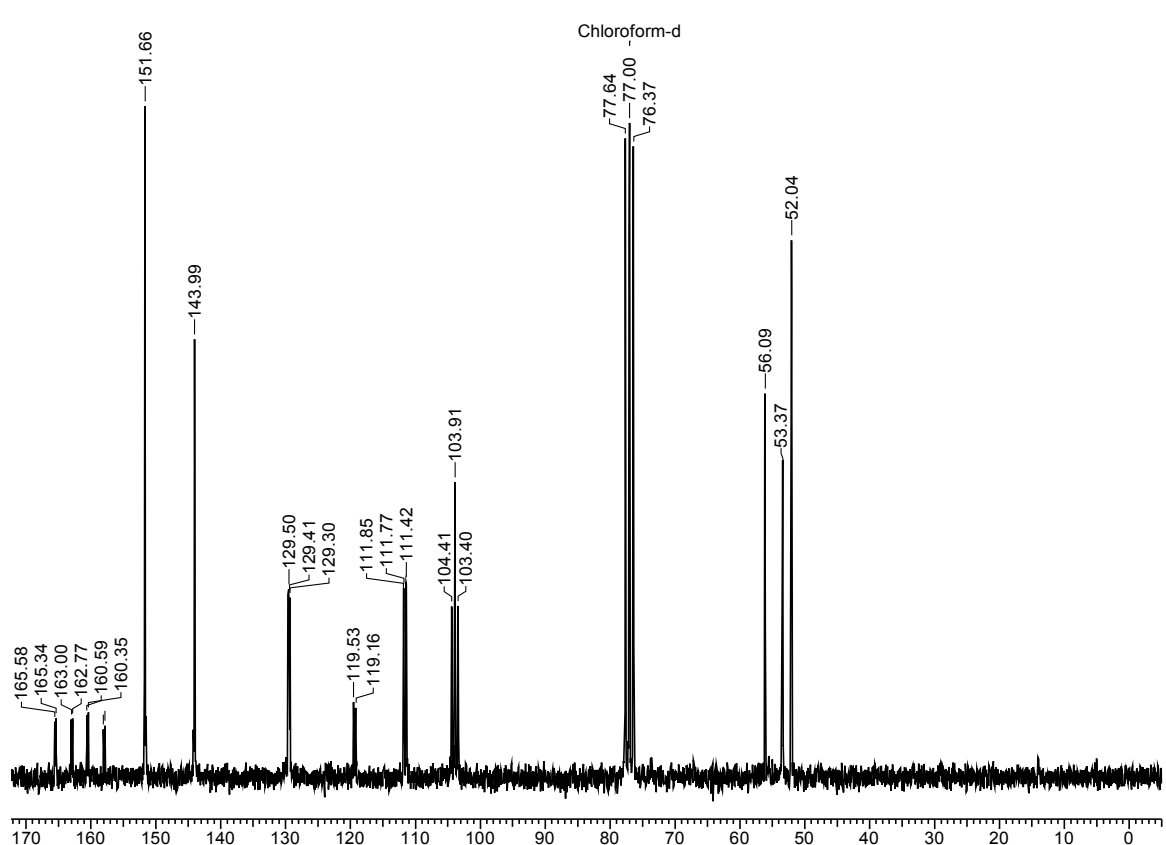
60: ^1H NMR, 200 MHz, CDCl_3 **60:** ^{13}C NMR, 50 MHz, CDCl_3 

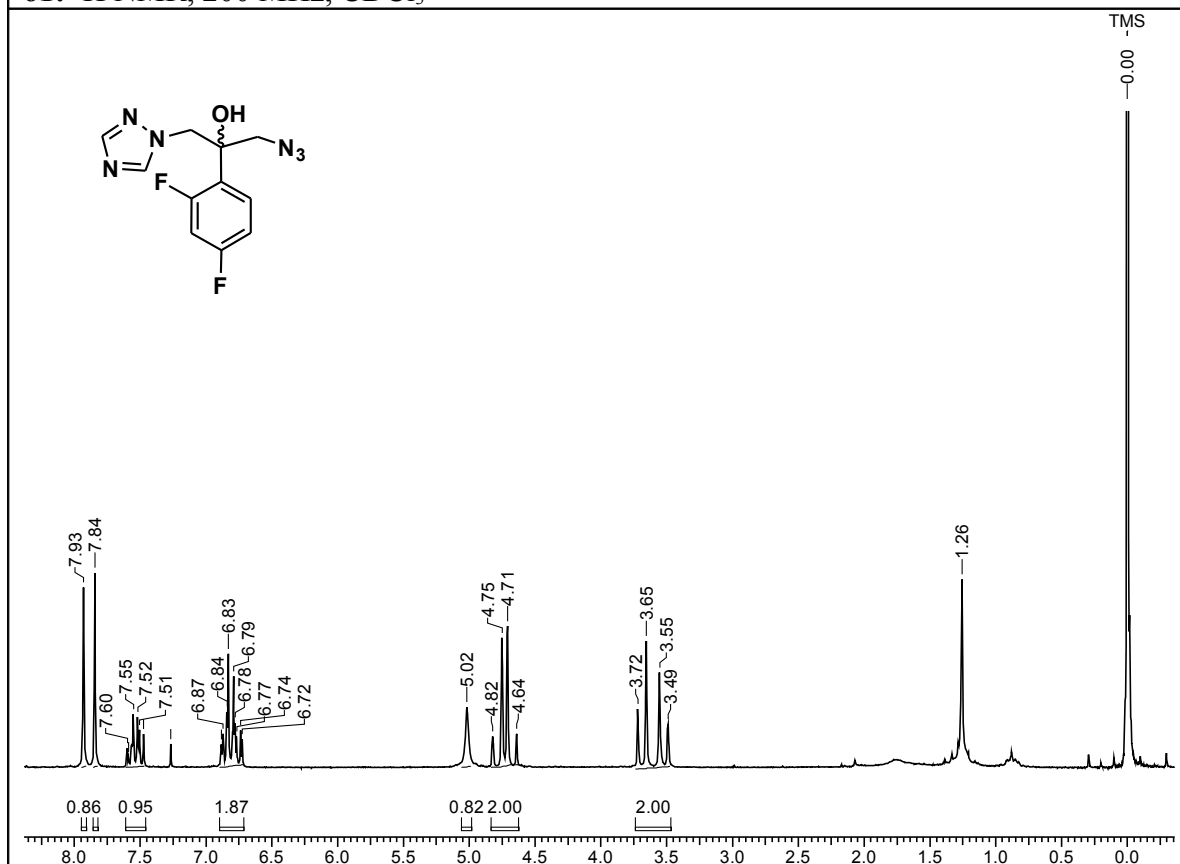
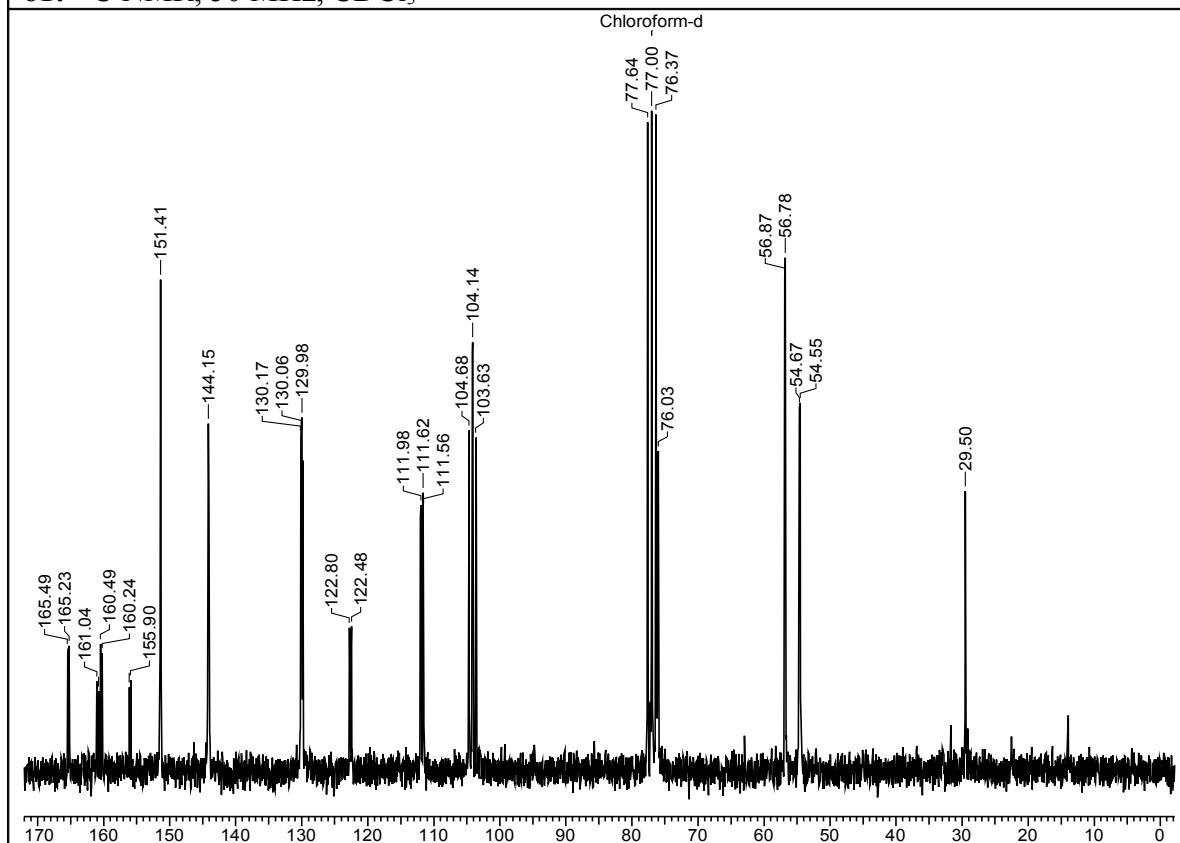
61: ^1H NMR, 200 MHz, CDCl_3 **61:** ^{13}C NMR, 50 MHz, CDCl_3 

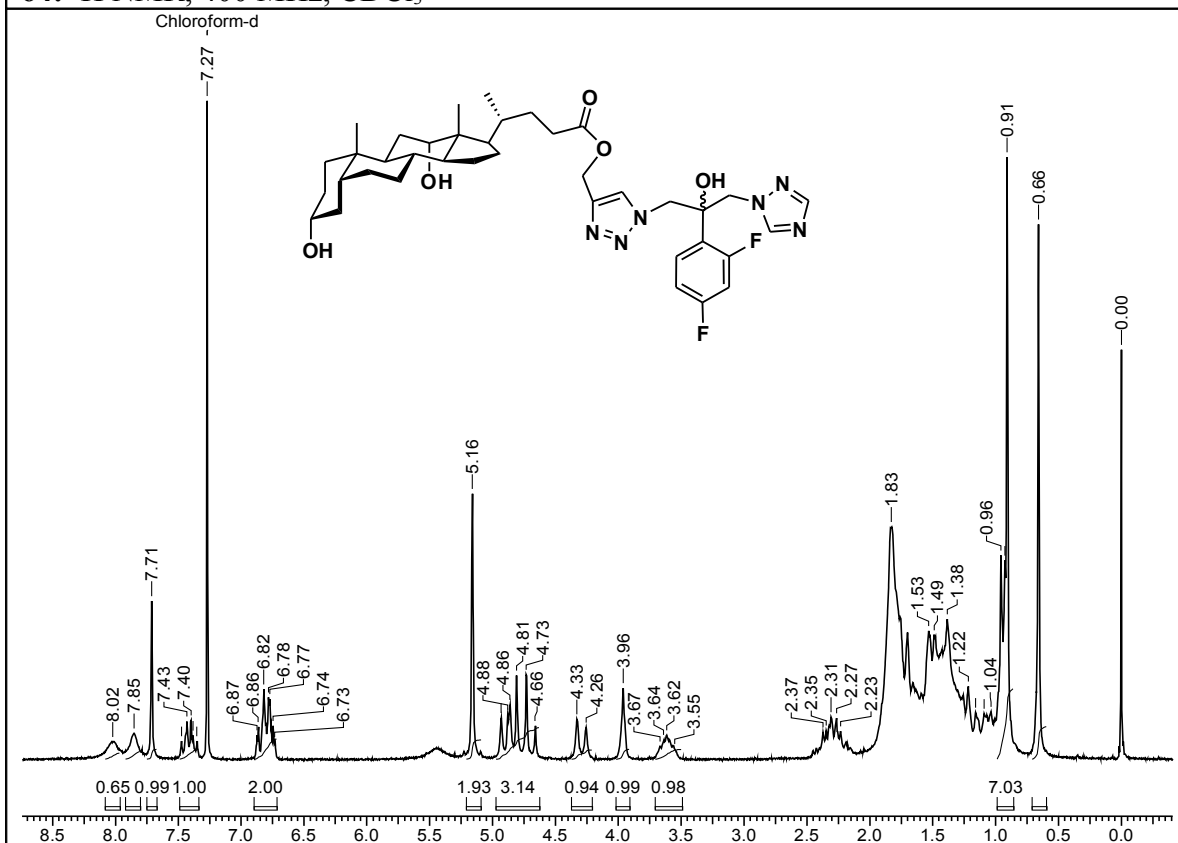
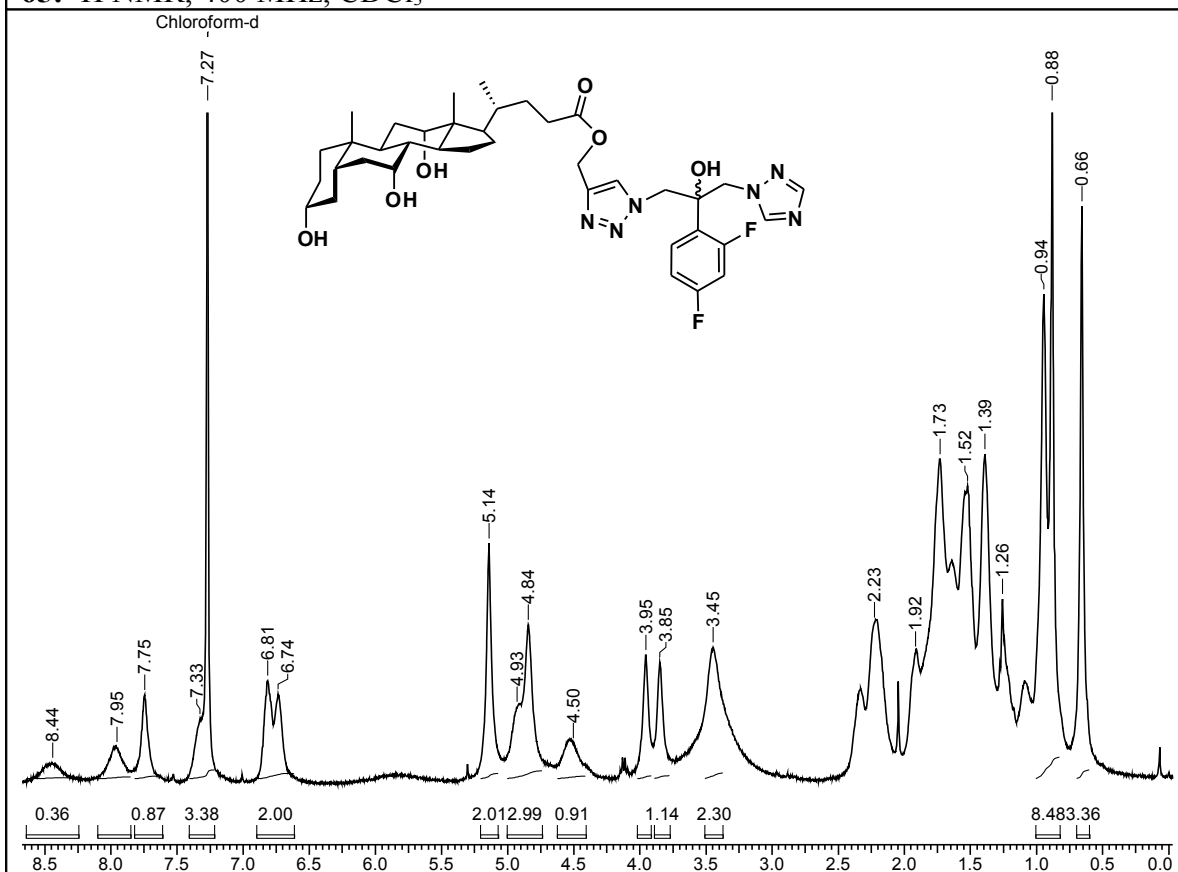
64: ^1H NMR, 400 MHz, CDCl_3 **65:** ^1H NMR, 400 MHz, CDCl_3 

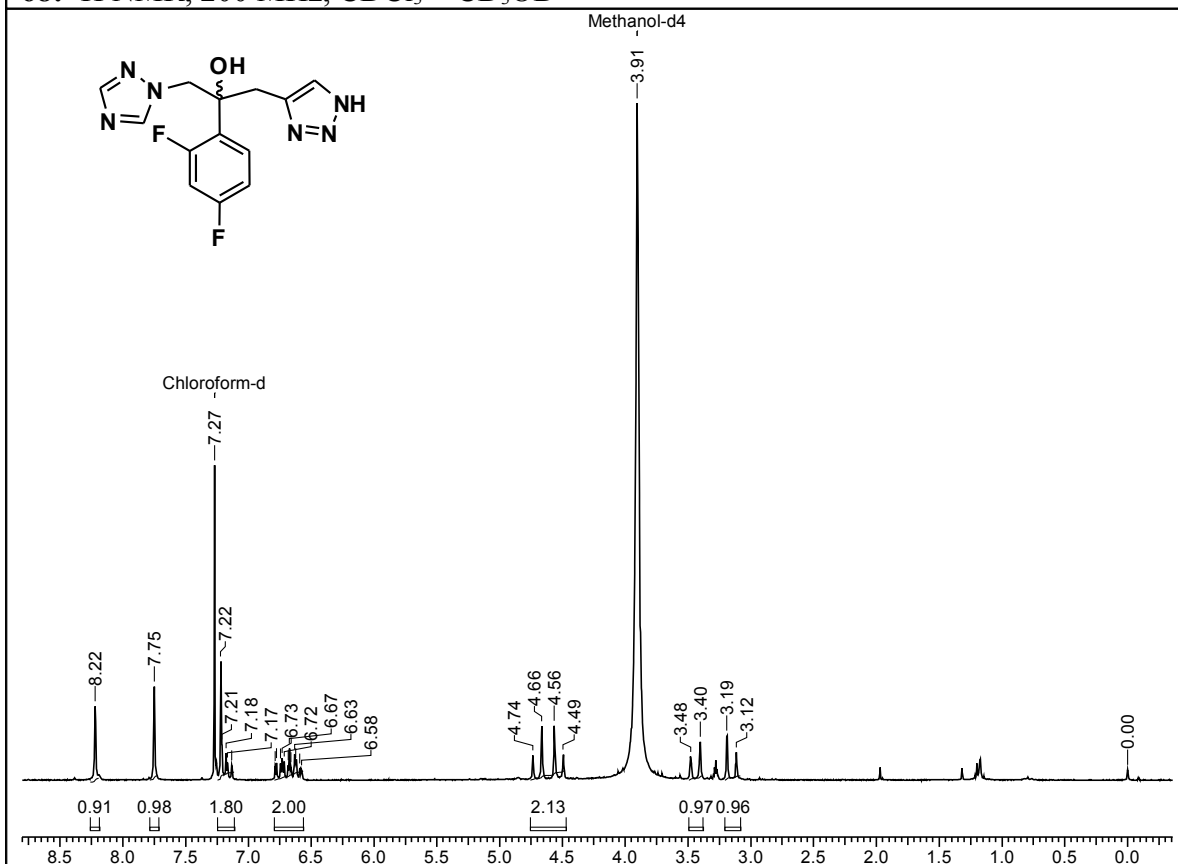
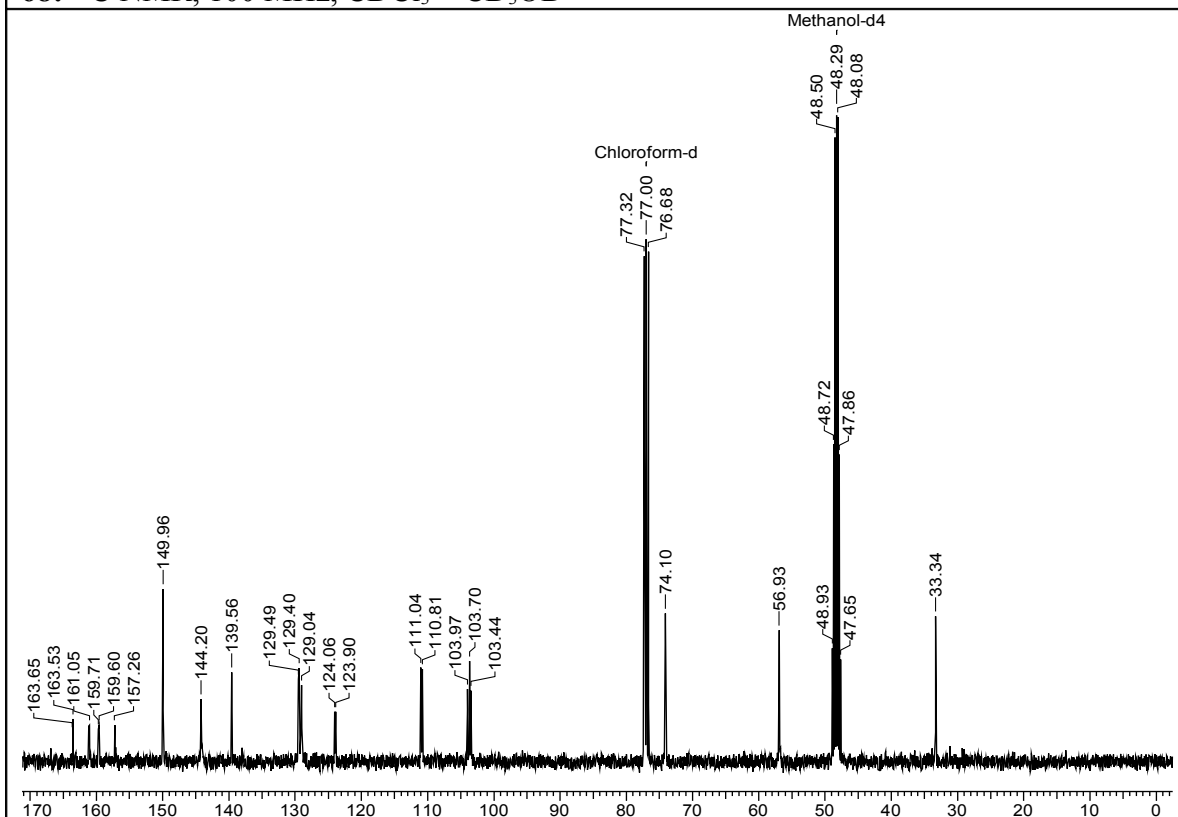
68: ^1H NMR, 200 MHz, $\text{CDCl}_3 + \text{CD}_3\text{OD}$ **68:** ^{13}C NMR, 100 MHz, $\text{CDCl}_3 + \text{CD}_3\text{OD}$ 

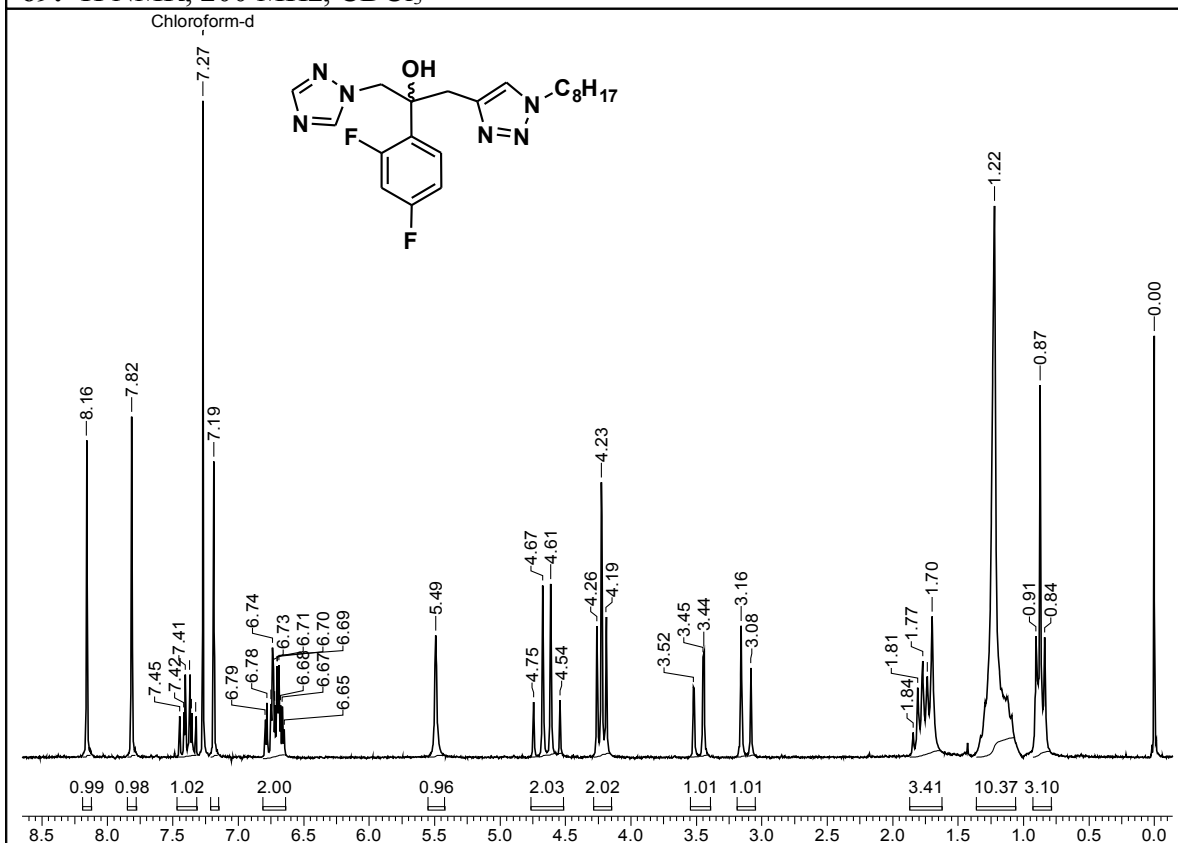
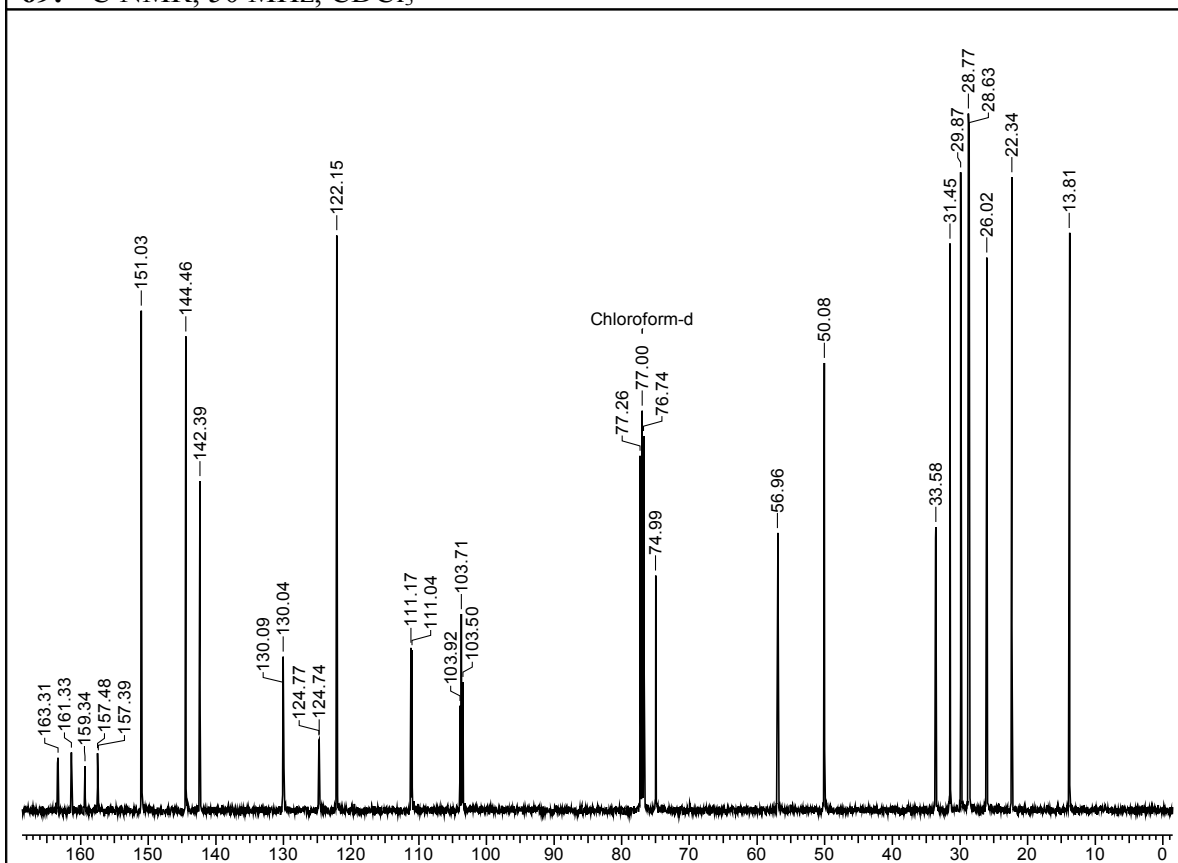
69: ^1H NMR, 200 MHz, CDCl_3 **69:** ^{13}C NMR, 50 MHz, CDCl_3 

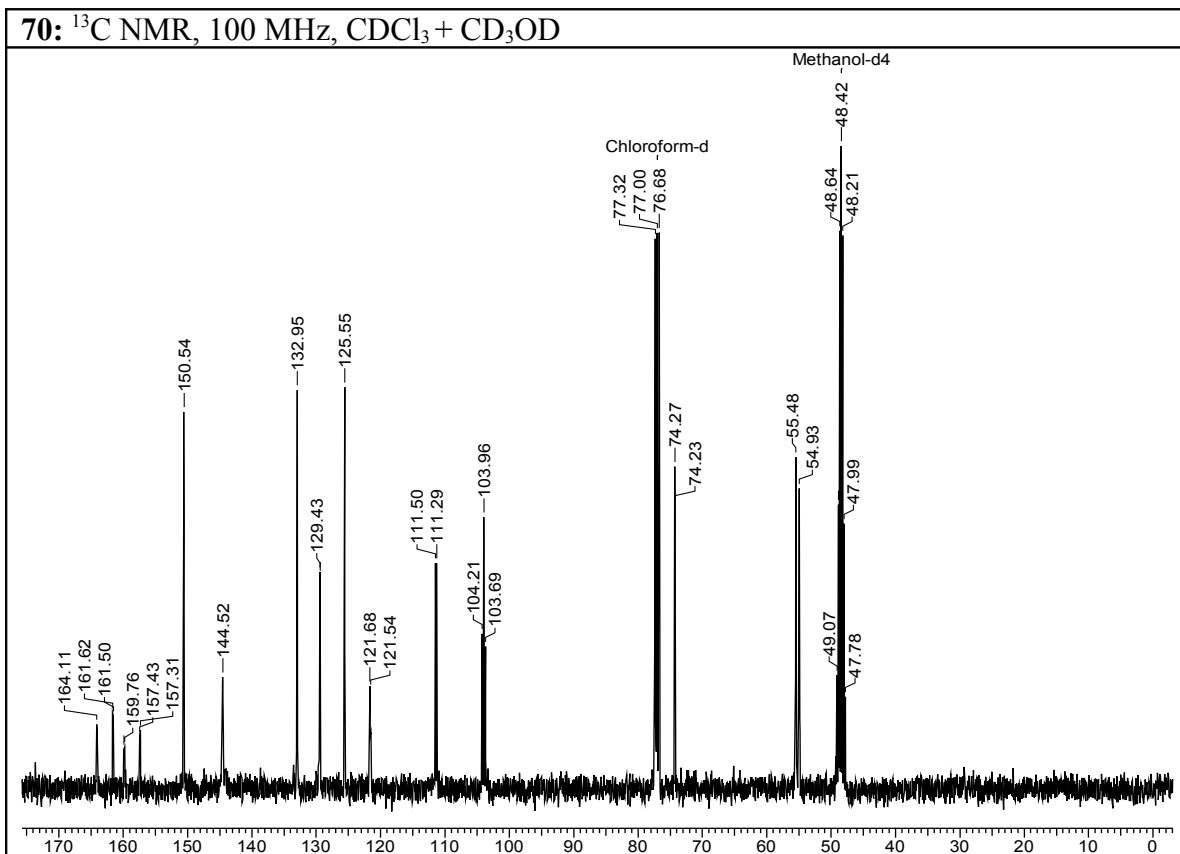
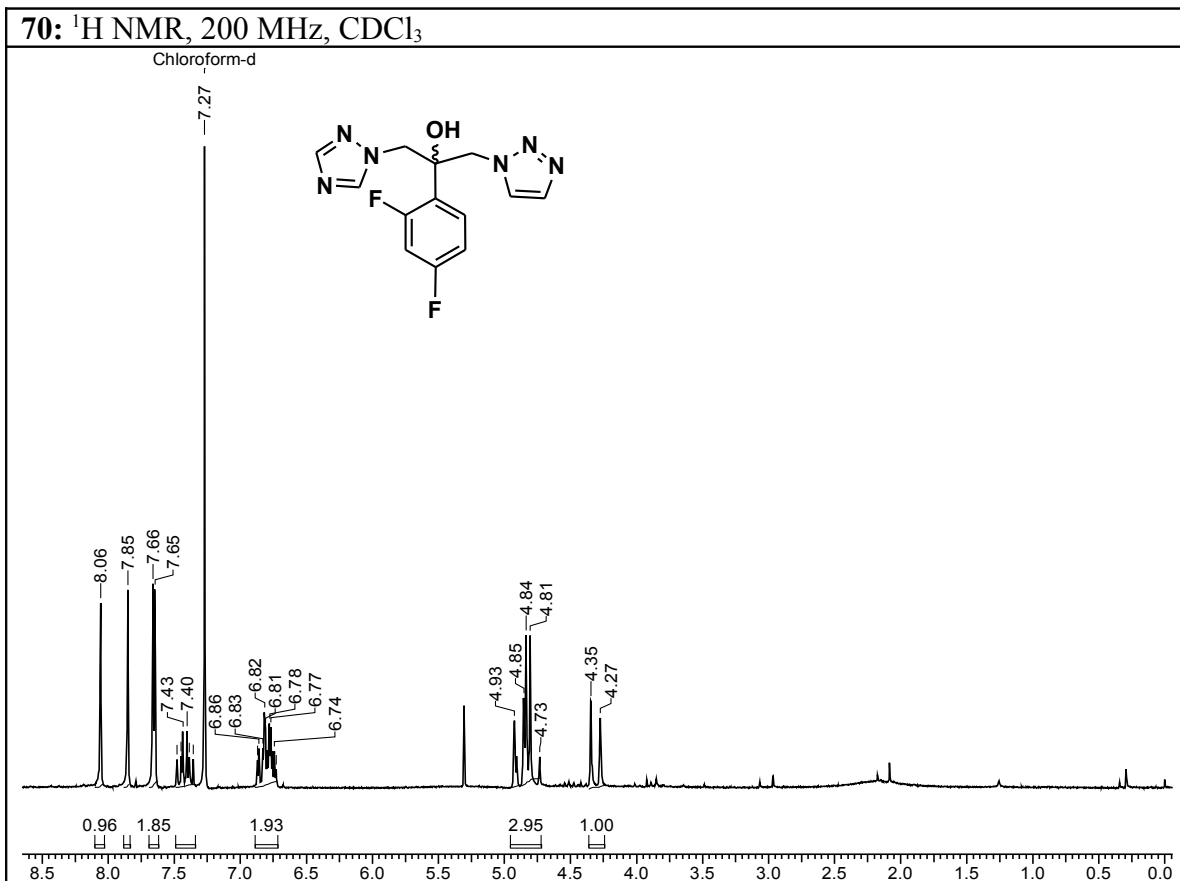

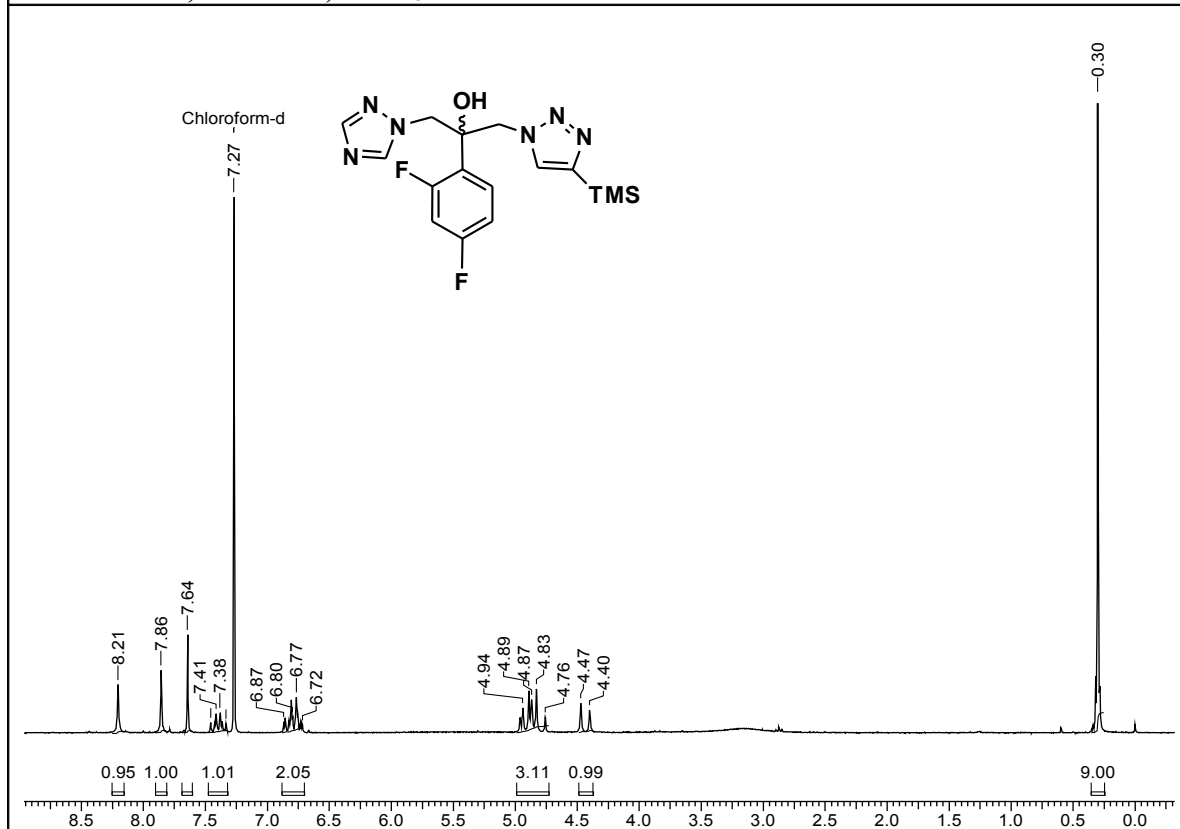
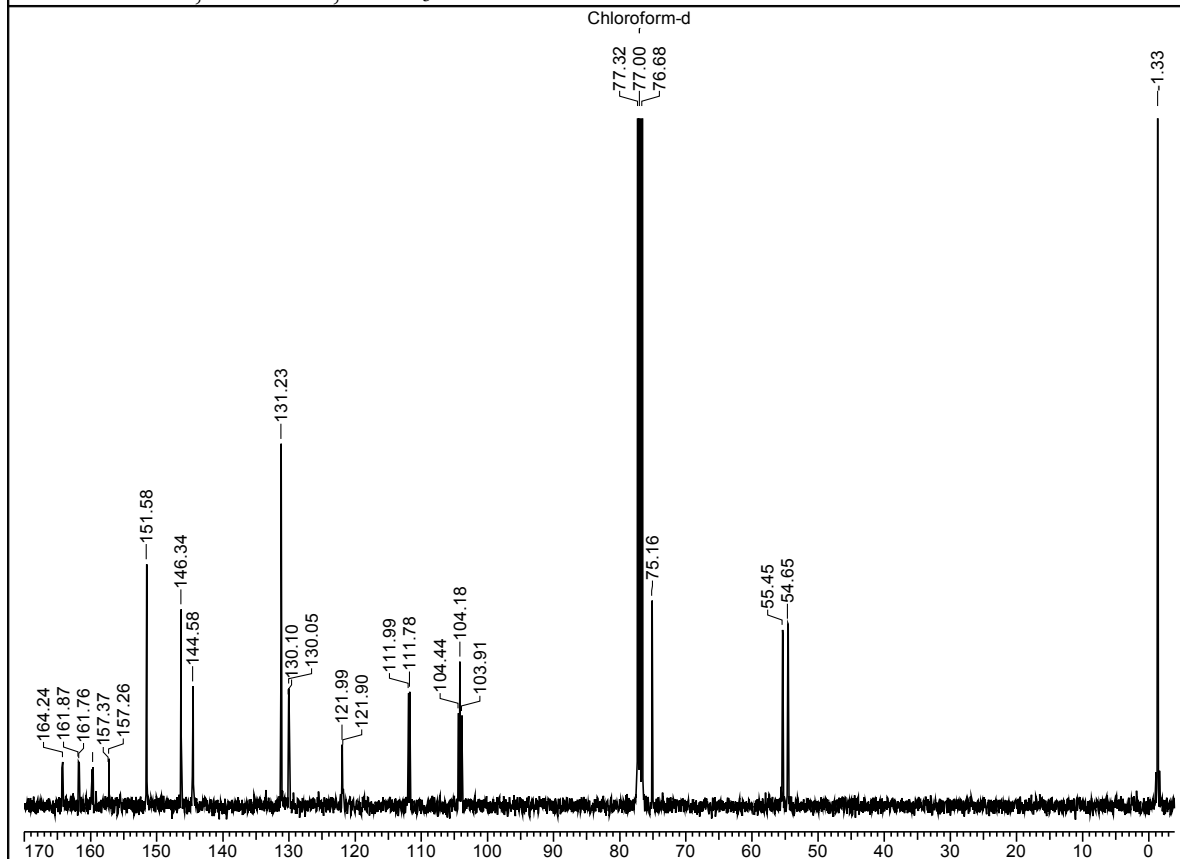
71: ^1H NMR, 200 MHz, CDCl_3 **71:** ^{13}C NMR, 100 MHz, CDCl_3 

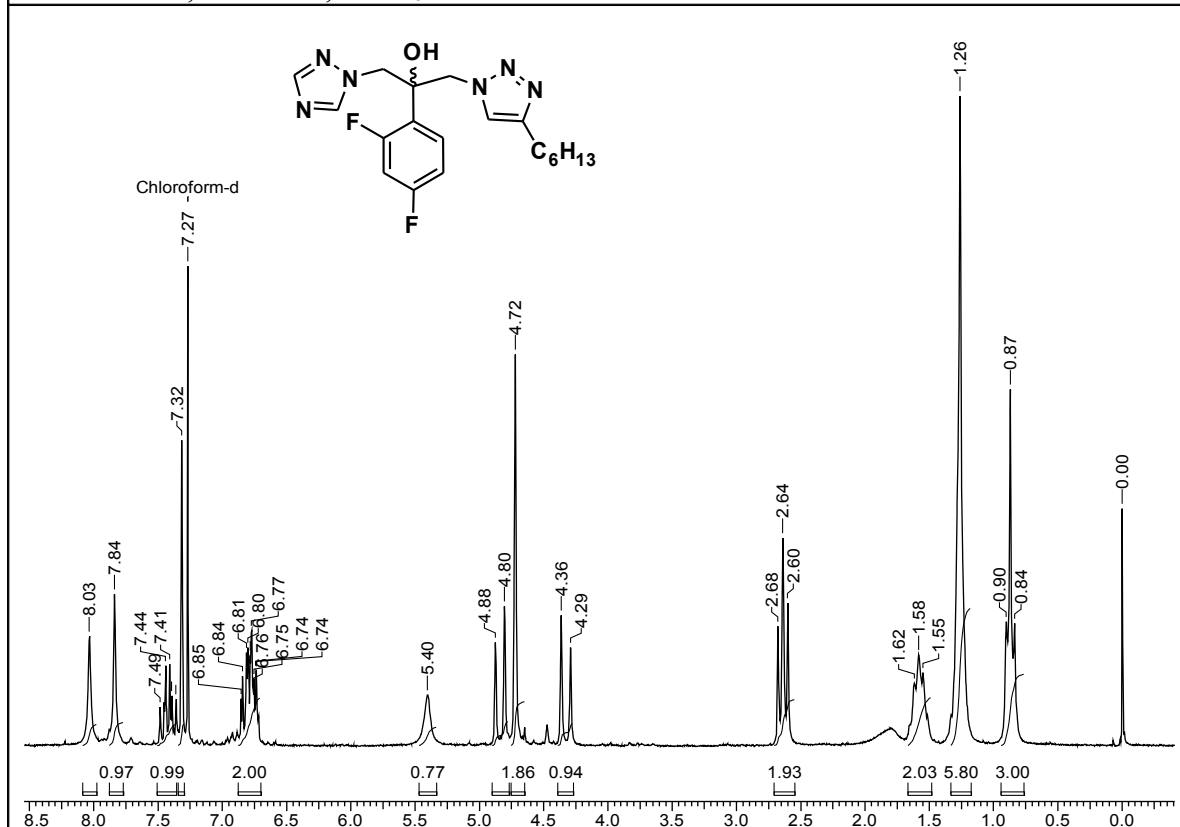
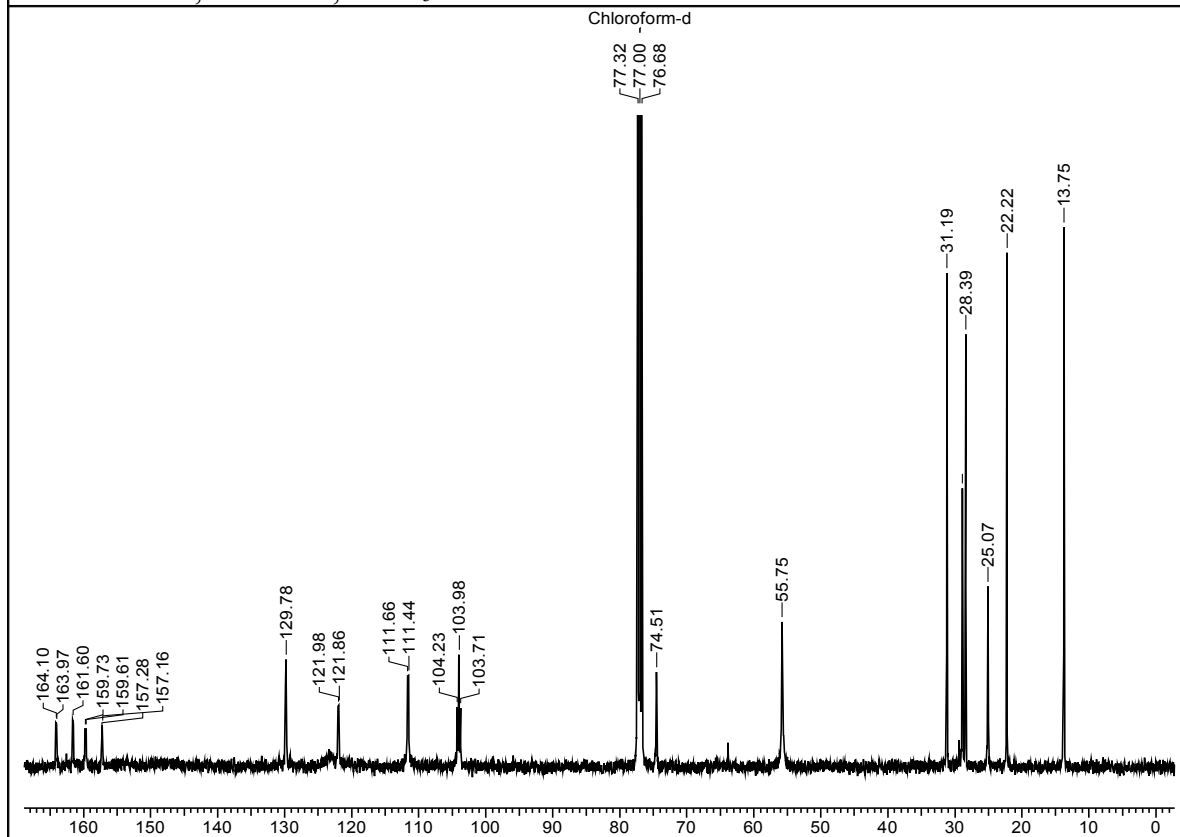
72: ^1H NMR, 200 MHz, CDCl_3 72: ^{13}C NMR, 100 MHz, CDCl_3 

2.1.8 Referances:

1. Hermanson, G. T. *Bioconjugate Techniques*, Academic Press, New York, USA, 1996.
2. *Bioconjugation Protocols: Strategies and Methods*, ed. Niemeyer, C. M.; Humana Press, New Jersey, USA, 2004.
3. *Perspectives in Bioconjugate Chemistry*, ed. Mears, C. F. American Chemical Society, Washington DC, 1993.
4. (a) Juliano, R. L. *Curr. Opin. Mol. Ther.*, **2005**, *7*, 132-136; (b) Gait, M. J. *Cell. Mol. Life Sci.*, **2003**, *60*, 844-853.
5. (a) Hossany, R. B.; Johnson, M. A.; Eniade, A. A.; Pinto, B. M. *Bioorg. Med. Chem.*, **2004**, *12*, 3743-3754; (b) Opatz, T.; Kallus, C.; Wunberg, T.; Kunz, H. *Tetrahedron*, **2004**, *60*, 8613-8626.
6. (a) Zatsepin T. S.; Oretskaya, T. S. *Chem. Biodiversity*, **2004**, *1*, 1401-1417; (b) Adinolfi, M.; Napoli, L. D.; Fabio, G. D.; Iadonisi, A.; Montesarchio, D. *Org. Biomol. Chem.*, **2004**, *2*, 1879-1886.
7. (a) Cao, Y.; Lam, L. *Adv. Drug Delivery Rev.*, **2003**, *55*, 171-197; (b) Greenwald, R. B.; Choe, Y. H.; McGuire, J.; Conover, C. D. *Adv. Drug Delivery Rev.*, **2003**, *55*, 217-250; (c) Lu, Z. -R.; Shiah, J. -G.; Sakuma, S.; Kopeckova P.; J. Kopecek, J. *Controlled Release*, **2002**, *78*, 165-173.
8. (a) Webb, R. R.; Kaneko, T. *Bioconjugate Chem.*, **1990**, *1*, 96-99; (b) Bieniarz, C.; Hussain, M.; Barnes, G.; King, C. A.; Welch, C. J.; *Bioconjugate Chem.*, **1996**, *7*, 88-95; (c) Jones, D. S.; Cockerill, K. A.; Gamino, C. A.; Hammaker, J. R.; Hayag, M. S.; Iverson, G. M.; Linnik, M. D.; McNeeley, P. A.; Tedder, M. E.; Ton-Nu, H. T.; Victoria, E. J. *Bioconjugate Chem.*, **2001**, *12*, 1012-1020; (d) Toyokuni, T.; Walsh, J. C.; Dominguez, A.; Phelps, M. E.; Barrio, J. R.; Gambhir, S. S.; Satyamurthy, N. *Bioconjugate Chem.*, **2003**, *14*, 1253-1259.; (e) Reddy, R. E.; Chen, Y.-Y.; Johnson, D. D.; Beligere, G. S.; Rege, S. D.; Pan, Y.; Thottathil, J. K. *Bioconjugate Chem.*, **2005**, *16*, 1323-1328.; (f) Kubler-Kielb, J.; Pozsgay, V. *J. Org. Chem.*, **2005**, *70*, 6987-6990.
9. (a) Enhsen, A; Kramer, W.; Wess, G. *Drug Discovery Today* **1998**, *3*, 409-418.; (b) Virtanen, E.; Kolehmainen, E. *Eur. J. Org. Chem.* **2004**, 3385-3399.; (c) Salunke, D. B.; Hazra, B. G.; Pore, V. S. *Curr. Med. Chem.* **2006**, *13*, 813-847.; (d) Sievänen, E. *Molecules* **2007**, *12*, 1859-1889.
10. (a) Kramer, W.; Wess, G. *Eur. J. Clin. Invest.* **1996**, *26*, 715-732. (b) Lehmann, T.; Engels, J. *Bioorg. Med. Chem.* **2001**, *9*, 1827-1835.

11. (a) Starke, D.; Lischka, K.; Pegels, P.; Uhlmann, E.; Kramer, W.; Wess, G.; Petzinger, E. *Bioorg. Med. Chem. Lett.* **2001**, *11*, 945-949. (b) Manoharan, M.; Jahns, L. K.; Bennett, C. F.; Vickers, T. A.; Ecker, D. J.; Cowser, L. M.; Freier, S. M.; Cook, P. D. *Bioorg. Med. Chem. Lett.* **1994**, *4*, 1053-1060.
12. Kannan, A.; De Clercq, E.; Pannecouque, C.; Witvrouw, M.; Hartman, T. L.; Turpin, J. M.; Buckheit, R. W. Jr.; Cushman, M. *Tetrahedron* **2001**, *57*, 9385-9391.
13. (a) Ulmann, A.; Tuetsch, G.; Philibert, D. *Scientific American* **1990**, *262*, 18-24. (b) Baulieu, E. -E. *Science* **1989**, *245*, 1351-1357.
14. Hazra, B. G.; Pore, V. S. *J. Indian Inst. Sci.* **2001**, *81*, 287-298.
15. Hazra, B. G.; Basu, S.; Pore, V. S.; Joshi, P. L.; Pal, D.; Chakrabarti, P. *Steroids* **2000**, *65*, 157-162.
16. Geldern, T. W.; Tu, N.; Kym, P. R.; Link, J. T.; Jae, H. -S.; Lai, C.; Apelqvist, T.; Rhonnstad, P.; Hagberg, L.; Koehler, K.; Grynfarb, M.; Goos-Nilsson, A.; Sandberg, J.; Österlund, M.; Barkhem, T.; Höglund, M.; Wang, J.; Fung, S.; Wilcox, D.; Nguyen, P.; Jakob, C.; Hutchins, C.; Färnegårdh, M.; Kauppi, B.; Öhman, L.; Jacobson, P. B. *J. Med. Chem.* **2004**, *47*, 4213-4230.
17. Anelli, P. L.; Lattuada, L.; Lorusso, V.; Lux, G.; Morisetti, A.; Morosini, P.; Serletti, M.; Uggeri, F. *J. Med. Chem.* **2004**, *47*, 3629-3641.
18. (a) Opsenica, D.; Pocsfalvi, G.; Juranic, Z.; Tinant, B.; Declercq J. -P.; Kyle, D. E.; Milhous, W. K.; Saloja, B. A. *J. Med. Chem.* **2000**, *43*, 3274-3282. (b) Saloja, B. A.; Terzic, N.; Pocsfalvi, G.; Gerena, L.; Tinant, B.; Declercq J. -P.; Milhous, W. K.; *J. Med. Chem.* **2002**, *45*, 3331-3336.
19. (a) Bhatia, D.; Yue-Ming, L.; Ganesh, K. N. *Bioorg. Med. Chem. Lett.* **1999**, *9*, 1789-1794.; (b) Cheng, K.; Khurana, S.; Chen, Y.; Kennedy, R. H.; Zimniak, P.; Raufman, J.-P. *The J. Pharmacol. Exp. Ther.* **2002**, *303*, 29-35.; (c) Bhat, L.; Jandeleit, B.; Dias, T. M.; Moors, T. L.; Gallop, M. A. *Bioorg. Med. Chem. Lett.* **2005**, *15*, 85-87.; (d) Scozzafava, A.; Supuran, C. T. *Bioorg. Med. Chem. Lett.* **2002**, *12*, 1551-1557; (e) Bulbul, M.; Saracoglu, N.; Kufrevioglu, O. I.; Ciftci, M. *Bioorg. Med. Chem.* **2002**, *10*, 2561-2567.
20. Hazra, B. G.; Pore, V. S.; Dey, S. K.; Datta, S.; Darokar, M. P.; Saikia, D.; Khanuja, S. P. S.; Thakur, A. P. *Bioorg. Med. Chem. Lett.* **2004**, *14*, 773-777.
21. (a) Salunke, D. B.; Hazra, B. G.; Pore, V. S.; Bhat, M. K.; Nahar, P. B.; Deshpande, M. V. *J. Med. Chem.* **2004**, *47*, 1591-1594.; (b) Bavikar, S. N.; Salunke, D. B.; Hazra,

- B. G.; Pore, V. S.; Dodd, R. H.; Thierry, J.; Shirazi, F.; Deshpande, M. V.; Kadreppa, S.; Chattopadhyay, S. *Bioorg. Med. Chem. Lett.* **2008**, *18*, 5512-5517.
22. (a) Vatmurge, N. S.; Hazra, B. G.; Pore, V. S.; Shirazi, F.; Chavan, P. S.; Deshpande, M. V. *Bioorg. Med. Chem. Lett.* **2007**, *18*, 2043-2047. ;(b) Vatmurge, N. S.; Hazra, B. G.; Pore, V. S.; Shirazi, F.; Deshpande, M. V.; Kadreppa, S.; Chattopadhyay, S.; Gonnade, R. G. *Org. Biomol. Chem.*, **2008**, *6*, 3823-3830.
23. Hawksworth, D. L. *Studies in Mycology*, **2004**, *50*, 9-17.
24. (a) Richardson, M. D. *J. Antimicrob. Chemother.* **1991**, *28* (Suppl. A), 1-11.; (b) Hoepelmn, I. M. *Inter. J. Antimicrob. Agents*, **1996**, *6*, 129-130.; (c) Ablordeppey, S. Y.; Fan, P.; Ablordeppey J. H.; Mardenborough, L. *Curr. Med. Chem.* **1999**, *6*, 1151-1196.; (d) Fridkin, S. K.; Jarvis, W. R. *Clin. Microbiol. Rev.* **1996**, *9*, 499-511.; (e) Larocco, M. T.; Burgert, S. J. *Clin. Microbiol. Rev.* **1997**, *10*, 277-297.; (f) Patel, R.; Paya, C. V. *Clin. Microbiol. Rev.* **1997**, *10*, 86-124.
25. (a) Latge, J. P. *Clin. Microbiol. Rev.* **1999**, *12*, 310-350; (b) Steenbergen, J. N.; Casabevall, A. *J. Clin. Microbiol.* **2000**, *38*, 1974-1976.
26. (a) Turner, W. W.; Rodriguez, M. *J. Curr. Pharm. Des.*, **1996**, *2*, 209-224. (b) Fostel, J. M.; Lartey, P. A. *Drug Discov. Today*, **2000**, *5*, 25-32. (c) Hossain, M. A.; Ghannom, M, A. *Exp. Opin. Invest. Drugs*, **2000**, *9*, 1797-1813.
27. Meunier, F. *Inter. J. Antimicrob. Agents*, **1996**, *6*, 135-140.
28. (a) Watkins, W. J.; Renau, T. E. *Antifungal agents in Burger's Medicinal Chemistry and Drug Discovery*, 6th Edition, vol. 5, p 881.
29. (a) Gallis, H. A.; Drew, R. H.; Pickard, W. W. *Rev. Infect. Dis.* **1990**, *12*, 308-329; (b) Arikian, S.; Rex, J. H. *Curr. Opin. Invest. Drugs* **2001**, *2*, 488-495;
30. (a) Frost, D. J.; Brandt, K. D.; Cugier, D.; Goldman, R. *J. Antibiotics*, **1995**, *48*, 306.; (b) Ghannoum, M. A. *Dermatol. Ther.* **1997**, *3*, 104-111.; (c) Asai, K.; Tsuchimori, N.; Okonogi, K.; Perfect, J. R.; Gotoh, O.; Yoshida, Y. *Antimicrob. Agents Chemother.* **1999**, *43*, 1163-1169. (d) Sheehan, D. J.; Hitchcock, C. A.; Sibley, C. M. *Clin. Microbiol. Rev.* **1999**, *12*, 40-79.
31. Birnbaum, J. E. *J. Am. Acad. Dermatol.* **1990**, *23*, 782-785.
32. (a) Georgopapadakou, N. H.; Tkacz, J. S. *Trends in Microbiology*, **1995**, *3*, 98-104.; (b) Odds, F. C.; Brown, A. J. P.; Gow, N. A. R. *Trends in Microbiology* **2003**, *11*, 272-279.
33. Barrett, D. *Biochimica et Biophysica Acta*, **2002**, *1587*, 224-233.
34. Odds, F. C. *Inter. J. Antimicrob. Agents*, **1996**, *6*, 145-147.

35. (a) Kauffman, C. A.; Carver, P. L. *Drugs* **1997**, *53*, 539-549; (b) Karyotakis, N. C.; Anaissie, E. J.; *Curr. Opin. Inf. Dis.* **1994**, *7*, 658-666; (c) Zervos, M.; Meunier, F. *Int. J. Antimicrob. Agents* **1993**, *3*, 147-170.
36. Rex, J. H.; Rinaldi, M. G.; Pfaller, M. A. *Antimicrob. Agents Chemother.* **1995**, *39*, 40-44.
37. (a) Dickinson, R. P.; Bell, A. S.; Hitchcock C. A.; Narayanaswami, S.; Ray, S. J.; Richardson, K.; Troke, P. F. *Bioorg. Med. Chem. Lett.* **1996**, *6*, 2031-2036.; (b) Chandrasekar, P. H.; Manavathu, E. *Drugs Today (Barc.)* **2001**, *37*, 135-148; (c) Herbrecht, R. *Int. J. Clin. Pract.* **2004**, *58*, 612-624; (d) Arikan, S.; Rex, J. H. *Curr. Opin. Invest. Drugs* **2002**, *3*, 555-561; (e) Bartroli, J.; Turmo, E.; Alguero, M.; Boncompte, E.; Vericat, M. L.; Conte, L.; Ramis, J.; Merlos, M.; Garcia-Rafanell, J.; Forn, J. *J. Med. Chem.* **1998**, *41*, 1869-1882.
38. Hitchcock, C. A.; Dickinson, K.; Brown, S. B.; Evans, E. G. V.; Adams, D. J. *Biochem. Journal.* **1990**, *266*, 475-480.
39. (a) Michael, S. M.; Kenneth, R. in: Recent Trends in the Discovery, Development and Evaluation of Antifungal Agents, R.A. Fromtling, Ed.; J.R. Prous Science Publishers, S.A, **1987**, pp. 81-92. (b) Aperis, G.; Mylonakis, E. *Expert Opin. Investig. Drugs*, **2006**, *15*, 579-602; (c) Chen, A.; Sobel, J. D. *Expert Opin. Emerg. Drugs*, **2005**, *10*, 21-35.
40. Lebouvier, N.; Pagniez, F.; Duflos, M.; Le Pape, P.; Na, Y. M.; Le Baut, G. Le Borgne, M. *Bioorg. Med. Chem. Lett.* **2007**, *17*, 3686-3689;
41. Nam, N. -H.; Sardari, S.; Selecky, M.; Parang, K. *Bioorg. Med. Chem.* **2004**, *12*, 6255-6269.; (b) Gao, P. -H.; Cao, Y. -B.; Xu, Z.; Zhang, J. -D.; Zhang, W. -N.; Wang, Y.; Gu, J.; Cao, Y. -Y.; Li, R.; Jia, X. -M.; Jiang, Y. -Y. *Biol. Pharm. Bull.* **2005**, *28*, 1414-1417 and references cited therein.
42. Heravi, M. M.; Motamedi, R. *Heterocyclic Communications*, **2005**, *11*, 19-22.
43. Upadhayaya, R. S.; Jain, S.; Sinha, N.; Kishore, N.; Chandra, R.; Arora, S. K. *Eur. J. Med. Chem.* **2004**, *39*, 579-592.
44. (a) Park, J. S.; Yu, K. A.; Kang, T. H.; Kim, S.; Suh, Y.-G. *Bioorg. Med. Chem. Lett.* **2007**, *17*, 3486-3490; (b) Sun, Q.-Y.; Xu, J.-M.; Cao, Y.-B.; Zhang, W.-N.; Wu, Q.-Y.; Zhang, D. -Z.; Zhang, J.; Zhao, H.-Q.; Jiang, Y.-Y. *Eur. J. Med. Chem.* **2007**, *42*, 1226-1233;
45. Stein, T. M.; Gellman, S. H. *J. Am. Chem. Soc.* **1992**, *114*, 3943-3950.
46. Savage, P. B. *Exp. Opin. Invest. Drugs.* **2000**, *9*, 263-271.

47. (a) Dalvie, D. K.; Kalgutkar, A. S.; Khojasteh-Bakht, S. C.; Obach, R. S.; O'Donnell, J. P. *Chem. Res. Toxicol.* **2002**, *15*, 269-299; (b) Horne, W. S.; Yadav, M. K.; Stout, C. D.; Ghadiri, M. R. *J. Am. Chem. Soc.* **2004**, *126*, 15366-15367.
48. (a) Genin, M. J.; Allwine, D. A.; Anderson, D. J.; Barbachyn, M. R.; Emmert, D. E.; Garmon, S. A.; Graber, D. R.; Grega, K. C.; Hester, J. B.; Hutchinson, D. K.; Morris, J.; Reischer, R. J.; Ford, C. W.; Zurenko, G. E.; Hamel, J. C.; Schaadt, R. D.; Stapert, D.; Yagi, B. H. *J. Med. Chem.* **2000**, *43*, 953-970; (b) Wamhoff, H. in *Comprehensive Heterocyclic Chemistry*; Katritzky, A. R., Rees, C. W., Eds.; Pergamon: Oxford, **1984**; pp 669-732; (c) Buckle, D. R.; Rockell, C. J. M.; Smith, H.; Spicer, B. A. *J. Med. Chem.* **1986**, *29*, 2262-2267; (d) Alvarez, R.; Velazquez, S.; San-Felix, A.; Aquaro, S.; De Clercq, E.; Perno, C. F.; Karlsson, A.; Balzarini, J.; Camarasa, M. J. *J. Med. Chem.* **1994**, *37*, 4185-4194.
49. (a) Rostovtsev, V. V.; Green, L. G.; Fokin, V. V.; Sharpless, K. B. *Angew. Chem., Int. Ed.* **2002**, *41*, 2596-2599; (b) Tornø'e, C. W.; Christensen, C.; Meldal, M. *J. Org. Chem.* **2002**, *67*, 3057-3064.
50. Cyr, T. D.; Dawson, B.A.; Neville, G. A.; Shurvell, H. F. *J. Pharm. Biomed. Anal.* **1996**, *14*, 247-255.
51. Konosu, T.; Tajima, Y.; Takeda, N.; Miyaoka, T.; Kasahara, M.; Yasuda, H.; Oida, S. *Chem. Pharma. Bull.* **1990**, *38*, 2476-2486.
52. (a) National Committee for Clinical Laboratory Standard, **1997**. Reference method for broth dilution antifungal susceptibility testing of yeast, approved standard. Document M27-A. National Committee for Clinical Laboratory Standards, Wayne, PA, USA.; (b) National Committee for Clinical Laboratory Standard, **1998**. Reference method for broth dilution antifungal susceptibility testing of conidium forming. filamentous fungi: proposed standard. Document M38-P. National Committee for Clinical Laboratory Standard, Wayne, PA, USA.; (c) National Committee for Clinical Laboratory Standards, **2000**. Methods for dilution antimicrobial susceptibility tests for bacteria that grow aerobically. Approved Standard. 5th ed. M7-A5. Villanova, PA: NCCLS; (d) Yamamoto N., Fujita J., Shinzato T., Higa F., Tateyamaa M., Tohyamaa M., Nakasone I., Yamane N. *Int. J. Antimicrob. Agents.* **2006**, *27*: 171-173.
53. The [3+2] cycloaddition of nonactivated terminal alkynes and trimethylsilyl azide proceeded smoothly in the presence of Cu(I) catalyst to give the corresponding *N*-unsubstituted triazole in good to high yield. Jin, T.; Kamijo, S.; Yamamoto, Y. *Eur. J. Org. Chem.* **2004**, 3789-3791.

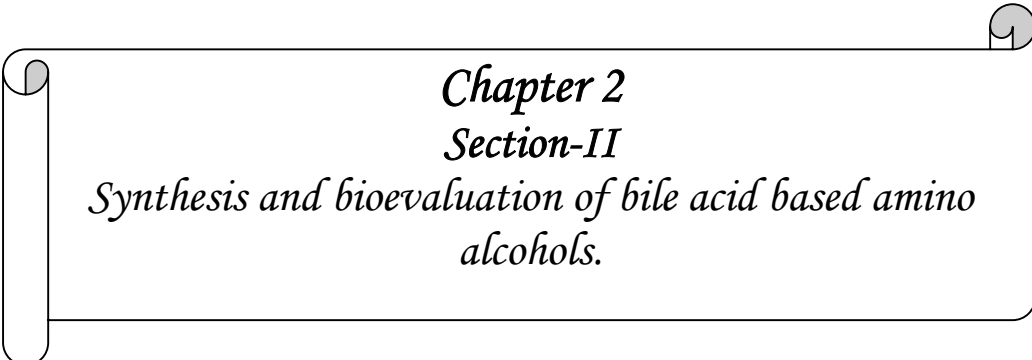

Chapter 2
Section-II
*Synthesis and bioevaluation of bile acid based amino
alcohols.*

2.2.1 Abstract

New bile acid-methylamine and bile acid-ethylenediamine conjugates were synthesized from C-3 oxirane. In the course of this synthesis, stereochemistry of the C-3 oxirane was confirmed by ^1H NMR as well as single crystal X-ray. The newly synthesized molecules are under bioevaluation for their antimicrobial activity.

2.2.2 Introduction

The medicinal chemistry of steroids covers a large and interesting series of structures and biological activities.¹ Though the number of steroidal natural products is limited, millions of hybrids can be prepared. This new approach seems to be very promising in the development of lead molecules. The sterol-polyamine conjugates as a new class of antibiotics have attracted much interest in recent years due to emergence of penicillin-resistant *Staphylococci*, *Streptococcus pneumoniae* in hospitalised patients.² Polyamines are polycationic at physiological pH and play key roles in biological systems.³ Polyamines are of considerable interest due to their advantages of low toxicity, low immunogenicity, controllable synthesis and defined molecular structure for pharmaceutical characterization.⁴

2.2.3 Review of literature

Squalamine **1** is the first sterol-polyamine conjugate that has been isolated from tissues of the dogfish shark, *Squalus acanthias*.⁵ This unusual natural product has attracted considerable attention because of its potent antimicrobial activity against a broad spectrum of microorganisms.⁶

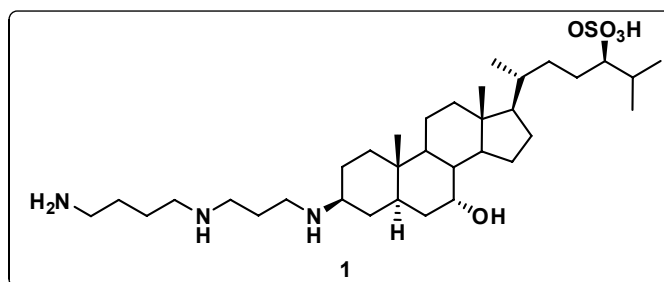

A minireview has appeared recently which summarizes and highlights the different advances in the understanding of the antimicrobial and antiangiogenic activity of squalamine.⁷ Attempts to obtain large amounts of squalamine from the dogfish shark resulted in the discovery, isolation and characterization of family of novel aminosterols.⁸

The fact that insufficient amounts of squalamine were available from natural recourses for mechanistic studies, coupled with clear need for the preparation of analogues prompted several groups to undertake the synthesis of squalamine⁹ and its analogues. A short review on synthesis of spermine and spermidine analogues of

squalamine has been reported.¹⁰ Formal synthesis of squalamine has been achieved in twelve steps from desmosterol with 7.4 % overall yield by Takeuchi and co-workers.¹¹ Recently Zhou *et al.* have accomplished a concise and stereoselective synthesis of squalamine from easily available chenodeoxy cholanate.¹²

Before the discovery of squalamine, cholic acid derivatives **2** and **3** with amine groups incorporated at the C-24 position were described to display only weak antimicrobial activity.¹³

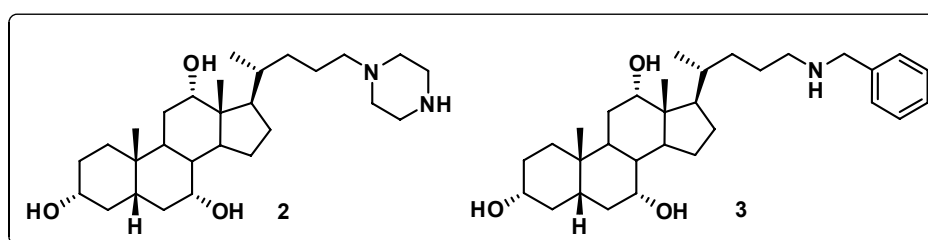

Soon after the isolation of squalamine, Regen and co-workers reported¹⁴ the rapid construction of squalamine mimic **4**. In this molecule they have exchanged the positions of pendant spermidine and sulfate groups on the A and D rings of a closely related sterol. Compound **4** not only mimics the structure of squalamine but also its extraordinary antimicrobial properties. Furthermore, Gilbert *et al.* have investigated¹⁵ the role of sulfate groups of squalamine by preparing various simplified analogues of compound **5**.

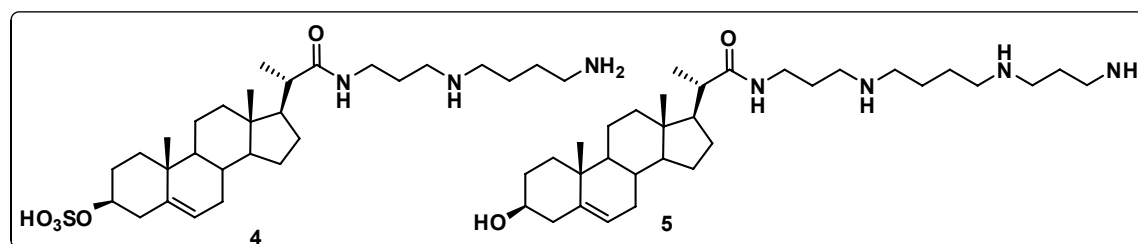

Bradly *et al.* have achieved synthesis of same analogue **4** of squalamine by using solid phase synthesis.¹⁶ Armstrong and co-workers investigated the antimicrobial properties of several bile acid based squalamine mimics.¹⁷ The mimics like **6** and **7** were prepared by linking putrescine, triethylenetetraamine and spermine in the side chain of different bile acids such as cholic acid, deoxycholic acid, lithocholic acid, ursocholanic acid, chenodeoxycholic acid and hyodeoxycholic acid.

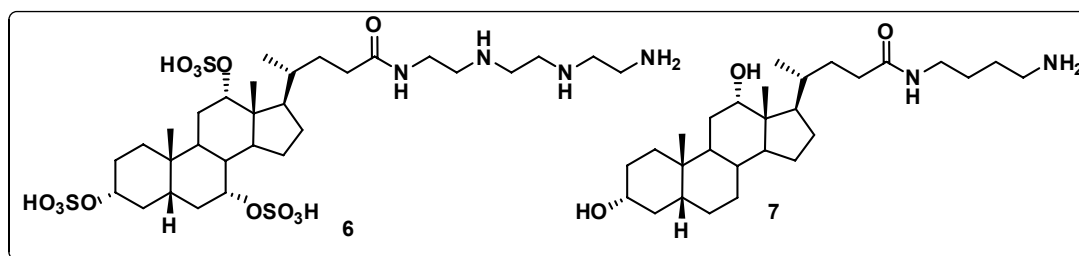

Jones *et al.* described the synthesis and antimicrobial activities of new squalamine analogues, such as 6 β -hydroxy-3-aminosterol **8** with *trans* A/B ring junction, from hydoxycholeic acid.¹⁸ Synthesis of squalamine analogue **9** having short side chain has been reported by Kim and co-workers.¹⁹ Selinsky *et al.* synthesized several new analogues e.g. **10** and **11** of squalamine and studied their antimicrobial activity.²⁰

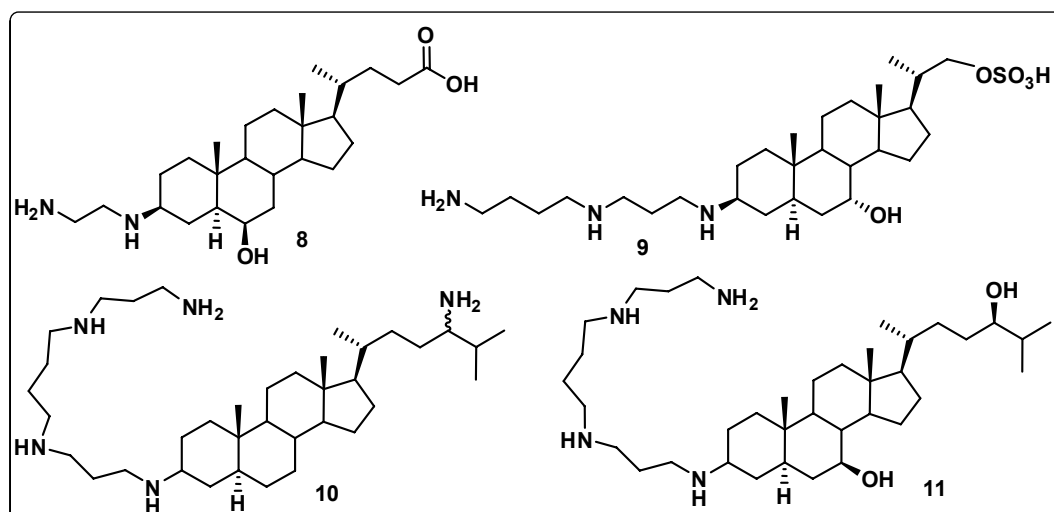

Stereoselective synthesis of squalamine dessulfates analogues **12** and **13** in which polyamine chain is attached to B ring of steroid skeleton were reported by Kihel and co-workers.²¹ Some of these analogues showed similar anti-bacterial activity to the parent compound squalamine.

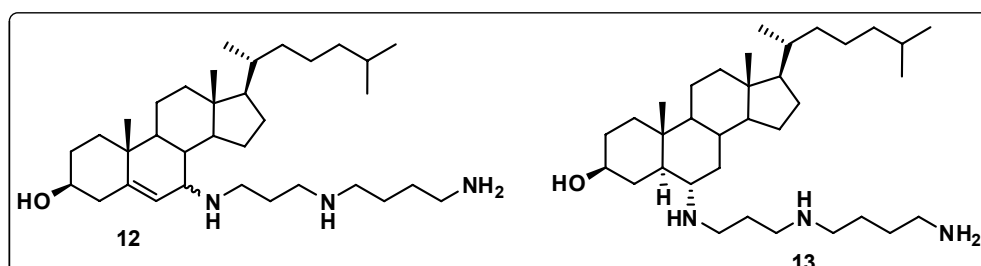

Savage *et al.*²² have designed a class of cationic steroid antibiotics (CSA) as steroid polyamine conjugates, with the intention of mimicking the antibacterial activities of polymyxin B (PMB) **14**. These antibiotics display antibacterial activity comparable or superior to that of PMB against Gram-negative bacteria. PMB **14** contains a lipophilic acyl chain and a heptapeptide ring that is responsible for lipopolysaccharide (LPS) binding. Resistance to PMB involves modification of LPS in the outer membranes of Gram-negative bacteria.²³ Since PMB is difficult to prepare and purify, simple molecules capable of associating with LPS and alter the permeability of Gram-negative bacteria were designed.²⁴ In their approaches in designing PMB mimics modification of steroids with polyamines have been carried out.

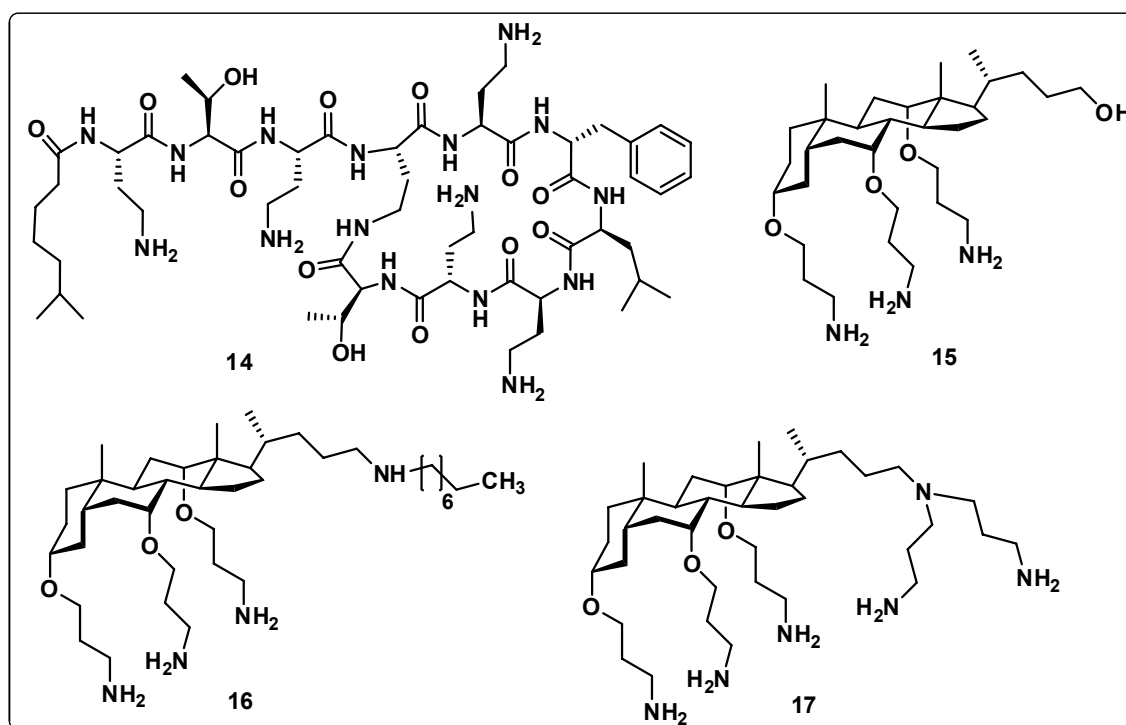

In PMB the amine groups on the macro ring are oriented on one face of the molecule but are segregated from the hydrophobic groups. Based on these observations PMB mimics **15** to **17** have been synthesized from cholic acid. In these molecules amino groups have been separated from the hydrophobic steroid moiety by ether linkage with stereochemically oriented oxygen atoms, which force the amine groups to occupy one face of the steroid. This allows the cholic acid derivatives **15**, **16** and **17** to exhibit facial amphiphilicity common to cationic peptide antibiotics. Compound **16** shows potent bactericidal activity against Gram-negative and Gram-positive bacteria while compound

15, that has no hydrophobic chain at C-24, does not show bactericidal activity against Gram-negative bacteria. This parallels to that of PMB and its derivatives.²⁵

Regen and co-workers have described the utilization of bile acid-polyamine conjugates as synthetic ionophores and extremely useful leads in the process of drug discovery²⁶ which is already discussed in introduction of chapter 1.

Recently there is report²⁷ from our group on synthesis of amino functionalized novel cholic acid derivatives such as **18** containing 1, 2 aminoalcohol in C ring of steroidal backbone. These compounds induced HIV-1 replication and syncytia formation in T cells.

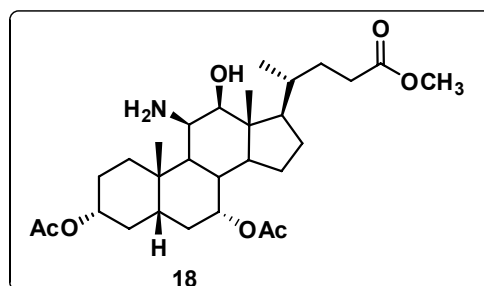

2.2.4 Present Work

2.2.4.1 Objective

Literature search revealed that a number of steroidal polyamine conjugates have been synthesized to improve activity spectrum and availability. Variations in the structure of the analogues led to changes in the spectrum of activity against variety of bacteria and yeasts. From the literature studies it is observed that three common elements are required for their characteristic activity

- ✓ Long and rigid hydrophobic unit.
- ✓ A flexible hydrophilic chain which is linked to hydrophobic unit.
- ✓ A pendant polar head group.

The precise structure of the polyamine is not important. The sulfate groups can be replaced by a carboxylate or hydroxyl or even removed altogether. The structure of the rigid hydrophobic unit i.e. steroid can also be varied.

From this literature survey, we have synthesized bile acid-methylamine and bile acid-ethylenediamine conjugates from the common intermediate oxirane. During the course of synthesis of these conjugates stereochemistry of oxirane at C-3 position of bile acid was assigned by spectroscopic data and confirmed by single crystal X-ray.

2.2.4.2 Results and Discussion

Accordingly, we synthesized oxirane **23** starting from methyl deoxycholate **19**. Oxidation of **19** was carried out using $\text{CrO}_3/\text{H}_2\text{SO}_4$ (Jones reagent) to obtain diketo compound **21** (Scheme 1). In ^{13}C NMR C-3 and C-12 keto carbonyl showed chemical shift at δ 211.8 and 213.8 respectively, while C-24 ester carbonyl was observed at δ 174.3. Diketo compound **21** when reacted with trimethylsulfoxonium iodide in DMSO/THF as a mixed solvent using NaH as a base gave regioselectively C-3 oxirane **23** as a single isomer in 91 % yield. The formation of oxirane **23** was confirmed by its spectroscopic data. In ^1H -NMR spectrum **23** showed a chemical shift for oxirane protons (OCH_2) as broad singlet at δ 2.62. Its ^{13}C NMR showed characteristic signals at δ 174.1, and 213.6 corresponding to the ester and C-12 keto carbonyls respectively. Two distinguishing signals at δ 53.4 (OCH_2) and 57.5 (C-3 quaternary carbon) were observed.

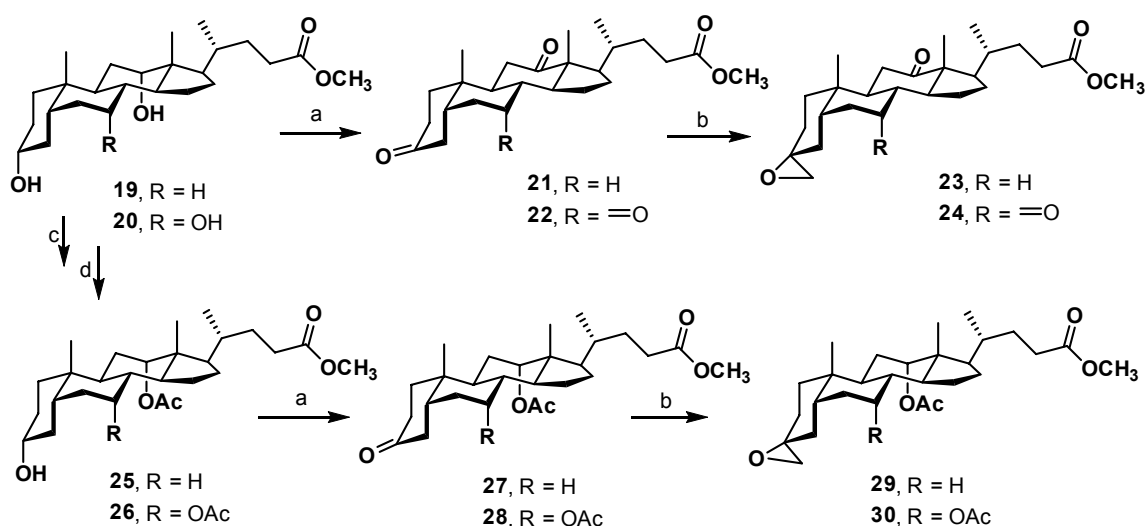

Scheme 1: Reagents and conditions: (a) CrO_3 , H_2SO_4 , Acetone, acetone, 0-10 °C, 10 min.; (b) Trimethyl sulfoxonium iodide, NaH, DMSO-THF, rt. 2 h; (c) Ac_2O , DMAP, Et_3N , DCM, 25-28 °C, 24 h; (d) K_2CO_3 , MeOH 3 h;

It is reported that the less reactive oxosulfonium ylide react with the carbonyl to form oxiranes. The stereochemistry of carbonyl addition to cyclohexanones varies depending on the ylide; the oxosulfonium ylide reacts by equatorial addition (i.e., of methylene) and the sulfonium ylide shows a preference for axial addition.²⁸ Formation of C-3 oxirane from C-3 keto steroids in which A/B ring junction is *trans* (Figure 1) is known in the literature.²⁹ There is no report on synthesis of C-3 oxirane of bile acid derivatives. In bile acids A/B ring junction is *cis*, hence α -face becomes more crowded as compared to A/B *trans* junction. Hence we became interested in confirming the stereochemistry of oxirane 23.

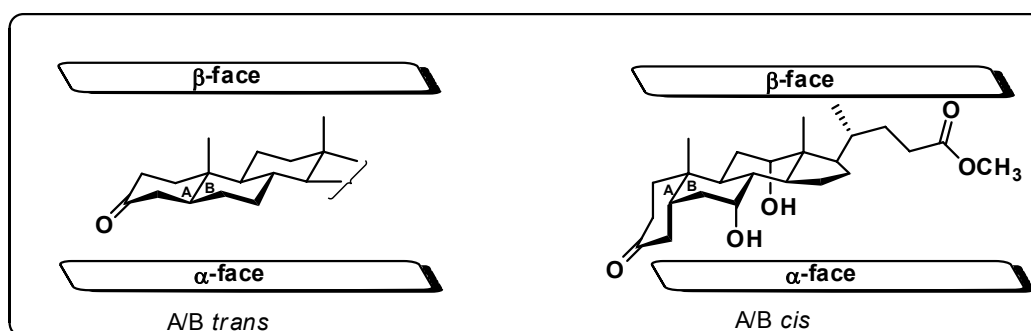

Figure 1:

We synthesized oxirane 24 using similar reaction sequence as that for oxirane 23, starting from methyl cholate 20 in good yield (Scheme 1). Our efforts to crystallize

compounds **23** and **24** remained unsuccessful. To confirm the stereochemistry we introduced acetate group at C-12 (and C-7) and synthesized oxiranes **29** and **30** from **19** and **20** respectively. Compound **19** was reacted with acetic anhydride in pyridine to obtain 3,12-diacetate compound which undergoes selective deprotection of C-3 acetate using K_2CO_3 in methanol to obtain **25** in good yield. Oxidation of **25** was carried out using Jones reagent, followed by oxirane formation using sulfur ylide (trimethyloxosulfoxonium iodide/NaH in DMSO/THF) to obtain compound **29**. Using similar reaction sequence oxirane **30** was obtained from **20** in good yield. Again, the compounds **29** and **30** could not be crystallized. Structures of both these compounds were confirmed by spectroscopic data. 1H -NMR spectrum of **29** showed a chemical shift at δ 3.29, broad singlet for oxirane (OCH_2). Downfield shift of oxirane CH_2 in compound **29** by $\sim \delta$ 0.7 compared with oxirane **23** (Figure 2) may be due to field effect of acetate group on oxirane CH_2 (Figure 3). This clearly indicated that acetate groups in compounds **29** and **30** and oxirane CH_2 are in one plane (on α -face). From this observation we concluded that oxosulfonium ylide attacks on C-3 keto from equatorial side.

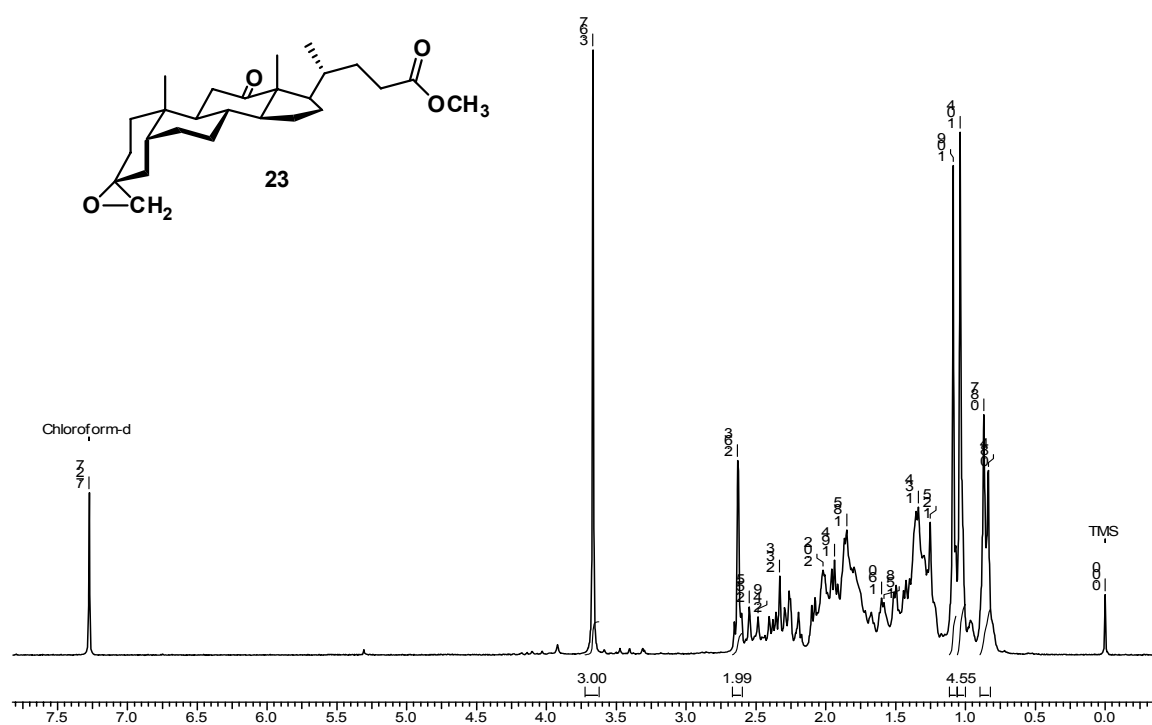

Figure 2:

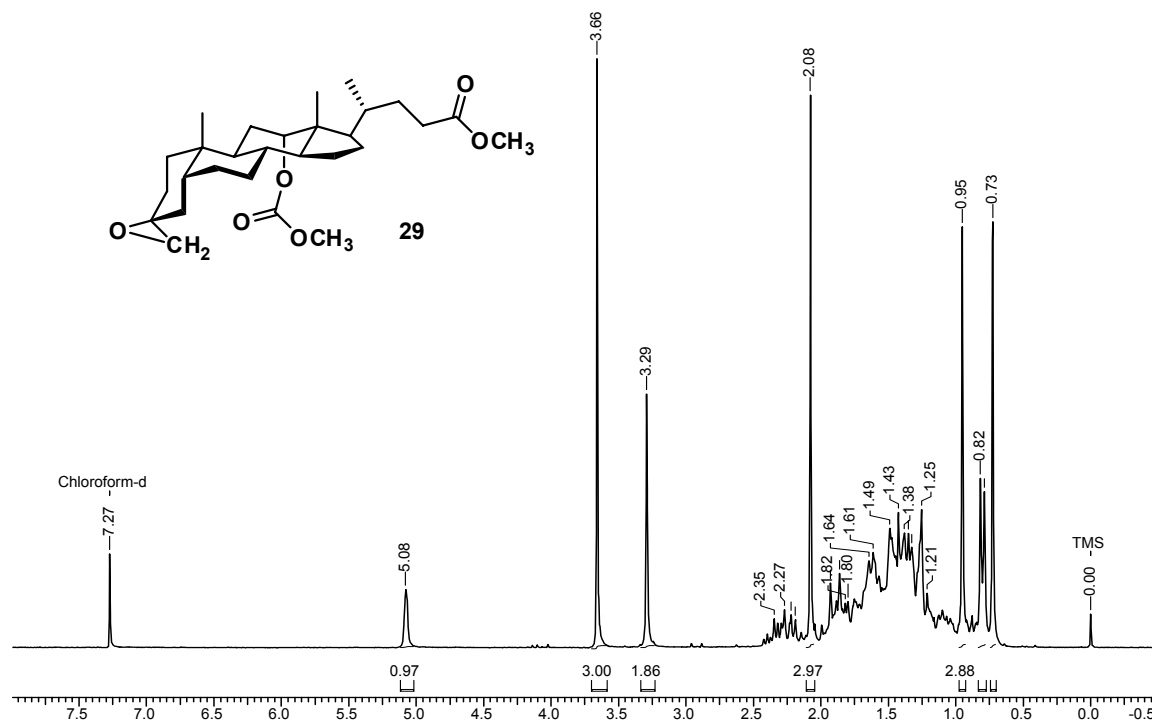
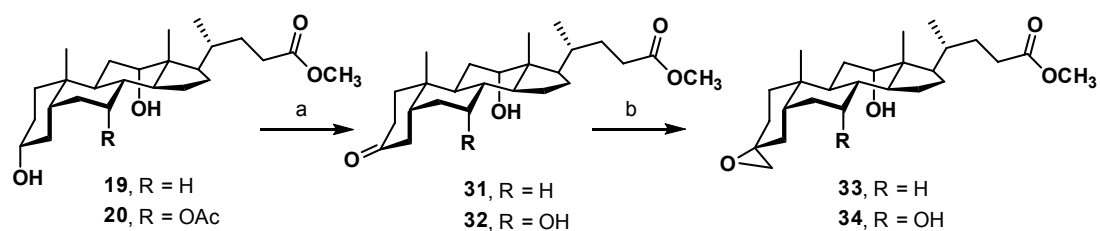

Figure 3:

Our next step was to attach amino functionality to steroid ring by opening of oxiranes with ethylene diamine or azide anion followed by reduction of azide to amine. To achieve the synthesis of our target molecules, we need to reduce keto functionality of oxirane **23**, **24** or deprotect acetyl protection at C-7, C-12 of oxiranes **29** and **30**. To avoid the reduction or protection-deprotection steps we synthesized oxirane **33** and **34** in two steps starting from methyl esters **19** and **20** (Scheme 2).

Selective oxidation of C-3 hydroxy group of compound **19** was carried out using Ag_2CO_3 on celite (prepared from AgNO_3 and Na_2CO_3 by literature procedure³⁰). In IR spectrum, absorbance due to keto carbonyl appeared at 1712 cm^{-1} while ester carbonyl at 1735 cm^{-1} . In ^{13}C NMR compound **31** showed signal at δ 213 ppm, due to C-3 keto carbonyl. Reaction of **31** with sulfur ylide (trimethylsulfoxonium iodide/ NaH in DMSO-THF) resulted into oxirane **33** in good yield (96%). In ^1H NMR compound **33** showed broad singlet at δ 2.64 due to oxirane CH_2 . In ^{13}C NMR signal at δ 213 ppm disappeared and one additional methylene signal was observed at δ 53.8.



Scheme 2: Reagents and conditions: (a) Ag_2CO_3 , toluene, Reflux, 5 h; (b) Trimethyl sulphoxoniumiodide, NaH, DMSO-THF, rt. 2 h.

Oxirane **33** could be nicely crystallized from ethylacetate-hexane and the C-3 oxirane stereochemistry was confirmed by single crystal X-ray (Figure 4).

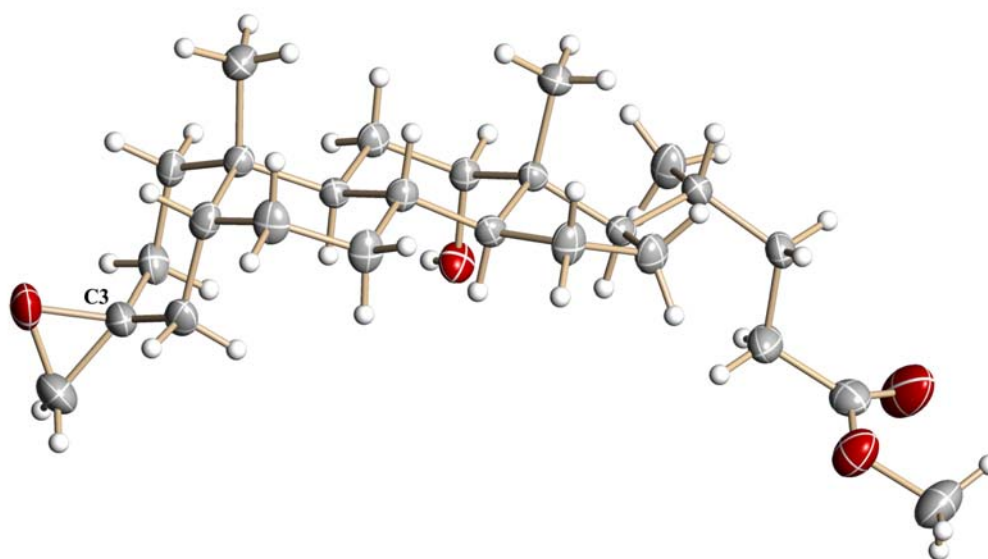
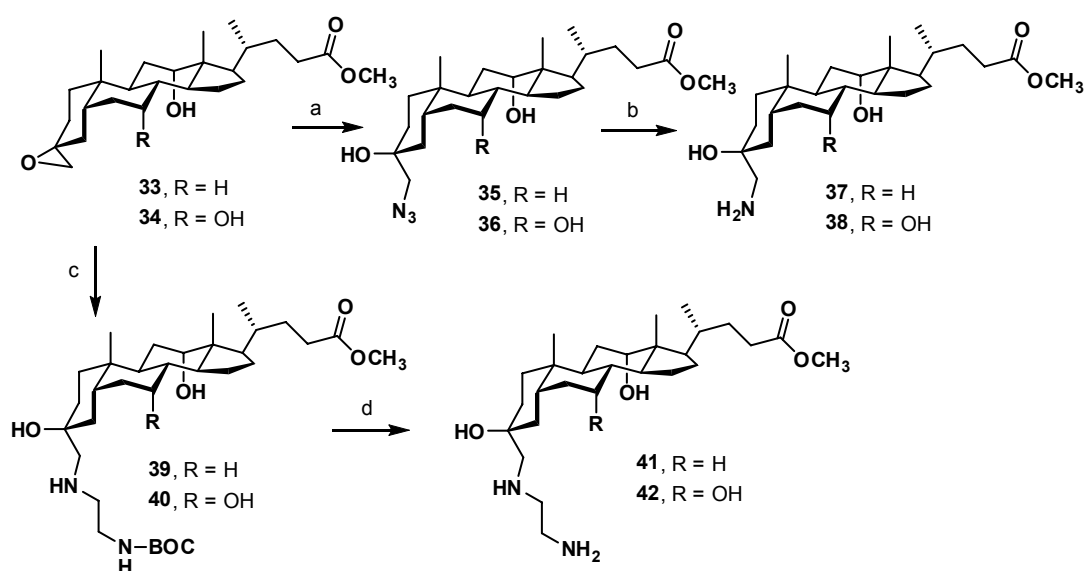

Figure 4: ORTEP view of Methyl (3 β -oxirane)-12 α -hydroxy-5 β -cholan-24-oate **33**.

Using similar reaction sequence oxirane **34** was synthesized from methyl cholate **20** in good yield. Nucleophilic opening of oxirane **33** with azide anion (NaN_3 in DMF) gave azido alcohol **35** (Scheme 3). IR spectrum of **35** showed characteristic bands at 1731, 2104 cm^{-1} corresponding to the ester carbonyl and azido group respectively. Its $^1\text{H-NMR}$ spectrum showed a characteristic signal at δ 3.26 ppm due to the C-3 α methylene protons (CH_2N_3). Hydrogenation of azido alcohol **35** was carried out using H_2 -Pd/C to obtain deoxycholic based aminoalcohol **37** in good yield. Its $^1\text{H-NMR}$ spectrum showed a characteristic signal at δ 2.59 ppm due to the C-3 α methylene proton (CH_2NH_2). Using similar reaction sequence cholic acid based aminoalcohol **38** was obtained from oxirane **34** in good yield (Scheme 3). We also synthesized two bile acid-ethylenediamine conjugates **41** and **42**. Nucleophilic opening of oxiranes **33** and **34** with N1-(Boc)-1,2-

diaminoethane gave compounds **39** and **40**, followed by deprotection of amine functionality and purification by column chromatography afforded pure bile acid-ethylenediamine conjugates **41** and **42** respectively. In $^1\text{H-NMR}$ spectrum of **41** and **42** showed a characteristic signal at δ 2.52, 2.72 and 2.81 each for two protons corresponding to newly formed ethylene protons of ethylenediamine chain.



Scheme 3: Reagents and conditions: (a) NaN_3 , DMF, 60-65 $^\circ\text{C}$, 12 h; (b) H_2 / Pd-C, MeOH; (c) N1-(Boc)-1,2- diaminoethane, MeOH reflux 2h; (d) 50% TFA/DCM.

Bioevaluation

The synthesized bile acid-amine conjugates **37**, **38**, **41** and **42** are under preliminary biological evaluation to study their *in vitro* antimicrobial activity.

2.2.5 Conclusion

In conclusion, we have synthesized novel bile acid-amine conjugates from common intermediate **33** with good yield. During the course of synthesis we confirmed the C-3 oxirane stereochemistry by spectroscopic data as well as single crystal X-ray. The synthesized molecules and intermediates are under biological screening for their antimicrobial activity.

2.2.6 Experimental Section

Methyl 3, 12- diketo-5 β -cholan-24-oate (21) and Methyl 3,7, 12- triketo-5 β -cholan-24-oate (22):

To a solution of methyl 3 α ,12 α -dihydroxy-5 β - cholan-24-oate **19** (0.812 g, 2 mmol) in acetone (20 mL) Jones Reagent (5 mL) was added at 5-10 °C. The reaction mixture was stirred at the same temperature for 10 min. Methanol (5 mL) was added, the solvent was evaporated and the crude solid material was dissolved in EtOAc/H₂O (5:1) mixture (100 mL). The organic layer was washed with cold H₂O (2x10 mL), 10% NaHCO₃ (2x10 mL), brine (2x10 mL) and dried over Na₂SO₄. Solvent was evaporated under reduced pressure to afford crude product. Purification by column chromatography on silica gel (2% MeOH/DCM) afforded pure compound **21** (0.772 g, 95%) as a white solid. Using similar procedure compound **22** was synthesized starting from methyl cholate **20**.

Methyl 3, 12- diketo-5 β -cholan-24-oate (21): mp 230 °C; IR (cm⁻¹): 1706, 1730; ¹H NMR (200 MHz, CDCl₃): δ 0.86 (d, J = 6.4 Hz, 3H, CH₃-21), 1.06 (s, 3H, CH₃-18), 1.11 (s, 3H, CH₃-19), 3.67 (s, 3H); ¹³C NMR (50 MHz, CDCl₃): δ 11.5, 18.4, 21.9, 24.1, 25.2, 26.3, 27.3, 30.2, 31.0, 35.2, 35.3, 35.3, 36.5, 36.7, 38.1, 41.9, 43.5, 43.9, 46.3, 51.2, 57.3, 58.2, 174.3, 211.8, 213.8.; Anal. Calcd for C₂₅H₃₈O₄: C, 74.59; H, 9.51; Found: C, 74.32; H, 9.41; MS (LCMS) m/z : 425.64 (M + 23 for Na).

Methyl 3,7, 12- triketo-5 β -cholan-24-oate (22): White solid, Yield: 96%; mp 246-247 °C; IR (cm⁻¹): 1697, 1704, 1737; ¹H NMR (300 MHz, CDCl₃): δ 0.85 (d, J = 6.3 Hz, 3H, CH₃-21), 1.07 (s, 3H, CH₃-18), 1.41 (s, 3H, CH₃-19), 3.66 (s, 3H); ¹³C NMR (75 MHz, CDCl₃): δ 11.7, 18.5, 21.8, 25.0, 27.5, 30.4, 31.9, 35.2, 35.4, 35.9, 36.3, 38.5, 42.7, 44.8, 45.5, 45.6, 46.7, 48.9, 51.3, 51.7, 56.8, 174.2, 208.3, 208.6, 211.6; Anal. Calcd for C₂₅H₃₆O₅: C, 72.08; H, 8.71; Found: C, 71.83; H, 8.53; MS (LCMS) m/z : 439.62 (M + 23 for Na).

Methyl (3 β -oxirane)-12- keto-5 β -cholan-24-oate (23) and Methyl (3 β -oxirane)-7, 12- diketo-5 β -cholan-24-oate (24):

To a solution of trimethylsulfoxonium iodide (0.330gm, 1.5 mmol) in dry DMSO (5 mL) was added NaH (0.048 g, 2 mmol). After 1h, compound **21** (0.402 g, 1 mmol) dissolved

in 5 mL THF was added at 25 °C. After stirring for 5 h ice was added to the reaction mixture and the product was extracted with ethyl acetate (2×50 mL). The organic layer was washed with water (4×10 mL) and then with brine solution. Extract was dried over sodium sulfate. Solvent was removed under reduced pressure and the crude product was purified by column chromatography (2% Methanol/DCM) to get pure compound **23** (0.457 g, 91% yield). Using similar procedure compound **24** was synthesized starting from methyl cholate **22**.

Methyl (3 β -oxirane)-12- keto-5 β -cholan-24-oate (23): White solid, Yield: 91%; mp 220 °C; $[\alpha]_D^{25}$ (CHCl₃, c 0.38) = + 43.8; IR (cm⁻¹): 1703, 1731; ¹H NMR (200 MHz, CDCl₃): δ 0.84 (d, *J* = 6.5 Hz, 3H, CH₃-21), 1.03 (s, 3H, CH₃-18), 1.08 (s, 3H, CH₃-19), 2.62 (bs, 3H, oxirane CH₂) 3.66 (s, 3H); ¹³C NMR (50 MHz, CDCl₃): δ 11.6, 18.5, 22.7, 24.2, 25.8, 26.3, 27.4, 27.8, 30.5, 31.2, 33.4, 34.0, 35.3, 35.4, 35.5, 38.3, 40.2, 43.7, 46.5, 51.2, 53.4, 57.5, 58.6, 58.7, 174.4, 214.5; Anal. Calcd for C₂₆H₄₀O₄: C, 74.96; H, 9.68; Found: C, 74.68; H, 9.53; MS (LCMS) *m/z*: 439.05 (M + 23 for Na).

Methyl (3 β -oxirane)-7, 12-diketo-5 β -cholan-24-oate (24): White solid, Yield: 89%; mp 174-175 °C; $[\alpha]_D^{27}$ (CHCl₃, c 0.41) = + 49.8; IR (cm⁻¹): 1699, 1712, 1733; ¹H NMR (300 MHz, CDCl₃): δ 0.84 (d, *J* = 6.5 Hz, 3H, CH₃-21), 1.05 (s, 3H, CH₃-18), 1.37 (s, 3H, CH₃-19), 2.62 (bs, 3H, oxirane CH₂) 3.66 (s, 3H); ¹³C NMR (75 MHz, CDCl₃): δ 11.7, 18.5, 22.5, 25.1, 27.3, 27.6, 30.4, 31.2, 32.9, 34.5, 35.4, 35.8, 38.6, 43.9, 44.9, 45.2, 45.5, 48.9, 51.4, 51.8, 53.2, 56.8, 57.7, 174.5, 209.7, 212.6; Anal. Calcd for C₂₆H₃₈O₅: C, 72.53; H, 8.90; Found: C, 72.33; H, 8.63; MS (LCMS) *m/z*: 453.42 (M + 23 for Na).

Procedure for acetylation of compounds 19 and 20:

To a solution of methyl ester **19** (0.406 g, 1 mmol) in dry dichloromethane (10 mL), 4-dimethylaminopyridine (0.042 g, 10 mole%), triethylamine (0.694 mL, 5 mmol), acetic anhydride (0.47 mL, 5 mmol) were added and the reaction mixture was stirred at 30° C for 16 h. Reaction was quenched with cold water, and extracted with dichloromethane (2x25 mL). Organic extract was washed with water, 5% NaHCO₃ (2x25 mL) and brine and dried on anhydrous Na₂SO₄. Solvent was removed under reduced pressure and the product was purified by column chromatography (20% ethylacetate/pet-ether) to give pure methyl 3 α , 12 α - diacetate-5 β -cholan-24-oate (0.456 g, 93% yield). Similarly methyl

3 α ,7 α ,12 α -triacetate-5 β -cholan-24-oate was synthesized from methyl ester **20** in 94% yield.

Methyl 3 α , 12 α - diacetoxy-5 β -cholan-24-oate: IR (cm⁻¹): 1724, 1733; ¹H NMR (200 MHz, CDCl₃): δ 0.72 (s, 3H, CH₃-18), 0.80 (d, J = 6.1 Hz, 3H, CH₃-21), 0.90 (s, 3H, CH₃-19), 2.03 (s, 3H), 2.10 (s, 3H), 3.66 (s, 3H), 4.70 (m, 1H), 5.08 (bs, 1H); ¹³C NMR (125 MHz, CDCl₃): δ 12.9, 18.1, 21.9, 22.0, 23.6, 24.0, 26.2, 26.4, 27.2, 27.5, 27.9, 31.4, 31.5, 32.8, 34.6, 35.0, 35.3, 35.3, 36.2, 42.4, 45.6, 48.1, 50.0, 52.0, 74.8, 76.5, 171.0, 171.1, 175.1; MS (LCMS) m/z : 491.47 (M + 1), 513.68 (M + 23 for Na).

Methyl 3 α ,7 α , 12 α - triacetoxy-5 β -cholan-24-oate: White solid, Yield: 94%; mp IR (cm⁻¹): 1724, 1733; ¹H NMR (200 MHz, CDCl₃): δ 0.73 (s, 3H, CH₃-18), 0.81 (d, J = 6.1 Hz, 3H, CH₃-21), 0.92 (s, 3H, CH₃-19), 2.05 (s, 3H), 2.09 (s, 3H), 2.14 (s, 3H), 3.66 (s, 3H), 4.60 (m, 1H), 4.90 (bs, 1H), 5.08 (bs, 1H); ¹³C NMR (50 MHz, CDCl₃): δ 11.9, 11.2, 21.1, 21.2, 21.3, 22.2, 22.5, 25.3, 26.6, 26.9, 28.6, 30.4, 30.5, 30.9, 34.0, 34.3, 34.3, 34.4, 37.4, 40.6, 43.1, 44.7, 47.0, 51.2, 70.4, 73.7, 75.0, 170.0, 170.1, 170.1, 174.1; MS (LCMS) m/z : 549.78 (M + 1), 571.75 (M + 23 for Na).

Methyl 3 α -hydroxy- 12 α -acetoxy-5 β -cholan-24-oate (25) and Methyl 3 α -hydroxy- 7 α , 12 α -diacetoxy-5 β -cholan-24-oate (26):

To solution of 3, 7, diacetoxy methyl cholate (0.245 g, 0.5 mmol) in methanol (10 mL) anhydrous K₂CO₃ (0.089 g, 0.6 mmol) was added. The reaction mixture was stirred at 30° C for 3h. Methanol was removed under reduced pressure, on rotavapour at low temperature. The residue was extracted with ethyl acetate (3x25 mL). Organic extract was washed with water and brine. It was dried over anhydrous Na₂SO₄ and concentrated to gave 3 α -hydroxy,12 α -acetoxy methyl cholate **25** (0.208 g) in 97% yield. Similarly methyl 3 α -hydroxy,7 α ,12 α -diacetoxy-methyl cholate **26** was synthesized from methyl 3 α ,7 α , 12 α - triacetoxy-5 β -cholan-24-oate in 95 % yield.

Methyl 3 α -hydroxy-12 α -acetoxy-5 β -cholan-24-oate (25): White solid, Yield: 97%; IR (cm⁻¹): 1724, 1733, 3300; ¹H NMR (200 MHz, CDCl₃): δ 0.72 (s, 3H, CH₃-18), 0.79 (d, J = 6.2 Hz, 3H, CH₃-21), 0.89 (s, 3H, CH₃-19), 2.08 (s, 3H), 3.62 (m, 1H), 3.66 (s, 3H), 5.07 (bs, 1H); ¹³C NMR (50 MHz, CDCl₃): δ 12.1, 17.2, 21.1, 22.9, 23.2, 25.3, 25.7, 26.8,

27.1, 30.1, 30.6, 30.7, 33.8, 34.1, 34.4, 34.8, 35.5, 35.9, 41.7, 44.7, 47.3, 49.2, 51.3, 71.2, 75.7, 170.4, 174.4; Anal. Calcd for C₂₇H₄₄O₅: C, 72.28; H, 9.89; Found: C, 71.91; H, 9.53; MS (LCMS) *m/z*: 449.47 (M + 1), 471.43 (M + 23 for Na).

Methyl 3 α -hydroxy-7 α ,12 α -diacetoxy-5 β -cholan-24-oate (26): White solid, Yield: 95%; IR (cm⁻¹): 1724, 1733, 3301; ¹H NMR (200 MHz, CDCl₃): δ 0.73 (s, 3H, CH₃-18), 0.80 (d, *J* = 6.1 Hz, 3H, CH₃-21), 0.91 (s, 3H, CH₃-19), 2.09 (s, 3H), 2.13 (s, 3H), 3.50 (m, 1H), 3.66 (s, 3H), 4.89 (bs, 1H), 5.08 (bs, 1H); ¹³C NMR (50 MHz, CDCl₃): δ 12.2, 17.4, 21.4, 21.6, 22.5, 22.7, 25.5, 27.1, 28.9, 30.4, 30.7, 30.8, 31.3, 34.2, 34.5, 34.8, 37.7, 38.5, 40.9, 43.3, 45.0, 47.2, 51.5, 70.8, 71.6, 74.4, 170.6, 170.6, 174.5; Anal. Calcd for C₂₉H₄₆O₇: C, 68.74; H, 9.15; Found: C, 68.39; H, 9.10; MS (LCMS) *m/z*: 507.59 (M + 1), 529.62 (M + 23 for Na).

Methyl 3-keto-12 α -acetoxy-5 β -cholan-24-oate (27) and Methyl 3-keto-7 α ,12 α -diacetoxy-5 β -cholan-24-oate (28):

Compounds **27** and **28** were prepared by Jones oxidation from compounds **25** and **26** respectively by using similar procedure as used for the preparation of compound **21**.

Methyl 3-keto-12 α -acetoxy-5 β -cholan-24-oate (27): White solid, Yield: 93%; mp 183-184 °C; IR (cm⁻¹): 1703, 1724, 1733; ¹H NMR (200 MHz, CDCl₃): δ 0.75 (s, 3H, CH₃-18), 0.80 (d, *J* = 6.1 Hz, 3H, CH₃-21), 0.99 (s, 3H, CH₃-19), 2.06 (s, 3H), 2.68 (dd, *J* = 13.14 and 15.03 Hz, 1H), 3.65 (s, 3H), 5.11 (bs, 1H); ¹³C NMR (50 MHz, CDCl₃): δ 12.3, 17.3, 21.1, 22.2, 23.2, 25.2, 25.7, 26.3, 27.1, 30.6, 30.7, 34.1, 34.5, 34.5, 35.2, 36.4, 36.7, 42.0, 43.8, 44.9, 47.4, 49.2, 51.3, 75.5, 170.2, 174.3, 212.6; Anal. Calcd for C₂₇H₄₂O₅: C, 72.61; H, 9.48; Found: C, 72.40; H, 9.23; MS (LCMS) *m/z*: 447.57 (M + 1), 469.51 (M + 23 for Na).

Methyl 3-keto-7 α ,12 α -diacetoxy-5 β -cholan-24-oate (28): White solid, Yield: 91%; mp 203-205 °C; IR (cm⁻¹): 1701, 1724, 1733; ¹H NMR (200 MHz, CDCl₃): δ 0.77 (s, 3H, CH₃-18), 0.82 (d, *J* = 6.1 Hz, 3H, CH₃-21), 1.02 (s, 3H, CH₃-19), 2.07 (s, 3H), 2.11 (s, 3H), 2.98 (dd, *J* = 13.4 and 15.3 Hz, 1H), 3.66 (s, 3H), 4.99 (bs, 1H), 5.13 (bs, 1H); ¹³C NMR (50 MHz, CDCl₃): δ 12.1, 17.4, 21.2, 21.3, 21.5, 22.6, 25.7, 27.0, 29.7, 30.6, 30.7, 30.8, 34.3, 34.4, 36.0, 36.5, 37.6, 42.0, 43.1, 44.4, 45.0, 47.2, 51.3, 70.4, 75.1, 170.0,

170.2, 174.3, 211.9; Anal. Calcd for C₂₉H₄₄O₇: C, 69.02; H, 8.79; Found: C, 68.82; H, 8.53; MS (LCMS) *m/z*: 505.61 (M + 1), 527.68 (M + 23 for Na).

Methyl 3-oxirane-12 α -acetoxy-5 β -cholan-24-oate (29) and Methyl 3-oxirane-7 α ,12 α -diacetoxy-5 β -cholan-24-oate (30):

Oxiranes **29** and **30** were synthesised by using sulfur ylide from compound **27** and **28** respectively by using similar procedure as used for the preparation of oxirane **23**.

Methyl 3-oxirane-12 α -acetoxy-5 β -cholan-24-oate (29): White solid, Yield: 89%; mp 153-154 °C; IR (cm⁻¹): 1724, 1733; ¹H NMR (200 MHz, CDCl₃): δ 0.72 (s, 3H, CH₃-18), 0.80 (d, *J* = 6.1 Hz, 3H, CH₃-21), 0.95 (s, 3H, CH₃-19), 2.08 (s, 3H), 3.29 (bs, 2H, oxirane CH₂), 3.66 (s, 3H), 5.08 (bs, 1H); ¹³C NMR (50 MHz, CDCl₃): δ 12.2, 17.3, 21.0, 22.1, 23.3, 25.2, 25.8, 26.1, 27.2, 27.4, 30.6, 30.7, 31.3, 33.7, 34.2, 34.3, 34.4, 34.5, 43.4, 45.0, 47.6, 49.1, 51.3, 53.3, 68.0, 75.4, 170.0, 174.1; Anal. Calcd for C₂₈H₄₄O₆: C, 73.01; H, 9.63; Found: C, 72.83; H, 9.44; MS (LCMS) *m/z*: 461.63 (M + 1), 583.42 (M + 23 for Na).

Methyl 3-oxirane-7 α ,12 α -diacetoxy-5 β -cholan-24-oate (30): White solid, Yield: 86%; mp 196-198 °C; IR (cm⁻¹): 1724, 1733; ¹H NMR (200 MHz, CDCl₃): δ 0.73 (s, 3H, CH₃-18), 0.81 (d, *J* = 6.1 Hz, 3H, CH₃-21), 0.95 (s, 3H, CH₃-19), 2.11 (s, 3H), 2.12 (s, 3H), 3.27 (bs, 2H, oxirane CH₂), 3.66 (s, 3H), 4.90 (bs, 1H), 5.08 (bs, 1H); ¹³C NMR (50 MHz, CDCl₃): δ 12.1, 17.4, 21.4, 21.7, 22.3, 22.6, 23.3, 25.5, 27.1, 27.8, 30.7, 30.8, 30.9, 31.5, 34.1, 34.5, 37.5, 37.6, 38.7, 42.0, 43.3, 44.9, 47.3, 51.5, 53.3, 70.0, 70.9, 75.4, 170.4, 170.4, 174.5; Anal. Calcd for C₃₀H₄₆O₇: C, 69.47; H, 8.94; Found: C, 69.23; H, 8.53; MS (LCMS) *m/z*: 519.47 (M + 1), 541.54 (M + 23 for Na).

Methyl 3-keto-12 α -hydroxy-5 β -cholan-24-oate (31) and Methyl 3-keto-7 α ,12 α -dihydroxy-5 β -cholan-24-oate (32):

Reaction was carried out in Dean Stark apparatus. To a solution of **19** (2 g, 4.926 mmol) in toluene (20 mL), well dried freshly prepared Ag₂CO₃ on celite (5.96 g, 21 mmol) was added. Reaction mixture was refluxed for 5-6 h. Reaction mixture was filtered through sintered funnel and the residue was washed with ethyl acetate. Filtrate was evaporated

under reduced pressure to obtain crude product **31** which on further purification by column chromatography (1.5% Methanol/DCM) afforded pure product **31** (1.850 g) in 92% yield. Using similar procedure compound **32** was synthesized from **20** in 90% yield. [Preparation of the Ag_2CO_3 on celite: AgNO_3 (34 g) was dissolved in 200 mL distilled water, the purified celite, 30 g (Celite was washed with 10% methanolic HCl, then with distilled water to neutrality and dried in oven at 120 °C for 24 h) was added. The mixture was stirred for 10 to 15 min and $\text{Na}_2\text{CO}_3 \cdot 10\text{H}_2\text{O}$, (30 g) dissolved in 300 mL distilled water was added. Stirring was continued for 10 min, yellow green precipitate was filtered and washed to neutrality with distilled water and dried for longer time. This reagent can be stored but preferably should be prepared prior to use³⁰].

Methyl 3-keto-12 α -hydroxy-5 β -cholan-24-oate (31): White solid, Yield: 92%; mp 145 °C (lit^{31,32} 143-145 °C); IR (cm^{-1}): 1712, 1728; ^1H NMR (200 MHz, CDCl_3): δ 0.70 (s, 3H, CH_3 -18), 0.95 (d, $J = 6.1$ Hz, 3H, CH_3 -21), 0.99 (s, 3H, CH_3 -19), 2.71 (dd, $J = 14.4$ Hz, 1H), 3.65 (s, 3H), 4.02 (bs, 1H); ^{13}C NMR (50 MHz, CDCl_3): δ 12.7, 17.3, 22.3, 23.5, 25.4, 26.4, 27.4, 28.9, 30.8, 30.9, 33.7, 34.3, 35.0, 35.6, 36.8, 37.0, 42.2, 44.2, 46.5, 47.3, 48.0, 51.5, 72.8, 174.6, 213.4; Anal. Calcd for $\text{C}_{25}\text{H}_{40}\text{O}_4$: C, 74.22; H, 9.97; Found: C, 73.91; H, 9.59; MS (LCMS) m/z : 405.57 (M + 1).

Methyl 3-keto-7 α , 12 α -dihydroxy-5 β -cholan-24-oate (32): White solid, Yield: 90%; mp 170 °C (lit^{31,32} 173-175 °C); IR (cm^{-1}): 1708, 1728; ^1H NMR (200 MHz, CDCl_3): δ 0.72 (s, 3H, CH_3 -18), 0.97 (d, $J = 6.1$ Hz, 3H, CH_3 -21), 0.99 (s, 3H, CH_3 -19), 3.40 (dd, $J = 13.5$ Hz, 1H), 3.67 (s, 3H), 3.92 (bs, 1H), 4.03 (bs, 1H); ^{13}C NMR (50 MHz, CDCl_3): δ 12.4, 17.2, 21.5, 23.1, 26.9, 27.3, 28.4, 30.7, 31.0, 33.9, 34.8, 35.2, 36.5, 36.7, 39.3, 41.6, 42.9, 45.4, 46.5, 47.1, 51.5, 68.2, 72.8, 174.8, 213.5; Anal. Calcd for $\text{C}_{25}\text{H}_{40}\text{O}_5$: C, 71.39; H, 9.59; Found: C, 69.99; H, 9.43; MS (LCMS) m/z : 421.47 (M + 1).

Methyl (3 β -oxirane),12 α -hydroxy-5 β -cholan-24-oate (33) and Methyl (3 β -oxirane)-7 α , 12 α -dihydroxy-5 β -cholan-24-oate (34):

Oxiranes **33** and **34** were synthesized by using sulfur ylide to give compounds **31** and **32** respectively by using similar procedure as used for the preparation of oxirane **23**.

Methyl (3 β -oxirane)-12 α -hydroxy-5 β -cholan-24-oate (33): White solid, Yield: 89%; mp 162 °C; IR (cm^{-1}): 1730; ^1H NMR (200 MHz, CDCl_3): δ 0.70 (s, 3H, CH_3 -18), 0.96 (d, J

= 6.1 Hz, 3H, CH₃-21), 0.99 (s, 3H, CH₃-19), 2.62 (bs, 2H, oxirane CH₂), 3.67 (s, 3H), 4.01 (bs, 1H); ¹³C NMR (50 MHz, CDCl₃): δ 12.6, 17.2, 23.1, 23.5, 25.7, 26.3, 27.4, 27.9, 28.8, 30.8, 30.9, 33.0, 33.3, 33.9, 34.0, 35.0, 35.7, 40.6, 46.4, 47.2, 48.2, 51.4, 53.5, 59.1, 73.0, 174.6; Anal. Calcd for C₂₆H₄₂O₄: C, 74.60; H, 10.11; Found: C, 74.33; H, 9.87; MS (LCMS) *m/z*: 419.30 (M + 1), 441.27 (M + 23 for Na).

Crystallographic data for compound 33: Empirical formula: C₂₆H₄₂O₄, Formula weight: 418.60; Temperature, 297(2) K, Wavelength, 0.71073 Å, Crystal system, space group, Orthorhombic, P212121, Unit cell dimensions, a = 7.2336(15) Å alpha = 90 deg. b = 10.202(2) Å beta = 90 deg. c = 32.269(7) Å gamma = 90 deg., Volume 2381.4(9) Å³, Z, Calculated density, 4, 1.168 Mg/m³, Absorption coefficient 0.076 mm⁻¹, F(000) 920, Crystal size 0.47 x 0.13 x 0.09 mm, Theta range for data collection 1.26 to 26.00 deg., Limiting indices -8 ≤ h ≤ 8, -12 ≤ k ≤ 9, -39 ≤ l ≤ 39, Reflections collected / unique 13045 / 4672 [R(int) = 0.0199], Completeness to theta = 26.00 100.0%, Absorption correction Semi-empirical from equivalents, Max. and min. transmission 0.9932 and 0.9649, Refinement method Full-matrix least-squares on F², Data / restraints / parameters 4672 / 1 / 279, Goodness-of-fit on F² 1.119, Final R indices [I > 2σ(I)] R1 = 0.0541, wR2 = 0.1277, R indices (all data), R1 = 0.0604, wR2 = 0.1319, Largest diff. peak and hole, 0.253 and -0.166 e.Å⁻³.

Methyl (3β-oxirane)-7α, 12α-dihydroxy-5β-cholan-24-oate (34): White solid, Yield: 84%; mp 180 °C; IR (cm⁻¹): 1730; ¹H NMR (200 MHz, CDCl₃): δ 0.71 (s, 3H, CH₃-18), 0.97 (s, 3H, CH₃-19), 0.99 (d, *J* = 6.1 Hz, 3H, CH₃-21), 2.63 (bs, 2H, oxirane CH₂), 3.67 (s, 3H), 3.88 (bs, 1H), 4.01 (bs, 1H); ¹³C NMR (50 MHz, CDCl₃): δ 12.5, 17.3, 22.5, 23.2, 26.0, 27.4, 27.9, 28.5, 30.8, 31.0, 33.9, 34.0, 34.7, 35.1, 36.3, 39.4, 40.0, 41.8, 46.5, 47.2, 51.5, 53.8, 59.4, 68.5, 72.9, 174.7; Anal. Calcd for C₂₆H₄₂O₅: C, 71.85; H, 9.74; Found: C, 71.61; H, 9.53; MS (LCMS) *m/z*: 435.37 (M + 1), 467.41 (M + 23 for Na).

Methyl (3α-azidomethyl)-3β,12α-dihydroxy-5β-cholan-24-oate (35) and Methyl (3α-azidomethyl)-3β,7α, 12α-trihydroxy-5β-cholan-24-oate (36):

To a solution of **33** (0.207 g, 0.5 mmol) in dry DMF (10 mL), sodium azide (0.100 g, 1.5 mmol) was added and stirring was continued at 60-65 °C for 3h. The reaction mixture was allowed to cool to room temperature. It was then poured into ice-cold water (30 mL) and

extracted with EtOAc. The organic extract was washed with cold water and brine. Solvent was evaporated under reduced pressure to afford crude product **35** which was purified by column chromatography on silica gel (2% MeOH/DCM) to produce pure compound **35** as white solid (0.203 g) in 91% yield. Using similar procedure compound **36** was synthesized from **34** in 90% yield.

Methyl (3 α -azidomethyl)-3 β ,12 α -dihydroxy-5 β -cholan-24-oate (35): White solid, Yield: 91%; mp 139-141 °C; IR (cm⁻¹): 1731, 2104, 3460; ¹H NMR (200 MHz, CDCl₃): δ 0.69 (s, 3H, CH₃-18), 0.97 (s, 3H, CH₃-19), 0.98 (d, J = 6.1 Hz, 3H, CH₃-21), 3.26 (bs, 2H, CH₂), 3.67 (s, 3H), 4.00 (bs, 1H); ¹³C NMR (50 MHz, CDCl₃): δ 12.6, 17.2, 23.2, 23.5, 25.8, 26.4, 27.3, 28.8, 29.4, 30.8, 30.9, 30.9, 32.7, 34.3, 34.9, 35.1, 35.6, 37.6, 46.4, 47.2, 51.4, 48.2, 62.8, 72.2, 73.0, 174.6; Anal. Calcd for C₂₆H₄₃N₃O₄: C, 67.65; H, 9.39; N, 9.10; Found: C, 67.32; H, 9.17; N, 8.93; MS (LCMS) m/z : 478.47 (M + 1).

Methyl (3 α -azidomethyl)-3 β ,7 α , 12 α -trihydroxy-5 β -cholan-24-oate (36): White solid, Yield: 90%; mp 178-179 °C; IR (cm⁻¹): 1728, 2106, 3477; ¹H NMR (200 MHz, CDCl₃): δ 0.71 (s, 3H, CH₃-18), 0.96 (s, 3H, CH₃-19), 0.98 (d, J = 6.1 Hz, 3H, CH₃-21), 3.25 (bs, 2H, CH₂), 3.67 (s, 3H), 3.86 (bs, 1H), 4.00 (bs, 1H); ¹³C NMR (50 MHz, CDCl₃): δ 12.4, 17.2, 22.5, 23.1, 25.6, 27.5, 28.4, 29.4, 30.7, 30.9, 31.0, 34.1, 34.9, 35.3, 37.1, 38.0, 39.2, 41.9, 46.5, 47.2, 51.5, 62.9, 68.4, 72.1, 73.2, 174.8; Anal. Calcd for C₂₆H₄₃N₃O₅: C, 65.38; H, 9.07; N, 8.80; Found: C, 65.12; H, 9.17; N, 8.73; MS (LCMS) m/z : 478.47 (M + 1).

Methyl (3 α -aminomethyl)-3 β ,12 α -dihydroxy-5 β -cholan-24-oate (37) and Methyl (3 α -aminomethyl)-3 β ,7 α , 12 α -trihydroxy-5 β -cholan-24-oate (38):

To a solution of **35** or **36** in methanol (20mL) was added (5 mol%) Pd/C catalyst. The hydrogenation was carried out using Parr apparatus at 40-45 psi at 30°C temperature for 3h. The reaction mixture was filtered and the filtrate was concentrated and dried under vacuum to obtain the compounds **37** (98%) and **38** (97%) respectively.

Methyl (3 α -aminomethyl)-3 β ,12 α -dihydroxy-5 β -cholan-24-oate (37): White solid, Yield: 98%; mp 158-159 °C; IR (cm⁻¹): 1729, 3410; ¹H NMR (400 MHz, CDCl₃): δ 0.69 (s, 3H, CH₃-18), 0.97 (s, 3H, CH₃-19), 0.98 (d, J = 6.1 Hz, 3H, CH₃-21), 2.58 (bs, 2H, CH₂),

3.67 (s, 3H), 3.99 (bs, 1H); ^{13}C NMR (100 MHz, CDCl_3): δ 12.7, 17.3, 23.3, 23.5, 25.9, 26.6, 27.4, 28.9, 29.6, 30.8, 30.9, 31.3, 32.8, 34.5, 35.0, 35.6, 35.8, 37.9, 46.4, 47.3, 48.3, 51.5, 52.8, 70.9, 73.1, 174.7; Anal. Calcd for $\text{C}_{26}\text{H}_{45}\text{N}_3\text{O}_4$: C, 71.68; H, 10.41; N, 3.22; Found: C, 71.39; H, 10.27; N, 3.05; MS (LCMS) m/z : 436.30 ($M + 1$).

Methyl (3 α -aminomethyl)-3 β ,7 α , 12 α -trihydroxy-5 β -cholan-24-oate (38): White solid, Yield: 97%; mp 181-184 °C; IR (cm^{-1}): 1731, 3418; ^1H NMR (400 MHz, CDCl_3): δ 0.69 (s, 3H, CH_3 -18), 0.94 (s, 3H, CH_3 -19), 0.97 (d, $J = 6.1$ Hz, 3H, CH_3 -21), 2.59 (bs, 2H), 3.66 (s, 3H), 3.84 (bs, 1H), 3.96 (bs, 1H); ^{13}C NMR (100 MHz, CDCl_3): δ 12.4, 17.3, 22.6, 23.1, 25.7, 27.5, 28.5, 29.6, 30.8, 31.0, 31.1, 34.3, 34.7, 35.3, 37.3, 38.5, 39.3, 41.8, 46.5, 47.2, 51.4, 57.6, 68.5, 70.9, 73.1, 174.7; Anal. Calcd for $\text{C}_{26}\text{H}_{45}\text{NO}_5$: C, 69.14; H, 10.04; N, 3.10; Found: C, 68.77; H, 9.80; N, 3.01; MS (LCMS) m/z : 452.32 ($M + 1$).

N1-(Boc)-1,2-diaminoethane:

To a solution of 1,2 diaminoethane (10 g, 0.17 mol) in dioxane:water (1:1, 200mL) 1N NaOH (10 mL) was added. The reaction mixture stirred and cooled in an ice bath. Di-*tert*-butyl dicarbonate (Boc anhydride) (2.4 g, 11 mmol) was added at 0-10 °C during 30 min. and stirring was continued for 8h at 0-10°C. The resulting solution was concentrated to 100 mL the N1,N2-di-Boc derivative not being soluble in water, precipitated and it was removed by filtration. The N1-mono-Boc derivative was obtained by repeated extraction of the filtrate in ethyl acetate. Removal of solvent yielded the mono-Boc-diaminoethane (60%)

^1H NMR (200 MHz, CDCl_3): δ 5.21 (bs, 1H, NH), 3.32 (t, $J = 8$ Hz, 2H), 2.54 (t, $J = 8$ Hz, 2H), 1.42 (s, 9H).

Synthesis of bile acid-ethylenediamine conjugates 41 and 42:

To a solution of compound **37** (0.1 g, 0.23 mmol) in dry methanol (10 mL) was added N1-(Boc)-1,2-diaminoethane (0.2 mL, 3 mmol). Reaction mixture was refluxed for 2 h. Then it was cooled to room temperature, methanol was evaporated under reduced pressure to obtain crude product **39**. BOC deprotection was carried out without purification using 15% trifluoroacetic acid (TFA) in dichloromethane and neutralization of salt with 50% DIPEA in dichloromethane to obtain crude product. Purification by column chromatography using neutral alumina and (MeOH:DCM:Liquor ammonia;

10:85:0.5) to gave pure compound **41** in 74% yield after two step. Using similar reaction conditions we synthesized compound **42** from **38** through intermediate **40** in 71% yield.

Bile acid-ethylenediamine conjugates (41): White solid, mp 121-123 °C; $[\alpha]_D^{25} = + 49.8$ (CHCl₃, c 0.44); IR (cm⁻¹): 1724, 1733; ¹H NMR (400 MHz, CDCl₃): δ 0.68 (s, 3H, CH₃-18), 0.95 (s, 3H, CH₃-19), 0.97 (d, $J = 6.1$ Hz, 3H, CH₃-21), 2.52 (bs, 2H), 2.72 (t, $J = 5.77$ Hz, 2H), 2.81 (t, $J = 5.8$ Hz, 2H), 3.66 (s, 3H), 3.98 (bs, 1H); ¹³C NMR (100 MHz, CDCl₃): δ 12.6, 17.2, 23.3, 23.5, 25.9, 26.6, 27.4, 28.9, 30.3, 30.8, 31.0, 31.3, 32.7, 34.4, 35.0, 35.7, 36.2, 37.8, 41.1, 46.4, 47.1, 48.2, 51.4, 52.2, 60.7, 70.8, 72.9, 174.7; MS (LCMS) m/z : 479.37 (M + 1), 501.34 (M + 23 for Na).

Bile acid-ethylenediamine conjugates (42): White solid, Yield: 71%; mp 161-163 °C; $[\alpha]_D^{25} = + 43.3$ (CHCl₃, c 0.40); IR (cm⁻¹): 1724, 1733; ¹H NMR (400 MHz, CDCl₃): δ 0.70 (s, 3H, CH₃-18), 0.95 (s, 3H, CH₃-19), 0.98 (d, $J = 6.1$ Hz, 3H, CH₃-21), 2.52 (bs, 2H), 2.72 (t, $J = 5.3$ Hz, 2H), 2.81 (t, $J = 5.3$ Hz, 2H), 3.66 (s, 3H), 3.86 (bs, 1H), 3.98 (bs, 1H); ¹³C NMR (100 MHz, CDCl₃): δ 12.5, 17.3, 23.6, 23.2, 25.8, 27.5, 28.6, 29.3, 30.4, 30.9, 31.1, 31.4, 34.3, 35.0, 35.3, 37.4, 39.1, 39.4, 41.1, 41.9, 46.6, 47.2, 51.5, 60.7, 68.5, 70.7, 73.1, 174.7; MS (LCMS) m/z : 495.67 (M + 1), 517.63 (M + 23 for Na).

2.2.7 Selected Spectra

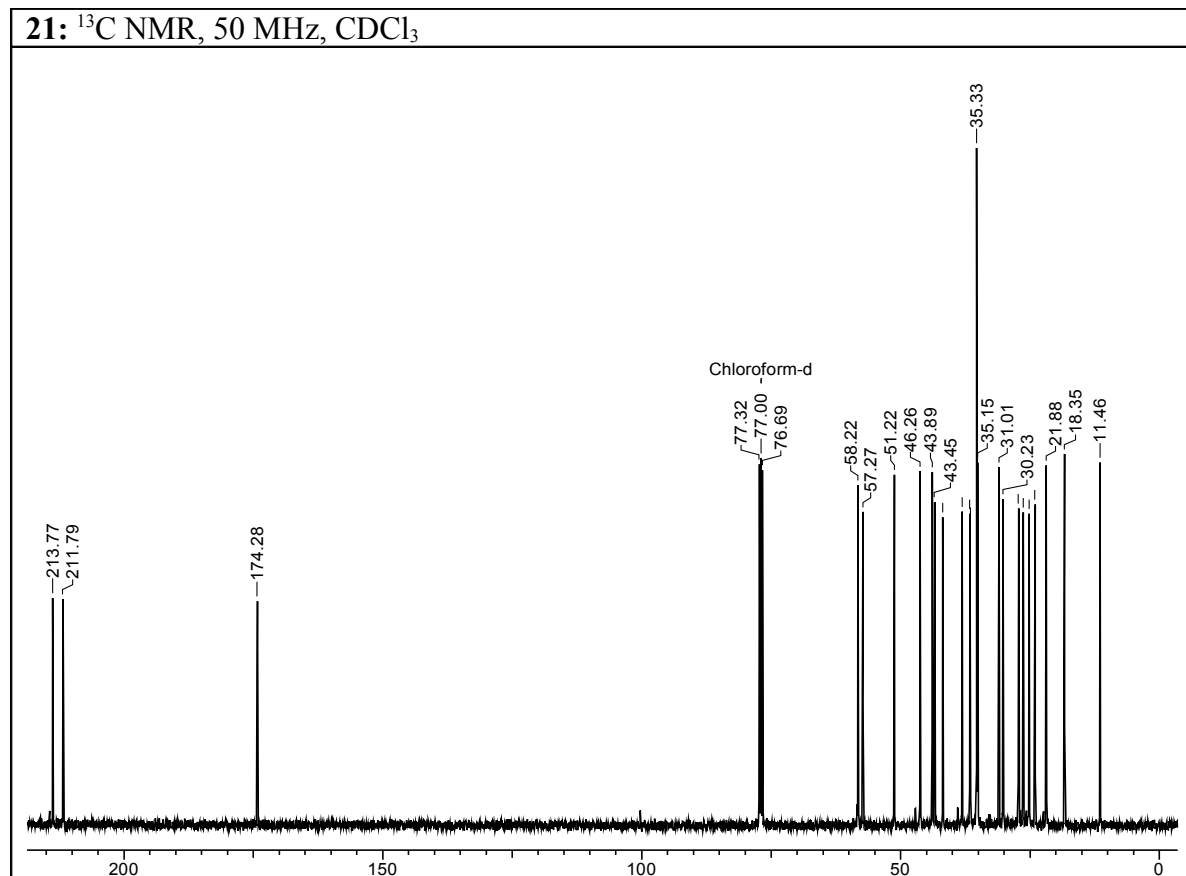
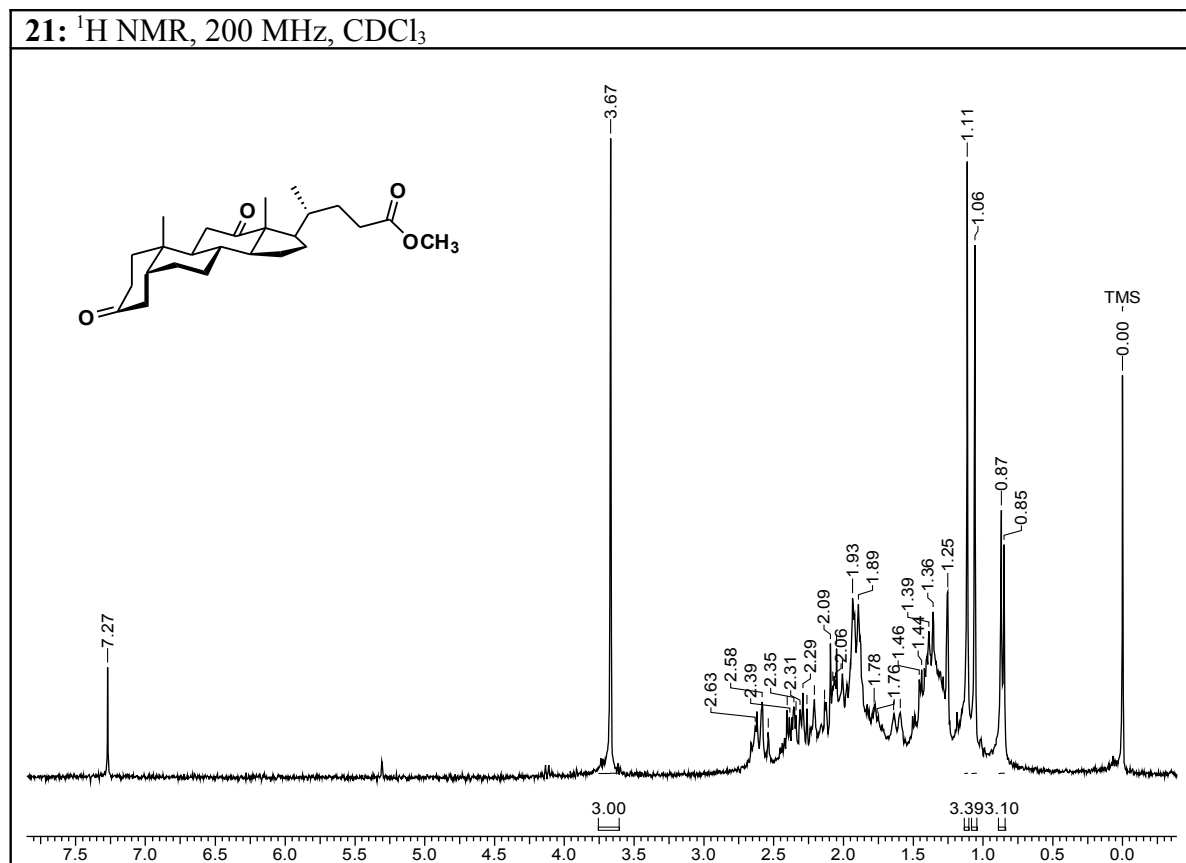

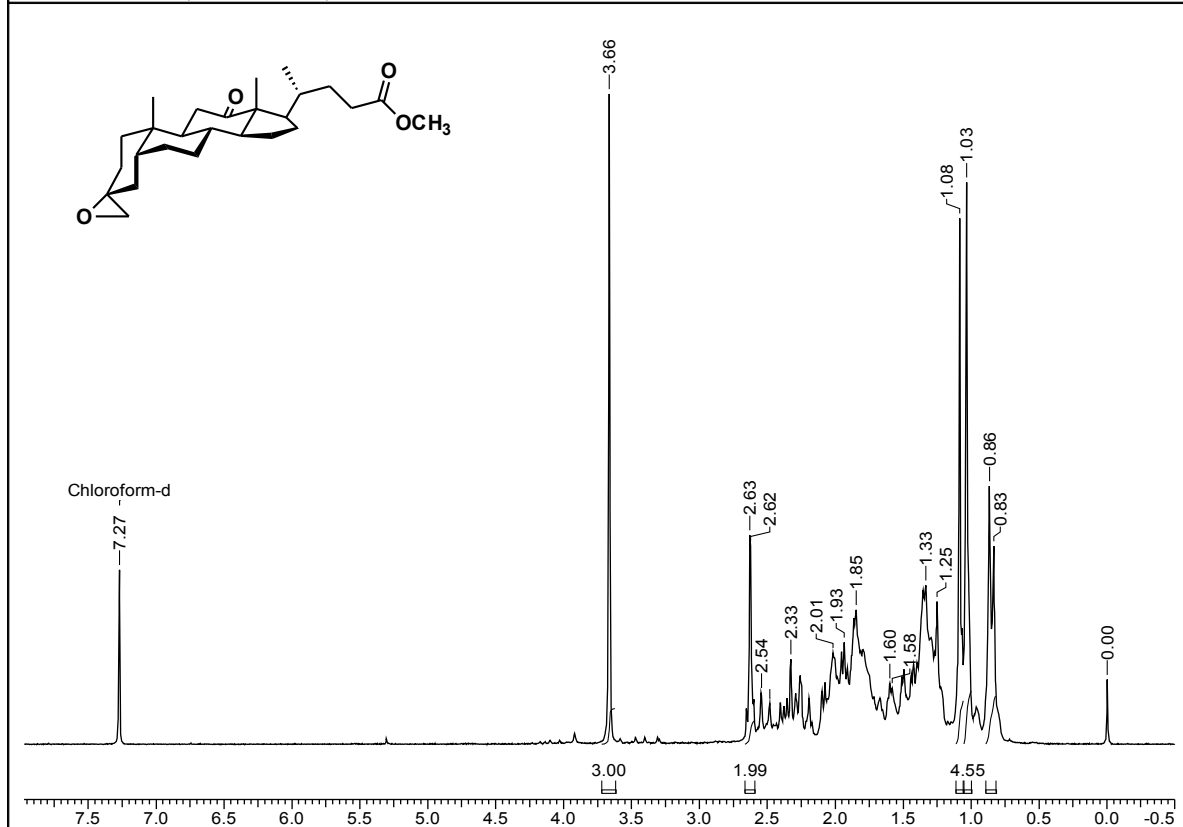
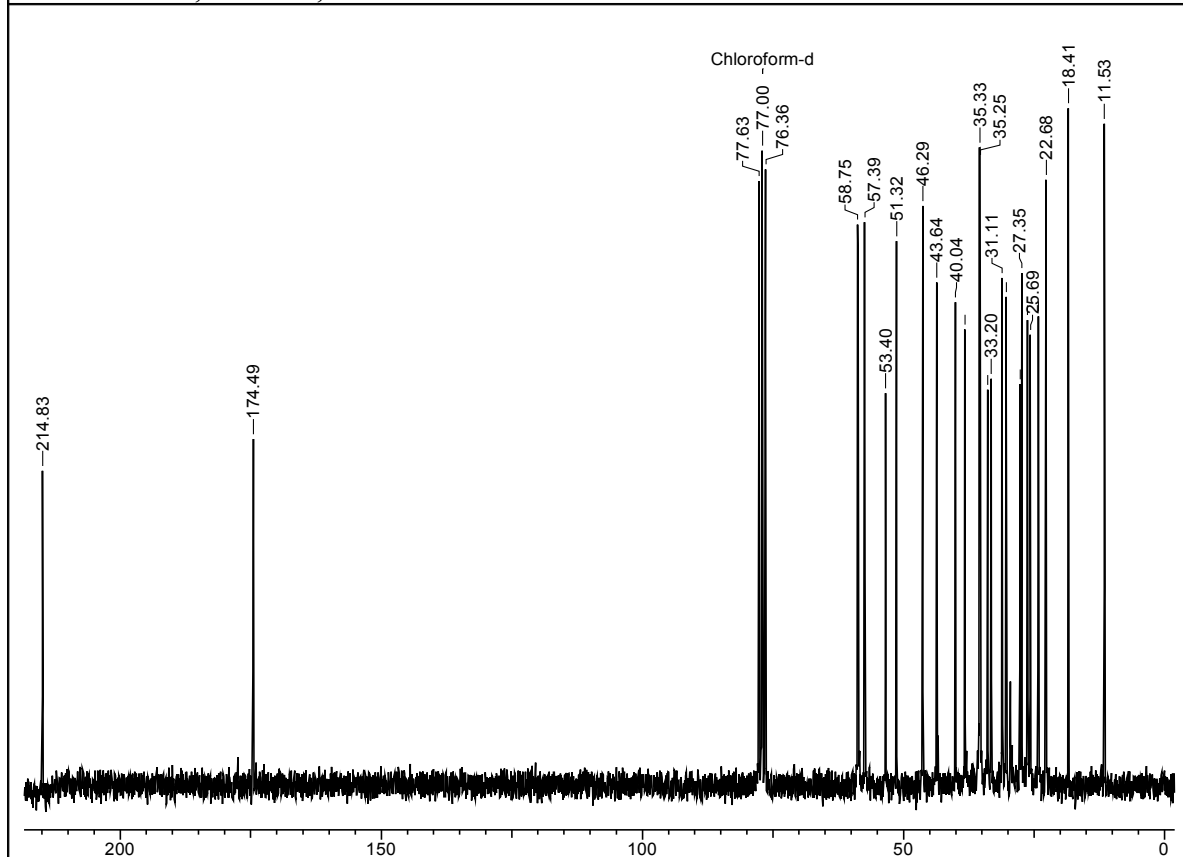
23: ^1H NMR, 200 MHz, CDCl_3 **23:** ^{13}C NMR, 50 MHz, CDCl_3 

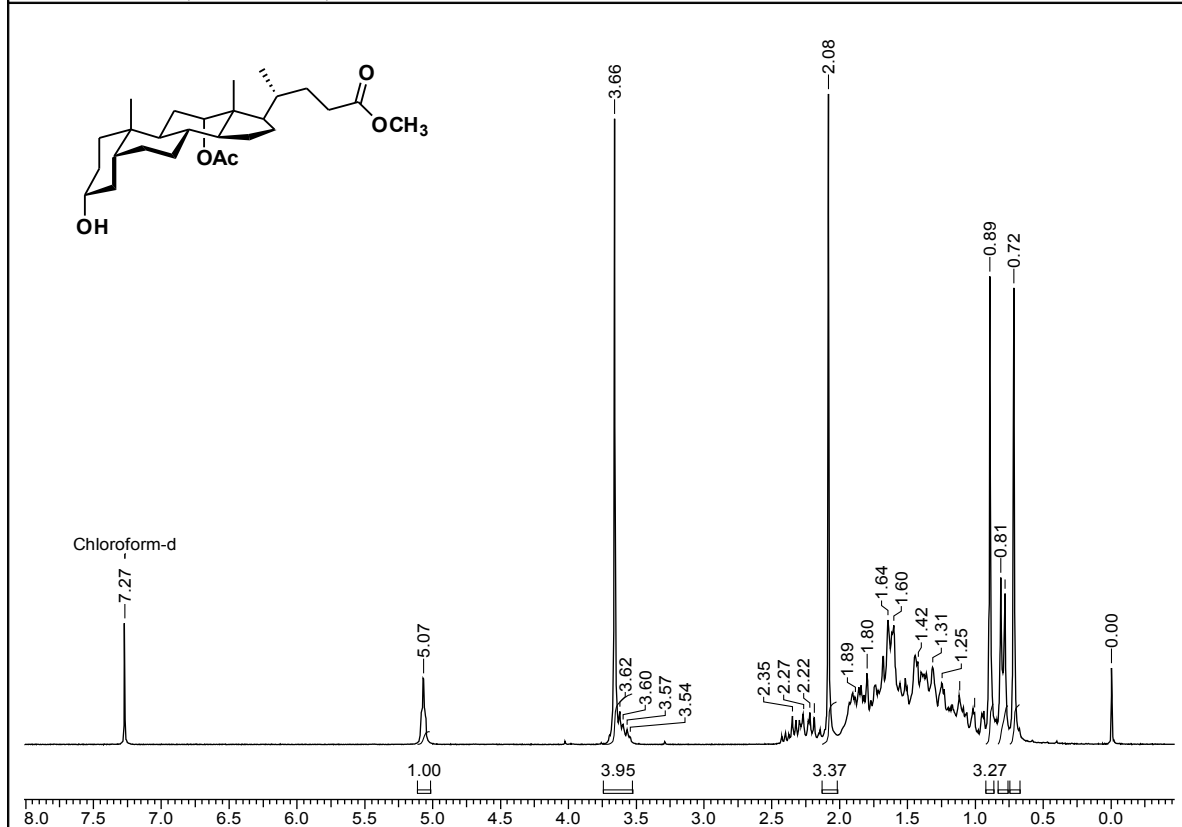
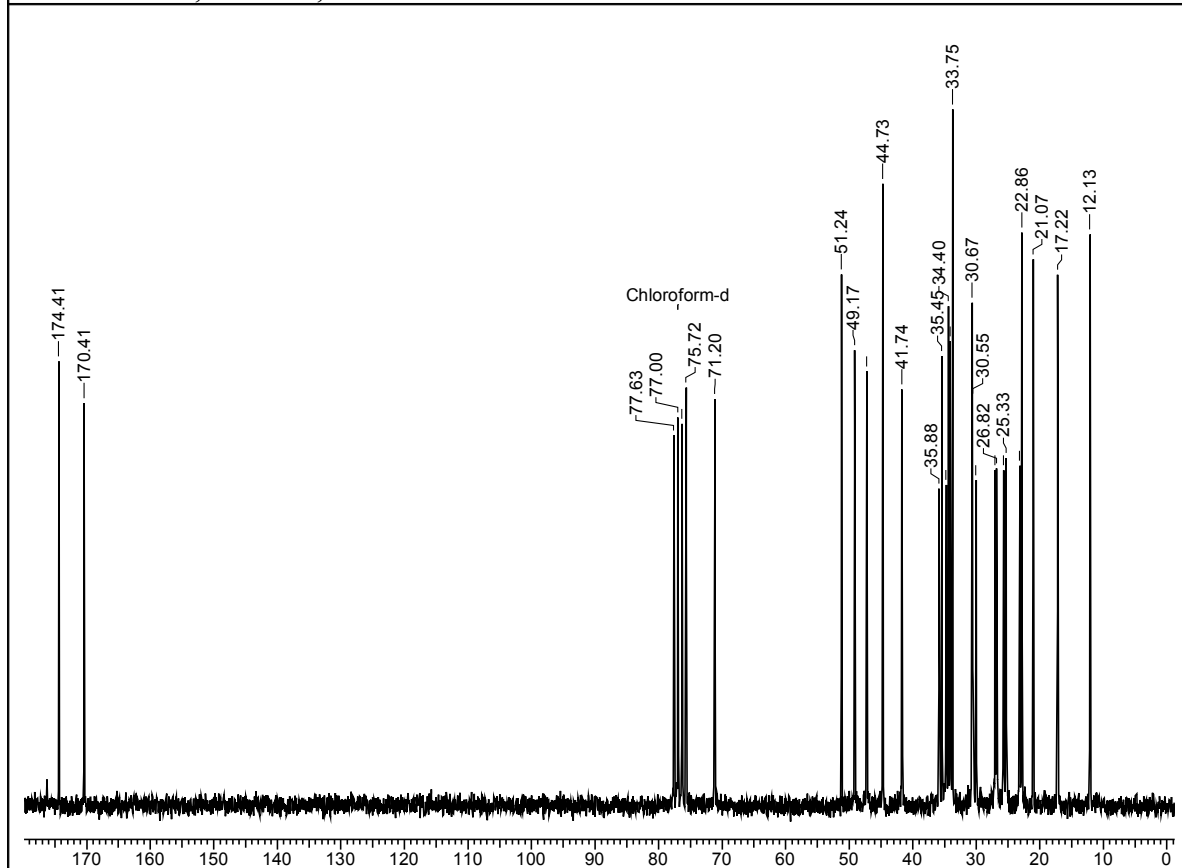
25: ^1H NMR, 200 MHz, CDCl_3 **25:** ^{13}C NMR, 50 MHz, CDCl_3 

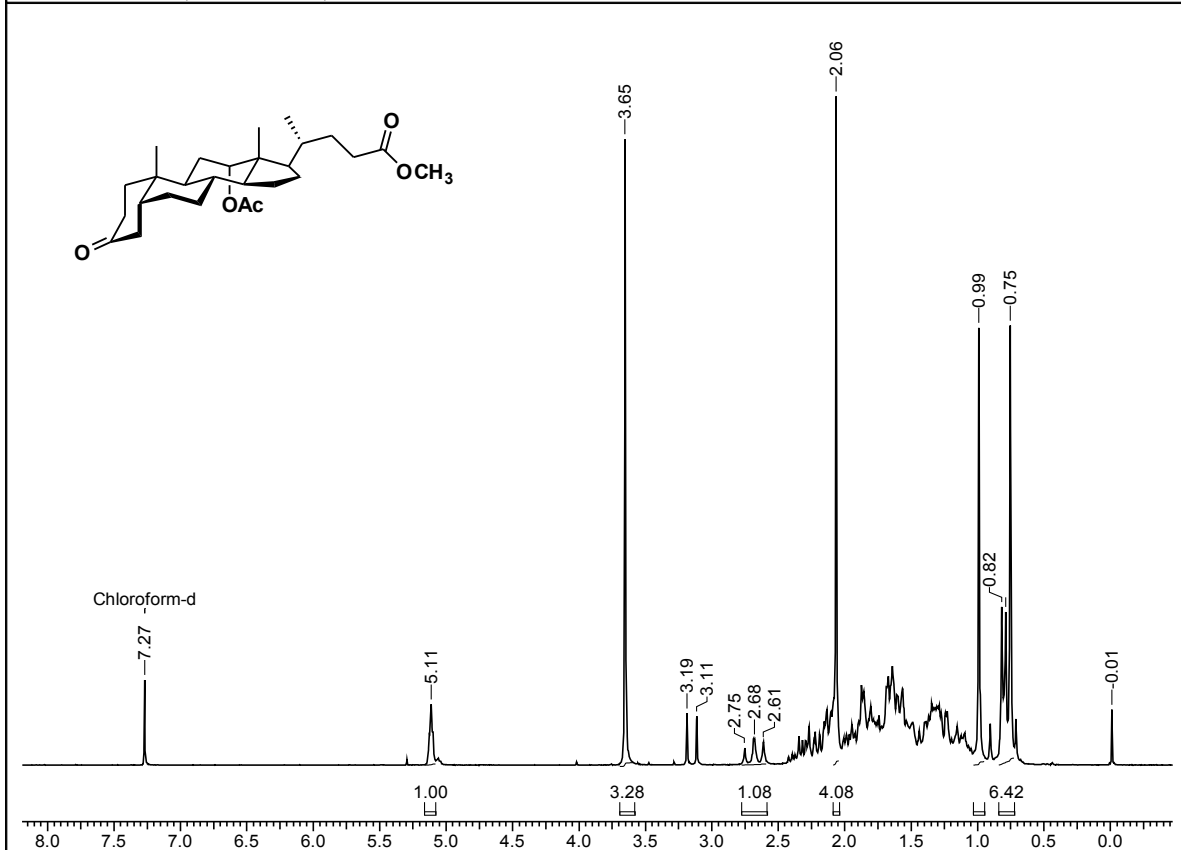
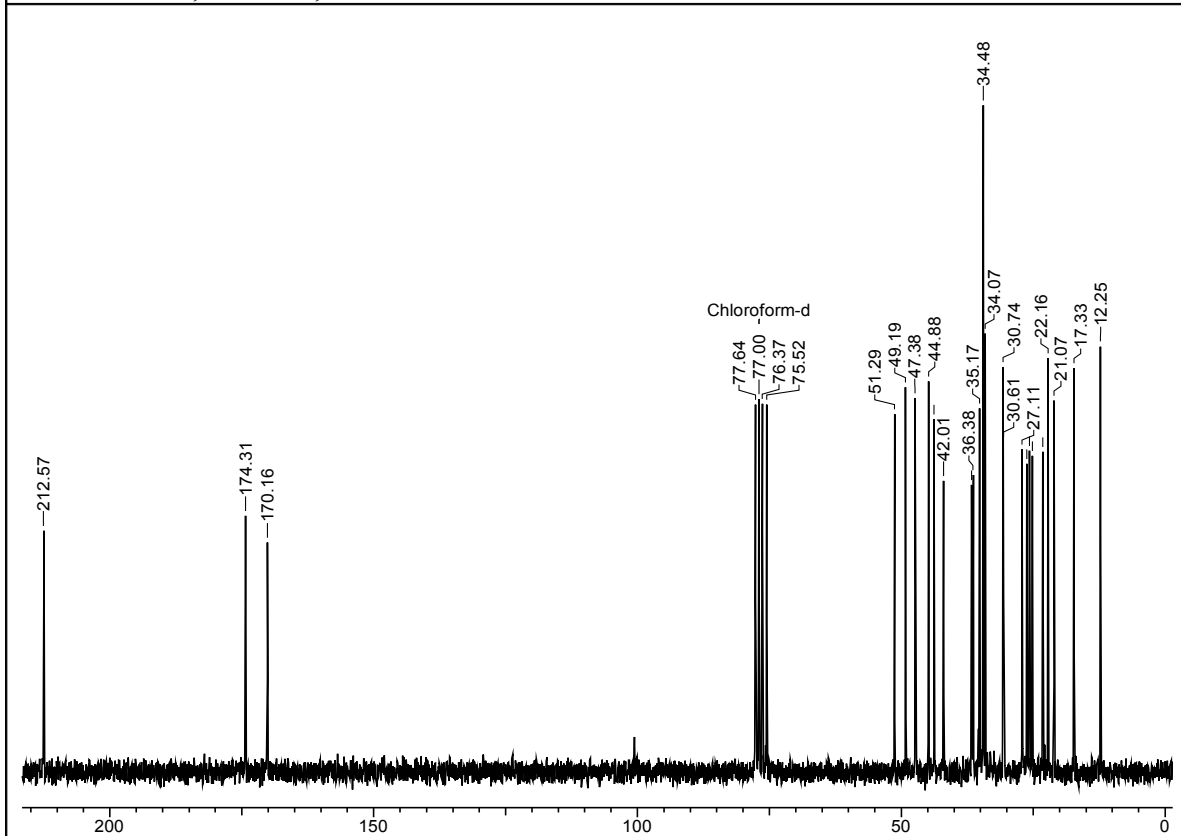
27: ^1H NMR, 200 MHz, CDCl_3 **27:** ^{13}C NMR, 50 MHz, CDCl_3 

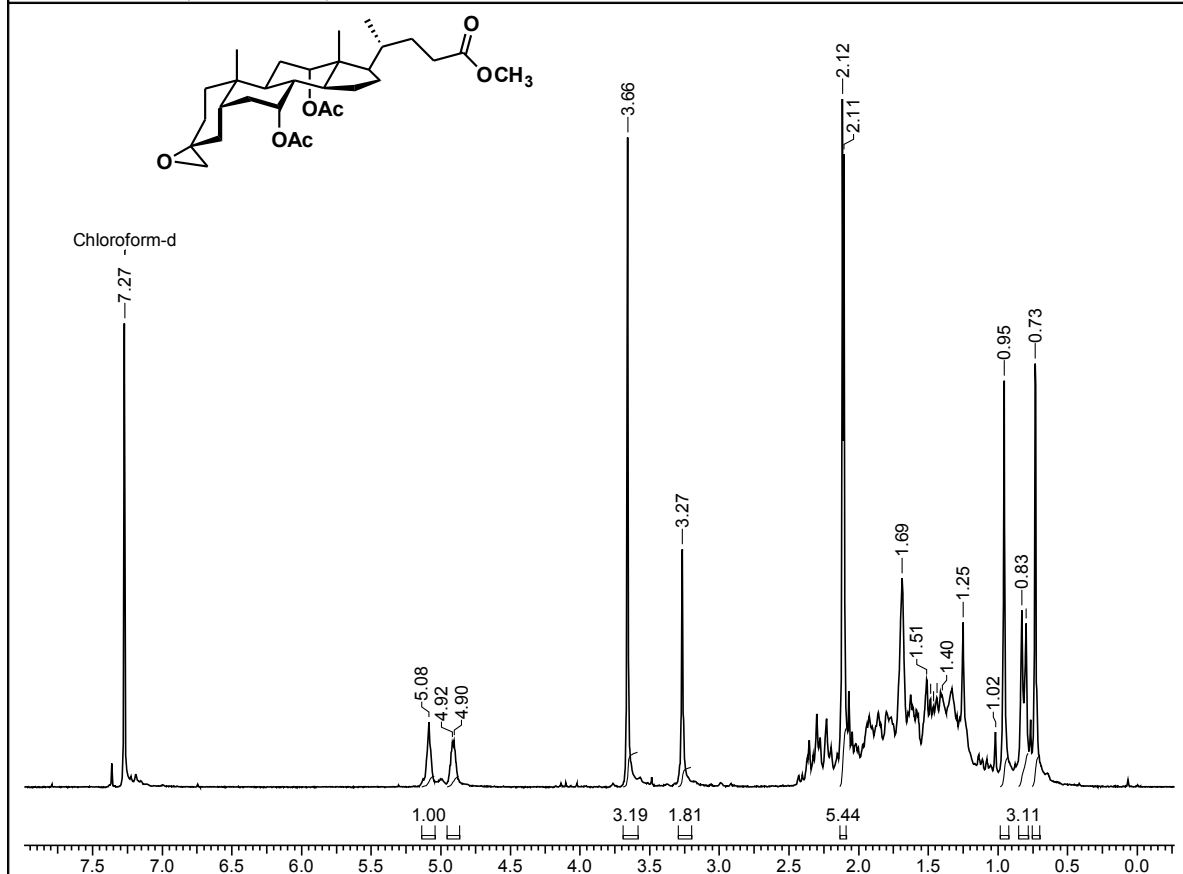
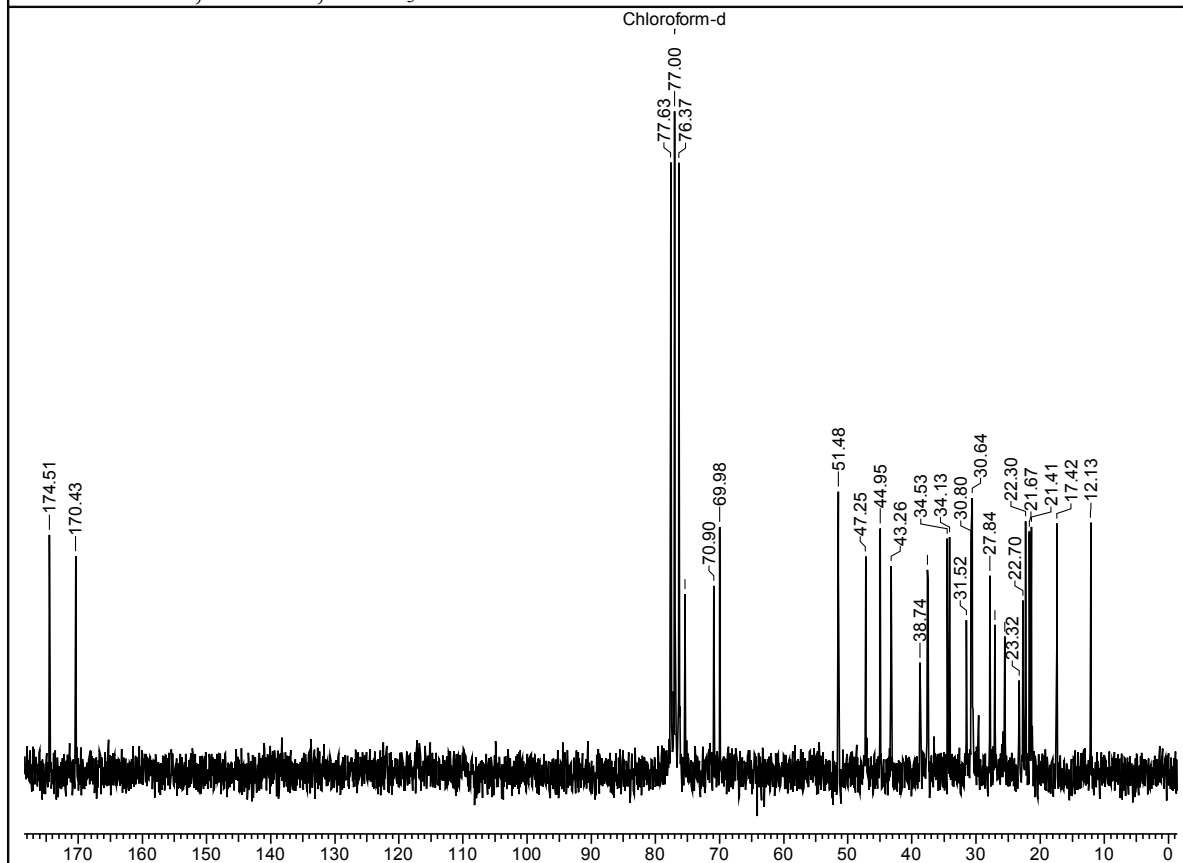
30: ^1H NMR, 200 MHz, CDCl_3 **30:** ^{13}C NMR, 50 MHz, CDCl_3 

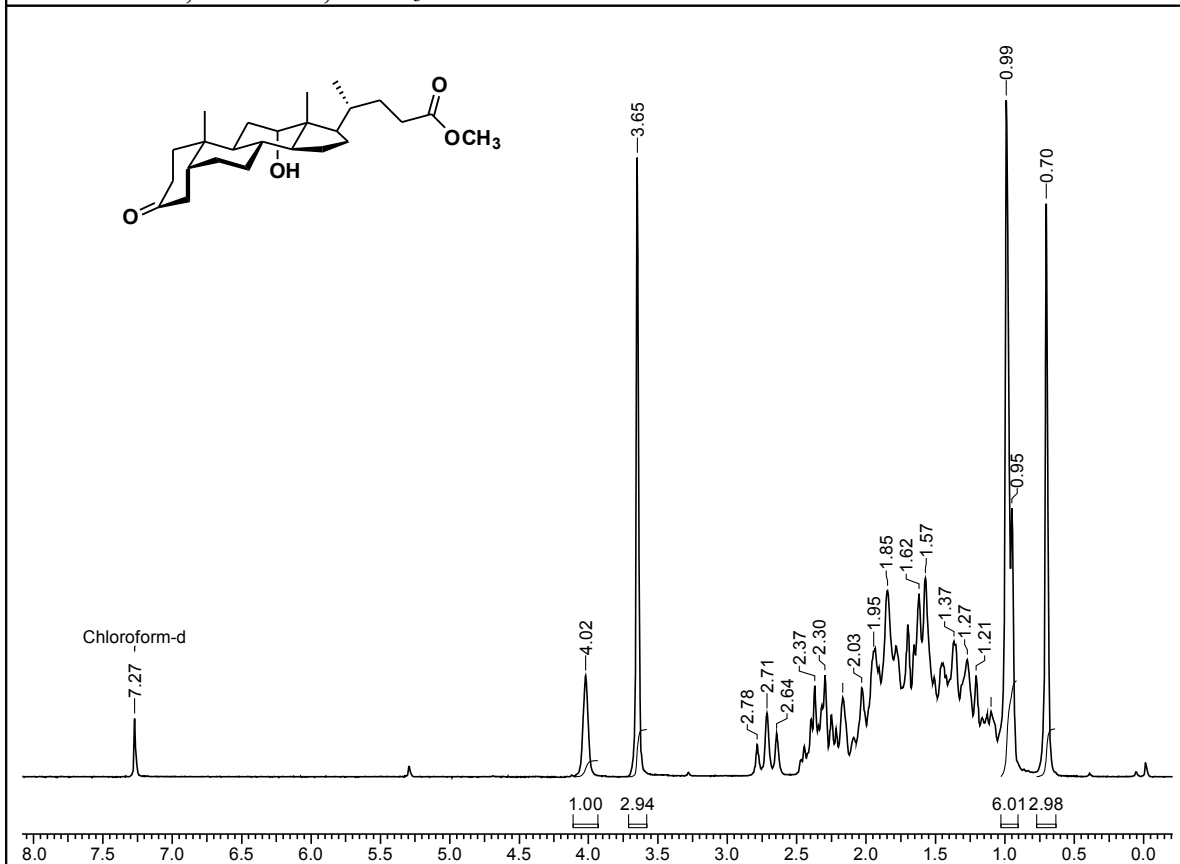
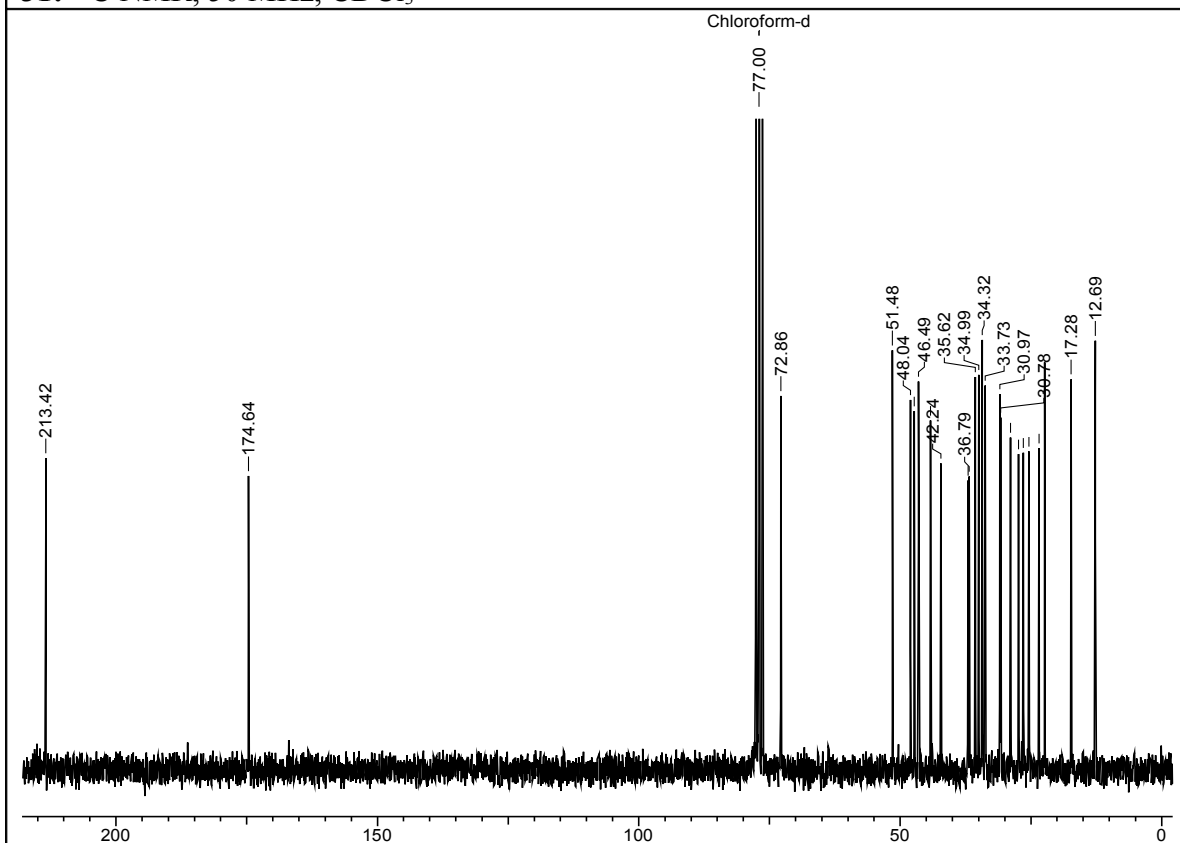
31: ^1H NMR, 200 MHz, CDCl_3 **31:** ^{13}C NMR, 50 MHz, CDCl_3 

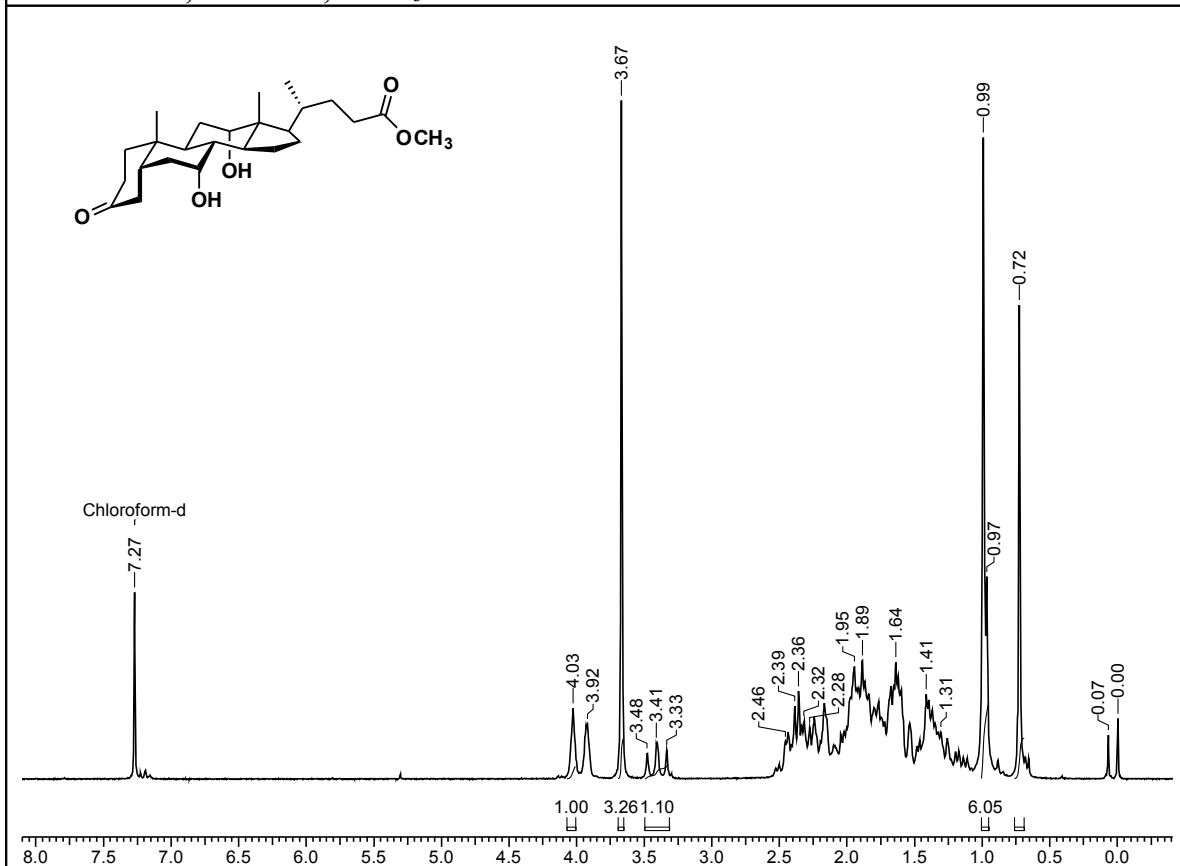
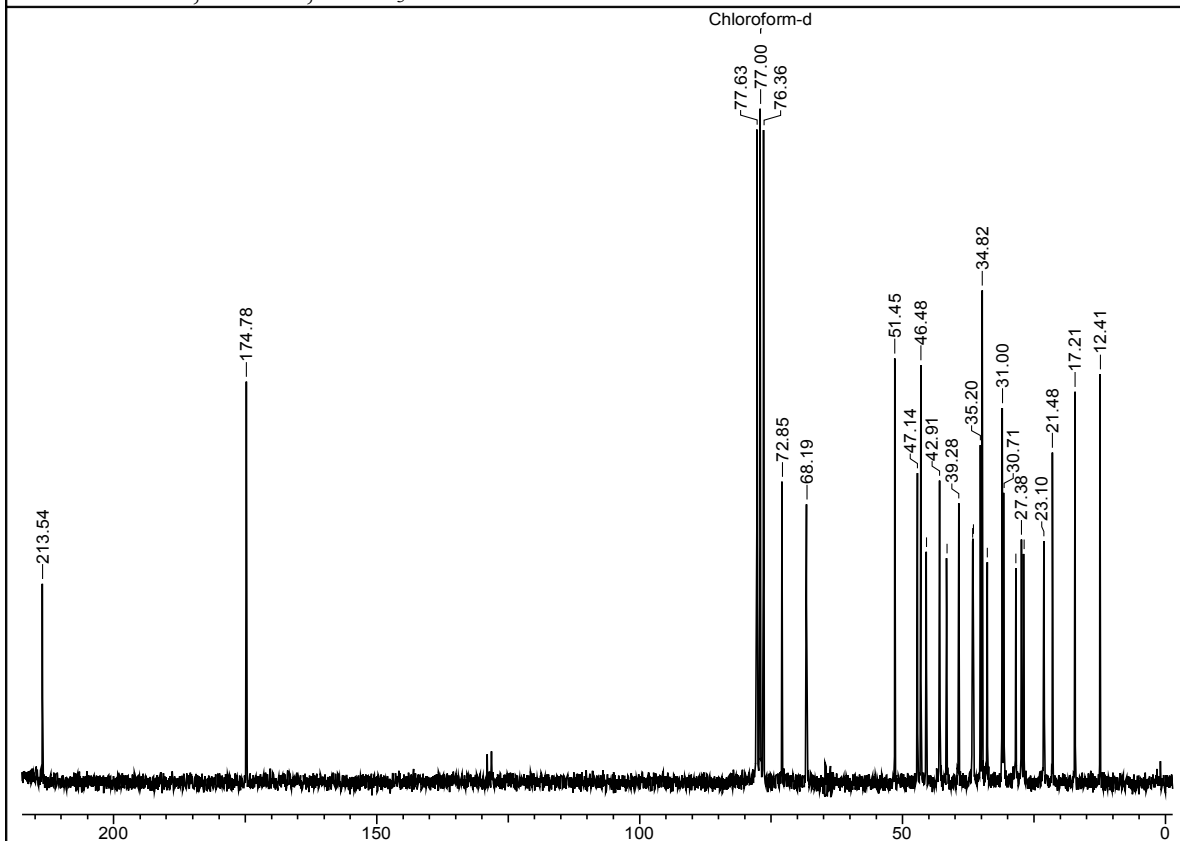
32: ^1H NMR, 200 MHz, CDCl_3 **32:** ^{13}C NMR, 50MHz, CDCl_3 

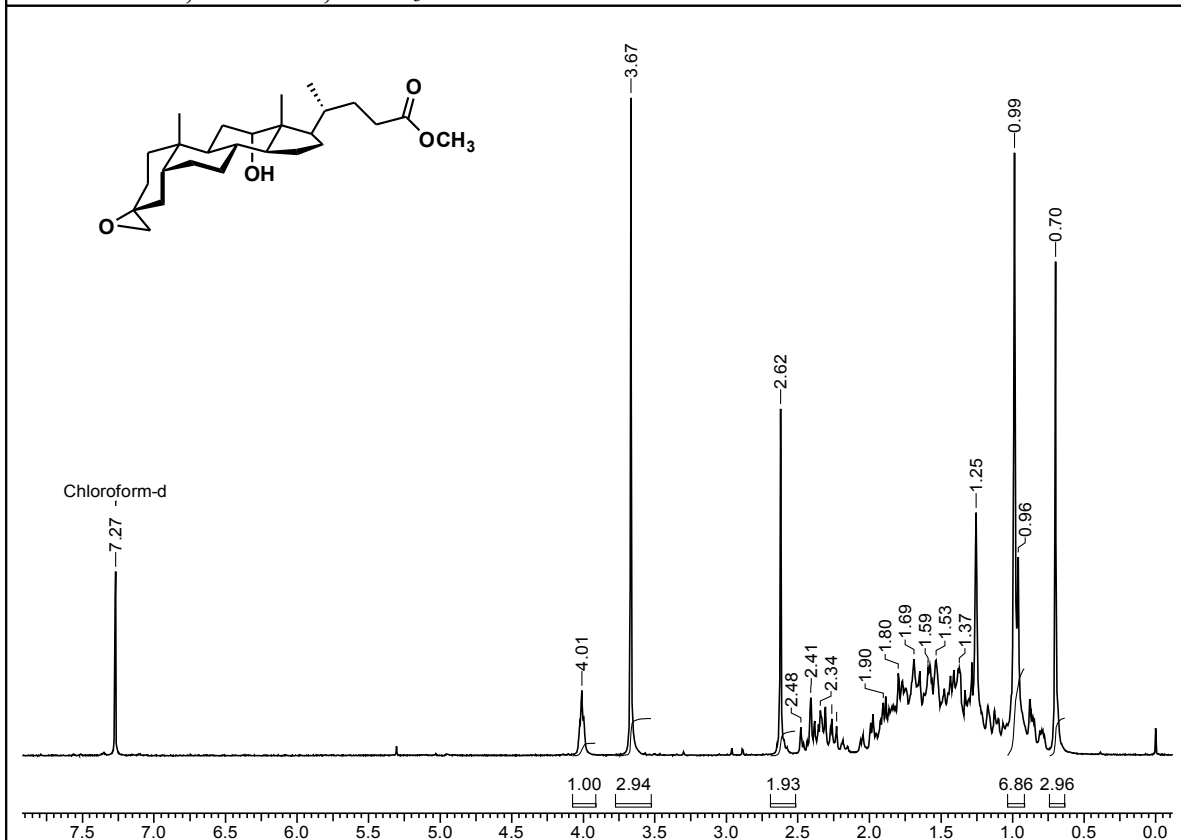
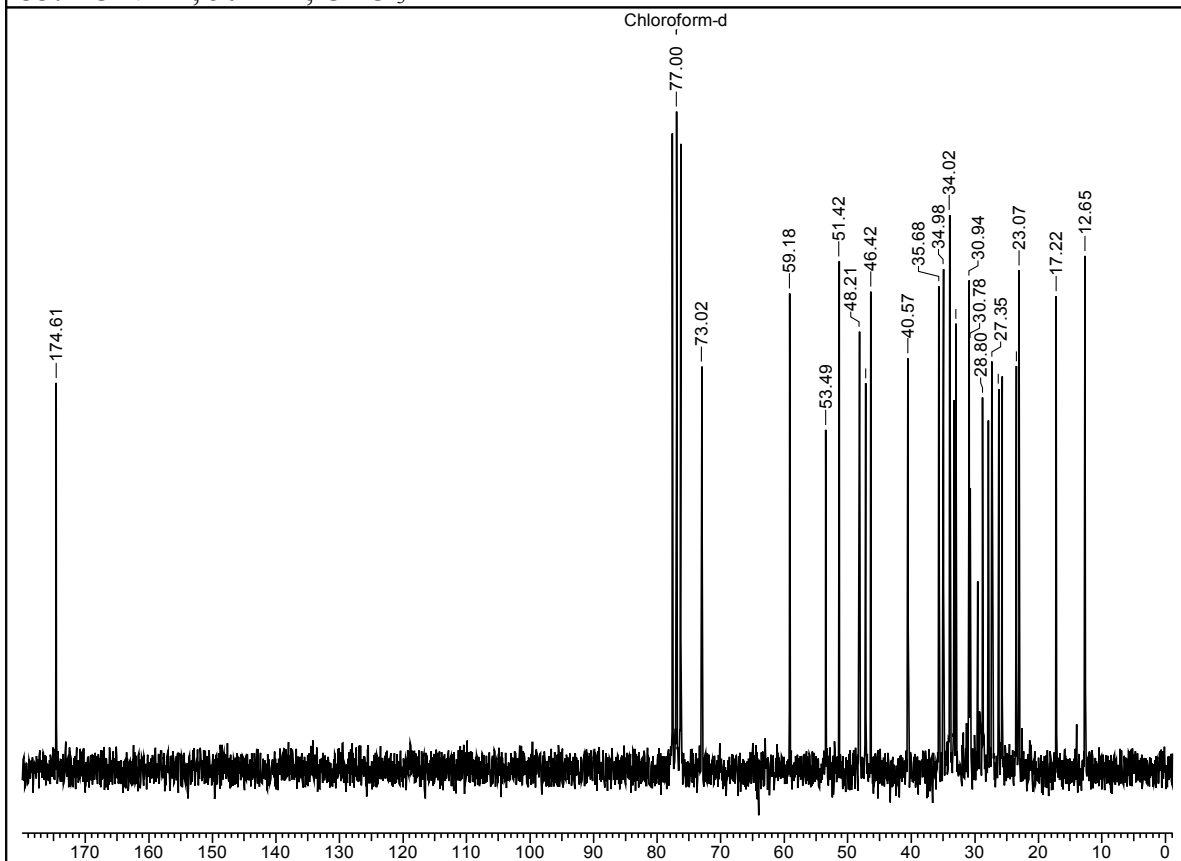
33: ^1H NMR, 200 MHz, CDCl_3 **33:** ^{13}C NMR, 50MHz, CDCl_3 

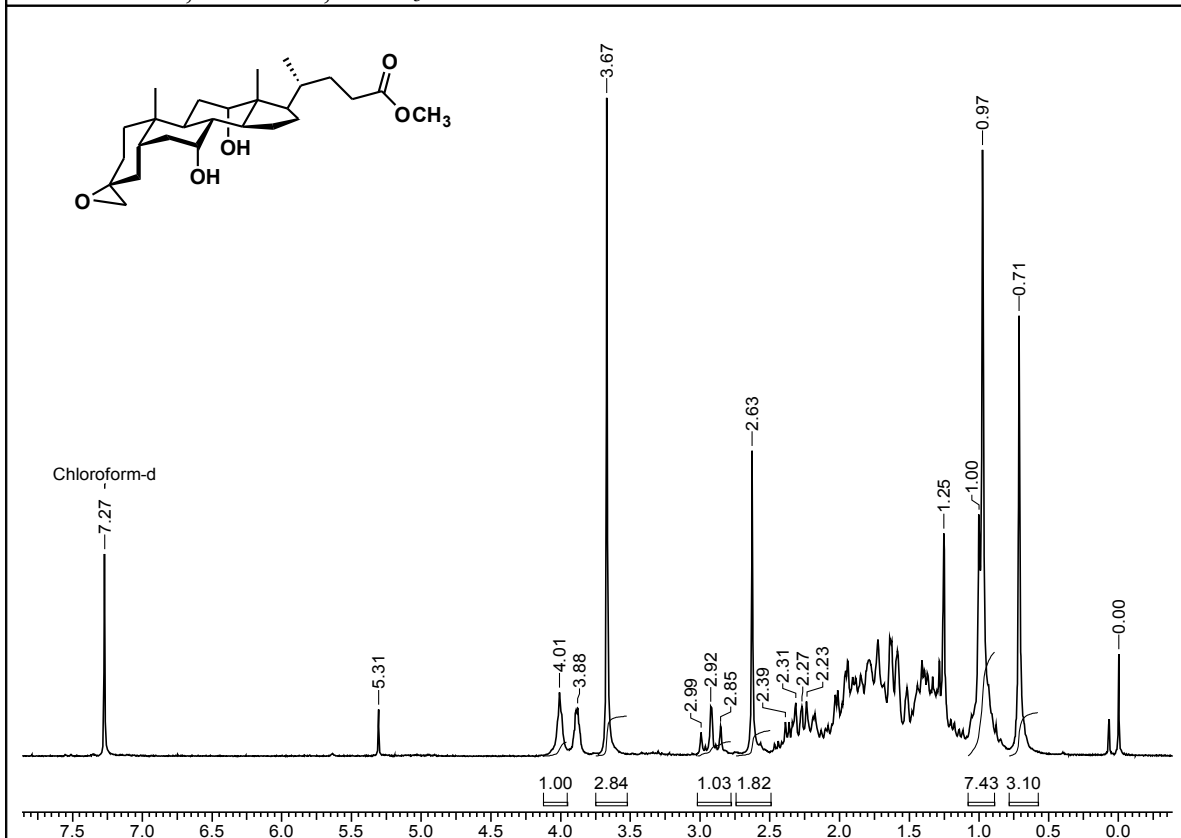
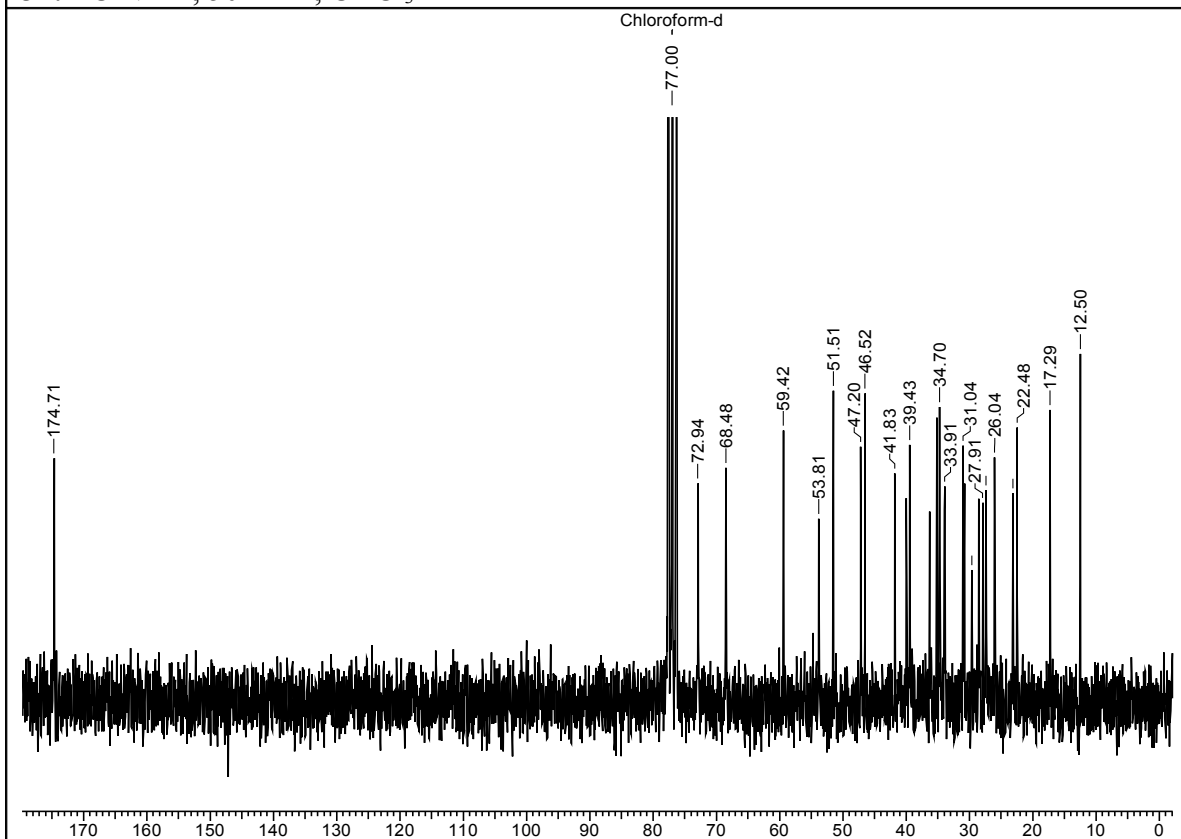
34: ^1H NMR, 200 MHz, CDCl_3 **34:** ^{13}C NMR, 50 MHz, CDCl_3 

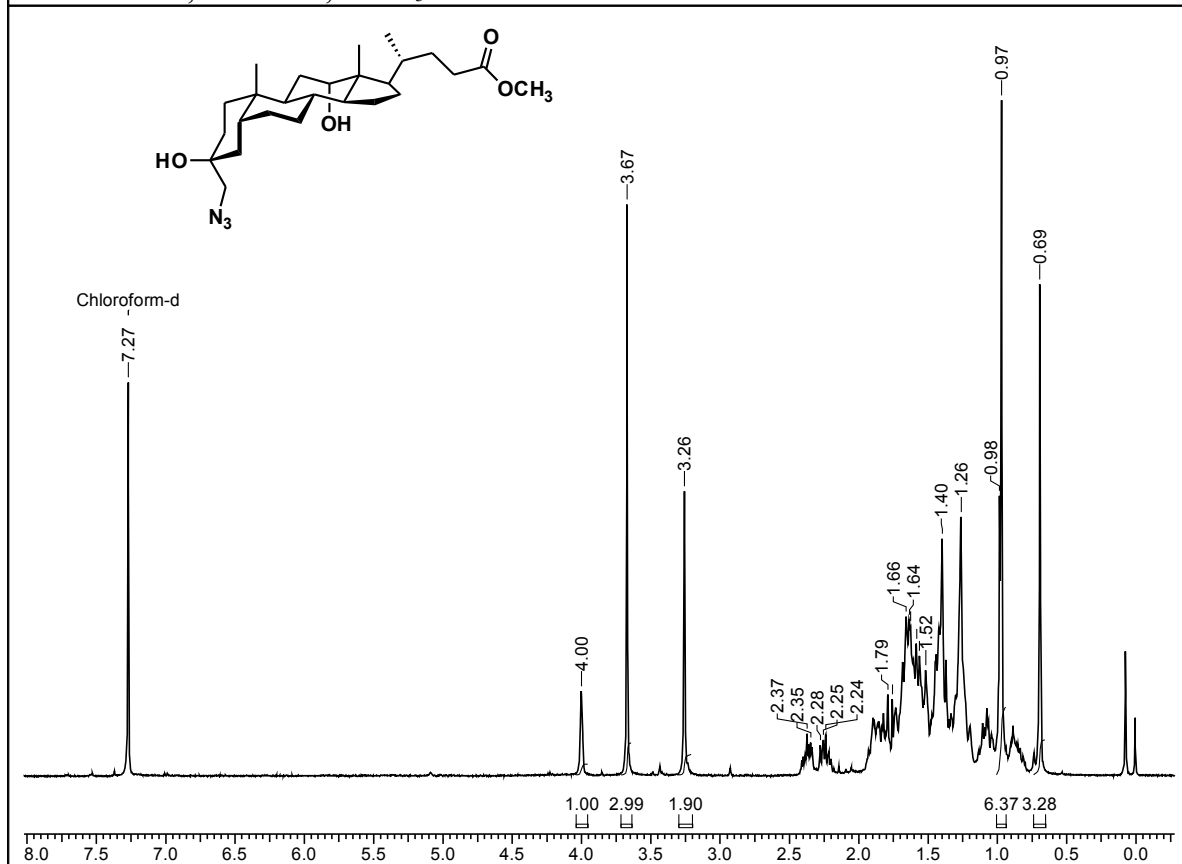
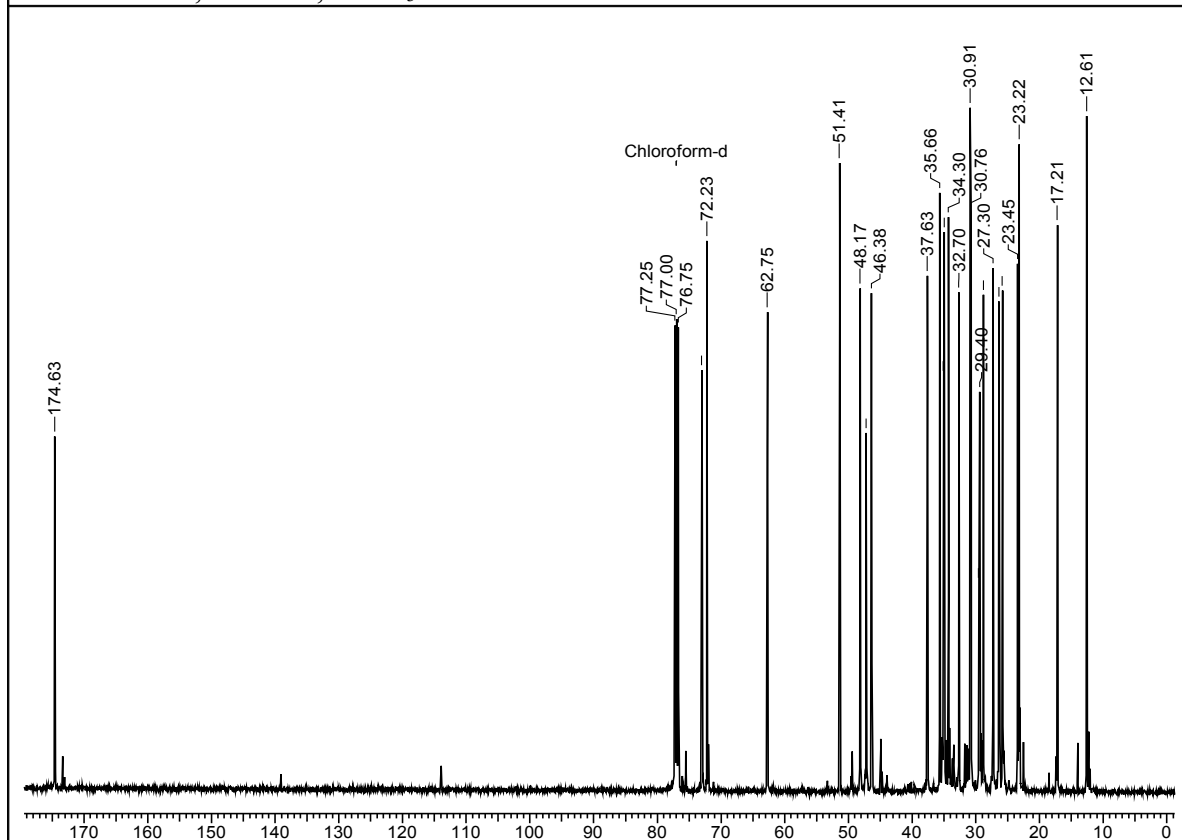
35: ^1H NMR, 200 MHz, CDCl_3 **35:** ^{13}C NMR, 50 MHz, CDCl_3 

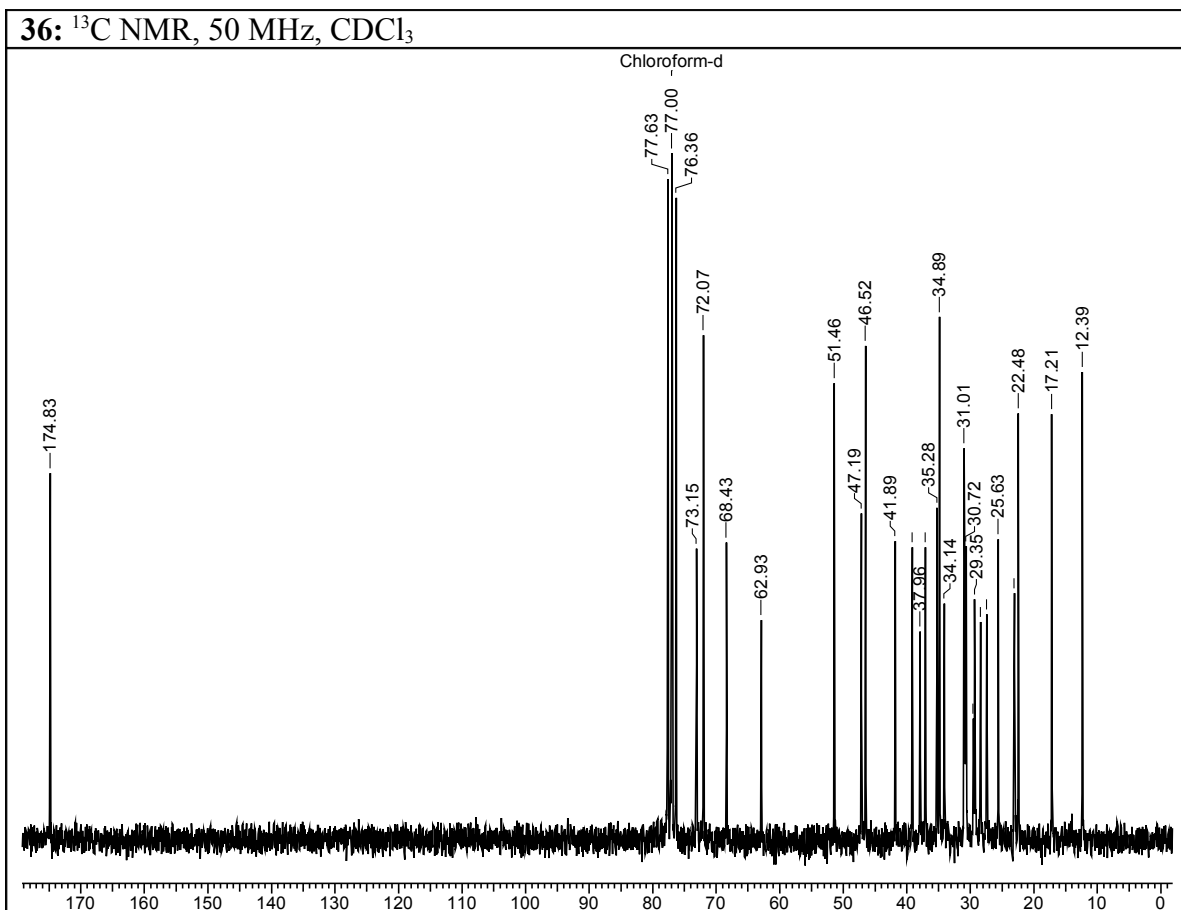
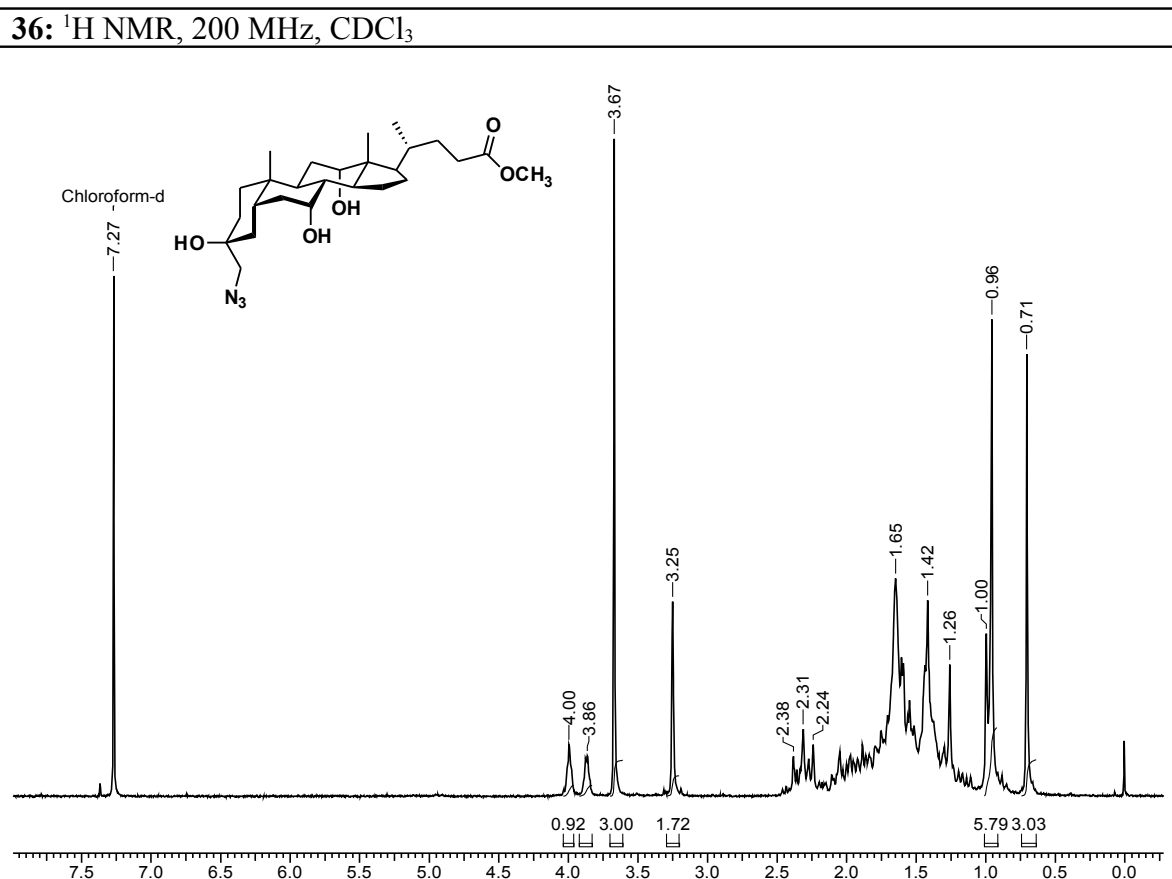

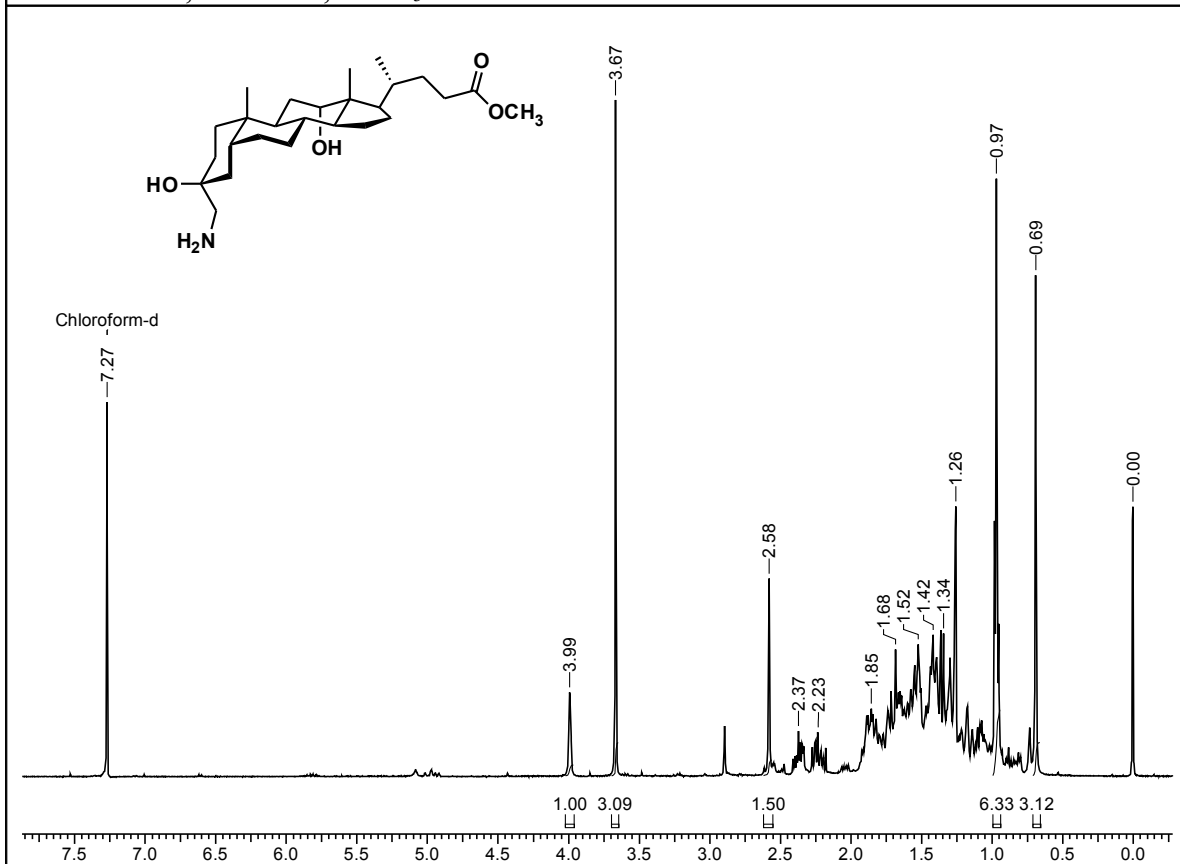
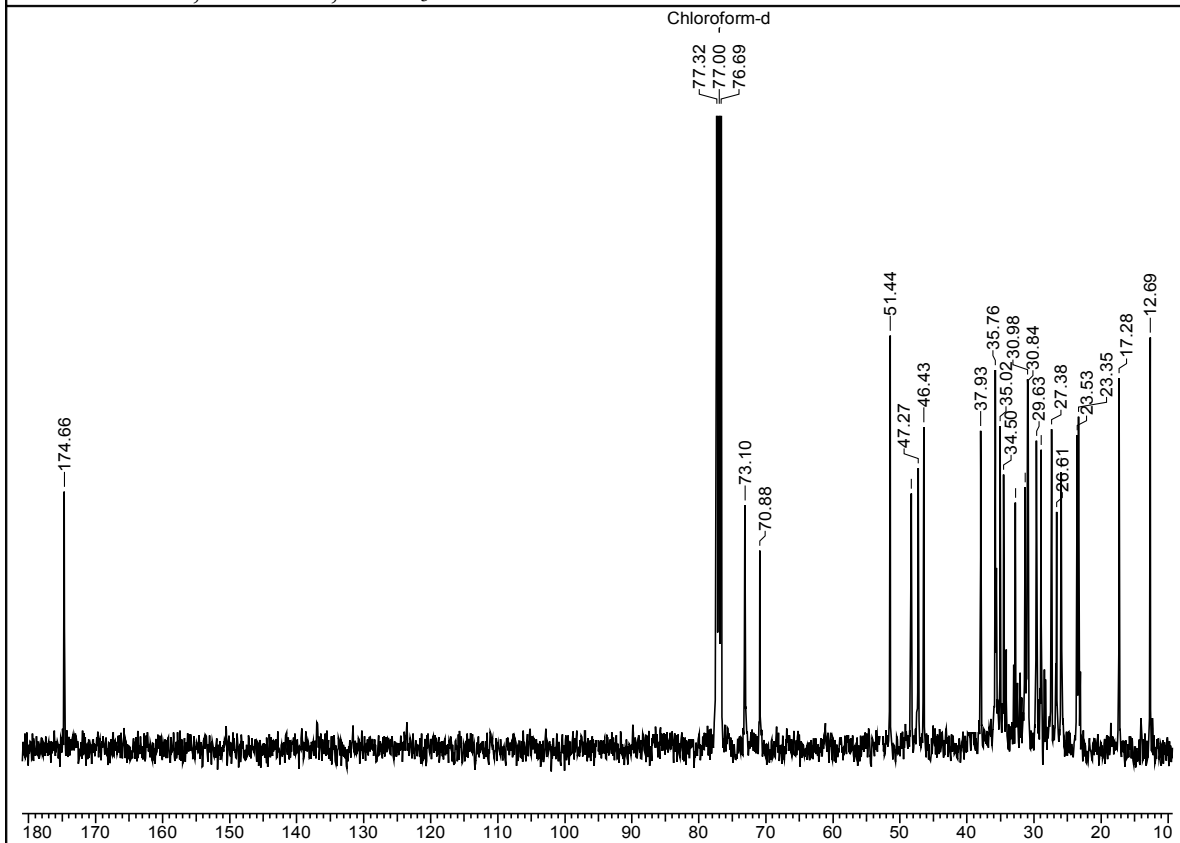
37: ^1H NMR, 400 MHz, CDCl_3 **37:** ^{13}C NMR, 100 MHz, CDCl_3 

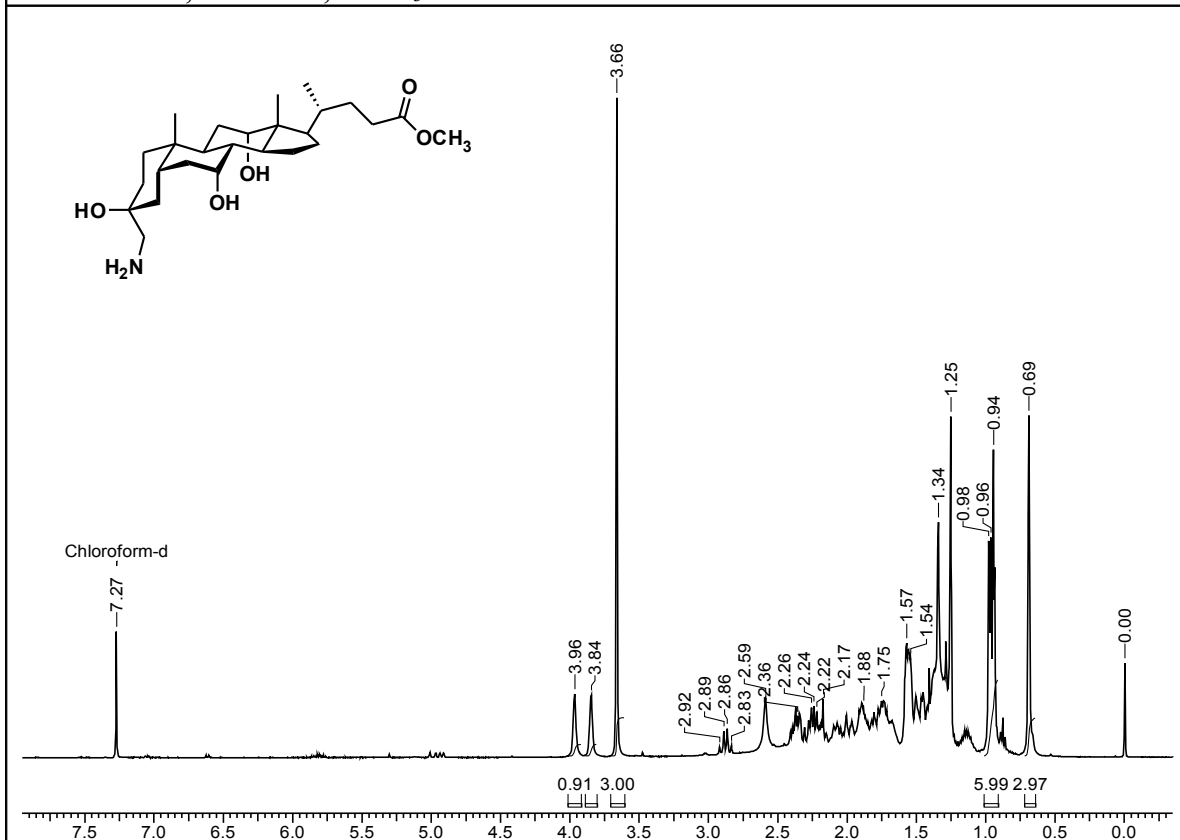
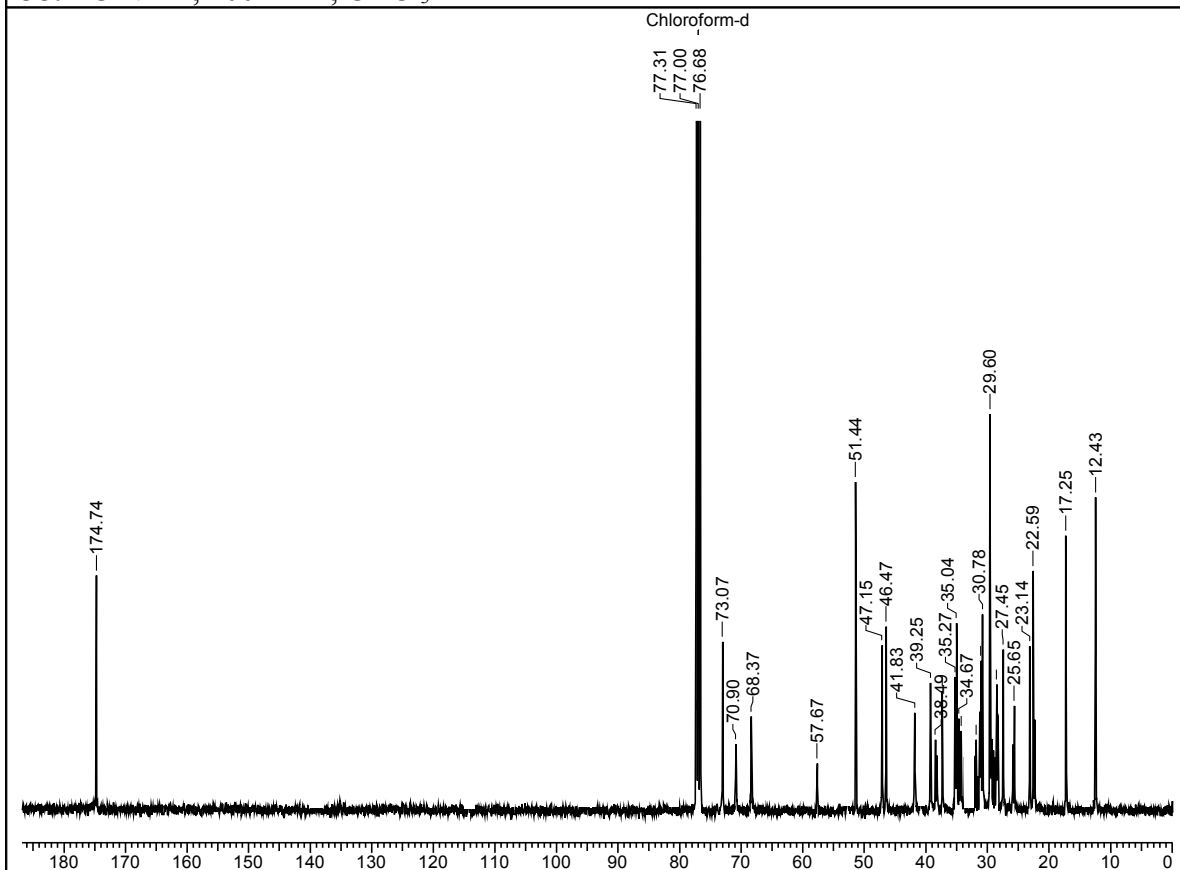
38: ^1H NMR, 400 MHz, CDCl_3 **38:** ^{13}C NMR, 100 MHz, CDCl_3 

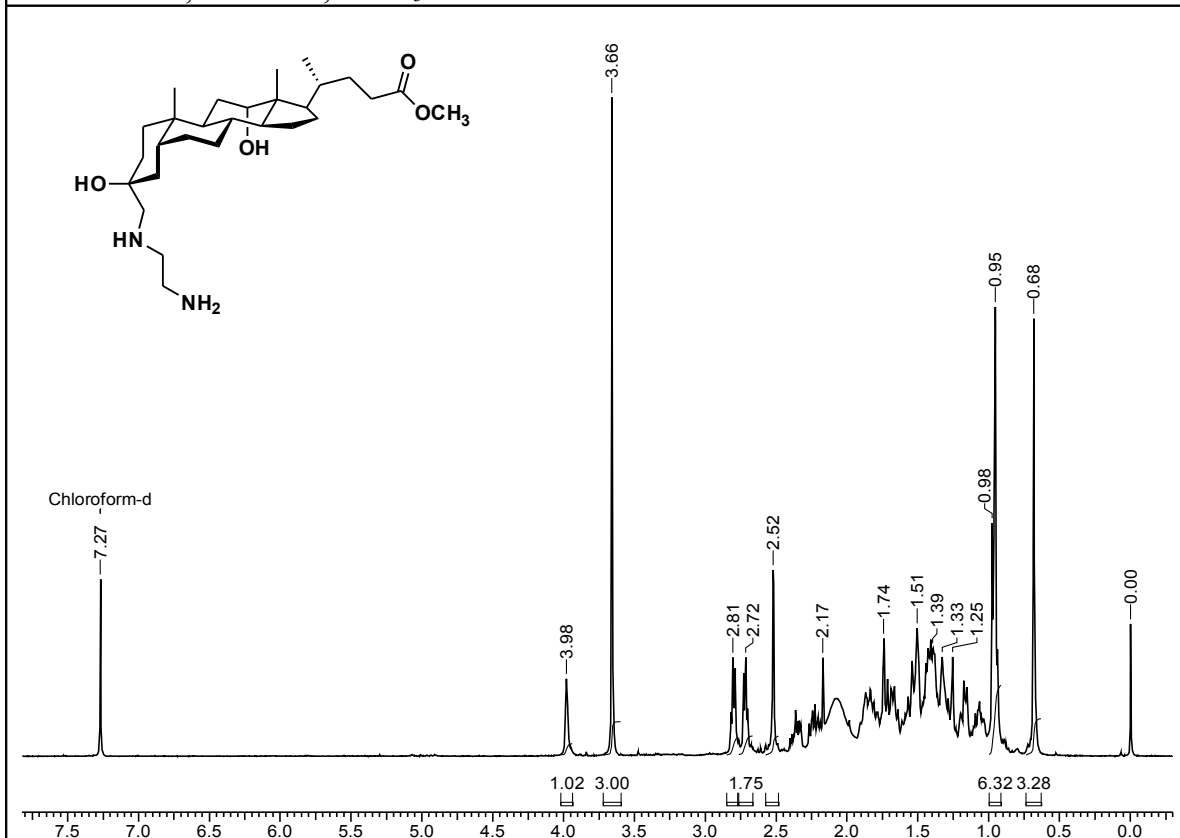
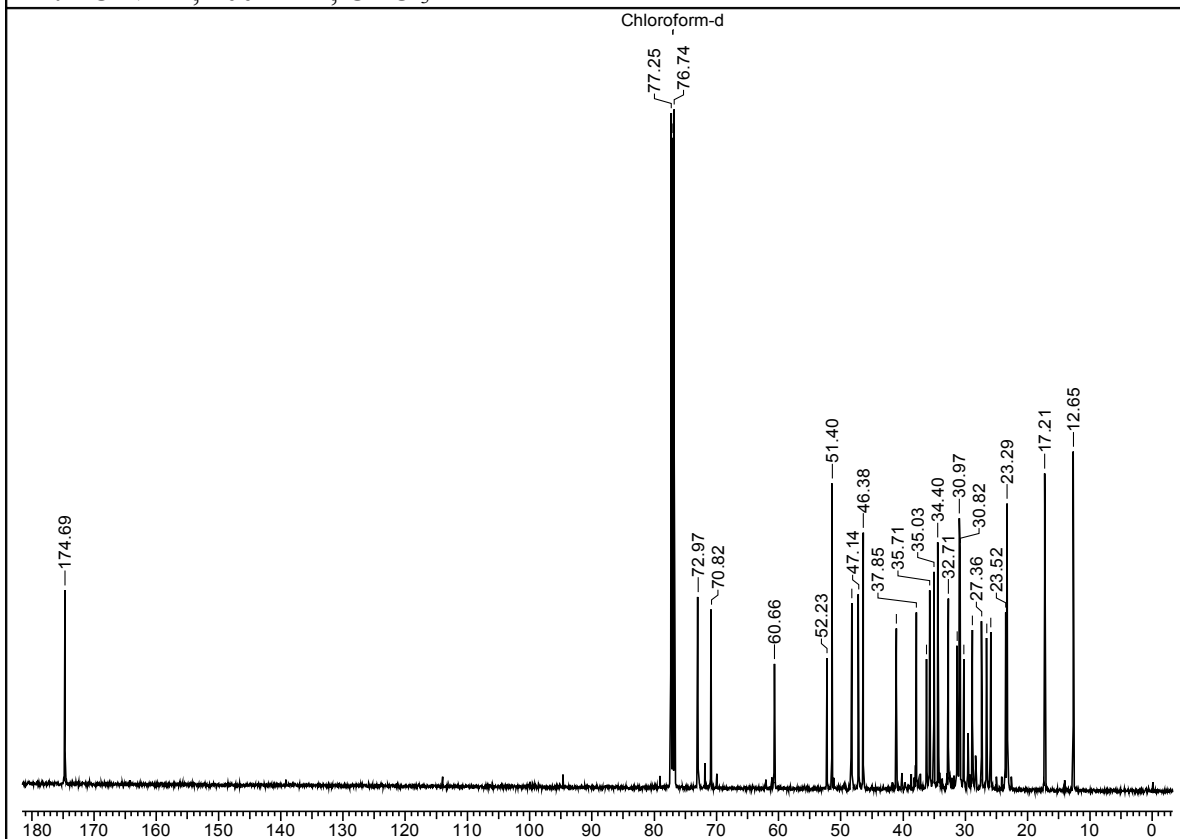
41: ^1H NMR, 400 MHz, CDCl_3 **41:** ^{13}C NMR, 100 MHz, CDCl_3 

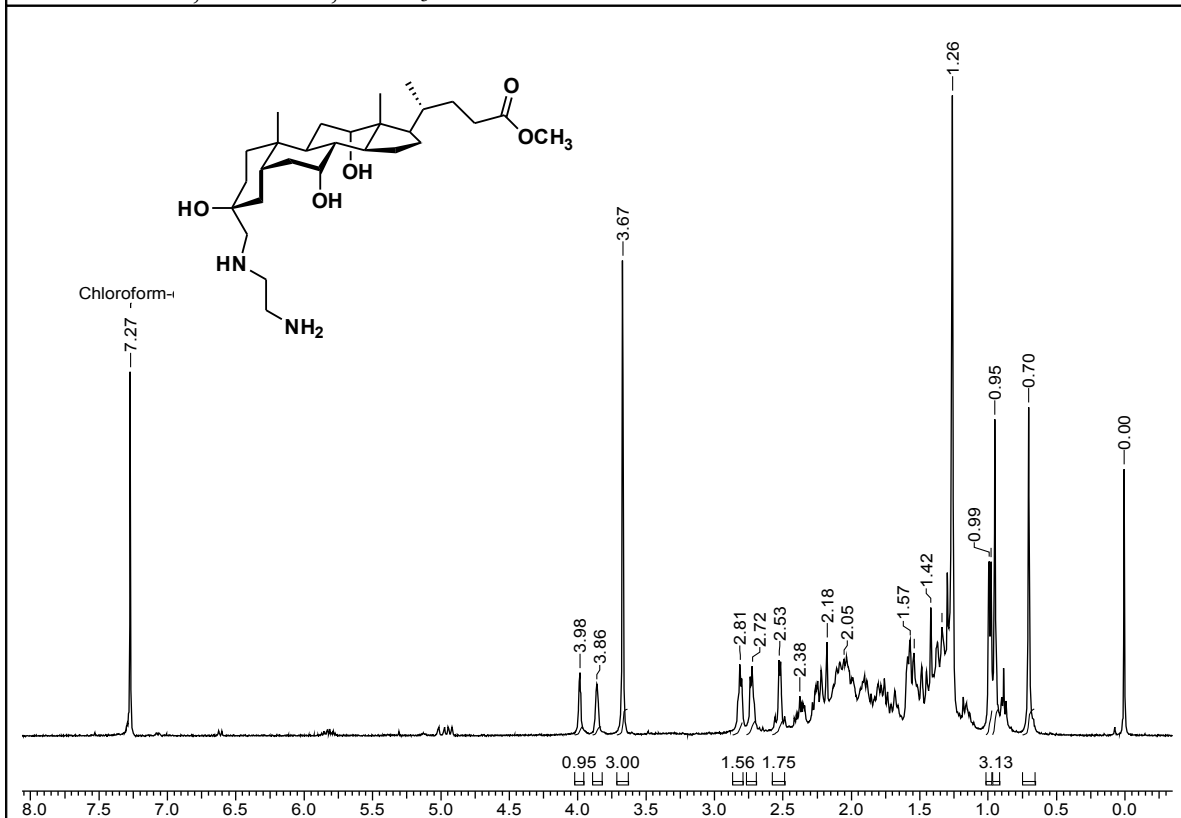
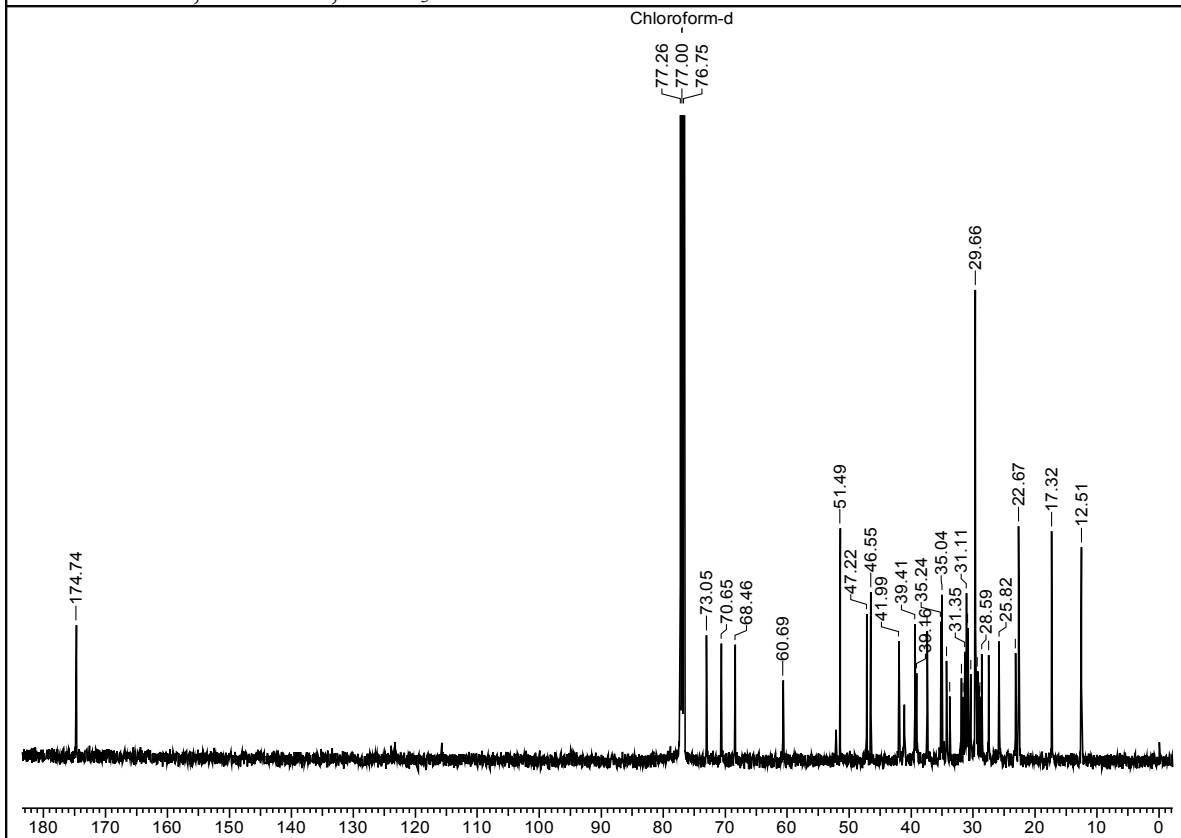
42: ^{13}C NMR, 400 MHz, CDCl_3 42: ^{13}C NMR, 100 MHz, CDCl_3 

2.2.8 References:

1. Salunke, D. B.; Hazra, B. G.; Pore, V. S. *Curr. Med. Chem.* **2006**, *13*, 813-847.
2. (a) Cohen, M. L. *Science* **1992**, *257*, 1050-1055. (b) Neu, H. C. *Science* **1992**, *257*, 1064-1073.
3. Blagbrough, I. S.; Carrington, S.; Geall, A. J. *Pharm. Sci.* **1997**, *3*, 223-233.
4. (a) Behr, J. -P.; Demeneix, B.; Loeffler, J. -P.; Perez-Mutul, J. *Proc. Natl. Acad. Sci. U.S.A.* **1989**, *86*, 6982-6986. (b) Donohue, R.; Mazzaglia, A.; Ravoo, B. J.; Darcy, R. *Chem. Commun.* **2002**, 2864-2865. (c) Byk, G.; Dubertret, C.; Escriou, V.; Frederic, M.; Jaslin, G.; Rangara, R.; Pitard, B.; Crouzet, J.; Wils, P.; Schwartz, B.; Scherman, D. *J. Med. Chem.* **1998**, *41*, 224-235. (d) Ewert, K.; Ahmed, A.; Evans, H. M.; Schmidt, H. -W.; Safinya, C. R. *J. Med. Chem.* **2002**, *45*, 5023-5029. (e) Nakaramura, E.; Isobe, H.; Tomita, N.; Sawamura, M.; Jinno, S.; Okayama, H. *Angew. Chem. Int. Ed.* **2000**, *39*, 4254-4257. (f) McGeorge, C.; Perrin, C.; Monck, M.; Camilleri, P.; Kirby, A. J. *J. Am. Chem. Soc.* **2001**, *123*, 6215-6220.
5. (a) Moore, K. S.; Wehrli, S.; Roder, H.; Rogers, M.; Forrest, J. N. Jr.; McCrimmon, D.; Zasloff, M. *Proc. Natl. Acad. Sci. U.S.A.* **1993**, *90*, 1354-1358. (b) Wehrli, S. L.; Moore, K. S.; Roder, H.; Durell, S.; Zasloff, M. *Steroids* **1993**, *58*, 370-378.
6. Stone, R. *Science* **1993**, *259*, 1125.
7. Brunel, J. M.; Salmi, C.; Loncle, C.; Vidal, N.; Letourneux, Y. *Curr. Cancer Drug Targets* **2005**, *5*, 267-272.
8. Rao, M. N.; Shinnar, A. E.; Noecker, L. A.; Chao, T. L.; Feibush, B.; Snyder, B.; Sharkansky, I.; Sarkhian, A.; Zhang, X.; Jones, S. R.; Kinney, W. A.; Zasloff, M. *J. Nat. Prod.* **2000**, *63*, 631-635.
9. Pechulis, A. D.; Bellevue, F. H. III; Cioffi, C. L.; Trapp, S. G.; Fojtik, J. P.; McKitty, A. A.; Kinney, W. A.; Frye, L. L. *J. Org. Chem.* **1995**, *60*, 5121-5126.
10. Brunel, J. M.; Letourneux, Y. *Eur. J. Org. Chem.* **2003**, 3897-3907.
11. Okumura, K.; Nakamura, Y.; Takeuchi, S.; Kato, I.; Fugimoto, Y.; Ikekawa, N. *Chem. Pharm. Bull.* **2003**, *51*, 1177-1182.
12. (a) Zhou, X. -D.; Cai, F.; Zhou, W. -S. *Tetrahedron*, **2002**, *58*, 10293-10299. (b) Zhang, D. -H.; Cai, F.; Zhou, X. -D.; Zhou, W. -S. *Org. Lett.* **2003**, *5*, 3257-3259. (c) Zhang, D. -H.; Cai, F.; Zhou, X. -D.; Zhou, W. -S. *Chinese J. Chem.* **2005**, *23*, 176-181.

13. (a) Bellini, A. M.; Quaglio, M. P.; Guarneri, M.; *Eur. J. Med. Chem.* **1983**, *18*, 185-190. (b) Bellini, A. M.; Quaglio, M. P.; Guarneri, M.; *Eur. J. Med. Chem.* **1983**, *18*, 191-195.
14. Sadownik, A.; Deng, G.; Janout, V.; Regen, S. L. *J. Am. Chem. Soc.* **1995**, *117*, 6138-6139.
15. Khabnadideh, S.; Tan, C. L.; Croft, S. L.; Kendrick, H.; Yardley, V.; Gilbert, I. H. *Bioorg. Med. Chem. Lett.* **2000**, *10*, 1237-1239.
16. Chitkul, B.; Atrash, B.; Bradley, M. *Tetrahedron Lett.* **2001**, *42*, 6211-6214.
17. Kikuchi, K.; Bernard, E. M.; Sadownik, A.; Regen, S. L.; Armstrong, D. *Antimicrob. Agents Chemother.* **1997**, *41*, 1433-1438.
18. Jones, S. R.; Kinney, W. A.; Zhang, X.; Jones, L. M.; Selinsky, B. S. *Steroids* **1996**, *61*, 565-571.
19. Kim, H. -S.; Choi, B. -S.; Kwon, K. -C.; Lee, S. -O.; Kwak, H. J.; Lee, C. H. *Bioorg. Med. Chem.* **2000**, *8*, 2059-2065.
20. Shu, Y.; Jones, S. R.; Kinney, W. A.; Selinsky, B. S. *Steroids* **2002**, *67*, 291-304.
21. Choucair, B.; Dherbomez, M.; Roussakis, C.; Kihel, L. E. *Tetrahedron* **2004**, *60*, 11477-11486.
22. (a) Savage, P. B.; Li, C. *Exp. Opin. Invest. Drugs*, **2000**, *9*, 263-272. (b) Savage, P. B. *Eur. J. Org. Chem.* **2002**, 759-768. (c) Savage, P. B.; Li, C.; Taotafa, .; Ding, B.; Guan, Q. *FEMS Microbio. Lett.* **2002**, *217*, 1-7.
23. Vaara, M.; Vaara, T. *Nature* **1983**, *303*, 526-528.
24. Li, C.; Peters, A. S.; Meredith, E. L.; Allman, G. W.; Savage, P. B. *J. Am. Chem. Soc.* **1998**, *120*, 2961-2962.
25. Schmidt, E. J.; Boswell, S. R.; Walsh, J. P.; Schellenberg, M. M.; Winter, T. W.; Li, C.; Allman, G. W.; Savage, P. B. *J. Antimicrob. Chemother.* **2001**, *47*, 671-674.
26. (a) Deng, G.; Dewa, T.; Regen, S. L. *J. Am. Chem. Soc.* **1996**, *118*, 8975-8976.;(b) Merritt, M.; Lanier, M.; Deng, G.; Regen, S. L. *J. Am. Chem. Soc.* **1998**, *120*, 8494-8501; (c) Otto, S.; Osifchin, M.; Regen, S. L. *J. Am. Chem. Soc.* **1999**, *121*, 7276-7277.(d) Bandyopadhyay, P.; Janout, V.; Zhang, L.; Regen, S. L. *J. Am. Chem. Soc.* **2001**, *123*, 7691-7696. (e) Bandyopadhyay, P.; Janout, V.; Zhang, Lan-hui.; Sawko, J. A.; Regen, S. L. *J. Am. Chem. Soc.* **2000**, *122*, 12888-12889; (f) Bandyopadhyay, P.; Bandyopadhyay, P.; Regen, S. L. *J. Am. Chem. Soc.* **2002** *124*, 11254-11255.; (g) Zhang, J.; Jing, B.; Regen, S. L. *J. Am. Chem. Soc.* **2003**, *125*, 13984-13987. (h)

- Janout, V.; Jing, B.; Staina, I. V.; Regen, S. L. *J. Am. Chem. Soc.* **2003**, *125*, 4436-4437. (i) Chen, W. -H.; Regen, S. L. *J. Am. Chem. Soc.* **2005**, *127*, 6538-6539.
27. Salunke, D. B.; Ravi, D. S.; Pore, V. S.; Mitra D.; Hazra, B. G. *J. Med. Chem.* **2006**, *49*, 2652-2655.
28. Corey, E. J.; Chaykovsky, M. *J. Am. Chem. Soc.* **1965**, *87*, 1353-1364.
29. (a) Cook, C. E.; Corley, R. C.; Wall, M. E. *Steroids* 1968, *33*, 2789-2793; (b) Bevins, C. L.; Bantia, S.; Pollack, R. M.; Bounds, P. L.; Kayser, R. H. *J. Am. Chem. Soc.* **1984**, *106*, 4957-4962; (c) Kashino, S.; Katz, H.; Glusker, J. P.; Pollack, R. M.; Boundst, P. L. *J. Am. Chem. Soc.* **1987**, *109*, 6765-6771; (d) Maltais, R.; Tremblay, M. R.; Poirier, D. *J. Comb. Chem.* **2000**, *2*, 604-614; (e) Maltais, R.; Luu-The, V.; Poirier *J. Med. Chem.* **2002**, *45*, 640-653;
30. (a) Rapoport, H.; Reist, H. N. *J. Am. Chem. Soc.* **1955**, *77*, 480; (b) Reagents for Organic synthesis, Fieser & Fieser, Volume p-363
31. Tserng, K. -Y. *Journal of lipid research* **1978**, *19*, 501-504.
32. Geldern, T. W.; Tu, N.; Kym, P. R.; Link, J. T.; Jae, H. -S.; Lai, C.; Apelqvist, T.; Rhonnstad, P.; Hagberg, L.; Koehler, K.; Grynfarb, M.; Goos-Nilsson, A.; Sandberg, J.; Österlund, M.; Barkhem, T.; Höglund, M.; Wang, J.; Fung, S.; Wilcox, D.; Nguyen, P.; Jakob, C.; Hutchins, C.; Färnegårdh, M.; Kauppi, B.; Öhman, L.; Jacobson, P. B. *J. Med. Chem.* **2004**, *47*, 4213-4230.

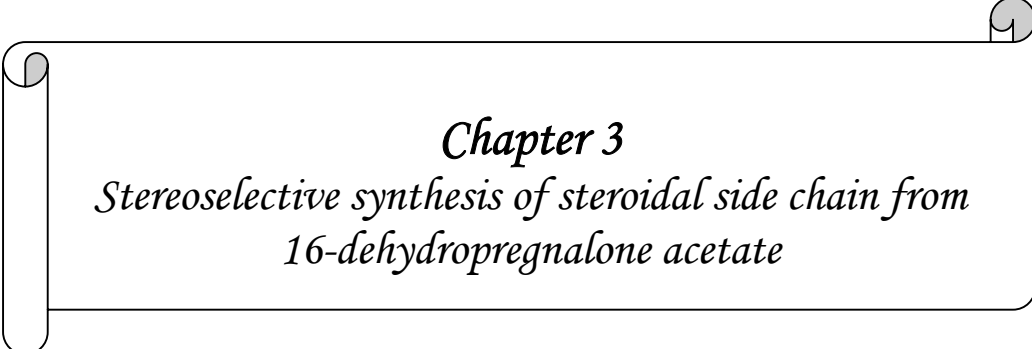

Chapter 3
Stereoselective synthesis of steroidal side chain from
16-dehydropregnalone acetate

3.1 Abstract

The isolation and synthesis of many biologically important steroids with modified side chains have stimulated much interest for the development of efficient methods to introduce such modified side chains into readily available steroids. In this chapter we have devoted our efforts towards stereoselective construction of steroidal side chain at C-20 having 'natural' configuration. 16-dehydropregnalone (16-DPA) **110** has been used as a starting material. Palladium catalyzed carbon-carbon bond forming Heck reaction between C-20 vinyl iodide **120** with methyl acrylate to form unsaturated compound **121** and transfer hydrogenation with triethylsilane and Pd/C are the key steps for stereoselective side chain synthesis.

3.2 Introduction

Steroids are a large class of natural products, widely distributed in animals and plants. In the past four-five decades large number of new steroids have been isolated which possess functionalized side chains attached to the tetracyclic unit at C-17 with both natural C-20(R) and unnatural C-20(S) stereochemistry. The biological significance of both the C-20 epimers of naturally occurring and synthetic analogues has provided an opportunity to pursue new synthesis of steroids or compounds with similar side chain structures.¹ Naturally occurring steroids having C-20(R) configuration show various biological activities. A few representative examples are shown in Figure 1.

The most abundant steroid found in animals is the highly lipophilic cholesterol **1**, which is metabolized to bile acids in liver and serves as a starting material for the synthesis of steroid hormones such as estradiol, testosterone etc. Ergosterol **2**, lanosterol **3** and stigmasterol **4** are widely distributed in fungi and plants.

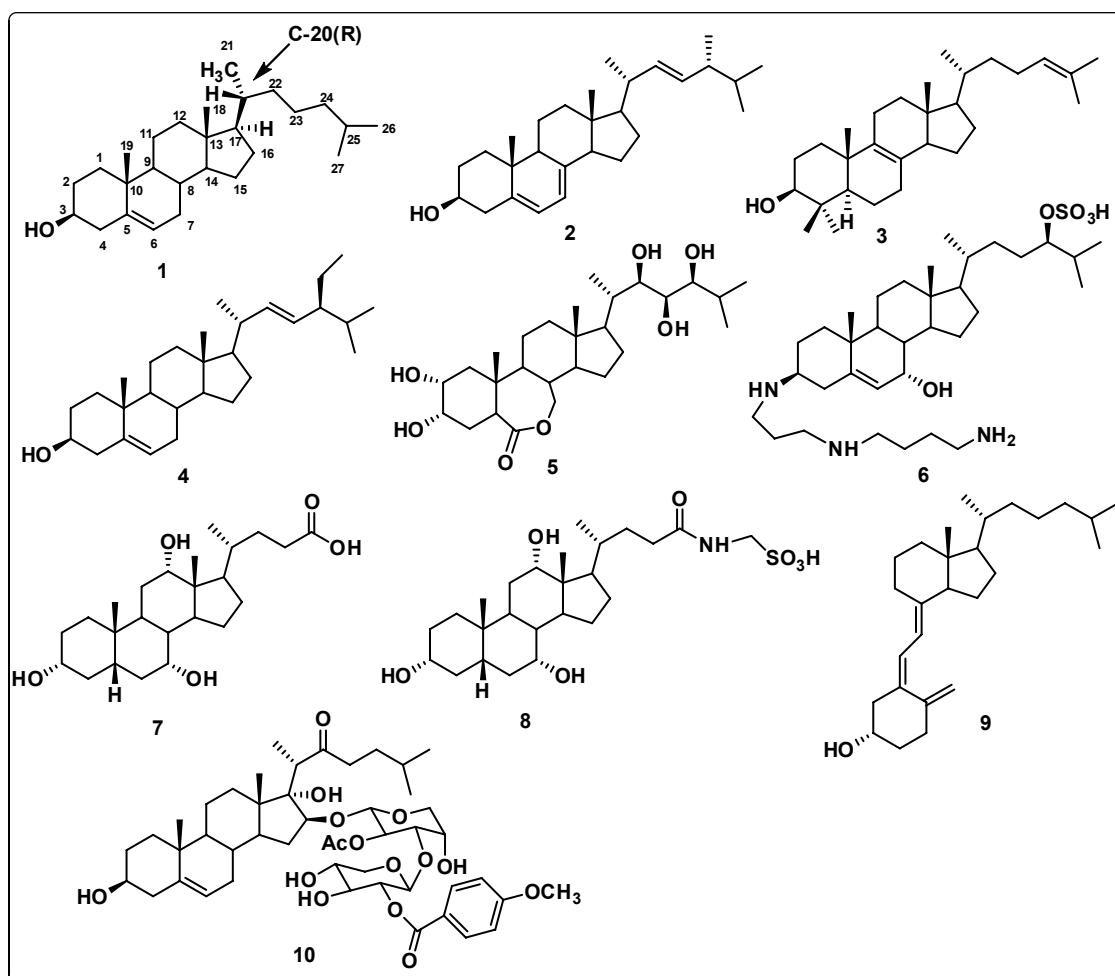

Figure 1: Steroids with C-20(R) natural stereochemistry

Brassinolide **5** and its analogues are important plant growth promoting steroids, a few of which are commercially available.² Squalamine **6**, the first naturally occurring sterol-polyamine conjugate³ is now in phase II clinical trials as an anticancer drug. Bile acids e.g. cholic acid **7**, taurocholic acid **8** are found in human intestinal bile. Vitamin D analogues⁴ e.g. Vitamin D₃ **9** and saponin⁵ OSW-1 **10** show various biological activities.

Steroids with unnatural C-20(S)-configuration have attracted attention because of the interesting biological activities of these epimers. A few representative examples are shown in Figure 2. Koreeda *et al.* reported⁶ that the C-20-isocholesterol **11** shows inhibitory activity for the conversion of cholesterol to pregnenolone. Idler *et al.* described⁷ the presence of 20-isocholest-5,22-dien-3 β -ol **12** in the scallop *Placopeeten magellanicus*. Djerassi and coworkers isolated four sterols **13-16** from a sea pen *Ptilosarcus gurneyi* and reported⁸ their chemical syntheses.

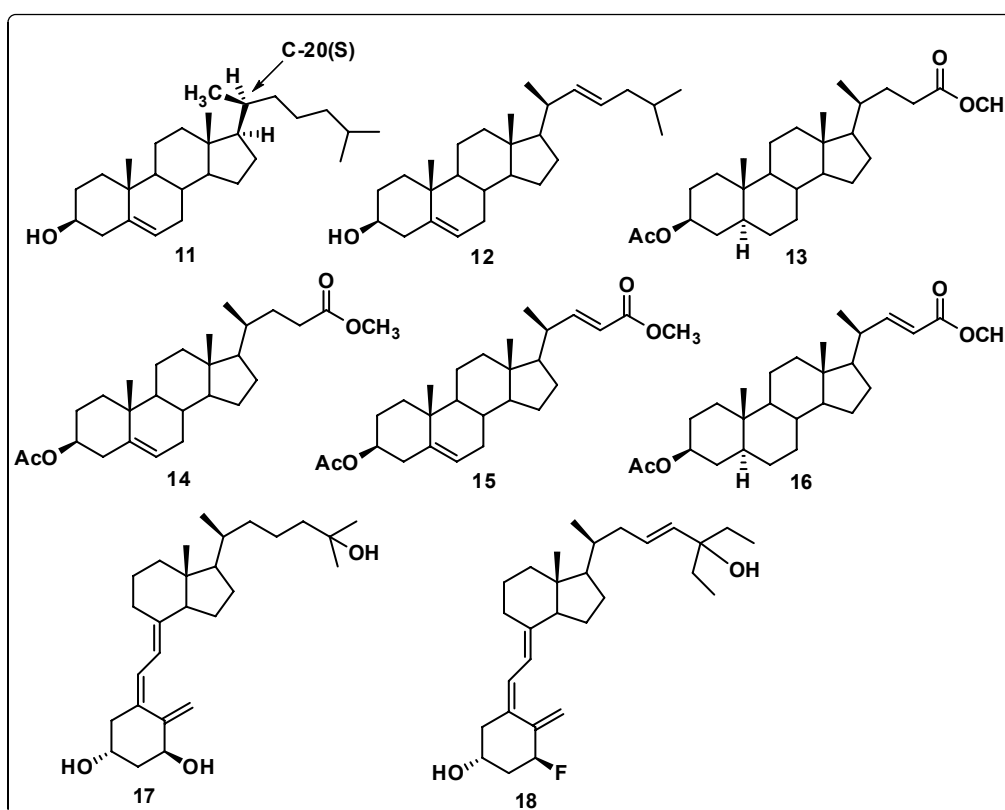

Figure 2: Steroids with C-20 (S) unnatural stereochemistry.

Unnatural C-20(S)-vitamin D₃ **17**, is more potent in regulating cell growth and cell differentiation than C20(R)-compound⁹ and 1 α -fluoro-16,23-diene-20-epi hybrid deltanoid (Ro 26-9228) **18** is used in the treatment of osteoporosis.¹⁰

3.3 Review of literature

The stereospecific introduction of steroid side chains on to the basic steroid nucleus has attracted a good deal of interest and hence intensive research on side chain syntheses yielded many imaginative syntheses of general interest and has contributed much to the development of stereospecific chiral carbon formation during the last two decades. Representative examples of some methods for stereoselective steroidal side chain construction are as follows:

Michael addition

A stereospecific construction of steroidal side chain based upon Michael addition of nitroalkanes to 17(20)-en-16-one has been devised by Kessar *et al.*¹¹ mainly for synthesis of sapogenins and steroidal alkaloids. It is also applied to the synthesis of cholesterol. Micheal addition of nitroalkane **20** to 17(20)-en-16-one **19** produced compound **21** having natural stereochemistry at C-20 (Scheme 1).

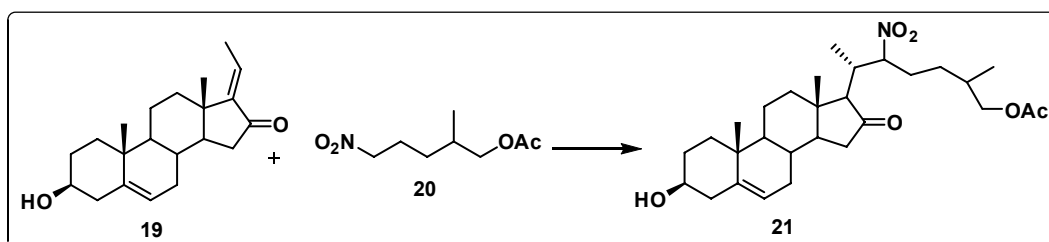

Scheme 1

Djerassi *et al.* conducted copper catalyzed Grignard addition of compound **23** to similar steroid enones such as **22** and observed that epimeric mixture at C-20 compounds **24** was produced starting from the pure *E* or *Z* isomer (Scheme 2).¹²

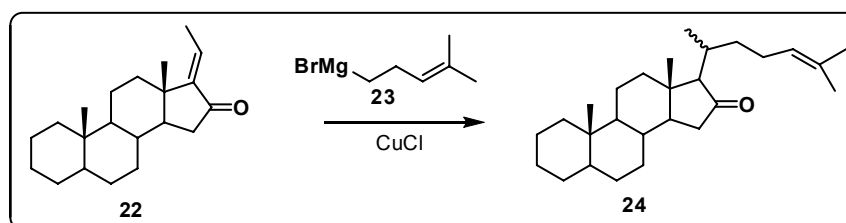

Scheme 2

Trost and coworkers isolated the C-20(R) isomer **26** by reaction of lithium diisohexylcuprate **25** with enolate **19** (Scheme 3).¹³ The reactions of either the *E*-17(20)-

en-16 α -pivaloyloxy **27** or the corresponding 16 β -pivaloyloxy steroid **28** with lithium isohexylcyanocuprate **29** each proceeded in a regio- and stereo controlled manner. The 16 α compound **27** gave exclusively the “unnatural” 20(S) chirality (compound **30**) which was converted to 20-epicholesterol, while 16 β compound **28** gave exclusively the “natural” 20(R) chirality (compound **31**) and was converted to cholesterol.

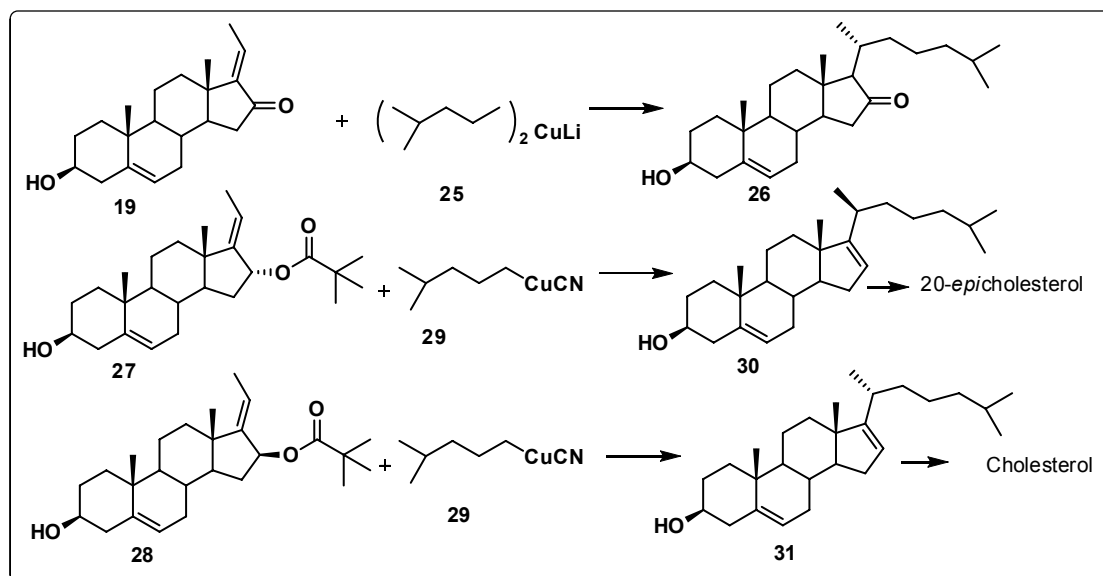

Scheme 3

Marino *et al.* have reported¹⁴ the regiospecific and stereospecific 1,4 addition of alkyl cyanocuprates **32** and **33** to alkylideneoxiranes **34** and **35** to give compounds **36** and **37** respectively, which is the only stereospecific methodology for the concomitant introduction of the C-20 asymmetric center and the 15 β -hydroxyl group (Scheme 4).

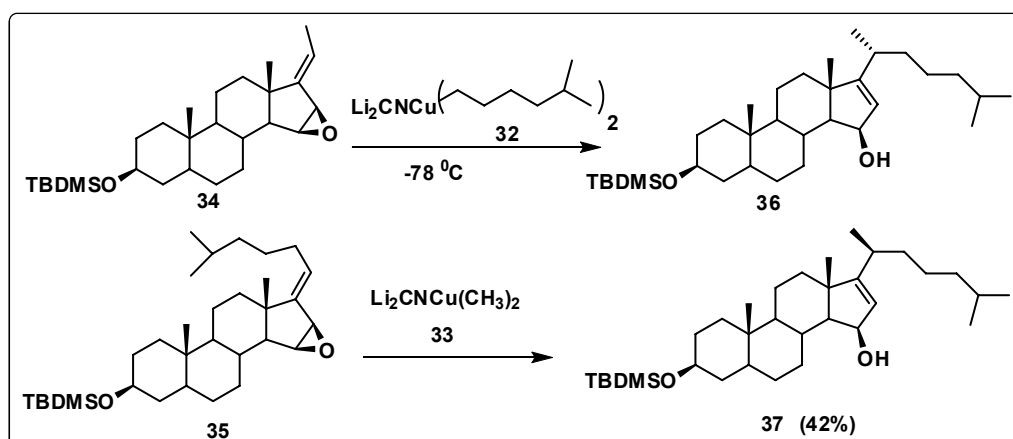

Scheme 4

Recently Jin *et al.* reported¹⁵ the TMSCl-activated stereoselective 1,4-addition of the α -alkoxy vinyl cuprate **38** to steroid 17(20)-en-16-one **39** to afford the silyl enol ether **40** generating C-20(S)-configuration (Scheme 5). This intermediate **40** has been converted into highly potent antitumor natural product OSW-1.

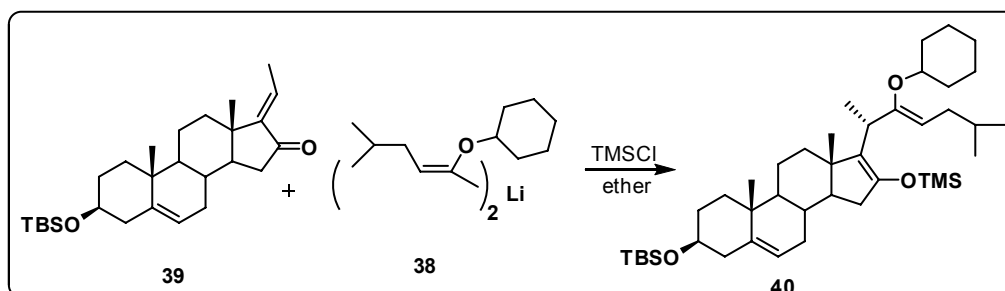

Scheme 5

Palladium catalyzed reactions

The palladium catalyzed method for side chain construction developed¹⁶ by Trost *et al.* might have wide spread applications. The method involves initial formation of allylpalladium complex **42** with unsaturated compound **41** from α -face (Scheme 6). The nucleophile can then add only from β -face yielding the “unnatural” configuration at C-20 (compound **43**). In the case of C-20-acetoxy compound **44**, palladium complex **45** is formed on the β -face owing to steric hindrance by the acetate moiety on α -face. Nucleophilic attack takes place from the acetate side yielding natural configuration at C-20 (compound **46**). This method is applied for the synthesis of ecdysone side chain.

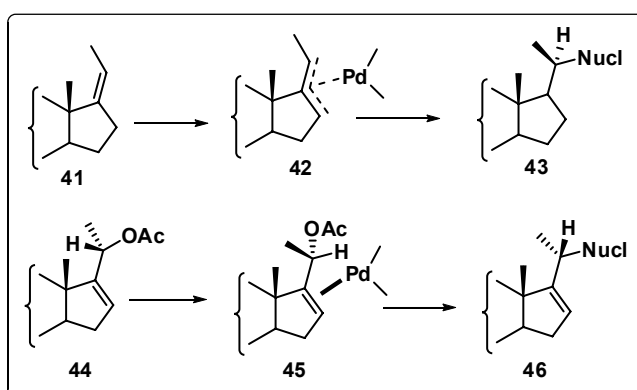

Scheme 6

Tsuji and coworkers reported¹⁷ the stereoselective introduction of side chain by activation of the palladium complex formed with *E*-15,16-epoxy-17(20)-en-alkylidene steroids **47** and **50** with various nucleophiles (Scheme 7).

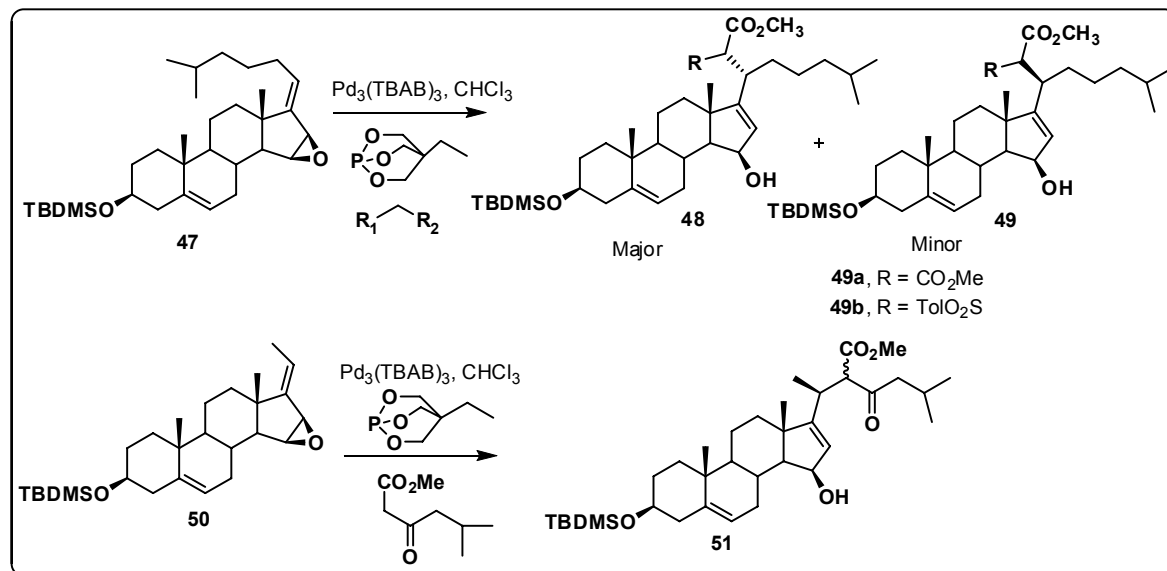

Scheme 7

Both the epimers at C-20 have been generated stereospecifically by the palladium-catalyzed hydrogenolysis of C-20 (*Z*) or (*E*) allylic carbonates **52** and **54** respectively with triethylammonium formate (Scheme 8).¹⁸

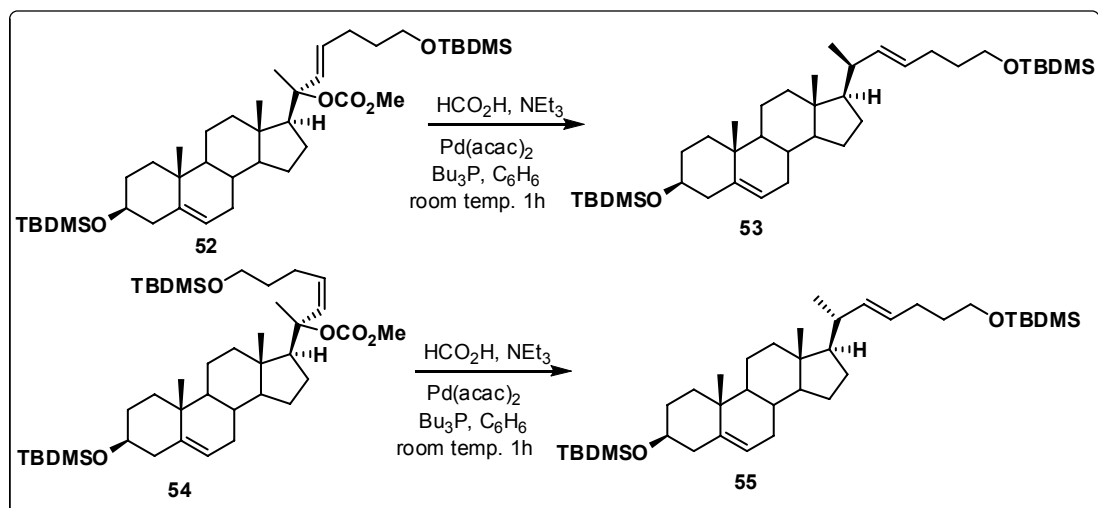

Scheme 8

Alkylation

Wicha and coworkers reported¹⁹ alkylation of the lithium derivative of the methyl esters of 3 β -tetrahydropyran-2-yloxypregn-5-en-21-oic acid with methyl iodide to give methyl 20-R-3 β -hydroxy-24,25-bisnorchol-5-en-22-oate. Ibuka and co workers reported²⁰ that reaction of (*E*)-ethyl 3 β -t-butyl dimethylsiloxypregna-5(6),17(20)-dien-21-oate **56** with lithium di-isopropylamide followed by alkyl halides results in the predominant formation of 20(S)-alkylation products in >88% isolated yields (Scheme 9). Synthetic applications to both C-20(R) and C-20(S) steroidal side chains are recently described by Wicha *et al.*²¹

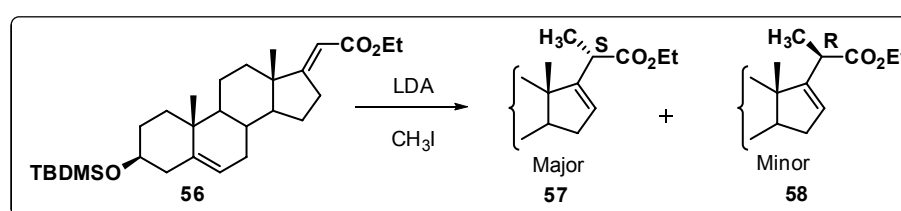

Scheme 9

Claisen rearrangement

Tanabe and coworkers reported²² the [3,3] Claisen sigmatropic rearrangement for the stereoselective construction of C-20(R) and C-20(S) isomers. A highly ordered six-member transition state in the concerted cyclic process accounts for the high stereoselectivity. *E* allylic β -ketoacetate **59** afforded compound **61** with natural C-20(R) configuration and *Z* isomers **60** resulted in compound **62** having unnatural C-20(S) configuration (Scheme 10).

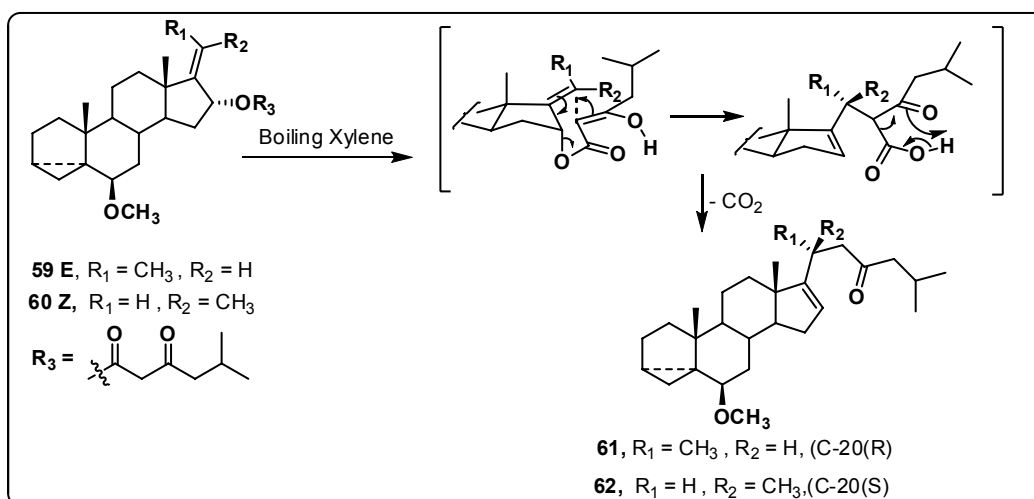

Scheme 10

Nakai and coworkers reported²³ an efficient approach to either (22S)- or (22R)-hydroxy-23-carboxylic acid side chain which relies on the stereochemical transmission via [3,3] Claisen sigmatropic rearrangement.

Ene Reaction

Uskokovic and coworkers²⁴ carried out Lewis acid catalyzed ene reaction of an appropriately substituted (*Z*)-3 β -acetoxy-5 α -pregn-17(20)-ene **63** with methyl propionate using ethyl aluminium dichloride as Lewis acid catalyst as well as proton scavenger. This reaction stereospecifically generated C-20(R) compound **64** (Scheme 11).

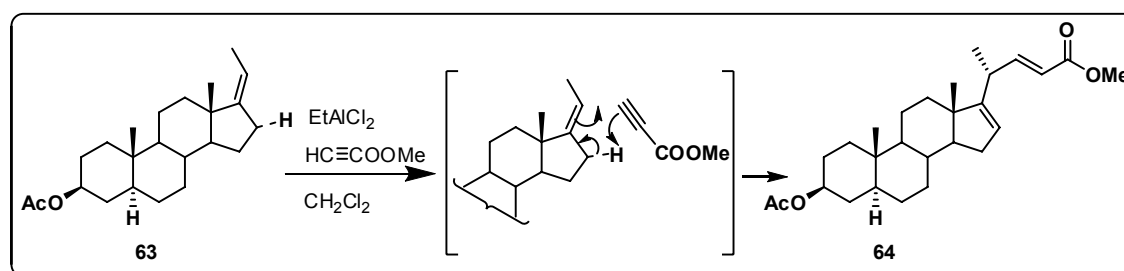

Scheme 11

The stereochemical control is attributed to the virtually exclusive attack of the enophile from the less hindered α -face of the olefin. Dauben *et al.* reported²⁵ diethylaluminium chloride catalyzed ene reaction between *E*-3 β -acetoxy-5(6),17(20)-pregnadiene and methyl propionate to yield methyl C-20(S)-3 β -acetoxychole-5,16,22-trienoate, at a slower rate than the C-20(R) formation from the *Z* isomer. Ene reaction of 17(*Z*) ethylidene steroid **65** with paraformaldehyde as an enophile in the presence of acetic anhydride using various cation exchange resins,²⁶ and also titanium triisopropoxy chloride, trimethylsilyl chloride and tert-butyldimethylsilyl chloride²⁷ as a Lewis acid catalyst has been reported from our laboratory (Scheme 12).

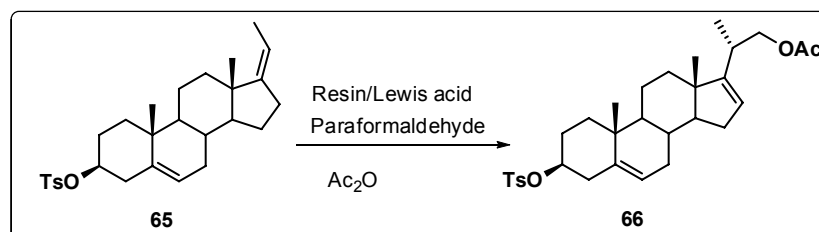

Scheme 12

This reaction afforded stereospecifically the C-22 acetate having C-20(R)-configuration (compound **66**) in excellent yields. Recently, Riccardis and coworkers²⁸ have used boron trifluoride catalyzed ene reaction for the synthesis of the C-2-symmetric bis-20(S)-5 α -23,24-bisnorchol-16-en-3 β ,6 α ,7 α -triol-22-terephthaloate, active as Na⁺-transporting transmembrane channel and diethylaluminium chloride catalyzed ene reaction for the synthesis of IPL576,092-contignasterol and IPL576,092-manoalide hybrids. Nakagawa *et al.* utilized this reaction for the synthesis of 6-deoxoteasterone, a brassinolide biosynthetic intermediate and 26,27-bisnorcastasterone.²⁹ Covey and coworkers used dimethylaluminium chloride and methyl aluminium dichloride mediated ene reactions for the synthesis of *ent*-cholesterol, *ent*-desmosterol, *ent*-deuterocholesterol, *ent*-bile acids.³⁰

Wittig rearrangement

Wittig rearrangement has been used for specifically transmitting an epimerically defined chirality at C-16 of the steroidal nucleus to the new chiral center(s) at C-20 and C-22 of the side chain as illustrated in Scheme 13. Its significant feature is that it allows the concurrent control of absolute and relative configurations at C-20 and C-22 through the proper combination of geometry of the exo-olefin, the configuration at C-16 (α and β), and the key G group.³¹

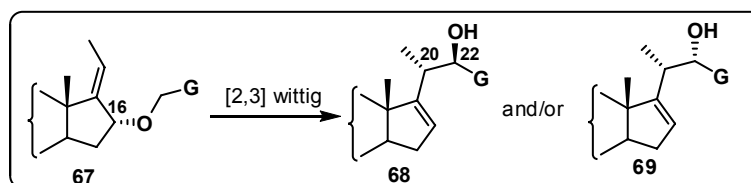

Scheme 13

Mikami *et al.*³² have successfully demonstrated the utility of this approach in the fully stereocontrolled synthesis of either 22(S)- or 22(R)-hydroxy-23-acetylenic side chains from the single precursor (Scheme 14). The most significant feature in this example is that the dianion rearrangement of **70a** affords the 20(S),22(S)-*threo* product **71a** as a single stereoisomer, whereas the introduction of the silyl group (**70b**) induced the reversal of diastereoselection to give the 20(S), 22(R)-*erythro* product **71b** as a single stereoisomer.

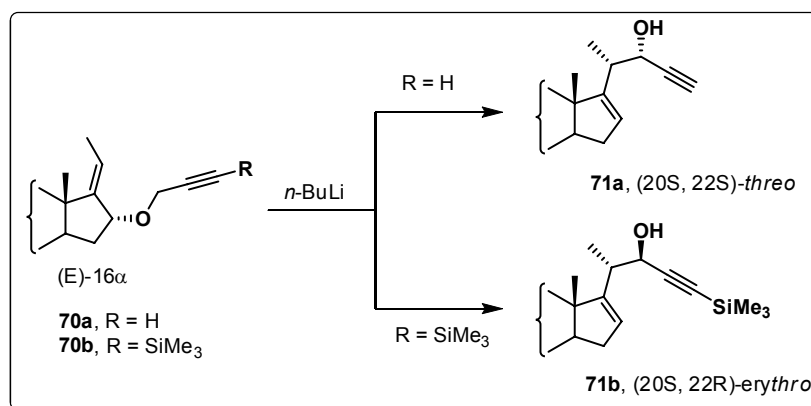

Scheme 14

The products can serve as key intermediates for the synthesis of many important side-chain modified steroids such as the insect hormone ecdysone and the plant growth regulators brassinosteroides. A similar rearrangement has been shown to proceed even on the sterically crowded β -face (Scheme 15), where the rearrangement exhibits the usual *Z erythro* selection to afford 20(S), 22(R) **73** as a single stereoisomer.³³ A Spanish group³⁴ has synthesized compounds **75a** and **75b** from E and Z isomers **74a** and **74b** respectively for transmitting the 16 α -chirality to the chiral center at C-20.

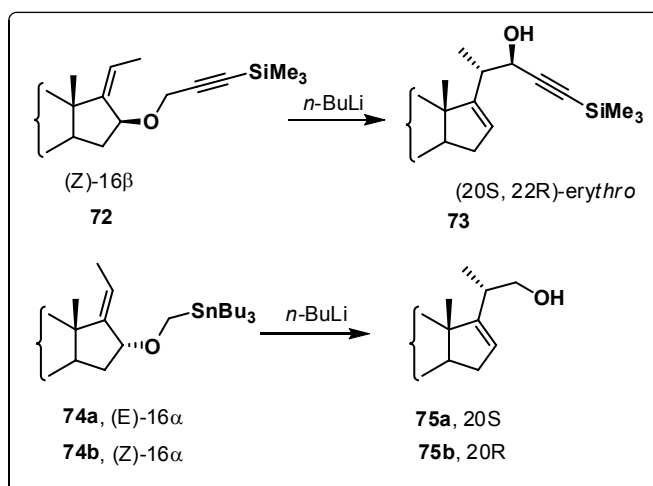

Scheme 15

Organoborane

A stereoselective synthesis of C-22 alcohols in the steroid series through hydroboration-oxidation of olefinic side-chains has been reported by Fetizon and coworkers.³⁵ The tetrahydropyranyl (THP) derivative **76** when treated with an excess of disiamylborane followed by oxidation with 30% hydrogen peroxide and 10% sodium

hydroxide gave 20(S)-alcohol **77** in 45% yield (Scheme 16). The use of the equivalent amount of diborane leads to a 4:6 mixture of the C-20(R) and C-20(S) isomers.

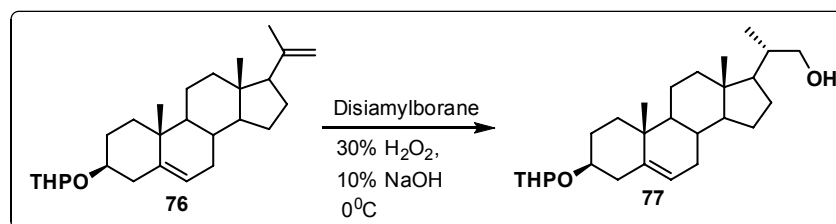

Scheme 16

Trivedi and coworkers reported³⁶ hydroboration of the same compound **76** using 9-borabicyclononane (9-BBN) followed by oxidation with H₂O₂/NaOH giving single C-20(S)-isomer in good yield. The hydroboration of 17(20)-(Z)-ethylidene steroid **78** with 9-BBN proceed in a highly selective manner from the α -face of the steroid. Treatment of the resulting 9-BBN derivative with chloroacetonitrile in the presence of base produces 21-cyano steroid **80** possessing the natural configuration at C-17 and C-20 (Scheme 17).³⁷ Rychnovsky *et al.* reported³⁸ hydroboration of *E*-17(20) ethylidene steroid **78** for the synthesis of *ent*-cholesterol.

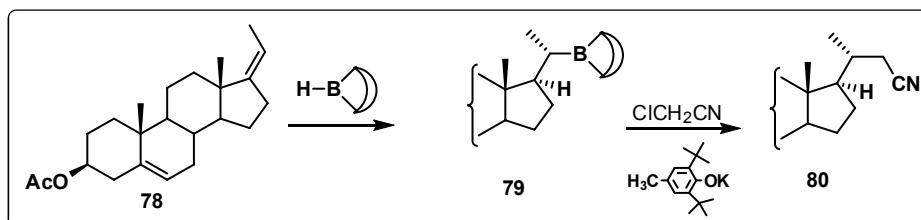

Scheme 17

Aldol Condensation

Aldol condensation of 16 α -hydroxy-17-one steroid **81** with propionate enolates has been reported by Yu *et al.*³⁹ The lithium *E* enolate of ethyl propionate on treatment with steroid **81** using conditions A (Scheme 18) gave only the 17 α -hydroxy-21 α -methyl product **82a** (63%). By using conditions B (without HMPA), the condensation reaction predominantly led to the desired 21 α methyl product **82a** (75% yield) with minor amount of 21 β -methyl isomer **82b** (12%). Bulky esters such as isobutyl and dodecyl propionate under conditions B gave predominantly the *E* enolates which on condensation with keto

compound **81** gave the desired 17 α -hydroxy-21 α -methyl compounds **83** (78%) and **84** (81%) as single isomers.

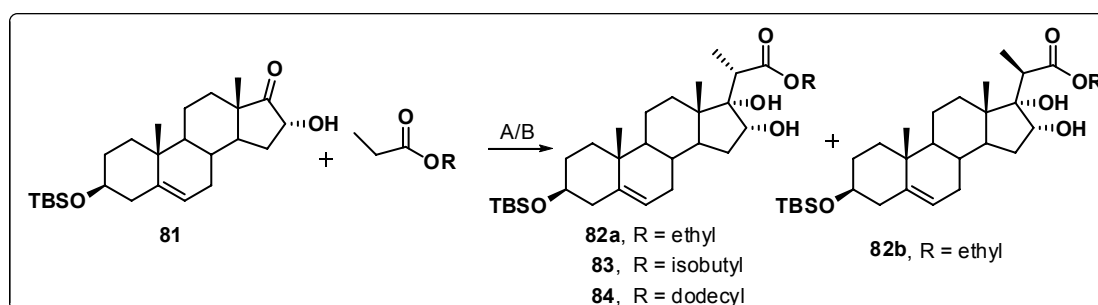

Scheme 18 Reagents and Conditions: (A) (1) *i*-Pr₂, *n*-BuLi, -78 °C, 15 min.; (2) -78 °C, HMPA, THF, Propionate, 0.5 h; (3) Ketone, -78 °C; (B) (1) *i*-Pr₂, *n*-BuLi, -78 °C, 15 min.; (2) -78°C, THF, Propionate, 0.5 h; (3) Ketone, -78°C.

Organozirconium^{40, 41} and organoruthenium⁴² also have been used for stereoselective side chain construction of steroids.

Catalytic Hydrogenation of 20(21)/20(22) double bonds

Several reports concerning hydrogenation of double bonds formed between C-20 and one of the adjacent carbons at C-17 and C-21 or C-22 have appeared. Gut's group⁴³ has reported that 17(20)-dehydrocholesterol (*E* isomer) **85** yields 20-isocholestanol **86** on catalytic reduction (10% Pd-C) in 25% yield (Scheme 19).

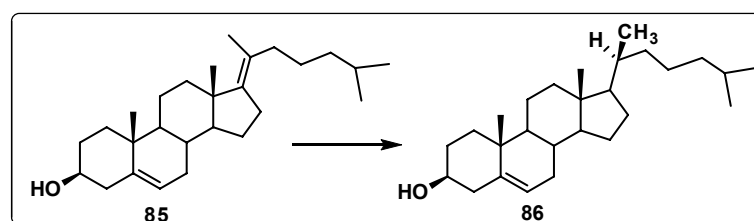

Scheme 19

During hydrogenation of diene **87** Sondheimer and Mechoulam⁴⁴ obtained different products under various conditions. With PtO₂ in HOAc, saturation of both 5(6) and 20(21) double bonds resulted and C-20(R)-cholestanol **88** was crystallized in 25% yield from the crude reaction mixture (Scheme 20). Hydrogenation of **87** over Pd-CaCO₃ in ethanol did not affect the 5(6) double bond, and C-20(S)-cholesterol was isolated in 25% yield. Nair and Mosettig⁴⁵ however, reported that catalytic reduction of 5 α -cholest-20(21)-ene **87** leads to a mixture of cholestanes, inseparable by column or gas

chromatography. Similarly, Schneider during his study⁴⁶ of the catalytic reduction of 20(21)-ene **89** with 5% H₂/Pd-C in EtOAc found that this reduction gave a mixture of C-20(R) **90** and C-20(S) **91** in 4:5 ratio. No increase of the C-20(R) isomer was noted when the reduction was performed in HOAc.

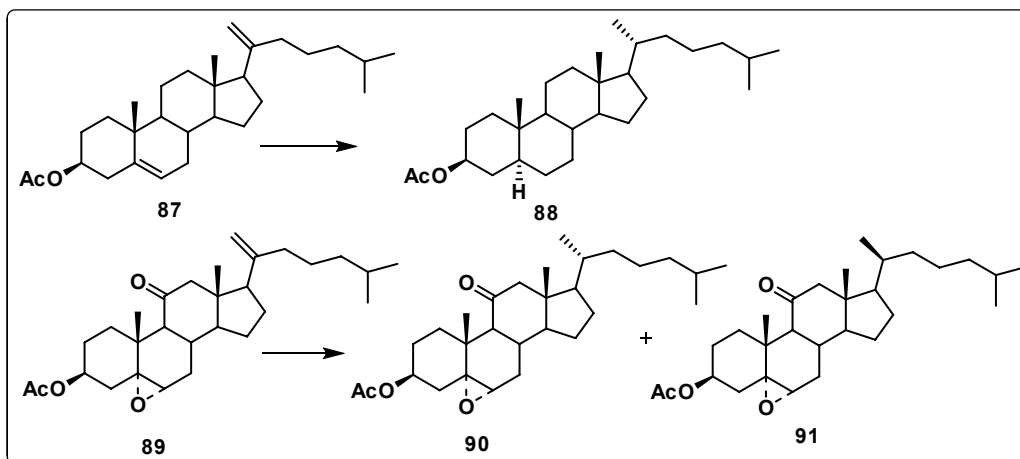

Scheme 20

Kametani *et al.*⁴⁷ reported the stereoselective hydrogenation on Pd/C of an olefinic furan derivative **92** to give the C-20(S) compound **93** which was used for the synthesis of ecdysone side chain (Scheme 21).

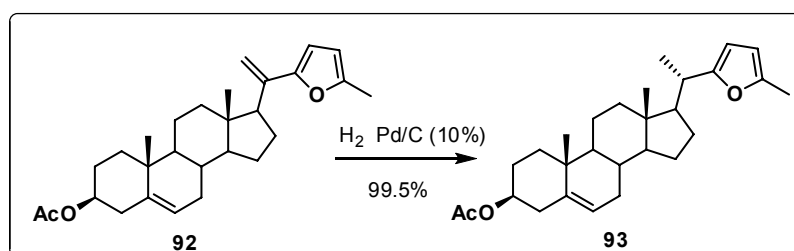

Scheme 21

Uskokovic and coworkers reported⁴⁸ the catalytic hydrogenation of the mixture of *E* and *Z* olefins **94** over platinum oxide catalyst in 95% ethanol to furnish approximately 1.5:1 mixture of C-20(R) **95** and C-20(S) **96** (Scheme 22). Similar reaction on epimeric mixture **97** led to mixture of C-20(R)-ketone **98** and C-20(S) isomer **99** from which compound **98** was readily separated by crystallization in 95% ethanol.

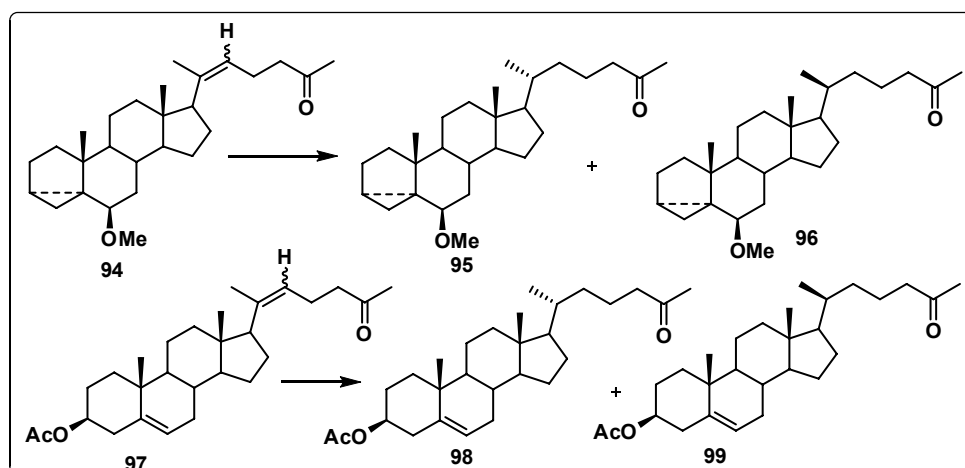

Scheme 22

Fukumoto and co-workers reported⁴⁹ catalytic hydrogenation of compound **100** with 20(22) double bond and **102** with 5(6),20(22)-diene using PtO_2 resulted into the corresponding saturated compounds **101** and **103** with C-20(R) natural configuration (Scheme 23). Kametani *et al.* reported⁵⁰ similar hydrogenation of the 20(22)-dehydro compound **104** having A/B *cis* junction that resulted into compound **105** with C-20(R) natural configuration.

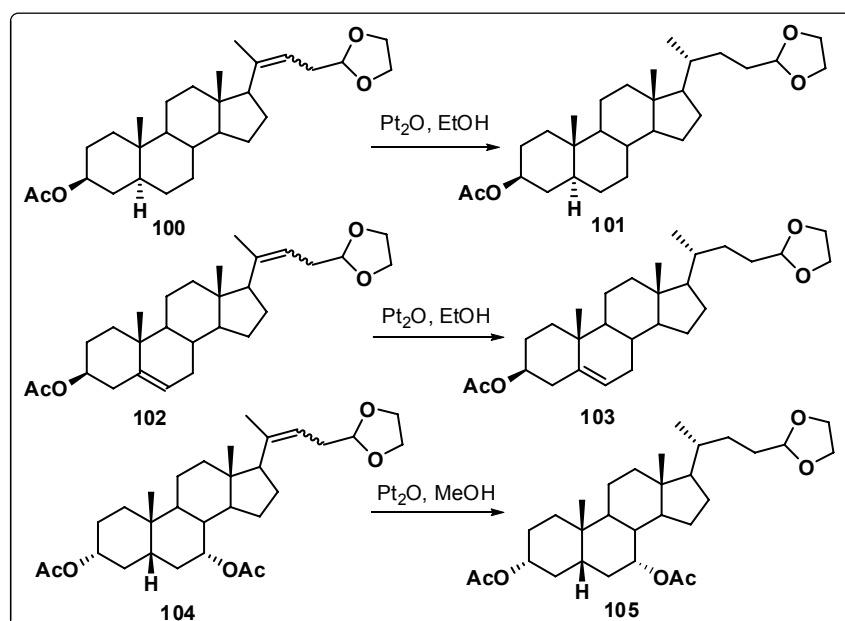

Scheme 23

Catalytic hydrogenation of the 20(21)/20(22) olefin over 5% $\text{Rh-Al}_2\text{O}_3$ afforded the C-20 epimeric mixture in 92% yield and 1:1 ratio.⁵¹ Recently, there is a report⁵² on the

catalytic hydrogenation of compound having 16(17), 20(21) and 24(25) double bonds. All the three olefinic bonds were hydrogenated to give saturated compound in quantitative yield as a mixture of C-20 epimers.

Ionic Hydrogenation

Recently, our group developed a highly stereoselective method for the construction of unnatural C-20(R) aldehydes starting from 16-dehydropregnenolone acetate. The salient feature of this synthesis is ionic hydrogenation of C-20-22-ketene dithioacetal **107** using $\text{Et}_3\text{SiH}/\text{CF}_3\text{COOH}$, to obtain the compound **108** having C-20 unnatural stereochemistry with 100% selectivity which was converted into C-20(R) aldehyde **109**.⁵³ The same compound was synthesized by ionic hydrogenation⁵⁴ of steroidal tertiary alcohols **106** using Et_3SiH and $\text{BF}_3\cdot\text{OEt}_2$ (Scheme 24). This unnatural C-20(R) aldehyde **109** was elaborated further to 20-*epi* cholanic acid derivatives.⁵⁵

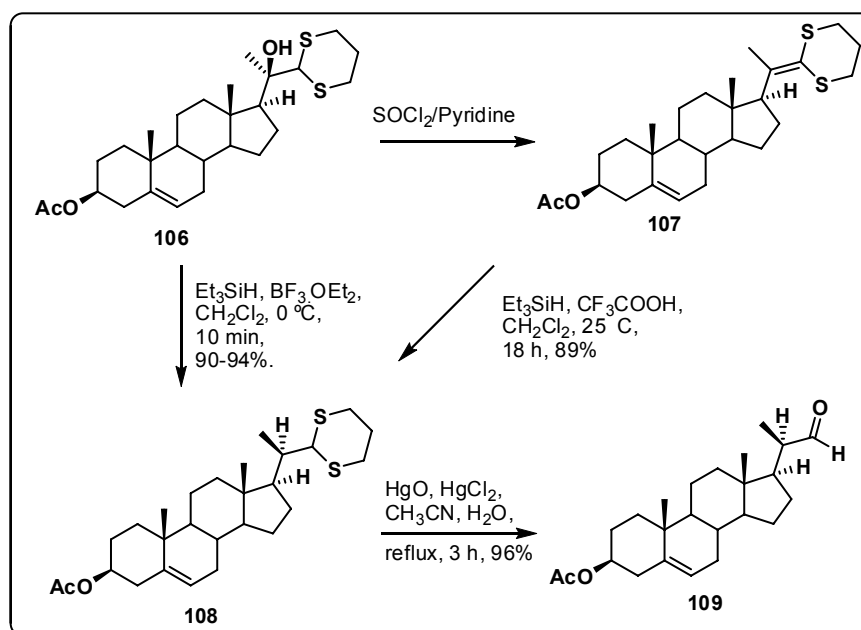

Scheme 24

3.4 Present Work:

3.4.1 Objective

In continuation of our work on stereoselective construction of steroidal side chain, we became interested in the stereoselective construction of the side chain at C-20 having 'natural' configuration from readily available⁵⁶ 20-oxo steroid 16-dehydropregalone acetate (16-DPA). Heck coupling and palladium catalyzed transfer hydrogenation have been used as key steps for this synthesis.

In literature there are reports on the coupling of alkyl halide with electron deficient alkenes for carbon-carbon bond formation by using tributyl tin hydride,⁵⁷ polymer supported organo tin compounds,⁵⁸ and by using Ni₂B (cat)/BER (borohydrate exchange resin) in methanol.⁵⁹ However, there is no report on construction of steroidal side chain from C-20 halogenated compounds. Hence, we were interested to synthesizing the C-20 iodo compound **113** which could be utilized for the stereoselective synthesis of the steroidal side chain.

3.4.2 Results and Discussion

Chemoselective hydrogenation of the 16-DPA **110** using 10% Pd/C in ethyl acetate at 45 psi afforded saturated ketone **111** without affecting the 5(6) double bond in 97% yield (Scheme 25). IR spectrum of **111** showed bands at 1701 and 1724 cm⁻¹ for C-20 keto and ester carbonyl respectively. ¹H-NMR spectrum showed upfield chemical shifts for C-18 methyl at δ 0.63 as compared to compound **110** (C-18 methyl at δ 0.92). Reduction of C-20-keto compound **111** with NaBH₄ in the presence of CeCl₃ gave C-20(R) alcohol **112** as the major product which was purified by crystallization (5% CH₂Cl₂/ MeOH). IR spectrum of **112** showed a band at 1724 cm⁻¹ for ester carbonyl. The ¹H-NMR spectrum showed characteristic signal at δ 1.14 (d, J = 6.06 Hz, 3H) for 21-CH₃, and chemical shifts for C-18 methyl at δ 0.77. Iodination of compound **112** was carried out using Corey's iodination procedure⁶⁰ which involves the transformation of primary and secondary alcohols into the corresponding iodides by treatment with a mixture of PPh₃-I₂-imidazole in dichloromethane. However, instead of C-20-iodo compound **113**, a complex mixture of products was obtained. From this mixture 17(20)-ene product **114** was identified as the major product along with minor amount of C-20 deoxygenated product **115**. Both these products were characterized by ¹H NMR and ¹³C NMR. Compound **114** showed chemical shift of C-21 methyl at δ 1.14 (d, J = 6.06 Hz, 3H) and

C-20 proton at δ 5.14 (m, 1H) while in ^{13}C NMR, quaternary C-17 carbon was observed at δ 150.0 and C-20 carbon at δ 113.5. There is a report⁶¹ in which $\text{PPh}_3\text{-I}_2$ reagent has been used for the dehydration of tertiary alcohols. In case of compound **112** dehydration reaction was observed for secondary alcohol to give C-17(20)-ene product **114**. To avoid the C-17(20)-ene product, iodination reaction was done on C-20(R)-alcohol **116a** and C-20(S)-alcohol **116b** in which 16(17) double bond was kept intact.

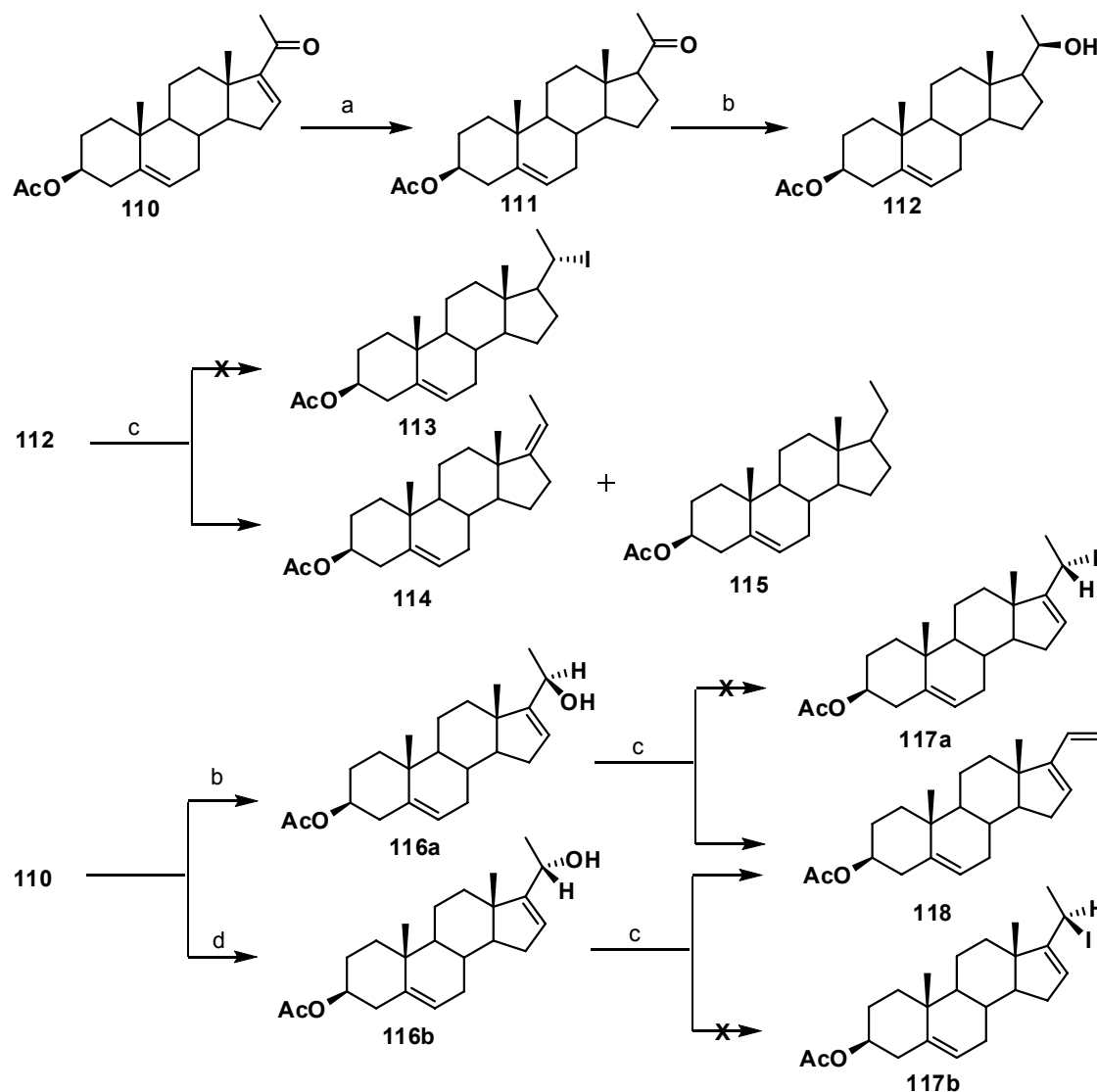

Scheme 25 Reagents and conditions: (a) 10% Pd/C, H_2 , EtOAc, 45 psi, 25-30 $^\circ\text{C}$, 12 h 98%; (b) CeCl_3 , NaBH_4 , MeOH; (c) **Path A**: PPh_3 , imidazole, I_2 , Triethylamine, CH_2Cl_2 or **Path B**: NaI, $\text{BF}_3\text{-Et}_2\text{O}$, acetonitrile; (d) Zn, HOAc.

C-20 (R)-alcohol **116a** was synthesized by reduction of 16-DPA **110** with NaBH_4 in the presence of CeCl_3 to give **116a** as a major product, which was purified by crystallization. ^1H -NMR spectrum of **116a** showed characteristic signal at δ 1.35 (d, $J = 6.44$ Hz) for 21-

CH₃, chemical shifts for C-18 methyl at δ 0.91 and C-20-(CHOH) was observed at δ 4.35 (q, $J = 6.44$ Hz, 1H). When the reduction of **110** was carried out using excess of zinc in acetic acid, C-20(S)-alcohol **116b** was obtained as a single product.⁶² ¹H-NMR spectrum of **116b** showed characteristic signal at δ 1.36 (d, $J = 6.44$ Hz) for 21-CH₃, chemical shifts for C-18 methyl at δ 0.87 and C-20-(CHOH) was observed at δ 4.38 (q, $J = 6.44$ Hz, 1H). Iodination was carried out on both the alcohols **116a** and **116b** using PPh₃-I₂-imidazole. In these reactions, instead of C-20-iodo compound **117a** or **117b**, 5(6),16(17) and 20(21) triene compound **118** was obtained as a major product. This compound showed characteristic chemical shift of δ 4.96 and 5.33 (Two d, $J = 18.0$ and 11.25 Hz, 2H) due to C-21-CH₂ and 6.28 and 6.30 (dd, $J = 18$ and 11.25 Hz, 1H) due to C-20-proton while in ¹³C NMR methylene at C-21 was observed at δ 112.8. There is a report in which NaI/BF₃-Et₂O is used as mild reagent for the conversion of allylic or benzylic alcohols into corresponding iodides.⁶³ However, when iodination was tried using this reagent for alcohols **116a** and **116b**, same triene **118** was obtained as sole product.

Since the synthesis of C-20-iodo compound was not realized using the above iodination methods, we thought of utilizing C-20-vinyl iodide **120** for our projected synthesis (Scheme 26). Chemoselective hydrogenation of 16-DPA **110** with 10% Pd-C in ethyl acetate followed by reaction with hydrazine hydrate in methanol/dichloromethane afforded C-20-hydrazone product **119** in 98% yield. This compound **119** showed characteristic up field chemical shift of δ 0.59 (s, 3H) due to 18-CH₃ and 1.76 (s, 3H) due to 21-CH₃. In ¹³C NMR quaternary carbon (C-20 hydrazone) was observed at δ 151.5. Oxidation of hydrazone **119** by iodine in the presence of triethylamine in THF gave vinyl iodide **120** in good yield.⁶⁴ In ¹H NMR compound **120** showed different chemical shift of both geminal C-21 methylene protons. One proton showed chemical shift of δ 5.98 (d, $J = 1.51$ Hz, 1H), while another at δ 6.15 (bs, 1H). In ¹³C NMR methylene at C-21 was observed at δ 126.1.

There are few reports on palladium catalyzed carbon-carbon bond forming reactions of steroidal vinyl iodide or vinyl triflate with alkenes and terminal alkynes.⁶⁵ Skoda-Foldes and coworkers reported Heck reaction of C-17-iodo-androst-16-ene with allyl acetates or methyl acrylate in the presence of catalytic amount of Pd(OAc)₂ and triethyl amine or K₂CO₃ as base.⁶⁶

In the present investigation, we carried out Heck coupling reaction of C-20-vinyl iodide **120** with methyl acrylate, using catalytic amount of Pd(OAc)₂ and K₂CO₃ in DMF

at 60-100 °C. Instead of expected coupling product **121**, complex mixture of products was obtained.

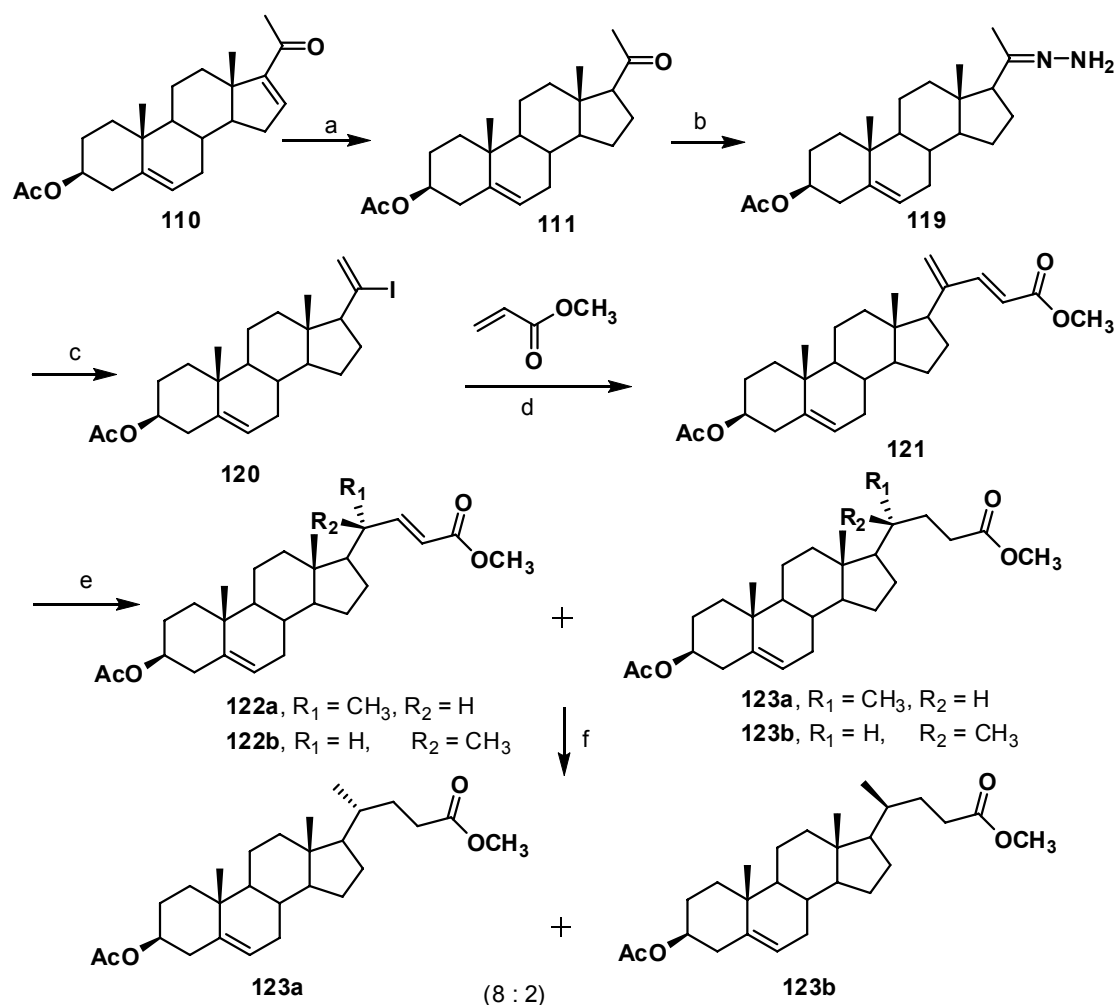

Scheme 26 Reagents and conditions: (a) 10% Pd/C, H₂, EtOAc, 45 psi, 25-30 °C, 12 h, 98%; (b) Hydrazine hydrate, Triethylamine, MeOH, 25-30 °C (c) I₂, Triethylamine, THF, 25-30 °C; (d) Pd(OAc)₂ (0.04%) K₂CO₃, DMF, 25-30 °C, 12h; (e) triethylsilane (excess), 15-20 min.; (f) 10-20% Pd-C (by weight), MeOH,

The same reaction was carried out using catalytic amount of Pd(OAc)₂ and PPh₃ at 60-100 °C or by changing Pd(PPh₃)₄ instead of Pd(OAc)₂. Under these reaction conditions, instead of expected coupling product **121**, complex mixture of products was obtained. To optimize the reaction conditions, the reaction was carried out using catalytic amount of Pd(OAc)₂ and K₂CO₃ in DMF at 25-30 °C (room temperature) 80% conversion of starting material was observed (on the basis of recovered starting material) and expected product **121** was obtained in 77% yield. Increase in catalyst amount or extended reaction time did not improve the yield.

IR spectrum of **121** showed a band at 1724 and 1668 cm⁻¹ for C-3-acetate carbonyl and C-24 methyl ester carbonyl respectively. ¹H-NMR spectrum showed characteristic

signals at δ 5.34 and 5.55 (s, 2H) for C-21-CH₂ and δ 6.02 (d, J = 15.95 Hz, 1H), 7.36 (d, J = 15.95 Hz, 1H) for and C-23 and C-22 CH respectively. C-24 Methyl ester showed chemical shift at δ 3.76. In ¹³C NMR C-24 carbonyl was observed at δ 167.6 and C-21 CH₂ at δ 122.

Our next goal was stereoselective hydrogenation of C-20(21) double bond to obtain single C-20(R) isomer. There are reports (as discussed in introduction) for the hydrogenation of C20(21) or C20(22) double bond by using different catalysts such as H₂, Pd/C, PtO₂ or Rhodium which give epimeric mixture at C-20. Platinum oxide catalyzed hydrogenation of C-20(21) double bond gives better selectivity when there is bulky group adjacent to C-20 (Scheme 20-23). Recently there is a report⁶⁷ in which Pd-C induced catalytic transfer hydrogenation using triethylsilane gives efficient reduction of multiple bonds, azides, imines, and nitro groups as well as benzyl group and allyl group deprotection, under mild neutral conditions. We carried out hydrogenation of compound **121** using triethylsilane and 15% Pd/C in methanol to afford compounds **122** and **123** as an epimeric mixture at C-20 within 10 min. In ¹H NMR (Figure 3) of this mixture, C20(21) double bond was observed to be completely hydrogenated (disappearance of chemical shift at δ 5.34 (s, 1H, 21-CH₂), and 5.55 (s, 1H, 21-CH₂) while C-22 and C-23 α,β olefinic protons shifted at δ 6.90 (dd, 1H, J = 16 and 10 Hz, C-22-H) and 5.73 (d, 1H, J = 16Hz, C-22-H).

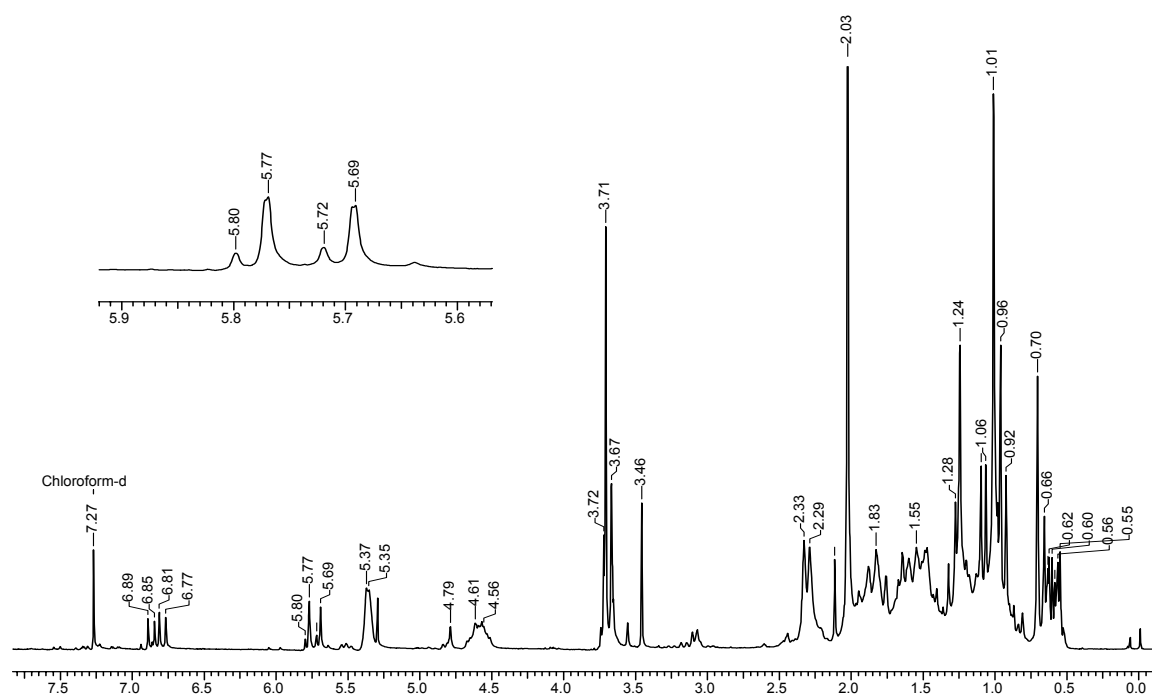
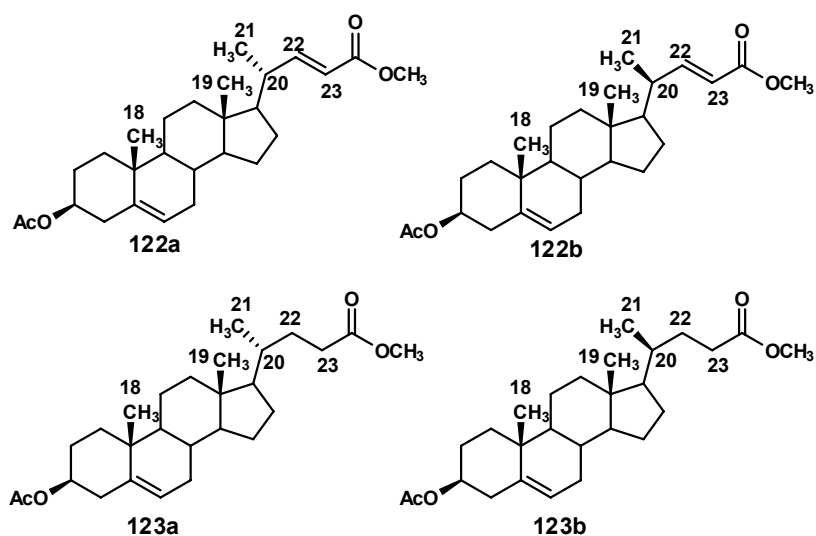

Figure 3

We tried complete hydrogenation of both C-20(21) and C-22(23) double bonds by increasing the reaction time up to 12 h and by increasing the percentage of catalyst as well as triethylsilane. However, under all these conditions we obtained the same mixture of products. In ^1H NMR of this mixture, chemical shifts due to major product were observed at δ 5.73 (d, $J = 16\text{Hz}$, C-22-H) and 1.09 (d, $J = 6.57\text{ Hz}$, C-21- CH_3) (Figure 3). These chemical shifts match with the literature chemical shift of compound **122a** as depicted in Figure 4. This clearly indicate that during the Pd-C induced catalytic transfer hydrogenation using triethylsilane gives C-20(R)- natural isomer as a major product.



Compound	Chemical shift in δ					
	COOCH_3	C23 (CH)	C22 (CH)	C21 (CH_3)	C19 (CH_3)	C18 (CH_3)
122a	3.72	5.74 (d)	6.87 (dd)	1.10 (d)	1.03	0.74
122b	3.73	5.81 (d)	6.90 (dd)	0.99 (d)	0.97	0.64
123a	3.68			0.92 (d)	1.03	0.69
123b	3.67			0.85 (d)	1.02	0.69

Figure 4

Further hydrogenation of this mixture using $\text{H}_2/\text{Pd-C}$ in ethyl acetate gave a mixture of compound **123a** and **123b** in 8:2 ratio [calculated by ^1H NMR chemical shift of methyl ester of the compound as shown in Figure 5]. From this mixture, cholanic acid derivative **123a** having C-20(R)-natural isomer, was purified as a major compound by crystallization from DCM-Methanol (1:9). In ^1H NMR of **123a** signal at δ 0.67 (s, 3H, 18- CH_3), 0.92 (d,

$J = 6.33$ Hz, 3H, 21-CH₃), 1.01 (s, 3H, 19-CH₃) match with the literature values for this compound.

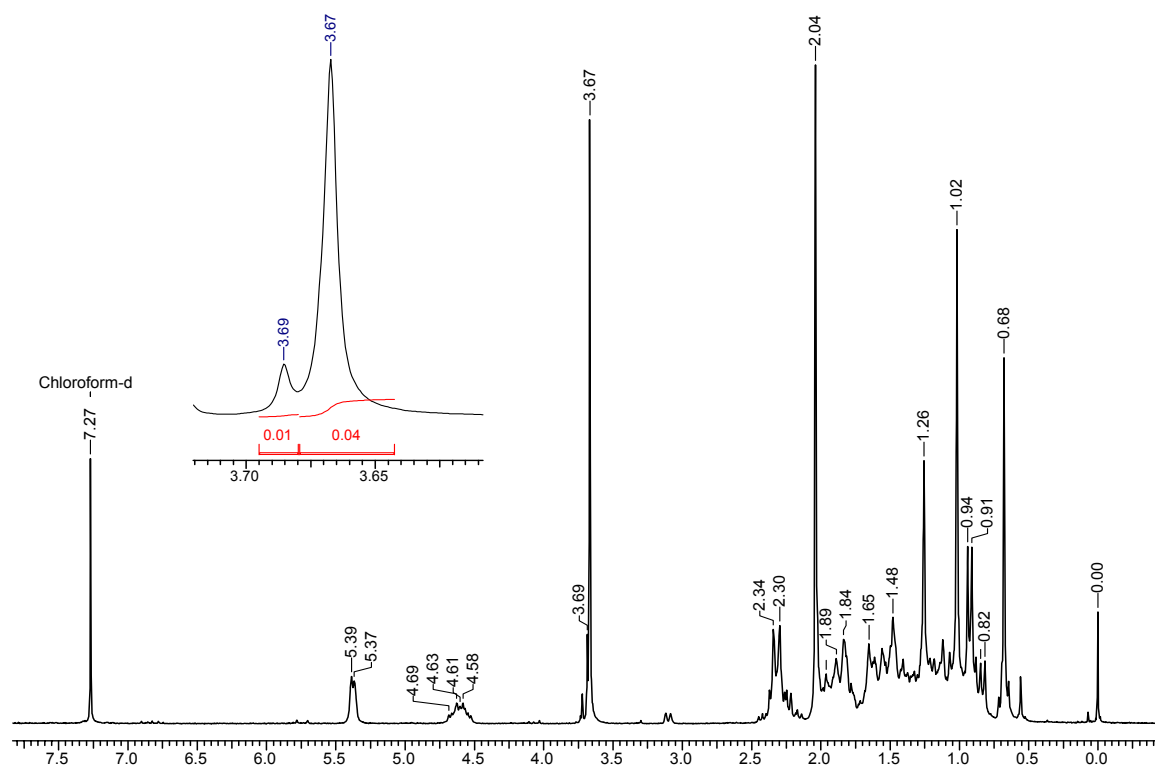

Figure 5

The stereochemistry of compound **123a** at C-20 was confirmed by single crystal x-ray. (Figure 6).

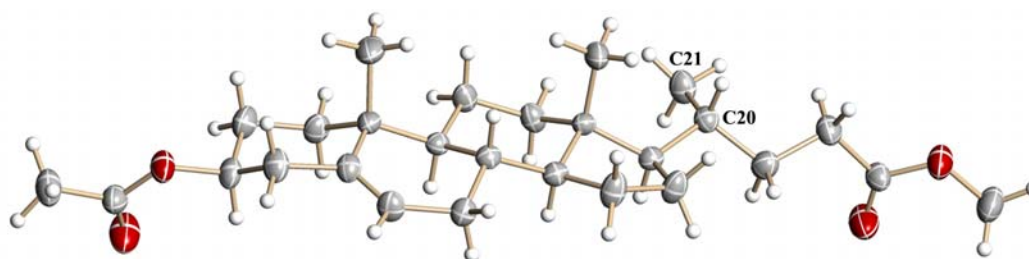

Figure 6 ORTEP view of Methyl (20R)-3β-acetoxychol-5-enoate **123a**.

Cholanic acid is a key intermediate for the synthesis of number of biologically active steroids having natural C-20(R)-configuration such as squalamine, brassinosteroids, OSW-1 etc. on modification as shown in Figure 7

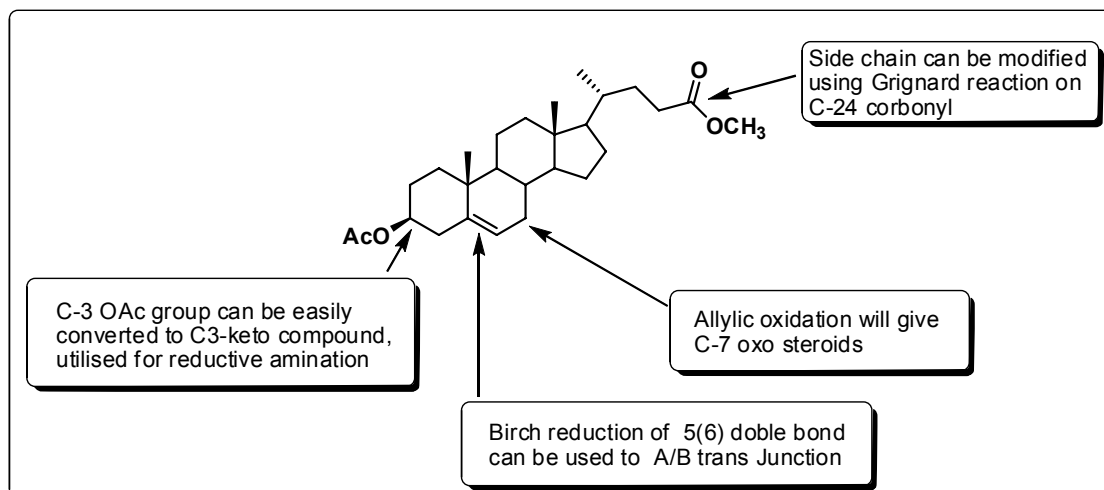

Figure 7

3.5 Conclusion

Stereoselective construction of steroidal side chain at C-20 position having ‘natural’ C-20(R)-configuration from 20 oxo steroid 16 dehydropregenalone (16 DPA) **110** has been archived. Palladium catalyzed carbon-carbon bond forming Heck reaction has been used for coupling between C-20-vinyl iodide **120** and methyl acrylate to form unsaturated compound **121**. Transfer hydrogenation using triethylsilane and Pd/C is the key step for stereoselective side chain synthesis.

Experimental section

16-dehydropregnenolone acetate (16 DPA) (110):

IR (cm^{-1}): 1662, 1724 cm^{-1} ; ^1H NMR (CDCl_3 , 200 MHz): δ 0.92 (s, 3H, 18- CH_3), 1.06 (s, 3H, 19- CH_3), 2.03 (s, 3H, OCOCH_3), 2.26 (s, 3H, 21- CH_3), 4.60 (m, 1H, 3-CH), 5.38 (d, $J = 4.7$ Hz, 1H, 6-CH), 6.71 (dd, $J = 3.3$ and 1.8 Hz, 1H, 16-CH); ^{13}C NMR (CDCl_3 , 50 MHz): δ 15.3, 18.8, 20.2, 21.0, 26.7, 27.3, 29.7, 31.1, 31.8, 34.2, 36.3, 36.5, 37.7, 45.6, 50.0, 55.9, 73.4, 121.6, 139.8, 144.1, 154.8, 170.0, 196.2.

3 β -Acetoxy-pregna-5-ene-20-one (111):

To a solution of 16-dehydropregnenolone acetate **110**, (2 g, 5.61 mmol) in ethyl acetate (100mL) was added 0.2g (10 mol %) 10% Pd-C catalyst. The hydrogenation was carried out using Parr apparatus at 45 psi at 30°C temperature for 16h. The reaction mixture was filtered through celite and the filtrate was concentrated and dried under vacuum to obtain

the saturated keto compound **111** (1.971 g, 98%), which was crystallized from ethyl acetate and hexane.

White solid; mp 144 °C (lit.²⁷ 143 °C); $[\alpha]_D^{26}$ (CHCl₃, c 0.2) = + 93.04; IR (cm⁻¹): 1701, 1724 cm⁻¹; ¹H NMR (CDCl₃, 200 MHz): δ 0.63 (s, 3H, 18-CH₃), 1.02 (s, 3H, 19-CH₃), 2.03 (s, 3H, OCOCH₃), 2.13 (s, 3H, 21-CH₃), 4.60 (m, 1H, 3-CH), 5.37 (d, *J* = 4.8 Hz, 1H, 6-CH); ¹³C NMR (CDCl₃, 50 MHz): δ 12.8, 18.9, 20.6, 21.0, 22.4, 24.1, 27.3, 31.1, 31.4, 31.4, 36.2, 36.6, 37.7, 38.4, 43.5, 49.5, 56.4, 63.2, 73.3, 121.9, 139.2, 169.9, 208.6; MS (LCMS) *m/z*: 359.51 (M + 1).

Reduction of compound 111 using NaBH₄ and CeCl₃·7H₂O:

To a solution of **111** (0.716 g, 2 mmol) in CH₂Cl₂ (10 mL) was added CeCl₃·7H₂O (0.744 g, 2 mmol) in methanol (20 mL). NaBH₄ (0.114 mg, 3 mmol) was added to the reaction mixture in one portion. The reaction mixture was stirred at 25 °C for 30 min, methanol was evaporated and the product was extracted with ethyl acetate (3x25 mL). The extract was washed with water and brine and it was dried over anhydrous Na₂SO₄. Solvent was removed under vacuum followed by crystallization from acetone-pet ether gave pure 20(S)-ol **112** (0.583 g, 80%).

3β-Acetoxy(20S)-hydroxy-pregna-5-ene (112): White solid; mp 123 °C; IR (cm⁻¹): 1724 cm⁻¹; ¹H NMR (CDCl₃, 200 MHz): δ 0.77 (s, 3H, 18-CH₃), 1.03 (s, 3H, 19-CH₃), 1.14 (d, *J* = 6.1 Hz 3H, 21-CH₃), 2.1 (s, 3H, OCOCH₃), 3.74 (m, 1H, 20-CH), 4.60 (m, 1H, 3-CH), 5.38 (d, *J* = 4.17 Hz, 1H, 6-CH); ¹³C NMR (CDCl₃, 50 MHz): δ 12.3, 19.3, 20.8, 21.4, 23.6, 24.5, 25.6, 27.7, 31.6, 31.8, 36.5, 37.0, 38.0, 35.7, 42.2, 50.0, 56.1, 58.4, 70.4, 73.9, 122.4, 139.7, 170.4; Anal. Calcd for C₂₃H₃₆O₃: C, 76.62; H, 10.06; Found: C, 76.50; H, 9.80; MS (LCMS) *m/z*: 361.53 (M + 1).

Iodination of compound 112:

Path A: To a suspension of PPh₃ (0.340 g, 1.3 mmol) in anhydrous dichloromethane (15 mL) at room temperature was added imidazole (0.088 g, 1.3 mmol) and iodine (0.328 g, 1.3 mmol) and it was stirred for 5 min. The alcohol **112** (0.360 g, 1 mmol) was then added to the reaction mixture and it was stirred at the same temperature for 3h. NaHSO₃ (15%) was added and the mixture was stirred for 10 min. Dichloromethane (100 mL) was added and the organic phase was washed with H₂O and brine solution, after which it was

dried over Na₂SO₄. Solvent was evaporated to give crude product. After purification by flash column chromatography (2% ethylacetate/pet-ether) gave pure compounds **114** (0.147 g) and **115** (0.035 g).

3 β -Acetoxy-(Z)-pregna-5,17(20)-diene (114): White solid; mp 159 °C; IR (cm⁻¹): 1724 cm⁻¹; ¹H NMR (CDCl₃, 200 MHz): δ 0.90 (s, 3H, 18-CH₃), 1.04 (s, 3H, 19-CH₃), 2.04 (s, 3H, OCOCH₃), 1.14 (d, J = 6.1 Hz 3H, 21-CH₃), 4.60 (m, 1H, 3-CH), 5.14 (m, 1H, 20-CH), 5.39 (d, J = 5.2 Hz, 1H, 6-CH); ¹³C NMR (CDCl₃, 50 MHz): δ 13.1, 16.5, 19.2, 21.1, 21.3, 24.4, 27.7, 31.3, 31.4, 31.6, 36.6, 36.9, 36.9, 38.1, 43.9, 50.0, 56.4, 73.8, 113.5, 122.4, 139.6, 150.0, 170.4; Anal. Calcd for C₂₃H₃₄O₂: C, 80.65; H, 10.01; Found: C, 80.51; H, 9.87; MS (LCMS) m/z : 343.51 (M + 1),

3 β -Acetoxy -pregna-5-ene (115): White solid; IR (cm⁻¹): 1724 cm⁻¹; ¹H NMR (CDCl₃, 200 MHz): δ 0.58 (s, 3H, 18-CH₃), 0.88 (t, J = 6.6 Hz, 3H 21-CH₃)1.03 (s, 3H, 19-CH₃), 2.04 (s, 3H, OCOCH₃), 4.60 (m, 1H, 3-CH), 5.38 (d, J = 4.6 Hz, 1H, 6-CH). MS (LCMS) m/z : 345.53 (M + 1).

Path B: A: To a stirred mixture of the alcohol **112** (0.360 g, 1 mmol) and sodium iodide (0.30 g, 2 mmol) in dry acetonitrile (10 mL), was added a solution of freshly distilled BF₃.Et₂O (0.26 mL, 2 mmol) in acetonitrile (2 mL) during 15 min at 0 °C. The stirring was continued at 25 °C for 1 h. The reaction mixture was poured into ice cold water (20 mL), treated with aq. solution (15%) of NaHSO₃ and then extracted with diethylether (3x15 mL). The combined ether extracts were washed with water (2x50 mL), brine (10 mL) and then dried over anhydrous Na₂SO₄. Evaporation of the solvent gave crude product which was purified by flash column chromatography over silica gel with 1% ethyl acetate/petroleum ether to obtain same compound **114** (0.135 g) as major product.

Reduction of compound 110 using NaBH₄ and CeCl₃.7H₂O:

Reduction of compound **110** was carried out using similar procedure used for synthesis of compound **112**. Recrystallization from acetone-pet.ether gave pure major product C-20(R)-ol, **116a**.

3 β -Acetoxy(20R)-hydroxy-pregna-5,16(17)-diene (116a): White solid; mp 144-145 °C; $[\alpha]_D^{26}$ (CHCl₃, c 0.12) = + 68.04; IR (cm⁻¹): 1724 cm⁻¹; ¹H NMR (CDCl₃, 200 MHz): δ

0.91 (s, 3H, 18-CH₃), 1.06 (s, 3H, 19-CH₃), 1.35 (d, $J = 6.4$ Hz 3H, 21-CH₃), 2.03 (s, 3H, OCOCH₃), 4.35 (q, $J = 6.4$ Hz 1H, 20-CH), 4.60 (m, 1H, 3-CH), 5.39 (d, $J = 4.7$ Hz, 1H, 6-CH), 5.66 (t, $J = 1.5$ Hz, 1H, 16-CH); ¹³C NMR (CDCl₃, 50 MHz): δ 16.7, 19.2, 20.6, 21.3, 23.4, 27.7, 30.3, 30.9, 31.5, 35.0, 36.7, 36.9, 38.1, 46.0, 50.5, 57.3, 65.6, 73.8, 122.3, 122.9, 139.9, 159.5, 170.5; Anal. Calcd for C₂₃H₃₄O₃: C, 77.05; H, 9.56; Found: C, 76.91; H, 9.39; MS (LCMS) m/z : 359.51 (M + 1).

Reduction of compound 110 using Zn in glacial HOAc:

16-DPA (1 g, 2.8 mmol) and zinc dust (5 g), in glacial acetic acid (50 mL), was stirred vigorously at 25 °C for 16h. The whole mixture was filtered and the Zn precipitate washed with CH₂Cl₂ (200 mL). The filtrate was washed with water, 5% aqueous NaHCO₃ and then water. Evaporation of the solvent gave a solid residue. Recrystallization from acetone-pet-ether gave pure C-20(S)-ol **116b** (0.607 g, 60%).

3 β -Acetoxy(20S)-hydroxy-pregna-5,16(17)-diene (116b): White solid; mp 126-129 °C; $[\alpha]_D^{26}$ (CHCl₃, c 0.17) = + 65.04; IR (cm⁻¹): 1724 cm⁻¹; ¹H NMR (CDCl₃, 200 MHz): 0.87 (s, 3H, 18-CH₃), 1.06 (s, 3H, 19-CH₃), 1.36 (d, $J = 6.4$ Hz 3H, 21-CH₃), 2.03 (s, 3H, OCOCH₃), 4.38 (q, $J = 6.4$ Hz 1H, 20-CH), 4.60 (m, 1H, 3-CH), 5.40 (d, $J = 4.4$ Hz, 1H, 6-CH), 5.63 (t, $J = 1.5$ Hz, 1H, 16-CH); ¹³C NMR (CDCl₃, 50 MHz): 16.7, 19.2, 20.6, 21.3, 23.4, 27.7, 30.3, 30.9, 31.5, 35.0, 36.7, 36.9, 38.1, 46.0, 50.5, 57.3, 65.6, 73.8, 122.3, 122.9, 139.9, 159.5, 170.5; Anal. Calcd for C₂₃H₃₄O₃: C, 77.05; H, 9.56; Found: C, 76.81; H, 9.33; MS (LCMS) m/z : 359.51 (M + 1).

Iodination of 116a and 116b:

Iodination of compound **116a** and **116b** was carried out using similar procedure used for compound **112**. Instead of **117a** or **117b** we obtained **118** as a major product.

3 β -Acetoxy-pregna-5,16,20-triene (118): White solid; mp 131-134 °C; IR (cm⁻¹): 1724 cm⁻¹; ¹H NMR (CDCl₃, 200 MHz): δ 0.93 (s, 3H, 18-CH₃), 1.07 (s, 3H, 19-CH₃), 2.03 (s, 3H, OCOCH₃), 4.60 (m, 1H, 3-CH), 4.96 and 5.33 (Two d, $J = 18.0$ and 11.3 Hz, 2H, 21-CH₂), 5.40 (d, $J = 6.7$ Hz, 1H, 6-CH), 5.71 (bs, 1H, 16-CH), 6.28 and 6.30 (dd, $J = 18$ and 11.3 Hz, 1H, 20-CH); ¹³C NMR (CDCl₃, 50 MHz): δ 15.8, 19.2, 19.3, 20.8, 21.4, 22.6, 27.7, 30.2, 31.2, 31.5, 35.2, 36.7, 36.8, 38.1, 46.0, 50.4, 57.2, 73.9, 112.8, 122.4, 129.4,

132.3, 139.9, 153.1, 170.6; Anal. Calcd for C₂₃H₃₂O₂: C, 81.13; H, 9.47; Found: C, 80.94; H, 9.31; MS (LCMS) *m/z*: 341.50 (M + 1).

3β-Acetoxy -pregna-5-ene-20 hydrazone (119):

To the solution of ketone **111** (0.356g, 1mmol) in methanol (20 mL) triethylamine (1.4 mL, 10 mmol) and hydrazine hydrate (99%) (0.18 mL, 3.5 mmol) were added. Reaction was stirred for 4 h at 25 °C. Solvent was evaporated and the product was extracted with ethyl acetate (3x25 mL). The extract was washed with water and brine and it was dried over anhydrous Na₂SO₄. Solvent was removed under vacuum to give pure **119** (0.364 g) in 98% yield.

White solid; mp 168 °C; [α]_D²⁶ (CHCl₃, c 0.21) = + 71.04; IR (cm⁻¹): 1724, 3389 cm⁻¹; ¹H NMR (CDCl₃, 200 MHz): δ 0.59 (s, 3H, 18-CH₃), 1.02 (s, 3H, 19-CH₃), 1.76 (s, 3H, 21-CH₃), 2.04 (s, 3H, OCOCH₃), 4.61 (m, 1H, 3-CH), 4.92 (bs, 2H, NH₂) 5.38 (d, *J* = 4.67 Hz, 1H, 6-CH); ¹³C NMR (CDCl₃, 50 MHz): δ 13.0, 15.4, 19.2, 20.8, 21.2, 22.9, 24.1, 27.6, 31.6, 31.8, 36.4, 36.8, 37.9, 38.7, 43.7, 49.9, 56.0, 58.8, 73.7, 122.3, 139.4, 151.5, 170.3; Anal. Calcd for C₂₃H₃₆N₂O₂: C, 74.15; H, 9.74; N, 7.52; Found: C, 73.86; H, 9.57; N, 7.35; MS (LCMS) *m/z*: 373.54 (M + 1).

3β-Acetoxy-20-iodopregna-5,20-diene (120):

To the stirred solution Iodine (0.762 g, 3 mmol) in dry THF (20 mL) triethylamine (8.4 mL, 60 mmol) was added. Hydrazone **119** (0.372 g, 1 mmol) dissolved in THF (10 mL) was added dropwise to the reaction mixture. Stirring was continued for 3h. Solvent was evaporated and the residue was purified by column chromatography over silica gel (10% Ethylacetate/Pet-ether) gave vinyl iodide **120** (0.355 g) in 74% yield.

White solid; mp 142-144 °C; [α]_D²⁶ (CHCl₃, c 0.22) = + 89.04; IR (cm⁻¹): 1724 cm⁻¹; ¹H NMR (CDCl₃, 200 MHz): δ 0.71 (s, 3H, 18-CH₃), 1.03 (s, 3H, 19-CH₃), 2.04 (s, 3H, OCOCH₃), 4.61 (m, 1H, 3-CH), 5.38 (d, *J* = 4.6 Hz, 1H, 6-CH), 5.98 (d, *J* = 1.5 Hz, 1H, 21-CH₂), 6.15 (bs, 1H, 21-CH₂); ¹³C NMR (CDCl₃, 50 MHz): δ 12.8, 19.3, 20.8, 21.4, 23.9, 27.6, 28.7, 31.6, 32.0, 36.5, 36.9, 38.0, 38.3, 43.9, 50.0, 56.2, 62.3, 73.7, 111.3, 122.2, 126.1, 139.6, 170.4; Anal. Calcd for C₂₃H₃₃IO₂: C, 58.98; H, 7.10; Found: C, 58.81; H, 6.91; MS (LCMS) *m/z*: 469.41 (M + 1).

Methyl (20(21),22)-3 β -acetoxychol-5-trienoate (121):

To a solution of vinyl iodide **120** (0.234 g, 0.5 mmol) in dry DMF (10 mL), methyl acrylate (0.9 mL 1 mmol), Pd-catalyst (0.005 g, 0.02 mmol), and K₂CO₃ (0.414 g, 1.5 mmol) were added and the reaction mixture was stirred under argon at 25-28 °C for 12 h. Ice was added to the reaction mixture and it was extracted with ethylacetate (3x25 mL), washed 5% HCl (2x25 mL), saturated aqueous NaHCO₃ (20 mL), and brine and dried over Na₂SO₄. The product was purified by chromatography on silica gel (2% ethyl acetate/pet ether) to give pure product **121** (0.163 g) in 77% yield and starting material **120** (0.047 g).

White solid; mp 153 °C; $[\alpha]_D^{26}$ (CHCl₃, c 0.2) = + 81.04; IR (cm⁻¹): 1691, 1724 cm⁻¹; ¹H NMR (CDCl₃, 200 MHz): δ 0.56 (s, 3H, 18-CH₃), 1.02 (s, 3H, 19-CH₃), 2.04 (s, 3H, OCOCH₃), 3.76 (s, 3H, COOCH₃), 4.61 (m, 1H, 3-CH), 5.34 (s, 1H, 21-CH₂), 5.38 (d, J = 5.0 Hz, 1H, 6-CH), 5.55 (s, 1H, 21-CH₂), 6.02 (d, J = 16.0 Hz, 1H, 23-CH), 7.36 (d, J = 16.0 Hz, 1H, 22-CH); ¹³C NMR (CDCl₃, 50 MHz): δ 12.8, 19.2, 20.9, 21.3, 24.2, 26.3, 27.6, 31.7, 32.3, 36.5, 36.9, 38.0, 38.6, 43.2, 50.0, 51.1, 51.5, 56.6, 73.8, 117.3, 122.0, 122.3, 139.6, 144.0, 149.1, 167.6, 170.4; Anal. Calcd for C₂₇H₃₈IO₄: C, 76.02; H, 8.98; Found: C, 75.79; H, 8.78; MS (LCMS) m/z : 427.58 (M + 1).

Hydrogenation of compound 121:

To a stirred solution of compound **121** (0.100 g 0.24 mmol) in MeOH (4 mL) 10% Pd-C (0.015 g, 15% by weight) was added under an argon-filled balloon. Neat Et₃SiH (TES) (0.4 mL, 2.4 mmol) was added dropwise to the reaction mixture. Within 10 min the reaction was complete. The reaction mixture was filtered through celite and the solvent was removed under vacuum. The product was purified on column to furnish mixture of compounds **122** and **123**. Catalytic hydrogenation of this mixture was carried out using 10% Pd-C catalyst at 45 psi, at 30 °C for 10 h. The reaction mixture was filtered through celite and the filtrate was evaporated under reduced pressure. Crystallization of the crude product from 10 mL methanol:dichloromethane (9:1) gave major product C-20(R)-ol, **123a** (0.063 g) and small amount of minor product C-20(R)-ol **123b** was isolated after repeated crystallizations.

Methyl (20R)-3 β -acetoxychol-5-en-24-oate (123a): White solid; mp 160-162 °C; $[\alpha]_D^{26}$ (CHCl₃, c 0.5) = + 45.2; IR (cm⁻¹): 1724 cm⁻¹; ¹H NMR (CDCl₃, 200 MHz): δ 0.67 (s, 3H, 18-CH₃), 0.92 (d, J = 6.3 Hz, 3H, 21-CH₃), 1.01 (s, 3H, 19-CH₃), 2.03 (s, 3H,

OCOCH₃), 3.66 (s, 3H, COOCH₃), 4.60 (m, 1H, 3-CH), 5.36 (d, $J = 5.0$ Hz, 1H, 6-CH); ¹³C NMR (CDCl₃, 50 MHz): δ 11.8, 18.3, 19.3, 21.0, 21.4, 24.2, 27.7, 28.1, 31.0, 31.0, 31.8, 31.9, 35.3, 36.5, 37.0, 38.1, 39.7, 42.3, 50.0, 51.4, 55.7, 56.6, 73.9, 122.5, 139.6, 170.4, 174.7; Anal. Calcd for C₂₇H₄₂O₄: C, 75.31; H, 9.83; Found: C, 75.27; H, 9.71; MS (LCMS) m/z : 431.62 (M + 1).

Crystallographic data for compound 123a: Empirical formula : C₂₇H₄₂O₄, Formula weight : 430.61, Temperature, 297(2) K, Wavelength, 0.71073 Å, Crystal system, space group, Monoclinic, P21, Unit cell dimensions, a = 11.0178(18) Å alpha = 90 deg. b = 7.4633(13) Å beta = 92.080(3) deg. c = 14.950(3) Å gamma = 90 deg., Volume 1228.5(4) Å³, Z, Calculated density, 2, 1.164 Mg/m³, Absorption coefficient, 0.076 mm⁻¹, F(000) 472, Crystal size, 0.40 x 0.29 x 0.03 mm, Theta range for data collection 1.36 to 25.99 deg, Limiting indices, -13$=h$=13, -9$=k$=9, -18$=l$=17, Reflections collected / unique 9650 / 4755 [R(int) = 0.0275], Completeness to theta = 25.99, 99.9 %, Absorption correction, Semi-empirical from equivalents, Max. and min. transmission 0.9977 and 0.9702, Refinement method, Full-matrix least-squares on F², Data / restraints / parameters, 4755 / 1 / 285, Goodness-of-fit on F², 1.182, Final R indices [I>2sigma(I)] R1 = 0.0655, wR2 = 0.1285, R indices (all data), R1 = 0.0784, wR2 = 0.1346, Largest diff. peak and hole, 0.194 and -0.174 e.Å⁻³.

Methyl (20S)-3β-acetoxychol-5-en-24-oate (123b):

White solid mp: 120–121 °C; ¹H NMR (CDCl₃, 200 MHz): δ 0.69 (s, 3H, 18-CH₃), 0.85 (d, $J = 4$ Hz, 3H, 21-CH₃), 1.02 (s, 3H, 19-CH₃), 2.03 (s, 3H, OCOCH₃), 3.67 (s, 3H, COOCH₃), 4.63 (m, 1H, 3-CH), 5.38 (d, $J = 5.0$ Hz, 1H, 6-CH).

3.7 Selected Spectra

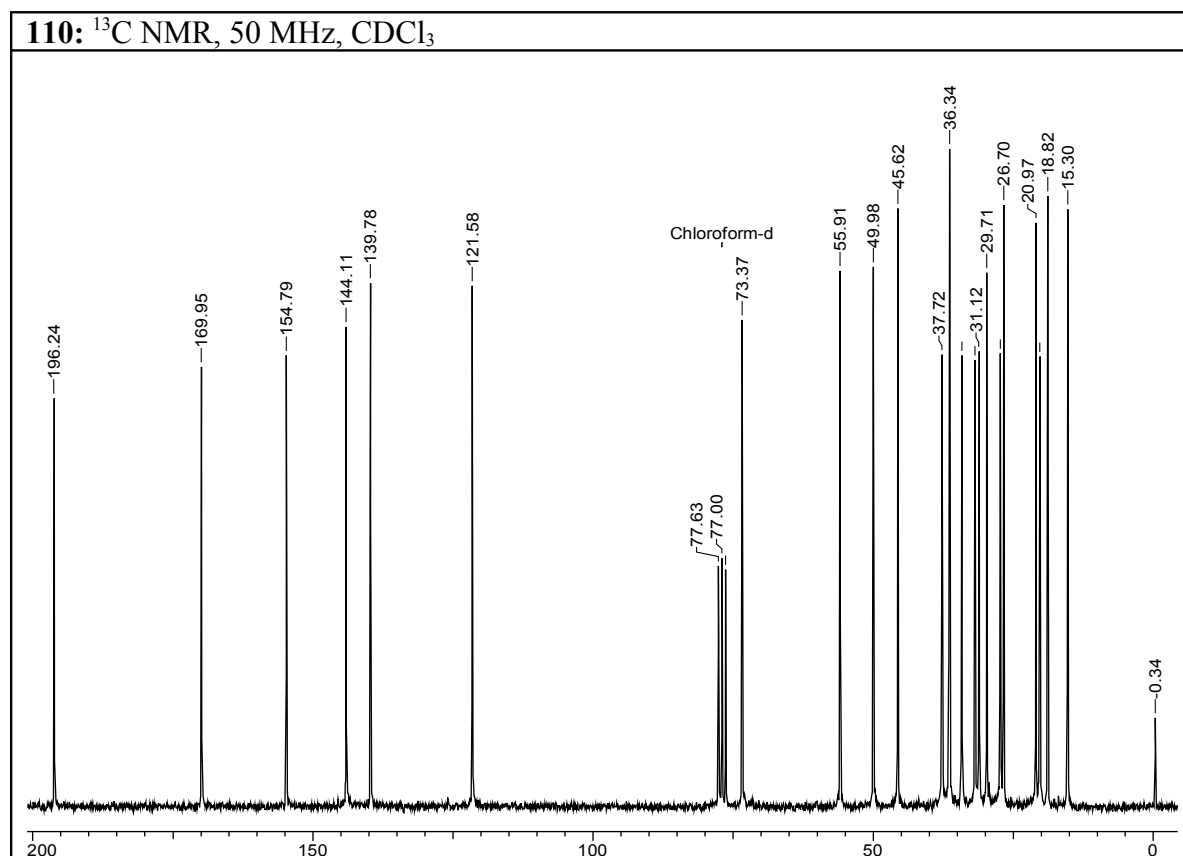
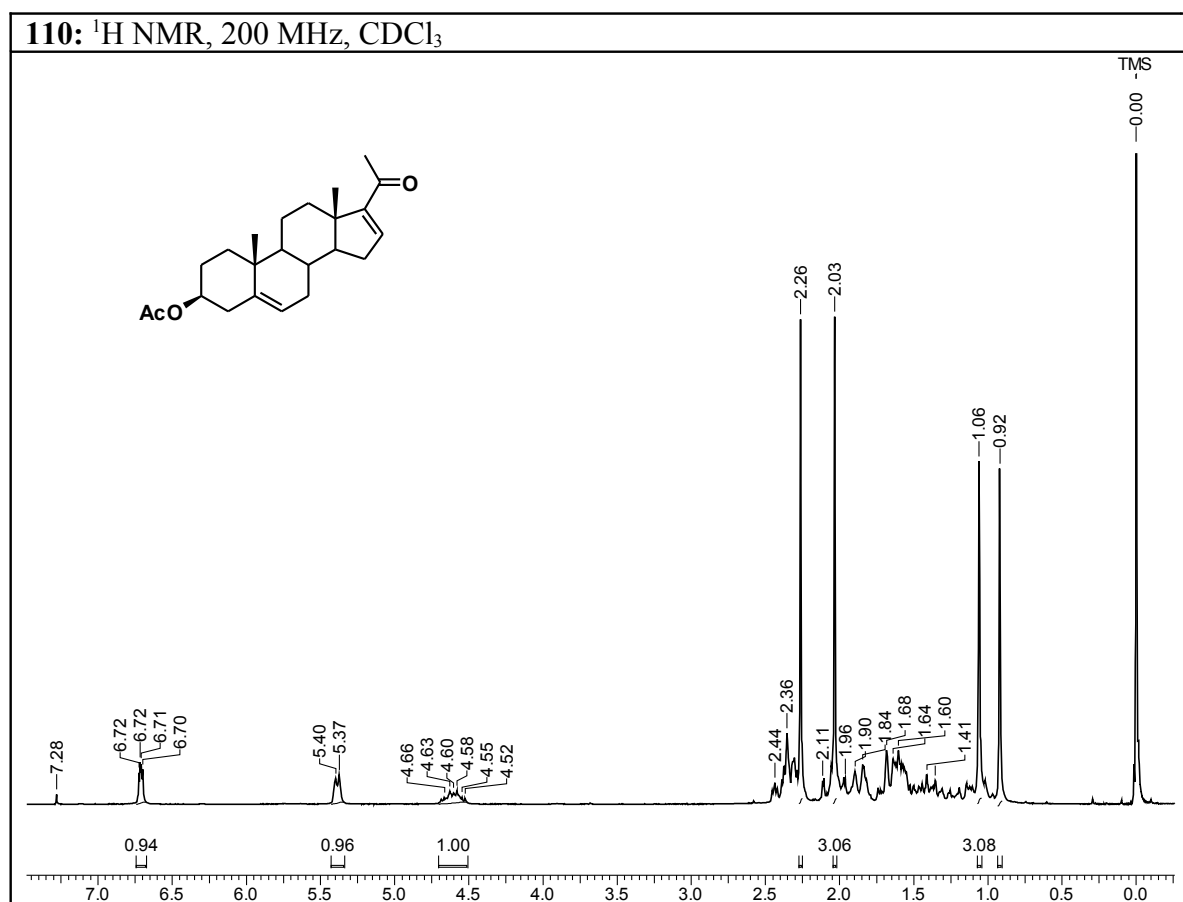

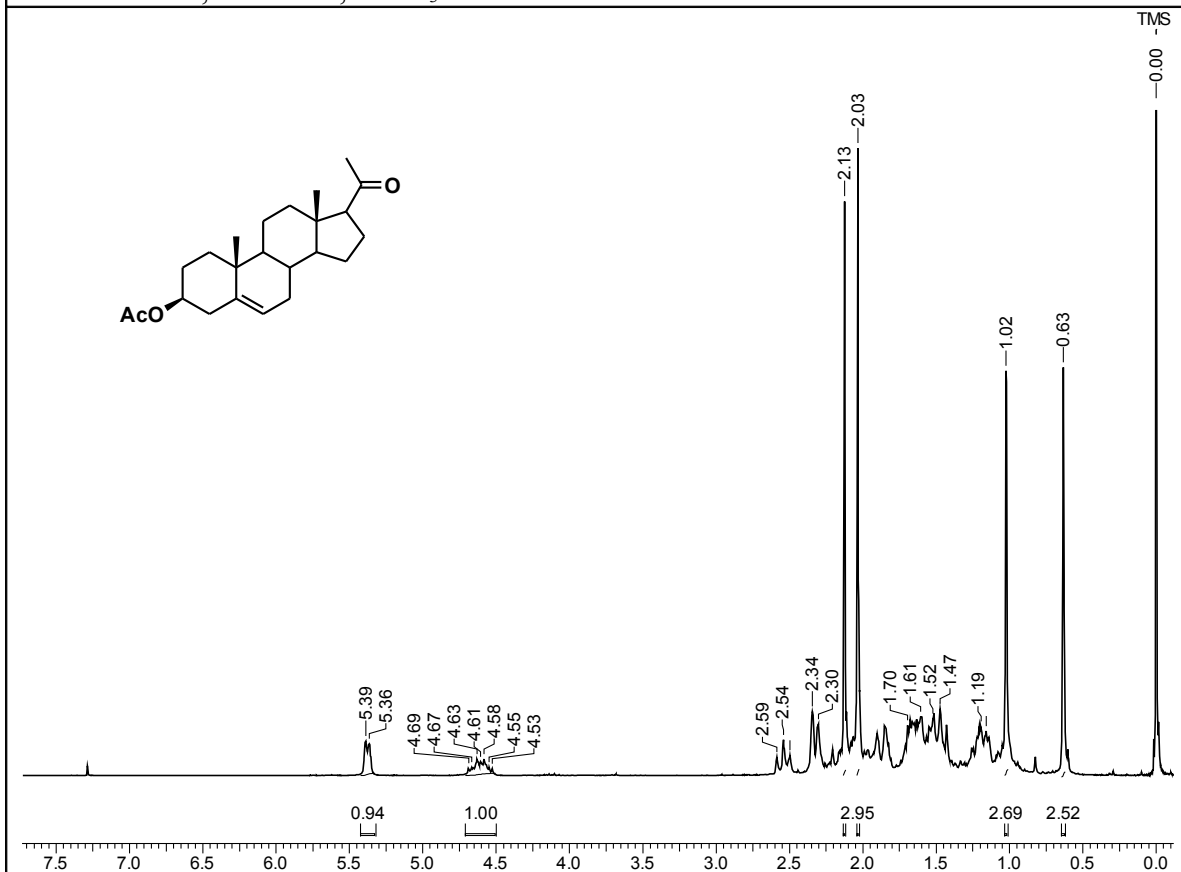
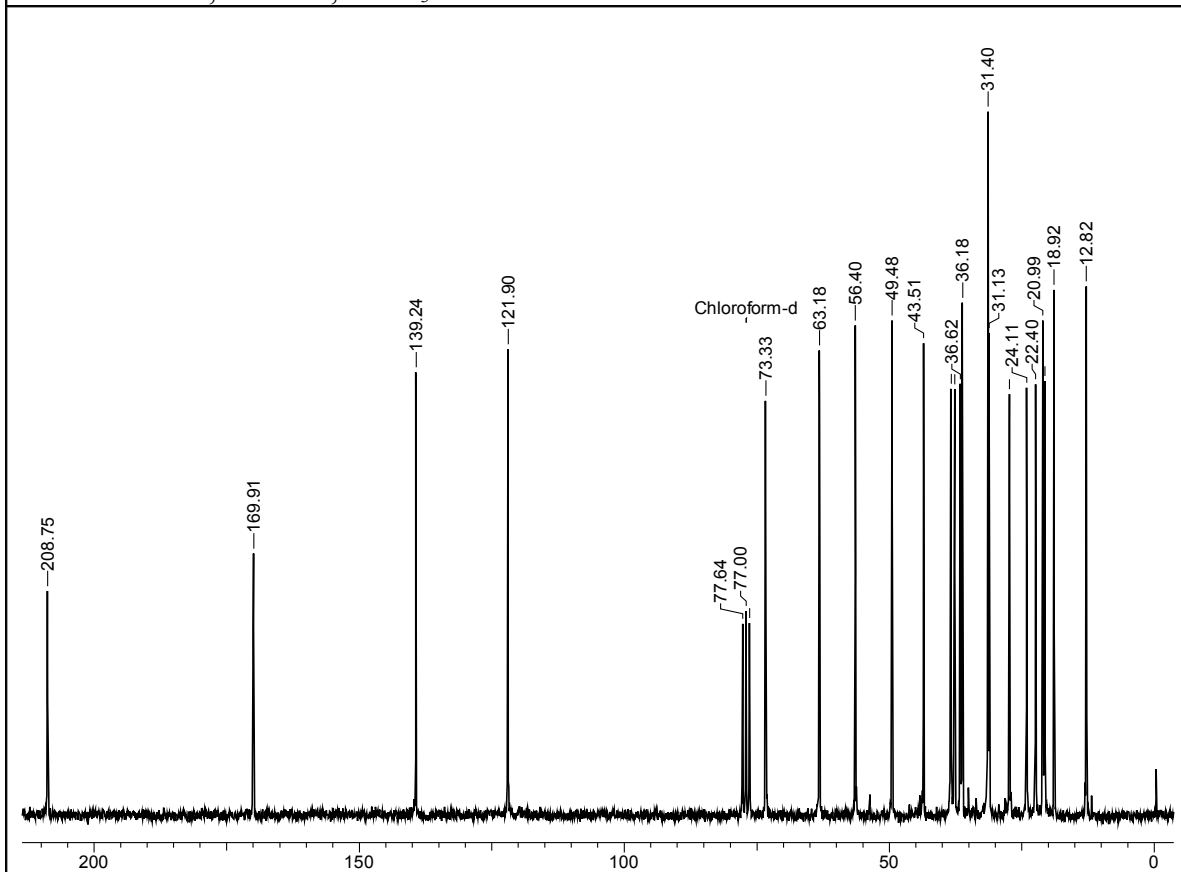
111: ^1H NMR, 200 MHz, CDCl_3 **111:** ^{13}C NMR, 50 MHz, CDCl_3 

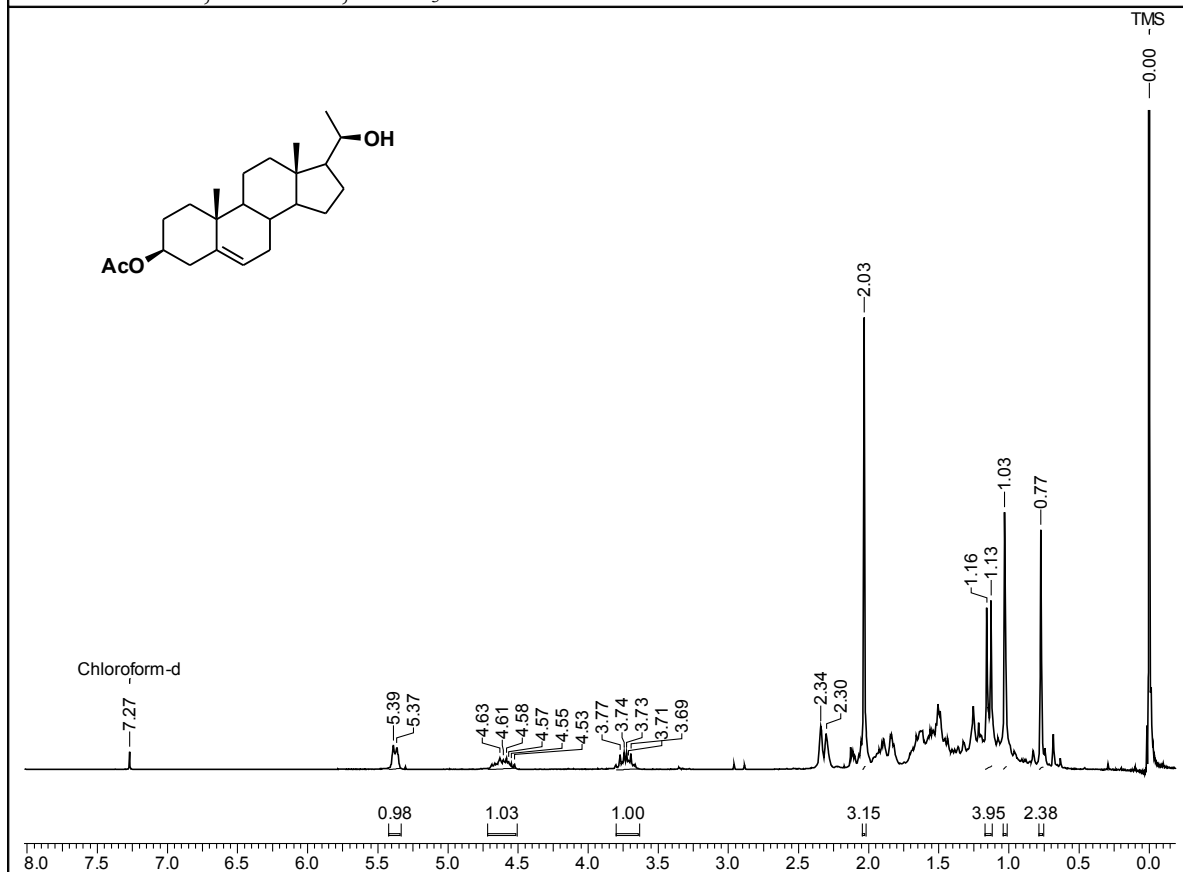
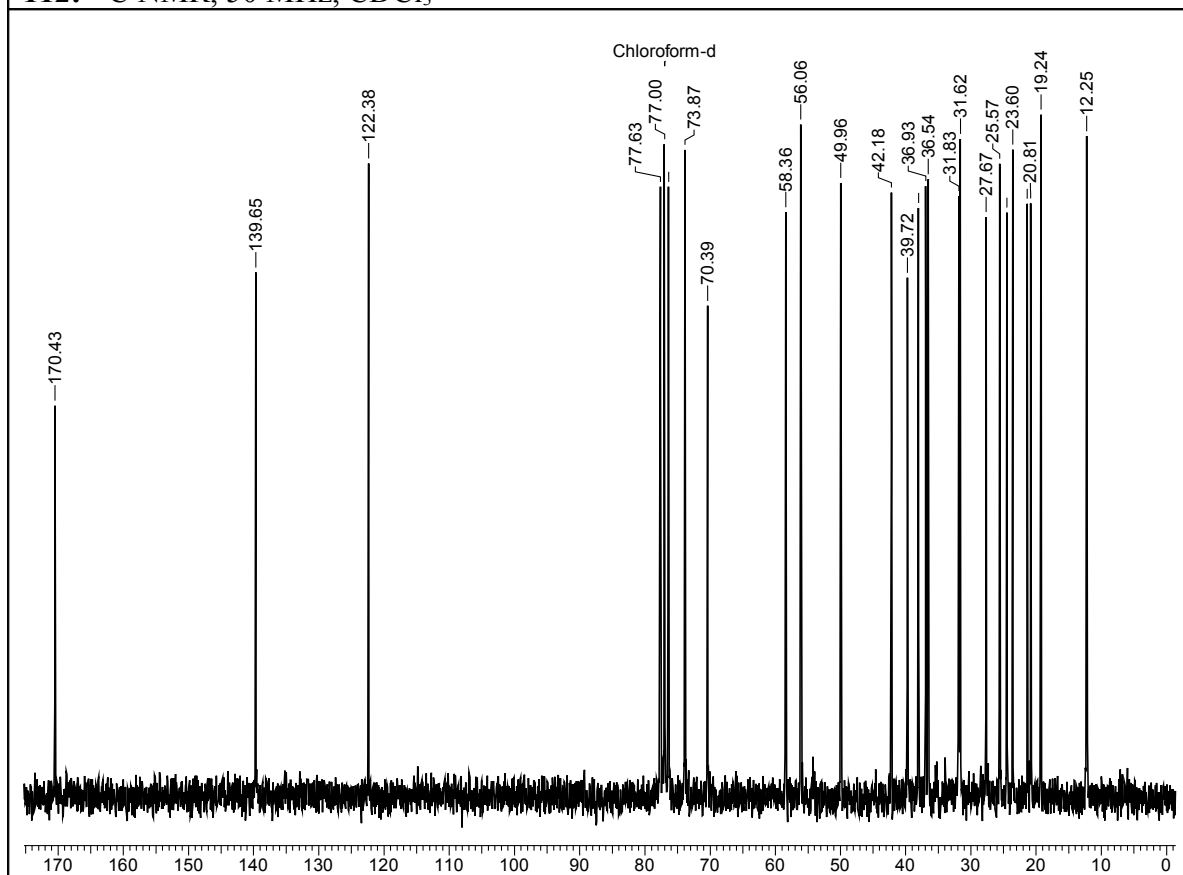
112: ^1H NMR, 200 MHz, CDCl_3 **112:** ^{13}C NMR, 50 MHz, CDCl_3 

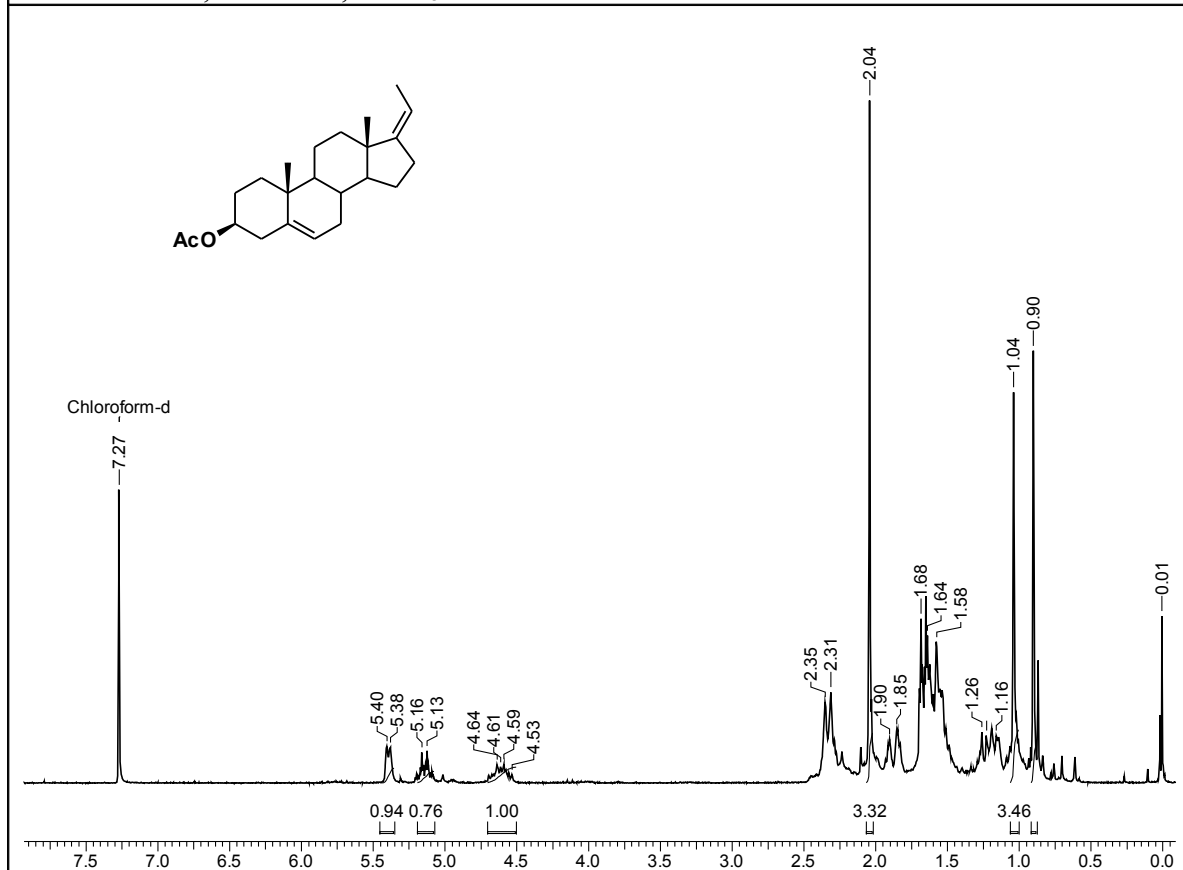
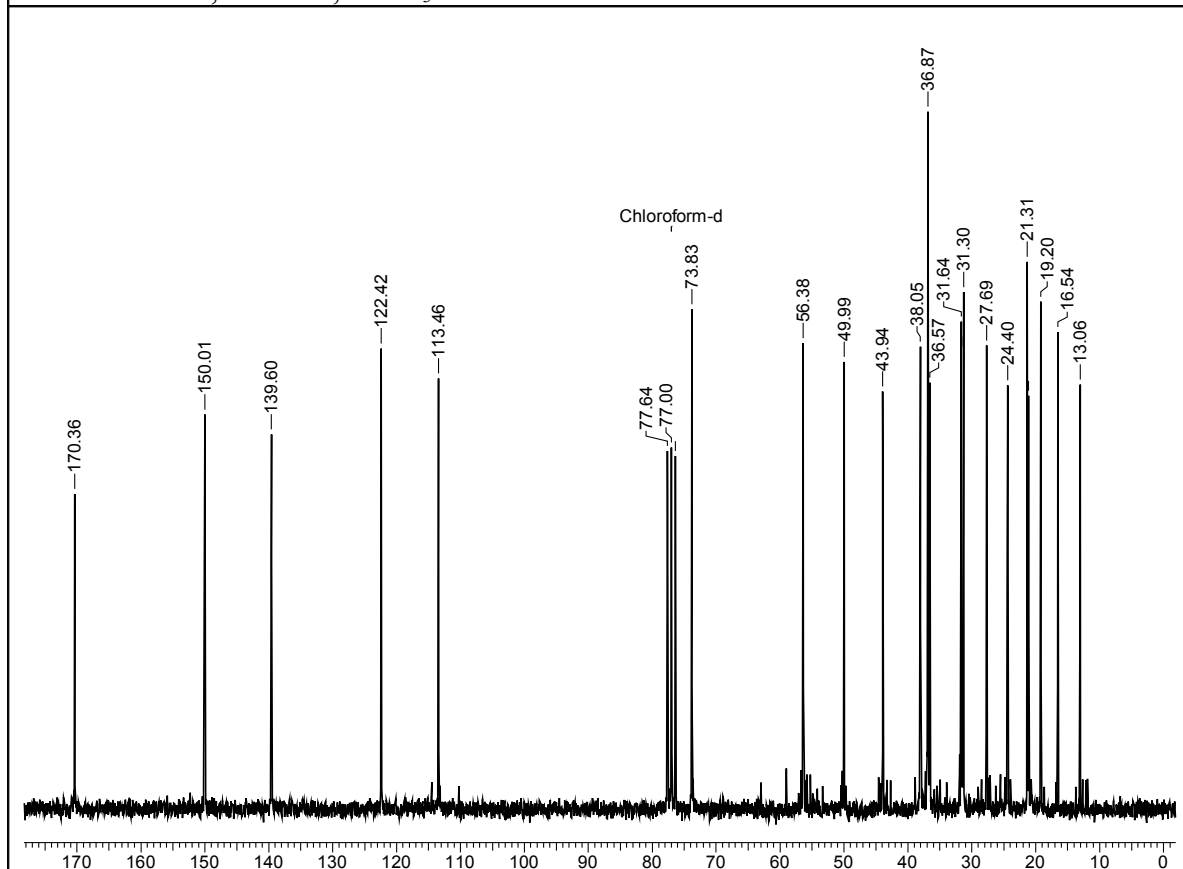
114: ^1H NMR, 200 MHz, CDCl_3 114: ^{13}C NMR, 50 MHz, CDCl_3 

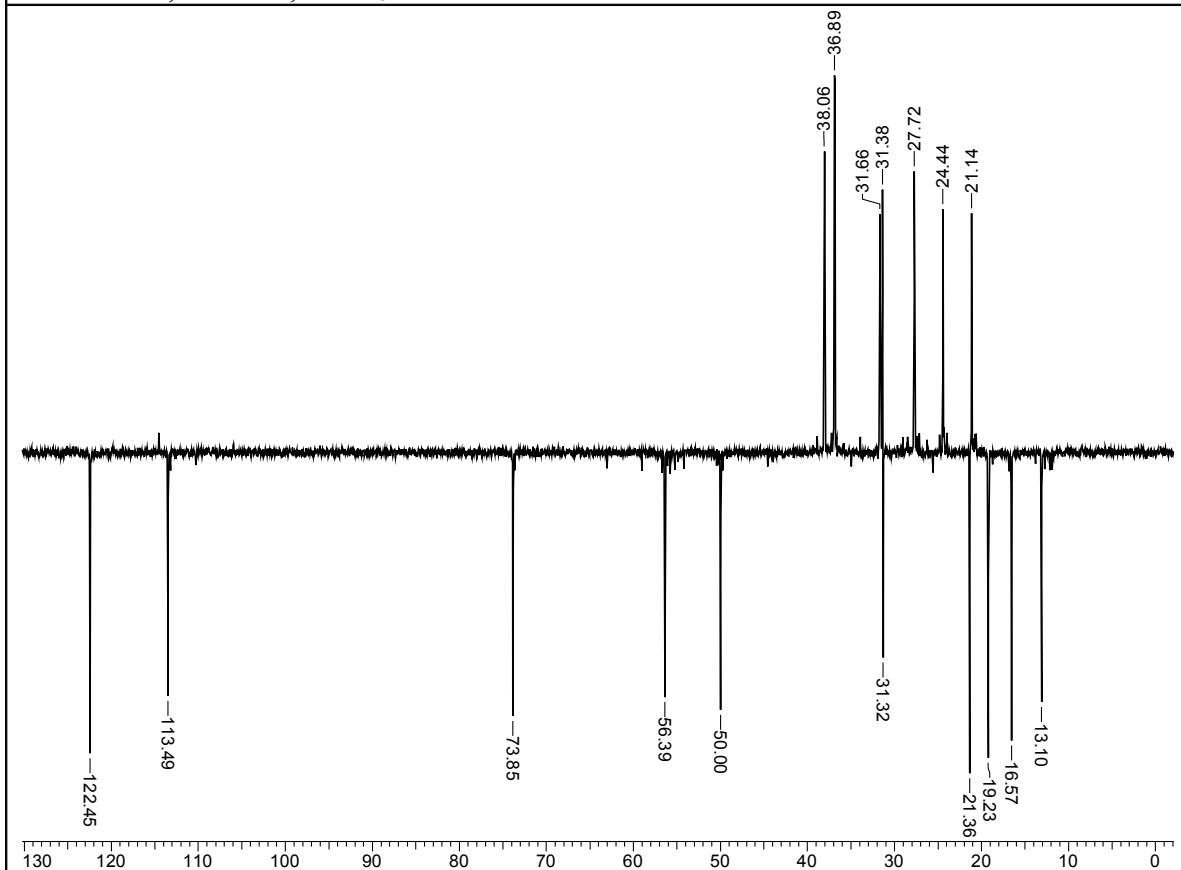
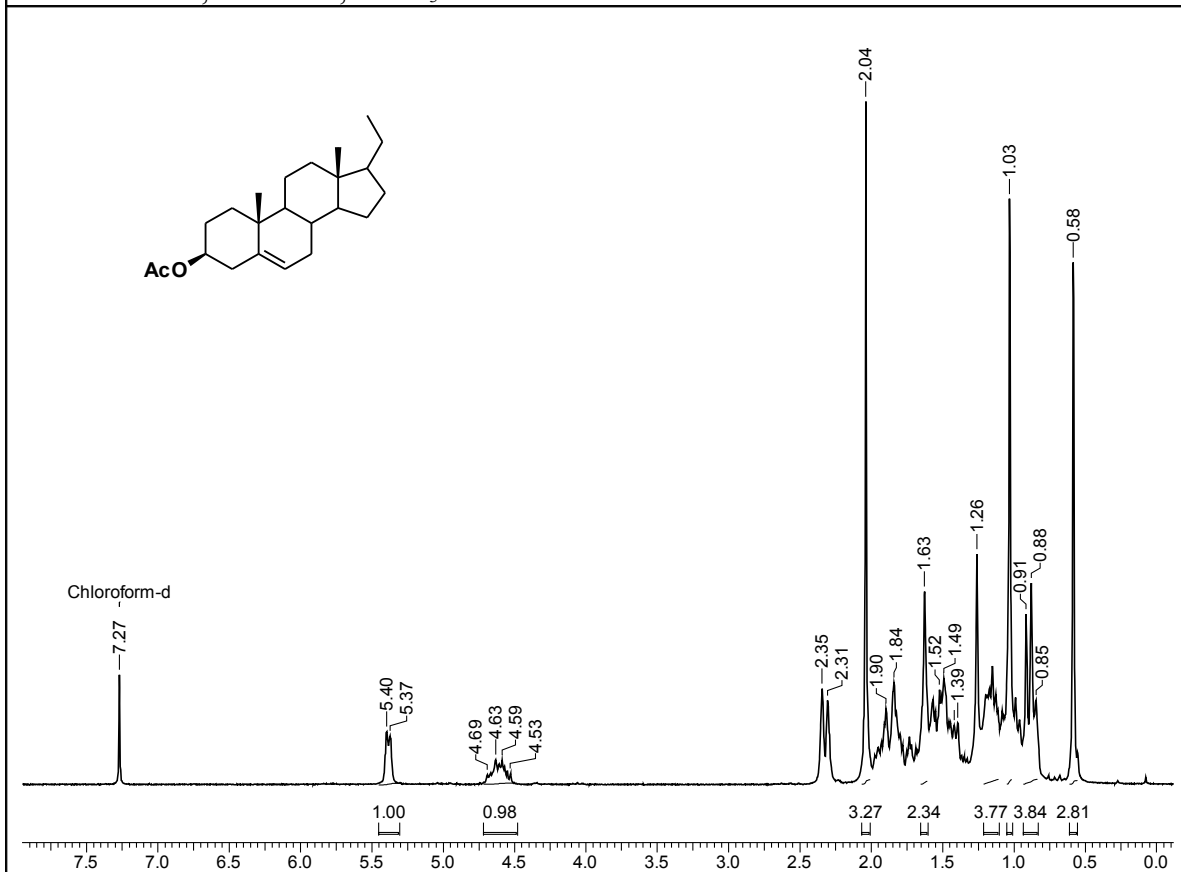
114: DEPT, 50 MHz, CDCl₃115: ¹H NMR, 200 MHz, CDCl₃

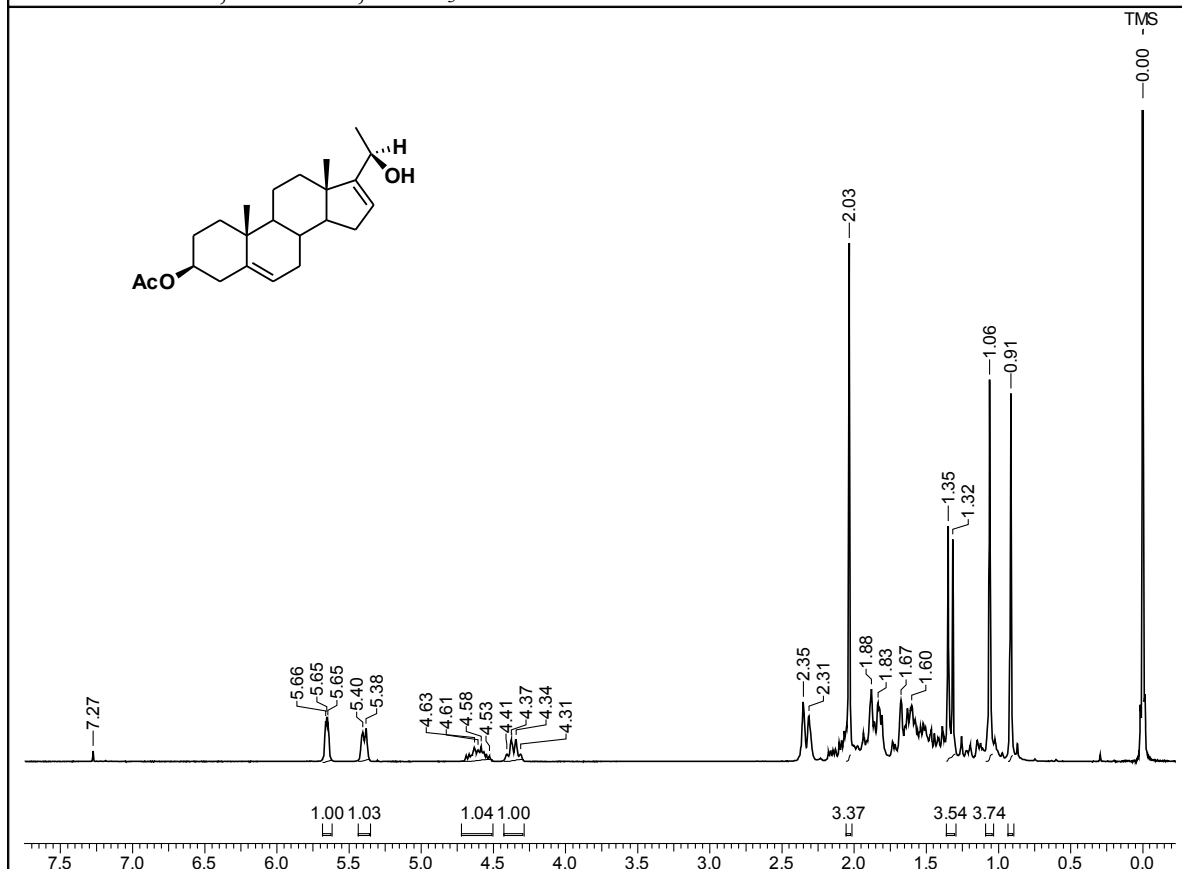
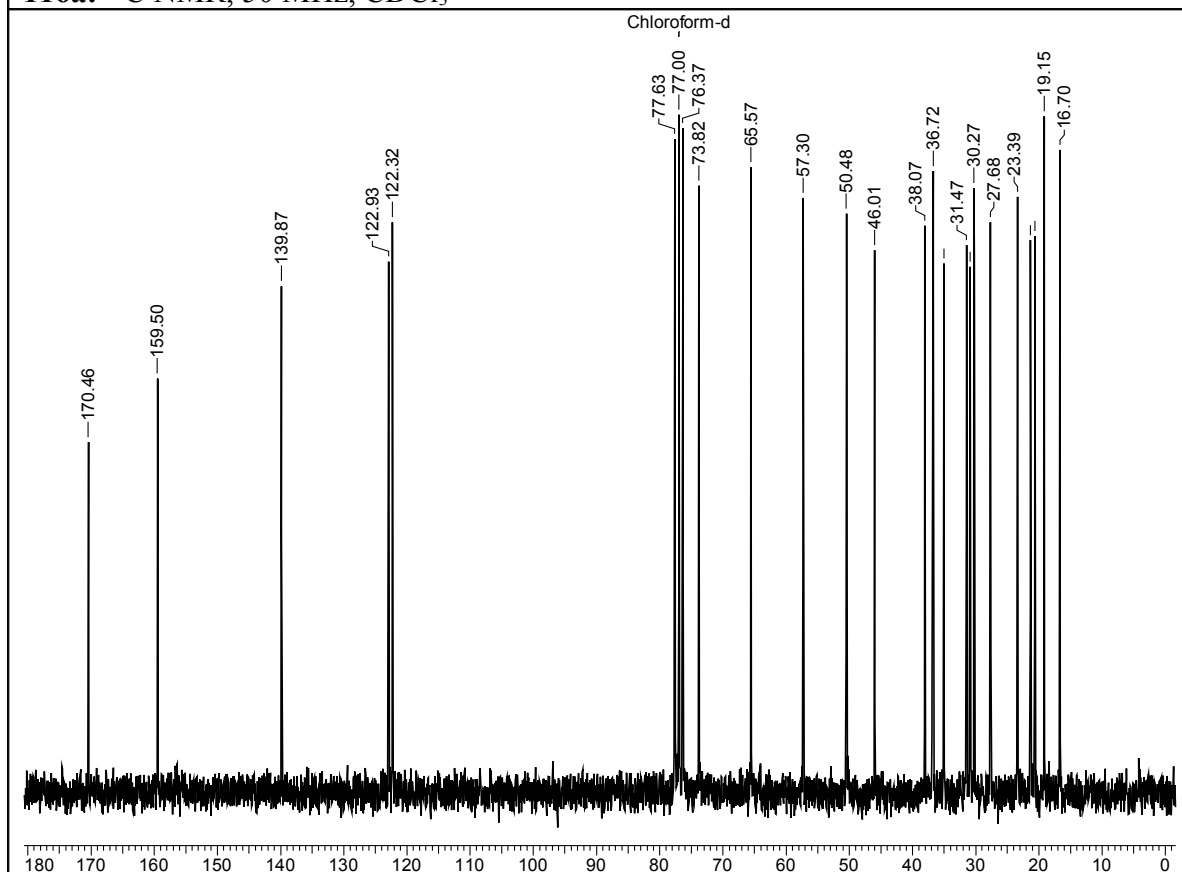
116a: ^1H NMR, 200 MHz, CDCl_3 **116a:** ^{13}C NMR, 50 MHz, CDCl_3 

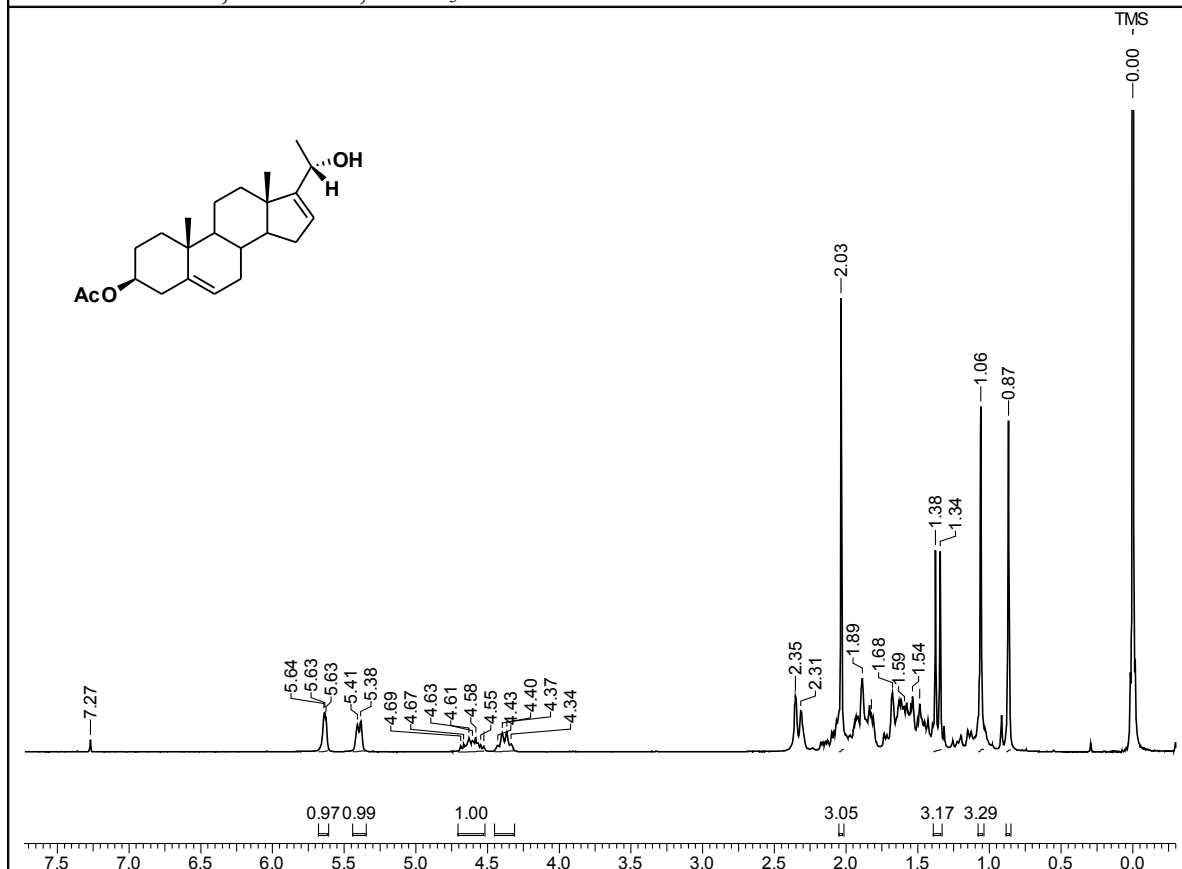
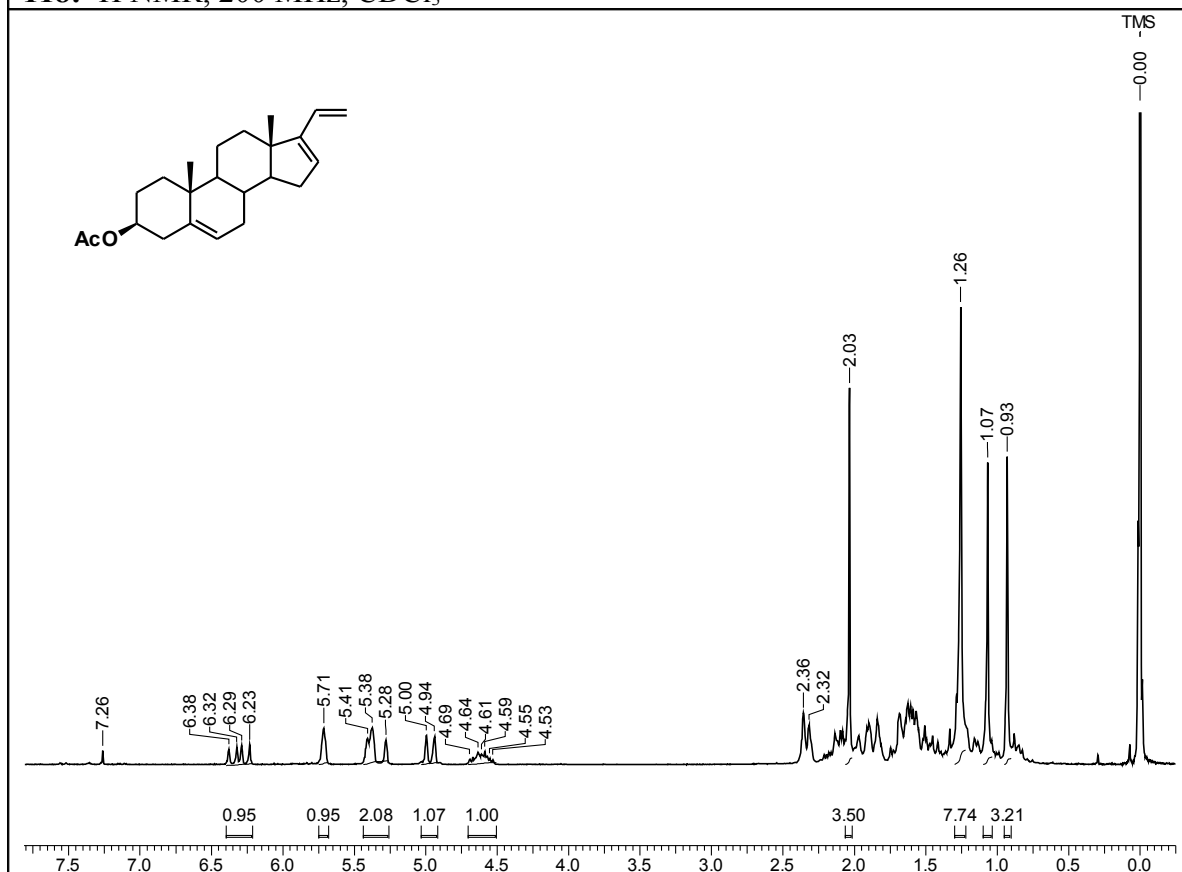
116b: ^1H NMR, 200 MHz, CDCl_3 **118:** ^1H NMR, 200 MHz, CDCl_3 

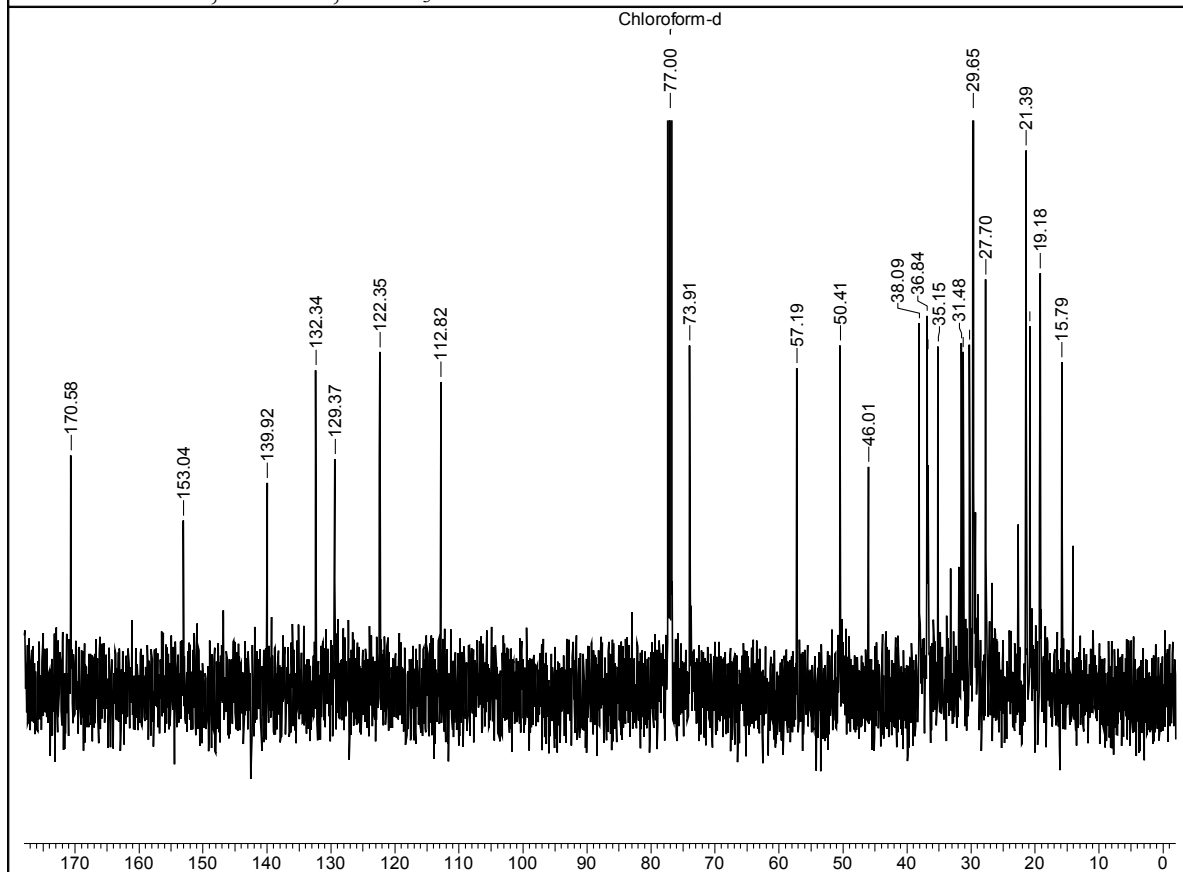
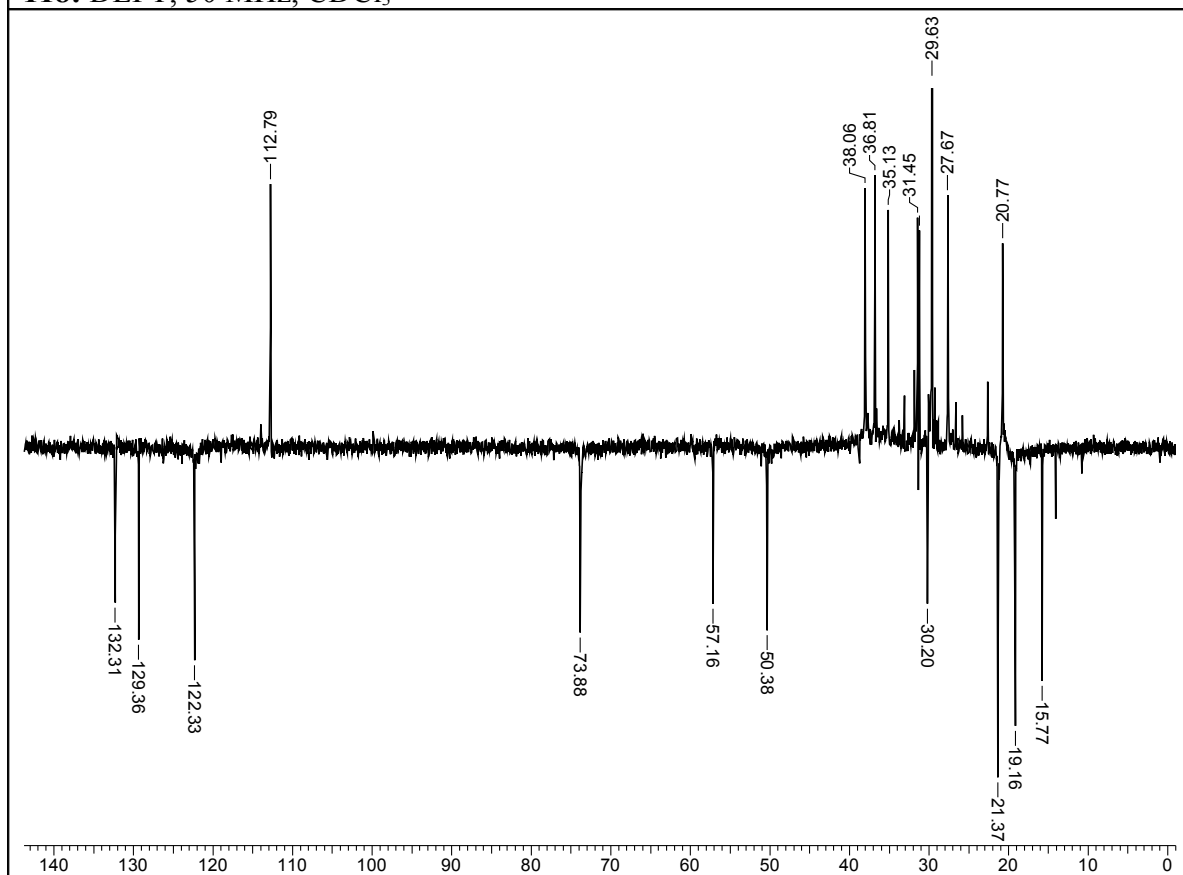
118: ^{13}C NMR, 50 MHz, CDCl_3 **118:** DEPT, 50 MHz, CDCl_3 

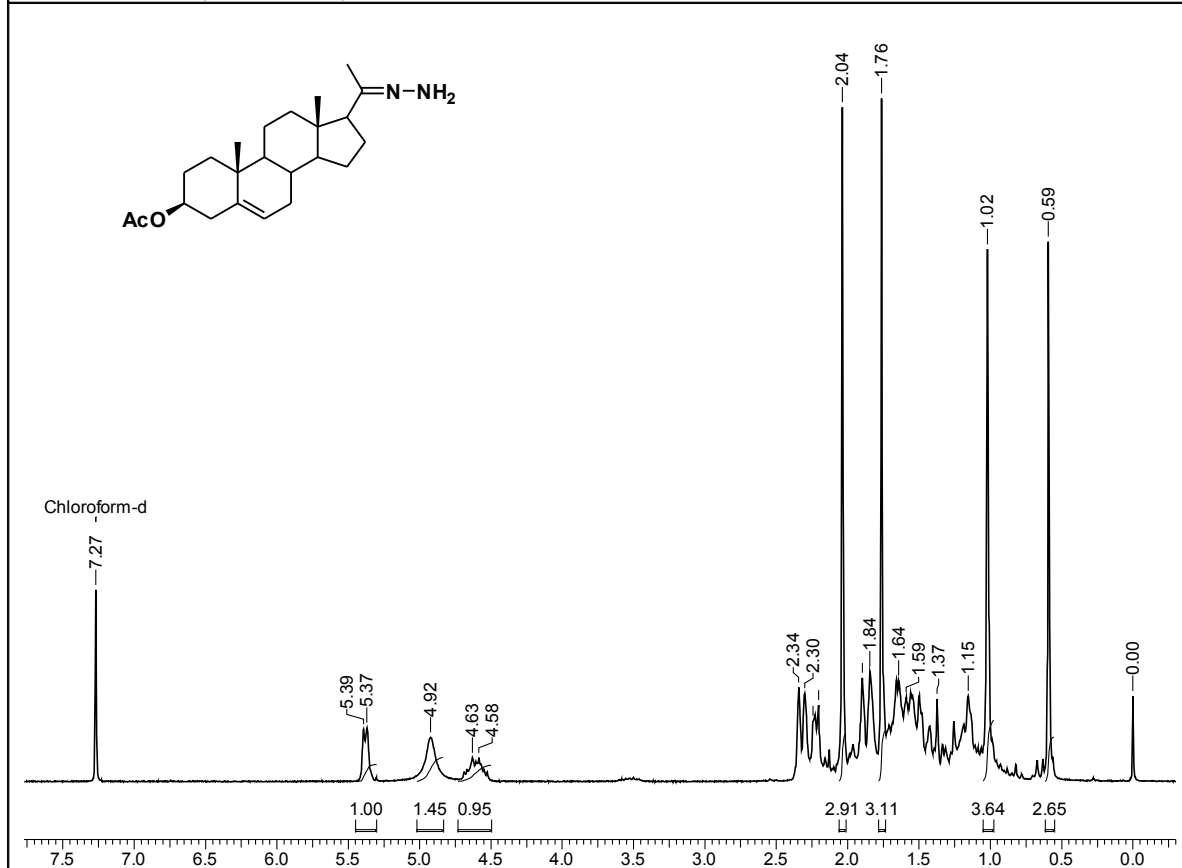
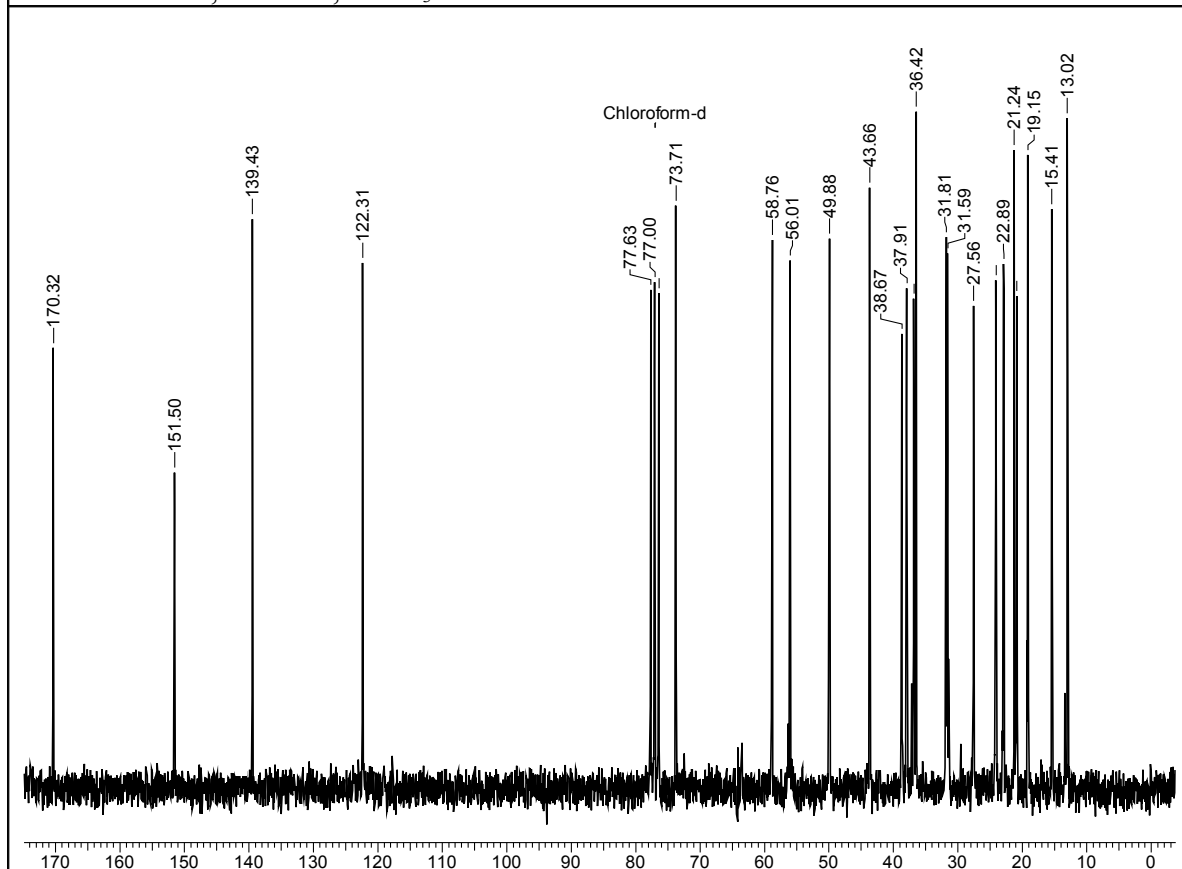
119: ^1H NMR, 200 MHz, CDCl_3 **119:** ^{13}C NMR, 50 MHz, CDCl_3 

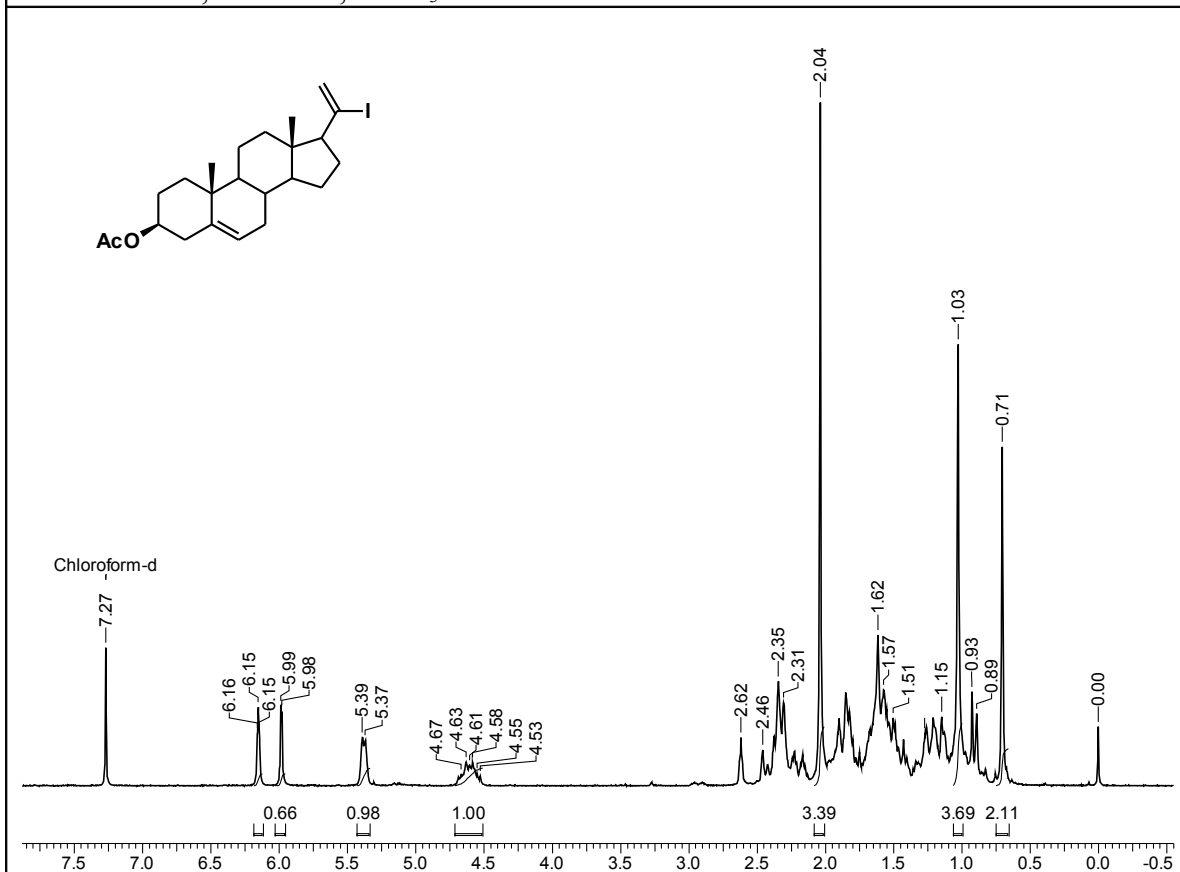
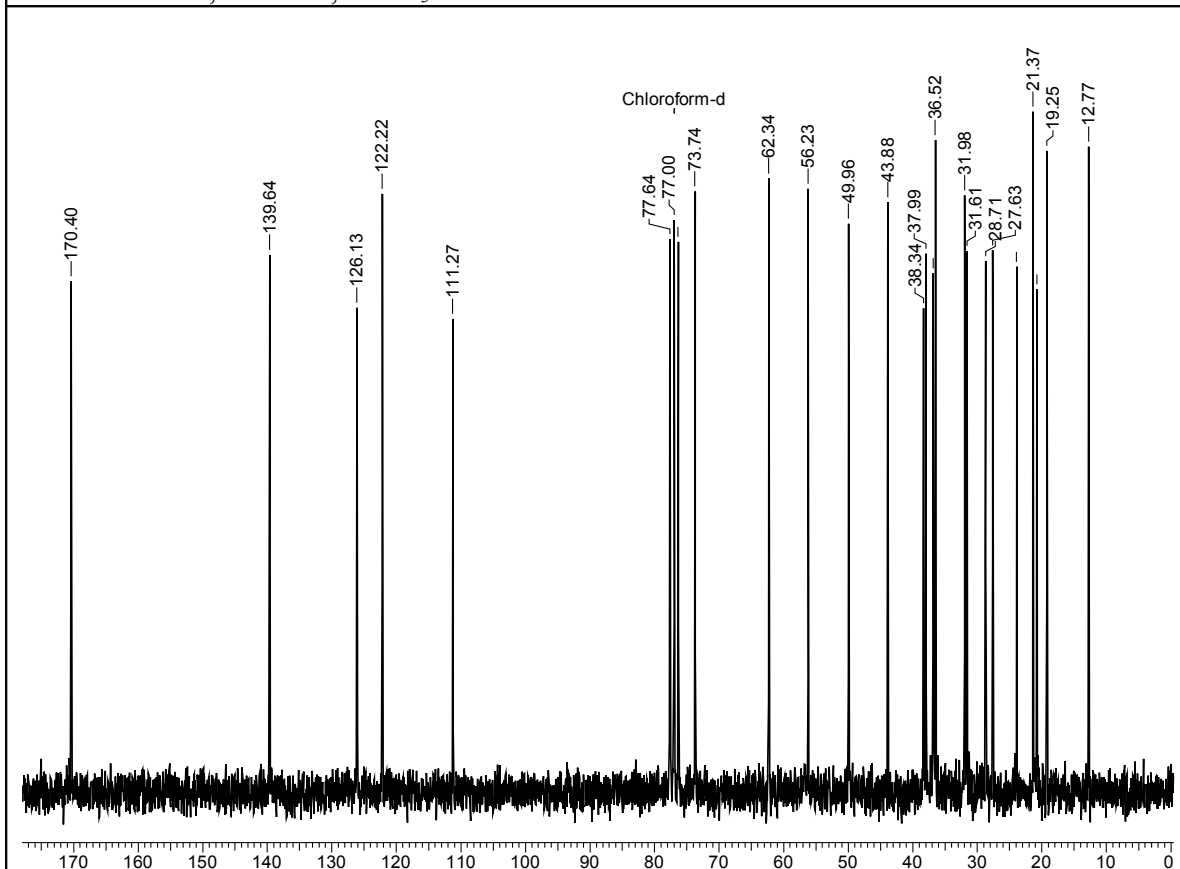
120: ^1H NMR, 200 MHz, CDCl_3 **120:** ^{13}C NMR, 50 MHz, CDCl_3 

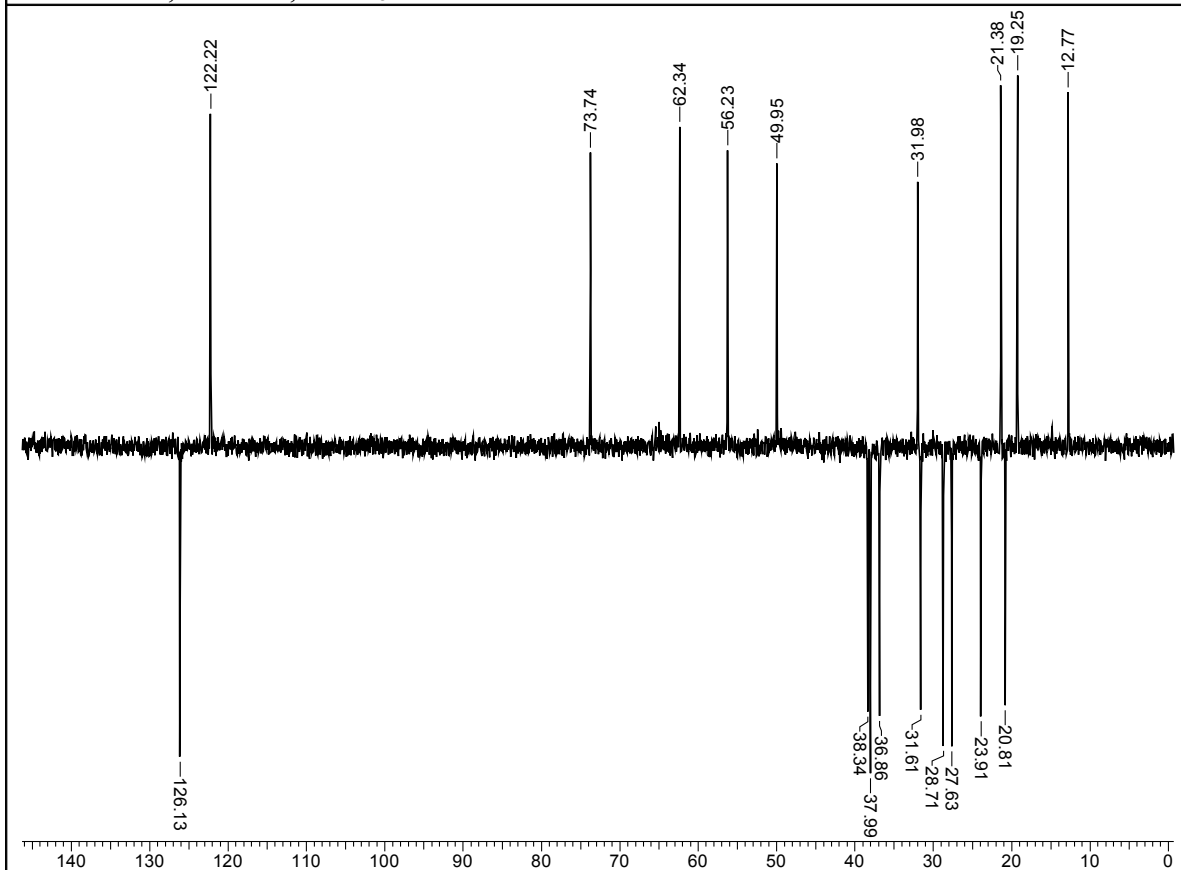
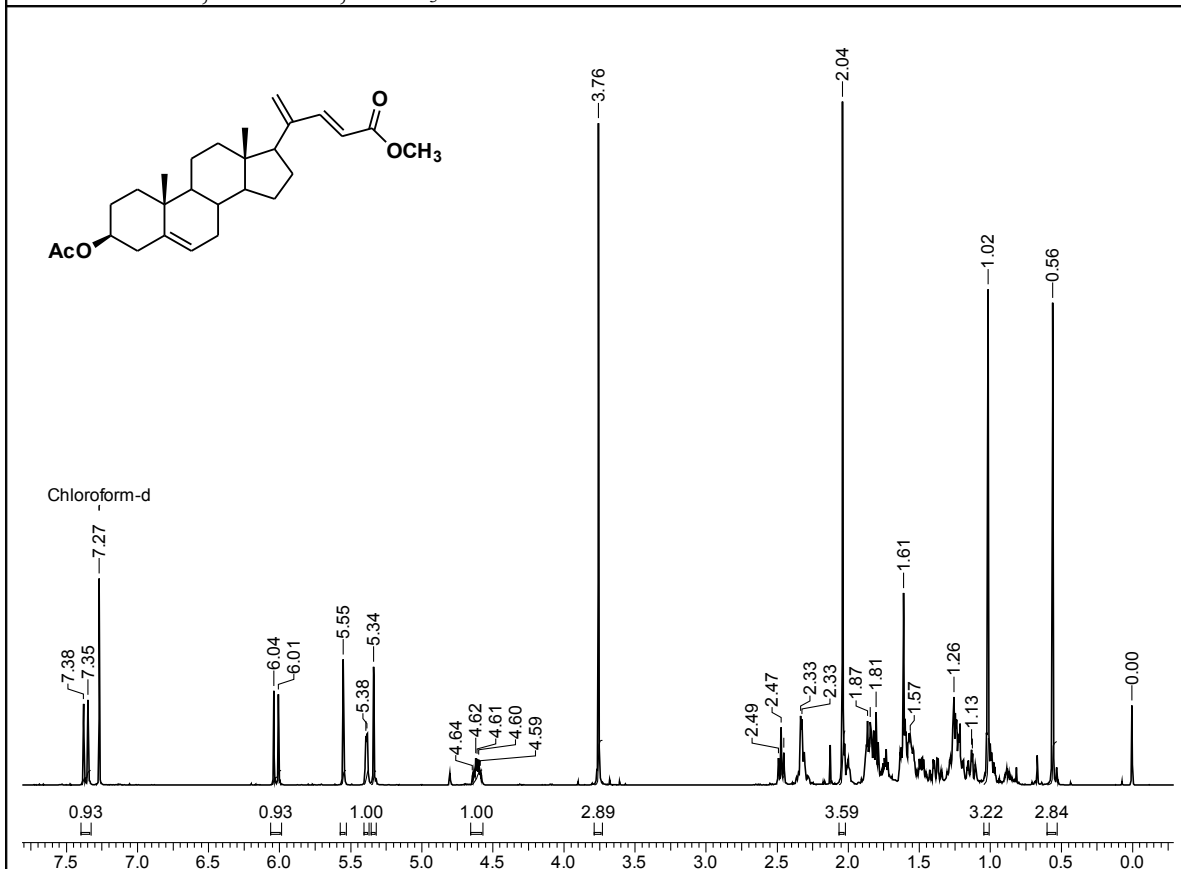
120: DEPT, 50 MHz, CDCl₃**121:** ¹H NMR, 200 MHz, CDCl₃

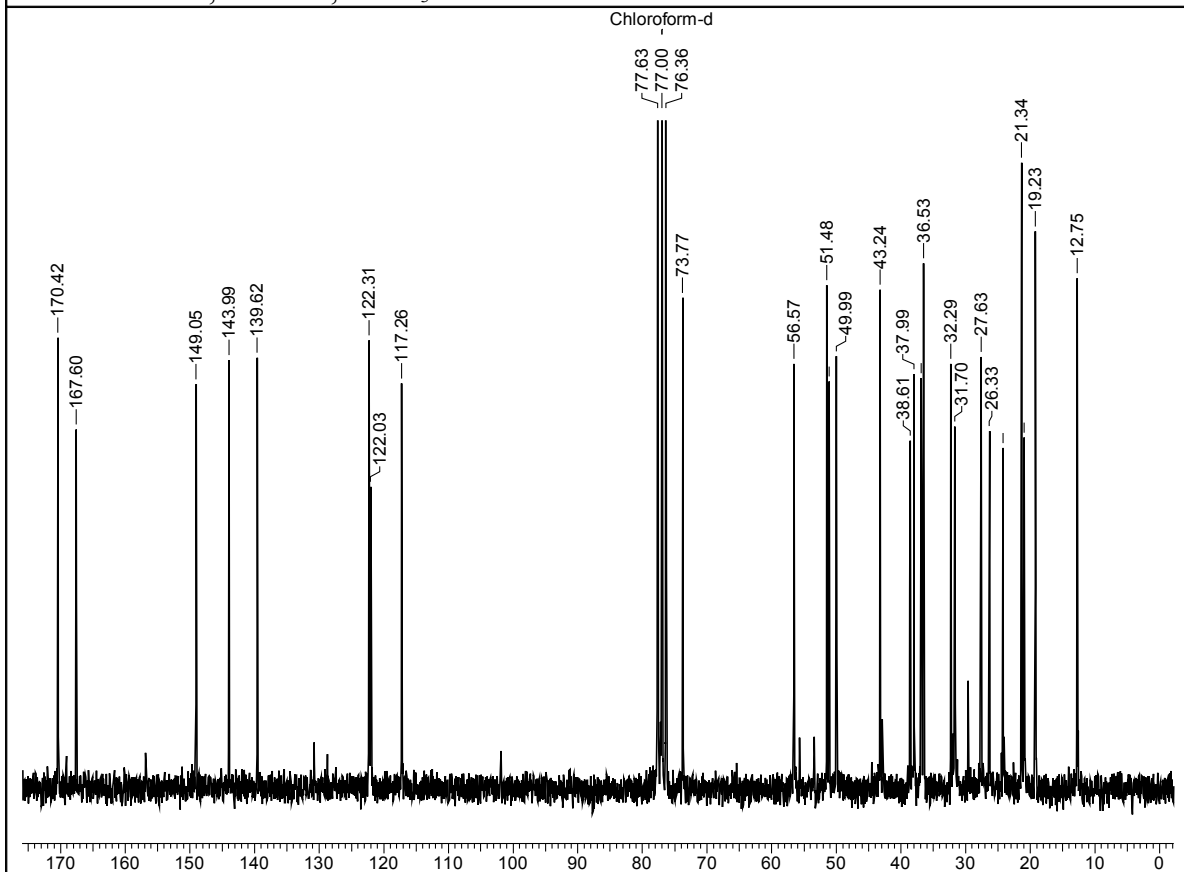
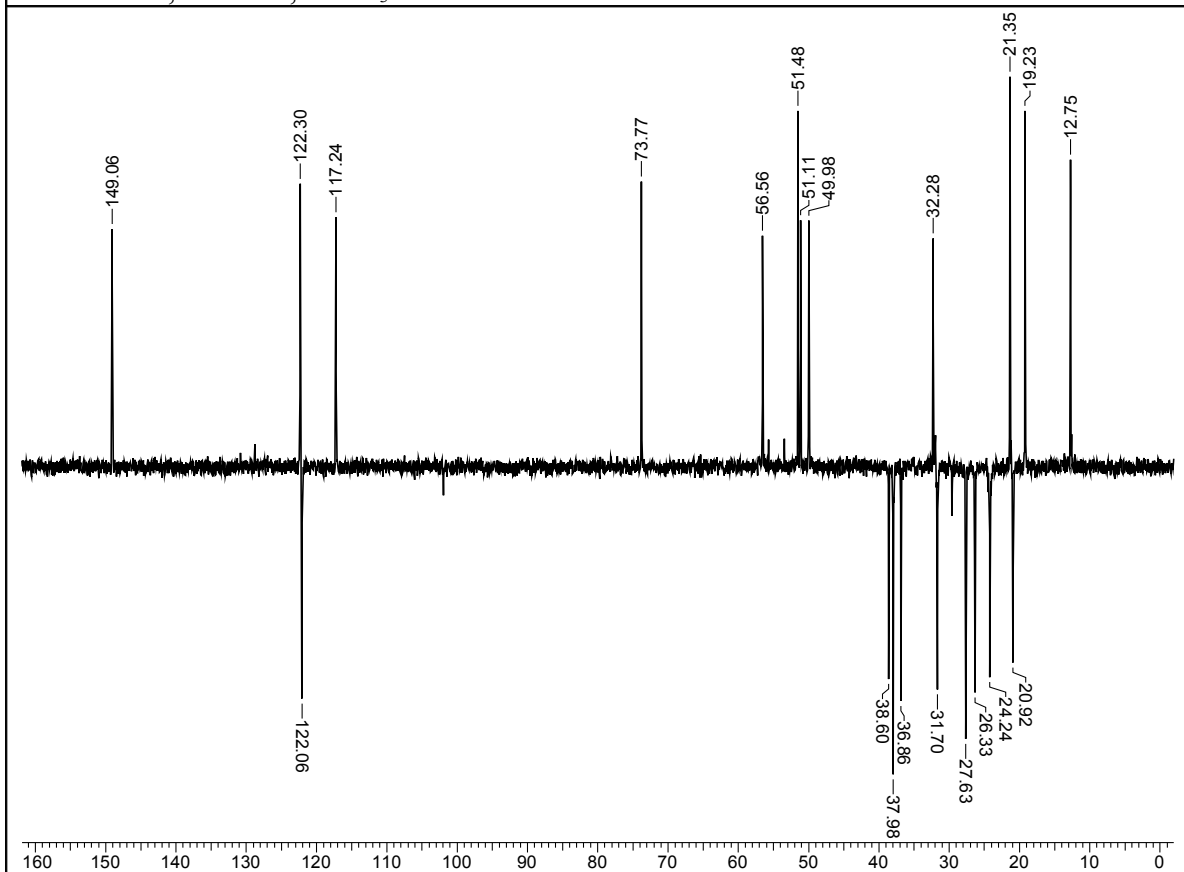
121: ^{13}C NMR, 50 MHz, CDCl_3 **121:** DEPT, 50 MHz, CDCl_3 

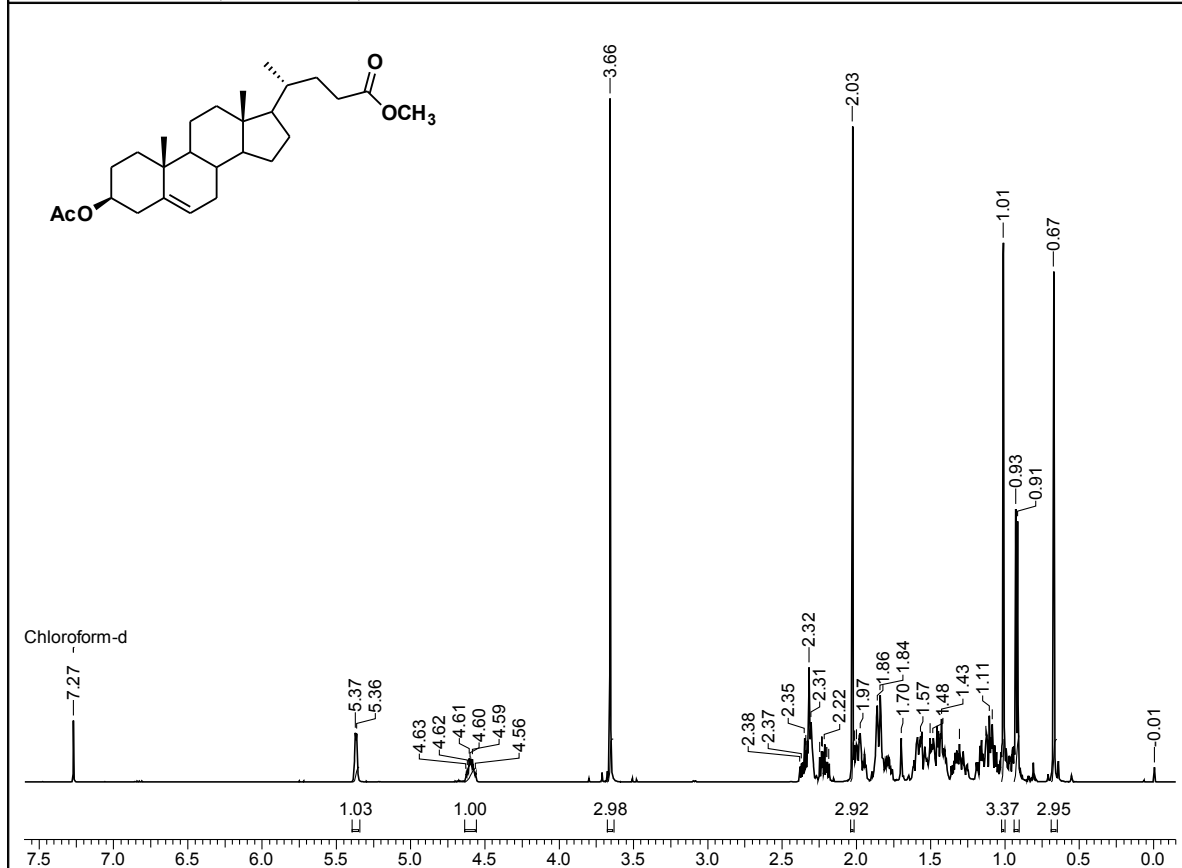
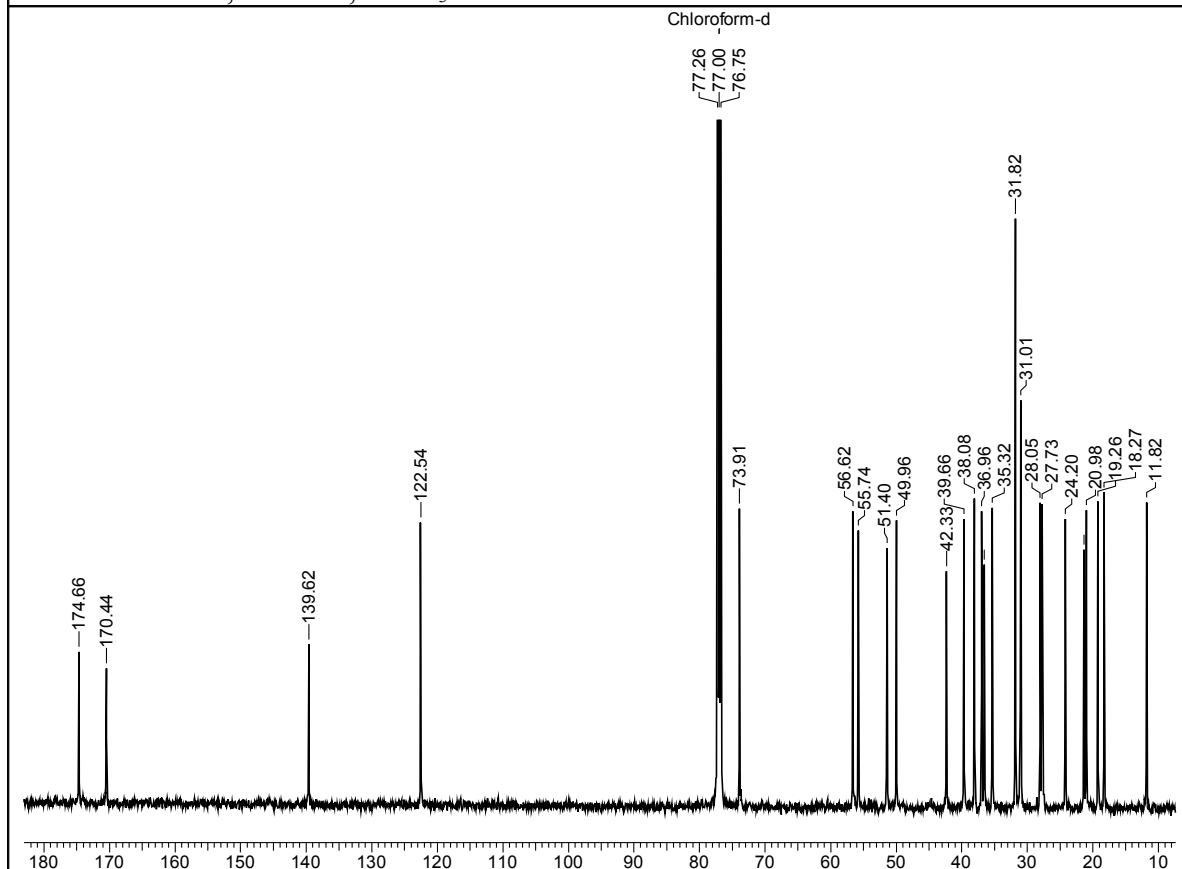
123a: ^1H NMR, 200 MHz, CDCl_3 **123a:** ^{13}C NMR, 50 MHz, CDCl_3 

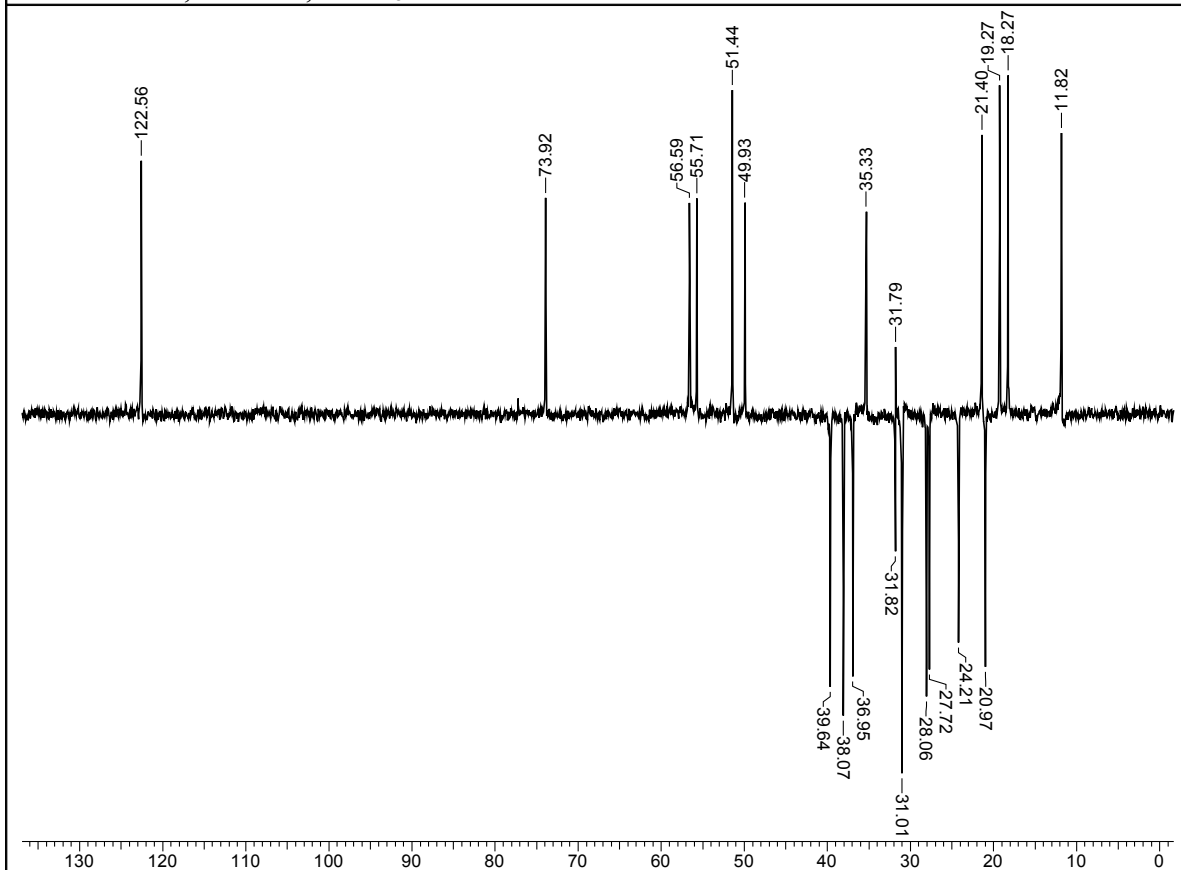
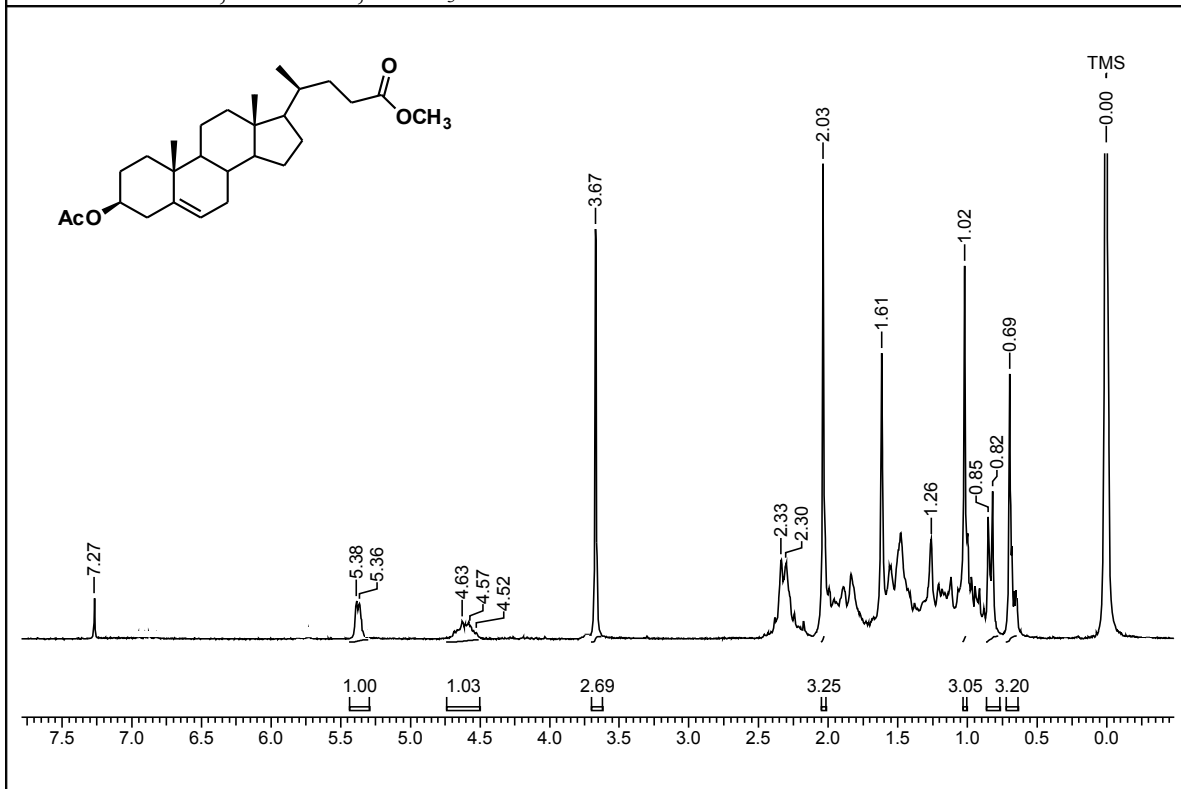
123a: DEPT, 50 MHz, CDCl₃**123b:** ¹H NMR, 200 MHz, CDCl₃

3.8 References

1. Piatak, D. M.; Wicha, J. *Chem. Rev.*, **1978**, *78*, 199-241; b) Redpath, J.; Zeelan, F. *Chem. Soc. Rev.* **1983**, *12*, 75-98.
2. a) Adam, G.; Marquardt, V. *Phytochemistry* **1986**, *25*, 1787-1799; b) Massey, A. P.; Pore V. S.; Hazra, B. G. *Synthesis* **2003**, 426-430;
3. a) Brunel, J. M.; Letourneux, Y. *Eur. J. Org. Chem.* **2003**, 3897-3907, and references cited therein. b) Zhang, D.-H.; Cai, F.; Zhou, X.-D.; Zhou, W.-S. *Org. Lett.* **2003**, *5*, 3257-3259.
4. a) Georghiou, P. E. *Chem. Soc. Rev.* **1977**, *6*, 83-107; b) Zhu, G.-D.; Okamura, W. H. *Chem. Rev.* **1995**, *95*, 1877-1952.; c) Taber, D. F.; Jiang, Q.; Chen, B.; Zhang, W.; Campbell, C. L. *J. Org. Chem.* **2002**, *67*, 4821-4827.; d) Gorobets, E.; Stepanenko, V.; Wicha, J. *Eur. J. Org. Chem.* **2004**, 783-799.
5. Morzycki, J. W.; Wojtkielewicz, A. *Phytochemistry reviews* **2005**, *4*, 259-277, and references cited therein.
6. Koreeda, M.; Koizumi, N. *Tetrahedron Lett.* **1978**, *19*, 1641-1644.
7. Idler, D. R.; Khalil, M. W.; Gilbert, J. D.; Brooks, C. J. W. *Steroids* **1976**, *27*, 155-166.
8. a) Vanderah, D. J.; Djerassi, C. *Tetrahedron Lett.* **1977**, *18*, 683-686.; b) Vanderah, D. J.; Djerassi, C. *J. Org. Chem.* **1978**, *43*, 1442-1448.
9. a) de los Angeles Rey, M.; Martinez-Perez, J. A.; Fernandez-Gacio, A.; Halkes, K.; Fall, Y.; Granja, J.; Mourino, A. *J. Org. Chem.* **1999**, *64*, 3196-3206.; b) Fujishima, T.; Konno, K.; Nakagawa, K.; Kurobe, M.; Okano, T.; Takayama, H. *Bioorg. Med. Chem.* **2000**, *8*, 123-134.; c) Sicinski, R. R.; Rotkiewicz, P.; Kolinski, A.; Sicinska, W.; Prahl, J. M.; Smith, C. M.; DeLuca, H. F. *J. Med. Chem.* **2002**, *45*, 3366-3380.; d) Blahr, L. K. A.; Bjorkling, F.; Calverley, M. J.; Binderup, E.; Begtrup, M. *J. Org. Chem.* **2003**, *68*, 1367-1375.
10. a) Posner, G. H.; Kahraman, M. *Eur. J. Org. Chem.* **2003**, 3889-3895.; b) Begue, J. – P.; Bonnet-Delpon, D. *J. Fluor. Chem.* **2006**, *127*, 992-1021.
11. a) Kessar, S. V.; Gupta, Y. P.; Rampal, A. L. *Tetrahedron Lett.* **1966**, *7*, 4319-4323. b) Kessar, S. V.; Rampal, A. L. *Tetrahedron*, **1968**, *24*, 887-892.; c) Kessar, S. V.; Gupta, V. P.; Mahajan, R. K.; Rampal, A. L. *Tetrahedron* **1968**, *24*, 893-898.; d) Kessar, S. V.; Gupta, V. P.; Mahajan, R. K.; Joshi, G. S.; A. L. Rampal *Tetrahedron*,

- 1968 24, 899-904. e) Kessar, S. V.; Rampal, A. L.; Gupta, V. P. *Tetrahedron*, **1968**, 24, 905-907.
12. a) Beard, C.; Wilson, J. M.; Budzikiewicz, H.; Djerassi, C. *J. Am. Chem. Soc.* **1964**, 86, 269-284. b) Wyllie, S. G.; Djerassi, C. *J. Org. Chem.* **1968**, 33, 305-313.
13. Schmuff, N. R.; Trost, B. M. *J. Org. Chem.* **1983**, 48, 1404-1412.
14. Marino, J. P.; Abe, H. *J. Am. Chem. Soc.* **1981**, 103, 2907-2909.
15. a) Yu, W.; Jin, Z. *J. Am. Chem. Soc.* **2001**, 123, 3369-3370.; b) Yu, W.; Jin, Z. *J. Am. Chem. Soc.* **2002**, 124, 6576-6583.
16. a) Trost, B. M.; Verhoeven, T. R. *J. Am. Chem. Soc.* **1976**, 98, 630-632.; b) Trost, B. M.; Matsumura, Y. *J. Org. Chem.* **1977**, 42, 2036-2038.; c) Trost, B. M.; Verhoeven, T. R. *J. Am. Chem. Soc.* **1978**, 100, 3435-3443.
17. a) Takahashi, T.; Ootake, A.; Tsuji, J. *Tetrahedron Lett.* **1984**, 25, 1921-1924.; b) Takahashi, T.; Ootake, A.; Tsuji, J.; Tachibana, K. *Tetrahedron* **1985**, 41, 5747-5751.
18. a) Mandai, T.; Matsumoto, T.; Kawada, M.; Tsuji, J. *J. Org. Chem.* **1992**, 57, 6090-6092.; b) Mandai, T.; Matsumoto, T.; Kawada, M.; Tsuji, J. *Tetrahedron* **1999**, 50, 475-486.
19. Wicha, J.; Bal, K. *J. Chem. Soc., Perkin Trans. 1*, **1978**, 1282-1288.
20. a) Ibuka, T.; Taga, T.; Nishii, S.; Yamamoto, Y. *J. Chem. Soc., Chem. Commun.*, **1998**, 342-344.; b) Ibuka, T.; Taga, T.; Shingu, T.; Saito, M.; Nishii, S.; Yamamoto, Y. *J. Org. Chem.* **1988**, 53, 3947-3952.
21. a) Kurek-Tyrlik, A.; Michalak, K.; Urbanczyk-Lipkowska, Z.; Wicha, J. *Tetrahedron Lett.* **2004**, 45, 7479-7482.; b) Kurek-Tyrlik, A.; Michalak, K.; Wicha, J. *J. Org. Chem.* **2005**, 70, 8513-8521.
22. Tanabe, M.; Hayashi, K. *J. Am. Chem. Soc.* **1980**, 102, 862-863.
23. Mikami, K.; Kawamoto, K.; Nakai, T. *Tetrahedron Lett.* **1986**, 27, 4899-4902.
24. Batcho, A. D.; Berger, D. E.; Uskokovic, M. R.; Snider, B. B. *J. Am. Chem. Soc.* **1981**, 103, 1293-1295.
25. Dauben, W. G.; Brookhart, T. *J. Org. Chem.* **1982**, 47, 3921-3923.
26. a) Hazra, B. G.; Joshi, P. L.; Pore, V. S. *Tetrahedron Lett.* **1990**, 31, 6227-6230.; b) Hazra, B. G.; Pore, V. S.; Joshi, P. L. *J. Chem. Soc. Perkin Trans. 1*, **1993**, 1819-1822.
27. Hazra, B. G.; Joshi, P. L.; Bahule, B. B.; Argade, N. P.; Pore, V. S.; Chordia, M. D. *Tetrahedron* **1994**, 50, 2523-2532.

28. a) Filippo, M. D.; Izzo, I.; Savignano, L.; Tecilla, P.; Francesco De Riccardis, F. D. *Tetrahedron* **2003**, *59*, 1711-1717.; b) Izzo, I.; Avallone, E.; Monica, C. D.; Casapullo, A.; Amigo, M.; Riccardis, F. D. *Tetrahedron* **2004**, *60*, 5587-5593.
29. a) Watanabe, B.; Yamamoto, S.; Sasaki, K.; Nakagawa, Y.; Miyagawa, H. *Tetrahedron Lett.* **2004**, *45*, 2767-2769.; b) Yamamoto, S.; Watanabe, B.; Otsuki, J.; Nakagawa, Y.; Akamatsu, M.; Miyagawa, H. *Bioorg. Med. Chem.* **2006**, *14*, 1761-1770.
30. a) Kumar, A. S.; Covey, D. F. *Tetrahedron Lett.* **1999**, *40*, 823-826.; b) Westover, E. J.; Covey, D. F. *Steroids* **2003**, *68*, 159-166.; c) Katona, B. W.; Rath, N. P.; Anant, S.; Stenson, W. F.; Covey, D. F. *J. Org. Chem.* **2007**, *72*, 9298-9307.; d) Katona, B. W.; Cummins, C. L.; Ferguson, A. D.; Li, T.; Schmidt, D. R.; Mangelsdorf, D. J.; Covey, D. F. *J. Med. Chem.* **2007**, *50*, 6048-6058.
31. Nakai, T.; Mikami, K. *Chem. Rev.* **1986**, *86*, 885-902.
32. Mikami, K.; Kawamoto, K.; Nakai, T. *Tetrahedron Lett.* **1985**, *26*, 2799-2802.
33. Mikami K.; Kawamoto, K.; Nakai, T. *Chem. Lett.* **1985**, 1719-1722.
34. Castedo, L.; Granja, J. R.; Mouriño, A. *Tetrahedron Lett.* **1985**, *26*, 4959-4960.
35. J. Bottin, M. Fetizon, *J. Chem. Soc. Chem. Commun.*, **1971**, 1087-1088.
36. Katoch, R.; Korde, S. S.; Deodhar, K. D.; Trivedi, G. K. *Tetrahedron* **1999**, *55*, 1741-1754.
37. Midland, M. M.; Kwon, Y. C. *J. Org. Chem.* **1981**, *46*, 229-230.
38. Rychnovsky, S. D.; Mickus, D. E. *J. Org. Chem.* **1992**, *57*, 2732-2736.
39. a) Shi, B.; Wu, H.; Yu, B.; Wu, J. *Angew. Chem. Int. Ed.* **2004**, *43*, 4324-4327.; b) Shi, B.; Tang, P.; Hu, X.; Liu, J. O.; Yu, B. *J. Org. Chem.* **2005**, *70*, 10354-10367.
40. a) Temple, J. S.; Schwartz, J. *J. Am. Chem. Soc.* **1980**, *102*, 7381-7382.; b) Temple, J. S.; Riediker, M.; Schwartz, J. *J. Am. Chem. Soc.* **1982**, *104*, 1310-1315.
41. a) Harada, S.; Kiyono, H.; Taguchi, T.; Hanzawa, Y.; Shiro M. *Tetrahedron Lett.* **1995**, *36*, 9489-9492; b) Harada, S.; Kiyono, H.; Nishio, R.; Taguchi, T.; Hanzawa, Y.; Shiro M. *J. Org. Chem.* **1997**, *62*, 3994-4001;
42. He, Z.; Yi, C. S.; Donaldson, W. A. *Org. Lett.* **2003**, *5*, 1567-1569.
43. Chaudhuri, N. K.; Williams, J. G.; Nickolson, R. Gut, M. *J. Org. Chem.*, **1969**, *34*, 3759-3766.
44. Sondheimer, F.; Mechoulam, R. *J. Am. Chem. Soc.*, **1958**, *80*, 3087-3090.
45. Nair G. V.; Mosettig, E. *J. Org. Chem.*, **1962**, *27*, 4659-4660.
46. Schneider, J. J. *Tetrahedron*, **1972**, *28*, 2717-2726.

47. Kametani, T.; Masayoshi, T.; Nemoto, H. *Tetrahedron Lett.* **1981**, *22*, 2373-2374.
48. Narwid, T. A.; Cooney, K. E.; Uskokovic, M. R. *Helv. Chim. Acta.* **1974**, *57*, 771-781.
49. Fukumoto, K.; Suzuki, K.; Nemoto, H.; Kametani, T.; Furuyama, H. *Tetrahedron* **1982**, *38*, 3701-3704.
50. a) Kametani, T.; Suzuki, K.; Nemoto, H. *J. Am. Chem. Soc.* **1981**, *103*, 2890-2891. b) Kametani, T.; Suzuki, K.; Nemoto, H. *J. Org. Chem.* **1982**, *47*, 2331-2342.
51. Kametani, T.; Katoh, T.; Fujio, J.; Nogiwa, I.; Tsubuki, M.; Toshio Honda, T.; *J. Org. Chem.* **1988**, *53*, 1982-1991.
52. Jogireddy, R.; Rullkotter, J.; Christoffers, J. *Synlett* **2007**, 2847-2850.
53. Shingate, B. B.; Hazra, B. G.; Pore, V. S.; Gonnade, R. G.; Bhadbhade, M. M. *Chem. Commun.* **2004**, 2194-2195.
54. Shingate, B. B.; Hazra, B. G.; Pore, V. S.; Gonnade, R. G.; Bhadbhade, M. M. *Tetrahedron Lett.* **2006**, *47*, 9343-9347.
55. Shingate, B. B.; Hazra, B. G.; Pore, V. S.; Gonnade, R. G.; Bhadbhade, M. M. *Tetrahedron* **2007**, *63*, 5622-5635.
56. The plant dioscoria, which is cultivated in many parts of India, is an abundant source of diosgenin. 16-Dehydropregnenolone acetate **12** is prepared commercially from diosgenin following Marker's procedure: Marker, R. E.; Wagner, R. B.; Ulshafer, P. R.; Wittbecker, E. L.; Goldsmith, D. P. J.; Rouf, C. H. *J. Am. Chem. Soc.* **1947**, *69*, 2167-2230.
57. (a) Burke, S. D.; Fobare, W. F.; Armistead, D. M. *J. Org. Chem.* **1982**, *47*, 3348-3350. (b) Giese, B.; Dupuis, J. *Angew. Chem. Int. Ed. Engl.* **1983**, *22*, 622-623. (c) Adlington, R. M.; Baldwin, J. E.; Basak, A.; Kozyrod, R. P. *J. Chem. Soc. Chem. Commun.* **1983**, 944-945. (d) Giese, B.; Gonzalez-Gomes, J. A.; Witzel, T. *Angew. Chem. Int. Ed. Engl.* **1984**, *23*, 69-70.
58. a) Ueno, Y.; Chino, K.; Watanabe, M.; Osamu, M.; Okawara, M. *J. Am. Chem. Soc.* **1982**, *104*, 5564-5566.; (b) Weinshenker, N. M.; Crosby, G. A.; Wong, J. Y. *J. Org. Chem.* **1975**, *40*, 1966-1971.; (c) Schumann, H.; Pachaly, B. *Angew. Chem. Int. Ed. Engl.* **1981**, *20*, 1043-1044.
59. Sim, T. B.; Choi, J.; Yoon, N. M. *Tetrahedron Lett.* **2006**, *37*, 3137-3140.
60. Corey, E. J.; Pyne, S. G.; Su, W. *Tetrahedron* **1993**, *49*, 10405-10412.
61. Manzaneda, E. J. A.; Chahboun, R.; Torres, E. C.; Alvarez, E.; Manzaneda, R. A.; Haidour, A.; Ramos, J. *Tetrahedron Lett.* **2004**, *45*, 4453-4455.

62. Ling, Y. ; Li, J.; Kato, K.; Liu, Y.; Wang, X.; Klus, G. T.; Marat, K.; Nnane, I. P.; Brodie, A. M. H. *Bioorg. Med. Chem.* **1998**, *6*, 1683-1693.
63. (a) Vankar, Y. D.; Trinadha Rao, C. *Tetrahedron Lett.* **1985**, *37*, 2717-2720; (b) Deo, M. D.; Marcantoni, E.; Torregiani, E. *J. Org. Chem.* **2000**, *65*, 2830-2833.
64. (a) Barton, D. H. R.; O'Brien, R. E.; Sternhell, S. *J. Chem. Soc.* **1962**, 470-476.; (b) Barton, D. H. R.; Bashiardes, G.; Fourrey, J. -L. *Tetrahedron Lett.* **1983**, *24*, 1605-1608; (c) Barton, D. H. R.; Bashiardes, G.; Fourrey, J. -L. *Tetrahedron* **1988**, *44*, 147-162.
65. Földes, R. S.; Kollár, L. *Chem. Rev.* **2003**, *103*, 4095-4130.
66. Földes, R. S.; Bodnar, M.; Kollár, L.; Horvath, J.; Tuba, Z. *Steroids* **1998**, *63*, 93-98.
67. Mandal, P. K.; McMurray, J. S. *J. Org. Chem.* **2007**, *72*, 6599-6601.

LIST OF RESEARCH PUBLICATIONS

1. **Aher, N. G.**; Pore, V. S. Synthesis of Bile Acid Dimers Linked with 1,2,3-Triazole Ring at C-3, C-11, and C-24 Positions *Synlett* **2005**, 2155–2158.
2. Pore, V. S.; **Aher, N. G.**; Kumar, M.; Shukla, P. K. Design and Synthesis of Fluconazole-Bile acid Conjugate using Click Reaction *Tetrahedron* **2006**, 62, 11178-11186.
3. **Aher, N. G.**; Pore, V. S.; and Patil, S. P. Design, Synthesis and Micellar Properties of Bile acid Dimers and Oligomers Linked with 1,2,3-Triazole Ring *Tetrahedron* **2007**, 63, 12927-12934.
4. **Aher, N. G.**; Pore, V. S.; Mishra, N. N.; Awanit Kumar; Shukla, P. K.; Sharma, A.; Bhat, M. K. Synthesis and antifungal activity of 1,2,3-triazole containing fluconazole analogues *Bioorg. Med. Chem. Lett.* **Article in press, (2009)** doi:10.1016/j.bmcl.2008.12.026.
5. **Aher, N. G.**; Pore, V. S.; Gonnade, R. G. Sterioselective synthesis of steroidal side chain from 16-dehydropregalone acetate. *J. Org. Chem.* **2009**, (*Communicated*).
6. **Aher N. G.**; Pore, V. S. Mishra, N. N. Shukla, P. K. Synthesis of bile acid-amino alcohols conjugate as antimicrobial agent. (manuscript under preparation)

PATENT (Indian Patent)

Aher, Nilkanth G.; Pore, Vandana S.; GB Shiva Keshava, Mishra, Nripendra N.; Awanit Kumar; Shukla, Praveen K.; Bhat, Manoj K. Novel fluconazole analogues **Indian Patent** 54NF2008.

SYMPOSIA ATTENDED/POSTER /ORAL PRESENTATIONS

1. Attended Post NOST mini symposium in organic chemistry 2003, National Chemical Laboratory, Pune India, **2003**.
2. **Aher N. G.**; Pore, V. S. Synthesis of bile acid derived new antifungal antibiotics. Poster presented at CRSI's Sixth National Symposium in Chemistry, **2004**, Kanpur, India.
3. **Aher, N. G.**; Salunke, D. B.; Pore, V. S. Design and synthesis of steroid based hybrid antifungal agents. Poster presented at CRSI's Seventh National Symposium in Chemistry, **2005**, Kolkata, India.
4. Oral Presentation on Use of 'Click Chemistry' in Bile Acids: Synthesis of Novel Antifungal Compounds. OCS Day 2005, National Chemical Laboratory, Pune India, **2005**.
5. **Aher, N. G.**; Salunke, D. B.; Hazra, B. G.; Pore, V. S. Design and synthesis of steroid based potential inhibitors of ergosterol biosynthesis as antifungal agents. Poster presented at International Symposium on Advances in Organic Chemistry, INSOC **2006**, Kerala, India.
6. Attended 4th INSA-KOSEF Symposium in Organic Chemistry. Contemporary organic chemistry and its future directions. National Chemical Laboratory, Pune India, **2009**.

ERRATUM
