

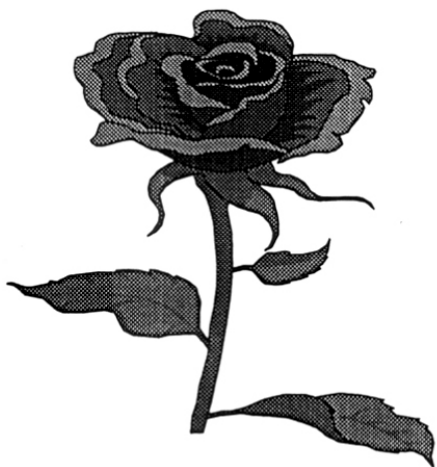

***Synthesis And Characterization Of
Functionalized Polyolefin Surfaces***

**A THESIS
SUBMITTED TO THE
UNIVERSITY OF POONA
FOR THE DEGREE OF
DOCTOR OF PHILOSOPHY
IN CHEMISTRY**

**BY
NABIN SARKAR
DIVISION OF POLYMER CHEMISTRY
NATIONAL CHEMICAL LABORATORY
PUNE 411008**



DEDICATED TO MY
PARENTS

TH-1107

DECLARATION

Certified that the work incorporated in the thesis entitled

**“SYNTHESIS AND CHARACTERIZATION OF FUNCTIONALIZED
POLYOLEFIN SURFACES”**

Submitted by Nabin Sarkar was carried out by the candidate under my supervision. Such material as has been obtained from other sources has been duly acknowledged.

Date: September 23, 1997

National Chemical Laboratory

Pune : 411 008

S. Sivaram

S.Sivaram

Research Guide

ACKNOWLEDGEMENT

It gives me immense pleasure to record deep sense of gratitude to Dr. S.Sivaram, Head, Polymer Chemistry Division, National Chemical Laboratory, Pune, for his valuable and inspiring guidance in abundant measure throughout my pursuance of this work.

I take this opportunity to express my gratitude to Dr. Susmita, Dr. P.P.Wadgaonkar, Dr. P.K.Saxena, Mr. A.S.Patil, Dr. B.D.Sarwade, Dr.(Mrs) B.Garnaik for their valuable advice and suggestions. I also wish to thank my colleagues Biswajit, Sukhendu, Balamurgan, Prodeep for their co-operation and support during these years.

My special thanks to K. Radhakrishnan for his constant help and encouragement.

I thank Dr. Mohandas, Dr. Mahajan, Dr. Vernekar, Dr.(Mrs) Idage, Dr. Khisti, Dr. Singh, Dr. Avadhani for valuable discussions on many occasions. I also thank Sruti, Parag, Vishwa Prasad, Raghunath, Bindu, Snehlata, Neeta, Jinu, Shreelata, Sunita Thombre, Sunita, Anjali, Subarno, Mahua, Ganeshswar and all my senior colleagues Arnob, Binod, Nikhil, Mani, Reddy, Satyanarayan, Shaikh, Iyer, Tusher for their timely help during the course of my stay at N.C.L. My thanks are due to spectroscopy, analytical, glass blowing, library group and all other friends at NCL for their proper assistance.

I wish to express my gratitude to few of my earlier teachers in chemistry, Dr. T.P.Pal, Mr. U.K.Pal, Dr.B.M.Mandal, Dr. S.P. Maulik who sowed the seeds of chemistry in me at an impressive stage of my life and influenced me to take up a career in chemistry. I also thank a few of my school friends, Ashish, Sumit and Bhaskar for their advice and encouragement.

I record my special thanks to my wife Anjana for giving encouragement, help and valuable advice in both my personal and research life. I also wish to express my gratitude to my in-laws for giving moral support.

I am indebted to my father Shri Dhirendra Nath Sarkar, mother Late Shrimati Bela Rani Sarkar, brother, sisters and other relatives for the timely advice, support and freedom given to me.

Finally, my thanks are due to the University Grant Commission, New Delhi for the award of a research fellowship and the Director,NCL, for permission to submit the work in the form of a thesis.

Nabin Sarkar

Nabin Sarkar

CONTENTS

| | |
|--|-----|
| ABSTRACT | i |
| LIST OF TABLES | iii |
| LIST OF FIGURES | v |
| <u>SYNTHESIS AND CHARACTERIZATION OF FUNCTIONALIZED POLYOLEFIN SURFACES</u> | |
| CHAPTER I | |
| <u>SURFACE MODIFICATION OF POLYMERS</u> | |
| 1.1 INTRODUCTION | 1 |
| 1.1.1 Chemical modification | 1 |
| 1.1.2 Photochemical modification | 2 |
| 1.1.3 Other modification (Plasma, Corona) | 5 |
| 1.2 SURFACE MODIFICATION OF POLY(ETHYLENE) AND POLY(PROPYLENE) | 9 |
| 1.2.1 Chemical methods | 9 |
| 1.2.2 Photochemical methods | 15 |
| 1.2.3 Other methods (Plasma, Corona) | 21 |
| 1.3 SURFACE MODIFICATION OF OTHER POLYMERS | 25 |
| 1.3.1 Poly(dien)s | 25 |
| 1.3.2 Poly(tetrafluoroethylene) | 27 |
| 1.3.3 Poly(styrene) | 29 |
| 1.3.4 Other Polymers | 31 |
| 1.4 SURFACE GRAFTING ON POLYMERS | 36 |
| 1.4.1 Chemical methods | 38 |
| 1.4.2 Photochemical methods | 40 |
| 1.5 METHODS OF CHARACTERISATION OF POLYMER SURFACES | 43 |
| 1.5.1 Attenuated Total Reflection Infrared Spectroscopy (ATR-IR) | 43 |
| 1.5.2 Contact angle measurement | 45 |
| 1.5.3 X-ray photoelectron spectroscopy (XPS) | 47 |
| 1.5.4 Scanning electron microscopy (SEM) | 51 |

| | |
|---|-----------|
| 1.5.5 Secondary ion mass spectroscopy (SIMS) | 52 |
| 1.5.6 Atomic force microscopy(AFM) | 53 |
| 16 SAMPLE PREPARATION, CONDITIONING AND HANDLING | 54 |
| 17 STRUCTURE- PROPERTY RELATIONSHIP IN MODIFIED SURFACES | 56 |
| 18 APPLICATIONS OF MODIFIED POLYMERS SURFACES | 59 |
| 19 REFERENCES | 64 |
| CHAPTER II | |
| <u>SCOPE AND OBJECTIVES OF THE PRESENT STUDY</u> | 71 |
| CHAPTER III | |
| <u>SURFACE SELECTIVE FUNCTIONALIZATION OF POLYETHYLENE WITH SUCCINIC ANHYDRIDE</u> | |
| 3.1 INTRODUCTION | 76 |
| 3.2 EXPERIMENTAL | 76 |
| 3.2.1 Materials | 76 |
| 3.2.2 Methods | 77 |
| 3.2.2.1 Sample preparation and conditioning | 77 |
| 3.2.2.2 Poly(ethulene) surface bearing succinic anhydride group | 77 |
| 3.2.2.3 Poly(ethylene) surface bearing succinic acid group | 78 |
| 3.2.2.4 Reaction of poly(ethylene) surface bearing succinic acid with 4-amino azobenzene | 80 |
| 3.2.2.5 Estimation of surface functional group concentration | 80 |
| 3.2.3 Characterization of surfaces | 80 |
| 3.3 RESULT AND DISCUSSION | 81 |
| 3.3.1 Control experiment | 81 |
| 3.3.2 Proof of surface functionality | 83 |
| 3.3.3 Evidences against photografting | 83 |
| 3.3.4 Concentration of functional groups | 84 |
| 3.3.5 Proof of surface selectivity | 86 |
| 3.3.6 Effect of reaction conditions on the surface reaction | 88 |
| 3.3.6.1 Reaction time | 88 |

| | |
|--|------------|
| 3.3.6.2 Concentration of maleic anhydride and benzophenone | 91 |
| 3.3.6.3 Nature of diluent | 92 |
| 3.3.7 Contact angle hysteresis | 93 |
| 3.3.8 Surface reconstruction of dicarboxylic acid modified polyethylene surfaces | 94 |
| 3.3.8.1 Effect of heating | 94 |
| 3.3.8.2 Effect of time | 95 |
| 3.3.9 Reaction mechanism | 96 |
| 3.4 CONCLUSION | 96 |
| 3.5 REFERENCES | 97 |
| CHAPTER IV | |
| <u>FUNCTIONAL GROUP TRANSFORMATIONS OF SUCCINIC ANHYDRIDE ON</u> | |
| <u>POLYETHYLENE SURFACE</u> | |
| 4.1 INTRODUCTION | 99 |
| 4.2 EXPERIMENTAL | 100 |
| 4.2.1 Materials | 100 |
| 4.2.2 Methods | 100 |
| 4.2.2.1 Sample preparation and conditioning | 100 |
| 4.2.2.2 Polyethylene surface bearing succinic anhydride group | 100 |
| 4.2.2.3 Polyethylene surface bearing succinic acid group | 101 |
| 4.2.2.4 Polyethylene surface bearing amide group derived from different amines | 101 |
| 4.3 RESULT AND DISCUSSION | 104 |
| 4.3.1 Monofunctionalization of the anhydride group | 104 |
| 4.3.2 Difunctionalization of the anhydride group | 104 |
| 4.3.3 Effect of pH on surface ionization of dicarboxylic acid | 106 |
| 4.3.4 Wettability characteristics of functionalized PE surfaces | 107 |
| 4.3.4.1 Nature of chemical functionality | 108 |
| 4.3.4.2 Nature of counter cation. | 109 |
| 4.3.4.3 Effect of heating | 112 |
| 4.4 CONCLUSION | 115 |
| 4.5 REFERENCES | 116 |

CHAPTER V

POLYOLEFIN SURFACES BEARING AZOBENZENE FUNCTIONALITY

| | |
|---|-----|
| 5.1 INTRODUCTION | 118 |
| 5.2 EXPERIMENTAL | 119 |
| 5.2.1 Material | 119 |
| 5.2.2 Methods | 119 |
| 5.2.2.1 Sample preparation and conditioning | 119 |
| 5.2.2.2 Polyolefin surface bearing succinic anhydride group | 119 |
| 5.2.2.3 Polyolefin surface bearing succinic acid group | 120 |
| 5.2.2.4 Polyolefin surface bearing mono azobenzene | 120 |
| 5.2.2.5 Polyolefin surface bearing bis azobenzene | 120 |
| 5.2.2.6 Polyolefin surface bearing mono 4-(4-nitrophenyl azo) aniline | 121 |
| 5.2.2.7 Polyolefin surface bearing bis 4-(4-nitrophenyl azo) aniline | 121 |
| 5.2.2.8 Preparation of amorphous azo polymer | 121 |
| 5.2.2.9 Analysis | 122 |
| 5.3 RESULT AND DISCUSSION | 123 |
| 5.3.1 Proof of functionalization | 123 |
| 5.3.2 Estimation of functional group concentration | 125 |
| 5.3.3 E ↔ Z isomerization of azobenzene on surface | 126 |
| 5.3.3.1 Kinetics of isomerization | 128 |
| 5.3.3.2 Effect of structure of chromophore | 130 |
| 5.3.3.3 Effect of attachment of the chromophore to the polymer backbone | 133 |
| 5.3.3.4 Effect of nature of polymer | 134 |
| 5.4 POTENTIAL APPLICATION OF AZOBENZENE BEARING POLYMER SURFACES | 134 |
| 5.5 CONCLUSION | 136 |
| 5.6 REFERENCES | 137 |
| CHAPTER VI | |
| <u>SURFACE ETCHING OF POLYETHYLENE</u> | |
| 6.1 INTRODUCTION | 139 |
| 6.2 EXPERIMENTAL | 140 |

| | | |
|--|---|-----|
| 6.2.1 | Material | 140 |
| 6.2.2 | Analysis | 140 |
| 6.2.3 | Methods | 140 |
| 6.2.3.1 | Poly(ethylene) film bearing succinic anhydride group | 140 |
| 6.2.3.2 | Poly(ethylene) film bearing mono azo benzene | 140 |
| 6.2.3.3 | Poly(ethylene) film bearing benzamide | 140 |
| 6.2.3.4 | Poly(ethylene) film bearing p-aminobenzamide | 141 |
| 6.2.2.5 | Poly(ethylene) film bearing diazonium salt | 141 |
| 6.2.3.6 | Electron beam irradiation | 141 |
| 6.2.3.7 | Plasma exposure | 141 |
| 6.2.3.8 | Thermal treatment | 141 |
| 6.3 | RESULT AND DISCUSSION | 141 |
| 6.3.1 | Proof of functionality | 141 |
| 6.3.2 | Etching of modified poly(ethylene) surface by high energy radiation | 142 |
| 6.3.3 | Thermal etching | 147 |
| 6.4 | CONCLUSION | 150 |
| 6.5 | REFERENCES | 150 |
| CHAPTER VII | | |
| <u>APPLICATION OF SURFACE FUNCTIONALISED POLYETHYLENE</u> | | |
| 7.1 | INTRODUCTION | 152 |
| 7.2 | EXPERIMENTAL | 153 |
| 7.2.1 | Material | 153 |
| 7.2.2 | Methods | 154 |
| 7.2.2.1 | Synthesis of hinderd amine light stabilizers | 154 |
| 7.2.2.2 | Preparation of polyolefin surface bearing succinic anhydride group | 154 |
| 7.2.2.3 | Preparation of polymer bound HALS-1 | 154 |
| 7.2.2.4 | Preparation of polymer bound HALS-2 | 155 |
| 7.2.2.5 | Analysis of surface concentration | 155 |
| 7.3 | RESULT AND DISCUSSION | 156 |
| 7.3.1 | Proof of functionalization | 156 |

| | |
|---|-----|
| 7.3.2 Surface protection of polyolefins against degradation | 157 |
| 7.4 CONCLUSION | 160 |
| 7.5 REFERENCES | 160 |

CHAPTER VIII

| | |
|---|-----|
| <u>SUMMARY AND CONCLUSIONS</u> | 163 |
|---|-----|

| | |
|----------------------------------|-----|
| <u>SYNOPSIS</u> | 166 |
|----------------------------------|-----|

LIST OF PUBLICATIONS

ABSTRACT

Selective functionalization of polymer surfaces has attracted considerable attention in recent years. The interest emerges because it enables the creation of functional properties on polymer surface while fully retaining the desirable bulk properties of the polymer. Furthermore, selective functionalization of polymers poses considerable challenges. Control of chemo- and topological selectivity requires innovative and imaginative application of organic chemical transformations. This thesis presents results of a photochemical modification of poly(olefin)s with view to introduce a reactive anhydride group on the polymer surface. The reactive anhydride group can be transformed into a wide mosaic of functional groups by simple chemical transformation. Functional groups so generated were characterized by a variety of surface analytical techniques for both chemoselectivity and functional group integrity. Surface selective functionalization was determined by angle dependent XPS study and concentration of functional group was estimated to be $\sim 1.2 \times 10^{15}$ molecules/cm². Wide variations in wettability ($40-106^\circ$) of the poly(ethylene) surface was observed depending on the nature of chemical functionality and the manner of their attachment. A brief study of thermal reconstruction of PE-succinic acid and some of its derivatives was conducted.

The azobenzene group are known to be isomerized by irradiation with light of appropriate wave length. The photochemical isomerization of azobenzene groups attached to semicrystalline films was studied using UV-visible spectroscopy. The thermal Z→E isomerization rate of azo compounds attached to a semicrystalline polymer was also determined. It was observed that the rate of isomerization from Z→E is faster in the case of a semicrystalline polymer.

Chemical and physical surface etching is useful for various polymer applications such as adhesion, electroplating, painting etc.. Azo groups present on the surface of the polymer were found to undergo bond scission, when exposed to electrons or thermal energy, causing nitrogen to be expelled from the surface/bulk of the polymer. This results in creation of surface pits or craters. This phenomenon was examined by scanning electron microscopy.

It is well known that hindered amine light stabilizers (HALS) are useful in improving light stability of polymer. HALS was introduced into polyolefin (PE, PP, EP) surfaces. The photo-stability of polyolefin films with surface anchored HALS were compared with films stabilized with commercial HALS (TINUVIN770) by melt blending. It was observed that the photo-stabilizing efficiency of surface anchored HALS is superior that of melt blended polyolefins.

List of Tables

| | | |
|-----|---|-----|
| 1.1 | Grafting of Glycidyl methacrylate and Glycidyl acrylate on PP and LDPE. | 16 |
| 1.2 | Grafting of vinyl monomers on LDPE and PP film, using vapor phase photochemical method. | 18 |
| 1.3 | Surface functionalities induced by corona treated at a polyethylene surface. | 24 |
| 3.1 | Atomic ratios of carbon and oxygen of succinic acid modified poly(ethylene) film 2. | 87 |
| 3.2 | Weight of poly(ethylene) film upon irradiation of UV light in presence of maleic anhydride. | 89 |
| 3.3 | Atomic ratios of carbon and oxygen of succinic acid modified poly(ethylene) film. | 90 |
| 3.4 | Effect of maleic anhydride and benzophenone concentration. | 91 |
| 3.5 | Summary of solvent effects on surface photografting. | 92 |
| 3.6 | Effect of solvent on surface reaction. | 93 |
| 3.7 | Advancing and receding contact angle of PE bearing succinic anhydride group. | 94 |
| 3.8 | Water contact angle of PE film bearing succinic acid before and after thermal treatment. | 95 |
| 4.1 | Surface wettability of functionalized poly(ethylene)s. | 105 |
| 4.2 | Contact angle of water on functionalized PE interfaces. | 108 |
| 4.3 | Contact angle of water on poly(ethylene) interface that contain different counter cations. | 110 |
| 4.4 | Water contact angle of PE Film bearing salts before and after annealing. | 113 |
| 4.5 | Contact angle of water on poly(ethylene) interface that contain different functional groups and whose contact angle changes with heating. | 114 |
| 5.1 | Concentration of polymer-bound azobenzene present in polyolefin films. | 126 |
| 5.2 | Survey of the structure and the results for the investigated polymers. | 132 |

- 5.3 Half life of thermal isomerization of polyolefin bound azobenzene and amorphous azo polymer. 133
- 6.1 Concentration of Polyethylene film bearing azobenzene and phenyl amine (2h irradiated sample). 148
- 7.1 Concentration of polymer-bound HALS-2 present in polyolefin films. 155

List of Figures

- 1.1 Vapor-phase surface grafting apparatus (HPM, high-pressure mercury). 2
Monomer and initiator are evaporated from a beaker.
- 1.2 Liquid-phase surface photografting apparatus: (a) high-pressure Hg lamp, (b) 2
interference filter, (c) borosilicate glass plate, (d) reacting solution, (e) polymer
film, (f) glass vessel, and (g) clamp screw.
- 1.3 Apparatus of vapor phase photografting. 3
- 1.4 Sketch of continuous surface photografting system (1) film feed roll, (2) 5
presoaking solution, (3) thermocouple (screened from UV lamp), (4) vapor inlet
of monomer and initiator, (5) running rolls, (6) nitrogen inlet, (7) quartz
window, (8) container of solid monomer, (9) electric heater, (10) exhaust outlet,
(11) cooling water pipe, (12) UV lamp, (13) parabolic reflector, (14) air inlet,
(15) air outlet, (16) screen, (17) lamp support, (18) monomer and initiator bubble
solution, (19) take-off roll, (20) driving motor, (21) temperature indicator, (22)
reaction chamber, and (23) lamp box.
- 1.5 Schematic diagram of a bell jar reactor: (A) vacuum chamber (B) rf electrode 6
(C) grounded electrode.
- 1.6 A schematic diagram of a corona-discharge setup. 8
- 1.7 Etching rate of polyolefins by chromic acid at 70°C. 9
- 1.8 ATR-IR spectra of polyethylene film: A, commercial film; B, PE-H, additive 11
free film; C, after oxidation with concentrated chromic acid solution; D, PE-
CO₂H, after treatment with 70% aqueous HNO₃ at 50°C; E, PE-CO₂H, after
extraction with hot 2-propanol.
- 1.9 Change in relative carbonyl absorption with time. Measured at 1735 cm⁻¹ with 16
CH₂ scissoring peak at 1470 cm⁻¹ as internal standard. LDPE grafted with GA
and GMA with acetone as solvent.
- 1.10 Polypropylene grafted with GA and GMA as a function of irradiation time. The 17
relative absorbance of the carbonyl peak at 1740 cm⁻¹ normalized against
methylene scissoring at 1470 cm⁻¹ was measured with ATR-IR and transmission
IR on 14 μm thick films.

- 1.11 Advancing contact angle measurements of water against LDPE grafted with GA and GMA at different UV irradiation times. Acetone was used as solvent. 17
- 1.12a Vapor phase photografting of monomer mixtures of St with AN, GMA, AA and MAA on PE film sensitized with BPO: (a) (o) St-AN; (●) St-GMA; (b) (o) St-AA, (●) St-MAA. Quantity of monomer, 2 mL; irradiation, 60°C, 60 min. 19
- 1.12b Vapor phase photografting of monomer mixtures of MAH with comonomers on PE film sensitized with BPO. Quantity of monomer, 2 mL; irradiation, 60°C, 60 min. (o) MAH-St; (●) MAH-BMA; (◐) MAH-EVE (40°C); (◑) MAH-BVE; (◒) MAH-VP. 19
- 1.13 Vapor phase photografting on LDPE film sensitized with BPO. Quantity of monomer: 2 mL, Irradiation: 60°C, 60 min, concentration of BPO: 0.3 wt%. 20
- 1.14 (a) C 1s and (b) N 1s spectra of polyethylene as a function of nitrogen-plasma treatment time. 22
- 1.15 Various surface grafting methods. 36
- 1.16 Possible structure of grafted surfaces: (a) homogeneous coverage of mobile chains, (b) mobile is constrained by cross-linking among grafted chains, (c) non homogeneous coverage, the substrate surface is still exposed, (d) the surface layer contains macromolecular chains both grafted and belonging to the substrate. 37
- 1.17 The Young equation. 45
- 1.18 Experimental set-up of XPS. 48
- 1.19 XPS spectrum of PE. 49
- 1.20 XPS spectrum of PE contaminated by silicone oil. 49
- 1.21 Carbon C1s peak of PTFE. The small peak at 285 eV is hydrocarbon contamination. 49
- 1.22 Schematic representation of the sputtering process: (1) ion emission near the impact point; (2) ion emission at some distance from the impact point; (3) no emission, only secondary phenomena. 52
- 1.23 An AFM optical sensing system. 54

- 1.24 XPS spectra of poly(ethylene terephthalate) (a) before cleaning and after 55
cleaning with an ultrasonic cleaner in (b) methanol, (c) acetone and (d) n-
heptane.
- 1.25 Top: The advancing contact angle (θ_a) of water on PE-CO₂H as a function of the 58
time the polymer had been heated at 100°C. samples were heated under vacuum
or under argon prior to determination of θ_a with water at either pH 1 or pH 13.
The value of θ_a on PE-H does not change under these conditions. Bottom: The
normalized XPS (ESCA) O_{1s} signal intensity obtained from PE-CO₂H as a
function of time at 106°C. Samples were heated under argon prior to
examination by XPS.
- 1.26 Photoinduced change in (o) wettability and (•) absorbance of PHEMA film 59
having pendant azobenzene groups. UV: $\lambda = 350 \pm 50$ nm; Vis: $\lambda > 470$ nm.
Azobenzene content was 0.387.
- 3.1 Sketch of reactor. Monomer and sensitizer are evaporated from a beaker 78
- 3.2 ATR-IR spectra of film a: film as such prepared, b: film after exposure to MA, 82
C: film after exposure to UV.
- 3.3 ATR-IR spectra of functionalized polyethylene surfaces (a) polyethylene, (b) 1, 83
(c) 2, (d) 3, (e) 4.
- 3.4 ATR-FTIR spectra of film (a) 1, (b) Commercial sample of melt functionalized 84
maleated polyethylene.
- 3.5 Calibration curve for 4-aminoazobenzene estimated by UV at $\lambda_{\max}=385$ nm. 85
- 3.6 (a) C_{1s} binding energy of succinic acid modified polyethylene at 35°, 55°, 75° 86
takeoff angle (irradiation time: 3min).
(b) C_{1s} binding energy of succinic acid modified polyethylene at 35°, 55°, 75°
takeoff angle (irradiation time: 6min).
- 3.7 Transmission FTIR spectra of modified polyethylene films at various reaction 88
time (a) 0 h, (b) 1 h (c) 2 h (d) 3 h (e) 5 h and (f) 8 h.
- 3.8 Change in the ratio of anhydride: carbon peak area (area 1789 cm⁻¹/area 1465 89
cm⁻¹) with reaction time.

| | | |
|-----|--|-----|
| 4.1 | Change in contact angle with pH of succinic acid modified (polyethylene), (o, PE; Δ , 1; \bullet , 2) (irradiated for 5 h). | 106 |
| 4.2 | Reconstruction of PE-[SO ₃ ⁻ NH ₃ R ⁺] at 70°C in vacuum at various times with various R groups as measured by advancing water contact angle. | 109 |
| 4.3 | FT-IR spectra of film a: Film bearing succinic acid group, b: Film bearing teramethyl ammonium salt. | 111 |
| 4.4 | XPS spectra of nitrogen of sample 15. | 111 |
| 4.5 | XPS spectra of sample 2, a: before heating, b: after heating. | 115 |
| 5.1 | Calibration curve for 4-amino azobenzene at $\lambda_{\text{max}}=372$ nm. | 122 |
| 5.2 | Photographs of films 4, 21 and 3,22. | 124 |
| 5.3 | FTIR spectra os sample 4 and 3. | 125 |
| 5.4 | Photoinduced change in (o) wettability and (\bullet) absorbance of PHEMA film having pendant azobenzene groups. UV: $\lambda = 350 \pm 50$ nm; Vis: $\lambda > 470$ nm. | 127 |
| 5.5 | Photoinduced changes in absorbance (a) and wettability (b) (sample a, Figure 5.2). | 127 |
| 5.6 | Absorption spectra of \underline{e} (Figure 5.8) before 1 and after 2 U.V light irradiation. | 128 |
| 5.7 | Plots of $\ln(T_{\text{isom}})/t$ vs time(t) for the semicrystalline and amorphous azo polymer. | 129 |
| 5.8 | Conversion to cis as a function of UV irradiation time at $\lambda_{\text{max}}(t)$ for sample \underline{c} . | 130 |
| 5.9 | General structure of polymer-bound azo compounds. | 131 |
| 6.1 | XPS spectra of nitrogen (a) sample 4 (b) sample 6. | 143 |
| 6.2 | SEM microphotographs of sample 4: (a) low magnification (b) medium magnification (c) high magnification. | 144 |
| 6.3 | SEM microphotographs of sample 6: (a) low magnification (b) high magnification. | 145 |
| 6.4 | Absorbance spectra of sample 4: (a) before electron beam irradiation (b) after electron beam irradiation. | 146 |

| | | |
|-----|--|-----|
| 6.5 | SEM microphotographs of sample 4 after plasma exposure. | 147 |
| 6.6 | FT-IR spectra of sample 25: (a) before heating (b) after heating. | 148 |
| 6.7 | SEM microphotographs of sample 25, after heating: (a) low magnification (b) high magnification. | 149 |
| 7.1 | FT-IR spectra of polyethylene film. (a) Succinic anhydride modified, (b) PB-HALS-1, (c) PB-HALS-2. | 156 |
| 7.2 | Photostabilizing efficiency of polymer-bound HALS and Tinuvin 770 in polyethylene films. | 157 |
| 7.3 | Photostabilizing efficiency of polymer-bound HALS and Tinuvin 770 in polypropylene films. | 158 |
| 7.4 | Photostabilizing efficiency of polymer-bound HALS and Tinuvin 770 in E-P copolymer films. | 158 |
| 7.5 | Carbonyl absorbance for PP film grafted with hindered amine: 4-amino-2,2,4,4-tetramethylpiperidine (AP), 2,4-dihydroxybenzophenone (DHBP), phenyl 4-aminosalicylate (PAS), irradiated in UVICON at 50°C for different times. | 159 |

CHAPTER I

SURFACE MODIFICATION OF POLYMERS

1.1 INTRODUCTION

Polymer surface chemistry is an area of practical and academic interest.^{1a,b,c} A principal concern in this area is the development of methods that selectively introduce and transform functional groups on the surfaces. In the case of functionalized polymer surfaces that are commonly produced by modification of non polar polymer films,²⁻⁴ good selectivity at the surface versus bulk can often be achieved in the initial functionalization chemistry, either through the use of highly reactive reagents or through the use of reagents or solvents that minimally interact with bulk polymer. Etching of polyethylene surface by chromic acid to generate carboxyl, ketone and aldehyde groups on the surface has been well studied with an objective to improve the adhesive properties of the polymer.^{5,6} Whitesides and coworkers oxidized polyethylene surface under controlled conditions and further modified the surface by derivatizing the surface carboxyl group. There are numerous reports on surface modification of polymers using techniques such as gamma rays, plasma, corona and photochemical modification. However, the characterization of these polymers present special problems as the reaction takes place only up to a few angstroms level. A number of techniques such as ATR FTIR, UV, contact angle, XPS, SEM, ESR and gravimetry have been used to characterize polymer surfaces. Properties such as wetting, weathering, permeation, sorption, adhesion, dye adsorption, biocompatibility and cell attachment are influenced by the nature of the polymer surface.⁷⁻⁹ These properties can be monitored and controlled by proper selection of the surface modification reaction. In applications where surface constitution of the polymer is important, novel strategies for modification according to the requirement is necessary. A reactive anchoring site on the surface of the polymer, capable of undergoing diverse chemical reaction, is therefore very desirable.

1.1.1 Chemical modification

Chemical modification such as oxidation, reduction, hydrolysis etc are the most popular techniques to improve surface properties of polymers. Chemical etching is used to convert a smooth hydrophobic polymer surface to rough hydrophilic surface by dissolution of amorphous regions and surface oxidation. Etching of polymer surface is an important step for preparing the polymer for electroless plating and adhesive bonding. Specific examples of etchants are chromic acid for polyolefins^{5,6} a solution of sodium metal either in liquid ammonia or as a complex with naphthalene, solvated by an excess of glycol dialkylether for fluoropolymers^{10,11} and on acid or base for polyesters¹² and polyimide.¹³

1.1.2 Photochemical modification

Surface photografting is the most useful method of surface modification and is performed by irradiating the polymer film using UV light in the presence of a solvent containing a suitable monomer and sensitizer. Modification can occur at the surface or in the bulk of the polymer. The depth of modification can be controlled by the interaction between the substrate polymer and the solvent. If the penetration of the solvent is limited to a very small depth surface grafting predominates. However, if the penetration of solvent is extensive then modification will occur at greater depths. Loss of property such as crystallinity, tensile modulus and surface gloss can occur if modification takes place too deep into the polymers surface. Photochemical modification can be performed in two ways i.e vapor phase and liquid phase modification (Figure 1.1,1.2).¹⁴⁻¹⁶

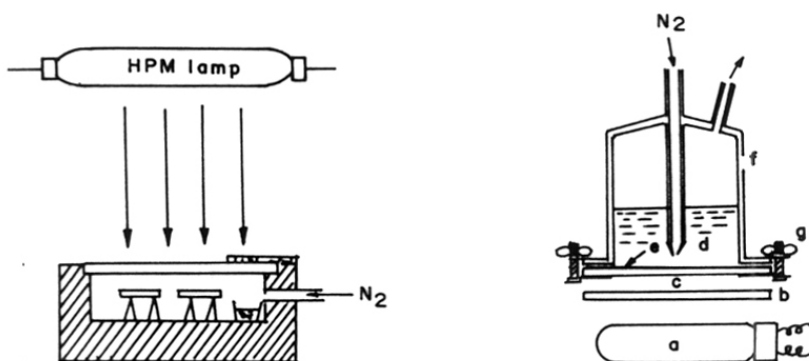

Figure 1.1: Vapor-phase surface grafting apparatus (HPM, high-pressure mercury).

Monomer and initiator are evaporated from a beaker

Figure 1.2: Liquid-phase surface photografting apparatus: (a) high-pressure Hg lamp, (b) interference filter, (c) borosilicate glass plate, (d) reacting solution, (e) polymer film, (f) glass vessel, and (g) clamp screw

In vapor phase modification, polymer film and solution containing monomer, sensitizer and suitable solvent are placed in a temperature controlled chamber. The reaction is performed under N_2 atmosphere. The polymer sample is irradiated in presence of vapor of monomer and sensitizer.¹⁴⁻¹⁶ But for other system¹⁷ (Figure 1.3) the reaction is carried out at 60°C using pyrex glass tube.

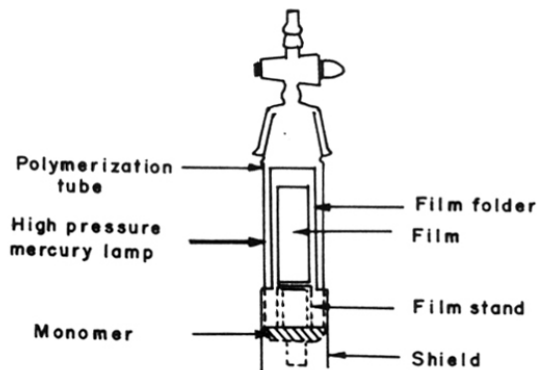

Figure 1. 3: Apparatus of vapor phase photografting

Polymer films are immersed in a solvent containing known quantities of sensitizer and poly(vinyl acetate) (PVAC, $M_w = 100,000$) and dried to prepare sensitizer-coated films. The polymer film is fixed on a sample holder and is kept at the center part of the tube. Monomer is placed at the bottom part of the tube. The pressure of the system, after freeze-thaw cycles is adjusted to 1 mm Hg.

In liquid phase modification (Figure 1.2), polymer film is in direct contact with a solution of monomer and sensitizer. For surface photografting UV radiation is used. Different types of UV sources are available such as medium pressure Hg lamp, high pressure Hg lamp, Xenon lamp. Medium pressure Hg lamp is the most popular.

Benzophenone and its derivatives are probably the most commonly used photoinitiator for surface photografting. When benzophenone is irradiated by UV light of wavelength ≥ 290 nm it gets excited to a short-lifetime singlet state and then relaxes to a more stable triplet state. Benzophenone in the triplet state can abstract a hydrogen atom from a polymer substrate and create an active site for surface graft polymerization. The mechanism is summarized in Scheme 1.1.

1. Initiation:

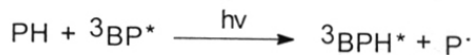

2. Propagation:

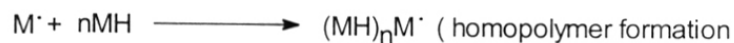
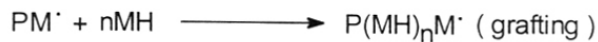

3. Termination with a radical (R[•]):



Scheme 1.1: Photografting mechanism

The process shown in Figure 1.1-1.3 are used in laboratory studies. They are not useful for industrial application due to long irradiation time and discontinuous nature of the process. Zhang and Ranby developed a process for continuous photografting of polymer films and fibers.¹⁹⁻²¹ A schematic diagram of this setup is shown in Figure 1.4.

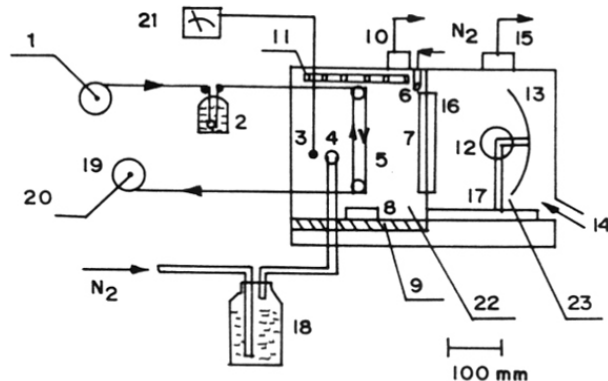

Figure 1.4: Sketch of continuous surface photografting system (1) film feed roll, (2) presoaking solution, (3) thermocouple (screened from UV lamp), (4) vapor inlet of monomer and initiator, (5) running rolls, (6) nitrogen inlet, (7) quartz window, (8) container of solid monomer, (9) electric heater, (10) exhaust outlet, (11) cooling water pipe, (12) UV lamp, (13) parabolic reflector, (14) air inlet, (15) air outlet, (16) screen, (17) lamp support, (18) monomer and initiator bubble solution, (19) take-off roll, (20) driving motor, (21) temperature indicator, (22) reaction chamber, and (23) lamp box

1.1.3 Other modification (Plasma and Corona)

Plasma modification presents another class of reactions which are widely used to modify surfaces.^{22,23} In this method, plasma of a gas (element, molecule or monomer) create functional groups on the polymer surface. During the plasma irradiation conditions, there is a chance of crosslinking and oxidation of the polymer depending on the length of exposure to plasma, power of the discharge and type of the gas used for modification. The chemical functionality introduced is largely dependent upon the experimental system. Both high purity gases and clean equipment are essential. Even with the care, the surfaces which are produced with even low energy plasmas contain a considerable amount of chemical heterogeneity. Studies show that a thin layer (100Å) of the polymer surface can be modified by this method,²⁴ however the surface is chemically heterogeneous. These conclusions were reached based upon XPS and contact angle data. A typical plasma system consists of a gas inlet, a reactor vessel, a vacuum pump, a matching network and a power source. Various

reactors have been used in plasma processing. A typical reactor is a bell jar with circular or square electrodes as shown in Figure 1.5. As the frequency increases, electrodes may be placed outside the reactor vessel. There are number of parameters that determine the rate of plasma polymer deposition and the chemical and physical nature of the deposited films and modified surfaces.

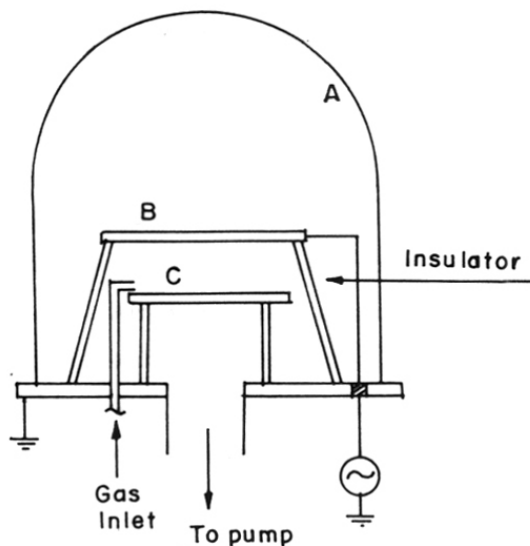

Figure 1.5: Schematic diagram of a bell jar reactor: (A) vacuum chamber (B) rf electrode (C) grounded electrode

The main advantages of this method of the plasma induced surface modification technique are:

1. Modification can be confined to the surface layer without modifying the bulk properties.
2. Excited species in a gas plasma can modify the surfaces of all polymers, regardless of their structure and chemical reactivity.
3. By choice of the gas used, it is possible to choose the type of chemical modification for the polymer surface.
4. The use of a gas plasma can avoid the problems encountered in wet chemical techniques such as residual solvent on the surface and swelling of the substrate.
5. Modification is fairly uniform over the whole surface.

The disadvantages of plasma techniques are:

1. Plasma treatments must be carried out in vacuum. This requirement increases the cost of operation.
2. The process parameters are highly system dependent; the optimum parameters developed for one system usually cannot be adopted for another system.
3. It is difficult to control precisely the nature and amount of a functional group formed on a surface.

The corona discharge method is an alternative technique widely used for the modification of polyolefins. The technique is relatively simple; a film of polymer is passed through a gap having a high electrical potential. Air in the gap is ionized and the corona which forms reacts with the film. A variety of oxidized carbon species are found on the surface which include carboxylic acid, hydroperoxide, hydroxyl and ketone functionalities.²⁵ Although these surfaces contain a wide variety of functional groups, auto adhesion (the sticking of two polymer surfaces together) is attributed to hydrogen bonding between carbonyl and enol functions on opposite discharge treated surfaces.

A corona treatment system consists of a high-voltage and high-frequency generator, an electrode and a grounded metal roll as shown in Figure 1.6. The grounded roll is usually covered with an insulating material such as polyester, ceramic, epoxy or silicon rubber. The system can be treated as a large capacitor with the electrode and the grounded roll as the plates of the capacitor and the roll covering and air as the dielectric. Corona occurs when a high voltage is applied across the electrodes to cause ionization of air. A plasma is formed, and a blue light color can be observed in the air gap. This atmospheric pressure plasma is called a corona discharge. The insulating material, which covers the grounded roll, prevents a direct arc between the two electrodes. However, the roll covering material is subjected to damage by heat and from the corona. This problem is resolved by using a quartz tube filled with irregularly shaped metal pellets as the electrode. Quartz, being impervious to damage by heat or corona, is a good material for this application. It is very common to find a corona treatment system installed downstream of an extruder. The two most important parameters that control the surface properties of the treated film, namely power input and film speed,

determine the total amount of energy available for the treatment. Other parameters that have significant effects on a treated surface are air-gap thickness, relative humidity, and treatment temperature. The nature of the polymer also plays an extremely important factor in determining the optical setting for each parameter.

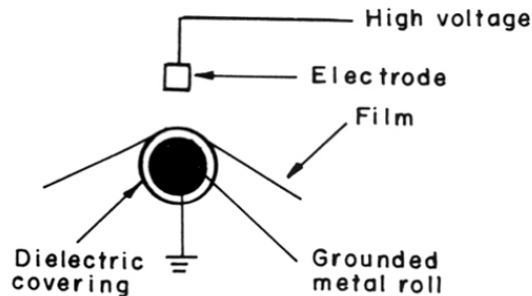

Figure 1.6: A schematic diagram of a corona-discharge setup

The main advantages of this method are:

1. The equipment is very simple and cost effective .
2. Corona treatment can be used in a continuous operation .

The main disadvantages of this method are:

1. Corona discharge treatment may not be as consistent as low pressure plasma treatment because of variation in ambient conditions such as temperature and humidity.
2. As corona discharge treatment is operated in open air, contamination might be a problem.
3. In some cases corona treatment have been shown to be less effective than low pressure plasma treatment in modifying surface properties of polymers. In addition, the flexibility of using gases of various type in low pressure plasma treatment does not exist in corona treatment. Thus the surface functionality is restricted to oxygen containing species.
4. Treatment in low pressure plasma systems are generally more uniform than corona treatment.

1.2 SURFACE MODIFICATION OF POLYETHYLENE AND POLYPROPYLENE

1.2.1 Chemical methods

Among all surface modification techniques, wet chemical treatment was the first technique used to improve the surface properties of polymer. The chemical composition of the solution employed in the treatment was in general mutated from general wet chemistry knowledge. Thus, for instance, chromic acid was used to oxidize polyolefins such as polyethylene and polypropylene, which are two examples from a general class of rather unreactive hydrocarbon polymers. These polymers are characterized by a non polar low energy hydrocarbon surface. Since no functional group is present on the surface, the surface is not wettable by polar solvents. These factors limit the utility of a polyolefin in specific applications.

Chemical methods to oxidize the surface of polyolefins include the use of strong oxidants like fuming sulfuric acid, nitric acid and chromic acid/sulfurous acid mixture.⁸ Chain scission and etching are obtained together with the introduction of oxygen containing functional groups. Chromic acid action on polyethylene has been extensively studied due to its commercial importance.^{26,27} In a solution of chromium trioxide in water and in the presence of sulfuric acid the following species exist for the establishment of several chemical equilibria, HCrO_4^- , $\text{Cr}_2\text{O}_7^{2-}$ and $\text{O}_3\text{CrOSO}_3^{2-}$ all causing oxidation of the polymer surface.

Blais and coworkers studied the effect of a chromic acid solution ($\text{K}_2\text{Cr}_2\text{O}_7$: H_2O : H_2SO_4 = 44:7.1:88.5 by weight) on the surface of LDPE, HDPE and PP using TEM, SEM, ATR-IR,²⁸ contact angle measurements. The polymer were found to have different chemical reactivity towards the etching of the surface. (Figure 1.7).

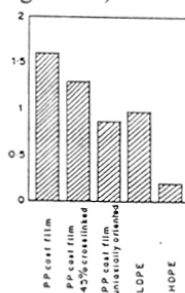

Figure 1.7: Etching rate of polyolefins by chromic acid at 70°C

Figure 1.7 shows that PP is etched more readily than LDPE, which in turn is less resistant than HDPE. From contact angle data it was observed that with etching time the advancing contact angle of LDPE and HDPE continuously decreased. However, for PP the contact angle initially decreased and after longer treatment time it increased again to a value lower than that of untreated PP. The presence of tertiary C-H sites in PP, causes rapid oxidation and produces a completely soluble surface layer (oligomer) at longer oxidation time. Upon washing, this surface oxidation layer is removed and the contact angle. Chemical modifications on polyolefin surfaces due to chromic acid can be readily detected by XPS.²⁹ From XPS analysis of chromic acid etched ($K_2Cr_2O_7 : H_2O : H_2SO_4 = 7 : 12 : 150$ by weight) LDPE and PP, it was observed that groups present on both polymers are sulphate, hydroxyl, carbonyl and carboxyl. But in case of LDPE traces of Cr was observed. A substantial difference in oxidation rate was observed with polypropylene attaining the maximum degree of modification more rapidly than polyethylene. However, the rate of penetration was higher in case of polyethylene. XPS variable angle study showed that after 1 minute etching at 20°C, the degree of oxidation in case of PP was depth dependent, whereas for PE under all etching conditions tested, the samples were homogeneously oxidized within the XPS sampling depth.

Apart from $K_2Cr_2O_7-H_2SO_4$ other etchants such as $KClO_3-H_2SO_4$ and $KMnO_4-H_2SO_4$ were investigated by Baszkin and Ter-Minassian-Saraga.^{30,32} The number of oxygen containing functionalities as a function of oxidation time and reagent was assessed by the amount of ^{45}Ca adsorbed from an aqueous calcium chloride solution³⁰ using an adsorbed paramagnetic probe such as, the ion Mn(II), ESR spectroscopy and XPS and contact angle measurements. Among the oxidizing reagents $KMnO_4-H_2SO_4$ was found to be stronger oxidizing agent than either $KClO_3-H_2SO_4$ or $K_2Cr_2O_7-H_2SO_4$.

Whitesides and coworkers³²⁻³⁶ carried out extensive studies on the surface oxidation and functionalization on LDPE. The oxidizing mixture was chosen so as to minimize non-carbonyl IR adsorption bands ($CrO_3 : H_2O : H_2SO_4 = 29 : 42 : 29$ by weight) and the sample was further treated by nitric acid in order to solubilize inorganic residues. After treatment with 70% aqueous nitric acid at 50°C or 6N hydrochloric acid at 50°C, a colorless

polyethylene film was obtained which showed no new functionality detectable by ATR-IR other than carbonyl derivative (Figure 1.8).

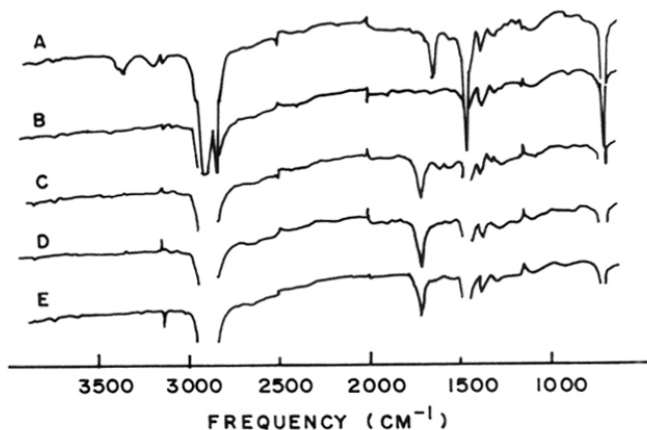
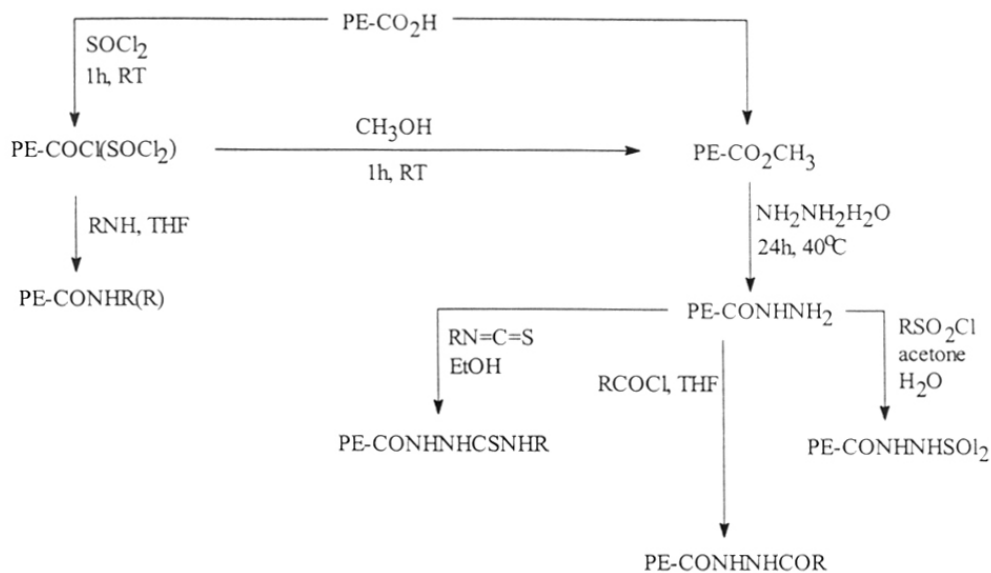

Figure 1.8: ATR-IR spectra of polyethylene film: A, commercial film; B, PE-H, additive free film; C, after oxidation with concentrated chromic acid solution; D, PE-CO₂H, after treatment with 70% aqueous HNO₃ at 50°C; E, PE-CO₂H, after extraction with hot 2-propanol

According to the authors, LDPE surface contained primarily carbonyl derivatives with approximately 60% of carboxylic acid group and 40% as ketones or aldehydes. The product film PE-COOH was visibly etched as evidenced by microscopic examination. However, question arises whether the surface carbonyl groups are firmly bound to the unoxidized bulk polymer or not. The majority of the surface carbonyl groups of PE-COOH were firmly attached because oxidation of PE-H to PE-COOH occurred by cleavage of carbon-carbon bonds. From the intensity of carbonyl group it was observed that there was no appreciable decrease of carbonyl peak after washing in a variety of solvents (THF, CH₂Cl₂, Et₂O, H₂O, MeOH, CHCl₃, CCl₄, DMF). Therefore, surface carbonyl groups are not attached to low molecular weight soluble fragments.

The density of surface carboxylic group generated at the surface was detected by two independent fluorimetric techniques and was to be approximately 2×10^{15} groups/cm² of geometric film area. But the actual surface density is lower than observed number due to

surface roughness. The surface functionality (PE-COOH) could be converted into different functional groups (Scheme 1.2) using a number of organic chemical transformations.



Scheme 1.2: Scheme of reactions on surface functionalized polyethylene

An intriguing observation is that reaction with SOCl_2 is not completely clean in the sense that some SOCl_2 is dissolved in polyethylene and affects successive reactions. But in the case of hydrazine hydrate the reaction is clearer because the reagent is immiscible with the hydrocarbon and does not swell or dissolve the polyethylene film.

The thermal effect on functionalized polymer surface was studied by contact angle and XPS measurement.³²⁻³⁶ It was observed that surface hydrophilicity decrease when heated in air but hydrophilic character of the interface of PE-CO₂H was retained essentially indefinitely (months to years) at room temperature. When PE-CO₂H was heated at 35-110°C the surface became hydrophobic and similar to unfunctionalized polyethylene. This is due to the reorientation effect of functional group present into the surface, the temperature and size of the functional group.³⁶

Metal catalyzed oxidation of polyolefins is a widely used technique of oxidation. The reagent used in this method is various iron salts which forms carboxylate complexes of

Fe(III). The actual reagent is reported to be an Fe^{v} oxenoid species. Barton used this reagent for selective hydrocarbon functionalization.^{37,38} Bergbreiter⁸ also applied the same chemistry on polyethylene and polypropylene. Using different analytical technique contact angle, IR, PS analysis, the oxidation of polyolefin was shown to proceed according to the Scheme 1.3.

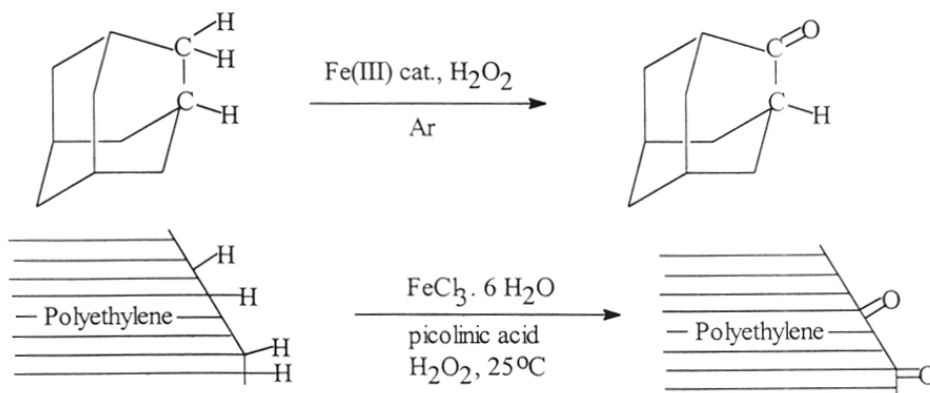

Scheme 1.3: polyolefin oxidation by metal catalyst

Derivatization by reduction and esterification with either trifluoroacetic anhydride or pyrene butyric acid chloride yielded an XPS labeled film or a fluorescent labeled film which confirmed that oxidation of the polyolefins had occurred.⁸ Using fluorescent spectroscopy, the level of functionalization was determined. Hydrolysis of the pyrene ester of a $\text{CrO}_3/\text{H}_2\text{SO}_4$ etched film and a iron cluster oxidized film showed that there were 5×10^{14} hydrolyzable pyrene groups on the former film and 1×10^{14} hydrolyzable pyrene groups on the latter film. These agreed with the more qualitative estimates of the relative extent of functionalization seen from ATR-IR and fluorescence spectroscopy of the films themselves. An advantage of this process is its mildness and the absence of etching and other gross morphological modification of the polymer substrate. A deficiency is the low level of functionality introduced. The functionalization is only at a level of 10-20% of what can be achieved by a conventional oxidative etching reaction.

Another process which functionalizes polyolefins without chain scission is the carbene insertion chemistry. This chemistry which was initially studied by Carlsson and Ostersaas involved generation of a reactive carbene in the presence of a solid polymer.²⁰ Various carbene sources and carbenes were used including ethyl diazoacetate and difluorocarbene.

Nitrenes also reacted with polyolefins. Since the carbenes were generated in the gas phase, dimerization reactions leading to olefin were diminished. The major reaction of the intermediate carbenes in such cases presumably occurred on encountering the hydrocarbon polymer. The inserted product is an ester which can be further modified by conventional organic chemical transformations. A disadvantage of this approach is that the overall product of these reactions can have a lot of carbonyl groups at the surface of a polymer that are not attached through carbon-carbon bonds. This is because insertion can occur either at C-H bonds of polyethylene or at C-H bond of the ester groups produced at polymer surface. As a result, significant amount of functional groups can be lost from the surface of these polymers.

Sulfonation of polyethylene with fuming sulfuric acid is a facile reaction and leads to sulfonic acid containing surfaces.^{39,40} This sulfonation chemistry works with polyethylene and polypropylene. In practice, the reaction times must be fairly short otherwise because charring can occur. In addition sulfonation of films require careful work-up to avoid highly exothermic heating (due to the heat of hydration of sulfuric acid) up on work-up with water. The presence of SO₃H groups on the surface can be ascertained in various ways. Most notable is a rapid increase in wettability. The presence of sulfur can also be detected by XPS spectroscopy and the density of sulfonic acid groups can be measured either by quantitative XPS spectroscopy or by reactive dyeing techniques. It is observed that there is a rough correlation between the measured advancing water contact angle and the S/C ratio for the initially produced sulfonated surfaces. However, this relationship between wettability and (-SO₃H)_{surface} does not seem to be maintained after surface reconstruction on annealing.⁴¹ Detailed XPS analysis of sulfonated high density polyethylene PE-SO₃H prepared by using a gaseous mixtures of SO₃+N₂ shows the presence of a number of functional groups, such as PE-SO₃H, PE-OSO₃H, PE-C=O and polyene unsaturation sequences. The presence of ketone and unsaturation was unequivocally established by XPS.⁴²

The behavior of sulfonated polyethylene surfaces differ significantly from that of other oxidized polymer surfaces in the sense that in these surfaces, hydrophilicity is increased upon thermal annealing.^{43,44} This behavior is in contrast to that seen with other oxidised polyethylene. The extent of reorganization can be controlled by converting the sulfonic acid

to its alkyl ammonium salts. Films with long chain alkylammonium (C_{18}) salts at their surface underwent thermal reorganization to less hydrophilic surfaces (increase in contact angle) while films with short chain alkylammonium (C_4) salts underwent reorganization to a more hydrophobic surface (decrease in contact angle). Sulfonated polyethylene films with intermediate sized alkylammonium (C_6) salts have contact angles which remained unchanged upon annealing. Contact angle measurements show that the advancing contact angle of PE-COOH changed from 74° to 100° upon heating but in the case of PE-SO₃H, the advancing contact angle decreases from 63° to 49° under similar conditions of annealing.

Solution halogenation of polyolefin is a free radical substitution reaction which suffers from the limitation that the halogen can diffuse into the polyolefin. To prevent this a two phase reaction (solid/gas) has been performed on polyolefin surfaces with control on reaction time. Several studies have described surface chlorination procedures which achieve some degree of surface selectivity.⁴⁵⁻⁴⁷ XPS has been used for obtaining both qualitative and quantitative information. Bromination, chlorosulfonation and chlorophosphorylation are other examples of this free radical substitution reaction which have been used to modify polyolefin surfaces.

1.2.2 Photochemical methods

Important factors which determine the nature of photochemical modification are structure of the polymer substrate and the nature of monomer used. The rate of the reaction as a function of irradiation time. Grafting does not occur in the crystalline regions since high crystallinity prevents penetration of the reagent in to this region of the polymer.

Polyethylene and polypropylene are semicrystalline polymer. The degree of crystallinity in polypropylene is higher compared to low density polyethylene. Therefore the grafting rate in polypropylene is slower compared to low density polyethylene. If one considers, the grafting of glycidyl acrylate or glycidyl methacrylate onto polyethylene and polypropylene, it is seen that the degree of grafting is more in the case of polyethylene (Table 1.1).

Table 1.1: Grafting of Glycidyl methacrylate(GMA) and Glycidyl acrylate(GA) on PP and LDPE

| Polymer | Crystallinity (%) | Grafting efficiency | |
|---------|-------------------|---------------------|--------|
| | | GMA (%) | GA (%) |
| LDPE | 38 | 46 | 63 |
| PP | 62 | 38 | 58 |

The grafting was performed in a reactor containing the polymer film in a solution of 2M monomer and 0.2M benzophenone in acetone under nitrogen at 60°C.¹⁶

The difference in the grafting efficiency is attributed to the difference in crystallinity of LDPE and PP. Grafting occurred preferably in the amorphous regions than the crystalline region, therefore grafting efficiency is more in the case of LDPE than PP.

The structure of the monomer also play an important role in determining grafting efficiency. If we compare the degree of grafting between GA and GMA on polyethylene or polypropylene, it is observe that GA is grafted more rapidly and more extensively than GMA (Figure 1.9 and Figure 1.10).

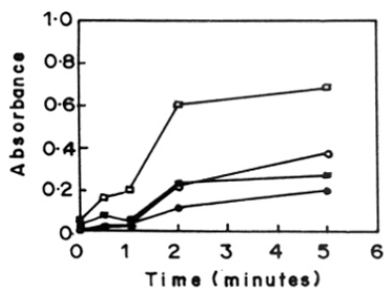

Figure 1.9: Change in relative carbonyl absorption with time. Measured at 1735 cm⁻¹ with CH₂ scissoring peak at 1470 cm⁻¹ as internal standard. LDPE grafted with GA and GMA with acetone as solvent

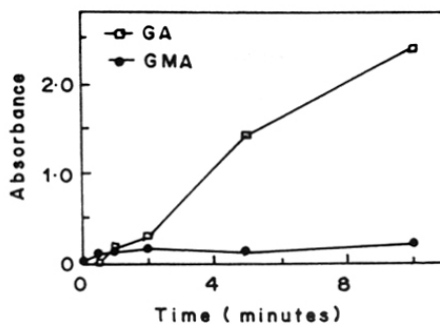

Figure 1.10: Polypropylene grafted with GA and GMA as a function of irradiation time. The relative absorbance of the carbonyl peak at 1740 cm^{-1} normalized against methylene scissoring at 1470 cm^{-1} was measured with ATR-IR and transmission IR on $14\text{ }\mu\text{m}$ thick films

The difference in grafting rate between GA and GMA can be explained by the difference in their structure. GMA is sterically hindered towards polymerization due to the disubstituted vinyl group and is thus expected to polymerize at a slower rate. The methyl group in GMA also stabilizes the intermediate radicals and lowers the activation energy for a radical attack on GMA with the subsequent GMA radical formation. Thus GMA will give higher rate of initiation than GA but a slower polymerization rate. From a study of contact angles, it was shown that polyethylene surface bearing GA shows slightly higher wettability than GMA grafted polyethylene surface (Figure 1.11), due to the higher hydrophilicity of poly GA and its greater efficiency of grafting.

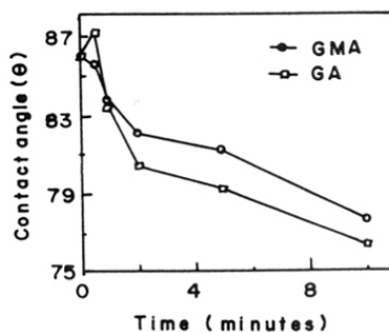

Figure 1.11: Advancing contact angle measurements of water against LDPE grafted with GA and GMA at different UV irradiation times. Acetone was used as solvent

Polyethylene and polypropylene can be modified by introducing different vinyl monomers and combination of monomers using vapor phase photochemical grafting^{17,48}(Figure 1.3). The results of vapor phase photografting sensitized by benzophenone, anthraquinone and benzoylperoxide are presented in Table 1.2 .

Table 1.2: Grafting of vinyl monomers on LDPE and PP film, using vapor phase photochemical method

| Monomer | Percent grafting, % | | | | | |
|---------------------------|---------------------|-----|-----|------|-----|-----|
| | PP | | | LDPE | | |
| | AQ | BPO | BP | AQ | BPO | BP |
| Methyl methacrylate (MMA) | 695 | 654 | 170 | 1164 | 620 | 146 |
| Acrylic acid (AA) | 200 | 241 | 289 | 297 | 251 | 377 |
| Methacrylic acid (MA) | 33 | 33 | 46 | 169 | 16 | 46 |
| Styrene (St) | 3 | 4 | 0 | 2 | 0 | 0 |

AQ: Anthraquinone , BPO: Benzoyl peroxide, BP: Benzophenone.

The sensitizers used in this study was not effective for styrene monomer. However, they were effective for MMA and AA. Anthraquinone was effective for MMA, but benzophenone was effective for AA irrespective of the polymer (PE or PP). Thus, the combined effect of sensitizer and monomer is an important factor to improve graft initiation.

Vapor phase photografting using a combination of monomers such as maleic anhydride and other comonomers (styrene, N-vinyl pyrrolidine, ethyl vinyl ether, n-butyl vinyl ether, benzyl methacrylate, α -methyl styrene) or styrene and comonomers such as (AN, GMA, AA and MAA) were carried out on polyolefin surfaces. The results are shown in Figure 1.12(a,b).

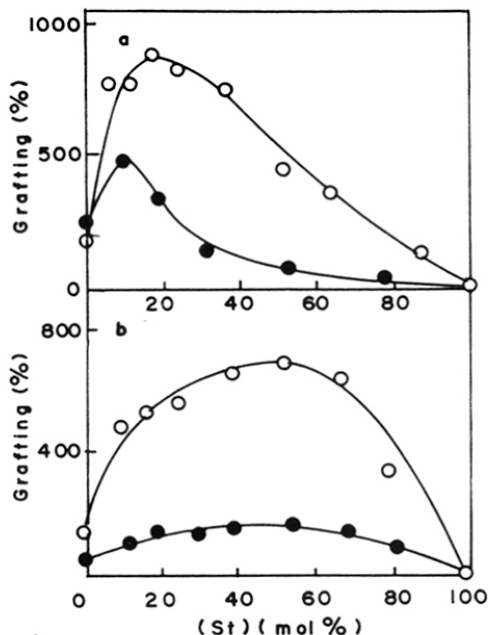

Figure 1.12a: Vapor phase photografting of monomer mixtures of St with AN, GMA, AA and MAA on PE film sensitized with BPO: (a) (O) St-AN; (●) St-GMA; (b) (O) St-AA, (●) St-MAA. Quantity of monomer, 2 mL; irradiation, 60°C, 60 min

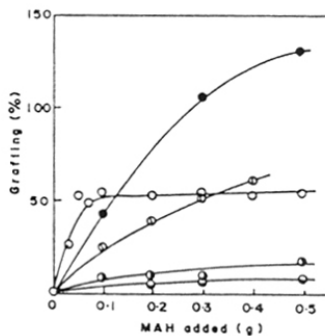

Figure 1.12b: Vapor phase photografting of monomer mixtures of MAH with comonomers on PE film sensitized with BPO. Quantity of monomer, 2 mL; irradiation, 60°C, 60 min. (o) MAH-St; (●) MAH-BMA; (⊖) MAH-EVE (40°C); (⊙) MAH-BVE; (●) MAH-VP

From Figure 1.12(a,b) it is evident that maleic anhydride is effective for grafting of monomers such as ethyl vinyl ether, n-butyl vinyl ether, benzyl methacrylate except styrene. Comonomers such as MMA, AN, VAC (Figure 1.13), exhibited high activities in grafting even in the absence of maleic anhydride.

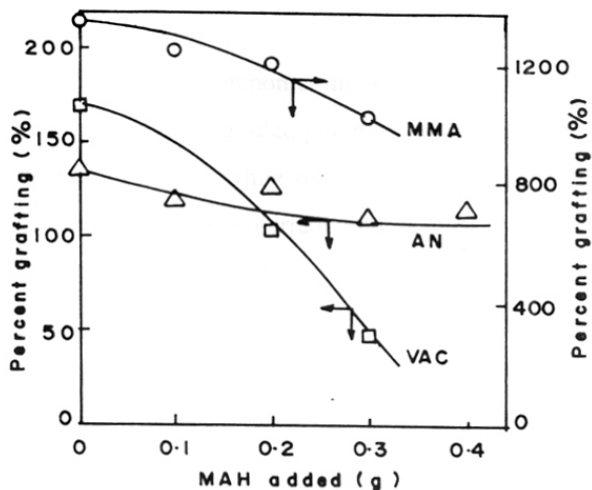

Figure 1.13: Vapor phase photografting on LDPE film sensitized with BPO. Quantity of monomer: 2 mL, Irradiation: 60°C, 60 min, concentration of BPO: 0.3 wt%

Styrene by itself did not undergo grafting; but the grafting efficiency was increased by using a combination of styrene and monomers such as AN, GMA, AA and MAA. The percent grafting exhibited a maximum value at a certain styrene monomer ratio.

Liquid phase photografting is another class of surface modification. Polyethylene and polypropylene surface can be modified by introducing different monomer using this method. Tazuka et al¹⁸ first developed this idea and introduced acrylamide onto the polypropylene film. They also studied concentration effect of sensitizer and monomer on polypropylene using this method. Later Kubota et al¹⁶ performed liquid phase photografting of various monomer on polyethylene and polypropylene surface.

In the liquid phase photografting, a deaerated system was employed to remove oxygen in the system which generally inhibits the radical polymerization of vinyl monomers. The oxygen removal process may be a disadvantage when the photografting is commercially utilized as a method for functionalization of polymer films on a large scale. To exclude the necessity of inert atmosphere during the course of reaction Kubota et al performed photografting of acrylonitrile (AN) and methacrylic acid (MAA) on low density polyethylene film on which benzophenone was coated earlier was investigated at 60°C in water medium under air atmosphere. In the case of AN monomer, where grafted polymer was formed predominately, oxygen in the system promoted the formation of both grafted

polymer and homopolymer. With MAA monomer in which homopolymer was formed preferentially compared to the formation of grafted polymer, the formation of homopolymer was accelerated by the presence of oxygen while suppressing that of grafted polymer. The formation of polyethylene peroxide by photo irradiation seemed to be a factor for the accelerated polymerization under air atmosphere. It was found that additives such as hydrazine and metallic ions (Fe^{2+} , Cu^{2+} , Ni^{2+}) are useful for enhancing the photografting under air atmosphere.⁴⁹

Geuskens and Ruckert used a water soluble derivative of benzophenone has been used to initiate the grafting of acrylamide onto a copolymer of styrene-(ethylene-co-butene)-styrene (SEBS).⁵⁰ When benzophenone is used as photo-initiator some diffusion of the molecule into the superficial layer of the polymer is required in order to get efficient hydrogen abstraction from the surface. However an ionic photoinitiator such as ((4-benzoyl benzyl)trimethyl ammonium chloride) (BTC), does not diffuse into polymers from aqueous solutions. Only adsorption of the molecule at the surface is required to initiate surface grafting. The presence of some hydrogen donor molecules in solution is required to initiate homopolymerization and to make grafting by macroradical recombination. Grafting results from the recombination of SEBS radicals formed at the surface of the film with growing polyacrylamide chains initiated in solution, very close to the inhomogeneous absorption of light and the existence of a thin viscous layer of homopolymer produced during the induction period. Surface grafting of acrylamide by the same mechanism on to polymers is also possible. The most uniqueness of this method is that grafting has been performed using a water soluble initiator which does not diffuse into the polymer bulk.

1.2.3 Other methods (Plasma and Corona)

Plasma: Oxygen and oxygen containing plasma are most commonly employed to modify polyolefin surfaces,⁵¹⁻⁵⁴ which are useful for improving wettability and adhesion property. From XPS characterization of in-situ plasma treated polyethylene it was shown that oxygen and nitrogen plasma created new chemical species on surface whereas inert gas plasmas did not have any detectable chemical effect on surface. Yet, upon exposure to the atmosphere, the inert gas treated samples underwent oxidation. The nitrogen treated samples also got effected upon exposure to atmosphere (nitrogen was substituted by oxygen). This indicate

that when defining application one should consider the treatment as a whole, including the passage from vacuum to atmosphere. Polyolefins can also be modified by CO₂ plasma⁵⁵ resulting in simultaneous degradation and the formation of oxygen functional groups on the polymer surface. The oxidation leads a ketone, acid an ester group. The degradation and oxidation rates depend on plasma parameters (duration, discharge power, gas flow, pressure etc.). The rate of oxidation is also dependent on the nature of polymer structure. Clark and Dilks studied the oxidation of polyethylene and polypropylene by an oxygen plasma.⁵⁶ The degree of oxidation of polyethylene is less compared to polypropylene. This difference may be due to the different oxygen etch rates of the two polymers. Nitrogen containing plasmas are widely used to improve wettability, printability, bondability and biocompatibility of polyolefin surface. For example Foerch and coworkers studied the effect of remote nitrogen plasma (reactive species produced in a nitrogen plasma were reacted with polyethylene surface positioned downstream from the main plasma region) on polyethylene.⁵⁷ The gas flow rate, the dilution of reactant gas, exposure time and reactor base pressure were all found to have a large impact on the efficiency of nitrogen incorporation. Optimum conditions caused 18 atom% nitrogen to be incorporated within 20 seconds of exposure for polyethylene.

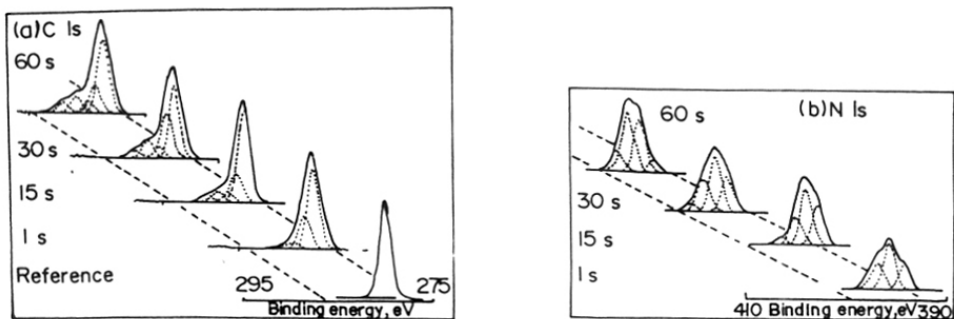

Figure 1.14: (a) C 1s and (b) N 1s spectra of polyethylene as a function of nitrogen-plasma treatment time

From the Figure 1.14, it can be observed that with time nature of functional group changes. Generally in N₂ plasma C-O, C-N, C=N, C=N groups are present on the surface, but the

determination of the exact nature of the functional group is not easy. Foerch and coworker have generated new products on polyethylene surface using a novel two step process.⁵⁷ The first stage involves exposure to a down stream nitrogen plasma and the second to either ozone or a corona treatment. It is observed that each step results in different reaction product. Mostly C-O functional groups are generated in first step whereas in the second step by corona discharge NO_2 group is generated. Ozone treatment of nitrogen plasma treated polyethylene surface increased carboxyl and carbonyl concentrations but did not produce any NO_2 group.





Foerch and coworkers performed a study of the effects of remote N_2 and O_2 plasma on polyethylene surface.⁵⁸ They observed that the rate at which surface modification by plasma treatment could be achieved allowed very high uptake of nitrogen or oxygen within extremely short periods of time (<1s). The uptake during corona discharge treatment for similar exposure times however was very low. In order to make comparisons more valid, long exposure time were required which lead to excessive damage on the surface. The nitrogen plasma treated surfaces appeared to retain their functionality better than the oxygen plasma treated samples. The depth of modification appeared to be similar for nitrogen and oxygen plasma treatment.

Surface fluorination of polyethylene and polypropylene can be done using CF_4 , CF_3H , CF_3Cl , and CF_3Br in a radio frequency glow discharge.^{59,60} Based on XPS and wettability measurement it was observed that all of these compounds provided a fluorocarbon layer on polyethylene but for polypropylene fluorination was not observed by using CF_3Cl and CF_3Br gas feeds. CF_3Cl and CF_3Br plasma cause chlorination and bromination of the polypropylene surface respectively. Fluorination of the surface occurs only to a minor extent. CF_3H undergoes polymerization in a plasma forming a deposited film which contains a variety of fluorinated functionalities. CF_4 is the only gas studied which fluorinates polypropylene surface directly without deposition of a thin plasma polymerization film.

Corona: It is known that corona treatment produces surface oxidation of polymers. It generates free radical hyperoxide on the surface. The decomposition of hyperoxide groups

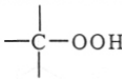
forms COH, C=O, and O=C-O groups on the corona treated polyethylene film. The presence of these groups was confirmed by XPS studies. XPS and gas-phase derivatization techniques were employed by Gerenser et al⁶¹ and Pochan et al⁶² to determine the nature and the concentration of various functional groups formed on the surface of corona treated polyethylene. Table 3 summarizes the results on corona treated polyethylene at two different energy level: 35000 and 4000 J m². In addition to COH, C=O, O=C-O and hyperoxide groups, the presence of peroxide groups was detected. The difference between the total oxygen tagged and the actual oxygen incorporated is attributed to the ether functional groups which have the highest concentration. The oxygen concentration increases with the increase in power level. Washing in water reduces the oxygen concentration at the surface suggesting that some of the oxidized fragments are loosely bound at the surface.

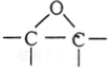
Table 3: Surface functionalities induced by corona treated at a polyethylene surface

| Functional group | 35000 J/m ² | | 4000 J/m ² | | |
|---|------------------------|--------------|-----------------------|--------------|--------------|
| | Initial | Water washed | Initial | Aged 16 days | Water washed |
|  | 1.2 | 0.9 | 1.1 | 1.1 | 1.3 |
|  | 1.7 | 1.1 | 0.9 | 1.8 | 1.2 |
|  | 1.8 | 0.9 | 1.1 | 1.0 | 0.8 |
|  | 2.3 | 1.1 | 1.1 | 1.0 | 0.8 |
|  | 1.6 | 0.8 | 1.6 | 0.8 | 0.8 |
| Total oxygen tagged | 13.8 | 7.7 | 9.2 | 6.4 | 6.6 |
| Actual oxygen incorporated | 18 | 10 | 12 | 10 | 10 |

1.3 SURFACE MODIFICATION OF OTHER POLYMERS

1.3.1 Poly(diene)s

Chemical modification using reactions that are well established in solution is also a versatile method for manipulating the structure of polymer at their surfaces. Application of this method to hydrocarbon polymers requires a careful choice of solvents and reagents that neither swell nor dissolve the polymer in order to promote selective functionalization at the surface. 1,2 polybutadiene surface has been modified using chemical and photochemical treatment (Scheme 1.4).

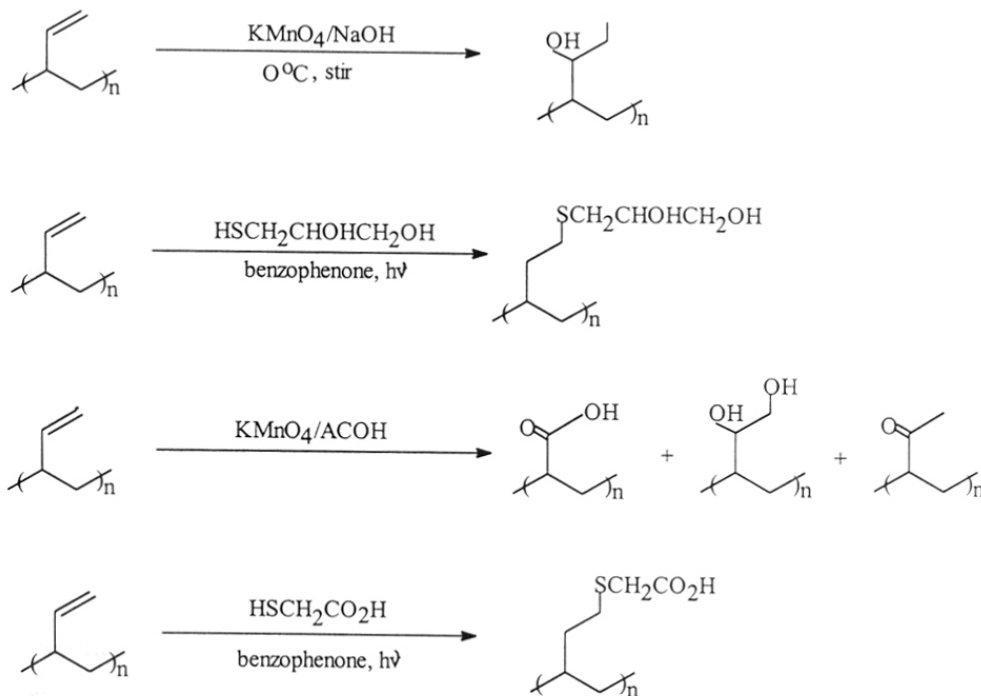

Scheme 1.3: Surface selective functionalization of poly(diene) using chemical reagents

The modified product can be useful for metal adhesion.^{63,64} Side chain double bond polymer is appropriate for modification in spite of main chain double bond polymer to avoid chain scission and etching of the polymer. It was observed that by using different reagent and reaction condition, surface functional group could be varied Scheme 1.4.

The primary disadvantage in using paramagnetic solutions is to modify the surface of PBD was the lack of selectivity inherent in these oxidations. In the synthesis of PBD-CHOHCH₂OH more highly oxidized by products were also produced. In the preparation of PBD-CO₂H with concentrated, acidic permanganate other oxidative products perhaps including 1,2-diols, ketone and aldehyde were also produced. A second complication in using permanganate to produce PBD-CO₂H was the addition of oxidized sulfur, present as sulfate or sulfonate that did not get rinsed away. This sulfur contamination probably resulted from several treatment of the surface with aqueous bisulfite that were necessary to remove any deposited oxidizes of manganese. The presence of these oxidized sulfur groups could affect the wettability of the surface and lowered the contact angle of water.

Alternatively, the photolytic addition of thiols or thiol acetic acid at the surface of PBD provided a synthetic route to a surface containing sulfide or thioacetate groups. This method gave good yields higher than those in the permanganate reactions of the desired products. The thioacetate groups at the surface of PBD-SCOCH₃, Sulfides to the polymer surface (PBD-SCH₂CO₂H, PBD-SCH₂CO₂CH₃) enhanced metal(copper)/polymer adhesion, relative to unmodified PBD/copper adhesion. Therefore, adhesion property can be improved by surface modification of 1,2-polybutadiene.

In spite of the good bulk mechanical properties of ethylene-propylene rubber the low surface water compatibility is the main difficult with this polymer to be used as a biomaterial. H. Mirzadeh et al⁶⁵ made graft polyacrylic acid onto the surface of ethylene-propylene rubber (EPR) by utilizing CO₂ pulsed laser as an excitation source. Peroxide formed on the surface by CO₂ pulsed laser treatment through peroxide mechanism has been found as a successful technique to initiate the graft copolymerization of hydrophilic acrylic acid onto the surface of this rubber. Grafting occurs successfully and is found to be dependent upon laser pulse number. Modified surface show significant improved water compatibility, the degree of which depends upon the surface morphology and the grafting level.

Noda prepared water wettable elastomeric films from a latex synthesized by polymerization of monomers in the presence of an amphiphilic block copolymer.⁶⁶ By migration of the

hydrophilic segments to the surface during film formation, the film is rendered essentially completely wettable by water. The latex was prepared by polymerizing a mixture of monomers (40 parts styrene to 60 parts butadiene) dispersed in water. An amphiphilic block copolymer consisting of a polyethylene oxide segment of relative molecular mass (M_r) 1365 attached to a short chain polybutadiene ($M_r=480$), was used as an emulsifying agent instead of a typical low molecular weight surfactant. Each latex particle is believed to be covered by a layer of the block copolymer and a substantial fraction of the reactive polybutadiene segment is probably grafted to the latex core during the emulsion polymerization. The latex exhibits an exceptionally high colloidal stability. Extensive dialysis of the latex even for days diminishes neither the colloidal stability nor the capability of latex to form a hydrophilic film. This film can be applicable for flexible coating that can introduce spatially selective wettability to solid surfaces, for example one side wettable perforated films used bandages and disposable diapers.

1.3.2 Poly(tetrafluoroethylene)

Surfaces of poly(tetrafluoroethylene) (PTFE) are very poorly suited for adhesion imparting properties due to its low surface energy (19 dyn/cm). PTFE is poorly wettable by liquids since strong attractive field of forces is very difficult to attain due to lack of sites able to create chemical bonding. Thus in order to adhesively bond fluoropolymer their surfaces must be modified. Considerable research has been directed towards increasing the surface energy of PTFE. Surface modification of PTFE can be achieved by many methods. Ion bombardment⁶⁷ produces topographical and chemical changes in PTFE surfaces. Plasma treatment have also been explored. Neither method introduces specific functional groups on the surface. The most successful method for modification of PTFE surface is by chemical reduction of C-F bond leading to a dark coloured porous surface.¹⁰ The most commonly used reducing agent is sodium, either in liquid ammonia or as a complex with naphthalene, solvated by an excess of glycol dialkylether. The reduction by using the latter solution is safer to handle and treatment is very easy. The fluoropolymer has to be put in the solution for a few minutes. The reaction involves the breaking of the carbon-fluorine bond, the production of sodium fluoride¹¹ and the decomposition of carbon radicals to yield unsaturated hydrocarbon chains.

Reduction of PTFE films can also be done by exposing the film to solutions of benzoin dianion generated from benzoin and excess potassium t-butoxide in DMSO at 50°C.⁶⁸ Shorter reaction times yield purple coloured films. However, as the reaction proceeds, films begin to appear lustrous gold. It should be noted that the gold color is obtained only after H₂O is added in the workup to rinse the films. The solution alone produces a deep black-purple film. Oxygen from the environment is introduced on the surface. Due to presence of a great number of conjugated double bonds, the sample assumes a dark color.

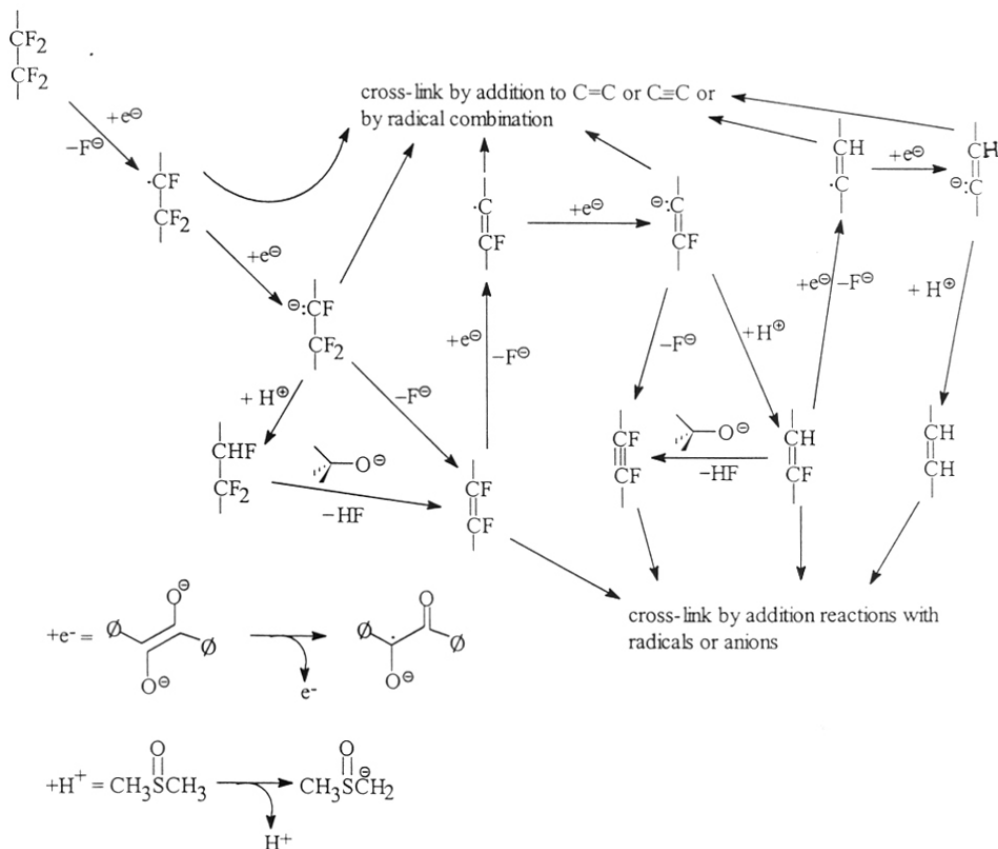

Scheme 1.5: The plausible reaction sequences for conversion of PTFE to unsaturated PTFE.

The XPS spectra of PTFE contains two major peaks: one from fluorine (F_{1s}; 696 eV) and one from carbon (C_{1s}; 293 eV). On reduction the majority of the surface is carbon with small amount of fluorine and oxygen. After reduction unsaturated PTFE film is useful for

exploiting further functionalization, such as hydroboration and subsequent oxidation, halogenation, radical addition, Friedel Crafts acylation etc (Scheme 1.6).

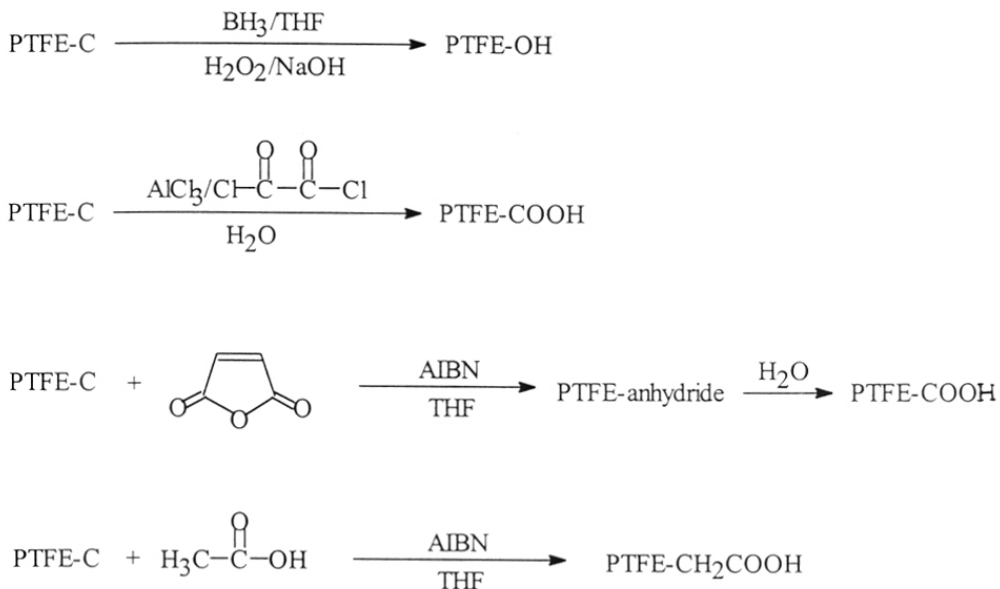

Scheme 1.6: Surface functionalization of unsaturated PTFE

1.3.3 Poly(styrene)

Ranby et al.¹⁴⁻¹⁶ modified polystyrene surface by photochemical grafting of acrylic acid, GA and GMA. Benzophenone and monomer in the vapor phase were irradiated by UV in the presence of polystyrene film. Modification took place on the outermost layer of the polystyrene film and were characterized by XPS and contact angle measurements. XPS measurements on samples irradiated for 5 min showed 90% poly(acrylic acid), 91% GA, and 57% GMA coverage of the PS surface. It was observed that the rate of grafting of these monomers onto polystyrene surface is higher compared to that on polyolefin surface. Polystyrene apart from being amorphous has a reactive benzylic hydrogen, thus improving the grafting efficiency.

Ikada et al.⁶⁹ performed UV light induced graft copolymerization of water-soluble monomers as acrylamide, acrylic acid, the sodium salt of 4-styrene sulfonic acid and N,N-

dimethylaminoethyl methacrylate onto a plasma pretreated film surface of polystyrene. As expected, the grafted surface showed more hydrophilic behavior than the untreated PS.

Chemical modification can also be performed on PS surface although with some difficulty due to its high solubility in many solvent.⁷⁰ Gibson and Banley performed sulfonation on PS surface using a sulfonating mixture and a quenching agent at room temperature. They analyzed surface concentration and depth of modification using several techniques, such as, ion exchange of the films with methylene blue, a cationic blue, cationic dye and subsequent visible light absorption measurement; direct titration of the sulfonic acid groups; direct reaction depth measurement by interferometry. The authors established that reaction occurs at greater than 2000 monolayers depth per side. This corresponds to the formation of a sulfonated layer of 3.5 μm thickness per side.

Oxygen plasma is most commonly used to modify polystyrene surfaces. Using plasma treatment a variety of functional groups such as C-O, C=O, O-C=O, C-O-O and CO₂ can be generated on the surface. Clark and Dilks⁵⁶ studied the oxidation of polystyrene and PE by an oxygen plasma. They observed that the rate of the formation of various functional groups such as C-O, C=O, O-C=O and CO₂ increases with exposure time. It was observed that the rate of oxidation of PS higher than PE. However, the oxygen etch rate is higher for PE. This is explained on the premise that in case of polyethylene large amounts of volatile products are formed during plasma treatment leaving oxidized products on the surface which is less in case of PE but more in PS.

Nitrogen-containing plasma are widely used to modify PS surface to improve the PS surface wettability, printability, bondability and biocompatibility. To improve cell affinity ammonia-plasma treatment is used to generate amino group onto PS surface.⁷¹ Ammonia and nitrogen plasmas have been used to provide surface amino binding sites for immobilization of heparin on polystyrene surfaces.⁷²

Benninghoven et al⁷³ and Nakayama et al⁷² showed that primary amino groups could be detected at the polystyrene surface after the treatment with an NH₃ plasma but not with an N₂ plasma with the help of an XPS derivatization technique. Foerch et al⁷⁴ generated a new

functional group on polystyrene surface using a novel two step process, N_2 and corona treatment. It is observed that each of the two-step reactions yields very different reaction products with an apparent increase in the formation of C-O functional group in the former case and the formation of surface NO_2 group in the latter case.

1.3.4 Other polymers

Surface modification of several other polymers such as PET, PC, PMMA, Polyimides, aromatic polyimides and polyphosphazenes have been studied. PET surfaces can be modified via chemical, photochemical and plasma techniques. Hydrolysis of PET by hot sodium hydroxide is one of the popular method (Scheme 1.7)

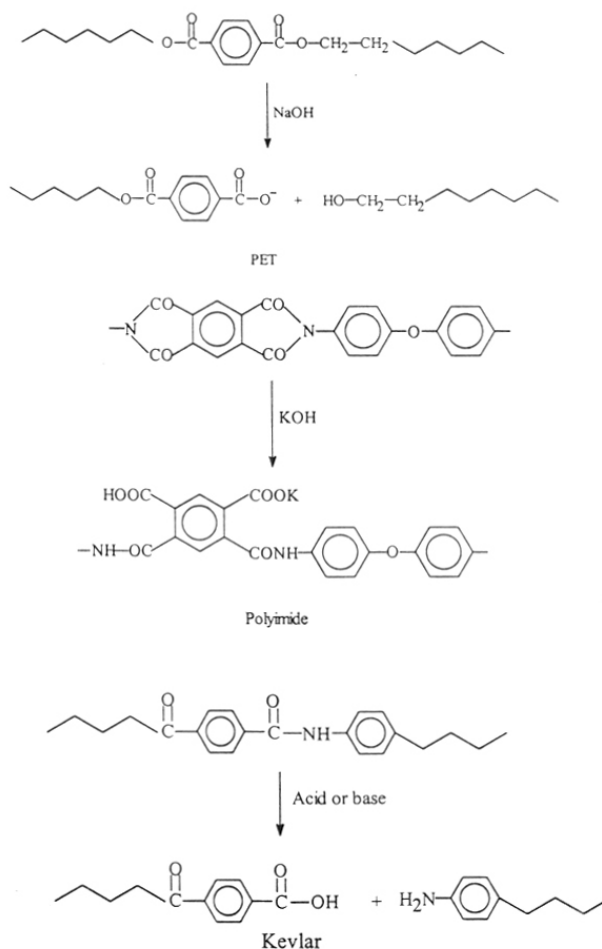

Scheme 1.7: Hydrolysis of PET, Polyimide and Kevlar surfaces

The number of hydrophilic groups on the surface can be increased by hydrolysis. However, the method leads to significant weight loss and extensive pitting and roughening of the treated sample. Based on weight loss, the following order of reactivity of several bases was found¹² : hydroxide < tert-butoxide < sec-propoxide < methoxide < ethoxide.

Surface of PET film can be modified photochemically in vapor and in liquid phase. Ogiwara et al^{75,76} immersed a PET film in acetone solution containing the photosensitizer (benzophenone, anthraquinone, benzoylperoxide) and a film forming agent (poly(vinylacetate), 1wt%). The sensitized substrate was irradiated either in solution of the monomer or in the presence of vapor monomer. Ranby et al¹⁹⁻²¹ performed vapor phase photografting of different acrylic monomer on PET film irradiating the substrates in a thermostat chamber equipped with a quartz window, where sensitizer and monomer evaporate from a solution of a volatile solvent in an open bucket which is shielded from UV by an aluminium foil.¹⁹⁻²¹ Kubota et al¹⁷ have performed graft polymerization of anionic and cationic monomers onto the surface of PET film with a simultaneous UV irradiation method but using no photosensitizer. To effect graft polymerization the PET film was immersed in an aqueous solution containing a monomer and periodate (NaIO_4) of appropriate concentration followed by UV irradiation without degassing. The monomers used were 2-acrylamide-2-methylpropane sulfonic acid and acrylic acid as anionic and N,N-dimethyl aminopropyl acrylamide and dimethyl aminopropyl acrylamide and dimethyl aminoethyl methacrylate as cationic monomer. The use of NaIO_4 during polymerization was to reduce the concentration of dissolved oxygen in solution by the photochemical reaction of NaIO_4 reaction with oxygen. UV light induced graft copolymerization of water-soluble monomers such as acrylamide, acrylic acid, sodium salt of 4-styrene sulfonic acid and N,N-dimethyl amino ethyl methacrylate onto Ar plasma pretreated film surface of PET has also been recently reported.⁶⁹

Polyimides are another class of polymer whose surface properties can be changed by hydrolysis (Scheme 1.7). The adhesion between two polymers can be improved by pretreatment with KOH or NaOH.¹³ Oxygen plasma treatment is another useful technique used for improving the polyimide surface. It is observed that the treated surface increases its wettability but does not lead to improve bond strength between the polymer and the metal-

polymer. Kreuz⁷⁷ and Matieuzo and Egitto⁷¹ observed that in the case of caustic which rinsed the surface after caustic treatment followed by drying sometimes changed the wettability of the treated film and sometime it did not. In case of plasma treated also water rinsing of plasma treated surfaces changed the surface wettability. The simplest explanation for both observations is that the treatments left behind low molecular weight fragments which could be removed by washing and which would serve as weak interface if a adhesion/coating was applied to the treated film.

Poly(aramid) have been surface hydrolysed either by acid or by bases^{77,71} (Scheme 1.7). The objective was to create reactive amino groups on Kevlar fibre surface, for subsequent chemical attachment of a bifunctional epoxide, which could improve the strength of the Kevlar fibre-epoxy matrix interface in composites. However, the reaction is not surface specific and if hydrolysis is allowed to proceed for too long mechanical damage outweighs advantages gained by improved adhesion.

Gerenser⁷⁸ have studied the plasma modification of several polymer surfaces, including polystyrene, poly(ethylene terephthalate), bis-phenol-A-polycarbonate (BPAPC) and poly(methyl methacrylate). The gases employed include argon, oxygen, nitrogen and argon/oxygen mixture. All plasma treatments were done in situ in the spectrometer preparation chamber. Based on XPS it was observed that argon plasma treatment does not introduce new chemical species into the PS surface, whereas oxygen and nitrogen plasma treatments incorporate only oxygen and nitrogen respectively into the PS surface. No other species were detected on the modified PS surfaces. Although argon plasma treatment does not incorporate new chemical spaces into polymer PS, selecting bond breakage and desorption of various short chain species can occur. Typically, for oxygen containing polymers, the oxygen /carbon ratio decreases during argon plasma treatment, probably due to the loss of CO or CO₂. The data for PMMA and PET are nearly identical, however the data for BPAPC suggest a much more rapid loss of oxygen at short treatment times. The initial rapid loss of oxygen for BPAPC is probably due to the labile nature of the carbonate group. The BPAPC was also found to be extremely susceptible to damage via radiative energy transfer. The process appears to be similar to that observed in a photo-Fries pathway.

The surface of the poly(methyl methacrylate) PMMA cladding of an optical fiber was chemically modified to introduce amino groups.⁷⁹ A pH sensitive dye with isothiocyanate functionality was bound on the optical fiber utilizing the amino groups located at the surface of the fiber. Reactions between isothiocyanates and primary amines are relatively fast and are usually completed in a relatively short time even under heterogeneous conditions. This modification was carried on in solution or in a heterogeneous phase, i.e. on the surface of PMMA cladding of the optical fiber. N-lithio ethylene diamine is formed in situ by the reaction of n-butyl lithium with excess ethylene diamine as the aminolyzing agent. The reaction occurs at room temperature and excellent conversion efficiency was obtained.

Allcock et al⁸⁰ developed a method the controlled formation of carboxylic acid units at the surface of acryloxyphosphazene high polymers. The first step involves a permanganate induced oxidation of p-methylphenoxy side groups with the surface density of carboxylic acid units being controlled by the ratio of p-methylphenoxy groups along the polymer chains. A second approach involves a base-induced hydrolysis of carboxylate ester functions at the para positions of surface aryloxy side groups (Scheme 1.8). The same ester functions were converted to alcohol moieties by surface reductions using lithium aluminium hydride in diethyl ether. The surface structures before and after these reactions were studied by a combination of contact angle measurements, X-ray photoelectron spectroscopy, scanning electron microscopy and ATR-IR spectroscopy.

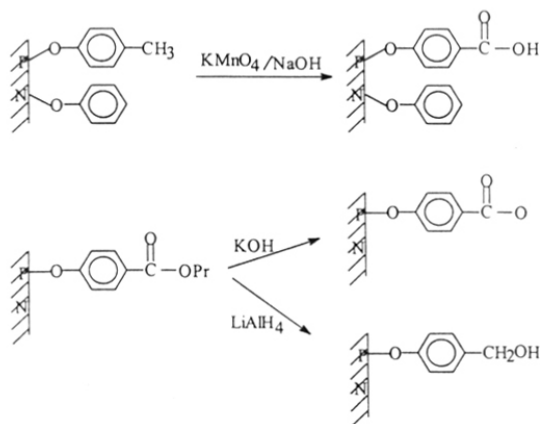

Scheme 1.8: Controlled formation of carboxylic acid groups at polyphosphazene surfaces

Pemberton and Jaeger⁸¹ studied surface modification of poly(vinyl alcohol) by peroxide initiated grafting of a poly(organophosphazene). A poly(organophosphazene) bearing allylic functions was grafted onto the surface of a poly(vinyl alcohol) film using benzoyl peroxide as an initiator (Scheme 1.5). The poly(vinyl alcohol) films were first coated with toluene solutions of poly(organophosphazene) and peroxide and then heated. After grafting it was extracted with toluene to remove ungrafted poly(organophosphazene). The presence of the covalently bonded and cross linked poly(organophosphazene) on the poly(vinyl alcohol) surface gives the surface a hydrophobic character.

In recent years greater emphasis has been placed on understanding the chemical and morphological changes effected by surface treatments and then correlating chemistry and morphology with adhesion. The picture that emerges is that surface energy alone is usually insufficient to predict adhesion to polyimides. Instead, factors such as, initial bond strength, bond durability, use of adhesives or metals directly deposited on the film, depend on chemical bonding, diffusion between deposited layers and the polyimide, formation of topography and the viscoelastic properties of the polymer below the surface. Poor viscoelastic behavior frequently is characterized as a weak boundary layer. Recent work has shown that small amount of organometallics that diffuse to the surface during the film forming process can significantly affect bondability both to adhesives and to vacuum deposited metals.⁸²

Biomedical polymers are widely used in a physiological environment such as the human body.⁸³ The minimum requirements for the biomedical polymers include non-toxicity, biocompatibility and bio-functionality. The toxicity of the biomedical polymers is mostly caused by concomitants in the polymers such as catalysts, monomers, oligomers and solvents which may provoke the severe or chronic inflammatory response of the living system. The surface modification of biomedical polymers is not for the non-toxicity but for the biocompatibility and biofunctionality of the polymers. Several techniques of surface modification have been applied for industrial polymers but most of them are ineffective in the surface modification of biomedical polymers with respect to the biocompatibility and biofunctionality. Most of the surface modifications performed on biomedical polymers have been devoted to improve the blood compatibility but very few surface modified devices are

currently in clinical use because of the high cost or low efficiency. As an example clinical applications of the surface modification in which a coupling reaction of poly(ethylene glycol) derivative is carried for hemodialysis to improve the blood compatibility.⁷⁹ The grafting markedly reduces the transient leucopenia of patients. Graft polymerization of water soluble monomers is also effective in lowering the interaction of artificial surfaces with blood components if an appropriate polymerization condition is employed. It is known that biofilms are formed on the surface of implants and biomaterials inserted in the body for long term catheterization. Therefore many attempts have been made to produce anti-bacterial surfaces. As an example polyurethane surface was modified by graft polymerization of acrylic acid and after dye treatment it is useful for bacterial adhesion.

1.4 SURFACE GRAFTING ON POLYMERS

Polymers have frequently been modified by graft polymerization to change their physical and chemical properties for such applications as biomaterials, membranes, and adhesives. Various commonly used grafting methods are illustrated in Figure 1.15.

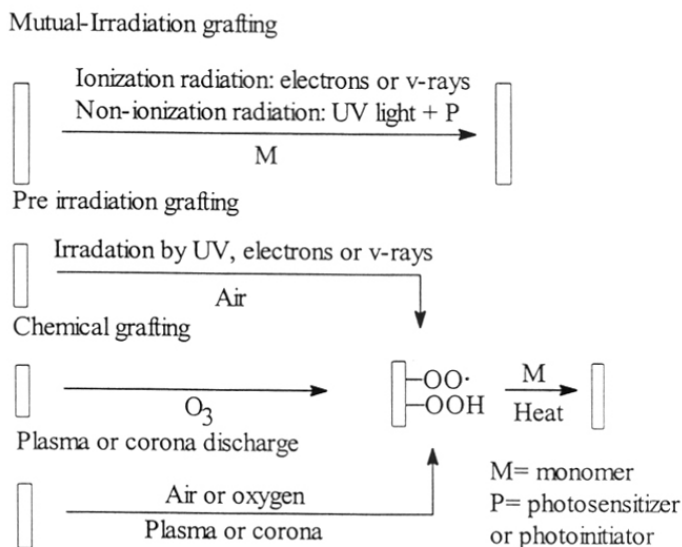

Figure 1.15: Various surface grafting methods

The key advantage of these techniques is that the surface of the same polymer can be modified to have very distinctive properties through the choice of different monomers. The

chemical modification of the surface was obtained by modifying existing chains. In surface grafting this is achieved by the covalent bonding of new macromolecules on the outermost layer of the substrate. The fundamental step in grafting is the creation of reactive groups on the substrate surface. This can be done either chemically or by irradiation (ionizing radiation, UV light and glow discharge). Once reactive sites are created, in principle they can couple to a preformed macromolecular chain. Even if this graft coupling technique is sometimes followed, it is rather more common to contact the activated surface with a suitable monomer, so that a growing chain starts from the activated site. Thus the process of grafting macromolecular chains to a substrate generally involves both chemical linking to the substrate and polymerization of the chains. Ideally a grafted surface should look like the one depicted in Figures 1.16(a-d).

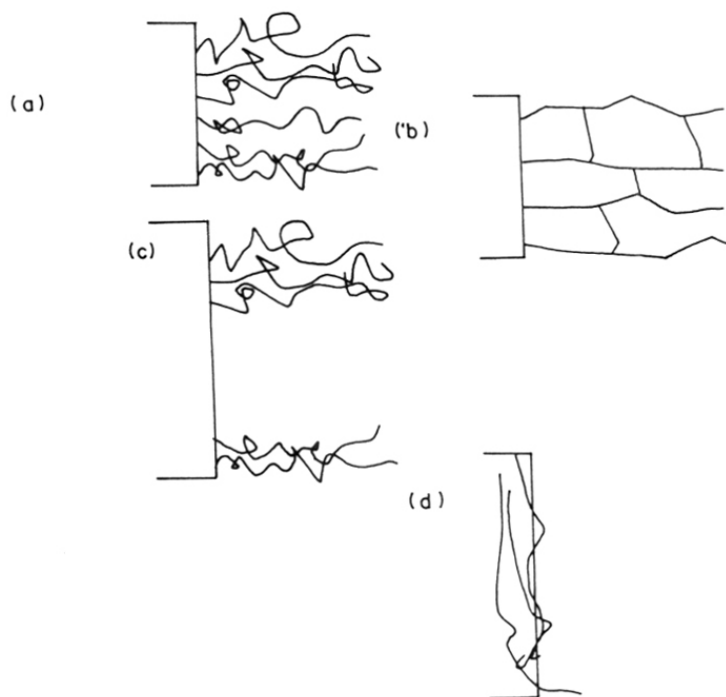

Figure 1.16 (a-d): Possible structure of grafted surfaces: (a) homogeneous coverage of mobile chains, (b) mobile is constrained by cross-linking among grafted chains, (c) non homogeneous coverage, the substrate surface is still exposed, (d) the surface layer contains macromolecular chains both grafted and belonging to the substrate

Figure 1.16a illustrates the case a homogeneous coverage of the substrate is obtained. Surface properties are controlled by the grafted chains. In solvents these chains expand or contract as the solvent is changed. In real situations, however, other surface structures are also possible; Figure 1.16b depicts cross linking between growing chains which impair chain mobility.⁸⁴ In Figure 1.16c an uneven distribution of active sites on the substrate surface leads to a heterogeneous grafted surface, whose properties are in part those of the substrate. In Figure 1.16d the surface is composed of both grafted and substrate chains, possibly, a consequence of a swelling of the substrate by the monomer.

If the polymer surface bears suitable functional groups, it is possible to perform a graft coupling of a preformed chain or exploit the functional groups as sites whence polymerization of a monomer can start. This step requires an initiation reaction. If as in the great majority of cases no chemically reactive functional groups are present on the substrate surface, the only choice is to create them: possible options are chemical treatment followed by initiation reaction or irradiation which can generate radicals as surface sites for graft polymerization. Irradiation can be performed in the presence of monomer or before exposure to the monomer. The involvement of radicals means that the irradiation atmosphere must be taken into account; if it is performed in air or if the sample is exposed to air after irradiation oxygen will scavenge radicals. It is often possible to exploit peroxides produced by the reaction between oxygen and radicals as grafting polymerization initiators by thermally or chemically inducing their decomposition.

1.4.1 Chemical methods

The majority of grafting process involves a radical mechanism of polymerization of vinyl monomers. The aim of the surface activation step is to create sites that can yield radicals in the successive initiation reaction. Graft polymerization on polymers bearing surface functional groups can be induced by a great number of chemical treatments and is the most direct and favorable case. The requirement of suitable functional groups however limits this technique mostly to natural polymers and in only a few cases to synthetic macromolecules. A great deal of work has been done on chemical grafting both bulk and surface on wool where one can take advantage of the reactivity of functional groups of wool proteins. It has been found that active sites are created by homolytic cleavage of -SS-linkages of cystine.⁸⁵

The other class of natural polymers such as cellulose, starch and lignin, bears functional groups which can initiate grafting using redox systems.^{86,87} Even if in all these papers the emphasis is more on bulk rather than on surface-related aspects, they can be used as a useful guideline for more surface specific studies.

For synthetic polymers the opportunities for chemically promoted initiation reaction are limited to a few substrates. Hydroxyl containing polymers such as poly(vinyl alcohol)(PVA) and poly(2-hydroxyethylmethacrylate)(PHEMA) can be used to initiate graft polymer.

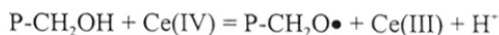

where P stands for the polymer substrate. A different approach is to use the substrate hydroxyl groups to link the polymerization initiators. Ikada and coworkers coupled 4,4'-azobis-4-cyanovaloyl chloride (AIVC) which is capable of initiating radical polymerization with surface hydroxyl groups of PVA and ethylene-vinyl alcohol copolymer(EVA)⁸⁸ (Scheme 1.9).

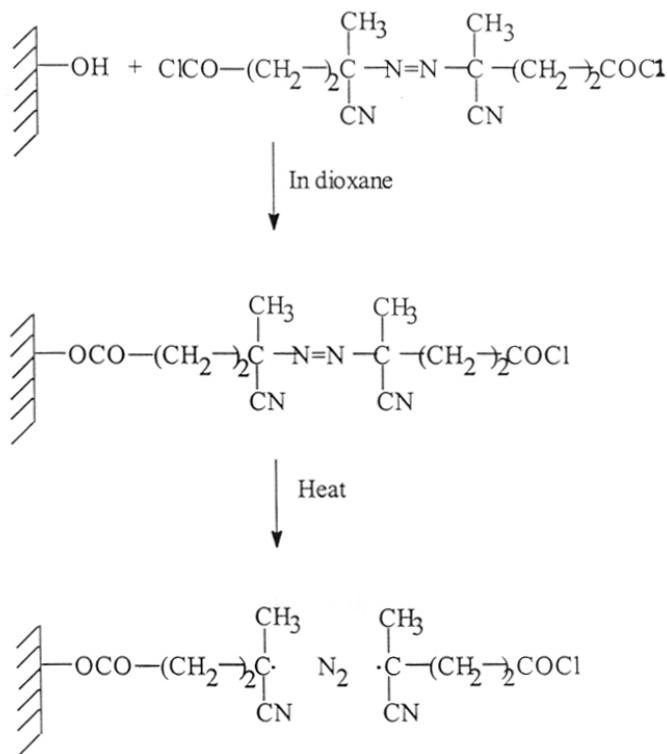

Scheme 1.9: Surface grafting by 4,4'-azobis-4-cyanovaloyl chloride.

Upon heating at 50°C, AIVC decomposes producing radicals which initiate the polymerization of acrylic monomers.

The functionalization of polypropylene⁸⁹(oxidation by a solution of chromium(VI) oxide, acetic acid and acetic anhydride, followed by reduction with borane) yields a highly hydroxylated surface, which can be treated with Ce(IV) to initiate radical polymerization.

1.4.2 Photochemical methods

Another way of producing grafting on polymer surfaces involves electromagnetic radiation i.e UV light. The most commonly employed wavelengths range from 250 to 360 nm, which means that their energy is not enough for homolytically cleave the strong C-C or C-H bonds of polymers. Using the shorter wavelength some low strength bonds may be cleaved but the low yield of this reaction makes this approach unsuitable for practical with most common polymers (although it must be noted that prolonged exposure to the source of irradiation, which means a very high radiation dose, can lead to major effects, as demonstrated by the photodegradation of polymers exposed to sunlight). A way to overcome the problem and practically exploit UV irradiation for grafting, is to add a photo-sensitive molecule to the polymers. One type of photo sensitive molecule is the so called photoinitiators, which are molecules designed to homolytically cleave and initiate radical polymerization when irradiated by light of a given wave length. Photoinitiators are widely used in UV curing of coatings or UV initiated polymerization. As to grafting, they can be used with substrates containing unsaturated groups available for copolymerization. Grafting on saturated polymers requires the creation of radical sites on the substrate surface and this can be done with the class of photosensitive molecules called photo sensitizers. The radiation promotes the sensitizers to an excited state, which can abstract a hydrogen atom from the polymer and produce a macroradical on the substrate. This radical site on the substrate that works as the initiator of polymerization. The mechanism of action of the most commonly used photosensitizer, that is, benzophenone(BP) is shown displayed in Scheme 1.10.

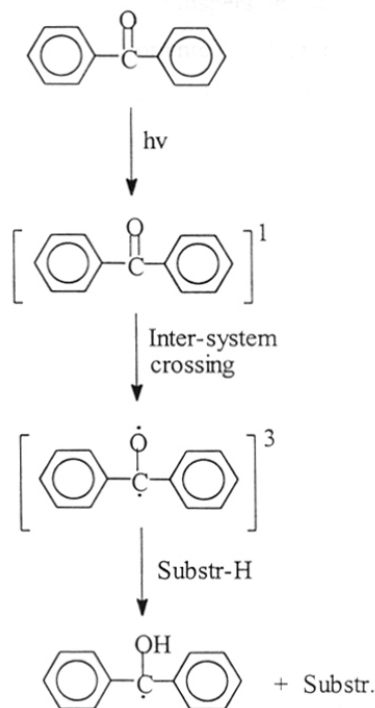

Scheme 1.10: The effect of UV light on benzophenone. The excited triplet state can extract a hydrogen from the substrate (Substr-H), creating in this way a macroradical where grafting occurs

UV light of wavelength between 300 and 400nm is adsorbed and excites BP to a singlet state which by intersystem crossing (ISC) reverts to a reactive triplet state which can abstract a hydrogen atom from the polymer substrate and create a macroradical. If vinyl monomers are present the macroradical can become the anchoring site of a growing grafted chain.

Photoinitiators and photosensitizers can be added to the substrate in several different ways. In the pioneering work of Oster and coworkers,⁹⁰ BP was blended with unvulcanized natural rubber by casting a film from a cyclohexane solution of rubber and BP. Polyethylene films were sensitized by introducing BP prior to extrusion by soaking for a few minutes in a solution of BP or by placing the films in the presence of BP for two days in desiccator.

Photografting of methyl acrylate can be performed on textile fabrics in the presence of biacetyl vapors or after treatment with aqueous dispersions of photosensitive metal oxides.⁹¹ Acrylamide(AAm) was photografted on oriented polypropylene films by Tazuke and Kimura by irradiation of an AAm-acetone solution containing BP or other sensitizer(methyl-2-benzoylbenzoate, 9-fluorenone 4-bromobenzophenone), a technique used also for the surface modification of poly(ethyleneterephthalate)(PET).⁹² Another approach involves the coating of the substrate by a sensitizer-containing film in an acetone containing the photosensitizer and a film forming agent (polyvinylacetate, typical concentration 1wt%). The sensitized substrate was later irradiated either in a solution of the monomer or in the presence of vapor monomers.^{74,76} The substrate can also be sensitized by pre-swelling in a suitable solution which allows the diffusion of the photosensitizer in the substrate surface region. After this step the sensitized substrate can be irradiated either in solution or in an atmosphere of acrylic monomers. Ranby and coworkers performed vapor phase photografting on polyolefins, polystyrene and PET, irradiating the substrates in a thermostat chamber equipped with a quartz window where sensitizer and monomer evaporate from a solution of a volatile solvent in an open bucket which is shielded from UV by an aluminum foil.^{14,15} They also developed a continuous process where the substrate is sensitized by pre-soaking in a sensitizer solution before reaching the reaction chamber.¹⁹⁻²¹

The advantage of photografting is that modification produced by this technique is virtually restricted to the surface regions. Photografting has been extensively used to improve such properties of polymer surfaces as adhesion, printability, antistatic, wearability, biocompatibility and dyeability. For example in biomedical applications various polymer surfaces have been grafted with different monomers to improve biointeraction for applications entailing cell adhesion, biocompatibility and immobilization of enzymes and bioactive materials. The conversion of hydrophobic to hydrophilic surface ones provides functional sites capable of binding chemically to enzymes or bioactive compounds. Garnett et.al used photografting to immobilize a typical enzyme, trypsin to the backbones of several polymers. Ranby et al grafted polyethylene films with glycidyl methacrylate by liquid-phase mutual irradiation with UV light. The grafted surface provides sites for the attachment of polyethylene glycol, forming a hydrogel surface which inhibits protein adsorption and after attachment of heparin onto the grafted surface it prevents blood clotting.

Photografting has been used to modify electrostatic properties of polymers. A very effective way to prevent oxidation and degradation of polymer films is to graft UV stabilizers onto a polymer surface. Oxidation and degradation start from the surface and progress slowly into the bulk of the polymer and grafted stabilizers are not susceptible to loss due to migration or evaporation. For example polypropylene, polystyrene, and polyethylene films were grafted with GMA and GA by mutual irradiation with UV.^{93,94} The stabilizers-2,4-dihydroxybenzophenone(DHBP), phenyl 4-aminosalicylate(PAS) and 4-amino-2,2,6,6-tetramethylpiperidine(AP) were attached to the grafted surface through chemical transformation reaction. Improved metal-polymer adhesion has been demonstrated by photografting of monomers containing chemical functional groups that can interact with the metal.⁹⁵ Poly(ethylene terephthalate) was photografted with monomers including acrylic acid, allyl urea, allyl thiourea, acrylamide etc which improved copper adhesion whereas copper delaminated from the virgin PET surface during electroplating.

1.5 METHODS OF CHARACTERIZATION OF POLYMER SURFACES

1.5.1 Attenuated Total Reflection Infrared Spectroscopy (ATR-IR)

Transmission infrared spectroscopy provides a method for rapid identification and quantitation of functional groups. Internal reflection spectroscopy extends this technique to polymer surface between the sample surface and a high refractive index optical element yielding spectra very similar to absorption spectra. In the experiment the IR beam establishes a standing wave in the crystal whose intensity falls off exponentially in the polymer. The depth of penetration(d_p) is the distance required for the electric field amplitude to fall to e^{-1} of its value at the surface of the sample.

$$d_p = \frac{\lambda_o}{2\pi n (\sin^2\theta - n_{21}^2)^{1/2}}$$

where θ = angle of incidence between the radiation beam and the normal to the surface.

λ = wave length of the radiation.

$n_{21} = n_2/n_1$ = refractive index of the sample/refractive index of the optical element

From the equation it is obvious that the depth of penetration is linearly dependent on the wavelength of radiation; unlike the absorption spectrum, bands become more intense at increasing wavelength since it is representative of a layer sampling depth. Also d_p decreases as the angle of incidence of the radiation increases or if the refractive index of the crystal

increases or the refractive index of the sample falls. The disadvantage of ATR-IR as a surface analytical tool lie in the large sampling depth for analysis. Also it is not very amenable to quantitative analysis since intensities of absorption are not reproducible from sample to sample due to variation in clamping pressure against the crystal. Methods have been developed for quantitative analysis⁹⁶ using band ratioing as an internal standard. It should also be noted that for optimal spectral contrast the refractive indices of the sample and the crystal should be as nearly equal as possible.

ATR-IR has found a large number of applications in diverse fields of surface analysis of polymers blends,⁹⁷⁻⁹⁹ block copolymers¹⁰⁰ and grafting.¹⁰¹ Depth profile between 1 and 10 μ m can be obtained but results are not related to the surface in the strictest sense. ATR-IR is less surface specific than XPS and it is less sensitive to surface contamination. In most cases a combination of techniques has been used such as XPS and ATR-IR. Depth profiles of incompatible blends for biomedical applications have been obtained by changing the angle of incidence.¹⁰² For incompatible blend of polyurethane and polydimethylsiloxane, it has been observed that increasing the incident angle the intensity of bands attributed to PDMS increases suggesting its segregation at the surface.¹⁰² In quantitative studies of poly(ethylene oxide)/poly(propylene oxide) blend surfaces, computer techniques have been used to fit experimental spectra with composite spectra obtained adding in different proportions of spectra of pure polymers. In blends of an acrylate copolymer as with a fluoro copolymer the surface segregation of the acrylic moiety was observed¹⁰³ hot with standing its surface tension is higher than that of the fluoro copolymer. This result attributed to the immiscibility between the two polymer and the large difference between their surface tensions.

Surface treatments of polymers such as photooxidation¹⁰⁴, chemical oxidation¹⁰⁵ and fluorination have been studied. Through peroxide intermediates OH, C-O-C, -C=O and -COOR groups are formed during the photo oxidation of PP.¹⁰⁴ Chemical oxidation¹⁰⁵ produces the same oxygen containing functions. The effect of treating PE with sulfuric acid fumes in order to obtain a biomedical material with special anticoagulant properties has been reported. Plasma and corona treatments have also been studied extensively.

1.5.2 Contact angle measurement

Contact angle measurement is probably the most common method of solid surface tension measurement. Contact angle data, especially, in the case of polymeric materials can be obtained with low price instruments and with simple techniques. However, the interpretation of data is not always straightforward and the correct use of data requires knowledge of the thermodynamic status of the observed angle.¹⁰⁶ At the basis of the measurement of solid surface tension by contact angle there is the equilibrium at the three phase boundary, (Figure 1.17). The drop of liquid that is put on a solid surface will modify its shape under the pressure of the different surface/interfacial tensions, until reaching equilibrium. In 1805 Thomas Young described the three phase equilibrium

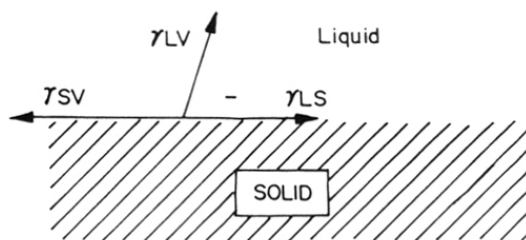

Figure 1.17: The Young equation

in terms of the vectorial sum shown in Figure 1.17. resulting in the following equation of interfacial equilibrium

$$\gamma_{sv} - \gamma_{sl} = \gamma_{lv} \cos\theta$$

where γ_{ij} is the interfacial tension between phases I and j, subscripts s,l,v refer to solid, liquid and vapor respectively and θ is the equilibrium (young) contact angle.

Wetting of solid surfaces by liquids especially by water, plays an important role in various practical applications. One would sometimes like to reduce the wettability of solid surfaces such that they would repel liquids upon contact. On other occasions, however, would enhance wettability to promote the spreading of liquids over a solid surface. Furthermore there are many applications where the simultaneous control of both wetting and nonwetting solid surfaces is required to accomplish a desired result. In printing for example the surface of a solid substrate must be maintained reasonably wettable so that ink can be transferred onto the surface. However the surface should not be overly wettable by the ink otherwise

unwanted smearing of printed image could result. In order to control such selective or spatially resolved wetting phenomena, quantitative knowledge of the surface wettability becomes extremely important.

The surface of polymers generally have low surface energies which mean that they will have high water contact angle. When a reaction is carried out on these polymers the modified polymer does not usually have the same surface energy as the original polymer and these difference are observed as changes in the contact angles.

Various surface modification techniques to increase the surface energy of solids are now available to make solid surfaces wettable with water. For example corona discharge and cold plasma treatments as well as wet chemical methods are used to incorporate chemical groups capable of interacting with liquids thereby enhancing are particularly effective in the enhancement of wetting to control adhesion to plastic surfaces. Conventional surface modification methods are still somewhat limited. The achieved increase in the wettability of a solid surface is in general transient in nature. The wettability gradually diminishes with time especially in dry air.^{107,108} This decrease in wettability is attributed to the thermodynamic driving force which causes minimization the surface free energy. It is believed that the chemical functional groups responsible for the enhanced wettability tend to migrate away from the surface exposed to dry air to the interior of the polymeric material.

When polyethylene is exposed to chromic acid the surface is oxidized. The presence of polar functionality is indicated by the decrease in the water contact angle. Contact angle thus provide a rapid qualitative indication that a reaction has occurred. Information about functional groups and their homogeneity is obtained both from the scatter in the contact angles which is measured in a variety of positions on the same sample and from the contact angle hysteresis. The scatter in the contact angle is quite easily obtained. The scatter is large if the surface contains unreacted material. Once the surface becomes homogeneous with respect to contact angle measurements the amount of scatter is reduced to 1-2°, the usual scatter for homogeneous polymer surfaces. The contact angle hysteresis also provides information about functional group heterogeneity.

Contact angle measurements are very useful when used in conjunction with other analytical techniques. When reaction kinetics at polymer surfaces are followed using several analytical methods including contact angle, information about the nature of chemical reactions is some time obtained. Water contact angles are sensitive to the outer few angstrom layers of the surface. Generally, for a reaction occurring selectively on a surface the value of the contact angle will attain a plateau early in the reaction. If, however, the reaction occurs to a greater depth, then the contact angle will continue to change even after the reaction has progressed far into the bulk of the polymer. This method is, however, not useful if the modified polymer is susceptible to secondary reactions as this would also cause changes in the observed contact angles. An example of this is the reduction of C-F bond in Teflon to form surface unsaturation.¹⁰⁹ Such surface unsaturation is prone to oxidation and it is, therefore, not possible to determine whether the observed contact angle changes are the result of the reduction or due to the subsequent oxidation of the reduced material.

Contact angle measurement have been recently demonstrated to be sensitive to the pH of the probe fluid when the surface contains ionizable functionalities.¹¹⁰ This study used oxidized polyethylene as a substrate containing surface carboxylic acid groups. When the contact angle was measured with acidic water, no dependence on pH was observed. However, as the pH was increased beyond 7.0, the contact angle decreased and the contact angle/pH plots resembled a titration curve. It thus appears that this method can be used to detect the presence or absence of easily ionizable functional groups on the surface.

1.5.3 X-ray photoelectron spectroscopy (XPS)

X-ray photoelectron spectroscopy(XPS) became one of the most widely employed spectroscopic technique available for surface analysis of polymers. The spectrum is obtained by irradiating the sample with a monochromatic (or quasi monochromatic) X-ray source. Photons can collide with electrons giving them their energy. Emitted electrons acquire a kinetic energy which is equal to the difference between the energy of the incident photon and the binding energy of the electron to the nucleus. In this experiment a sample is irradiated with monochromatic X-rays($MgK\alpha$) in an ultra- high vacuum chamber. The photons are observed and electron emitted with kinetic energy given by $KE = h\nu - BE - \theta_s$,

where $h\nu$ is the energy of the photon, BE is the binding energy of the atomic orbital from which the electron originates and θ_s is the spectrometer work function. The electrons leaving the sample are detected by an analyser according to their kinetic energy. The XPS spectrum is a plot of the number of electrons emitted versus their respective binding energy.

The XPS instrumentation consists of a UHV chamber (usually at a background vacuum of 10^{-7} - 10^{-8} pa) containing the sample holder, an X-ray gun and an electron analyser. The most popular X-ray guns use the K_{α} lines of Mg (1253.6 eV) which ensure both good resolution and sensitivity. In modern spectrometers emitted electrons are detected by a cylindrical mirror (CMA) or hemispherical analyser. A sketch of instrumental arrangement is shown in Figure 1.18.

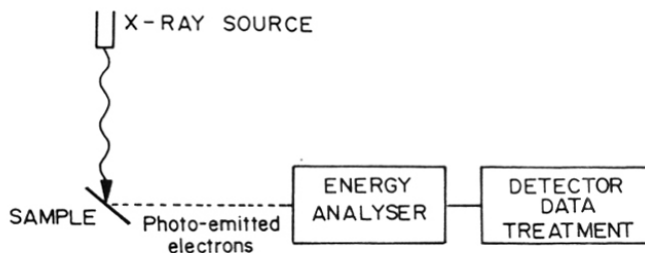

Figure 1.18: Experimental set-up of XPS

Using XPS, all elements, except H and He are observable. From photon emission spectra quantitative information can be obtained. Core electrons with high binding energies contribute to the most important spectral features. These electrons are less sensitive to the chemical state than valence electrons. Nevertheless, they offer information, even if they are approximate and sometimes ambiguous regarding the chemical state of detected elements.

The XPS spectrum of a clean hydrocarbon polymer is rather simple since only the C_{1s} peak is present (Figure 1.19). Contaminants and/or surface oxidation are often observed (Figure 1.20), but unlike in SIMS surface cleanliness is not a life or depth problem. Thus, most of the information about polymer surfaces has been drawn from C_{1s} peaks since they are usually a sum of components relative to the different chemical states of the carbon atom at the surface. Line fitting of C_{1s} spectra allows, semiquantitatively an evaluation of the

relative amounts of different functional groups^{111,112} at the surface. Large chemical shift effects are given by fluorocarbon polymers, owing to the electron attractive effect of fluorine (Figure 1.21).

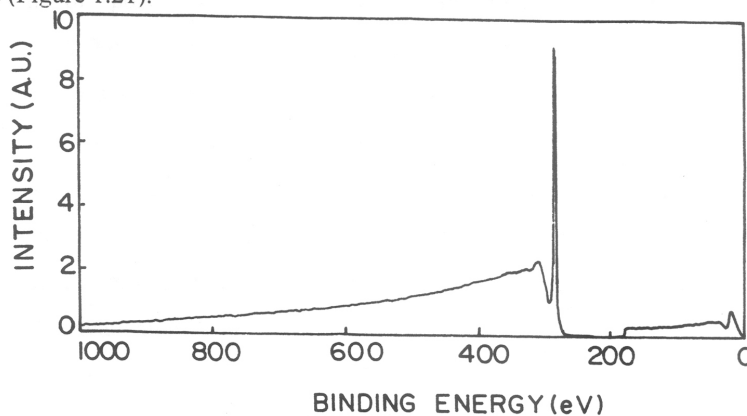

Figure1.19: XPS spectrum of PE

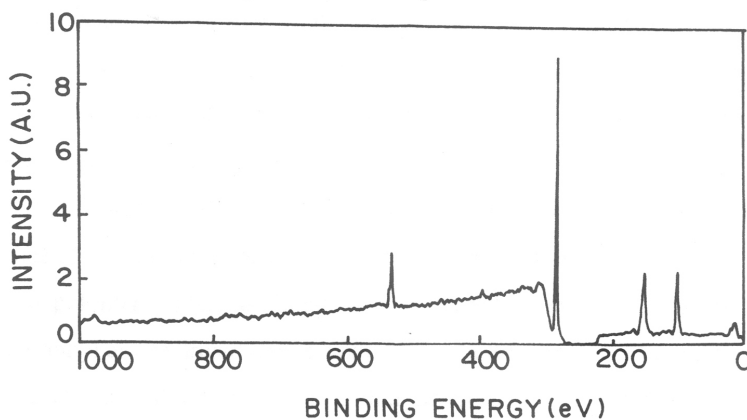

Figure1.20: XPS spectrum of PE contaminated by silicone oil

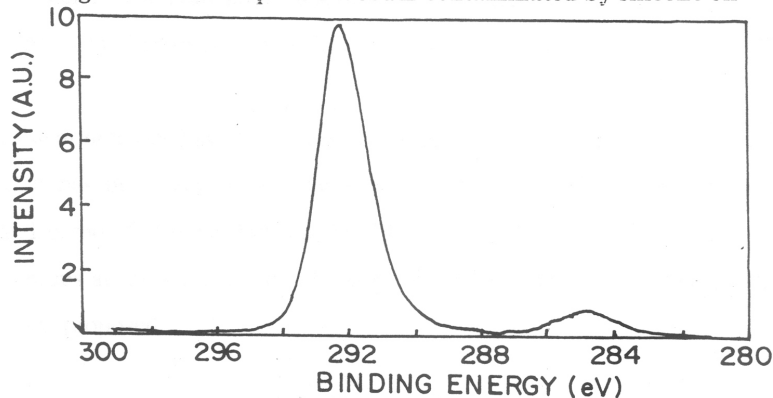

Figure1.21 : Carbon C1s peak of PTFE. The small peak at 285 eV is hydrocarbon contamination

Surface of polymers¹¹², copolymers¹¹³ and blends¹¹⁴ have been widely studied by XPS. Modification of polymers surfaces using chemical/physical methods have been characterized by XPS analysis.¹¹⁵ Grafting studies on to polymer surfaces have also been carried out.¹¹³ In such studies observed chemical shifts are sometimes not sufficient to unambiguously define the nature of functionality at the surface. For instance, it is impossible to distinguish ketones from aldehydes, from ester etc. Since each group has a specific chemical reactivity many secondary transformation reactions have been proposed which introduce a new, easy detectable element at the surface. This method has been called 'tagging' or 'derivatization'.

Treating PE with a chromic acid /sulfuric acid mixture mainly produces carboxyl groups. Treating a poly(chlorotrifluoroethylene) surface with methyl lithium removes CF_2 - groups near the surface, with an increase of the hydrocarbon component by the introduction of methyl groups and unsaturations.¹¹⁷ Etching of PTFE with a solution of sodium naphthalene in THF results in deep changes of C_{1s} peak, appearance of O_{1s} and Na 1S peaks and a decrease of F 1s intensity. Rinsing with H_2O and THF results in minor changes and the disappearance of sodium from the surface. The latter observation is attributed to the removal of NaF. The polymer surface is found to be oxidized as evidenced by the presence of carboxyl, carbonyl and hydroxyl bonds. Oxidation of a PP film with chromium(VI) oxide in acetic acid/acetic anhydride results in a thin layer(10nm) of hydroxyl groups, olefins, ketones and esters.¹¹⁸ Derivatization experiments were used to unambiguously identify the groups formed. A gradual dissolution of the modified layer was also observed.

Various physical methods have been used to improve the adhesion properties of polymers. Using XPS it has been shown that flame treatments induce the formation of hydroxyl, carbonyl and carboxyl groups both on PE, PP.¹¹⁹ On the basis of the relative amount of functional groups at the surface a step by step oxidation mechanism of the methyl pendent group has been proposed.

Cold plasma, a technology developed in the electronic industry has become a very popular method for treatment of polymer surfaces. XPS has been applied to the study of water or oxygen plasma treatments of PE surfaces.¹²⁰ These process provide high densities of

carboxylic acid groups which can be converted to alcohol or esters. Studies on oxygen or air plasma treated surfaces have been carried out on PP,¹²¹ PS,¹²² PTFE,¹²³ copolymers and many other materials. Studies have also been made using other gases like argon, nitrogen, ammonia, H₂O with the general aim of understanding the modification mechanism and the suitability of the technique for application purpose.

1.5.4 Scanning electron microscopy

The surfaces of polymers before and after surface treatments provides information about the changes in surface morphology which occur upon reaction. This method has been widely used for the changes in microtopography which results upon surface modification. This changes are very apparent when the modification is corrosive in nature. In these cases the surfaces are etched and pitted.

In SEM the electrons are excited from a tungsten filament, accelerated by a voltage (1-30 KeV) and directed down the center of an electron optical column consisting of magnetic lens. These lenses cause a fine electron beam to be focused onto the specimen surface. Scanning coils placed before the final lens cause the electron spot to be scanned across the specimen surface in the form of a square raster. The currents passing through the coils are made to pass through the corresponding deflection coils of a cathode ray tube which produces a similar raster on the screen in a synchronous fashion.

The electron beam excites the emission of secondary electrons from the specimen surface. These emitted electrons strike the collector and the resulting current is amplified and used to modulate the cathode ray tube. Hence there is a direct correspondence between the number of secondary electrons collected from any point and the brightness of the point on the CRT screen.

The secondary electrons are emitted from a shallow region of the surface and hence are very sensitive to change in the surface microtopography. Thus, secondary electron images are good indicators of the corrosive nature of a reaction.

1.5.5 Secondary ion mass spectroscopy

SIMS (secondary ion mass spectroscopy) techniques have acquired importance particularly in the analysis of semiconductors and polymers. In a SIMS experiment the particles (secondary ions) emitted from the surface as a consequence of ion or atom bombardment are mass analyzed. In static SIMS (SSIMS) the ion current incident on the surface is very limited (some 10^{-10} ampere). Therefore secondary ions come from the first one or two layers of the material and the surface is not substantially damaged. In dynamic SIMS the ion current is higher (upto 10^{-7} ampere). Therefore the surface is rapidly eroded and with no specificity to the surface. Whereas, SSIMS can be used for surface studies, dynamic SIMS has found applications in depth profiling studies. The process following from the impact of an accelerated ion or atom with the surface is shown in Figure 1.22.

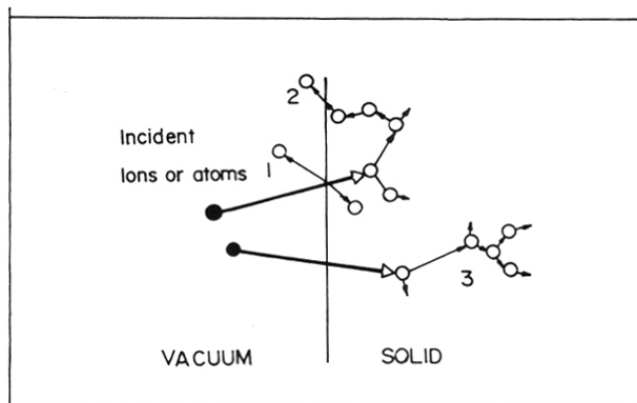

Figure 1.22: Schematic representation of the sputtering process: (1) ion emission near the impact point; (2) ion emission at some distance from the impact point; (3) no emission, only secondary phenomena

The energy of the incident ion is dissipated in a series of collisions and secondary particles are emitted even at a distance from the primary impact site. Such a process is commonly called sputtering. A fraction of emitted particles is submitted to ionization and can be analyzed. The intensity $i_s^M = i_p s r^+ \theta_M \beta$

Where θ_M is the surface concentration of M, expressed as coverage, β an instrumental factor, s the sputtering yield (i.e the number of particles M emitted after each primary ion impact) and r^+ is the probability of particle M to be emitted as an ion and detected. s and r^+ determined the spectrum since they depend on emission and ionization mechanisms, which

are functions of the electronic structure of the material. As in conventional mass spectrometry, it is also possible in SSIMS to obtain both positive and negative ion spectra. Most of the data now available are positive ion spectra since negative ion spectra are considered to be much less informative. However negative ion spectra are particularly useful in detecting groups containing electronegative elements such as oxygen and halogens.

1.5.6 Atomic force microscopy

The atomic force microscope was invented by Binnig, Quata and Gerber.^{1b} Similar to a scanning tunneling microscope the atomic force microscope can produce three dimensional image of a solid surface at very high resolution. The advantage of using an atomic force microscope is that it can image nonconducting samples such as polymers and ceramics. In the past several years atomic force microscopy has shown great promise for generating surface polymer morphological information. In a study of the surface structure of dendritic crystals of polyethylene.¹²⁴ AFM proved to be a technique comparable to if not better than scanning electron microscopy. In another study, the surface structure of polystyrene and poly(2,6- dimethyl-1,4-phenylene oxide) films was studied by AFM before and after the application of tensile elongation.¹²⁵ Before the application of strain the surface of the film was smooth. Immediately after the application of strain the surface of the stretched polymer films remained smooth. However topographic bumps were detected by AFM on the stretched polymer films as the aging time increased. The technique has also been applied to study the surface structure of copolymers^{126,127} and the surface morphology of electrochemically polymerized poly(phenyl oxide) film. A typical commercial AFM consists of a piezoelectric scanner which controls scanning motion, an optical head with cantilever deflection and a base, which support the scanner and the head and includes a circuit for the deflection signal which operates by scanning across the cantilever spring. The tip and the cantilever are microfabricated from silicon, silicon oxide or silicon nitride. Features on the sample surface cause the cantilever to deflect as the sample moves under the tip. An optical system is used to sense the position of the tip relative to the sample. Figure 1.23 shows an optical system for a popular commercial AFM.

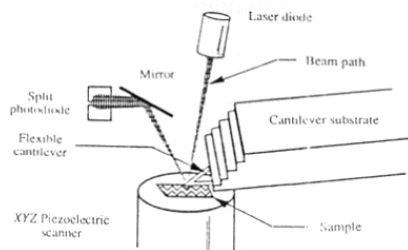

Figure 1.23: An AFM optical sensing system

The beam from a laser diode is focused onto the back of the cantilever. The beam is reflected off the back of the cantilever onto a split photodiode which provides a sensitive measure of the cantilever deflection. The feedback signal is used to control the height of the piezoelectric crystal as the sample is scanned. The height of the piezoelectric crystal is related directly to the topography of the sample surface.

1.6 SAMPLE CONDITIONING AND HANDLING

Most polymer surfaces are contaminated with foreign materials. The surfaces of polymer are contaminated with mold-release agents, additives, oxygen containing impurities and solvents. It is difficult in case of a polymer to prepare a clean surface that is totally free of impurities. Generally, in the field of surface science a surface is regarded as clean when no impurities can be detected by techniques such as XPS (detection limit $\sim 0.1\%$). However, if the same surface were to be examined by a surface analysis technique with higher sensitivity such as SIMS (detection limit $\sim 10^{-5}\%$), impurities probably would be detected. Thus cleanliness of the surface is a relative concept.

Tools which are used to handle samples should be very clean because the contaminants on the tools can be easily transferred to the specimen. In addition direct contact with the surface of sample to be analyzed should be avoided. Before the analysis it is recommended that the surface first be inspected with a light microscope to examine the physical condition of the sample. A detailed description of different sample-handling techniques has been presented by Committee E 42 of the American Society for Testing and Materials (ASTM).¹²⁸

Depending on the purpose of the investigation there are several commonly used techniques to prepare a clean surface. The one most commonly used is ion-beam cleaning. Inert gas ions such as Ar^+ at 1-10 KeV remove contaminants from a surface very effectively. However, physical interactions of ions with surface atoms can introduce unwanted side effects such as surface reactions or preferential sputtering of one or more components. In addition chemical and physical properties of a surface can be quite different before and after ion-sputtering cleaning.

Solvent cleaning is another commonly employed method. The basic solvent cleaning procedures include vapor degreasing, ultrasonic vapor degreasing and solvent wipe, immersion or spray. The biggest problem with solvent cleaning is the possibility that residual solvent will be left on the surface. Figure 1.24 represents XPS spectra of poly(ethylene terephthalate) (PET) before and after ultrasonic washing in methanol, acetone and n-heptane.

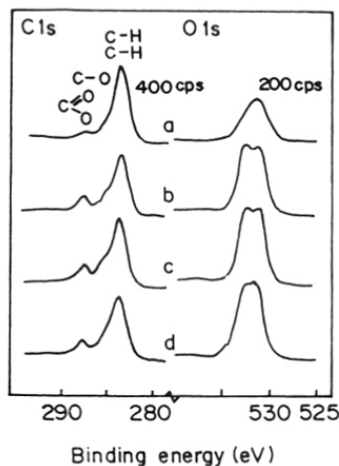

Figure 1.24: XPS spectra of poly(ethylene terephthalate) (a) before cleaning and after cleaning with an ultrasonic cleaner in (b) methanol, (c) acetone and (d) n-heptane

The PET surface is heavily contaminated with hydrocarbon as revealed by the C 1s spectrum with an intense hydrocarbon peak and a relative weak ester component and also by the asymmetrical shape of the O 1s peak. The C 1s spectrum from the cleaned surface shows a well defined ester component; the O 1s spectrum has the symmetrical double peak

corresponding to two oxygen atoms in the ester group. These results indicate that a polymer sample with a surface free of contaminants can be prepared by ultrasonic washing in an organic solvent without destroying the surface chemical structure.¹²⁹ Cleavage or fracture of a sample and mechanical abrasion of the sample in a vacuum chamber is another frequently used method for preparing clean surface without depositing contaminants on the surface.

1.7 STRUCTURE-PROPERTY RELATIONSHIP IN MODIFIED SURFACES

In order to obtain information about structure property relationship it is necessary to deal in diverse fields of science including morphology, rheology, organic chemistry, physical chemistry and mechanics. Many of these fields deal with overall macroscopically observed properties and relate this to molecular models using a variety of theories. Some times it is necessary to create systems with limited variables, to idealize applications and to create models based upon simple perceptions in order to make an intractable problem easy to handle. Experiment and modeling can advance the understanding of a complex system. Information that is gained about polymer structures can, often, through the application of suitable theory give information concerning observable properties and vice versa. With correlative data, polymer structures can be engineered to maximize a desired property and to reduce an undesired one. Solid organic polymer surfaces offer several advantage over other class of material because its surface energy is less as compared to other materials. So surface can be freed of contaminants by extraction with suitable solvents. Polymer do not undergo spontaneous oxidation and thus is useful for study interfacial phenomena under laboratory condition. Polymer surfaces are sensitive to temperature, in the sense that they are mobile at about 100°C. Interaction between the solvent and the polymer causes the interface structure to change due to mobility of the polymer surface. Thus polymer surfaces provide a unique opportunity to alter the interface by changing the solvent and temperature. A primary factor for this absence of progress is the lack of substrate suitable for studies the molecular level. New methods have to be developed for functionalizing and modifying polymer surfaces which produce materials whose structures are better understood at the molecular level. This development would make possible detailed explorations of surface structure-property correlations for these new materials. When these materials have been exhaustively characterized the knowledge gained about surface chemistry, reactivity and

structure could be used to microscopically alter the structure of the material and observe the changes which occur in the macroscopic surface properties.

The method generally used for surface modification is chemical oxidation, chemical reduction, plasma treatment, corona discharge treatments etc. Most of these modifications involve reaction conditions and highly reactive reagents which tend to restrict selectivity in product formation and structural change of the polymer surface. The modified polymer are more reactive than the starting material. These modified material would be useful to study interfacial phenomena.

Relatively fewer attempts have been made to relate microscopic surface characteristics to macroscopic behavior like wetting or adhesion. In addition, data concerning structure-reactivity relationships is noticeably missing from the literature pertaining to organic polymer surfaces.

Whitesides and coworkers^{7,43} studied molecular level characteristics of the interfacial region-structure, polarity, reactivity, location and concentration of functional groups and macroscopic material properties of the functionalized polymer such as wettability and adhesion. If the polymer surface contains ionizable groups which differ significantly in their polarity in going from the non ionized state, then a simple change in pH can dramatically change the polarity and wettability of the surface.¹³⁰ This has perhaps been most elegantly demonstrated in a set of recent studies by Whitesides and his group utilizing essentially contact angle titration. They studied pH dependent wettability on surface functionalized polyethylene such as PE-COOH and its derivatives. It provides a particularly convenient method for examining the state of ionization of functional groups influencing the wetting of the functionalized polymer. They also studied surface reconstruction of PE-COOH and its derivatives by contact angle and XPS (Figure 1.25).³⁶

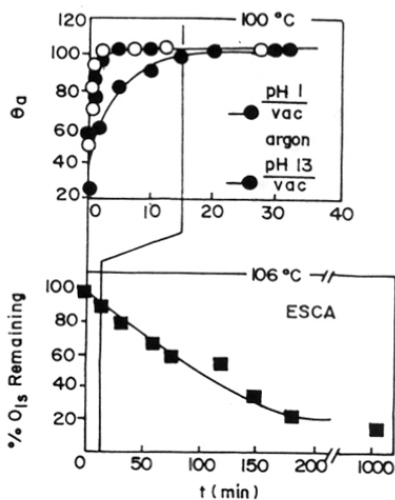

Figure 1.25: Top: The advancing contact angle (θ_a) of water on PE-CO₂H as a function of the time the polymer had been heated at 100^oC. samples were heated under vacuum or under argon prior to determination of θ_a with water at either pH 1 or pH 13. The value of θ_a on PE-H does not change under these conditions. Bottom: The normalized XPS (ESCA) O_{1s} signal intensity obtained from PE-CO₂H as a function of time at 106^oC. Samples were heated under argon prior to examination by XPS

Upon heating the PE-COOH surface it becomes hydrophobic due to migration of COOH group towards the interior of the polymer film. The rate of reconstruction also depends on factors such as nature of the polymer substrate, nature of functional group, size of the functional groups and the entropy of the system.

Polymer surface containing azobenzene groups show a photoinduced trans to cis isomerization, resulting in a significant increase in dipole moment and therefore polarity (Figure 1.26).

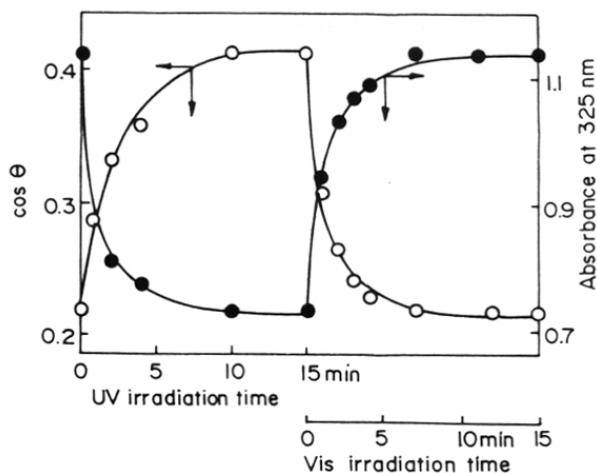

Figure 1.26: Photoinduced change in (O) wettability and (●) absorbance of PHEMA film having pendant azobenzene groups. UV: $\lambda = 350 \pm 50$ nm; Vis: $\lambda > 470$ nm. Azobenzene content was 0.387

1.8 APPLICATIONS

Surface modification of polymer is an interesting example of chemical modification which can alter polymer surface properties without affecting the bulk properties. Such modified surfaces play an important role in determining properties such as wettability, adhesion, permeability and biocompatibility.

Wetting:

The wettability of solid surfaces by water plays an important role in the application of various plastics and rubbers in our every day. Often we would like to keep certain surfaces, such as the outer layer of raincoats, water repellent so that water will not seep inside. On the other hand it is desirable to make other surfaces more water loving, or hydrophilic, to achieve the opposite effects. One cannot for example, paint with water colour unless the surface of art paper is sufficiently water wettable. In recent years the hydrophilicity of solid surface has attracted considerable attention in biomedical applications. Many implant

devices developed as temporary or permanent replacement of biological organs use synthetic materials, including plastics and rubbers, which have to be exposed to tissues and body fluids. In general, materials found in living organisms with the obvious exception of lipids are quite hydrophilic while most synthetic polymers are hydrophobic in nature. To make such synthetic materials compatible with the surrounding environment the surfaces of synthetic materials need modifying to become more hydrophilic. Other obvious areas where water wettability is an important factor include textile finishes, printing,¹³¹ paper and disposable sanitary articles,¹³² adhesives and various coating applications.

One of the examples where simple lowering of water surface tension may potentially cause a problem is in absorbent applications. There are many classical water absorbing articles—such as sponges, towels, nappies, swabs and mops which all work basically in a similar manner: water is wicked into porous or fibrous absorbent materials and held there by the capillary action. In order for the water to be absorbed it must wet the surface of the absorbent material. Lowering the water surface tension should certainly enhance the wicking; however, if one wants to retain the absorbed water inside the absorbent articles the lowering surface tension now become a problem. A low surface tension fluid will spread not only into the absorbent materials but also over any other surfaces adjacent the absorbent.

Adhesion, painting, permeability:

Painting is another good example of an application where such spatially resolved wetting becomes important. It is impossible to print figures and image over a surface unless the material surface can be wetted by an ink or pigment containing fluid. However, if the surface tension of the ink is so low that it can spread all over the solid surface., a severe smearing tension fluids arise whenever there is need to confine the wetting of solid surfaces to a spatially well defined area. These problems can be avoided if the wettability of solid surfaces is controlled not by lowering the fluid surface tension γ_L but by increasing the solid surface energy γ_S . This is one of the main motivations behind developing intrinsically hydrophilic solid surfaces.

For most polymers the outer most surface is hydrophobic due to a preponderance of nonpolar bonds and hence difficult to wet. Many of the paints, adhesives and printing inks used to coat polymer products are hydrophilic. They do not form strong chemical

interactions with a hydrophobic polymer surface and can not properly adhere. Thus, there is a real commercial incentive to develop methods capable of modifying the outermost surface of the polymer in order to improve its adhesion. Modification processes usually involve the incorporation of oxygen and /or nitrogen into the surface of polymer. This enables the formation of stronger interactions between the surface and the coating, thus improving adhesion without affecting bulk properties. Specific functional group on polymer surfaces can control the adhesion between polymer and metal. One example is the chemical modification of polybutadiene surfaces. The photolytic addition of thiols to the carbon-carbon double bonds at the surface of polybutadiene provides a convenient method for preparing substrates for studying the effect of sulfur containing functional groups on the adhesion of polymer to metals. The main gas phase techniques for modifying polymer materials involve excited state chemistry processes such as plasma glow discharge, corona discharge or flame treatment. Recently, an alternative surface modification process that also uses excited state chemistry has been developed in Canada.¹³³ This process exposes the polymer surface to both ultraviolet light (UV) and ozone to increase the number of oxygen-functional groups. This UV/ozone (UVO) approach appears to overcome many of the negative features of other surface treatments, especially for 3D objects.

Polymer surface properties (adsorption, adhesion, wettability, friction) are directly related to the surface chemical structure. Synthetic routes to chemically modified polymer surfaces with the objective of preparing substrates with controllable surface structures is an important method for controlling the macroscopic surface properties. Surface selective modifications have been reported for polyethylene,¹³⁴ poly(chlorotrifluoroethylene),¹³⁵ poly(vinylidene fluoride),¹³⁶ polypropylene,⁸⁹ poly(tetrafluoroethylene-co-hexafluoropropylene)¹³⁷ and poly(ether ether ketone).¹³⁸ Under certain conditions the photochlorination of a barrier layer (chlorinated polyethylene) that inhibits permeation of chlorine to greater depths. Surface selective modification of this type may be useful for the preparation of asymmetric nonporous membranes for gas separation. Heterogeneous (gas-solid) photochlorination reactions of a poly(4-methyl-1-pentene) film was studied with the objective of determining factors that control the surface selectivity of the modification reaction. By adjusting the chlorine vapor pressure, light source intensity and reaction time, the depth of the chlorination reaction (thickness of the modified layer) and the

extent(density) of chlorination (Cl:C ratio) could be independently controlled. Gas permeabilities of asymmetric membranes prepared by this reaction to hydrogen, carbon dioxide, oxygen and nitrogen were determined. A densely and deeply chlorinated membrane was shown to have improved selectivities over those of unmodified poly(4-methyl-1-pentene). The selectivity increased the most (from 16.5 to 95.9) for H_2/N_2 and the least (from 2.1 to 2.6) for CO_2/O_2 with accompanying decreases in flux.

Proteins are complex polyamides with a wide range of amphiphilic and dynamic characteristics. Chan and Dill recently reviewed the motions and time scales for both proteins and synthetic linear polymers. Although the nomenclature and the semantics are different in the two worlds, the processes and the principles are very similar. The tendency for protein molecules to adsorb and then conformationally adapt (denature) at polymer/aqueous interfaces has been an area of major study for the past thirty years, largely driven by the need to enhance and improve the blood and tear compatibility of various medical devices and diagnostic products.

Field responsive materials:

Molecular recognition, supramolecular chemistry and molecular engineering are developing areas of chemistry and technology that critically depend on understanding the organization of assemblies of molecules either in solution or in the solid state.¹³⁹ Such issues have been exemplified in recent studies of organization and morphology in mixtures of molecules in self-assembled monolayers and membranes. Indeed the ability of induce organization can develop into an important area that could have practical application. Many surface-functionalized polymers in contact with a solvent have a surface that is better described as an interface of functionality the morphology of which can vary in both a two and three dimensional way.^{139,140}

Biocompatibility:

A number of “magic” biomaterials have been studied by Andrade and coworkers¹⁴⁴ from the point of view of interface dynamics and restructuring. Here we discuss some recent work on polyether urethanes, because they represent multi-phase polymer systems with the “intelligence” required to restructure their interfaces, depending on the environment.

Tingey have extensively characterized the surface properties of biomedical polyether urethanes both in and out of water. Briefly, there is a tendency for low energy phase to dominate in air and the more high energy phase to dominate in water, although in many biomedical polyether urethanes the surface free energies of the soft segment and hard segment phases are roughly comparable, so this tendency is not particularly dramatic. It is far more dramatic in multiphase polymer systems where the two phases differ greatly in their respective surface free energies. In addition, and perhaps even more importantly, the phase dimensions in these systems are in the range of 100 Å or so, a particularly important scale for plasma and tear protein interaction.

Proteins are highly anisotropic, dynamic and conformationally unstable polymers and thus exhibit a wide range of interactions at interfaces.¹⁴¹ The ability of the same protein to interact at different interfaces by hydrophobic, polar and electrostatic means, and by combinations of such forces, is now well known and has been extensively discussed. The ability of such proteins to conformationally adapt, i.e denature at interfaces is also well known and qualitatively understood. It is generally recognized that one of the greatest problem in biomaterials which hinders the full exploitation of synthetic vascular graft and organs is the thrombogenic nature of most materials in blood contacting applications. Therefore, by introducing suitable functional group onto the surface of polymer it is possible to improve the biocompatibility of polymer. PEG bearing surfaces are currently one of the most promising approaches to blood compatibility:

- PEG grafted onto polymers form hydrogel surfaces which inhibit protein adsorption.
- Heparin grafted onto polymer surfaces prevent surface activated blood clotting.
- Antibodies attached to a polymer surface which can used in the detection of antigens.

PEG surfaces are resistant towards protein adsorption. The adsorption of radioactive labelled human transferrin onto PE films and PE with PEG grafted onto the surface. The thrombus formation of blood in contact to surfaces grafted with heparin was not completely prevented, but it significantly inhibited compared with the untreated sample. The heparin molecules may be too tightly bonded to the PE matrix to completely prevent blood coagulation. Attachment of antibodies or antigens to polymer substrates are used in ELISA (enzyme linked immunosorbent assay) techniques. With surface grafting it is possible to

covalently attach proteins to polymer surfaces, thus inhibiting bleeds and losses of protein during washing.

The use of catheters has gained widespread acceptance by the medical profession. Catheters are used frequently in such routine procedures as the delivery of intravenous fluids to and the removal of urine from compromised patients and with increasing frequency in such complicated procedures as the compression of plaques in coronary arteries and the obstruction of blood flow to specific areas of the body. The more complicated catheter procedures often require the use of two catheter systems. Their use has been restricted because of excessive friction between the catheters. Catheters are most commonly fabricated from silicone rubber (SR), polyethylene (PE), poly(vinyl chloride) (PVC) and fluorinated ethylene- propylene copolymer (FEP). Plasma treatment resulted in increased surface energy of the polymers, as indicated by increased wettability and decreased air-water contact angles. Also, oxidation of the polymers occurred even when the polymers were treated in inert atmospheres, most probably as a result of interaction with water vapor present as an impurity in the discharge chamber.^{140,141}

1.9 REFERENCES

1. a) Swalen. J.D, Allara. D.L, Andrade. J.D, Chandross. E.A, Garoff. S, Israelachvili. I, McCarthy. T.J, Murray. R, Pease. R.F, Rabolt. J.F, Wynne. K.J, Yu. H, Langmuir, **1987**, 3, 932.
 b) Chan. C. M, Polymer Surface Modification and Characterization. Hanser, New York, **1994**, p 1-285.
 c) Garbassi. F, Morra. M, Occhiello. E, Polymer Surfaces from Physics to Technology. John Wiley & Sons Ltd, Chichester, **1994**, p 1-462.
2. Baszkin. A, Deyme. M, Nishino. M, Ter-Minassian-Saraga. L, Prog.Colloid Polym.Sci., **1976**, 61, 97.
3. Rasmussen. J.R, Stdronsky. E.R, Whitesides. G.M, J.Am.Chem.Soc., **1977**, 99, 4757.
4. Ward. W.J, McCarthy. T.J. In Encyclopedia of Polymer Science and Engineering, 2nd ed.; Mark. H.F, Bikales. N.M, Overberger. C.G, Menges. G, Kroschwitz. J.I, Eds.; John Wiley and Sons, New York, **1989**, p674.
5. McCarthy. T.J, Chimia, **1990**, 44, 316.

6. Rasmussen. J.R, Stedronsky. E.R, Whitesides. G.M, J.Am.Chem.Soc., **1977**, 99, 4736.
7. Whitesides. G.M, Ferguson. G.S, Chemtracts-Organic Chemistry, **1988**, 1, 171 and reference cited there in.
8. Bergbreiter. D.E, 'Chemically Modified surfaces' Mottola. H.A, Steinmetz. J.R, Eds.: Plenum Press, New York, **1992**, p 133-154.
9. Andrade. J.D, Gregonis. D.E, Smith. L.M, 'Surface and Interfacial Aspects of Biomedical Polymers' Andrade. J.D, Ed.; Plenum Press, New York, **1985**, Vol 1, Chapter 2.
10. Benderly. A.A, J.Appl.Polym.Sci., **1962**, 20, 221
11. Lukas. J, Lochmann. L and Kalal. J, Angew.Makromol.Chem., **1990**, 181, 183
12. Namboori. C.G.G and Haith. M.S, J.Appl.Polym.Sci., **1968**, 12, 1999
13. Lee. K.W, Kowalczyk. S.P and Shaw. J.M, Macromolecules, **1990**, 23, 2097
14. Allmer. K, Hult. A and Ranby. B, J.Polym.Sci.Polym.Chem., **1989**, 27, 1641
15. Allmer. K, Hult. A and Ranby. B, J.Polym.Sci.Polym.Chem., **1989**, 27, 3405
16. Allmer. K, Hult. A and Ranby. B, J.Polym.Sci.Polym.Chem., **1988**, 26, 2099
17. Kubota. H, Yoshino. N and Ogiwara. Y, J.Appl.Polym.Sci., **1990**, 39, 1231
18. Tazuke. S and Kimura. H, Makromol.Chem., **1978**, 179, 2603
19. Zhang. P.Y and Ranby. B, J.Appl.Polym.Sci., **1990**, 40, 1647
20. Zhang. P.Y and Ranby. B, J.Appl.Polym.Sci., **1990**, 41, 1469
21. Zhang. P.Y and Ranby. B, J.Appl.Polym.Sci., **1990**, 43, 621
22. Clark. D.T and Wilson. R, J.Polym.Sci., **1983**, 21, 837
23. Collions. G.C.S, Lowe. A.C and Nicholas. D, Eur.Polym.J., **1973**, 9, 1173
24. Clark. D.T and Dilks. A, J.Polym.Sci.Polym.Chem.Ed., **1977**, 15, 2321
25. Briggs. D and Kendall. C.R, Polymer, **1979**, 20, 1053
26. Briggs. D, Brewis. D.M and Konieezko, J.Mater.Sci., **1976**, 11, 1270
27. Holmes-Farley. S.R and Whitesides. G.M, Langmuir, **1987**, 3, 62
28. Blais. P, Carlsson. D.J, Csullog. G.W and Wiles. D.M, J.Colloid.Interface.Sci., **1974**, 47, 636
29. Siperko. L.M, Appl. Spectrosc., **1989**, 43, 226.
30. Baszkin. A and Ter-Minassian-Saraga, J.Polym.Sci., **1971**, C34, 243
31. Baszkin. A and Ter-Minassian-Saraga, Polymer, **1974**, 15, 759
32. Rasmussen. J.R, Bergbreiter. D.E and Whitesides. G.M, J.Am.Chem.Soc., **1977**, 99, 4736

33. Rasmussen. J.R, Bergbreiter. D.E and Whitesides. G.M, J.Am.Chem.Soc., **1977**, 99, 4746
34. Cross. E.M, McCarthy. T.J, Polym. Prepr., **1988**, 29, 285
35. Holmes-Farley. S.R and Whitesides. G.M, Langmuir, **1986**, 2, 266
36. Holmes-Farley. S.R and Whitesides. G.M, Langmuir, **1987**, 3, 799
37. Barton. D.H.R, Boivin. J and Hill. H.C, J.Chem.Soc.Perkin Trans., **1986**, 1, 1797
38. Barton. D.H.R, Boivin. J, Gastiger. M, Morzycki. J, Hay-Motherwell. R.S, Motherwell. W, Ozbalik. N and Schwartzentruber. K.M, J.Chem.Soc.Perkin Trans., **1986**, 1, 947
39. Olsen. D.A and Osteraas. A.J, J.Polym.Sci. PartA, **1969**,1, 7, 1913
40. Fonseca. C, Perena. J.M, Faton. J.G and Bello. A, J.Mater.Sci., **1985**, 20, 3283
41. Bergbreiter. D.E and Kabza. K, J.Am.Chem.Soc., **1991**, 113, 1447
42. Idage. S.B, Badrinarayanan. S, Vernekar. S.P, Sivaram. S, Langmuir, **1996**, 12, 1018
43. Whitesides. G.M, Laibinis. P.E, Langmuir, **1990**, 6, 87
44. Bergbreiter. D.E and Kabza. K, J.Am.Chem.Soc., **1991**, 113, 1447
45. Elman. J.F, Geranser. L.F, Goppert-Berarducci. K.E and Pochan. J.E, Macromolecules, **1990**, 23, 3922
46. Cross. E.M and McCarthy. T.J, ACS Polym.Prepr, **1990**, 31, 422
47. Hartig. H and Huettinger. K.J, J.Colloid.Interface.Sci., **1983**, 93, 63
48. Polymer films were immersed in a solvent containing known quantities of sensitizer and poly(vinyl acetate) (PVAC, Mw = 100,000) and dried to prepare a sensitizer coated films. The substrate was irradiated in a tube which is fixed on sample holder was kept at the center part of the tube and monomer was placed at the bottom part.
49. Kubota. H, J.Appl.Polym.Sci., **1993**, 48, 1717
50. Ruckert. D and Geuskens. G, Eur.Polym. J., **1996**, 32, 201
51. Nuzzo. R.G and Smolinski, Macromolecules, **1984**, 17, 1013
52. Nakayama. Y, Takahagi. T, Soeda. F, Hatada. K, Nagaoka. S, Suzuki. J and Ishitani. A, J.Polym.Sci.Chem.Ed., **1988**, 26, 559
53. Occhiello. E, Morra. M, Cinquina. P and Garbassi. F, Polymer, **1992**, 33, 3007
54. Occhiello. E, Morra. M, Morini. G, Garbassi. F and Johnson. D, J.Appl.Polym.Sci., **1991**, 42, 2045
55. Poncin-Epaillard. F, Chevet. B and Brosse. J.C, Eur.Polym.J., **1990**, 26, 333
56. Clark. D.T and Dilks. A, J.Polym.Sci.Polym.Chem.Ed., **1979**, 17, 957

57. Foerch. R, McIntyre. N.S, Sodhi. R.N.S and Hunter. D.H, *J.Appl.Polym.Sci.*, **1990**, 40, 1903
58. Foerch. R, Izawa. J and Spears. G, *J.Adhesion Sci.Technol.*, **1991**, 5, 549
59. Yagi. Y, Paviath. A.E and Pittman. A.G, *J.Appl.Polym.Sci.*, **1982**, 27, 4019
60. Strobel. M, Corn. S, Lyons. C.S and Korba. G.A, *J.Polym.Sci.Polym.Chem.Ed.*, **1985**, 23, 1125
61. Gerenser. L.J, Elman. J.F, Mason. M.G and Pochan. J.M, *Polymer*, **1985**, 24, 47
62. Pochan. J.M, Gerenser. L.J, and Elman. J.F, *Polymer*, **1986**, 27, 1058
63. Carey. D.H, Ferguson. G.S, *Macromolecules*, **1994**, 27, 7254
64. Paul. M, Carey. D.H and Ferguson. G.S, *Chem.Mater.*, **1995**, 7, 1303
65. Mirzadeh. H, Ekbatani. A, Katbab. A, *Iranian Polymer Journal*, **1996**, 5, 225
66. Nada. I, *Nature*, **1991**, 350, 143
67. Munro. H.S, *ASC Polym. Mater. Sci. Eng.*, **1988**, 58, 344
68. Costallo. C.A and McCarthy. T.J, *Macromolecules*, **1984**, 17, 2940
69. Ikada. Y, *Polymer*, **1995**, 36, 21
70. Gibson. H.W and Bailey. F.C, *Macromolecules*, **1980**, 13, 34
71. Mateinzo. L.J and Egitto. F.E, *Poly Degradation Stability*, **1992**, 35, 181
72. Nakayama. Y, Takahagi. T, Soeda. F, Hatada. K, Nagaoka. S, Suzuki. J and Ishitani. A, *J.Polym.Sci.Polym.Chem.Ed.*, **1988**, 26, 559
73. Lub. J, Van Vroonhoven. F.C.B.M, Bruninx. E and Benninghoven. A, *Polymer*, **1989**, 30, 35
74. Foerch. R, McIntyre. N.S and Hunter. D.H, *J.Polym.Sci.Polym.Chem.Ed.*, **1990**, 28, 803
75. Ogiwara. Y, Kanda. M, Takumi. M and Kubota. H, *J.Polym.Sci.Polym.Lett.Ed.*, **1981**, 19, 457
76. Kubota. H, Yoshino. N and Ogiwara. Y, *J.Polym.Sci.Polym.Lett.Ed.*, **1983**, 21, 367
77. Inagaki. N, Tasaka. S, Hibi. K, *J.Polym.Sci.Polym.Chem.Part A*, **1992**, 30, 1425
78. Gerenser. L.J, *J.Adhesion Sci. Technol.*, **1993**, 7, 1019
79. Puschett. J. B and Matyjaszewski. K, US patent 5077078, Dec.31, **1991**
80. Allcock. H.R, Morrissey. C.T, Way. W.K, Winograd. N, *Chem. Mater.*, **1996**, 8, 2730
81. Pemberton. L and Jaeger. R.D, *Chem. Mater.*, **1996**, 8, 1391
82. Coulman. D and Edman. J, *Makromol. Chem. Macromol. Symp.*, **1996**, 101, 471
83. Ikada. Y, *Makromol. Chem. Macromol. Symp.*, **1996**, 101, 455

84. Ikada. Y, Adv.Polym.Sci., **1984**, 57, 103
85. Negishi. M, Arai. K and Okada. S, J.Appl.Polym.Sci., **1967**, 11, 115
86. Meister. J.J, Patil. D.R, Field. L.R and Nicholson. J.C, J.Polym.Sci. Polym.Chem.Ed., **1984**, 22, 1963
87. Meister, J.J, Patil, D.R, Jewell. M.C and Krohn. K, J.Appl.Polym.Sci., **1987**, 33,1887
88. Samal. R.K, Iwata. H and Ikada. Y, Physicochemical Aspects of Polymer Surfaces, K.L.Mittal(ed), Plenum Press, New York, **1983**, Vol. 2, p. 801
89. Lee. K.W and McCarthy. T.J, Macromolecules, **1988**, 21, 309
90. Oster. G and Shibata. O, J.Polym.Sci., **1957**, 26, 233
91. Needles, H.L and Alger, K.W, J.Appl.Polym.Sci., **1975**, 19, 2207
92. Goldblatt. R.D, Park. J.M, White. R..C, Matienzo. L.J, Huang. S.J and Johnson, J.F, J.Appl.Polym.Sci., **1989**, 37, 335
93. Allmer. K, Hult. A and Ranby. B, J.Polym.Sci. Polym.Chem.Ed.,**1989**, 27, 3405
94. Allmer. K, Hult. A and Ranby. B, J.Polym.Sci. Polym.Chem.Ed., **1989**, 27, 3419
95. Munro. H. S, ASC Polym. Mater. Sci. Eng., **1988**, 58, 344
96. Mirabella. F.M, J.Polym.Sci. Polym.Chem.Ed., **1982**, 20, 2309
97. Schmidt. J.J, Gardella,Jr. J.A and Salvati,Jr. .L, Macromolecules, **1989**, 22, 4489
98. Clark. M.B, Burkhardt. C.A and Gardella,Jr. J.A, Macromolecules, **1991**, 24, 799
99. Kano. Y, Ishikura. K, Kawahara. S and Akiyama. S, Polymer J., **1992**, 24, 135
100. Vargo. T.G, Hook. D.J, Gardella,Jr. J.A, Eberhardt. M.A, Meyer.A.E and Baier. R.E, J.Polym.Sci. Polym.Chem., **1991**, 29, 535
101. Ranby. B, Gao. Z.M, Hult. A and Zhang. P.Y, in Chemical Reactions on Polymers, J.L.Benhan (Ed.), ACS Symp.Ser.no 364(**1988**).
102. Gardella, Jr. J.A, GrobeIII. G.L, Hopson. W.L and Eyring. E.M, Anal.Chem., **1984**, 56, 1169
103. Kano. Y, Ishikura. K, Kawahara. S and Akiyama. S, Polymer J., **1992**, 24, 135
104. Carlsson. D.J and Wiles. D.M, Macromolecules, **1970**, 2, 587,597
105. Narebska. A and Bukowski. Z, Makromol.Chem., **1985**, 186, 1411
106. Adamson. A.W, Physical Chemistry of Surfaces, 5th Edu. Wiley, New York,**1990**
107. Ratner. B.D, Weathersby. P.K, Hoffman. A.S, Kelly. M.A and Scharpen. L.H, J.Appl.Polym.Sci., **1978**, 22, 643
108. Sharma. A.K, Millich. F and Hellmuth. F.W, J.Appl.Polym.Sci., **1981**, 26, 2205

109. Kaelble. D.H and Cirlin. E.H. *J.Polym.Sci.Part A*, **1971**, 29, 363
110. Holmes-Farley. S.R, Reamey. R.H, McCarthy. T.J, Deutch. J, Whitesides. G.M, *Langmuir*, **1985**, 1, 725
111. Amudeswari. S, Reddy. C.R and Joseph. K.T, *J.Macromol.Sci.Chem.*, **1986**, A23, 805
112. Klasek. A, Kaszonyiova. A and Pavelka. F, *J.Appl.Polym.Sci.*, **1986**, 31, 2007
113. Schmitt. R.L, Gardella, Jr. J.A, Magill. J.H, Salvati, Jr. L and Chin. R.L, *Macromolecules*, **1985**, 18, 2675
114. Busscher. H.J, Hoogsten. W, Dijkema. L, Sawatsky. G.A, Van Pelt. A.W.J, De Jong. H.P, Challa. G and Arends. J, *Polymer Comm.*, **1985**, 26, 252
115. Golub. M.A and Cornia. R.D, *Polymer*, **1989**, 30, 1576
116. Uchida. E, Uyama. Y, Iwata. H and Ikada. Y, *J.Polym.Sci. Polym.Chem.*, **1990**, 28, 2837
117. Holmes-Farley. S.R, Reamey. R.H, McCarthy. T.J, Deutch. J and Whitesides. G.M, *Langmuir*, **1985**, 18, 1826
118. Lee. K.W and McCarthy. T.J, *Macromolecules*, **1988**, 21, 309
119. Briggs. D, Brewis. D.M and Konieczko. M.B, *J.Mater.Sci.*, **1979**, 14, 1344
120. Nuzzo. R.G and Smolinsky. G, *Macromolecules*, **1984**, 17, 1013
121. Occhiello. E, Morra. M, Morini. G, Garbassi. F and Humphrey. P, *J.Appl.Polym.Sci.*, **1991**, 42, 551
122. Dilks. A.J, *J.Polym.Sci. Polym.Chem.*, **1981**, 19, 1319
123. Morra. M, Occhiello. E and Garbassi. F, *Langmuir*, **1989**, 5, 872
124. Patil. R, Kim. S.J, Smith. E, Reneker. D.H and Weisenhorn. A.L, *Polym. Commun.*, **1990**, 31, 455.
125. Yang. A.C.M, Terris. B.D and Kunz. M, *Macromolecules*, **1991**, 24, 6800.
126. Annis. B.K, Noid. D.W, Sumpter. B.G, Reffner. J.R and Wunderlich. B, *Makromol. Chem. Rapid Commun.*, **1992**, 13, 169.
127. Collin. B, Chatenay. D, Coulon. G, Ausserre. D and Gallot. Y, *Macromolecules*, **1992**, 25, 1621.
128. ASTM Committee E-42, *Surface Interface Analysis*, **1988**, Vol. 11, p. 119.
129. Takahagi. T, Nakayama. Y, Soeda. F and Ishitani. A, *J. Appl. Polym. Sci.*, **1990**, 41, 1451.
130. Holmes-Farley. S.R, Bain. C.D and Whitesidec. G.M, *Langmuir*, **1988**, 4, 921.

131. Kato. Y, Fowkes. F.M, Vanderhoff. J.W, 'Surface Energetics of the Lithographic Printing Process', Ind. Eng. Chem. Prod. Res. Dev., **1982**, 21, 441
132. Noda. I, US Patent 4 735 843, **1988**
133. McIntyre. N. Stewart and Walzak. M. J, Modern Plastics International, **1995**, March, 69
134. Cross. E.M., McCarthy. T.J., Macromolecules, **1992**, 25, 2603.
135. Dias, A.J., McCarthy, T.J., Macromolecules, **1987**, 20, 2819.
136. Dias. A.J., McCarthy. T.J., Macromolecules, **1984**, 17, 2529.
137. Bening. R.C., McCarthy. T.J., Macromolecules, **1990**, 23, 2648.
138. Franchina. N.L., McCarthy. T.J., Macromolecules, **1991**, 24, 3045.
139. Bergbreiter. D. E and Gray. H. N, Macromolecules, **1995**, 28, 8307
140. Bergbreiter. D.E and Gray. H.N., Macromolecules, **1995**, 28, 8302.
141. Triolo. P.M and Andrade. D, Journal of Biomedical Materials Research, **1983**, 17, 129

are aimed at

with

response to

to

CHAPTER II

OBJECTIVES OF THE PRESENT INVESTIGATIONS

2.1 INTRODUCTION

Studies on surface modification of polymers are aimed at creating specific surface properties without affecting the bulk characteristics. Most synthetic polymers have an inert surface i.e they are not wetted with water, have poor adhesion to paints and low adsorption of dyes, paints, metal etc.¹⁻³ To improve these properties a number of methods to modify polymer surfaces have been developed such as gamma-rays, plasma, corona and photochemical modification. Surface properties can be monitored and controlled by proper selection of surface modification reaction. In applications where surface constitution of the polymer is important, novel strategies for modification according to the requirement is necessary. A reactive anchoring site on the surface of the polymer, capable of undergoing diverse chemical reaction is therefore very desirable. The bulk and surface properties of polymers have been successfully exploited to produce materials that have a wide range of application. Surface properties are more important compared to bulk for determining applications such as adhesion, wettability, printability.^{4,5} Thus, tailoring of surface properties of polymers has attracted considerable interest in recent years. However, the characterization of these polymers present special problems as the reaction takes place only upto a few angstrom level. A number of techniques have been used to characterize polymer surfaces, such as ATR FTIR, UV, contact angle, XPS, SEM, ESR, gravimetry etc.

The most common method of surface modification is by oxidation. Surface oxidation is mainly carried out by corona discharge or with an oxidising solution.⁶ One method that has been used to alter the surface properties of polymers is by photochemical grafting. The technique involves polymerization of vinyl monomers initiated by radical sites generated on solid polymer surfaces. The grafting of polymer chains onto a polymer surface can alter the surface properties of the substrate without affecting its bulk properties. Polyethylene itself has been photochemically grafted with a variety of hydrophilic vinylic monomers using solution and vapor phase techniques.^{7,8} The bulk modification of polyethylene with maleic anhydride has been exhaustively studied.⁹

The present investigation was undertaken with the purpose of introducing discrete, reactive anhydride functionality onto the surface of polyolefins, to study the transformation of the anhydride group to other chemical functionalities and examine the surface properties of such modified surfaces.

(a) Wettability is a property of a surface that is both theoretically and practically important. Wetting of solid surfaces by liquids, especially, water, plays an important role in various practical applications. One would sometimes like to reduce the wettability of solid surfaces such that they would repel liquids upon contact. On other occasions, however enhanced wettability to promote the spreading of liquids over a solid surface is desired. There are many applications where the simultaneous control of both wetting and nonwetting solid surfaces is required to accomplish a desired result. Thus, it is very desirable to prepare polymer surfaces with a graded range of hydrophilicities.

(b) Polymers undergo degradation and oxidation by a combination of oxygen, heat and UV light. Polymer degradation can be prevented by incorporating suitable stabilizer into the polymer. Generally a stabilizer is melt blended into the polymer.^{10,11} However, stabilizers are low molecular weight organic compounds which can be lost from the polymer by evaporation and migration.¹² Chemical attachment of stabilizer to the polymer molecule offers a solution to this problem.⁷ Hindered amine light stabilizer (HALS) based on tetra methyl piperidine compounds, are a class of efficient stabilizers which are widely used to protect polyolefins against photo and thermal oxidation.¹³ To improve the stability of polymer, surface functionalized polyolefins with anhydride group offers an interesting method to chemically attach HALS to the surface of polyolefins.

(c) Photoresponsive polymers have great potential for application in a wide variety of areas, including optical information storage and optical switching system.¹⁴ For use in photomemory system, materials containing azobenzene units are promising because these have dipole moments and optical parameters that are highly susceptible to change due to their reversible photoisomerization. previously, the photoisomerization of azobenzene linked to amorphous acrylic and liquid crystalline polymers have been well studied.¹⁵ However, photoisomerization of azo compounds bound to semicrystalline polymers such as polyolefins has not been reported in the literature. Therefore, we undertook a study of photochemical isomerization of azobenzene unit incorporated in semicrystalline polyolefin films.

(d) Physical and mechanical properties of plastics depend not only on the chemical structure of polymers but also on their surface topology. Surface treatment of polymers by oxidizing

solutions has been used by the electroplating industry to promote metal to polymer adhesion.¹⁶ High energy radiations can also cause deep seated changes in surface topology. For example, polyethers will degrade by chemical degradation of C-O-C linkage, by irradiation. The specimen in the electron microscope receives very large doses of radiation so that degradation does not stop with a fragment of reduced molecular weight. It continues until the fragments are small enough to volatilize in the vacuum environment of the microscope leaving the specimen with an altered surface. In extreme cases, there will be a loss of sufficient material to leave a hole or crack on the surface. In the present work a clean and simple surface etching technique of polyethylene film bearing azo or diazo group using various high energy irradiation has been studied.

2.2 Approaches:

2.2.1 Photochemical functionalization of polymer surface: Polyethylene surface bearing succinic anhydride group.

2.2.1.1 Polyethylene surface bearing succinic anhydride was synthesized using a mild photochemical reaction.

2.2.1.2 Surface selective functionalization was determined by angle dependent XPS study.

2.2.1.3 Concentration of surface functionality was determined by UV and gravimetry.

2.2.1.4 Effect of reaction conditions (time, concentration etc) on the surface reaction were studied.

2.2.2 Functional group transformation on succinic anhydride of polyethylene surface.

2.2.2.1 Monofunctionalization and difunctionalization of anhydride group were carried out through chemical transformation reaction.

2.2.2.2 Chemically modified polymer surfaces were characterized by surface analytical technique.

2.2.2.3 Effect of pH on surface ionization of dicarboxylic acid was studied.

2.2.2.4 The effect of chemical functionality, counter cation, spacer on surface wettability was studied.

2.2.3 Cis-trans isomerization of aromatic azo chromophores, bound to semicrystalline polymer.

2.2.3.1 Polyolefin films bearing azo compounds were prepared via chemical transformation reaction.

2.2.3.2 The rate of cis-trans isomerization were evaluated as a function of structure of chromophore, type of attachment, nature of polymer.

2.2.4 Surface etching of functionalization polyethylene film by electron or thermal energy.

2.2.4.1 Azo compound and diazonium salt were incorporated on to the polyethylene surface.

2.2.4.2 Surface etching of modified polyethylene film was performed by electron gun.

2.2.5 Surface anchored HALS for improved U.V stability of polyolefins.

2.2.5.1 HALS was incorporated on to the polyolefin surface.

2.2.5.2 Phostabilizing efficiency of polymer bound HALS in polyolefins was studied by SEPAP 12/24 photoirradiation chamber at 60°C.

2.3 REFERENCES

1. Whitesides. G. M, Ferguson. G.S, Chemtracts-organic Chemistry, **1988**, 1, 171 and reference cited there in.
2. Bergbreiter. D. E, "Chemically Modified Surfaces"; Mottola, H. A.; Steinmetz, J. R.; Eds.; Plenum Press, New York, **1992**, p 133-154.

3. Andrade. J. D, Gregonis. D. E, Smith. L. M, "Surface and Interfacial Aspects of Biomedical Polymers"; Andrade, J. D, Ed.; Plenum Press, New York, 1985, Vol.1, Chapter2.
4. Mumbauer. P. D, Carey. D. H and Ferguson. G. S, Chem. Mater., 1995, 7, 1303
5. Whitesides. G.M and Laibinis. P.E, Langmuir, 1990, 6, 87
6. Rasmussen. J. R, Stdronsky. E. R, Whitesides. G. M, J. Am. Chem. Soc., 1977, 99, 4757.
7. Ranby. B, Macromol chem. Macromol.Symp, 1992,65,55
8. Kubota. H, J.Appl.Polym.Sci., 1992,46,383
9. Gaylord. N.G, J.Macromol.Sci-Revs.Macromol.Chem., 1975,C13(2),235
10. Fertig. J, Goldberg. A, J.and Scoutchi. M, J. Appl. Polym. Sci., 1966, 10, 663.
11. Fertig. J, Goldberg. A. J and Scoutchi. M, J. Appl. Polym. Sci., 1965, 9, 903.
12. Luston. J, Developments in polymer stabilizer-2, Applied science publishers, London, 1980, p.185.
13. Ye. Y, Polymer Degdration and Stability, 1992, 37, 11
14. Irie. M., Adv.Polym.Sci, 1990, 94, 27.
15. Eich. M, Wendorff. J.H, Reck. B, Ringsdorf. H, Makromol.Chem.,Rapid Communication, 1987, 8, 467
16. Fitchmun. D.R, Newman. S, Wiggle. R, J.Appl.Polym.Sci., 1970, 14, 2457

CHAPTER III

SURFACE SELECTIVE FUNCTIONALIZATION OF POLYETHYLENE WITH SUCCINIC ANHYDRIDE

numbers 16 MN 50000
Chemical Corps
precipitated from meth
of 80 micron th
were subjected to extract

3.1 INTRODUCTION

Synthetic routes to chemically modified polymer surfaces with controllable structures continues to be an area of contemporary research, having both, theoretical and practical interest.¹ The objective is to devise mild techniques of primary surface functionalization with a high degree of chemo- and topological selectivity. Additionally, the primary functional groups on the surface should be capable of undergoing a variety of organic chemical transformations under mild conditions, thus enabling creation of novel secondary surface functionalities.

Chemically modified poly(ethylene) surfaces have attracted considerable attention.² Yet, there are few examples of chemical reaction on poly(ethylene) surfaces which satisfy the rigorous criteria of chemo- and topological selectivity. Surface chemical oxidation of poly(ethylene) leads to carboxylated poly(ethylene) surfaces (PE-(CO₂H)).³ This reaction has been imaginatively exploited for studying a bewildering variety of surface phenomena.⁴ However, the reaction is reported to be complex, ill defined and produces microscopically heterogeneous surfaces.^{1,5} Surface damage, such as, pitting and chain scission, are reported to accompany the oxidation reaction. Similarly vapor phase sulfonation of poly(ethylene) leads to surface impurities such as keto groups, PE-(OSO₃H) and polyene unsaturation.⁶

In this chapter, a mild photochemical technique is described for surface functionalization of poly(ethylene) (Scheme 1) which introduces a reactive succinic anhydride group on the surface of poly(ethylene). Various conditions affecting the surface selectivity of the reaction was studied. Although photochemical grafting of reactive monomers such as glycidyl acrylate, glycidyl methacrylate, acrylonitrile, acrylic acid, methacrylic acid etc. is well known,^{7a,b,c} the use of this technique for introducing a reactive functional group on the surface of the polymer is unprecedented in the literature.

3.2 EXPERIMENTAL

3.2.1 Materials

Low density poly(ethylene) (Indothene 16 MA 400, density = 0.916 g/cc, MFI=40 g/min) was obtained from Indian Petrochemical Corporation Limited, Baroda, India. It was refluxed in xylene for 2 h and reprecipitated from methanol to remove antioxidants and other additives. Poly(ethylene) films of 80 micron thickness were prepared by melt pressing in a hydraulic press. The films were subjected to extraction by hot acetone for 8 h and dried

in vacuum at 30°C for 8 h. The additive free film were stored under N₂ atmosphere. Maleic anhydride (E. Merck, India Ltd) was recrystallized from chloroform and stored under dry condition. Benzophenone (Aldrich Chemicals, USA) was recrystallized from ethanol. Maleic anhydride grafted poly(propylene) (Profax LD 5017) was obtained as a gift sample from Himont, USA

3.2.2 Methods

3.2.2.1 Sample preparation and conditioning

Low density polyethylene was dissolved in xylene and refluxed for 2 h followed by precipitation from n-hexane. The polymer was filtered and dried in vacuo at 50°C. The polymer was stored under nitrogen. The purified polymer was pressed into a thin film of (80-100 μm) by using a Carver press at 130°C. The polymer powder was placed between two layers of PET films which were also placed between two aluminum sheets. A pressure (2000 pound) was applied. The film was soxhlet extracted in chloroform for 4 h. The film was then dried in vacuo at 40°C for 4 h. These films were then preserved under nitrogen blanket.

The contact angle were measured after conditioning the films in a constant humidity chambers containing a saturated solution of Na₂SO₄ for 24 h.

3.2.2.2 Poly(ethylene) surface bearing succinic anhydride group (1)

Poly(ethylene) film (5x5 cm² area) was suspended in a small glass reactor. A beaker containing 25 mL solution of maleic anhydride (4.9 g) and benzophenone (0.9 g) in dry acetone was placed along side. The reactor was purged with nitrogen for 20 min to remove any oxygen present. The reactor was placed in a UV chamber equipped with an electrical heating arrangement. Prior to start of UV irradiation the temperature of the reactor was raised to 60°C for 2 h to saturate the environment around the film with vapors of maleic anhydride and benzophenone. Subsequently, the film was irradiated for 3 minutes and 6 minutes using a 400 W high pressure mercury vapor lamp, which emitted light in the near UV region ($\lambda > 290\text{nm}$). The distance between the reactor and UV lamp was 18 cm.(Figure 3.1). The reaction was presumed to occur equally on both sides of the free standing film since the monomer and sensitizer were in the vapor phase surrounding the film. The modified poly(ethylene) thus produced was soxhlet extracted with acetone for 8 h, dried under vacuum at 30°C and stored under N₂ atmosphere. Irradiation under similar conditions,

but for extended period of time (upto 8 h) gave greater depths of penetration of the functional group (vide infra).

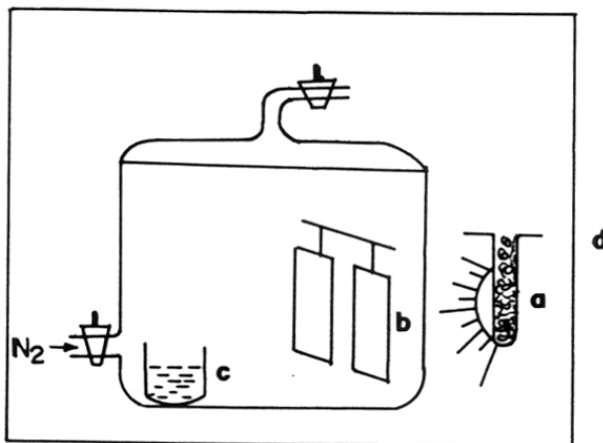
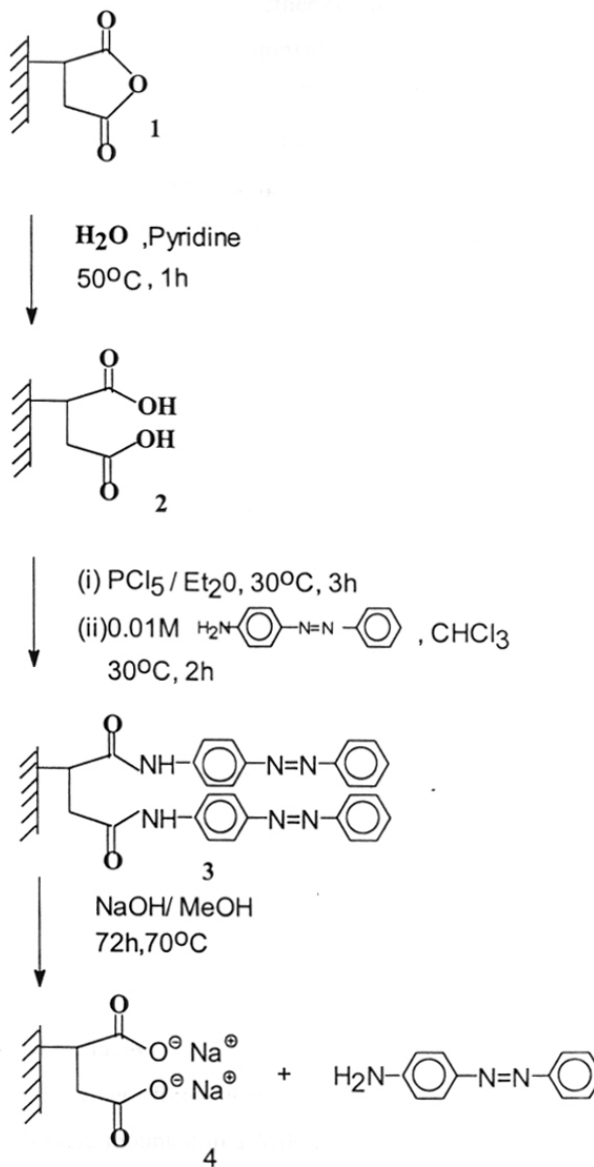

Figure 3.1: Sketch of reactor: (a) UV lamp (b) polymer film (c) reacting solution (d) heating chamber

3.2.2.3 Poly(ethylene) surface bearing succinic acid group (2)

The film 1 was placed in water, containing 2 wt% pyridine. The water was heated to 50°C for 1 h. The film was then rinsed with water and dried at 30°C for 4 h.



Scheme 3.1: Chemical transformation reaction on poly(ethylene) surface and used for quantitative estimation of surface functional group on polyethylene

3.2.2.4 Reaction of poly(ethylene) surface bearing succinic acid with 4-aminoazobenzene (3)

The film 2 was placed in 10 mL of dry diethylether containing 2 g of PCl5 at 30°C for 3 h. The film was removed and immersed immediately in a 0.01M solution of 4-aminoazobenzene in chloroform for 2 h at 30°C. The film was rinsed with chloroform and soxhlet extracted with acetone for 4 h and dried under vacuum at 30°C for 4 h.

3.2.2.5 Estimation of surface functional group concentration

A sample of film 3 (1x1 cm²) was placed in an ampoule containing 1 mL of 1N methanolic NaOH solution, and sealed. The ampoule was heated for 72 h at 70°C. After cooling, the methanolic solution was transferred to a 10 ml volumetric flask and made up to the mark. After additional dilution, the UV absorbance of the solution was measured at 382 nm. Using a calibration curve of concentration of 4-aminoazobenzene vs absorbance, the concentration of 4-aminoazobenzene in the unknown solution was calculated. The surface functionality was calculated using the following relationship:

$$\text{Surface functionality (molecules/cm}^2\text{)} = \frac{[C] \times N \times V}{1000 \times A \times (2 \times 2)} \quad \text{eq1}$$

Where [C] = Concentration of unknown solution obtained from calibration curve (no of moles present in 1000mL of unknown solution); N = Avogadro Number(molecules/mole); V = Volume of the analyte solution (mL); A = Area of the film (cm²); The factor (2 X 2) arises because 4-amino azobenzene reacts with both the sides of the film and two equivalent reacts with the one equivalent of succinic acid chloride.

3.2.3 Characterization of surfaces

ATR-FTIR spectra of polymer films were recorded on a Perkin Elmer 16 PC spectrophotometer. Films were mounted in a MIR-2 stainless steel sample holder with thin rubber pads placed between the holder and film to improve the contact between the sample and the KRS-5 reflection element. The ATR cell was aligned at a 45°C angle. UV spectroscopy was performed on a Hewlett Packard 8452 A Diode Array spectrophotometer. X-ray photoelectron spectroscopy (XPS) studies were carried out using a VG Scientific ESCA-3-MK-II electron spectrometer fitted with a Mg K ∞ (1253.6eV) X-ray source (non-monochromatic). The anode was operated at 120 W (12kV, 10 mA), and the analyzer was

operated at a constant pass energy of 50eV. All spectra were recorded with similar spectrometric parameters. The binding energy (BE) scale was calibrated by determining the BE of Au(4f_{7/2}) (84eV) and Cu(2p_{3/2}) (932.4eV) levels using spectroscopically pure metals obtained from Johnson-Matthey, London. The binding energy values (measured to an accuracy of +0.2eV) are in good agreement with literature values.⁸ The resolutions in terms of full width at half- maximum(fwhm) of the Au(4f_{7/2}) level is 1.6eV. The films were mounted on a stainless steel holder with double sided adhesive tape. The peak shift due to surface charging was corrected using the C(1s) level at 285eV as an internal standard. In all the cases C(1s), O(1s) levels were recorded. Elemental concentrations were calculated using the XPS peak areas and the corresponding photoelectron cross sections.⁹ The XPS peaks were assumed to have Gaussian line shape and were resolved into individual component after proper subtraction of base line using the Shirley background subtraction method.⁹ The downhill-simplex method was used to minimize the fitting errors. The line width was allowed to vary in the range 2.0-2.4eV to obtain a good fit. Contact angle was determined on a NRL Contact Angle Goniometer 100-00,230. The samples were conditioned for 24 h prior to measurements in a constant humidity chamber containing a saturated solution of Na₂SO₄. The advancing contact angle of water on poly(ethylene) film (3x1 cm²) surface was measured by 'sessile drop' method at room temperature (30±2°C). Reported contact angle values are average of at least 10 readings and are accurate to within ± 2°. Samples were weighed on a Mettler-M5 microbalance with an accuracy of ± 0.005 mg for gravimetric analysis.

3.3 RESULTS AND DISCUSSION

Succinic anhydride groups were introduced on the surface of polyethylene films by a mild photochemical process. The effect of different reaction conditions on the modification reaction was studied. The surface selectivity of the reaction was established by surface analytical techniques.

3.3.1 Control experiments

The surface functionalization of polyethylene by maleic anhydride in presence of benzophenone as a sensitizer and acetone was proved by performing the following control experiments:

The reaction as mentioned in method 3.2.2.2 was carried out in the absence of UV light for 5 h. The film was characterized by ATR-FTIR which showed no new peak (Figure 3.2 a,b). Further there is no change in the contact angle. This proves that no new functional groups are formed on the absence of light.

The reaction mentioned in method 3.2.2.2 was carried out in absence of maleic anhydride for 5 h but in presence of UV light. The film was characterized by ATR-FTIR and contact angle measurement. No new peaks were observed in the ATR-FTIR (Figure 3.2c) and no change of contact angle was also observed. This establishes that under conditions of experiments there is no UV induced changes on the polymer surface.

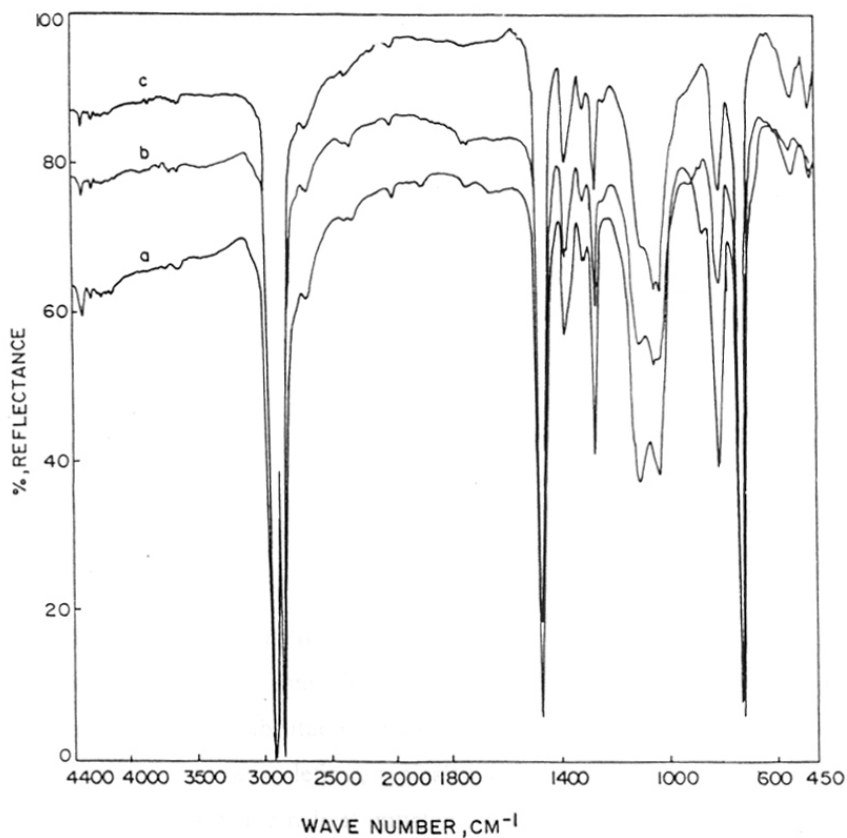

Figure 3.2: ATR-IR spectra of film a: film as such prepared, b: film after exposure to MA, C: film after exposure to UV

3.3.2 Proof of surface functionality

Irradiation of poly(ethylene) film in presence of acetone vapors containing 2M maleic anhydride and 0.2M benzophenone gave a modified film **1** (Scheme 3.1) which showed two sharp peaks at 1789 and 1868 cm^{-1} in the ATR-FTIR spectrum, characteristic of the cyclic anhydride group¹⁰ (Figure 3.3). The film **1** showed no absorption in the transmission IR mode. Upon hydrolysis **1** was transformed into **2**, as indicated by loss of cyclic anhydride group and appearance of a new peak at 1715 cm^{-1} characteristic of the carboxylic acid group (Scheme 3.1, Figure 3.3).

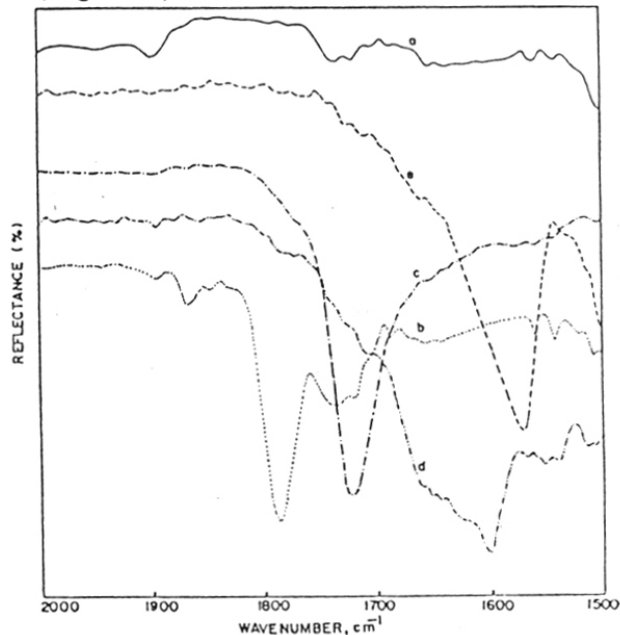

Figure 3.3: ATR-IR spectra of functionalized polyethylene surfaces (a) polyethylene, (b) 1, (c) 2, (d) 3, (e) 4

3.3.3 Evidence against photografting

It is well known that maleic anhydride does not homopolymerize easily due to steric hindrance imposed by 1,2 disubstitution of the double bond.¹¹ Maleic anhydride undergoes graft polymerization onto poly(olefins), typically at temperature above 120 °C, in melt phase and in presence of a free radical initiator.¹² Careful analysis of the composition of maleic anhydride grafted onto poly(olefin) has identified both succinic anhydride groups and low molecular weight oligomers of poly(maleic anhydride) in the polymer.¹³

To unequivocally establish that, under the reaction conditions used in the present study, the functional group on the surface was predominantly the succinic anhydride group, the ATR-IR spectra of film **1** was compared with that of a commercial sample of melt functionalized maleated poly(propylene) (Profax LD5017 from Himont, USA) (Figure 3.4).

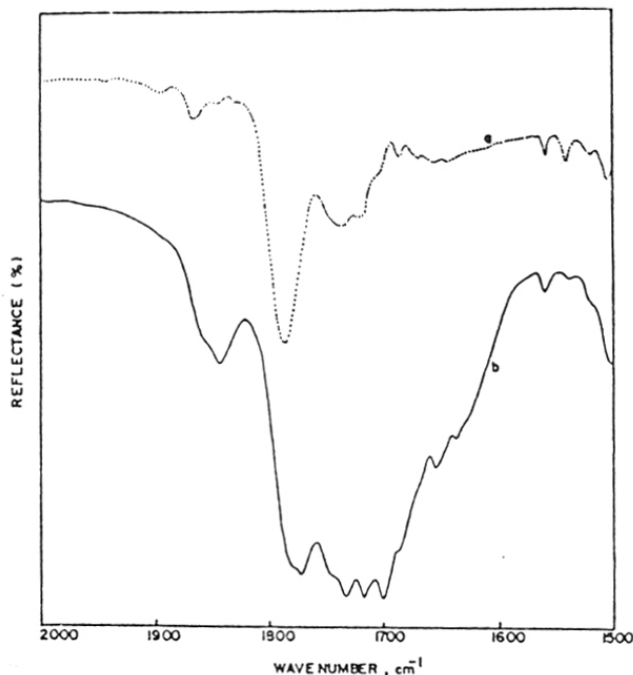

Figure 3.4: ATR-FTIR spectra of film (a) **1, (b) Commercial sample of melt functionalized maleated polyethylene**

Film **1** showed a sharp peak at 1789 cm^{-1} whereas the commercial grafted poly(propylene) showed a broad absorption in $1775\text{ to }1697\text{ cm}^{-1}$ region indicative of a range of functionalities (anhydride, acid, ketones etc.). The position as well as the symmetric shape of the cyclic anhydride peak seem to indicate that no substantial grafting reaction leading to poly(maleic anhydride) has occurred on the surface.

3.3.4 Concentration of functional group

The anhydride linkage of **1** can readily be hydrolyzed to succinic acid by heating in water (Scheme 3.1). The ATR-IR spectrum showed complete disappearance of the anhydride peak and the emergence of a new absorption band at 1715 cm^{-1} , characteristic of the carboxylic acid. The ATR-IR of **3** showed the characteristic amide and aromatic absorption at $1658\text{--}1600\text{ cm}^{-1}$ (broad peak, Figure 3.3) and showed complete disappearance of acid peak which represent complete conversion from **2** to **3**. The absence of a peak at 1780 cm^{-1} confirmed

that no imide formation has occurred. The surface concentration of the anhydride group was estimated by converting **1** to **3** (Scheme 3.1), followed by alkaline hydrolysis of **3** to liberate 4-aminoazobenzene. The characteristic peaks due to **3** disappeared upon hydrolysis resulting in a new sharp peak at 1566 cm^{-1} indicative of the carboxylate anion (**4**, Scheme 3.1, Figure 3.3). From the disappearance of the amide peak, it can be assumed that the hydrolysis is quantitative. The quantity of 4-aminoazobenzene liberated upon hydrolysis of **3** was estimated by measuring the absorption at 382 nm. Using an appropriate calibration curve (Figure 3.5), the concentration of 4-aminoazobenzene was determined and by putting this concentration in equation 1, the surface functionality of the film was obtained as:

$$\text{Surface functionality (molecules/cm}^2\text{)} = \frac{7.7 \times 10^{-7} \cdot 6.023 \times 10^{23} \cdot 10}{1000 \cdot (1 \times 1) \cdot (2 \times 2)} = 1.17 \times 10^{15}$$

(3 min. irradiated sample)

Similarly for 6 min. irradiated sample surface functionality obtained 1.24×10^{15} molecules/cm². If one assumes that conversion of **1** to **3** as well as its hydrolysis is quantitative, then one can infer that $\sim 1.2 \times 10^{15}$ molecules/cm² of succinic anhydride is initially present on the poly(ethylene) surface. These results indicate a surface selective functionalization.

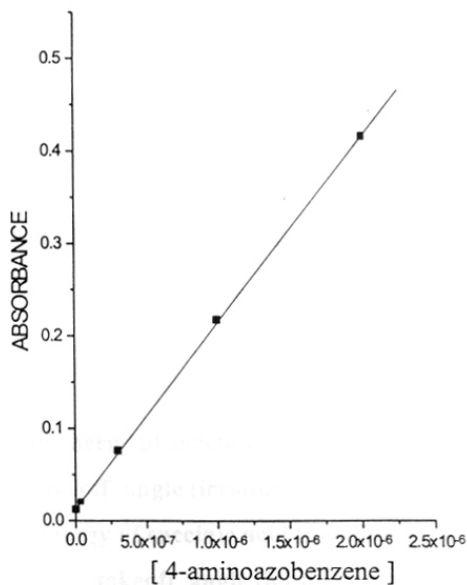

Figure 3.5: Calibration curve for 4-aminoazobenzene estimated by UV at $\lambda_{\text{max}}=385$ nm

3.3.5 Proof of surface selectivity

To confirm the surface selectivity of the functionalization reaction, film **2** was subjected to XPS analysis. XPS showed peaks at 285 eV and 289 eV corresponding to the C_{1s} binding energy of the C-H and O=C-O carbons (Figure 3.6).

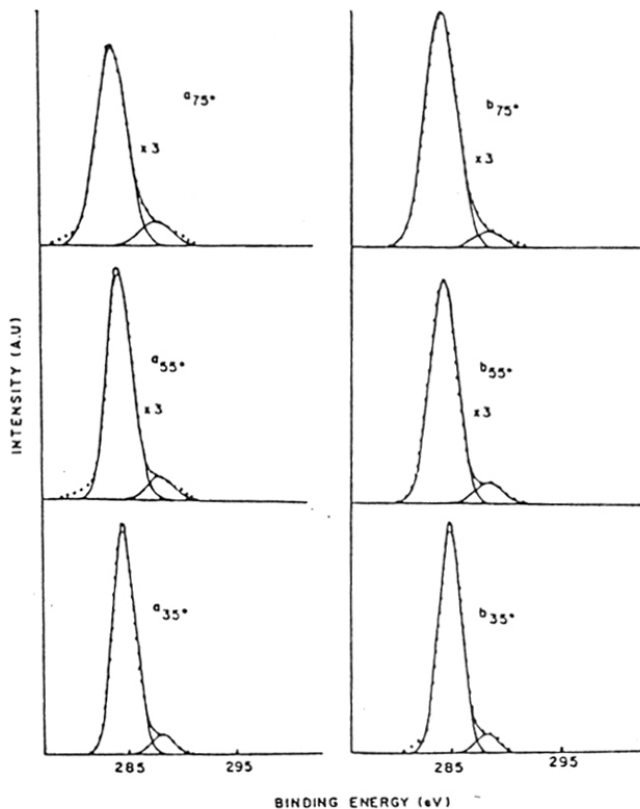

Figure 3.6: (a) C_{1s} binding energy of succinic acid modified polyethylene at 35°, 55°, 75° takeoff angle (irradiation time: 3min)

(b) C_{1s} binding energy of succinic acid modified polyethylene at 35°, 55°, 75° takeoff angle (irradiation time: 6min)

An angular dependent XPS measurement at take off angles $\theta = 75^\circ$, 55° and 35° showed that the intensity ratio of O_{1s}/C_{total} and C_{289}/C_{total} decreases with increasing take off angle (Table3.1).

Table 3.1: Atomic ratios of carbon and oxygen of succinic acid modified poly(ethylene) film 2

| Takeoff angle (θ°) | Atomic ratio | | | [O/C:C ₂ /C:C ₁ /C] ^a |
|-------------------------------------|--------------------------------------|---|---|--|
| | $\frac{O_{1s}}{C_{1s285}+C_{1s289}}$ | $\frac{C_{1s289}}{C_{1s285}+C_{1s289}}$ | $\frac{C_{1s285}}{C_{1s285}+C_{1s289}}$ | |
| Blank sample 60 | 0.02 | 0.00 | 1.00 | 4.0:0:200 |
| (A) 3 min reaction 75 | 0.140 | 0.078 | 0.921 | 4.0:2.22:26.31 |
| 55 | 0.153 | 0.088 | 0.911 | 4.0:2.30:23.81 |
| 35 | 0.157 | 0.103 | 0.896 | 4.0:2.62:22.82 |
| (B) 6 min reaction 75 | 0.140 | 0.067 | 0.932 | 4.0:1.91:26.62 |
| 55 | 0.160 | 0.090 | 0.909 | 4.0:2.25:22.72 |
| 35 | 0.168 | 0.106 | 0.893 | 4.0:2.52:21.26 |

$$^a C = C_{1s285} + C_{1s289}, C_1 = C_{1s285}, C_2 = C_{1s289}$$

The XPS intensity of the ratios of peaks due to O_{1s}/C_{total} and C_{289}/C_{total} showed angular dependence, indicating that functionalization had occurred within the depth of detection of XPS ($\sim 45 \text{ \AA}$). Assuming that reaction completed within 45 \AA (75°) and putting the average ratio of $C_{289}/O_{531.4}$ (35° , 55° , 75°) on the standard equation, $I = K(1 - e^{-d/\lambda \sin \theta})$ where I is the intensity of the signal; K encompasses the number average of atoms sampled, ionization cross section, instrumental transmission etc.; d is the depth; λ is the mean free paths for photo emitted electrons of kinetic energy 970 eV (C1s) and 720 eV (O1s) of 14 \AA and 10 \AA respectively, the reaction depth were estimated as follows:

$$I_c/I_o(\text{average area ratio}) = (I_c^{75^\circ}/I_o^{75^\circ} + I_c^{55^\circ}/I_o^{55^\circ} + I_c^{35^\circ}/I_o^{35^\circ})/3 = (0.557 + 0.575 + 0.656)/3 = 0.596$$

$$(1 - e^{-d/14\sin 75^\circ}) \quad (1 - e^{-d/14\sin 75^\circ})$$

but $I_c/I_o = \frac{\dots}{(1 - e^{-d/10\sin 75^\circ})}$; so $\ln I_c/I_o = \ln \frac{\dots}{(1 - e^{-d/10\sin 75^\circ})}$

$$(1 - e^{-d/10\sin 75^\circ}) \quad (1 - e^{-d/10\sin 75^\circ})$$

Therefore, $d = 18 \text{ \AA}$ for 3 min. irradiated sample, similarly for 6 min. irradiated sample reaction depth obtained 20 \AA .

The results indicate a reaction depth of approximately $18\text{--}20 \text{ \AA}$ for 3 to 6 min reaction. The surface elemental analysis (Table 3.1) further confirm the presence of dicarboxylic groups on the surface.

3.3.6 Effect of reaction conditions on the surface modification reaction

3.3.6.1 Reaction time

The transmission FT-IR spectrum of the poly(ethylene) film at different periods of irradiation is shown in Figure 3.7

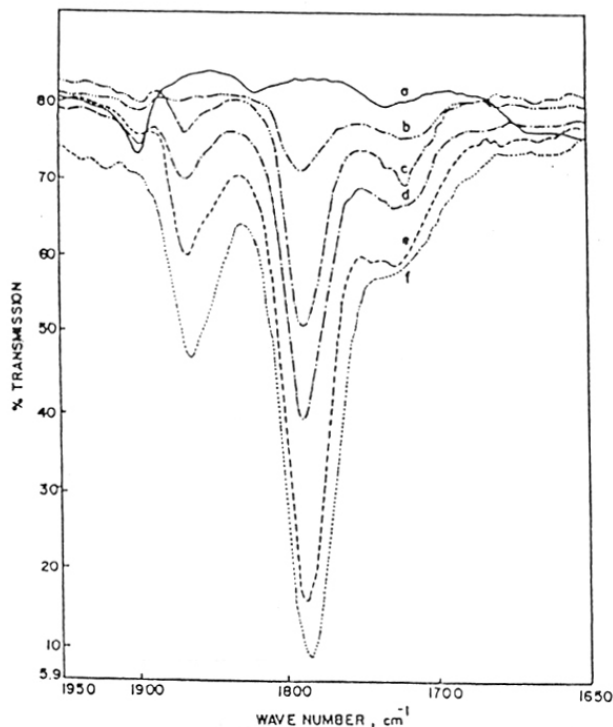

Figure 3.7 Transmission FTIR spectra of modified polyethylene films at various reaction time (a) 0 h, (b) 1 h (c) 2 h (d) 3 h (e) 5 h and (f) 8 h

The film shows sharp peaks at 1868 and 1789 cm^{-1} , characteristic of cyclic anhydride groups, the intensity of which increases with irradiation time. This is also shown by a plot of the ratio of peak areas at 1789 cm^{-1} and 1465 cm^{-1} (CH_2 deformation) which increases with irradiation time (Figure 3.8).

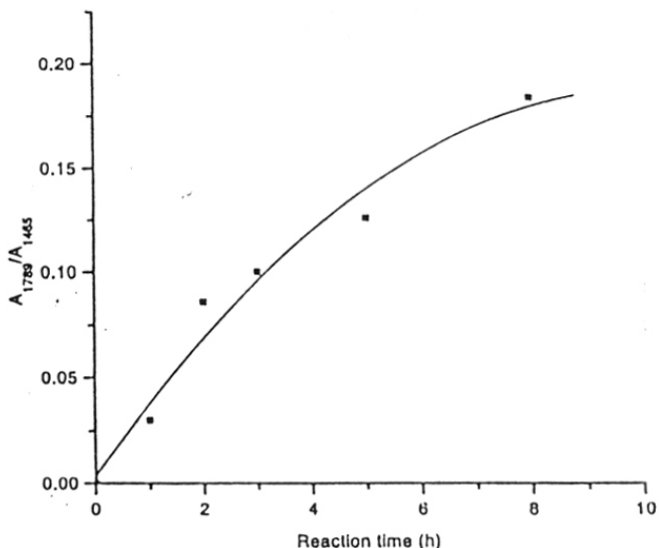

Figure 3.8: Change in the ratio of anhydride: carbon peak area (area 1789 cm^{-1} /area 1465 cm^{-1}) with reaction time

Gravimetric analysis indicated a monotonic weight gain with increasing irradiation time (Table 3.2) implying greater concentration of functional groups.

Table 3.2: Weight of poly(ethylene) film upon irradiation of UV light in presence of maleic anhydride

| Irradiation time (h) | Initial film weight (mg) | Weight gain (mg) |
|----------------------|--------------------------|------------------|
| 1 | 26.785 | 0.155 |
| 2 | 22.490 | 0.180 |
| 3 | 20.490 | 0.210 |
| 5 | 20.740 | 0.255 |
| 8 | 27.170 | 0.410 |

The X-ray photoelectron spectra of modified film 1 showed two C_{1s} binding energy peaks at 285 and 289eV due to C-H and O=C-O carbons and a peak at 531.4eV (O_{1s}) whose area increases with irradiation time. Quantitative surface elemental analysis was performed on 2

using XPS by measurement of areas corresponding to C_{1s} and O_{1s} peaks corrected for respective photoionization cross sections. The spectrum of modified sample exhibit well developed tail to higher binding energy. The peak area at 289.0eV (C_{1s}) and 531.4eV (O_{1s}) increase gradually with the progress of reaction (Table 3.3).

Table 3.3: Atomic ratios of carbon and oxygen of succinic acid modified poly(ethylene) film

| Reaction time(h) | Takeoff angle (θ°) | Atomic ratio | | | [O/C: C_2 /C: C_1 /C] ^a |
|------------------|----------------------------------|--------------------------------------|---|---|--|
| | | $\frac{O_{1s}}{C_{1s285}+C_{1s289}}$ | $\frac{C_{1s289}}{C_{1s285}+C_{1s289}}$ | $\frac{C_{1s285}}{C_{1s285}+C_{1s289}}$ | |
| 1 | 60 | 0.138 | 0.057 | 0.943 | 4.0:1.65:27.30 |
| | 40 | 0.118 | 0.053 | 0.946 | 4.0:1.79:32.00 |
| 2 | 60 | 0.145 | 0.070 | 0.929 | 4.0:1.92:25.60 |
| | 40 | 0.125 | 0.057 | 0.942 | 4.0:1.82:30.00 |
| 3 | 60 | 0.169 | 0.077 | 0.922 | 4.0:1.82:21.80 |
| | 40 | 0.152 | 0.062 | 0.937 | 4.0:1.64:24.60 |
| 5 | 60 | 0.187 | 0.090 | 0.909 | 4.0:1.92:19.40 |
| | 40 | 0.186 | 0.069 | 0.930 | 4.0:1.48:20.00 |
| 8 | 60 | 0.224 | 0.123 | 0.877 | 4.0:2.20:15.60 |
| | 40 | 0.196 | 0.081 | 0.919 | 4.0:1.65:18.80 |

^a $C=C_{1s285}+C_{1s289}$, $C_1=C_{1s285}$, $C_2=C_{1s289}$

It is clear from Table 3.3 that the extent of reaction increases with time since the atomic ratio of carboxylic carbon and oxygen to that of total carbon increases with time. This suggest that with the increase in reaction time, the polymer becomes more densely functionalized. The XPS intensity of the ratios of peaks due to O_{1s}/C_{total} and C_{289}/C_{total} did not show any angular dependence, indicating that functionalization had occurred beyond the depth of detection of XPS ($\sim 40 \text{ \AA}$).

3.3.6.2 Concentration of maleic anhydride and benzophenone

The photochemical reaction was performed at different concentration of maleic anhydride and benzophenone at a fixed time i.e 2 h and 70°C (Table 3.4).

Table 3.4. Effect of maleic anhydride and benzophenone concentration

| Maleic anhydride (M) | Benzophenone (M) | Peak area ratio of 1789 and 1465 cm^{-1} | Weight gain (mg) |
|----------------------|------------------|---|------------------|
| 0.1 | 0.01 | 0.088 | 0.178 |
| 0.25 | 0.025 | 0.075 | 0.160 |
| 0.5 | 0.05 | 0.091 | 0.185 |
| 1.0 | 0.10 | 0.084 | 0.175 |
| 2.0 | 0.20 | 0.089 | 0.180 |
| 3.0 | 0.30 | 0.118 | 0.260 |
| 3.5 | 0.35 | 0.120 | 0.264 |
| 4.0 | 0.40 | 0.116 | 0.255 |

From Table 3.4 it can be observed that as the concentration of MA and BP increases from 0.1M to 2M and 0.01M to 0.2M respectively there is no appreciable increase in anhydride concentration. Using 3 M of MA and 0.3 M of BP causes the anhydride concentration to increase.

The reaction was also performed by keeping MA concentration constant i.e 3M and decreasing concentration of BP from 0.2M to 0.01M. It was found the concentration of anhydride is decreases from value 0.118 (area ratio) to ~ 0.083. Similar behavior was shown when the concentration of MA was decreased from 2M to 0.1M keeping the BP

concentration constant i.e 0.3M. It can be thus concluded that 3M MA and 0.3M BP is the most suitable concentration for this reaction.

3.3.6.3 Nature of the diluent

The reaction rate on polymer surface and the properties of modified surface are strongly related to the nature of the diluent. A good diluent for surface reaction must satisfy many requirements. The diluent must be a nonsolvent for the base polymer. To confine the reaction to the surface, the diluent must not swell the base polymer excessively; however, some interactions between the diluent and the base polymer is necessary to provide sites for chemical reaction. The effect of nature of diluent on the surface reaction of MA is summarized in Table 3.5.

Table 3.5. Summary of solvent effects on surface photografting

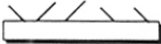
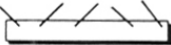
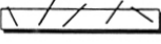
| Solvent | Solvent-polymer interaction | BP-solvent interaction | Surface concentration of grafted polyacrylamide | Rate of grafting | Proposed structure of grafted film |
|------------------------------------|-----------------------------|------------------------|---|------------------|--|
| Acetone-water | Small | No | High-medium | Slow-medium |  |
| Acetone-CH ₃ CN | Moderate | No | High-medium | Fast |  |
| Tetrahydrofuran-CH ₃ CN | Strong | Yes | Low | Slow-medium |  |

It is advantageous for the graft chains to be soluble in the diluent, to facilitate their propagation outside the polymer surface.

The diluent must be inert to the triplet excited state of the photosensitizer or photoinitiator. This is particularly important for base polymers that are not very susceptible to radical attack. If the diluent is more reactive to the excited state of the photoinitiator than the

substrate polymer, grafting can be inhibited. Tazuke and Kimura showed that methanol could be used as the diluent when poly(vinyl chloride), poly(vinylidene chloride) and cellulose triacetate, which are easily attacked by radicals were the substrates and benzophenone was the initiator.¹⁴ However, when the same diluent was used for the grafting of acrylamide onto poly(ethylene) and poly(propylene), only homopolymer of acrylamide was obtained because methanol reacts with the triplet state of benzophenone.

The photochemical reaction on poly(ethylene) was performed at different diluent at a fixed reaction condition i.e 2 h and 70°C; 2M maleic anhydride and 0.2M benzophenone (Table 3.6).

Table 3.6: Effect of diluent on surface reaction

| Diluent | Initial film weight (mg) | Weight gain (mg) |
|-----------------|--------------------------|------------------|
| Acetone | 21.540 | 0.180 |
| Tetrahydrofuran | 22.170 | 0.140 |
| Chloroform | 20.470 | 0.135 |
| Benzene | 23.875 | 0.085 |

From Table 3.6 it can be observed that the acetone is most effective for this reaction. Acetone, which is more stable towards hydrogen abstraction by the triplet state of benzophenone, is preferred as the diluent for surface grafting onto polymers, such as poly(ethylene) and poly(propylene). It also functions as an initiator. For example, after absorbing UV light an excited acetone molecule can split to form a methyl radical or abstract a hydrogen atom from a nearby molecule. In general hydrogen donor diluents are superior to diluents which cannot donate hydrogen.

3.3.7 Contact angle hysteresis

If the surface of a solid is smooth, chemically homogeneous and rigid, the contact angle formed by the tangential plane to the liquid with the plane of the solid is the equilibrium contact angle θ . On a practical surface, addition of liquid will not cause the liquid front to advance, but it will increase the height of the liquid is added, a sudden advance will be observed. The angle at the onset of this sudden advance is the advancing contact angle θ_a ,

which is the maximum observed value. Subtraction of the liquid will not cause the liquid to recede but it will decrease the height of the liquid drop and the contact angle. When enough liquid is subtracted from the drop, a sudden retraction will occur. The angle at the onset of this sudden retraction is the receding angle θ_r , which is the minimum observed value. The difference between θ_a and θ_r is referred to as contact angle hysteresis, which may be classified as thermodynamic or kinetic.

Table 3.7: Advancing and receding contact angle of PE bearing succinic anhydride group

| Reaction Time (h) | Advancing contact angle ($\theta_a \pm 2^\circ$) | Receding contact angle ($\theta_r \pm 2^\circ$) | Hysteresis value |
|-------------------|--|---|------------------|
| 1 | 87 | 60 | 27 |
| 2 | 85 | 55 | 30 |
| 3 | 82 | 51 | 31 |
| 5 | 80 | 50 | 30 |
| 8 | 80 | 50 | 30 |

It is seen that the hysteresis value of all the samples are more or less similar.

3.3.8 Surface reconstruction of dicarboxylic acid modified polyethylene surfaces

Surface reorganization of dicarboxylic acid onto the polyethylene surface was studied under different conditions.

3.3.8.1 Effect of heating

Wettability of functionalized polymer surface can be controlled by heat treatment. Rate of migration of functional group depends on the structure and size of functionalized group. The general behavior of functionalized polymers is to undergo reorganization to produce less polar surfaces. Several factors are responsible for this behavior and has been discussed by Whitesides.¹⁵ The energetically favorable change to a lower surface free energy at a vacuum/polymer interfaces is the dominant factor responsible for reconstruction of high energy functionalized polymer surfaces. However, other factors such as the nature of substrate polymer, entropy and the identity of the reorganizing functional groups could affect the overall energy change and the outcome of any annealing experiment. The thermal

reconstruction of the interface of PE-COOH have been studied by subjecting the surfaces to controlled temperature under vacuum for various intervals of time.¹⁶ Heating of any carboxylated film in a vacuum oven at 70°C produced an annealed film, the hydrophilicity of which varied with annealing time. The advancing contact angle (θ_a) changed from 74° to 100° over a 1 h period. The succinic acid modified poly(ethylene) prepared in the present study was also subjected to heat treatment to examine thermal reconstruction effects (Table 3.8).

Table 3.8: Water contact angle of PE film bearing succinic acid before and after thermal treatment

|  | Initial $\theta_a \pm 2^\circ$ | $\theta_a \pm 2^\circ$ (30 min heating) at 90°C/10 mm Hg | $\theta_a \pm 2^\circ$ (60 min heating) at 90°C/10 mm Hg |
|---|-----------------------------------|---|---|
| | | 80 | 95 |

Table 3.8 shows the change in the contact angle of water on **2** (5 h irradiated sample) as a function of heating time. The migration of functional groups away from the interface appears to be dominated by minimization of the interfacial free energy.¹⁶ From the Table 3.8 it is observed that the migration of functional group was complete within 30 minutes. Contact angle data showed that no major changes occurred after 30 mins annealing. From XPS it was found that the ratio $O_{531.4}/C_{total}$ of **2** decrease to 25% ($O_{531.4}/C_{total}$, 0.29→0.22) (36Å) after 60 minutes heating. This is similar to a value of 30% decrease observed in the case of PE-COOH after 60 minutes of heating under vacuum.¹⁶

3.3.8.2 Effect of time

The advancing contact angle (θ_a) of **1** was 90° and 88° whereas that of **2** was 85° and 83° for 3 min and 6 min reaction respectively. The lowering of the contact angle is indicative of the more hydrophilic surfaces of **1** and **2** relative to unmodified poly(ethylene) ($\theta_a=105^\circ$). The modified surface showed extended stability with no evidence of surface reconstruction. The θ_a measured after a period of 4 days and 7 days was 83° and 86° for film **2** (scheme 1, 6 min sample). Such extended stability of surface functional groups may be a reflection of the semicrystalline nature of the polymer with restricted chain mobility at ambient temperature.

3.3.9 Reaction mechanism

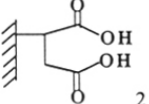
A plausible mechanism for the surface functionalization reaction is shown in Scheme 2. The reaction is initiated by the photoexcited triplet state of the benzophenone which abstracts a hydrogen atom from the surface of the poly(ethylene) creating a surface radical.^{17,18} The surface radical then adds to maleic anhydride generating a new carbon centered radical, α to the carbonyl group. The reaction is presumably terminated by a hydrogen transfer reaction from the diluent. Both the mild reaction conditions and the presence of an excess hydrogen donor solvent (acetone) ensures that further polymerization of the maleic anhydride to poly(maleic anhydride) does not occur on the surface.

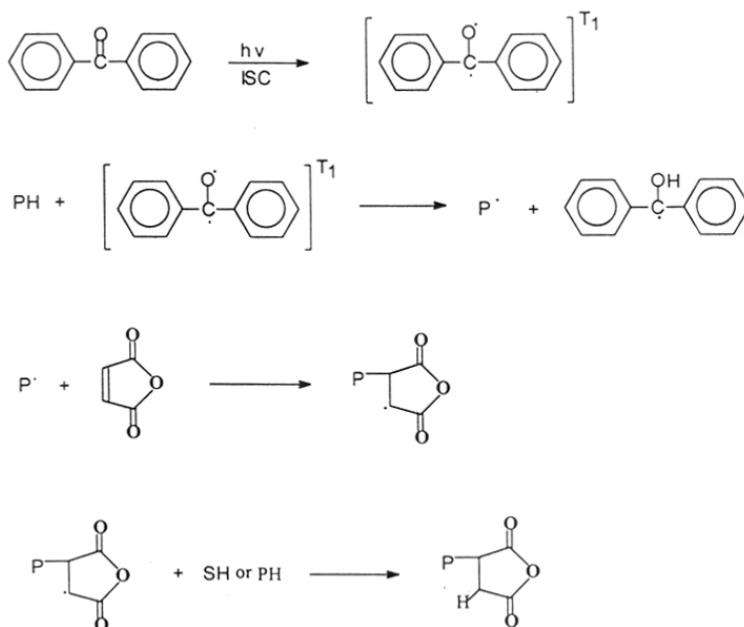

Scheme 3.2: Plausible mechanism of functionalization on poly(ethylene).
PH: polymer, SH: diluent

3.4 CONCLUSION

A mild surface selective functionalization of poly(ethylene) with succinic anhydride has been achieved. The surface functionality has been characterized by XPS, ATR-FTIR, contact angle and UV-visible spectroscopy. The result shows that the surface concentration of succinic anhydride group is $\sim 1.2 \times 10^{15}$ molecules/cm² with ~ 18 - 20 \AA depth. The reactive succinic anhydride group provides a convenient functionality for further attachment of a wide variety of other functional groups onto the poly(ethylene) surface.

3.5 REFERENCES

1. Whitesides. G. M, Ferguson. G. S, Chemtracts-Organic Chemistry, **1988**, 1, 171.
2. Bergbreiter. D. E, Prog. Polym. Sci., **1994**, 19, 529.
3. Rasmussen. J. R, Stedronsky. E. R, Whitesides. G. M, J. Am. Chem. Soc., **1977**, 99, 4736.
4. Holmes-Farley. S. R, Whitesides. G. M, Langmuir, **1987**, 3, 62.
5. Nuzzo. R. G, Smolinsky. G, Macromolecules, **1984**, 17, 1013.
6. Idage. S. B, Badrinarayanan. S, Vernekar. S. P, Sivaram. S, Langmuir, **1996**, 39, 1231.
- 7a. Kubota. H, Yoshino. N, Ogiwara. Y, J. Appl. Polym. Sci., **1990**, 39, 1231.
- b. Kubota. H. J, Appl. Polym. Sci., **1992**, 46, 383.
- c. Ranby. B, Makromol. Chem. Macromol Symp., **1992**, 63, 55 and references cited therein.
8. Hedman. J, Klasson. M, Nilsson. R, Nordling. C, Sorokina. M.F, Kljushnikov. O.I, Nemnouov. S.A, Trapeznikov. V.A and Zyryanov. V.G, Physica Scripta, **1971**, 4, 195.
9. Scofield. J. H, J. Electron Spectrosc. Relat. Phenom., **1976**, 8, 129.
10. The blank film showed a weak absorption in 1715-1720 cm⁻¹ region which persisted in the modified film 1 (Figure 3.5). This is attributed to the surface oxidized impurities present in the original film. Partial hydrolysis of the succinic anhydride group during film handling can not ruled out.
11. Odian. G, Principles of Polymerization, 3rd Edition, John Wiley and Sons, New York, **1991**, p 281.
12. Gaylord. N. G, J. Macromol. Sci.- Revs. Macromol. Chem., **1975**, C13(2), 235.
13. Roover. B. De, Sclavons. M, Carlier. V, Devaux. J, Legras. R, Momtaz. A. J, Polym. Sci., Polym. Chem., **1995**, 33, 829.
14. Tazuke. S and Kimura. H. J, Polym. Sci. Polym. Lett., **1978**, 16, 497.
15. Whitesides. G.M, Laibinis. P.E, Langmuir, **1990**, 6, 87

16. Holmes-Farley.S.R, Nuzzo.R.G, McCarthy. T.J, Whitesides. G.M, Langmuir, **1987**, 3, 799,
17. Lucki. J, Rabek. J. F, Ranby. B, Qu. B. J, Susti. A, Vogl. O, Polymer, **1990**, 31, 1772.
18. Chan. C. M, Polymer Surface Modification and Characterization Hanser, New York, **1994**, p 200.

CONCLUSION

It is well charac-

terized modified

compatibil-

ization of the

polymer

is well charac-

terized modified

compatibil-

ization of the

polymer

CHAPTER IV

FUNCTIONAL GROUP TRANSFORMATIONS OF SUCCINIC ANHYDRIDE ON POLYETHYLENE SURFACE

4.1 INTRODUCTION

Preparation of specific polymer surfaces with well characterized functional groups is an area of significant current research.¹ Surface modified polymers can be used to study interfacial properties of material such as biocompatibility, adhesion, gas permeation, friction and surface reconstruction.² Surface modification of chemically resistant polymers have generally been accomplished by treatment of surfaces with chemical reagents.^{3,4} Carboxylic acid groups have been introduced onto a surface of polyethylene (PE-COOH) by oxidation with concentrated chromic acid solution at temperatures between 25-75°C followed by further oxidation with 70% aqueous nitric acid at 50°C.⁴ The PE-COOH can be transformed chemically as well as by microwave radiation⁵ to a variety of other derivatives.

Grafting of hydrophilic monomers onto hydrophobic polyethylene surface is well in literature. Kubota^{6,7} has studied the vapor phase photografting of a series of polar monomers onto the surface of polyethylene. In this approach the sensitizer is first coated on the polymer substrate followed by irradiation with monomer vapors. Tezuke⁸ irradiated the polymer surface when it was immersed in the solution containing sensitizer and monomer. Recently, Ranby and coworkers⁹ have developed convenient methods for surface modification of polymers by photoinitiated graft polymerization of a variety of acrylic monomers. In the batch process, the substrate was enclosed in a cell containing initiator and monomer vapor. UV light passed through a quartz window initiated the grafting reaction. In the continuous process the substrate was presoaked in a solution of initiator and monomer and then drawn into the reactor and irradiated by UV. In all the above approaches, an acrylic polymer is grafted onto the surface of polyethylene.

The bulk modification of polyethylene with maleic anhydride has been exhaustively studied.¹⁰ Gabara and Porejko¹¹ reported the reaction of maleic anhydride with a polyethylene film at a temperature range of 80-110°C in presence of AIBN or benzoyl peroxide (5% by weight of polymer) for 20-48 h in acetic anhydride as solvent. The polyethylene films turned brown after reaction. Based on gravimetry and infrared evidence it was concluded that poly(maleic anhydride) was grafted onto the polyethylene surface.

On the contrary, nonchemical methods for introducing discrete functional groups on polymer surfaces are rare. Recently, Keana and coworkers reported introduction of a N-hydroxysuccinimide functionalized perfluorophenyl group onto a surface of polyethylene by

photolysis of the spin coated film with the corresponding perfluorophenylazide.¹² In this chapter, a simple and mild photochemical reaction is reported for the introduction of discrete succinic anhydride groups onto the surface of polyethylene. The second objective is to survey a range of organic functional groups on the surface of polyethylene for their influence on wettability and to search for a correlation between some appropriate measure of polarity of the individual functional groups in solution and the wettability of an interface incorporating them. The third objective is to confirm that changes in wettability with pH of interfaces having acidic or basic groups reflect protonation or deprotonation and to examine how such ionizations influence wetting.

4.2 EXPERIMENTAL

4.2.1 Materials

Ethanolamine, ethylene diamine (s.d.fine chemicals, India) was dried by azeotropic distillation with dry benzene and fractionally distilled under reduced pressure. Aniline (s.d.fine chemicals, India) was dried with CaH_2 and distilled under reduced pressure. Morpholine (s.d fine chemicals, India) was dried with KOH and fractionally distilled. 4-amino azobenzene, piperazine (E.Merck, Germany), Tetramethylammonium hydroxide, tetraethylammonium hydroxide, tetrabutylammonium hydroxide, tetrapropylammonium hydroxide (20% aq solution, Aldrich Chemicals, USA), PCl_5 (s.d.fine chemicals, India), NaOH, HCl (E.Merck, India), Poly(oxyethylene glycol) (average M.W. 600, Sisco Chem, India), Poly(oxyethylenediamine) (average M.W. 2000, Texaco Chemicals Company, USA) were used as received. Acetone, methanol, chloroform and diethylether were obtained from s.d.fine chemicals, India and were distilled before use.

4.2.2 Methods

4.2.2.1 Sample preparation and conditioning

The procedure is described in section 3.2.2.1

4.2.2.2 Poly(ethylene) surface bearing succinic anhydride group (1)

The procedure is described in section 3.2.2.2, except that the irradiation time was 1 h, 2 h, 3 h, 5 h and 8 h.

4.2.2.3 Poly(ethylene) surface bearing succinic acid group (2)

The film 1 was placed in water, containing 2 wt% pyridine and heated to 50°C for 1 h. The film was then rinsed with water and dried at 30°C for 4 h.

4.2.2.4 Polyethylene film bearing amide and ester group derived from different amines and alcohols

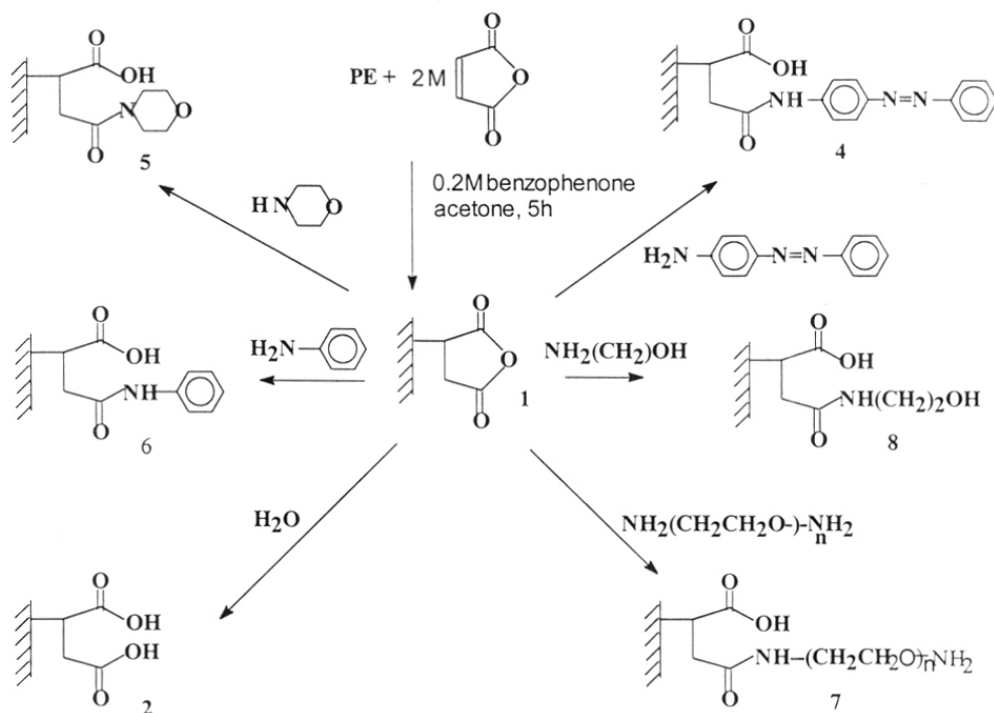

Scheme 4.1: Chemical transformations of polyethylene film bearing succinic anhydride group: Monofunctionalization

Reaction of poly(ethylene) surface bearing succinic acid with 4-aminoazobenzene (3)

The film 2 was placed in 10 mL of dry diethylether containing 2 g of PCl_5 at 30°C for 3 h. The film was removed and immersed immediately in a 0.01 M solution of 4-aminoazobenzene in chloroform for 2 h at 30°C. The film was rinsed with chloroform and soxhlet extracted with acetone for 4 h and dried under vacuum at 30°C for 4 h.

Poly(ethylene) film bearing azobenzene (4)

The film 1 (scheme 4.1) was immersed in 3 mL of 0.01M 4-amino azobenzene solution in chloroform. The film was allowed to react with 4-amino azobenzene at 30°C for 6 days with occasional stirring. The film was thoroughly extracted using hot chloroform and dried under vacuum at 30°C for 4 h.

Poly(ethylene) film bearing COCl group (9)

The film 2 (4.2) was immersed in 10 mL of dry diethyl ether containing 2 g of PCl_5 for 3 h at 25°C. The film was quickly removed from the above solution and used immediately without workup to minimize hydrolysis of the acid chloride by atmospheric moisture.

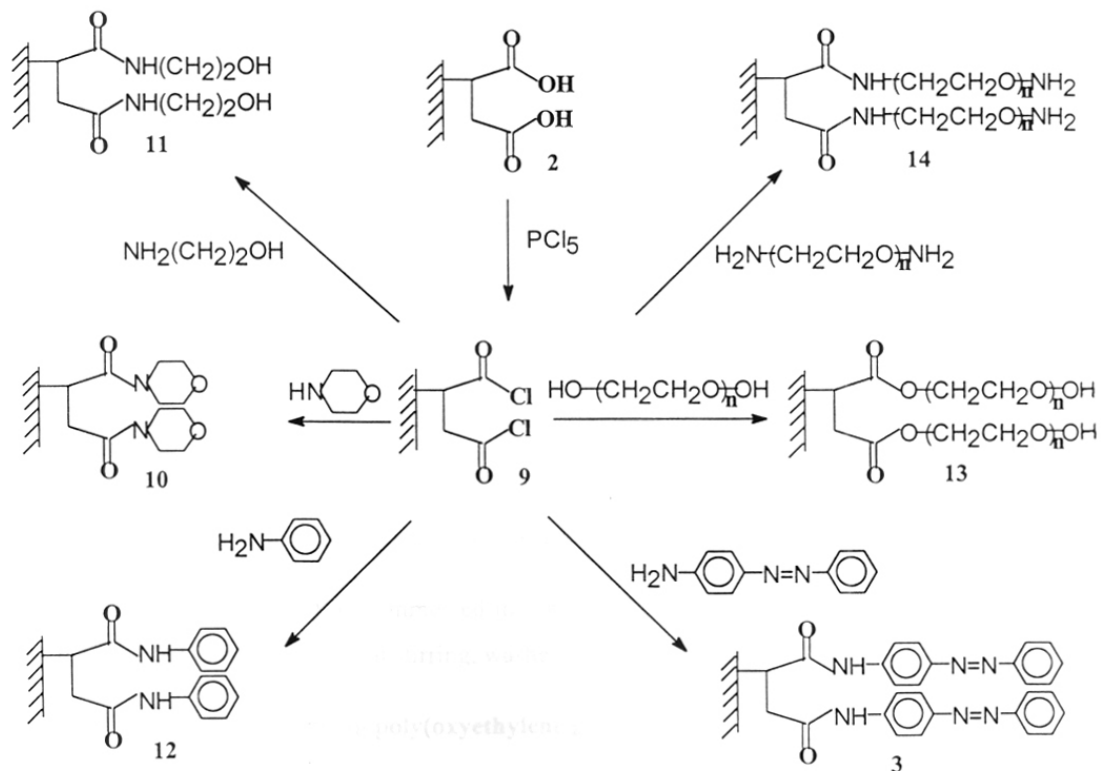

Scheme 4.2: Chemical transformation of poly(ethylene) film bearing succinic anhydride group: Difunctionalization

Poly(ethylene) film bearing morpholine (5, 10)

The film 1 (scheme 4.1) was immersed in morpholine for 3 h at 25°C. The film was thoroughly extracted using hot chloroform and dried under vacuum at 30°C for 2 h.

The film 9 (scheme 4.2) was placed in morpholine for 1 h at 25°C, washed and dried as before.

Poly(ethylene) film bearing ethanolamine (8, 11)

The film 1 (scheme 4.1) was immersed in ethanolamine at 25°C for 3 h, washed and dried as before.

The film 9 (scheme 4.2) was immersed in ethanolamine at 25°C for 1 h, washed and dried as before.

Poly(ethylene) film bearing aniline (6, 12)

The film 1 (scheme 4.1) was immersed in aniline at 25°C for 3 h, washed and dried as before.

The film 9 (scheme 4.2) was immersed in aniline at 25°C for 1 h, washed and dried as before.

Poly(ethylene) film bearing poly(oxyethylenediamine) (7, 14)

The film 1 (scheme 4.1) was immersed in 5 wt% poly(oxyethylenediamine) in chloroform for 24 h at 30°C with occasional stirring, washed and dried as before.

The film 9 (scheme 4.2) was immersed in 5 wt% poly(oxyethylenediamine) in chloroform for 6 h at 30°C with occasional stirring, washed and dried as before.

Poly(ethylene) film bearing poly(oxyethylene glycol) (13)

The film 9 (scheme 4.2) was immersed in PEG (n=14) for 20 h at 60°C with constant stirring, washed with water, extracted with acetone for 2 h and dried under vacuum for 4 h at 30°C.

4.3 RESULTS AND DISCUSSION

Succinic anhydride is a reactive functionality capable of facile transformation to a variety of organic functional groups. In order to study such transformations and to evaluate the behavior of such modified surfaces, we prepared modified poly(ethylene)s with higher concentration of succinic anhydride (greater depths of functionalization). This was achieved simply by increasing the irradiation time of the film. Strictly speaking, a definition of "surface" implies a two dimensional array of functionality. However, for practical applications of modified surfaces, reaction in depth may not only be acceptable, but in some cases even desirable. These reactive functional group on the polyethylene surface undergo facile transformation to various functional groups such as acids, amides, esters, salts by reaction with various reagents.













4.3.1 Monofunctionalization of the anhydride group

The succinic anhydride modified poly(ethylene) (irradiation time:5 h) could be transformed into a carboxylic acid by simple hydrolysis or to mono amides by treating with the corresponding amines or esters (Scheme 4.1). The succinic acid functionalized poly(ethylene) showed a θ_a of 80° . Holmes-Farley et al.¹³ achieved a θ_a of 55° for PE-COOH prepared by treatment of poly(ethylene) film with strong oxidizing agents such as chromic acid. The lower contact angle in the latter implies more substantial modification of the film by polar groups, presumably on account of the drastic conditions of modification employed.

4.3.2 Difunctionalization of the anhydride group

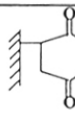
The dicarboxylic acid could be transformed to a diacid chloride, which could in turn be converted to a diamide or diester (Scheme 4.2). The characteristic IR absorption band and the advancing contact angle of the functionalized poly(ethylene)s are shown in Table 4.1.

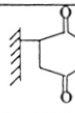
Table 4.1: Surface wettability of functionalized poly(ethylene)s

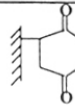
| Functionality | θ_a° | Characteristic absorption (cm^{-1}) |
|--|------------------|---|
|  1 | 83 | 1789,1868 (cyclic anhydride group) |
|  2 | 80 | 1715 (C=O of acid) |
|  5 | 72 | 1720,1652 (C=O of acid, amide); 1112 (C-O-C) |
|  10 | 60 | 1652 (C=O of amide); 1112 (C-O-C) |
|  8 | 72 | 1710, 1654 (C=O of acid, amide); 1562 (small peak of NH bending) |
|  11 | 60 | 1654 (C=O of amide); 1562 (small peak of NH bending) |
|  13 | 42 | 1741 (C=O of ester); 1119 (C-O-C) |
|  7 | 70 | 1721,1650 (C=O of acid, amide); 1565 (NH bending); 1106 (C-O-C) |
|  14 | 40 | 1650 (C=O of amide); 1565 (NH bending); 1106 (C-O-C) |
|  6 | 90 | 1720, 1678 (C=O of acid, amide) |
|  12 | 100 | 1678 (C=O of amide) |
|  4 | 98 | 1715 (C=O of acid and amide peak are merged); 1600 (aromatic peak) |
|  3 | 106 | 1658-1600 (broad peak, C=O of amide and aromatic peak are merged) |

The changes in the contact angle of various modified poly(ethylene)s (Table 4.1) showed some interesting trends. With mono substitution, there was a marginal decrease in θ_a . However, the value leveled off around 72° , irrespective of the nature of substitution (except in case of reaction with aniline and 4-aminoazobenzene). Apparently in these cases, the monocarboxylic acid functionality determines the wettability character of the surface. Upon disubstitution, further, and more substantial, decrease in θ_a was observed.

4.3.3 Effect of pH on surface ionization of dicarboxylic acid

The succinic anhydride and succinic acid modified film were subjected to advancing contact angle measurement using aqueous alkali solution of varying pH in the range 11.7 to 13.1 at 25°C . The contact angle was measured in quadruplicate, by sequentially increasing the pH of the solution. Each successive set of measurements, were performed on different locations of the film. The dicarboxylic acid functionalized poly(ethylene) showed changes in advancing contact angle with pH (Figure 4.1).

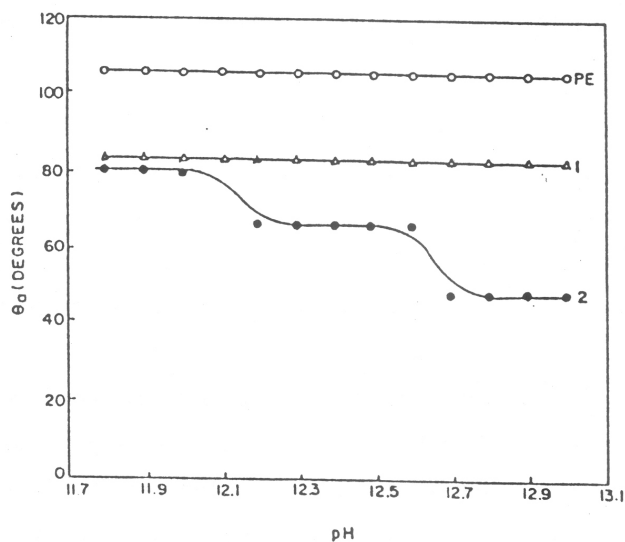

Figure 4.1: Change in contact angle with pH of succinic acid modified poly(ethylene) (o, PE; Δ , 1; \bullet , 2) (irradiated for 5 h)

Figure 4.1 represents the variation of θ_a with unbuffered aqueous pH in poly(ethylene) surface, **1** and **2**. No change in θ_a is observed with pH in untreated poly(ethylene) and **1**. The succinic acid modified poly(ethylene) **2** exhibits an abrupt change in contact angle from 80° to 67° at pH = 12.2 and 48° at pH = 12.7. This behavior is consistent with the dibasic nature of succinic acid which has two pKa values at 4.21 and 5.64.¹⁴ However, the ionization of **2** occurs at an even higher pH as compared to PE-COOH (pH= 11.9).¹³ Holmes-Farley et al.¹³ have observed that the carboxylic acid group of PE-COOH does not behave as a simple monobasic acid. The ionization occurs at a more basic value of pH than that of monobasic carboxylic acid or even of polybasic acid such as polyacrylic acid. Three possible explanations were suggested for this peculiar acid-base behavior displayed by PE-COOH. (1) Coulomb interactions between carboxylate ions, (2) electrostatic field gradient at the polymer-water interface due to large dipole moments of carboxylate groups and carboxylic acid and (3) local dielectric cavity effect at polymer-water interface. Although it is yet not clear which of these effects is the most important, they are nevertheless responsible for accentuating the acidity of dicarboxylic acids on poly(ethylene) surface.

4.3.4 Wettability characteristics of functionalized polyethylene surfaces

Wettability is a property of a surface that is both theoretically and practically important. Wetting of solid surfaces by liquids, especially by water, plays an important role in various practical applications. One would sometimes like to reduce the wettability of solid surfaces such that they would repel liquids upon contact. On other occasions, however enhanced wettability to promote the spreading of liquids over a solid surface is desired. There are many applications where the simultaneous control of both wetting and nonwetting solid surfaces is required to accomplish a desired result. In printing, for example, the surface of a solid substrate must be maintained reasonably wettable so that ink can be transferred onto the surface. The wettability of solid surfaces by a liquid is often characterized by contact angle measurement.¹⁵⁻¹⁷ Various surface modification techniques to increase the surface energy of solid are now available to make solid surfaces wettable with water. For example corona discharge and cold plasma treatments as well as wet chemical methods are used to incorporate chemical groups capable of interacting with liquids thereby enhancing the wettability.¹⁸ The PE-COOH can be transformed chemically as well as by microwave radiation to a variety of other derivatives.^{5,18} It shows complex phenomena such as surface reconstruction on heating.^{19,20} The thermal reconstruction of the interface of PE-COOH and

its derivatives have been previously studied by subjecting the surfaces to controlled temperature under vacuum for various intervals of time.²¹ Since large number of modified PE surfaces were prepared during this study it was of interest to examine their wettability characteristics as well as their thermal reconstruction behavior.

4.3.4.1 Nature of chemical functionality

Polymer with graded wettability can be prepared by incorporating different functional groups on the surface Whitesides examined the contact angle properties of different functional group on the surface of polyethylene (Table 4.2).

Table 4.2. Contact angle of water on functionalized PE interfaces

| Sample | θ_a° |
|--|------------------|
| PE-H (unoxidized) | 103 |
| Amides | |
| PE[CONH-glucose] | 20 |
| PE[CONHCH ₂ CH ₂ OH] | 40 |
| PE[CONHCH ₂ CH ₂ NH ₂] | 34 |
| PE[CONH ₂] | 50 |
| PE[CONHCH ₃] | 49 |
| PE[CONHC ₆ H ₅] | 113 |
| PE[CONHC ₈ H ₁₇] | 114 |
| Esters | |
| PE[CO ₂ CH ₃] | 90 |
| PE[CO ₂ CH ₂ CH ₃] | 103 |
| PE[CO ₂ (CH ₂) ₂ CH ₃] | 107 |
| PE[CO ₂ (CH ₂) ₃ CH ₃] | 116 |
| PE[CO ₂ (CH ₂) ₄ CH ₃] | 123 |
| PE[CO ₂ (CH ₂) ₅ CH ₃] | 125 |

From the Table 4.2 it is observed that depending on the nature of functional group and the type of linkage, it is possible to alter the surface wettability. But complete wetting is not possible even incorporation of very polar, hydrophilic groups such as N-acylglucosamine, sulfate and sulfonate into the surface. Therefore it is not possible to prepare fully wettable surface derived from PE-CO₂H by increasing the polarity of functional group. However, the wetting of the surface can be increased by increasing the sites capable of hydrogen bonding on the surface. For example, surface bearing glucose exhibits the highest wettability due to the presence of multiple hydroxyl groups. It is also observed that amide functionality is more effective for wetting than ester functionality due to more polar character of -CONH- group. It is also observed that increasing the number of alkyl groups causes a decrease in

wettability because of the ability of long chain hydrocarbons to assume multiple conformations and thereby inhibiting of hydrogen bonding.

Using modified polyethylene film 1 a number of chemical functionalities were introduced (Table 4.1). The modified film exhibited a wide range of hydrophilicity. Here also it is observed that by increasing the hydrogen bonding ability caused the wettability to increase (sample 13 and 14). The changes in the contact angle of various modified poly(ethylene)s (Table 4.1) showed some interesting trends. With monosubstitution, there was a marginal decrease in θ_a . However, the value leveled off around 72° , irrespective of the nature of substitution (except in case of reaction with aniline and 4-aminoazobenzene). Apparently in these cases, the monocarboxylic acid functionality determines the wettability character of the surface. Upon disubstitution, further, and more substantial, decrease in θ_a was observed.

4.3.4.2 Nature of counter cation

Surface wettability can be controlled by changing the counter cation of the surface²⁰ (Fig 4.2).

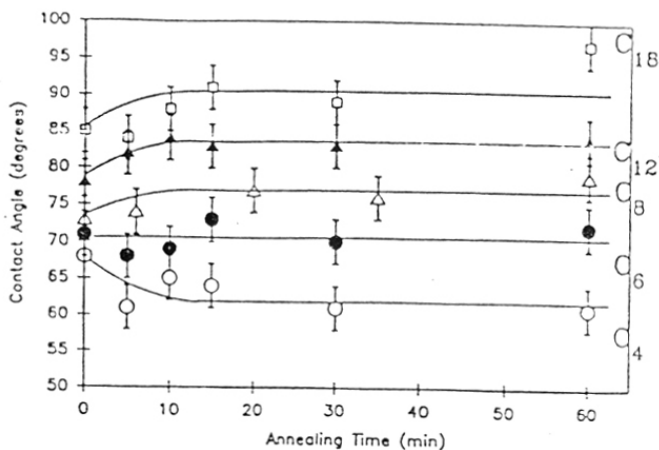

Figure 4.2: Reconstruction of PE- $[\text{SO}_3^-\text{NH}_3\text{R}^+]$ at 70°C in vacuum at various times with various R groups as measured by advancing water contact angle

From Figure 4.2 it is seen that the value for θ_a increased as the alkyl group of the ammonium salt increased in size (from C_4 to C_{18}).

Table 4.3. Contact angle of water on poly(ethylene) interface that contain different counter cations

| Sample | θ_a° |
|-----------|------------------|
| <p>2</p> | 80±2 |
| <p>15</p> | 55±2 |
| <p>16</p> | 60±2 |
| <p>17</p> | 64±2 |
| <p>18</p> | 65±2 |

A similar study was performed on sample **2**, neutralized with tetraalkylammonium ion with varying alkyl lengths. Film **2** (5 h irradiated sample) was immersed in different tetraalkyl ammonium solution (tetramethyl, tetraethyl, tetrapropyl, tetrabutyl ammonium hydroxide) for 24 h at 25 °C, washed thoroughly with water and dried in vacuo. The formation of salt on the surface was evidenced by IR and XPS analysis. In IR two new peaks appeared at 1634 and 1560cm⁻¹ (Figure 4.3) and XPS showed a peak corresponding to nitrogen binding energy at 400 eV (Figure 4.4). Formation of tetraalkylammonium salt was accompanied by a decrease in contact angle. Sample **2** exhibits lower wettability than sample **15** because of the ionic nature of surface of the latter. However, further increase in the length of the alkyl group (C₁→C₂) caused an increase in constant value of ~ 64° when the alkyl group consisted of three carbon atoms or more. This once again alters to the ability of longer chain alkyl group to inhibit hydrogen bonding.

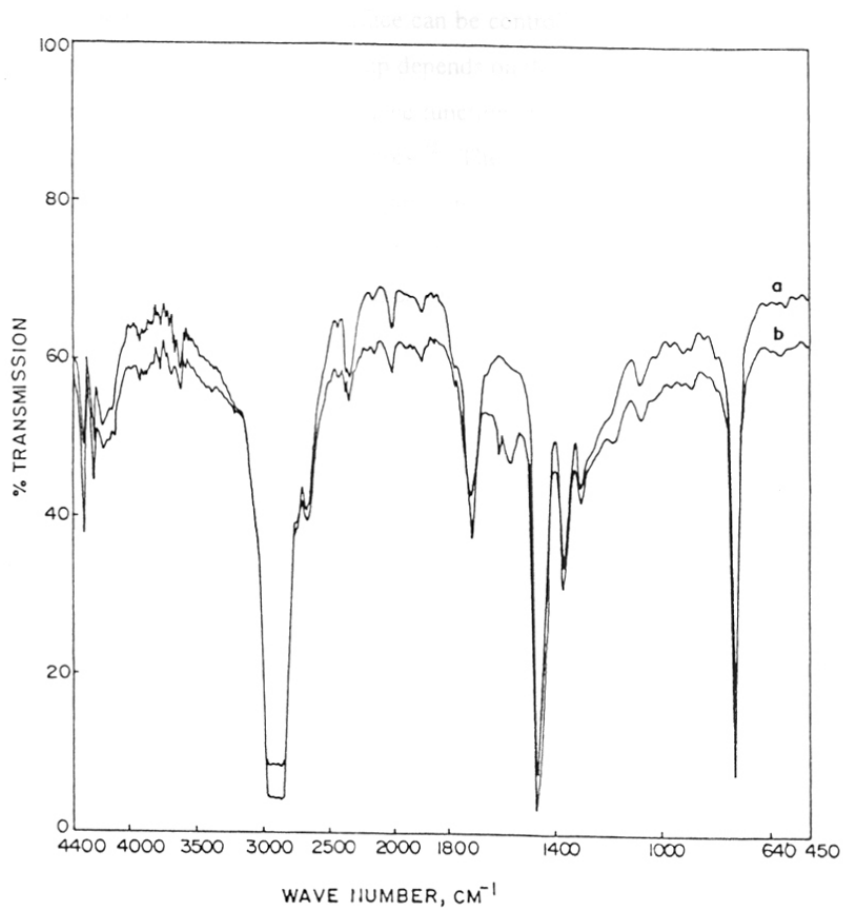

Figure 4.3: FT-IR spectra of film a: Film bearing succinic acid group, b: Film bearing tetramethyl ammonium salt

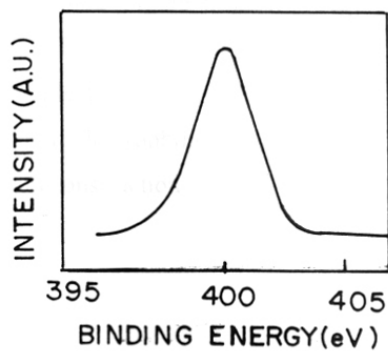

Figure 4.4: XPS spectra of nitrogen of sample 15

4.3.4.3 Effect of heating

Wettability of functionalized polymer surface can be controlled by heat treatment. The rate of surface reconstruction of functional group depends on the structure and size of functional group. In general, polymers containing surface functionality undergo surface reconstruction upon thermal annealing due to several factors.²² The energetically favorable change to a lower surface free energy at a vacuum/polymer interfaces is one of the dominant factors responsible for reconstruction of high energy functionalized polymer surfaces. However, other factors such as the nature of the polymer, entropy and the identity of the reorganizing functional groups also affect the overall energy change and the outcome of any annealing experiment. Sulfonated polyethylene films on the contrary reconstruct at rates comparable to those of carboxyl-containing polyethylene films but in a manner such that a more hydrophilic surface is produced after annealing.²⁰ Heating a sulfonated PE film in a vacuum oven at 70°C produced an annealed film, the hydrophilicity of which varied with annealing time. A typical variation in hydrophilicity would be a change in θ_a from 63° to 49° over an 1 h period. While separate sulfonation experiments yielded films whose initial θ_a and final θ_a varied by as much as 5°, every sulfonated film annealed produced a more hydrophilic surface. More lightly sulfonated films had a higher initial and final θ_a . In contrast the θ_a for a carboxylated film changed from 74° to 100° under the same conditions in accord with earlier reports. The rate of change of θ_a with annealing time was similar for the PE-[SO₃H] or PE-[CO₂H] samples. Suspension of PE-[SO₃H] or PE-[CO₂H] films in refluxing 2-propanol also led to surface hydrophilicity changes in these films. In the case, the limiting value of θ_a for PE-[CO₂H] was 82° while the limiting value of θ_a for PE-[SO₃H] was 56°.

Substitution of other groups for H⁺ in the sulfonated film showed that the hydrophilicity of the annealed film could be controlled (Figure 4.2). From Figure 4.2, it is noticed that a film with ammonium salts having longer chain organic groups upon annealing formed a poly(ethylene) like surface while those having shorter chain alkylammonium salts upon annealing resulted in a more hydrophilic surface. Therefore, the size of the cation determines the rate of surface reconstruction.

Using film **2**, neutralized with tetraalkylammonium ions, with varying alkyl lengths surface reconstruction phenomena was examined (Table 4.4).

poly(ethylene)

Table 4.4. Water contact angle of PE Film bearing salts before and after annealing

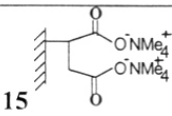
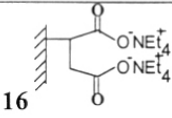
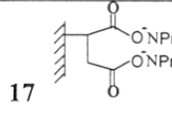
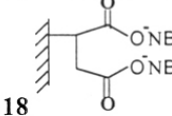
| Sample | Initial θ_a | θ_a (30 min heating) | θ_a (60 min heating) |
|---|--------------------|-----------------------------|-----------------------------|
|  <p>15</p> | $55 \pm 2^\circ$ | $72 \pm 2^\circ$ | $72 \pm 2^\circ$ |
|  <p>16</p> | $60 \pm 2^\circ$ | $67 \pm 2^\circ$ | $71 \pm 2^\circ$ |
|  <p>17</p> | $64 \pm 2^\circ$ | $69 \pm 2^\circ$ | $71 \pm 2^\circ$ |
|  <p>18</p> | $65 \pm 2^\circ$ | $68 \pm 2^\circ$ | $70 \pm 2^\circ$ |

At the end of thirty minutes of annealing at 90°C , a greater loss of wettability was observed with smaller alkyl ammonium cations. Apparently, surface reconstruction is slowed down with alkyl groups having larger carbon numbers.

The thermal reconstruction of the interface and its derivatives have been previously studied by subjecting the surfaces to controlled temperature under vacuum for various intervals of time.²¹ A study of thermal reconstruction of **2** and its derivatives was examined by contact angle and XPS study (Table 4.5).

Table 4.5. Contact angle of water on poly(ethylene) interface that contain different functional groups and whose contact angle changes with heating

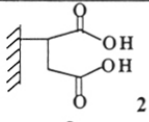
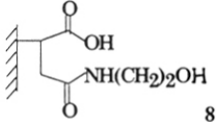
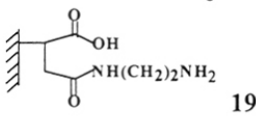
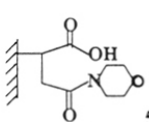
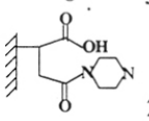
| Sample | Initial θ_a | θ_a (30 min heating) | θ_a (60 min heating) |
|---|--------------------|-----------------------------|-----------------------------|
|  2 | $80 \pm 2^\circ$ | $95 \pm 2^\circ$ | $95 \pm 2^\circ$ |
|  8 | $72 \pm 2^\circ$ | $78 \pm 2^\circ$ | $79 \pm 2^\circ$ |
|  19 | $70 \pm 2^\circ$ | $80 \pm 2^\circ$ | $80 \pm 2^\circ$ |
|  5 | $72 \pm 2^\circ$ | $75 \pm 2^\circ$ | $75 \pm 2^\circ$ |
|  20 | $71 \pm 2^\circ$ | $73 \pm 2^\circ$ | $73 \pm 2^\circ$ |

The samples were thermally annealed at $90^\circ\text{C}/10$ mmHg vacuum. Table 4.5 shows the change in the contact angle of water of the various samples upon thermal annealing. The migration of functional groups away from the interface appears to be dominated by minimization of the interfacial free energy.²¹ From Table 4.5 it is observed that the migration of functional group was mostly complete within 30 minutes. From XPS it was found that the ratio $\text{O}_{531.4}/\text{C}_{\text{total}}$ of **2** decrease to 25% ($\text{O}_{531.4}/\text{C}_{\text{total}}$, $0.29 \rightarrow 0.22$) (36A) after 60 minutes heating (Figure 4.5). The nature of functional group also plays a role in determining the extent of surface reconstruction. Morpholine and piperazine containing surfaces did not undergo significant change in wettability upon heating, Compared to surfaces bearing ethanol amine or ethylene diamine (**8** and **9**) which exhibited larger changes in contact angle. This could be due to the greater conformational rigidity of the cyclic morpholine or piperazine functionality relative to the open chain ethanol amine or ethylene diamine.

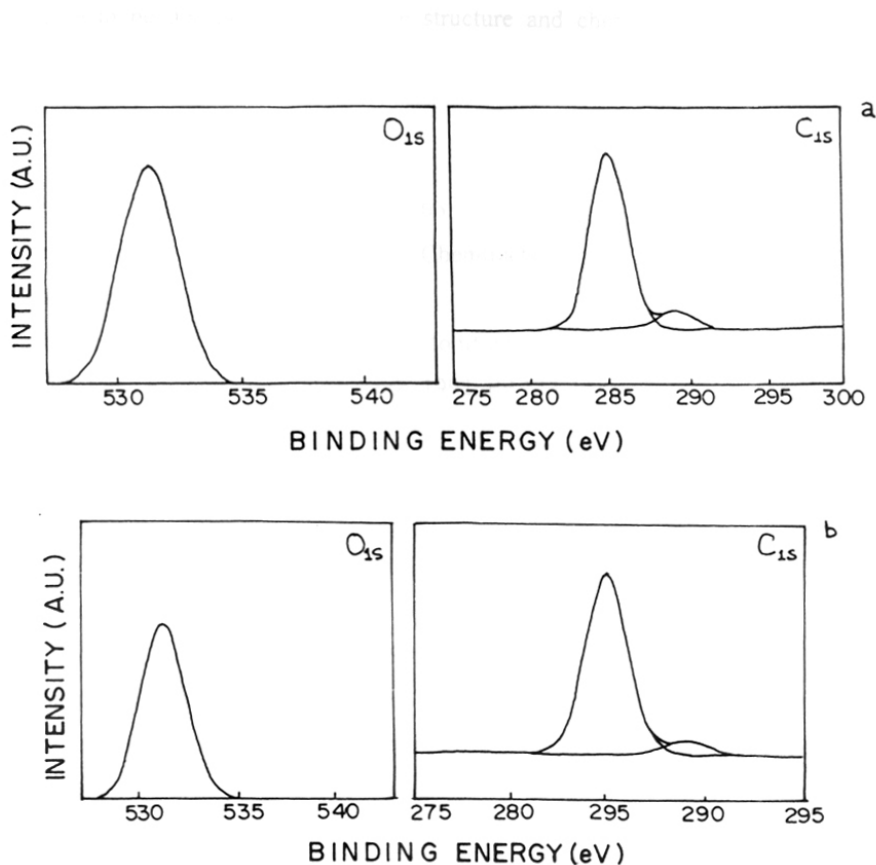

Figure 4.5: XPS spectra of sample 2, a: before heating, b: after heating

4.4 CONCLUSION

Poly(ethylene)s can be functionalized, both in bulk and surface, using a mild photochemical reaction with maleic anhydride in presence of a triplet photosensitizer. The intrinsic reactivity of the anhydride group facilitates efficient functional group interconversions on the poly(ethylene) surface. The anhydride modified poly(ethylene) surface is chemically very reactive and is capable of being converted to a variety of new functional groups using simple organic chemical transformations. Wide variations in wettability ($\theta_a = 40-106^\circ$) of the poly(ethylene) surface was observed depending on the nature of chemical functionality and their nature of attachment. The rate of surface reconstruction upon thermal annealing has

been shown to be depended both on the structure and chemical nature of the surface functionality.

4.5 REFERENCES

1. Allcock. H.R, Science, **1992**, 255, 1106.
2. (a) Whitesides. G.M, Ferguson. G.S, Chemtracts-organic Chemistry, **1988**, 1, 171 and reference cited there in.
(b) Bergbreiter. D.E, "Chemically Modified Surfaces"; Mottola, H.A.; Steinmetz, J.R.; Eds.; Plenum Press, New York, **1992**, PP 133-154.
3. McCarthy. T.J, Chimia, **1990**, 44, 316.
4. Rasmussen. J.R, Stedronsky. E.R, Whitesides. G.M, J.Am.Chem.Soc, **1977**, 99, 4736.
5. Bergbreiter. D.E, Kabza. K, Small,B.L, Chem. Mater., 1993, 5, 257.
6. Kubota. H, Yoshino. N, Ogiwara. Y, J.Appl.Polym.Sci., **1990**, 39, 1231.
7. Kubota. H, J. Appl.Polym. Sci., **1992**, 46, 383.
8. Tazuke. S, Matoba. T, Kimura. H, Okada. Y, ACS Symp. Ser., **1980**, 121, 217.
9. Ranby. B, Makromol. Chem. Macromol Symp., **1992**, 63, 55 and references cited therein.
10. Gaylord. N.G, J. Macromol. Sci.- Revs. Macromol. Chem., **1975**, C13(2), 235.
11. Gabara. W, Porejko. S, J.Polym.Sci.,Polym.Chem., **1967**, 5, 1547.
12. Yan. M, Cai. S.X, Wybourne. M.N, Keana. J.F.W, J.Am.Chem.Soc., **1993**, 115, 814.
13. Holmes-Farley. S.R, Reamey. R.H, McCarthy. T.J, Deutch. J, Whiteside. G.M, Langmuir, **1985**, 1, 725.
14. 'Lange's Handbook of Chemistry'; Dean, J. A., ed., McGraw-Hill Book Co., New York, 1979, 5-17.
15. Shafrin. E.G and Zisman. W.A, J.Phys.Chem., **1960** 64, 519,
16. Owens.D.K and Wendt. R.C, J.Appl.Polym.Sci., **1969**, 13, 1741,
17. McBride. J.M, Segmaller. B.E, Hellingsworth. M.D, Mills. D.E, Weber. B.A, Science, **1986**, 234, 830,
18. Holmes-Farley. S.R, Bain. C.D, Whitesides. G.M, Langmuir, 1988, 4, 921,
19. Rasmussen. J.R, Stedronsky. E.R, Whitesides. G.M, J.Am.Chem.Soc., 1977, 99, 4736,

20. Bergbreiter. D.E and Konardkabza. J.Am.Chem.Soc., 1991, 113, 1447,
21. Holmes-Farley. S.R, Nuzzo. R.G, McCarthy. T.J, Whitesides. G.M, Langmuir, **1987**, 3, 799,
22. Whitesides. G.M, Laibinis. P.E, Langmuir, **1990**, 6, 87

...potential for application in a photocopying system.¹⁴² For example, the use of azobenzene as a photoresist is promising because of its high resolution and its susceptibility to photochemical configuration changes. However, the use of azobenzene as a photoresist is limited by its low solubility in the developer solution. The use of azobenzene as a photoresist is limited by its low solubility in the developer solution. The use of azobenzene as a photoresist is limited by its low solubility in the developer solution.

CHAPTER V

POLYOLEFIN SURFACES BEARING AZOBENZENE FUNCTIONALITY

...
...
...

5.1 INTRODUCTION

Photoresponsive polymers have great potential for application in areas, such as optical information storage and optical switching system.^{1a,b} For use in photomemory system, materials containing azobenzene units are promising because these have dipole moments and optical parameters that are highly susceptible to change due to their reversible photoisomerization. The geometrical configuration of azo bond in azobenzene compound can be changed reversibly from trans or E to cis or Z by the irradiation with light of appropriate wavelength. The two states have distinct absorption spectra. This characteristic feature allows reversible storage of data on the basis of cis and trans states. A number of studies have been reported on the $E \rightleftharpoons Z$ isomerism of azobenzene bound to a polymer, either in the main chain or side chain.^{2,3,4} In all these cases, the azo moiety was incorporated into the polymer by copolymerization. Consequently, most of the systems studied so far have been based on amorphous vinyl polymers, especially those based on acrylic monomers. Such polymers have attracted significant interest as suitable materials for reversible optical storage.³ The photochemically induced $E \rightarrow Z \rightarrow E$ isomerization of the azobenzene groups within the polymer can generate local orientation of the azobenzene group when the polymer film is irradiated with a linear polarized laser beam. The real interest in the subject, started in 1987 when Wendorff demonstrated reversible optical storage properties on some liquid-crystalline polymer films.^{5,6} The presence of a spacer allowed the mesogenic azobenzene moiety to exhibit liquid crystalline behavior. The liquid-crystalline polymers containing azo aromatic mesogenic groups in the side chain or in the main chain offer the possibility to modify the order state by external fields and/or light. Photochemically induced isothermal phase transitions of some side chain liquid crystalline polymers were studied by Ikada et al. using calorimetry, FT-IR dichroism, polarizing microscopy, etc.⁷ The $E \rightleftharpoons Z$ isomerization of the azo compounds was used to influence the nature of LC phase. When a liquid-crystalline azo polymer sample is examined on a polarizing microscope equipped with a hot stage and irradiated with a linearly polarized laser beam, the nematic to isotropic phase transition can be successfully induced by the photoisomerization of the azo groups in the polymer. The reverse process, namely, the $Z \rightarrow E$ isomerization, occurs in dark and restores the polymer to the initial nematic state.

The photoisomerization of azobenzene based polymers have been previously studied in amorphous and LC polymers. Since, no method was available previously to attach a azobenzene group to semicrystalline polymer, their photoisomerization behaviour has not been studied before. Since during the course of this work such materials could be prepared an investigation of the photochemical and thermal isomerization of azobenzene functionality chemically linked to semicrystalline polyolefin films was undertaken. This chapter presents the results of this study.

5.2 EXPERIMENTAL

5.2.1 Materials

Commercial sample of isotactic polypropylene (i-PP, Koylene S3030), was obtained from Indian Petrochemical Corporation Limited, Baroda, India. 4-amino azobenzene (E.Merck, Germany), 4-(4-nitrophenyl azo) aniline (Aldrich Chemicals, USA), PCl_5 (s.d.fine chemicals, India), were all reagent grade and used as received.

5.2.2 Methods

5.2.2.1 Sample preparation and conditioning

This is described in 3.2.2.1

5.2.2.2 Polyolefin film bearing succinic anhydride group (1, scheme 5.1)

The procedure was similar to that described in section 3.2.2.2, except that the irradiation time was 1 h.

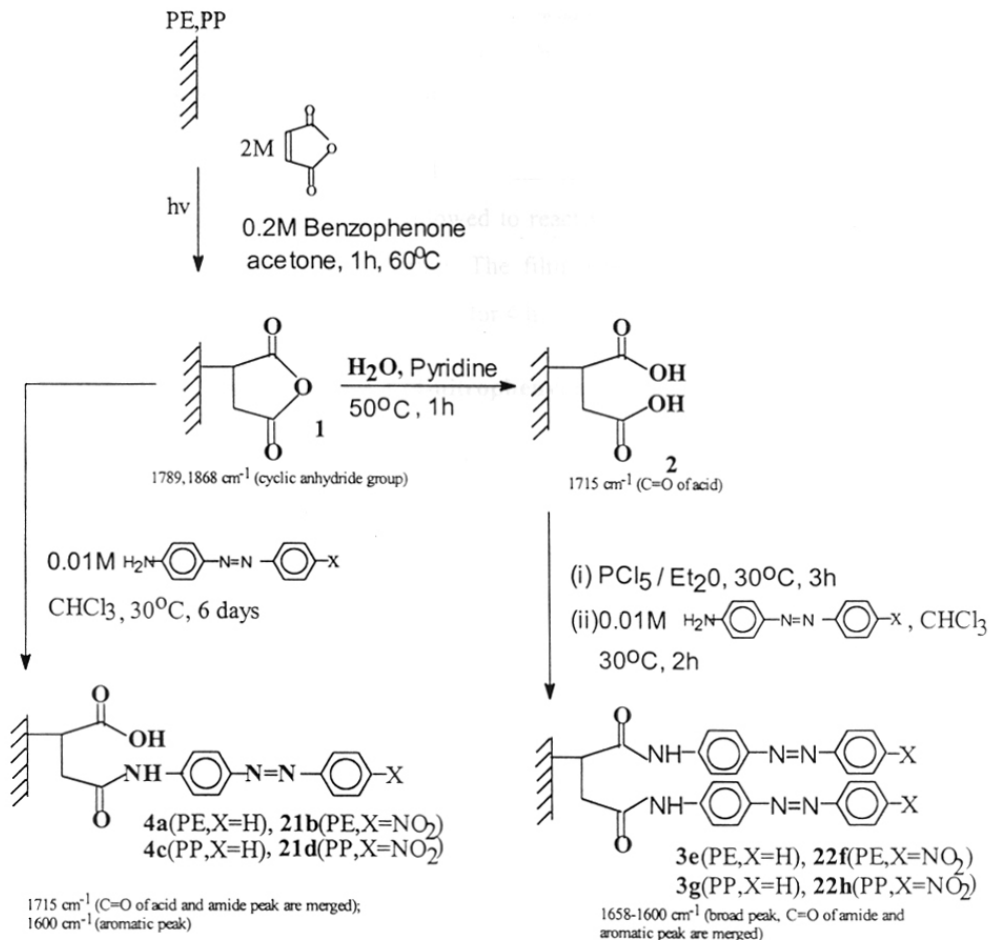

Scheme 5.1: Synthetic route for obtaining polymer (PE,PP)-bound azo compounds

5.2.2.3 Polyolefin film bearing succinic acid group (2)

The procedure is described in section 3.2.2.3.

5.2.2.4 Polyolefin film bearing mono azobenzene (4)

The procedure is described in section 4.2.2.4.

5.2.2.5 Polyolefin film bearing bis azobenzene (3)

The procedure is described in section 4.2.2.4.

5.2.2.6 Polyolefin film bearing mono 4-(4-nitrophenyl azo)aniline (21)

The film 1 (scheme 5.1) was immersed in 3 mL of 0.01M 4-(4-nitrophenyl azo)aniline solution in chloroform. The film was allowed to react with 4-(4-nitrophenyl azo)aniline at 30°C for 6 days with occasional stirring. The film was thoroughly extracted using hot chloroform and dried under vacuum at 30°C for 4 h.

5.2.2.7 Polyolefin film bearing bis 4-(4-nitrophenyl azo)aniline (22)

The film 2 (scheme 5.1) was placed in 10 mL of dry diethylether containing 2 g of PCl₃ at 30°C for 3 h. The film was removed and immersed immediately in a 0.01 M solution of 4-(4-nitrophenyl azo)aniline in chloroform for 2 h at 30°C. The film was rinsed with chloroform and soxhlet extracted with acetone for 4 h and dried under vacuum at 30°C for 4 h.

5.2.2.8 Preparation of amorphous azo polymer (23)

Synthesis of monomer[p-(N-Methacrylyl)aminoazobenzene]: Methacryloyl chloride (8 mL, 0.064 mole) was dissolved in THF (15 mL) and the solution was kept in an ice bath for 10 min. A solution of 4-amino azobenzene (12g, 0.064 mole) was added slowly to the above mixture. After the addition of methacryloyl chloride, the resulting mixture was stirred at room temperature overnight. The solvent was removed by applying vacuum and the residue was dissolved in chloroform, extracted with water and dried over anhydrous Na₂SO₄. The solution was filtered and solvent removed using a rotavapour. The solid product was purified by column chromatography and recrystallized from methanol/water. Yield 60%, ¹H NMR(CDCl₃): δ 2.2 (-CH₃), 5.5,5.85 (CH₂=), 6.85(amide proton), 7.2-8 (aromatic proton). The mp observed is 151-153°C (in literature⁸ reported mp 150-152°C).

Synthesis of polymer: Polymerization was performed in dry toluene (10 ml) with 10% by weight AIBN as initiator at 60°C for 4 days. The polymer was precipitated in n-hexane and purified by reprecipitation in a THF/n-hexane system. The yield was 90% and the polymer had a molecular weight 7250 (\bar{M}_w) (relative to PMMA) and a Tg of 152°C.

Preparation of thin film: Thin film of polymer was obtained by dissolving the poly(4-azophenyl N-phenyl methacrylamide) polymer in THF and casting onto a clean glass slide. The film was initially allowed to dry air and subsequently heated at 70°C for 4 h under vacuo. The layer thickness was tuned to such a level that the UV absorbance did not exceed the value 1 in order to obey the law of Lambert and Beer.

5.2.2.9 Analysis

FT-IR measurements were carried out with a Perkin-Elmer 16PC Spectrometer. Polymers were purified free of additives and stabilizers, and film samples were prepared by melt pressing. The methods of purification and sample preparation (60 μm thick film) have been described in section 3.2.2.1. Advancing contact angles were determined on a NRL Contact Angle Goniometer 100-00230. Reported contact angle values are average of at least 10 readings and are accurate to within $\pm 2^\circ$. Samples were weighed on a Mettler-M5 microbalance for gravimetric analysis which has weighing accuracy of ± 0.005 mg.

UV analysis was carried out with a HP 8452A Diode Array Spectrophotometer. Polyolefin film bearing succinic anhydride groups ($1 \times 3 \text{ cm}^2$) was immersed in 3 mL of 0.01M 4-amino azobenzene dye solution in chloroform. The film was allowed to react with dye at 25°C for 6 days with occasional stirring. A blank experiment was conducted with untreated polyolefin film under identical conditions. The concentration of the dye after reaction with the surface anhydride groups of the film was determined by UV-Visible spectroscopy. A calibration curve (Figure 5.2) was drawn from UV absorption of dye solution of known concentration at 372 nm. The depletion of dye concentration in the solution gave a measure of surface concentration of dye (calculation described in Chapter III).

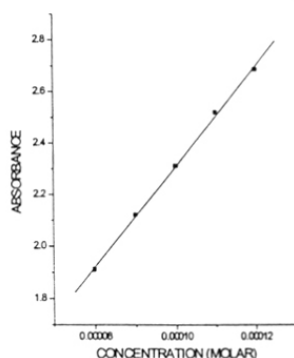

Figure 5.1: Calibration curve of 4-amino azobenzene at $\lambda_{\text{max}} = 372\text{nm}$

For determination of slow cis:trans isomerization rates the film bearing azo compounds were exposed for 30 min in a 400 W, high pressure mercury lamp ($\lambda = 290$ nm), long enough to reach a photostationary state. After irradiation, the film was quickly (< 20 s) introduced into a Hewlett Packard 8452 A Diode Array UV-visible spectrophotometer and the thermal reversion was monitored by measuring the change in absorbance of the film at 342 nm wavelength. The film was exposed to visible light to increase the rate of cis:trans isomerization for switching experiments using a 25W light bulb placed at a distance of 5 cm from the film. The thermal isomerization rate constant $k(T_{\text{isom}})$ was determined by performing UV measurements as a function of time. The amount of trans azobenzene group is assumed to be linearly related to its absorbance at $\lambda_{\text{max}}(t)$ since during the whole process the absorbance was less than 1. Furthermore, the thermal cis \rightarrow trans back isomerization is an irreversible process.

5.3 RESULT AND DISCUSSION

5.3.1 Proof of functionalization

Reaction between sample **1** (scheme 5.1) and azo compounds results in yellow (**4**), orange (**21**) and brown (**3,22**) colored films (Figure 5.2). The **4,21** films showed peaks in FTIR due to acid and amide functionality at 1715 cm^{-1} (merged) and a peak due to aromatic groups at 1600 cm^{-1} . However, the **3** and **22** films showed amide and aromatic peak in a broad range $1658\text{-}1600\text{ cm}^{-1}$ and the absence of peak due to CO_2H functionality (Figure 5.3).

4-amino azobenzene absorbs at a $\lambda_{\text{max}} = 372$ nm in chloroform solution. The UV absorbance of polyolefin film **4** shows a hypsochromic shift to 342 nm. This is due to the formation of amide which competes for the nitrogen lone pair with the aromatic group.

The advancing contact angle of film **4** ($\theta_a = 98^\circ$) is higher than film **1** ($\theta_a = 87^\circ$). Apparently, azobenzene moiety contributes to increased hydrophobicity.

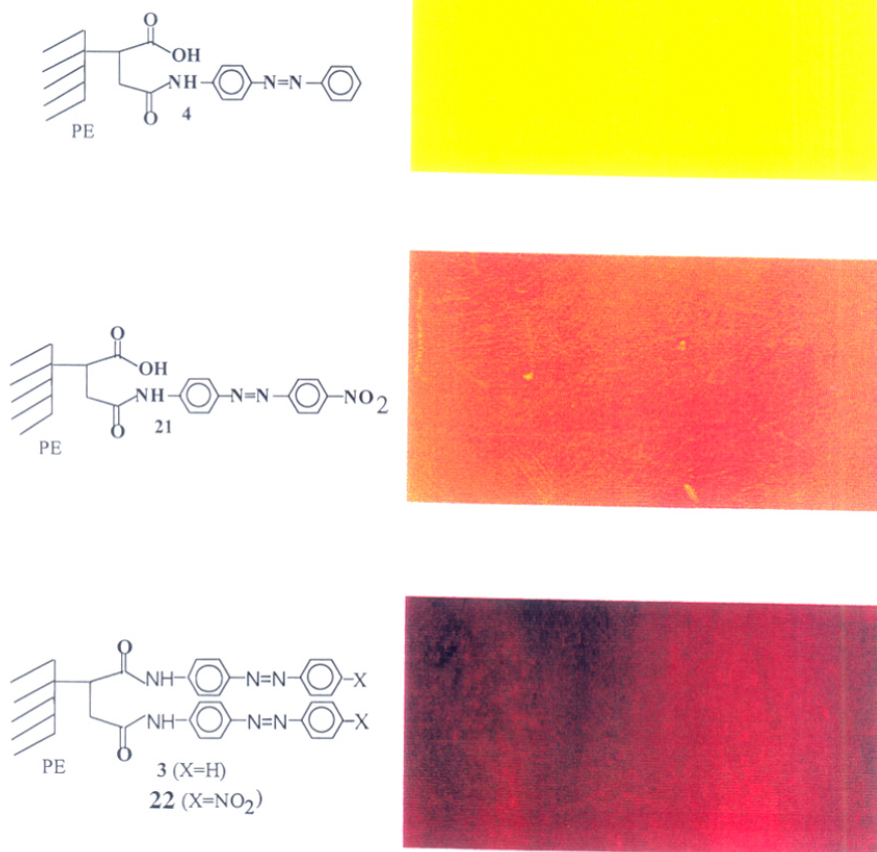

Figure 5.2: Photographs of films 4, 21 and 3,22

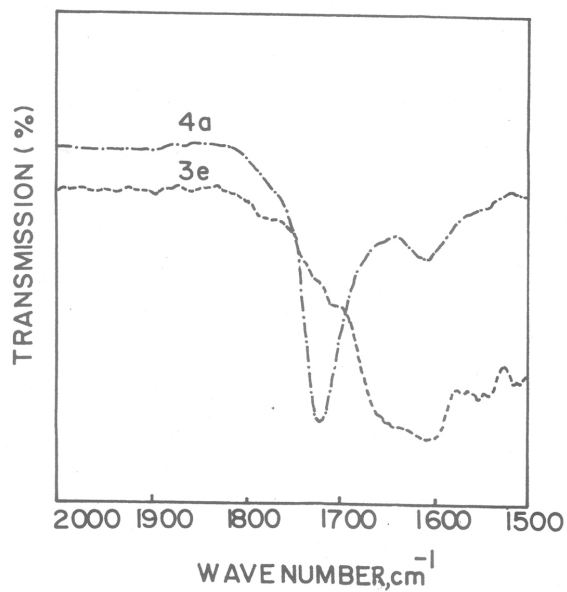

Figure 5.3: FTIR spectra of sample 4a and 3e

5.3.2 Estimation of functional group concentration

UV-visible spectroscopy was used to calculate the surface concentration of the dye. Gravimetric analysis was also used to calculate the amount of dye on the polyolefin surface. From the increase in weight, before and after dye incorporation, the mol of dye/cm² was

calculated (Table 5.1). The UV spectroscopy data is in good agreement with the gravimetric analysis data.

Table 5.1: Concentration of polymer-bound azobenzene present in polyolefin films

| Sample | Concentration $\mu\text{mol}\cdot\text{cm}^{-2}$ | |
|--------|--|---------------|
| | by UV | by Gravimetry |
| 4a | 2.50 | 2.62 |
| 4c | 1.32 | 1.40 |

5.3.3 E:Z isomerization of azobenzene on surface

The azobenzene group can be isomerized by irradiation with light of appropriate wave length. This isomerization alters the molecular shape and the physical properties (polarity) of the azobenzene group (scheme 5.2). Cis form azobenzene has a dipole moment of 3.1D, while the dipole moment of the trans form is less than 0.5D. During the isomerization, azobenzene undergoes a large structural change. The distance between 4 and 4' carbons decreases from 9.0 to 5.5 Å.

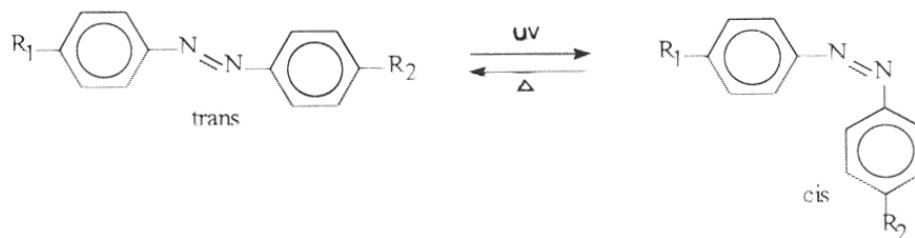

Scheme 5.2: E:Z isomerization of Azobenzene compounds

This change in dipole moment is reflected in a change of surface wettability.¹ Figure 5.4 shows a wettability change measured by the contact angle of a water droplet on the surface of a HEMA-methacryloyl-2-hydroxyethyl-phenylazobenzene copolymer. The absorbance change at 325 nm, which gives information about the content of trans of azobenzene chromophores, is also included in the figure. The contact angle ($\cos\theta$) increases from 0.22 to 0.41 under ultraviolet irradiation, while it decreases to 0.22 with visible irradiation. At the same time, the absorbance decrease with ultraviolet irradiation, while it increases with

visible irradiation. The close correlation between the contact angle and the absorbance at 325 nm indicates that the wettability change of the polymer surface is attributable to the structural change of the azobenzene chromophores.

Samples of film **4a** was subjected to UV and visible radiation (UV: $\lambda \geq 290$ nm; Vis: $\lambda > 470$ nm) and contact angle measured (Figure 5.5). The shape of the curve is similar to that reported in literature (Figure 5.4).

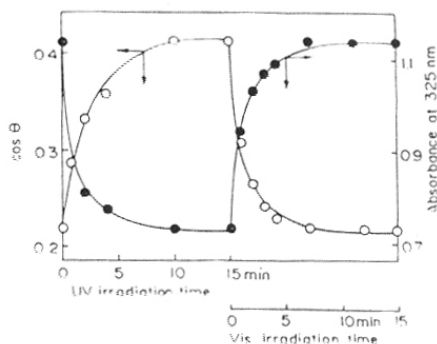

Figure 5.4: Photoinduced change in (○) wettability and (●) absorbance of PHEMA film having pendant azobenzene groups. UV: $\lambda = 350 \pm 50$ nm; Vis: $\lambda > 470$ nm

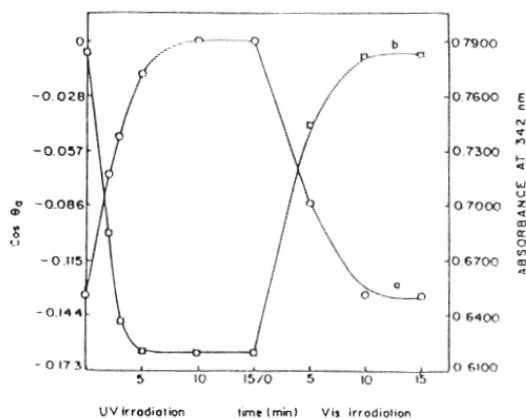

Figure 5.5: Photoinduced changes in absorbance (a) and wettability (b) (sample 4a)

This film underwent a change its advancing contact angle from 98° to 90° after UV light irradiation. The irradiation in the region of the main absorption band (π - π^* transition) of the trans or E form creates a metastable nonplanar, cis or Z form, revealed by a strong decrease of a main absorption band (Figure 5.6). Thus it can be concluded that azobenzene when chemically linked to a semicrystalline polymer exhibits similar bond dynamics as when it is chemically linked to an amorphous polymer.

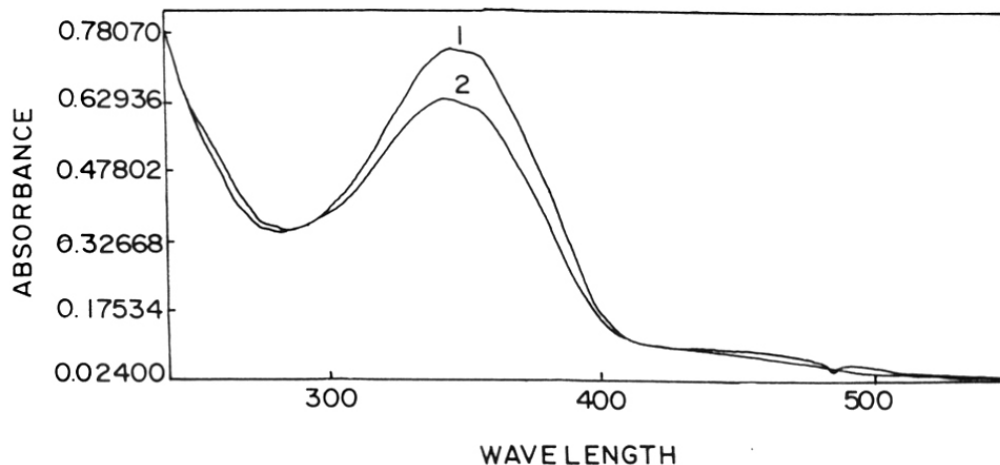

Figure 5.6: Absorption spectra of 4a before 1 and after 2 U.V light irradiation

Figure 5.6 shows the photoinduced change in the absorption spectra of azobenzene containing polyethylene film **4a**. The main absorption band at 342 nm decreases upon UV irradiation indicating that the azobenzene groups undergoes isomerization from E to the Z conformation by irradiation. However, the Z state is thermodynamically unstable with respect to the E state. Therefore, thermal relaxation process occurs after several hours at room temperature. This thermal back reaction is strongly influenced by light, temperature and solvents.^{2,9,10} Transformation from Z to E under the influenced of visible light was observed in case of film **4a**. This caused a change in its advancing contact angle 90° to 98° (Z to E) after 15 minutes of visible light irradiation (Figure 5.5).

5.3.3.1 Kinetics of cis:trans isomerization

By applying eq 1, $k(T_{\text{isom}})t$ can be computed. Plotting $k(T_{\text{isom}})t$ versus time t gives a curve with slope $k(T_{\text{isom}})$ (Figure 5.7).

$$k(T_{\text{isom}})t = \ln \frac{A_E - A_Z}{A_E - A_t} \quad (1)$$

A_E is the absorbance reached at infinite time, which is (normally) also the starting situation after storage in the dark before irradiation with UV light. A_Z is the absorbance measured directly after irradiation, A_t is the absorbance at time t after irradiation. Values for the absorbance were taken at $\lambda_{\text{max}}(t)$. The half-life times $t_{1/2}$ of the Z state were derived from absorption at $t_{1/2} = A_Z + (A_E - A_Z)/2$ (2)

$$t_{1/2} = \ln 2/k(T_{\text{isom}}) \quad (3)$$

Since eq. 3 assumes a first order process and $k(T_{\text{isom}})$ was not found to be constant during the process of thermal back- isomerization, $t_{1/2}$ was determined from eq. 2.

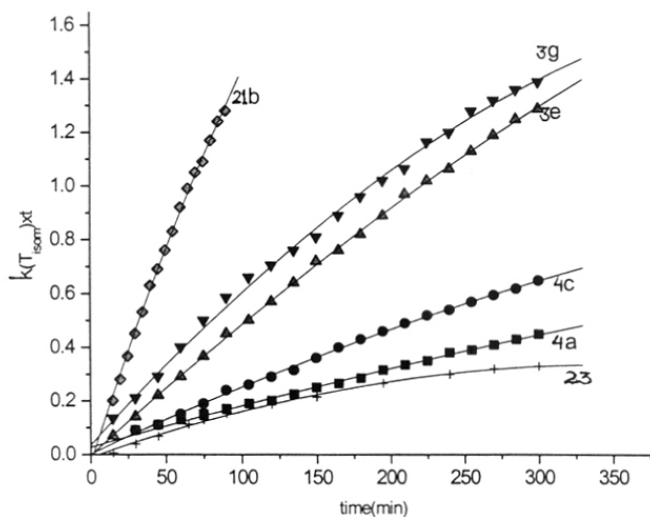

Figure 5.7: Plots of $k(T_{\text{isom}})xt$ vs time(t) for the semicrystalline and amorphous azo polymer

As indicated in Figure 5.7 the $k(T_{\text{isom}})xt$ versus time(t) relation is not linear, as would be expected for first-order kinetics. This nonlinearity is thought to be caused by the difference in the environment of the azobenzene group. The rate of the thermal isomerization is

enhanced by steric factors such as limited free volume in the polymer matrix or (movement of) neighboring chain segments. The slope of the $k(T_{\text{isom}})$ versus time(t) can be regarded as a summation of individual k values, in which in the beginning fast azo groups enhance the overall rate and only slow groups remain after a period of time. This makes it impossible to give one absolute value for $k(T_{\text{isom}})$.

The relationship between the cis concentration attained during photoisomerization and the duration of the exposure time for polymer (Figure 5.8) indicates that exposure time of about 5 min is sufficient to reach a photostationary state with the light intensities used. Apparently not all azobenzene side groups in the polymer matrix are available for photoisomerization.

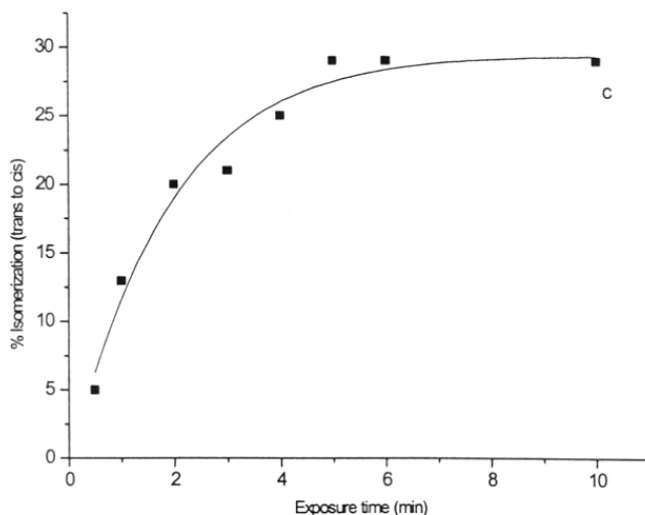

Figure 5.8: Conversion to cis as a function of UV irradiation time at $\lambda_{\text{max}}(t)$ for sample 4a

5.3.3.2 Effect of structure of chromophore

The ready availability of azobenzene and its derivative, chemically bound to polyolefin films (Figure 5.9) afforded an opportunity to examine the $E \rightleftharpoons Z$ isomerization.

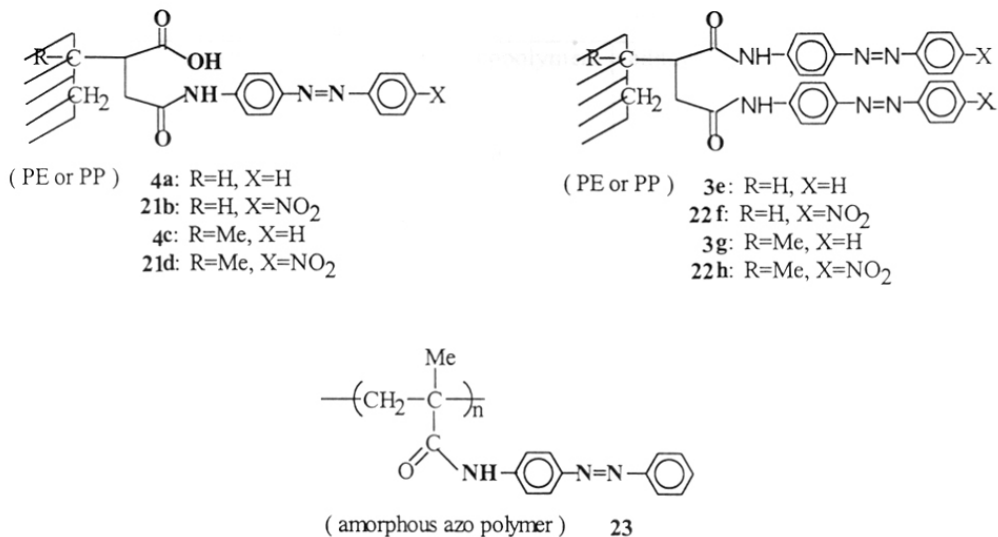

Figure 5.9: General structure of polymer-bound azo compounds

Thermal back isomerization rate is found to depend on the type of the chromophore and the nature of attachment of the chromophore to the polymer backbone.^{2,3} The variation of the substituent has the largest effect on the rate of the thermal back-isomerization (Table 5.2). Changing from a N(CH₃)₂ substituent (polymer I) to CO₂Et (polymer IV) causes an increase of $t_{1/2}$ by a factor of 22, which is caused by an increase of the activation energy for the thermal isomerization due to a smaller overlap between the π - π^* and the n - π^* states. This difference in overlap can be attributed to the electronegativity difference between the substituents of the azobenzene side group. The N(CH₃)₂ group is a strong electron donor and induces an asymmetric electron distribution within the azobenzene group resulting in a push-pull type of azobenzene. Natansohn et al³ also reported that thermal isomerization rate constants are dependent on the spectral type of the chromophore. They observed that a polymer having azobenzene group relaxes slowly (three orders of magnitude slower) than other azo polymers bearing substituted azobenzene groups.

Table 5.2: Survey of the structure and the results for the investigated polymers

| polymer code | substituent | | spacer | | copolymer | | additions | λ_{\max} (t) (nm) | $t_{1/2}^b$ (min) |
|--------------|-----------------|----------------------------------|--------|---|-----------|-----|-----------|---------------------------|-------------------|
| | X | Y | n | m | p | q | | | |
| I | H | N(CH ₃) ₂ | 0 | 0 | 0 | 1 | - | 405 | 120 |
| II | H | N(CH ₃) ₂ | 0 | 0 | 0.5 | 0.5 | - | 405 | 110 |
| III | H | N(CH ₃) ₂ | 6 | 1 | 0.8 | 0.2 | - | 405 | 60 |
| IV | H | CO ₂ Et | 0 | 0 | 0 | 1 | - | 325 | 2700 |
| V | CH ₃ | CO ₂ H | 0 | 1 | 0 | 1 | - | 360 | 550 |

^a $t_{1/2}$ denotes the half-life time of cis.

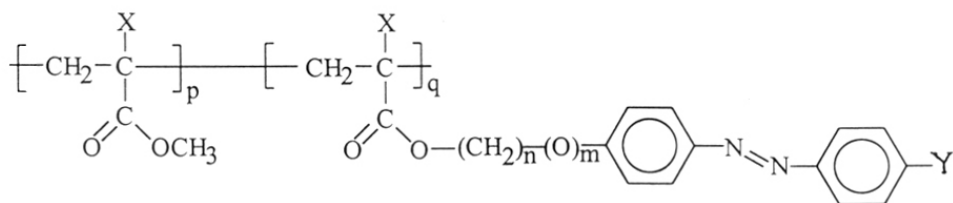
**General structure of the (co)polymers.**

A similar observation was also made with samples **4a** and **23** (Figure 5.9). All the films were irradiated by UV light for 30 mins. The half life time of thermal back isomerization is given in Table 5.3. If the azobenzene groups have no electron-donor or electron-acceptor groups the thermal Z → E isomerization is relatively slow.³ Similar results are observed in case of polyolefin bearing azobenzene (**4a,4c,3e,3g**) and substituted azobenzene (**21b,21d,22f,22h**) (Figure 5.9). Comparison of thermal isomerization rates of **4a** and **21b** (Figure 5.8), indicates that the rate of isomerization of **4a** is 10 times slower than **21b** possibly due to substitution effect of nitro group (Table 5.3).

Table 5.3: Half life of thermal isomerization of polyolefin bound azobenzene and amorphous azo polymer

| Polymer code | λ_{\max} (nm) | $t_{1/2}$ (min) |
|--------------|-----------------------|-----------------|
| 4a | 342 | 510 |
| 21b | 380 | 50 |
| 4c | 342 | 300 |
| 21d | 230 | 45 |
| 3e | 342 | 150 |
| 22f | 380 | 40 |
| 3g | 342 | 105 |
| 22h | 380 | 35 |
| 23 | 344 | 1080 |

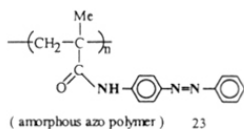
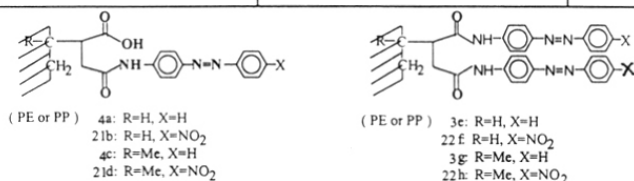

5.3.3.3 Effect of nature of attachment of the chromophore to the polymer backbone

E:Z isomerization of azobenzene compounds depends on their nature of attachment to the polymer backbone. The introduction of a spacer (polymer III, Table 5.2) results in a decrease of $t_{1/2}$ by a factor of 2 due to the increased mobility of the azobenzene group. The rate of thermal isomerization is enhanced by steric factor.² The half life of thermal isomerization is shown in Table 5.3. It is observed that substituting both the carboxylic group with an azobenzene group has the effect of accelerating the rate of thermal isomerization of Z \rightarrow E. This may arise due to excessive nonbonded interaction between the aromatic group when both the azobenzene groups are present in the cis isomer.

5.3.3.4 Effect of the nature of polymer

Natanshon et al³ reported that amorphous azopolymer and semicrystalline polymer (16% crystallinity) does not show appreciable difference in thermal isomerization rates. But when the thermal isomerization rates of amorphous azo polymer and semicrystalline polymer (azobenzene chemically linked to PE or PP) were compared, a significant difference was found. The result shows amorphous azo polymer relaxes slowly compared to semicrystalline polymer (Table 5.3). Again, if we compare the results of $t_{1/2}$ of two semicrystalline polymer (**4a,4c**) (Figure 5.9) it is observed that **4c** relaxes faster than **4a**. This may be due to the effect of free volume distribution in polymer matrix. Depending on the crystallinity of the polymer, it can be assumed that the effective free volume per azo group is relatively more in amorphous polymers than in semicrystalline polymers. Therefore, structural compactness of semicrystalline polymer enhance its Z unstability and it relaxes fastles towards its stable E state. Similarly it can be assumed that effective free volume per azo group in **4c** is less than **4a** due to its higher crystallinity. Therefore, PP bearing all azobenzene samples (**4c, 21d, 3g, 22h**) relaxes faster than PE bearing all azobenzene samples (**4a, 21b, 3e, 22f**) (Figure 5.9).

5.4 POTENTIAL APPLICATION OF POLYMER BOUND AZOBENZENE

Photoresponsive polymers are able to light, giving reversible variations of their structure and conformation that in turn are accompanied by variations of their physical properties. Research in the area of photochromic compounds has become increasingly important because of their potential application in the field of optical technology and in the design of new materials that provide sophisticated responses to external stimuli. Scheme 5.2 shows some of the photochromic compounds: azobenzene derivatives. Their photochromic behavior is due to their ability to exist in two different states having different absorption spectra interconvertible by light. The occurrence of two different structures that can be reversibly interconverted by means of an external light stimulus can be the basis for so-called molecular switch. Moreover, since the two photoisomers are characterized by different geometry and different polarity their interconversion can affect the structure of attached macromolecules and in turn the physical properties of materials. The research on optical storage systems has become a subject of extensive scientific and industrial interest. Polymers with high optical sensitivity, high storage densities, short switching and access time, reversibility and high signal to noise ratio after many write-erase cycles are being

developed for use as optical recording media. Azo polymers were found to be such materials. These could be used in erasable optical memory disks and tapes as erasable holographic information storage materials and as optical sensors usable over a wide range of temperatures.

Much work has been done in order to develop artificial membranes whose physical properties-permeability, conductivity, membrane potential- can be controlled in response to light.¹¹ Thus photoresponsive membranes were prepared from poly(L-glutamic acid) containing azobenzene groups in the side chains.¹² The maximum water content of the membrane was found to increase by irradiation at 350 nm (trans-cis isomerization) as a result of the different polarity and hydrophobicity of the trans and cis isomers. As a consequence the membrane potential and conductivity were found to change on irradiation. The photoinduced variations of the membrane functions were completely reversible and could be photocontrolled by irradiation and dark adaptation in connection with the trans-cis photoisomerization of the side chain azobenzene groups.

Significant effort has been invented in the characterization of the photoresponsive properties of derivative membranes entrapping photochromic compound such as azobenzene and its derivatives. Anzai et al¹³ used the cis-trans isomerization of azobenzene modified crown ethers to regulate the membrane potential across a poly(vinyl chloride) membrane. Photo-induced trans-cis isomerization of azobenzene potential across a poly(vinyl chloride) membrane. Photo-induced trans-cis isomerization of azobenzene derivatives has also been widely used to photocontrol metal ion permeability through PVC membranes¹⁴, liquid crystalline membranes¹⁵ and bilayer membranes.¹⁶ More recently it has been shown that the membrane potentials and permeability of polymer membranes containing photochromic compounds in the polymer chains could be regulated by light irradiation.

The surface free energy of a solid is an important feature of printing, dyeing and adhesion. If surface free energy which is the inherent value of the material can be controlled by external physical signals such as light, wide application of new materials are expected. Ishihara et al^{17,18} have synthesized photoresponsive polymers that contain photochromic azobenzene group in their side chains. Further, the contact angle formed by water on the surface of the

film prepared from p-phenyl azo acrylanilide-2-hydroxyethyl methacrylate copolymer is changed by the photoisomerization of the azobenzene moiety. Further photoinduced changes in the surface free energy of the azo aromatic polymer, prepared by the introduction of the azobenzene groups into the side chains of hydrophilic poly(HEMA) was investigated. Figure 5.2 shows the change of the wettability of the polymer surface by water and the absorbance at 325 nm, which corresponds to a peak for trans-azobenzene moiety, when the light was irradiated onto a film of azo aromatic polymer. When the irradiation is carried out the absorbance of the trans form decreased with irradiation time and the photo equilibrium was obtained within 15 min. The absorbance change was accompanied by an increase in the wettability of the surface of the polymer film. If irradiation by visible light follows the absorbance of the trans form returned to its original level and the wettability decreased once again. The results indicate that the wettability of the polymer surface can be regulated by the photoisomerization of the azobenzene moiety. An investigation was made on the adsorption behavior of water-soluble azo dye toward a polymeric adsorbent and it was demonstrated that a reduction in the hydrophobic interaction brought on by photoisomerization greatly contributes to the desorption of azo dyes from the adsorbent.¹⁷ Water soluble polymeric azo dyes were prepared and the photoinduced adsorption-desorption behavior of the surfactant were examined. Ishihara et al¹⁹ also reported the regulation of the hydrophobic chromatography for proteins by light, polymeric hydrophilic adsorbents containing an azobenzene moiety as a ligand were prepared and the photoinduced adsorption-desorption behavior of proteins was investigated. The separation of protein mixtures was also investigated using a gradient column which was constituted by two polymeric hydrophilic adsorbents having different hydrophobicities.

5.5 CONCLUSION

Irradiation of semicrystalline azo polymer films with light of appropriate wave length induces E to Z isomerization. The Z isomer isomerises back thermally to the E isomer at room temperature. The thermal rate of relaxation depends on the type of chromophore and nature of attachment to the polymer backbone. The azo group containing electron acceptor groups show a fast thermal E:Z isomerization rate. Steric factor also influences the rate of relaxation. The thermal Z → E isomerization of semicrystalline azo polymer film was

compared with that of amorphous azo polymer film. It was observed that an amorphous azo polymer relaxes slowly when compared to a semicrystalline polymer.

5.6 REFERENCES

1. a) Irie. M, Adv.Polym.Sci, **1990**, 94, 27
b) Kumar. S, Chem.Rev., **1989**, 89, 1915
2. Haitjema.H. J, Von Morgen. G.L, Tan. Y.Y, Challa. G, Macromolecules, **1994**, 27, 6201
3. Barrett. C, Natansohn. A, Rochon. P, Chem.Mater., **1995**, 7, 899
4. Yu. W.C, Sung. C.S.P, Robertson. R, Macromolecules, **1988**, 21, 356
5. Eich. M, Wendorff. J.H, Reck. B, Ringsdorf. H, Makromol.Chem.,Rapid Communication, **1987**, 8, 59
6. Eich. M, Wendorff. J.H, Reck. B, Ringsdorf. H, Makromol.Chem.,Rapid Communication, 1987, 8, 467
7. Ikeda. T, Hasegawa. S, Sasaki.T, Miyamoto. T, Lin. M.P, Tazuke. S, Makromol. Chem., **1991**, 192, 1495
8. Paik. C.S and Morawetz. H, Macromolecules, **1972**, 5, 171
9. Wildes. P.D, Pacifici. J.G, Irick. G.Jr, Whitten. D.G, J.Amer.Chem.Soc., **1971**, 93, 2004
10. Nishimura. N, Sueyoshi. T, Yamanaka. H, Imai. E, Yamamoto. S, Hasegawa. S, Bul Chem Soc Jap., **1976**, 49(5), 1381
11. Anzai. J and Osa. T, Tetrahedron, **1994**, 50, 4039
12. Kinoshita. T, Sato. M, Takizawa. A and Tsujita. Y, Macromolecules, **1986**, 19, 51
13. Anzai. J, Sasaki. H, Ueno. A and Osa. T, J.Chem.Soc.,Chem.Commun., **1983**,1045
14. Anzai. J, Ueno. A, Sasaki. H, Shimokawa. K and Osa.T, Macromol.Chem.,Rapid Commun., **1983**, 4, 731
15. Kumano. A, Niwa. O, Kajiyama. T, Takayanagi. M, Kano. K and Shinkai. S, Chem.Lett., **1980**, 421
16. Okahata. Y, Lim. H, Hachiya. S, Macromol.Chem.Rapid.Communi., **1983**, 4, 303
17. Ishihara. K, Hawada. N, Kato. S and Shinohara. I, J.Polym.Sci.,Chem.Ed., **1983**, 21, 1551

18. Ishihara. K, Negishi. N and Shinohara. I, J.Polym.Sci., Chem.Ed., **1982**, 27, 1897
19. Ishihara. K, Kato. S and Shinohara. I, J.Appl.Polym.Sci., **1982**, 27, 4273

mers depend not only

Surface treatment

in the electrolytic

solution of anfer

can yield pe

with the

surface

of the

of the

of the

of the

of the

of the

of the

of the

of the

of the

of the

of the

of the

of the

of the

of the

of the

of the

of the

of the

of the

of the

of the

of the

of the

of the

of the

of the

CHAPTER VI

SURFACE ETCHING OF POLYETHYLENE

6.1 INTRODUCTION

Physical and mechanical properties of polymers depend not only on the chemical structure of the polymers but also on their topology. Surface treatment of various polymers (PE or PP) by oxidizing solutions has been practiced in the electroplating industry to enhance metal to polymer adhesion. It was found that a solution of sulfuric acid solution saturated with chromium trioxide at a temperature of about 80°C can yield platable and a strongly adhesive ABS and polypropylene surfaces.^{1,2} In earlier work, the problem was tackled completely from a mechanical point of view.³ However, later studies based largely on the development of surface sensitive analytical techniques were more phenomenological. The characterization of polymer topology contributing to properties and behavior of plastics products is very important from the practical point of view. Kaczmarek⁴ studied surface topology of different polymers such as poly(2,6-dimethyl-1,4-phenylene oxide), cis-1,4-polybutadiene, poly(ethylene imine) generation exposure to UV light irradiation. From scanning electron microscopy it was observed that different sizes and shapes of microspores and cracks are generated on the surface which in turn is dependent on the structure of polymer and the irradiation condition. The formation of micropores and cracks are due to evaporation of gaseous degraded product from the polymer surface upon irradiation by UV light irradiation. Kaminska et al⁵ also examined the effect of UV light irradiation on PVC film. They demonstrated the appearance of numerous blisters and voids on the surface. Upon UV light irradiation of the sample HCl gas is generated from the surface leaving behind voids. Srinivasan^{6,7} developed a technique for precise etching of polymers such as polyimide, PET and PMMA using UV laser pulses, which is useful in the microelectronics industry. He proposed that due to the interaction of the laser beam with the polymer surface, various fragments are generated. When these fragments leave the surface, holes are created.

Although examples of chemical treatment and UV-irradiation are reported for etching of polymer surfaces, use of electron beam has not been reported in the prior literature. Azobenzene group is known to be labile to high energy radiation, leading to bond scission and extrusion of nitrogen gas. Therefore, it was reasoned that if a polymer surface containing chemically bound azobenzene group is subjected to high energy radiation, there may deep seated changes in surface topology may occur arising out of loss of molecular fragments. This chapter reports the results of this study.

6.2 EXPERIMENTAL

6.2.1 Materials

p-Phenylene diamine (s.d.fine chemicals, India) was recrystallized from ethanol and sublimed in vacuum. Aniline (s.d.fine chemicals, India) was dried with CaH_2 and distilled under reduced pressure. Other reagents are same as mentioned in section 3.2.1.

6.2.2 Analysis

FT-IR spectra of polymer films were recorded on a Perkin Elmer 16 PC spectrophotometer. UV spectroscopy was performed on a Hewlett Packard 8452 A Diode Array spectrophotometer. SEM was recorded on a Stereo Scan 440 Scanning Electron Microscopy, Leica, Cambridge. X-ray photoelectron spectroscopy (XPS) studies were carried out using a VG Scientific ESCA-3-MK-II electron spectrometer fitted with a $\text{Mg K}\alpha$ (1253.6 eV) X-ray source (non-monochromatic). The anode was operated at 120 W (12kV, 10 mA), and the analyzer was operated at a constant pass energy of 50eV. Plasma irradiation experiment was performed on a MPS-300 Plasma reactor, March Scientific Co. USA. Samples were weighed on a Mettler-M5 microbalance for gravimetric analysis which has a weighing accuracy of ± 0.0005 mg.

6.2.3 Methods

6.2.3.1 Poly(ethylene) film bearing succinic anhydride group (1)

The procedure is described in section 3.2.2.2, except irradiation time (2 h).

6.2.3.2 Poly(ethylene) film bearing mono azobenzene (4)

The procedure is described in section 4.2.2.4

6.2.3.3 Poly(ethylene) film bearing benzamide (6)

The film 1 (scheme 6.1) was immersed in aniline at 25°C for 3 h. The film was extracted using hot chloroform and dried under vacuum at 30°C for 4 h.

6.2.3.4 Poly(ethylene) film bearing p-aminobenzamide (24)

The film **1** (scheme 6.1) was immersed in 0.01M solution of p-phenylene diamine in chloroform for 3 h at 25°C. The film was extracted using hot chloroform and dried under vacuum at 30°C for 2 h.

6.2.3.5 Poly(ethylene) film bearing diazonium salt (25)

The modified film **24** (scheme 6.1) was immersed in 1M HCl for 30 min at 0°C. Saturated NaNO₂ solution (0°C) was added slowly and kept for 30 min at 0°C. The film was rinsed by water and dried under vacuum for 2 h.

6.2.3.6 Electron beam irradiation

Polyethylene film bearing the azobenzene group (**4**, scheme 6.1) was irradiated using an electron beam (10 KeV) for 20 min (10 min one side) at 10⁻⁵ torr pressure and the irradiated sample was examined by UV-Visible spectroscopy.

6.2.3.7 Plasma exposure

Polyethylene film bearing the azobenzene group (**4**, scheme 6.1) was exposed to nitrogen plasma for 1 min at 10 ml/min flow rate, 100w power, 190 millitorr pressure and the exposed sample was examined by UV-Visible spectroscopy.

6.2.4.8 Thermal treatment

Polyethylene film bearing the diazonium salt (**25**, scheme 6.1) was heated at 75°C for 2h under 10 mmHg vacuum and the sample was examined by FT-IR spectroscopy.

The concentration of the azobenzene and the p-aminobenzamide groups were determined by UV-visible spectroscopy and gravimetric analysis as described in chapter III.

6.3 RESULTS AND DISCUSSION

6.3.1 Proof of functionality

The preparation of various surface modified polyethylene films is shown in Scheme 6.1. The FT-IR transmission of samples **4** and **6** are discussed in chapter IV. FT-IR of film **24** exhibits peaks at 1720 (C=O) and 1678 (amide) cm⁻¹ whereas film **25** an additional peak appears at 2240 cm⁻¹ (N≡N).

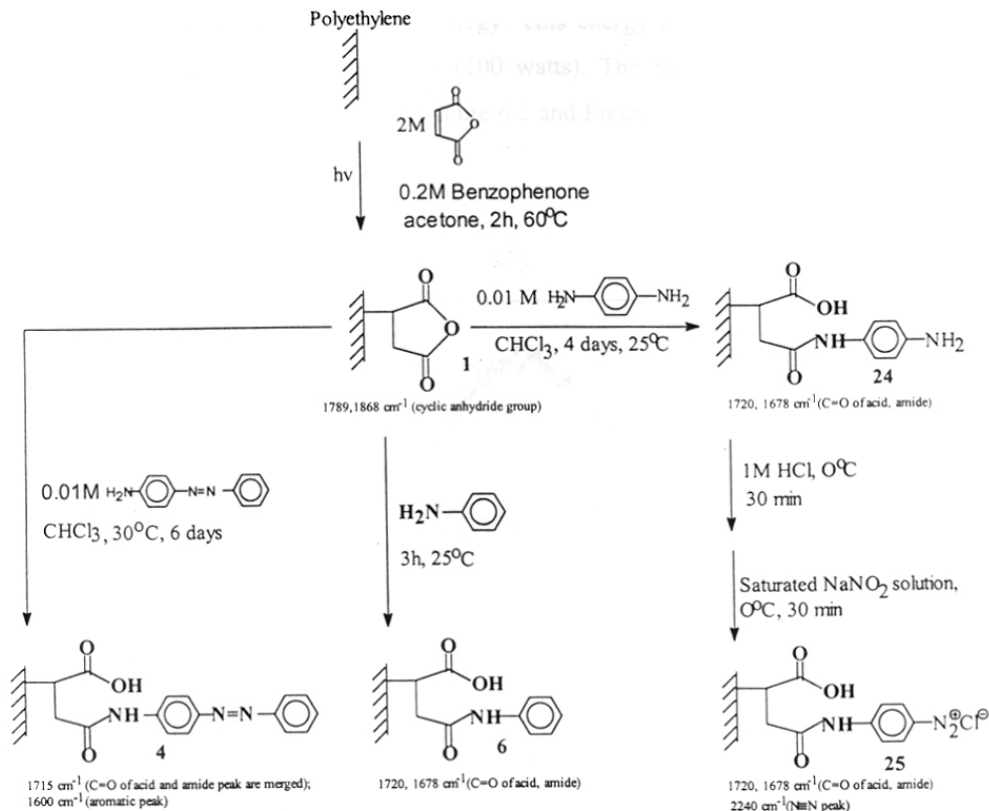

Scheme 6.1: Synthetic route for obtaining polyethylene film-bound succinic anhydride, azobenzene, benzamide, p-aminebenzamide and diazonium salt

6.3.2 Etching of modified polyethylene surface by high energy radiation

Film 4 was subjected to XPS analysis (Figure 6.1). Surprisingly the XPS did not show any peak with a BE of 400 eV corresponding to the N_{1s} peak. This is in contrast to the XPS spectra of film 6 which shows a peak at 400 eV (Figure 6.1). Thus, it became apparent that, under the impact of electron energy, some irreversible changes in the chemical composition of film 4 were occurring. It was suspected that the labile azo functionality underwent chemical degradation, leading to loss of nitrogen-containing functional groups.

To further probe this observation, films 4 and 6 were subjected to SEM analysis. The samples were exposed to an electron beam irradiation in the vacuum sample chamber of an

SEM for 20 min. using a 10^{-6} Watts energy. This energy is substantially lower than energy of an electron used in an XPS (100 watts). The SEM photographs of exposed samples of films 4 and 6 are shown in Figure 6.2 and Figure 6.3 respectively at comparable magnifications.

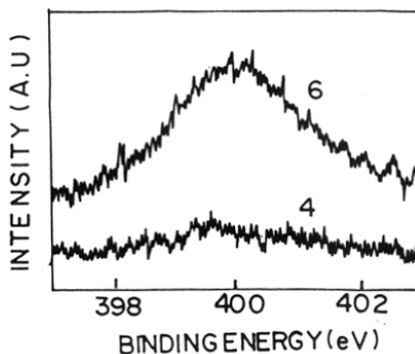
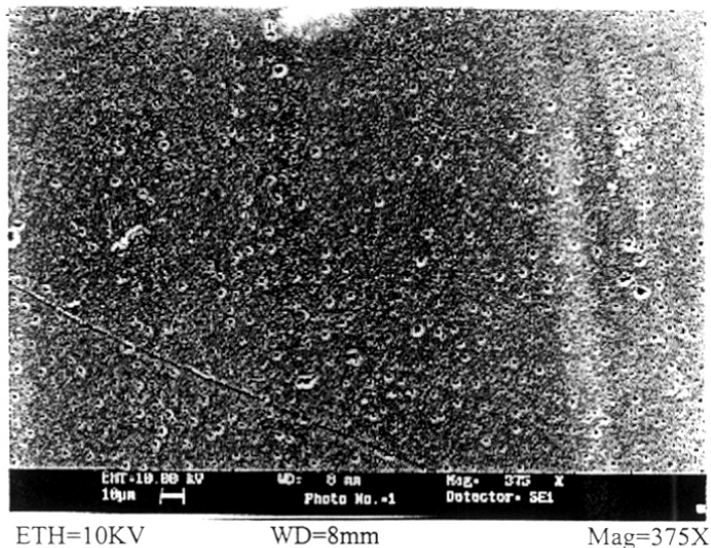
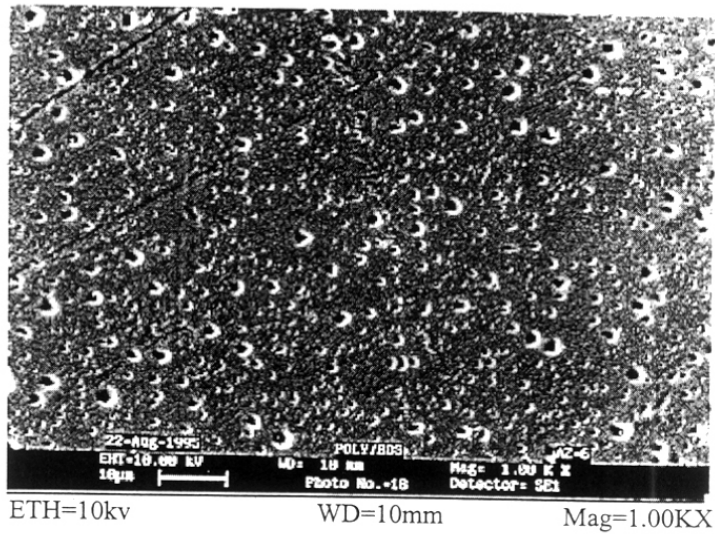

Figure 6.1: XPS spectra of nitrogen (a) sample 4 (b) sample 6



a

Figure 6.2: SEM microphotographs of sample 4: (a) low magnification



b

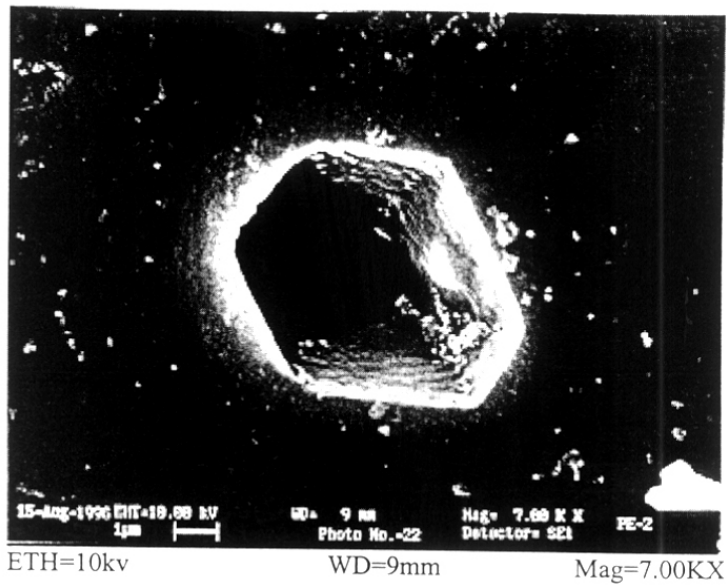

c

Figure 6.2: SEM microphotographs of sample 4: (b) medium magnification (c) high magnification

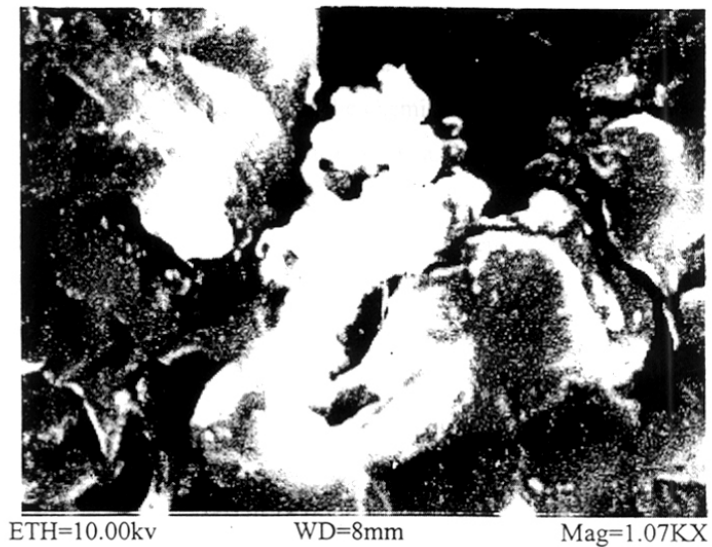

a

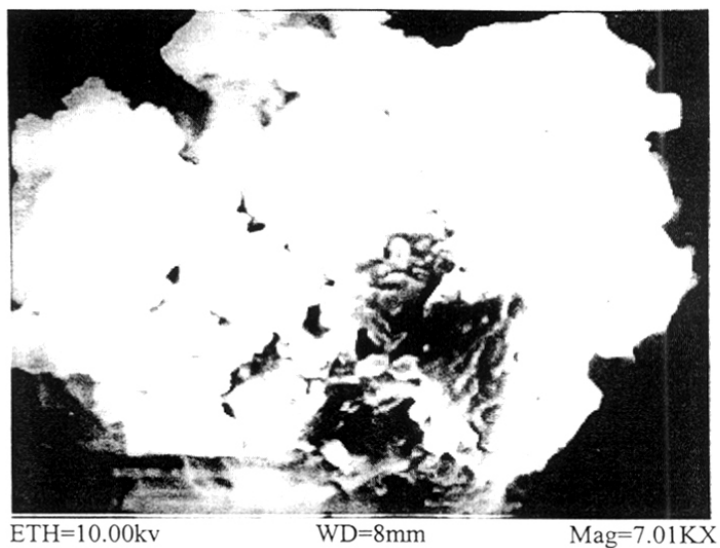

b

Figure 6.3: SEM microphotographs of sample 6: (a) low magnification (b) high magnification

To further confirm this hypothesis, film **4** was exposed to plasma radiation for 1 min in a plasma chamber. Plasma is another source of high energy radiation with an energy of cause weak chemical links to break. A sample of film **4** after exposure to plasma was immediately subjected SEM analysis. The SEM picture (Figure 6.5) is similar to the one shown in Figure 6.2. The film **4** after exposure to plasma was also analysed by XPS. Once again no peaks due to nitrogen were found.

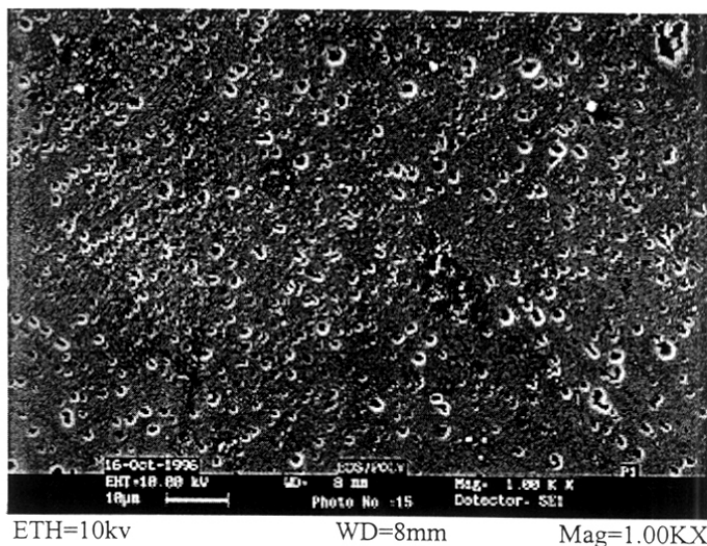

Figure 6.5: SEM microphotographs of sample 4 after plasma exposure

6.3.3 Thermal etching

If nitrogen extrusion were the cause of the observed surface pitting in case of polyethylene film bearing azobenzene functionality, than it was reasoned that any alter nature way of “splitting off” nitrogen from the surface/bulk of a polymer film should also lead to similar observations. Aromatic diazonium salts are known to be thermally labile and decompose by eliminating nitrogen. Therefore, a polyethylene film bearing a diazonium chloride functionality was prepared according to Scheme 6.1. The film **25** was prepared by diazotizing the corresponding amine (film **24**). The concentration p-aminobenzamide was determined by UV-visible spectroscopy and was found to be $0.25 \mu\text{mol}/\text{cm}^2$. The concentration as obtained by gravimetry was $0.23 \mu\text{mol}/\text{cm}^2$ (Table 6.1).

Table 6.1: Concentration of polyethylene film bearing azobenzene and p-aminobenzamide (2 h irradiated sample)

| Sample | Concentration $\mu\text{mol.cm}^{-2}$ | |
|--------|---------------------------------------|---------------|
| | by UV | by Gravimetry |
| 4 | 0.30 | 0.31 |
| 6 | 0.25 | 0.23 |

The diazo group bearing polyethylene film **25** upon heating at 75°C for 2 h under a 10 mmHg vacuum suffered a loss of nitrogen as evidenced by the absence of the peak at 2240 cm^{-1} (Figure 6.6). The film **25** after thermal treatment was examined by SEM Figure 6.7. Craters on the surface are observed, similar to Figure 6.2, confirming that extrusion of N_2 causes surface pitting. The craters cross section were in the range of 5 to 10 micron.

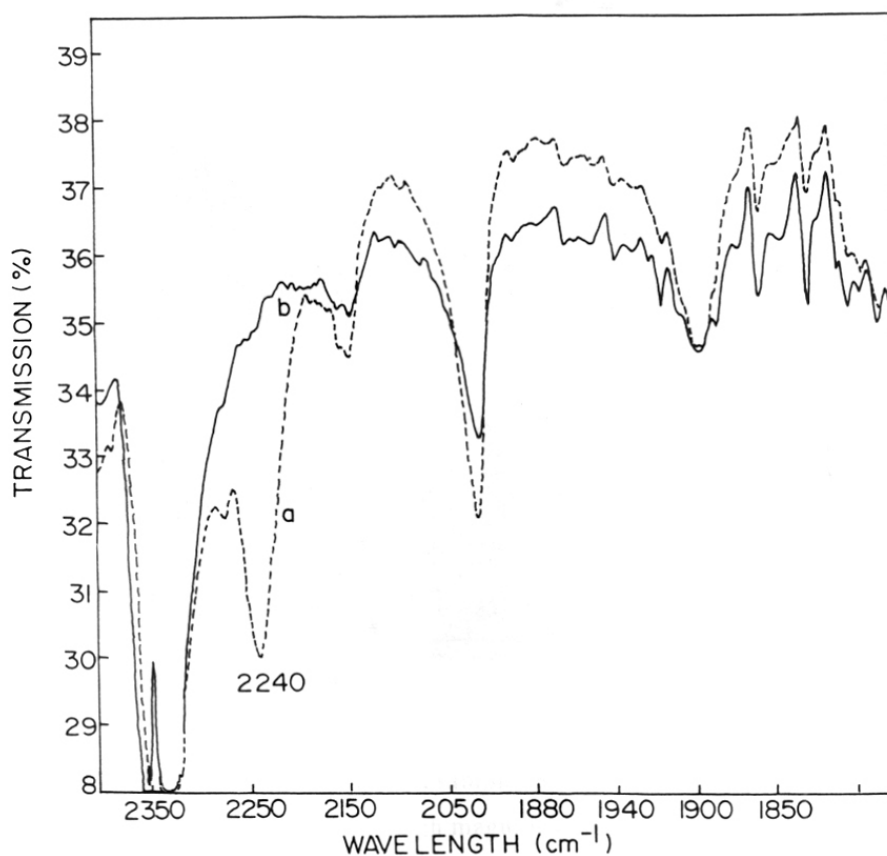
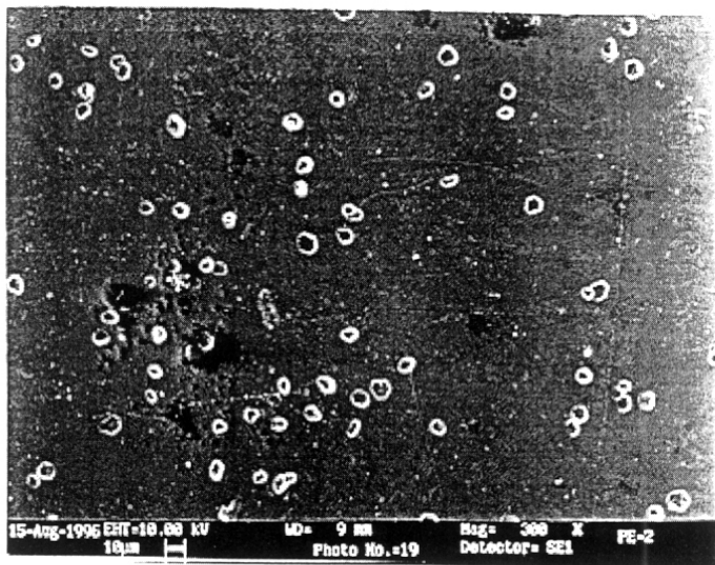
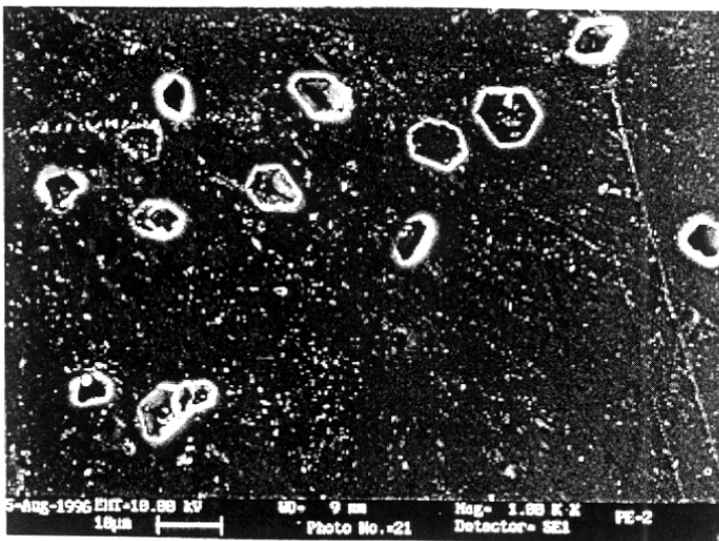

Figure 6.6: FTIR spectra of sample 25 : (a) before heating (b) after heating



ETH=10kv WD=9mm Mag=300X

a



ETH=10kv WD=9mm Mag=1.00KX

b

Figure 6.7: SEM microphotographs of sample 25, after heating: (a) low magnification
(b) high magnification

The surface topography of the polymers play a determinant role in the adhesive, optical and wetting characteristics of the surface. There are numerous applications of polymers in which control of surface topography is also desirable. In particular, the ability to create surface topography of controlled length scales could be useful for varying surface sheen, decreasing glare, improving wetting or increasing mechanical adhesion. Chemical etching is often employed to create surface inhomogeneity for electroless plating of thermoplastics. In these cases, the surface pits are used to mechanically bind the colloidal Pd and Sn which function as the substrate for electroplating.⁸

The use of appropriately surface functionalized polymers thus enables generation of novel surface topographical features using non-invasive energy sources such as plasma, electron beam or heat. The technique is clean and fast. However, sufficient information is not available to speculate on the degree of control that is possible using this method for inducing surface topographical changes in polymers.

6.4 CONCLUSION

The experimental results demonstrate that surface etching is possible by exposing appropriate functional groups chemically linked to a polymer surface to high energy irradiation (plasma, electron beam or heat). Surface etching has been characterized by various analytical tools such as XPS, SEM, UV-visible spectroscopy and FTIR. Azo group is found to be most effective in generating "craters" on the polymer surface.

6.5 REFERENCES

1. Kato. K, *Polymer*, **1968**, 9, 419
2. Fitchmun. D.R, Newman. S, Wiggle. R. J, *Appl.Polym.Sci.*, **1970**, 14, 2457
3. Garbassi. F, Morra. M, Occhiello. E, *Polymer Surfaces from Physics to Technology*. John Wiley & Sons Ltd, Chichester, **1994**, Chapter 10,13
4. Kaczmarek. H, *Polymer*,**1996**, 37, 189
5. Kaminska. A, Kaminiski. J, Rozploch. F, Kaczmarek. H, *Angew.Makromol.Chem.*,

- 1989**, 169, 185
6. Srinivasan. R, Braren. B, Chem.Rev., **1989**, 89, 1303
 7. Srinivasan. R, Polym.Degrad.Stabil., **1994**, 43(1), 101
 8. Chan. C. M, Polymer Surface Modification and Characterization. Hanser, New York, **1994**, p 28

CHAPTER VII

**APPLICATION OF SURFACE FUNCTIONALIZED POLYOLEFINS: SURFACE
ANCHORED HINDERED AMINE LIGHT STABILIZERS FOR IMPROVED U.V
STABILITY OF POLYOLEFINS**

7.1 INTRODUCTION

Polymers are susceptible to degradation by oxygen in combination with UV light or heat. The oxidative degradation can be partially prevented by introducing suitable stabilizers into the polymer by melt blending. Compatible and mobile stabilizers usually give the best protection, but low molecular weight stabilizers are easily lost from the polymer through migration, evaporation, or extraction. To avoid such loss, polymeric stabilizers have been introduced, but the low mobility and poor compatibility of polymeric stabilizers decreases their efficiency.¹ The oxidation and degradation of a polypropylene film starts from the surface and slowly proceeds into the interior of the polymer.^{2,3} Stabilizers are therefore expected to be most effective if they are concentrated at the surface, where the oxidation takes place. However, when situated at the surface they are easily lost through evaporation or extraction. To prevent such loss they should preferably be anchored chemically to the polymer surface.

Surface grafting of stabilizers has been reported as a convenient technique for attaching a stabilizer to the polymer in a permanent manner.⁴⁻⁶ Recently, there has been great interest in the use of polymer-bound stabilizers to control the location of the stabilizers in polymer systems.⁷⁻⁹ Acrylic coating have been developed employing a bound hindered amine light stabilizer. These coatings exhibit superior weatherability over similar acrylic coatings using free HALS.¹⁰⁻¹³ In particular, this approach has been used to control the leaching of stabilizers from polymers, and is particularly useful in coating systems. Recently, Al-Malaika et al. have achieved high level of grafting of a HALS type stabilizer onto polyolefins using reactive processing techniques.¹⁴⁻¹⁶

In this chapter a mild photochemical technique was explored for surface functionalization of polyolefins which introduced succinic anhydride group onto the polymer surface.¹⁷ The technique is clean and proceeds with a high degree of chemo- and topological selectivity. Succinic anhydride is a reactive functional group to which a number of other functionalities can be attached through simple chemical reactions. The objective of the present work was, therefore, to anchor a HALS to the surface of a polyolefin through the succinic anhydride moiety (Scheme 7.1) and to examine the UV stability of such surface modified polymers.

The HALS used were 1,2,2,6,6-pentamethyl-4-piperidinol (HALS-1) and 2,2,6,6-pentamethyl-4-aminopiperidine (HALS-2).

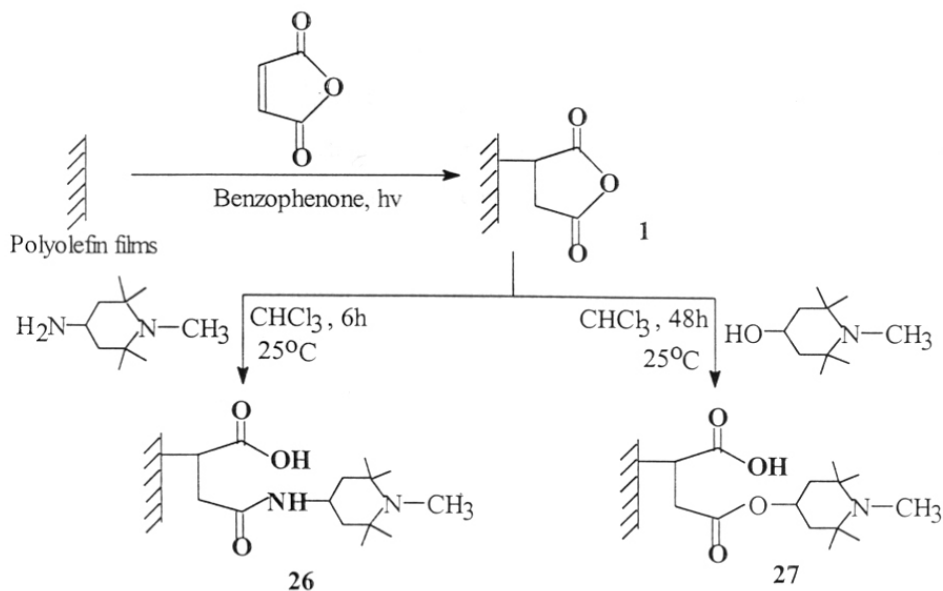

Scheme 7.1: Synthetic route for obtaining polymer-bound hindered amine light stabilizers

7.2 EXPERIMENTAL

7.2.1 Materials

Commercial samples of isotactic polypropylene (i-PP, Koylene S3030), low density polyethylene (LDPE, Indothene 16MA400) from Indian Petrochemicals Corp. Ltd., Baroda, India, and heterophasic ethylene-propylene copolymer (EPQ 30R, MI = 0.6-0.9, 15.1 mol % ethylene) from Himont, Italia were used in this study. Commercial hindered amine light stabilizer (HALS), Tinuvin 770 (bis(2,2,6,6-tetramethyl-4-piperidinyl)sebacate, white crystals, mp $81\text{-}83^\circ\text{C}$, $M_n = 480.7$) from Ciba-Geigy, Switzerland, was used as reference for comparison. Maleic anhydride (E. Merck, India) was recrystallized from chloroform and stored under desiccator. Benzophenone (Aldrich) was recrystallized from ethanol.

FT-IR measurements were carried out with a Perkin-Elmer 16PC Spectrometer and UV analysis were carried out from chloroform solutions with a HP 8452A Diode Array Spectrophotometer. Polymers were purified from free of additives and stabilizers and film

samples prepared by melt pressing. The method of purification and sample preparation (80 μm thick film) have been described elsewhere.¹⁸ All solvents used were purified by literature procedures.¹⁹

7.2.2 Methods

7.2.2.1 Synthesis of hindered amine light stabilizers (HALS)

Synthesis of 1,2,2,6,6-Pentamethyl-4-piperidinol:

Triacetoneamine(4-oxo-2,2,6,6-tetramethyl piperidine) was synthesized from the condensation of acetone with ammonia in the presence of calcium chloride as per literature procedure.²⁰

1,2,2,6,6-tetramethyl-4-piperidinol was prepared by reported procedure reference 21. Yield 92 %, mp 72-74°C, (Lit.mp 73-74°C²⁰).

Synthesis of 1,2,2,6,6-Pentamethyl-4-aminopiperidine²²:

9.2g (0.05 mol) of 1,2,2,6,6- pentamethyl-4-piperidone oxime²¹ was dissolved in 80 mL of methanol with ammonium hydroxide (5 mL) and Raney nickel (1.5 g) was hydrogenated at atmospheric pressure in room temperature for 4 h. The catalyst was filtered and washed with dichloromethane, dried with sodium sulfate and the product was distilled under vacuum at 15 mm, bp 97-99° (Lit. bp 85-86°C at 10 mm Hg²¹).

7.2.2.2 Preparation of polyolefin surfaces bearing succinic anhydride groups

Thin film of polyolefin (thickness 80 μm) was suspended in a small glass reactor. A beaker containing 25 mL solution of maleic anhydride (7.35 g) and benzophenone (1.35 g) in dry acetone was placed alongside. The reactor was purged with nitrogen for 20 min to remove any oxygen present. The reactor was placed in a UV chamber equipped with an electrical heating arrangement. The temperature of the reactor was raised to 60°C. The film was irradiated for 2 h using a 400 W high pressure mercury vapour lamp, which emitted light in the near UV region ($\lambda > 290 \text{ nm}$). The distance between the reactor and UV lamp was 18 cm. The reaction was presumed to occur equally on both sides of the free standing film since the monomer and sensitizer were in the vapour phase surrounding the film. The modified polyethylene film thus produced was Soxhlet extracted with acetone for 8 h, dried under vacuum at 30°C and stored under N_2 atmosphere.

7.2.2.3 Preparation of polyethylene polymer-bound HALS-1 (27,PB-HALS-1)

Surface modified polyethylene film (3x1 cm^2) bearing succinic anhydride group was reacted with 1,2,2,6,6-pentamethyl-4-piperidinol (0.016 M) in dry chloroform for 48 h at 25°C with

occasional stirring. Completion of the reaction was monitored by FT-IR. The film was soxhlet extracted with chloroform for 5 h to remove any unreacted HALS.

7.2.2.4 Preparation of polyethylene polymer-bound HALS-2 (26,PB-HALS-2)

Surface modified polyethylene film ($3 \times 1 \text{ cm}^2$) bearing succinic anhydride group was reacted with 1,2,2,6,6-pentamethyl-4-aminopiperidine (0.016 M) in dry chloroform for 6 h at 25°C with occasional stirring. Completion of the reaction was monitored by FT-IR. Then the film was soxhlet extracted with chloroform 5 h to remove any unreacted HALS. The same procedure was followed in case of polypropylene and heterophasic ethylene-propylene copolymers. A sample of unmodified polyethylene film was treated with HALS-1 and HALS-2 under identical reaction conditions. It was confirmed by UV spectroscopy that there was no HALS either occluded or adsorbed, in the films. Film samples containing commercial HALS (Tinuvin 770, 0.3 wt %) was prepared by melt blending for the comparative study.

7.2.2.5 Analysis of surface concentration

By UV - VIS spectroscopy : Polyolefin film bearing succinic anhydride groups ($1 \times 3 \text{ cm}^2$) was immersed in 5 mL of 0.016 M 1,2,2,6,6-pentamethyl-4-piperidinol solution in chloroform. The film was allowed to react with HALS at 25°C for 48 h with occasional stirring. A blank experiment was conducted with untreated polyolefin film under identical conditions. The concentration of the HALS after reaction with the surface anhydride groups of the film was determined by UV-Visible spectroscopy. Prior to this a calibration was drawn from UV absorptions of HALS solution of known concentration. The depletion of HALS concentration in the solution gave a measure of surface concentration of HALS.

By Gravimetry : Gravimetric analysis was used to calculate the amount of HALS on polyethylene surface. From the increase in weight, before and after HALS incorporation, the mol of HALS present/ cm^2 was calculated (Table 7.1).

Table 7.1: Concentration of polymer-bound HALS-2 present in polyolefin films

| Sample | Concentration $\mu\text{mol.cm}^{-2}$ | |
|--------|---------------------------------------|---------------|
| | by UV | by Gravimetry |
| 26(PE) | 0.92 | 0.9 |
| 26(PP) | 0.42 | 0.4 |
| 26(EP) | 1.08 | 1.0 |

7.3 RESULTS AND DISCUSSION

Hindered amine light stabilizers (HALS) were surface anchored to polyolefin films by reacting the HALS, namely, 1,2,2,6,6-pentamethyl-4-piperidinol and 1,2,2,6,6-pentamethyl-4-aminopiperidine with succinic anhydride functionalized polyolefin surfaces. The photo-stability of polyolefin films with surface anchored HALS were compared with films stabilized with commercial HALS (Tinuvin 770) by melt blending. It is shown that the photo-stabilizing efficiency of surface anchored HALS is superior that of melt blended polyolefins.

7.3.1 Proof of functionalization

The polyolefin surface bearing succinic anhydride group **1** has been characterized by FT-IR spectroscopy. The IR spectrum of the succinic anhydride modified polyolefin film shows two sharp peaks at 1868 and 1789 cm^{-1} , characteristic of the cyclic anhydride group (Figure 1, curve a).¹⁷ The succinic anhydride functionalized polyolefin films were reacted with 1,2,2,6,6-pentamethyl-4-piperidinol (PB-HALS-1) and 1,2,2,6,6-pentamethyl-4-amino piperidine (PB-HALS-2), FT-IR of these films shows the complete disappearance of peaks at 1868 & 1789 cm^{-1} (Figure 7.1, curve b & c). This confirms that the succinic anhydride groups present in the films were completely reacted with HALS (Scheme 7.1). The IR spectrum of PB-HALS-1 shows a band at 1736 cm^{-1} due to ester linkage and at 1720 cm^{-1} due to acid groups (Figure 7.1, curve b) whereas the IR spectrum of PB-HALS-2 shows peaks at 1669 cm^{-1} and 1720 cm^{-1} for amide and acid groups respectively (Figure 7.1, curve c).

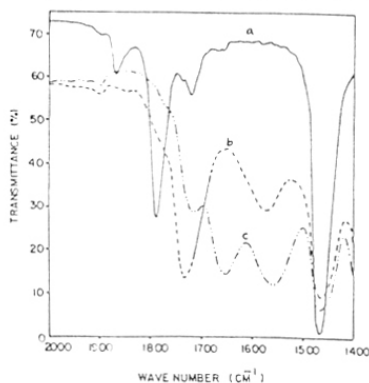

Figure 7.1: FT-IR spectra of polyethylene film. (a) Succinic anhydride modified, (b) PB-HALS-1, (c) PB-HALS-2

The concentration of HALS present on the polymer surface was determined by UV-Visible spectroscopy and gravimetry. The results are shown in Table 7.1 and are indicative of

substantial penetration of the functional group, beyond a monolayer coverage. XPS studies of such surface modified polyethylene indicate a penetration depth of greater than 40-50 Å.²³

7.3.2 Surface protection of polyolefins against degradation

The photo-irradiation was carried out in SEPAP 12/24 photo-irradiation chamber at 60°C. This unit has a UV source supplying radiation longer than 300 nm. The details of the equipment is described elsewhere.¹⁸

Photostabilizing efficiency of PB-HALS-1 and PB-HALS-2 in polyethylene, polypropylene and heterophasic ethylene-propylene copolymer was studied from the carbonyl group formation with irradiation time and their performance compared with polymers, prepared by melt blending. The carbonyl group formation in surface modified polyethylene upon photo irradiation is shown in Figure 7.2.

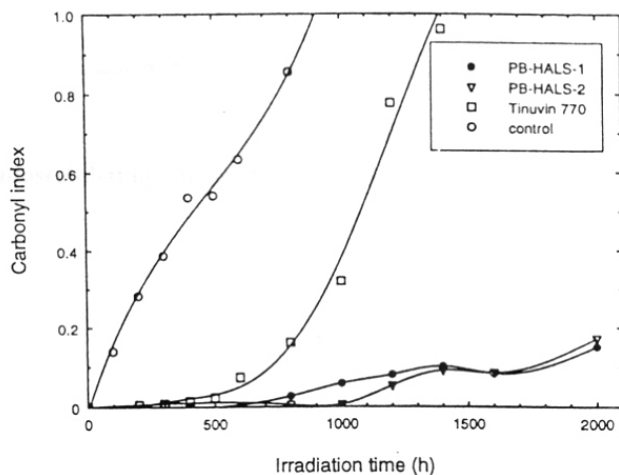

Figure 7.2: Photostabilizing efficiency of polymer-bound HALS and Tinuvin 770 in polyethylene films

The rate of carbonyl index formation was plotted against irradiation time. Unprotected polyethylene showed a rapid increase in the carbonyl absorbance after only 25 h of irradiation. PB-HALS-1 and PB-HALS-2 shows remarkable photo-stability compared to the polymer stabilized with melt blended Tinuvin 770. In the case of melt blended HALS, a

carbonyl absorbance value of 0.1 reaches within 100 h irradiation time whereas in the case of polymer-bound

HALS there was no significant carbonyl group absorbance upto 600 h and upon longer irradiation time, a slow increase in carbonyl index was observed. The carbonyl group formation upon irradiation of a surface modified polypropylene and a heterophasic E-P copolymer is shown in Figures 7.3 and 7.4, respectively.

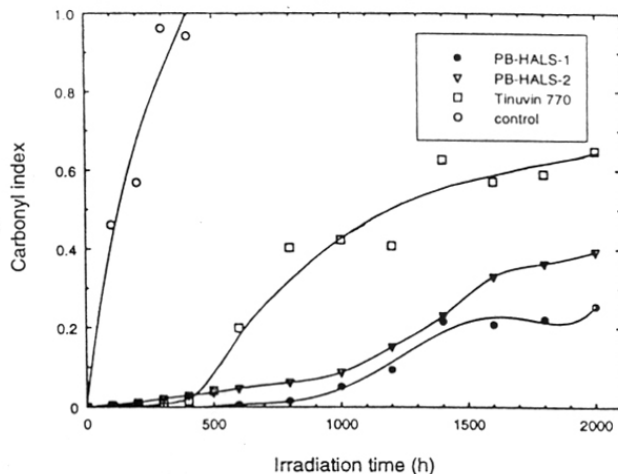

Figure 7.3: Photostabilizing efficiency of polymer-bound HALS and Tinuvin 770 in polypropylene films

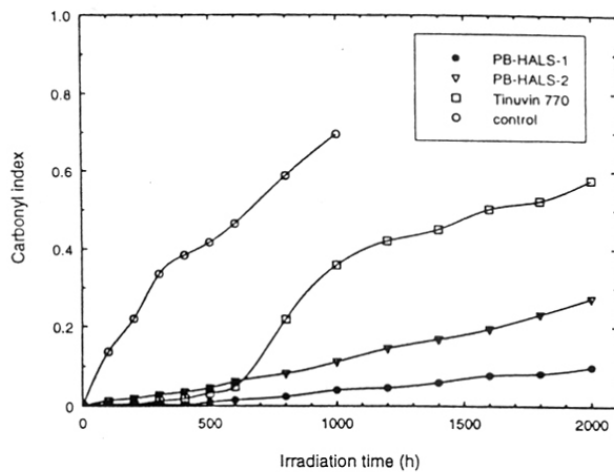

Figure 7.4: Photostabilizing efficiency of polymer-bound HALS and Tinuvin 770 in E-P copolymer films

In these cases also remarkable photo stabilizing efficiency was observed in case of HALS surface anchored to polyolefins. PB-HALS-1 shows a better effect on the photo stability as compared to PB-HALS-2 in all cases. Shlyapinthok²⁴ reported that, if the NH-group is not so fully hindered as in 2,2,6,6-tetramethylpiperidine derivatives, the photostabilizing efficiency was considerably reduced. Since the nitroxyl radicals corresponding to such amines are not stable this result was taken as a confirmation for the prime role of nitroxyl radicals. Since nitroxyl radicals were known as efficient traps for alkyl radicals it was postulated that they were the main active species in stabilization. However, both PB-HALS-1 and PB-HALS-2 show remarkable photo stability. Ranby et al.²⁵ have reported that polypropylene is effectively protected against UV initiated degradation by grafting the PP surface with glycidyl methacrylate in thin surface layers followed by chemical attachment of HALS to the oxirane group.

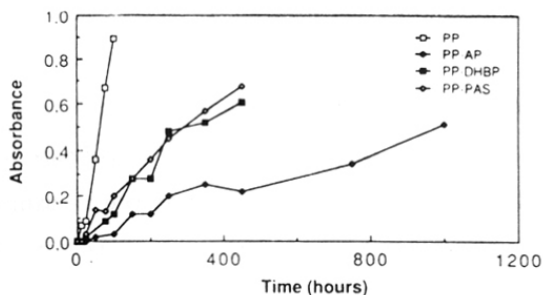

Figure 7.5: Carbonyl absorbance for PP film grafted with hindered amine: 4-amino-2,2,4,4-tetramethylpiperidine (AP), 2,4-dihydroxybenzophenone (DHBP), phenyl 4-aminosalicylate (PAS), irradiated in UVICON at 50°C for different times

A similar surface grafting led to no significant stabilizing effect in case of polyethylene. Similarly, Mingbo and Xingzhou⁵ have shown that polypropylene film photo-grafted on the surface with 2,2,6,6-tetramethyl-4-piperidinyl methacrylate showed a high degree of photostabilization. PB-HALS-1 showed a better effectiveness compared to other reported^{5,25} polymer-bound HALS. The increase in carbonyl group was observed only after an induction period of 600 h whereas in the case of polypropylene grafted with 2,2,6,6-tetramethyl-4-piperidyl-methacrylate⁵ it was 200 h and 100 h in polypropylene grafted with aminotetramethylpiperidine.²⁵

One of the ambiguities in the anchoring of a stabilizer to a polymeric surface is the lack of precise knowledge of the depths upto which the stabilizer molecules have penetrated into the polymer bulk. We have reasons to believe that under the conditions employed in the present study, the reactions occur upto depths of several hundreds of angstroms. It is reasonable to assume that for any appreciable stabilizing action, the stabilizer should be present in sufficient concentration upto reasonable depths. Carlsson and Wiles^{2,3,26} showed using ATR that the oxidation of unstabilized polypropylene was confined to about 10 microns (100,000 Å) depth. This is because oxygen diffusion decreases rapidly as one proceeds from the surface to core and maximum damage due to photo-oxidation occurs in regions where the dissolved oxygen concentration is very high. A similar observation was also made in case of polyethylene.²⁷ We do not have a definite knowledge of the precise depths upto which HALS is present in the present case. However, the result indicate that adequate concentration of HALS is present in sufficient depths for effective photostabilization. The effectiveness of surface anchored stabilizer is also related to the physical proximity between the stabilizer molecule and the hydroperoxidation site. The fact that surface anchored stabilizers of the type studied here shows better photostability indicates that the stabilizer is present more or less uniformly throughout the polymer, and especially in regions of high oxygen concentrations, which are likely site for radical formation.

7.4 CONCLUSIONS

Polyethylene, polypropylene and heterophasic E-P copolymer films were effectively protected against photo-irradiation by anchoring HALS onto the succinic anhydride modified polymer surfaces. The improved photostability of such materials must be attributed to the chemical bonding between the additive and the polymer surface and hence to its permanence.

7.5 REFERENCES

1. Luston. J, Development in Polymer Stabilization-2, Applied Science Publishers, London, 1980, p. 185-236.
2. Carlsson. D.J and Wiles. D.M, Macromolecules, 1971, 4(2), 174
3. Carlsson. D.J and Wiles. D.M, Macromolecules, 1971, 4(2), 179

4. Singh. R.P, Prog. Polym. Sci, **1992**, 17, 251
5. Mingbo. H and Xingzhou. H, Polym. Degrnd. Stab, **1987**, 18, 321
6. Ranby. B, Macromol. Chem., Macromol. Symp., **1992**, 63, 55
7. Scott. G, in Developments in Polymer Stabilization-1, ed. G. Scott. Elsevier Applied Science, New York, **1979**, p. 309.
8. Rekers. J.W and Scott. G, **1988**, May, U.S. Patent 4,356,307
9. Kelkenberg. H and Wolf. E, **1982**, Oct. 26, U.S. Patent 4,365,307
10. Kamath. V.R and Sargent. J.D, **1990**, U.S. Patent 4,927,891
11. Callais. P.A, Kamath. V.R and Sargent. J.D, Polymer-bound stabilizer coatings: The synthesis of acrylic HSC resins with peroxides containing hindered amine light stabilizer groups. Proc. Water-Borne & Higher Solids Coatings Symposium, Feb.3-5, Vol. 15, **1988**, New Orleans, LA, USA, p.104.
12. Callais. P.A, Kamath. V.R and Sargent. J.D, High solids coating compositions containing polymer-bound light stabilizer acrylic resins. Proc. Water-Borne & Higher Solids Coatings Symposium, Feb.1-3, Vol.16, **1989**, New Orleans, LA, USA, p.486.
13. Palys. L.H, Photostabilization of polypropylene using alkyl succinimide and polymer-bound hindered amine light stabilizers. Proc. of Reinforcement Impact Modification and Nucleation of Polymers Conference (RETEC), Feb. 25-27, **1990**, Houston, TX, p.199.
14. Al-Malaika. S, CHEMTECH, **1990**, 366
15. Al-Malaika. S, Ibrahim. A.Q, Rao. M.J and Scott. G, J. Appl. Polym. Sci., **1992**, 44, 1287
16. Al-Malaika. S, Scott. G and Wirjosentono. B, Polym. Degrnd. Stab., **1993**, 40, 233
17. Sarkar. N, Bhattacharjee. S and Sivaram. S, Langmuir, **1997**, 13, 4142.
18. Mani. R, Singh. R.P, Sivaram. S and Lacoste. J, Polym. J, **1994**, 26, 1132,
19. Perrin. D.D and Armarego. W.L.F, Purification of laboratory chemicals, 3rd ed., Pergamon press, Oxford, **1988**.
20. Sosnovsky. G and Konieczny. M, Synthesis., **1976**, 735
21. Lutz. W.B, Lazams. S and Meltzer. R.I, J. Org. Chem., **1962**, 27, 1695
22. Danso-Danquah. R.E, Scott. A.I and Becker. D, Tetrahedron, **1993**, 49, 8195
23. Sarkar. N and Sivaram. S, (Unpublished results).

24. Shlyapinthok. V.Ya, Bystritzkaya. E.V, Shapiro. A.B, Smirnov. L.N and Rozantsev. E.G, *Nauk. I.A, USSR, Ser. Khim.*, 1973, 1915
25. Allmer. K, Hult. A and Ranby. B, *J. Polym. Sci., Part A: Polym. Chem*, 1989, 27, 3419
26. Carlsson. D.J and Wiles. D.M, *J. Polym. Sci. Polym. Lett. Ed.*, 1971, 8, 419,
27. Gugumus. F, *Angew. Makromol. Chem.*, 1990, 182, 85, 111

CHAPTER VIII

SUMMARY AND CONCLUSION

Succinic anhydride groups have been introduced on to the surface of poly(ethylene) films by a mild photochemical process. The surface functionality were characterized by ATR-FTIR, XPS, UV-visible spectroscopy and the measurement of solid/liquid contact angles. Surface functionality was determined by ATR-IR. The surface concentration of functional group was approximately 1.2×10^{15} molecules/cm². Angle dependent XPS ($\theta = 35^\circ, 55^\circ, 75^\circ$) study indicates that surface selective reaction occurred on the surface of poly(ethylene). The poly(ethylene) surface modified by succinic anhydride group undergoes facile transformation to various functional groups such as acid, esters, amide by reaction with water, alcohols and amines. In order to study such transformations and to evaluate the behavior of such modified surfaces, polyethylene film with higher concentration of succinic anhydride (greater depth of functionalization) were prepared. This was achieved simply by increasing the irradiation time of the film. For many practical applications of modified surfaces, reaction in depth may not only be acceptable, but, in some cases even desirable. Higher depths of functionalization upon increased irradiation time was evidenced by an ability to observe the functionality in a transmission mode in FT-IR and the absence of change in the intensity ratio of O_{1s}/C_{total} and C_{289}/C_{total} with increasing take off angle. The succinic anhydride modified poly(ethylene) was transformed into a carboxylic acid by simple hydrolysis or to mono functionality by treating with the corresponding amines or esters. The dicarboxylic acid was transformed to a diacid chloride which was converted to a diamide or diester. Wide variations in wettability ($\theta = 40-106^\circ$) of the poly(ethylene) surface was observed depending on the nature of chemical functionality and manner of their attachment.

Azobenzenes were anchored onto poly(olefin) films by reacting the various amino azobenzenes with succinic anhydride functionalized poly(olefin) surfaces. These azobenzene group bound to poly(ethylene) film responds to external stimuli such as light or heat and undergoes E:Z isomerization. The thermal rate of relaxation depends on manner of chromophore, type of attachment to the polymer backbone and the nature of the polymer. The azobenzene containing electron acceptor groups shows a fast thermal Z→E isomerization rate. Steric factor also influences the rate of relaxation. The thermal Z→E isomerization of azobenzene in semicrystalline polymer film was compared with that of an

amorphous polymer film. It was observed that the amorphous polymer relaxes more slowly as compared to the semicrystalline polymer.

Poly(ethylene) surfaces bearing labile groups such as azo and diazonium linkages underwent bond scission, leading to expulsion of nitrogen upon exposure to electron energy, plasma irradiation or thermal energy. This phenomenon leads to substantial topographical changes as evidenced by appearance of surface "craters" or "pits" as shown by SEM. Thus polymer surfaces containing functionality which are labile may offer an interesting approach to bring about topographical changes on the surfaces of polymers.

Hindered amine light stabilizers (HALS) were anchored on to poly(olefin) films by reacting HALS, namely 1,2,2,6,6-pentamethyl 4-piperidinol and 1,2,2,6,6-pentamethyl 4-aminopiperidinol with succinic anhydride functionalized poly(olefin) surfaces. The photostability of poly(olefin) films with surface anchored HALS were compared with films stabilized with commercial HALS (Tinuvin 770) by melt blending. It was observed that the photostabilizing efficiency of surface anchored HALS superior that of melt-blended poly(olefin)s.

The results of this study show that poly(olefin)s can be functionalized, both in the bulk and the surface, using a mild photochemical reaction with maleic anhydride in presence of a triplet photosensitizer. The resulting succinic anhydride group on the surface of the polymer can be transformed into a variety of new functional groups using simple organic chemical transformations. Wide variations in wettability of the poly(ethylene) surface can be observed depending on the nature of chemical functionality.

When azobenzene functionality were attached to poly(olefin)s, the films exhibit photo and thermally induced $E \rightleftharpoons Z$ isomerization. The rate of thermal back isomerization from $Z \rightarrow E$ is dependent on type of chromophore, manner of their attachment to the polymer backbone and the crystallinity of polymers. The thermal $Z \rightarrow E$ isomerization of an azo group attached to a semicrystalline is faster than an azo group attached to a glassy acrylic polymer.

Polymer surfaces bearing chemically weak linkages (azo or diazonium) undergo profound surface topographical changes upon exposure to electron energy, plasma or even heat and thus open up an alternative way to create surface inhomogeneities.

Polyethylene, polypropylene and heterophasic E-P copolymer films were effectively protected against photo-irradiation by anchoring HALS onto the succinic anhydride modified polymer surfaces. The improved photostability observed for such materials must be attributed to the chemical bonding between the additive and the polymer surface and hence to its permanence.

SYNOPSIS

The thesis entitled '**Synthesis and characterization of functionalized polyolefin surfaces**' consists of seven chapters and chapter VIII summarizes the work reported in the thesis.

Introduction

Polymer surface chemistry is an area of practical and academic interest¹. A principal concern in this area is the development of methods that selectively introduce and transform functional groups on the surfaces. In case of functionalized polymer surfaces that are commonly produced by modification of nonpolar polymer films²⁻⁴, good selectivity at the surface versus bulk can often be achieved in the initial functionalization chemistry, either through the use of highly reactive reagents or through the use of reagents or solvents that minimally interact with bulk polymer. Etching of polyethylene surface by chromic acid to generate carboxyl, ketone and aldehyde groups on the surface has been well studied with an objective to improve the adhesive properties of the polymer.^{5,6} Whitesides and coworkers oxidized the polyethylene surface under controlled conditions and further modified the surface by derivatizing the surface carboxyl group. There are numerous reports on surface modification of polymers using techniques such as gamma rays, plasma, corona and photochemical modification. However, the characterization of these polymers presents special problems as the reaction takes place only upto a few angstrom level. A number of techniques have been used to characterize polymer surfaces, such as ATR FTIR, UV, contact angle, XPS, SEM, ESR, gravimetry etc. Properties such as wetting, weathering, permeation, sorption, adhesion, dye adsorption, biocompatibility and cell attachment etc are influenced by the nature of the polymer surface⁷⁻⁹. These properties can be monitored and controlled by proper selection of surface modification reaction. In applications where surface constitution of the polymer is important, novel strategies for modification according to the requirement is necessary. A reactive anchoring site on the surface of the polymer, capable of undergoing diverse chemical reaction is therefore very desirable. The bulk and surface properties of polymers have been successfully exploited to produce materials that have a wide range of application. Surface properties are more important compared to bulk for determining properties such as adhesion, wettability, printability.^{10,11} Thus, tailoring of surface properties of polymers has attracted considerable interest in recent years.

The most common method of surface modification is by oxidation. Surface oxidation is mainly carried out by corona discharge, with oxidizing solution.³ One method that has been used to alter the surface properties of polymers is by photochemical grafting. The technique involves polymerization of vinyl monomers initiated by radical sites generated on solid polymer surfaces. The grafting of polymer chains onto a polymer surface can alter the surface properties of the substrate without affecting its bulk properties. Polyethylene itself has been photochemically grafted with a variety of hydrophilic vinylic monomers using solution and vapor phase techniques.^{12,13} The bulk modification of polyethylene with maleic anhydride has been exhaustively studied.¹⁴ The present investigation has been undertaken with a view to introduce a discrete, reactive anhydride functionality onto the surface of polyolefins and incorporation of suitable organic compounds onto the surface to improve surface property of polymer as describe below.

(a) Wettability is a property of a surface that is both theoretically and practically important. Wetting of solid surfaces by liquids, especially, water, plays an important role in various practical applications. One would sometimes like to reduce the wettability of solid surfaces such that they would repel liquids upon contact. On other occasions, however enhanced wettability to promote the spreading of liquids over a solid surface is desired. There are many applications where the simultaneous control of both wetting and nonwetting solid surfaces is required to accomplish a desired result. Thus a study aimed to introduce various functional groups such as acids, esters, salts by reaction of polyethylene bearing succinic anhydride with various reagents to make graded hydrophilicity.

(b) Polymers undergo degradation and oxidation by a combination of oxygen, heat and UV light. Polymer degradation can be prevented by incorporating suitable stabilizer into the polymer. Generally a stabilizer is melt blended into the polymer.^{15,16} However, stabilizers are low molecule weight organic compounds which can be lost from the polymer by evaporation and migration¹⁷. Chemical attachment of stabilizer to the polymer molecule offers a solution to this problem¹².

Hindered amine light stabilizer (HALS) based on tetra methyl piperidine compounds, are a class of efficient stabilizers which are widely used to protect polyolefins against photo and

thermal oxidation.¹⁸ To improve the stability of polymer, surface functionalized polyolefins with anhydride group offers an interesting method to chemically attach HALS to the surface of polyolefins.

(c) Photoresponsive polymers have great potential for application in a wide variety of areas, including optical information storage and optical switching system.¹⁹ For use in photomemory system, materials containing azobenzene units are promising because these have dipole moments and optical parameters that are highly susceptible to change due to their reversible photoisomerization. In the past, the photoisomerization of azobenzene based compound have been studied in amorphous and LC polymers.²⁰ But the photoisomerization of azo compound bound to semicrystalline polymer is not well studied in the literature. Therefore, we undertook a study of photochemical isomerization of azobenzene unit incorporated into semicrystalline polyolefin films. We also determined the thermal cis→trans isomerization rate of azo compound on a polymer matrix.

(d) Physical and mechanical properties of plastics depend not only on the chemical structure of polymers but also on their surface topology. Surface treatment of polymers by oxidizing solutions has been used by the electroplating industry to promote metal to polymer adhesion.²¹ High energy radiation's can also cause deep seated changes in surface topology. For example, polyethers will degrade by chemical degradation of C-O-C linkage, by irradiation. The specimen in the electron microscope receives very large doses of radiation so that degradation does not stop with a fragment of reduced molecular weight. It continues until the fragments are small enough to volatilize in the vacuum environment of the microscope leaving the specimen with an altered surface. In extreme case there will be a loss of sufficient material to leave a hole or crack on the surface. Therefore, a clean and simple surface etching of polyethylene film bearing azo or diazo group using various high energy irradiation has been studied.

Objective of the Present Research:

1. Preparation of a polymer surfaces with a discrete and reactive functional group.
2. Transformation of the surface functional group on polymer surfaces and characterization of chemically modified polymer surfaces by surface analytical techniques such as XPS, FT-IR, ATR-IR, UV, contact angle goniometry, SEM etc.
3. Explore applications of chemically modified polymer surfaces in areas such as:
 - Surface stabilization of polymer film against UV degradation.
 - Surface chemical dynamics such as photoisomerization.
 - Surfaces with graded hydrophilicities.

Chapter I

This chapter provides a detailed survey of the literature on surface modification and characterization of polymer.

Chapter II

The objective and scope of the present investigation are described in this chapter.

Chapter III

This chapter deals with the selective surface functionalization of poly(ethylene) for introducing a reactive succinic anhydride group on the surface of poly(ethylene)s. Different reaction conditions such as time, concentration of monomer, nature of solvent and sensitizer have been studied. Surface selectivity was established by angle dependent XPS study.

Chapter IV

This chapter deals with chemical transformation of succinic anhydride functionality on poly(ethylene) to generate PE surface with graded hydrophilicity. The succinic anhydride group on PE was transformed into carboxylic acid by simple hydrolysis and mono amides or diamides by treating with different amines (ethylene diamine, morpholine, aniline etc.). Surface wettability was studied by contact angle goniometry. The functional groups were characterized by FT-IR and XPS.

Chapter V

This chapter deals with the investigation of cis-trans isomerization of azo group bound to a semicrystalline polymer. The rate of thermal isomerization of different azo compounds bound to semicrystalline polymer was determined. The rate of isomerization of an azo group in both an amorphous and a semicrystalline polymer was compared.

Chapter VI

This chapter describes surface etching of PE film bearing azobenzene group using various high energy irradiation, and the characterization of surface topology by SEM.

Chapter VII

This chapter deals with the improvement of UV stability of polyolefins by chemically anchoring hindered amine light stabilizer (HALS) onto the surface. Photostabilizing efficiency of polymer bound stabilizer was studied from the carbonyl group formation with irradiation time and compared with polyolefins containing melt blended HALS.

Chapter VIII

This chapter summarizes the results and describes the salient conclusions of the investigations reported in the thesis.

Poly(ethylene)s can be functionalized, both in bulk and surface, using a mild photochemical reaction with maleic anhydride in presence of a triplet photosensitizer. The resulting succinic anhydride group can be transformed into a variety of new functional groups using simple organic chemical transformations. Wide variations in wettability of the poly(ethylene) surface was observed depending on the nature of chemical functionality.

Irradiation of semicrystalline azo polymer films with light of appropriate wave length induces trans to cis isomerization and the azobenzene group then isomerized back thermally in the ambient condition. The thermal rate of relaxation depends on type of chromophore, type of attachment to the polymer backbone and nature of polymer. The azo group containing electron acceptor groups shows a faster thermal cis-trans isomerization rate. Steric factor and nature of polymer also influences the rate of relaxation. The thermal cis→trans isomerization of semicrystalline azo polymer film was compared with that of

amorphous azo polymer film. It was observed that the amorphous azo polymer relaxes slowly as compared to semicrystalline polymer.

Polyethylene, polypropylene and heterophasic E-P copolymer films were effectively protected against photo-irradiation by anchoring HALS onto the succinic anhydride modified polymer surfaces. The improved photostability of such materials must be attributed to the chemical bonding between the additive and the polymer surface and hence to its permanence.

The surface etching of polyethylene bearing azobenzene and diazo groups using various high energy irradiation has been achieved. The efficiency of etching of PE bearing azo group is more as compared to PE bearing diazo group.

References

1. Swalen. J.D, Allara. D.L, Andrade. J.D, Chandross. E.A, Garoff. S, Israelachvili. I, McCarthy. T.J, Murray. R, Pease. R.F, Rabolt. J.F, Wynne. K.J, Yu. H, Langmuir, **1987**, 3, 332
2. Baszkin. A, Deyme. M, Nishino. M, Ter-Minassian-Saraga. L, Prog. Colloid Polym.Sci., **1976**, 61, 97.
3. Rasmussen. J.R, Stedronsky. E.R, Whitesides. G.M, J. Am. Chem. Soc., **1977**, 99, 4757.
4. Ward. W.J, McCarthy. T.J, In Encyclopedia of Polymer Science and Engineering, 2nd ed, Mark. H.F, Bikales. N.M, Overberger. C.G, Menges. G, Kroschwitz. J.I, Eds.; John Wiley and Sons: New York, **1989**, p vol., p 674
5. McCarthy. T.J, Chimia, **1990**, 44, 316
6. Rasmussen. J.R, Stedronsky. E.R, Whitesides. G.M, J. Am. Chem. Soc., **1977**, 99, 4736.
7. Whitesides. G.M, Ferguson. G.S, Chemtracts-organic Chemistry, **1988**, 1, 171 and reference cited there in.
8. Bergbreiter. D.E, "Chemically Modified Surfaces"; Mottola. H.A, Steinmetz. J.R, Eds.; Plenum Press, New York, 1992, p 133-154.

9. Andrade. J.D, Gregonis. D.E, Smith. L.M, "Surface and Interfacial Aspects of Biomedical Polymers"; Andrade, J. D, Ed.; Plenum Press, New York, **1985**, Vol 1, Chapter2.
10. Bergbreiter. D.E, "Chemically modified surfaces"; Mottola. H.A, Steinmetz. J.R, Eds; Plenum Press New York **1992**, p133-154.
11. Whitesides. G.M and Laibinis. P.E, Langmuir, **1990**, 6, 87
12. Ranby. B, Macromol Chem. Macromol Symp, **1992**, 65, 55
13. Kubota. H, J.Appl.Polym.Sci, **1992**, 46, 383
14. Gaylord. N.G, J.Macromol.Sci-Revs.Macromol.Chem, **1975**, C13(2),235
15. Fertig. J, Goldberg. A.J and Scoutchi. M, J. Appl. Polym. Sci., **1966**, 10, 663.
16. Fertig. J, Goldberg. A.J and Scoutchi. M, J. Appl. Polym. Sci., **1965**, 9, 903.
17. Luston. J, Developments in polymer stabilizer-2, Applied science publishers, London, **1980**, p.185.
18. Yongcheng. Ye, Polymer Degradation and Stability, **1992**, 37, 11
19. Irie. M, Adv.Polym.Sci , **1990**, 94, 27.
20. Eich. M, Wendorff. J.H, Reck. B, Ringsdorf. H, Makromol.Chem.,Rapid Communication, **1987**, 8, 467
21. Fitchmun. D.R, Newman. S, Wiggle. R, J.Appl.Polym.Sci., **1970**, 14, 2457

LIST OF PUBLICATIONS

1. Characterization of a Surface Modified Polymer: Polyethylene Modified with Succinic Anhydride Group. **Nabin Sarkar**, Susmita Bhattacharjee and S.Sivaram. Polymer Science recent Advances, I.S.Bhardwaj (editor), **1994**, 2, 933-938
2. Surface Anchored Hindered Amine Light Stabilizers For Improved U.V Stability of Polyolefins. R.Mani, **N.Sarkar**, R.P.Singh and S.Sivaram, Journal of Macromolecular Science. Pure. Appl. Chem. **1996**, A33(9), 1217-1226
3. Surface Functionalization of Poly(ethylene) with Succinic Anhydride: Preparation, Modification and Characterization. **Nabin Sarkar**, Susmita Bhattacharjee and Swaminathan Sivaram. Langmuir **1997**, 13, 4142-4149
4. Cis-trans Isomerization of Aromatic Azo Chromophores, Bound to Semicrystalline Polymer. **Nabin Sarkar**, Swaminathan Sivaram, Makromol.Chem.Phys.(communicated)
5. Surface Etching of Functionalized Poly(ethylene) Film by Electron or Thermal Energy. **Nabin Sarkar**, Swaminathan Sivaram, Polymer (communicated)
6. Thermal Reconstruction of Functionalized Poly(ethylene) Surfaces. **Nabin Sarkar**, Swaminathan Sivaram, Polymer (to be communicated)