

**STUDIES IN THE SYNTHESIS OF  
NEW CHROMOPHORIC AND  
BIOLOGICALLY ACTIVE COMPOUNDS**

**A THESIS  
SUBMITTED TO THE  
SHIVAJI UNIVERSITY, KOLHAPUR  
FOR THE DEGREE OF  
DOCTOR OF PHILOSOPHY  
( IN CHEMISTRY )**

**BY  
G. S. JADHAV**  
M. Sc.

**NATIONAL CHEMICAL LABORATORY  
PUNE 411 008 ( INDIA )**

**AUGUST 1986**

---


**DEDICATED TO  
MY PARENTS, UNCLE AND WIFE**

---

## CERTIFICATE

It is certified that the work incorporated in the thesis entitled "STUDIES IN THE SYNTHESIS OF NEW CHROMOPHORIC AND BIOLOGICALLY ACTIVE COMPOUNDS" submitted by Mr.G.S. Jadhav, embodies the findings of his original research work carried out under my supervision at National Chemical Laboratory, Pune. This work has not been submitted so far for any degree or diploma.

NCL, Pune 411 008  
Dated August 29, 1986



(Dr.G.T. PANSE)  
Research Guide

## ACKNOWLEDGEMENTS

I wish to express my deep sense of gratitude to Dr.G.T. Panse, Scientist Division of Organic Chemistry, National Chemical Laboratory, Pune, for his patient instructions, subtle, skilful guidance, and incisive insight throughout the investigation of this research topic. In addition, I am indebted to Dr.N.R. Ayyangar, Head, Division of Organic Chemistry II, NCL, for his sustained interest and helpful discussions during my work related to dyes and pigments. I would like to express my gratitude to Dr.L.K.Doraiswamy, FNA, Director, National Chemical Laboratory and to Prof. B.D.Tilak, FNA, ex-Director, NCL for kindly allowing me to work at the NCL for my Ph.D and to submit this work in the form of a thesis to Shivaji University. I would like to thank all the persons who helped in the preparation of this thesis, in particular, Dr.S.K. Kamat and Dr. K.V.Srinivasan and members of Organic Chemistry Division of NCL for their constant support.

I would like to thank Mr. H. Krishnamurthy, the Chairman and Managing Director, Dr. M.Sriram, Chief Manager (R&D) and Dr.S.V. Joshi, Manager (R&D) of Hindustan Organic Chemicals Ltd., Rasayani for their constant encouragement during the course of this work. I wish to thank for the technical help received during the investigation of this research from the colleagues of R&D Division of Hindustan Organic Chemicals and Dr. B.D. Bamane, Mr.S.R.Ravirkar in particular.

I am thankful to Dr.B.G. Khadse, Head of the Chemotherapy Department, Haffkine Institute, Bombay, for making available the facilities needed to test antitubercular activity. I am also thankful to Mr.V.K. Menon, M/s Amar Dye-Chem Ltd., Bombay, for his help in the evaluation of pigments.

  
(G.S. JADHAV)

## CONTENTS

	Page
<b>SUMMARY</b>	1-7
<b>CHAPTER I</b>	
<b>Ortho-Cumidine [Benzenamine -2-(1-Methyl-Ethyl): A Versatile Intermediate for Dyes and Pigments</b>	8-100
SECTION A Introduction	8
SECTION B Present work	14
Monoazo solvent dyes from <u>o</u> -cumidine	17
Disazo dyes from <u>o</u> -cumidine	28
Disazo solvent dyes from <u>4-o</u> -cumylazo- <u>o</u> -cumidine ( <u>11c</u> )	34
Disazo dyes from <u>4-o</u> -cumylazo- <u>o</u> -cumidine ( <u>11c</u> ) with commercial naphthols as coupling components	40
Dyes derived from <u>o</u> -cumidine using <u>3</u> -methyl- <u>5</u> - pyrazolone as coupling component	40
Light fastness of monoazo and disazo dyes ( <u>5a</u> ), ( <u>5b</u> ), ( <u>12a</u> ), ( <u>12b</u> ), ( <u>17b</u> ) and ( <u>17c</u> )	51
Pigments prepared from <u>ortho</u> -cumidine derivative ( <u>5</u> -nitro- <u>o</u> -cumidine)	55
Comparison of dyeing behaviour of <u>5</u> -nitro- <u>o</u> - cumidine hydrochloride with <u>5</u> -nitro- <u>o</u> - toluidine	64
SECTION C Experimental	66
References	99
<b>CHAPTER II</b>	
<b>Biologically Active <u>4</u>-Thiazolidinones from schiff bases</b>	101-175
SECTION A Introduction	101
History of Tuberculosis	105
Inventions on antitubercular active drugs	106
<u>4</u> -Thiazolidinones	106
Synthesis of <u>4</u> -thiazolidinones	111
Reactions of <u>4</u> -thiazolidinones	117
SECTION B Present Work	127
Aims, Objective and Scope	127
Present work (Discussions)	135
Biological results and discussion	158

		Page
SECTION C	Experimental	161
	References	165
<b>CHAPTER III</b>	<b>Asymmetric Synthesis of <u>4</u>-Thiazolidinones</b>	<b>176-220</b>
SECTION A	Introduction	176
	Asymmetric Synthesis	176
	Methods for the preparation of asymmetric synthesis	184
	Optical purity	189
	Aim and Scope of Work	193
SECTION B	Present Work (Discussion)	196
SECTION C	Experimental	215
	References	218

### General Remarks

1. All melting points are uncorrected and are in °C.
2. IR spectra were recorded in nujol using Perkin-Elmer Infracord model 137B & 599-B Pye-Unicam infrared spectrophotometer SP-300. The IR values are recorded in  $\text{cm}^{-1}$ .
3.  $^1\text{H-NMR}$  spectra were recorded in  $\text{CDCl}_3$  and  $\text{DMSO}(D_6)$  with trimethylsilane (TMS) as an internal reference on Varian T-60 and Brucker's FT, WH-90 NMR spectrometers. The chemical shifts ( $\delta$  values) are recorded in ppm. The following abbreviations are used:  
  
s = singlet; d = doublet; t = triplet; q = quartet and m = multiplet.
4. Mass spectra were recorded on CEC-21-110-B double focussing mass spectrometer using a direct inlet system and at an ionising voltage of 70 eV. The samples were vapourized at the minimum possible temperature.
5. UV-Visible spectra were recorded on a 'Beckman' double beam spectrophotometer model 216 with 1-cm quartz cells. The wavelength maxima have been recorded in nm.
6. Figures underlined are structure numbers, and figures in superscript are literature references. The numbers assigned to the structures given in each chapter refer only to that particular chapter.
7. Specific rotations were recorded on Jasco DIP-181 digital polarimeter.

8. Elemental analysis of compounds is carried out by micro-analytical procedures for carbon, hydrogen and nitrogen.

9. Abbreviation:

dil - dilute

HETP - Height equivalent to theoretical plate

resp. - respectively

hrs - Hours

s.s. - Stainless steel

I.D. - Internal diameter

GLC - Gas liquid chromatography

T.B. - Tuberculosis

ACE - Angiotension Converting Enzyme

INH - Isonicotinic acid hydrazide

CNS - Central Nervous System

PAS - Para-amino Salicylic Acid.

M.p. - melting points.

e.e. - Enantiomeric excess



---

---

## SUMMARY

---

---

## SUMMARY

### CHAPTER I - Ortho-cumidine [benzenamine-2-(1-methylethyl)]:

A versatile intermediate for dyes and pigments.

The solvent dyes are used in industry to colour the material like petroleum products, waxes, shoe creams etc. through their ability to dissolve organic solvents such as acetone, benzene, toluene, kerosene etc. Based on their solubility they are classified into three classes. The literature survey of solvent dyes and their chemical constitutions have been reviewed and data regarding the class of azo dyes and pigments have been described.

Para-isomer of cumidine finds large use in the manufacture of the herbicide, isoproturon. The economy of the industrial process for p-cumidine is greatly dependent on finding out commercial outlets for the accumulating o-cumidine. The use of o-cumidine as an intermediate for solvent dyes and pigments has been explored because of its structural similarity to o-toluidine. Findings in this chapter are confined to azo class of solvent dyes and pigments. We have synthesized monoazo and disazo pigments incorporating 5-nitro-o-cumidine as diazo component and compared them with mono and disazo pigments derived from 5-nitro-o-toluidine.

Separation of mixed nitrocumens was achieved by fractional distillation under reduced pressure. The mono-azo solvent dyes derived from o-cumidine using 2-naphthol, 1-naphthol and p-cresol as coupling components were compared with the commercial solvent orange 2, solvent red 2 and solvent yellow 2 respectively, derived

from o-toluidine. The new monoazo solvent dyes were found to have 15 to 300% better solubilities than the commercial solvent dyes. The wavelength maxima of the two series of dyes were comparable. However, the tinctorial strength of the new solvent dyes are somewhat lower than those of the commercial solvent dyes.

The performance of 4-o-cumylazo-o-cumidine (llc) as solvent dye was better than the commercial solvent yellow 2 and solvent yellow 3 (Fast Garnet GBC Base). Similarly disazo solvent dyes derived from llc had much better solubilities, higher tinctorial strength and better light fastness as compared to the commercial solvent red 24 and solvent orange 13 derived from Fast Garnet GBC base. Several new disazo dyes using llc as a diazo component and commercial naphthols as coupling components have also been synthesized.

Several new monoazo and disazo dyes based on o-cumidine (4c) and p-o-cumylazo-o-cumidine (llc) as diazo component and 3-methyl-5-pyrazolone as coupling component were synthesized. The performance of the new solvent dyes has been evaluated against solvent dyes derived from o-toluidine and p-o-tolylazo-o-toluidine.

The new dyes showed better solubilities, bathochromic shifts and higher tinctorial strengths than the dyes derived from o-toluidine.

Several new pigments were synthesized by coupling diazo-5-nitro-o-cumidine with commercial naphthols, and 3-methyl-5-pyrazolone as coupling components respectively. The electronic spectra of the new pigments were compared with commercial pigments (viz. pigment

orange 2, pigment red 22, pigment red 114, pigment red 8, pigment red) derived from 5-nitro-o-toluidine.

The dyeing behaviour of 5-nitro-o-cumidine hydrochloride as an azoic diazo component was compared with the commercial azoic diazo component 12 (5-nitro-o-toluidine). In case of Naphthol ASG, dyeing obtained from 5-nitro-o-cumidine is greener than the corresponding o-toluidine derivative (Fast Scarlet G Base). Similarly with Naphthol ASBO, cumidine derivative is stronger and redder, as compared with toluidine derivative. The dyeings with Naphthol AS and Naphthol ASBS are comparable.

CHAPTER II - Synthesis of biologically active 4-thiazolidinones.

4-Thiazolidine derivatives exhibit a variety of pharmacological activities. The presence of N-C-S linkages in the 4-thiazolidinones has been postulated as the moiety for different biological activities like antibacterial, antifungal and antitubercular activities. Further attempts also have been made to enhance the biological activity by introducing the different substituents at 2,3,5 position of 4-thiazolidinone ring.

These observations prompted us to synthesize the different thiazolidinones. The 4-thiazolidinones have been prepared from the Schiff bases having an azomethine linkage (C=N). Schiff base is an important class of compounds which can be used to prepare thiazolidinones and related compounds,  $\beta$ -lactams, heterocyclic compounds dyes, metal complexes etc.

We have prepared Schiff bases (91, 93, 99) by the condensation of differently substituted benzoic acid hydrazides (90), benzylamine (92) and N-aminoquinazolone (98) with substituted aliphatic or aromatic aldehydes respectively. The spectral data of all these Schiff bases has been discussed.

Further, these Schiff bases have been converted to corresponding thiazolidinones (100, 101) by refluxing a mixture of Schiff bases and thioglycolic acid either in benzene or in toluene for 8 hrs by using Dean-Stark apparatus to remove water formed during the reaction azeotropically. These thiazolidinones were then tested for the antitubercular activity.

The analytical data, m.ps and yields of all these thiazolidinones is given in Table 4 while spectral data are given in Tables 5 and 6 and discussed in the present chapter. In all these 4-thiazolidinones, we observed S-CH<sub>2</sub> in the region of 3.6 to 3.8 but it is not a sharp singlet. Always it is showing at least a doublet. This may be due to the nonequivalence of two protons of S-CH<sub>2</sub> in the 4-thiazolidinone ring and they are coupling with each other. However, the 4-thiazolidinones (101) showed in NMR that all the peaks are in the appropriate form in appropriate positions but for the benzylic protons (Ph-CH<sub>2</sub>). It has shown two sets of doublets. The J-value for these two sets is 14 cps. This indicated that two benzylic protons are nonequivalent. This nonequivalence may be due to the asymmetric centre present in the system. The large shift observed for these protons can be explained on the basis of magnetic anisotropy of

C=O group present at | position.

Out of sixteen 4-thiazolidinones prepared, ten compounds were screened for their in vitro antituberculosis activity against *M. tuberculosis* (H<sub>37</sub>Rv strain) (Table 7). Out of ten compounds, seven have shown antitubercular activity at different concentrations. Only one compound (100c) which has methoxy group at the ortho position of aldehyde moiety has shown anti T.B. activity at 50  $\mu$ g/ml. From the observations in Table 7 one can conclude that when there is no substituent in either benzamide or benzaldehyde moiety the compound does not show anti-T.B. activity upto 200  $\mu$ g/ml. However, if the methoxy group is in the ortho position in the benzaldehyde ring, it shows better activity. Further it is observed that substitution in the para-position gives less activity.

### CHAPTER III - Asymmetric Synthesis of 4-thiazolidinones

A literature survey and state of art of asymmetric synthesis of some of the important biologically active compounds have been presented. Synthesis of optically active thiazoline and thiazolidine compounds has been discussed. In order to find out the extent of optical induction and to correlate the structure activity relationship of 4-thiazolidones, we have prepared 4-thiazolidinones by following the same route which has been discussed in Chapter II. Only difference is that here optically active thiazolidinones are prepared by treating optically inactive Schiff bases (45,47) with thioglycolic acid in presence of optical activity inducing reagent quinine or by the treatment of thioglycolic acid on the optically active Schiff bases (49,50).

As we selected thioglycolic acid as the addition reagent to prepare 4-thiazolidinones from Schiff bases there will be only one asymmetric centre at the 2-position of 4-thiazolidinone ring and hence only 2'=2 isomers will be formed.

The optically active 4-thiazolidinones (46,48) prepared using quinine as the catalyst have shown the optical rotations (Table I) but their analytical and spectral data are very similar to those prepared in the Chapter II. We were unable to determine the optical purity by NMR because of the low optical purity.

As we got low optical purity by the above mentioned route, we prepared optically active Schiff bases (49, 50) by condensing the aliphatic or aromatic aldehyde with dextro or levo (d or l) methylbenzylamine and l-phenylalaninemethylester. They were characterized by analytical and spectral data.

The Schiff bases (49,50) were then converted to the corresponding 4-thiazolidinones (51, 52) by the same method described in Chapter II.

The 4-thiazolidinones obtained were then characterised by spectral and analytical data. Their optical rotations are given.

The NMRs of individual 4-thiazolidinones have been discussed thoroughly in the present work. All the 4-thiazolidinones have shown two sets of peaks corresponding to each group in NMR. This is because of the formation of the diastereomeric mixture of 4-thiazolidinone formed during the reaction. On the basis of NMR, we have shown

that one of the isomers is having around 10% enantiomeric excess (e.e) over the other isomer. The work on the asymmetric synthesis of other biologically active heterocyclic systems e.g. aziridines,  $\beta$ -lactams, thiazolines and thiazines is in progress.



---

CHAPTER I  
ORTHO-CUMIDINE [BENZENAMINE-2-(1-METHYL-ETHYL)]:  
A VERSATILE INTERMEDIATE FOR  
DYES AND PIGMENTS

---

---

---

SECTION-A

---

---

## INTRODUCTION

The para isomer of cumidine finds large use in the manufacture of herbicides such as isoproturon. Para-cumidine is manufactured industrially by mixed acid nitration of cumene by the process described by Haun and Kobe<sup>1</sup>. This gives 60% p-nitrocumene 30% o-nitrocumene and 8% m-nitrocumene. There are two methods by which p-cumidine is isolated. In one method the p-cumidine isomer is isolated by fractional distillation of nitration mixture followed by reduction. In the other method, the nitration mixture is reduced to give mixed cumidine from which p-isomer is isolated taking advantage of their  $pK_b$  values. On industrial scale for the economy of the process it becomes essential to find out commercial outlets for the accumulating o-cumidine. So far extensive survey of the literature has revealed no industrial outlets for either o-cumidine or its derivatives. In the present chapter, we have explored use of o-cumidine as an intermediate for solvent dyes and pigments because of its structural similarity to o-toluidine.

The solvent dyes belong to those class of dyes which are used to colour materials through their ability to dissolve in an organic solvent. Based on the solubility characteristics solvent dyes can be classified into various types as follows.

1. **Dyes soluble in hydrocarbon and other less polar solvents**

These are usually used to colour these solvents or a great variety of material containing such solvents.

2. **Dyes soluble in spirit and more polar solvents**

These are generally used for lacquers, stains and varnishes, for flexographic and gravure inks.

### 3. Dyes that have relatively low solubility in most solvents

These dyes can be used for mass colouration of synthetic polymer composition and various other end uses.

Chi-kang Dien has recently reviewed<sup>2</sup> the development in solvent dyes and discussed their chemical constitution and solubility characteristics. Table I provides numerical data on solvent dyes mentioned in Colour Index (1982)<sup>3</sup> classified according to hue.

Findings reported in this chapter are confined to azo class of solvent dyes. Azo dyes used for solvent dyes do not have water solubilising groups. They provide yellow, orange, red, violet, blue, brown and black colours. They are cheap and have many uses. Out of the total number of 346 solvent azo dyes reported in Colour Index Volumes, only 82 have known chemical constitution, (Table 1). Out of these 82 known solvent azo dyes there are six solvent azo dyes based on o-toluidine as diazo component which have been commercialised.

In this chapter we have compared solvent dye characteristics of these six commercial solvent dyes with those of the corresponding new mono and ~~disazo~~ solvent dyes derived from o-cumidine as diazo component.

Out of total number of 690 pigments that are listed in Colour Index<sup>3</sup> the pigments and dyes that are derived from 5-nitro-o-toluidine are given in Chart 1. Both the solvent dyes and pigments have similar chemical constitution, such as monoazo and ~~disazo~~ compounds and have the common property of being water insoluble. The basic difference

TABLE I  
SOLVENT DYES IN COLOUR INDEX UPTO 1982

Hue	CHEMICAL CLASS						Total	
	Azo	Anthra-quinone	Triaryl-methane	Xanthene	Misc.	Unknown		
Yellow	a)	84	6	-	3	43	24	160
	b)	28	-	-	-	4	-	32
Orange	a)	55	11	-	4	12	22	104
	b)	15	1	-	3	3	-	22
Red	a)	109	37	-	14	16	43	219
	b)	27	4	-	12	7	-	50
Violet	a)	7	18	3	-	7	9	44
	b)	1	5	2	-	3	-	11
Blue	a)	7	66	15	-	27	20	135
	b)	-	14	6	-	9	-	29
Green	a)	5	7	4	1	3	11	31
	b)	-	4	2	1	1	-	8
Brown	a)	43	-	-	-	6	9	58
	b)	7	-	-	-	1	-	8
Black	a)	30	-	-	-	7	14	51
	b)	4	-	-	-	3	-	7

a) Total Number

b) Number of dyes of known structure.

## CHART-1

COMMERCIAL PIGMENTS AND DYES FROM 5-NITRO-o-TOLUIDINE

NAME OF THE PIGMENT	C.I. NUMBER	CHEMICAL STRUCTURE
PIGMENT ORANGE 3	12105	
PIGMENT RED 22	12315	
PIGMENT RED 114	12351	
PIGMENT RED 8	12335	
PIGMENT RED 162	12390	

COMMERCIAL PIGMENTS AND DYES FROM 5-NITRO-O-TOLUIDINE

NAME OF PIGMENT	C.I. PIGMENT	CHEMICAL STRUCTURE
PIGMENT RED 162	12431	
ACID BLACK	20500	
DIRECT RED	25015	
DIRECT BLUE 39	30390	

between pigments and solvent dyes is the relative insolubility of pigments in organic solvents. However, most commercial pigments still have some solubility in organic solvents. For practical purpose however they are incorporated into materials by dispersion and or in collidal form rather than in true solution in the substrate.

In application both pigments and solvent dyes are competing with each other in inks, coatings, mass colouration of synthetic polymer compositions etc. Relative merits of solvent dyes and pigments have been reviewed<sup>4-6</sup>.

In this chapter we have synthesised new monoazo and diazo pigments incorporating 5-nitro-o-cumidine as diazo component and compared them with mono and diazo pigments derived from 5-nitro-o-toluidine.



---

---

SECTION-B

---

---

## PRESENT WORK

Solvent dyes are characterised by their high solubility and their ability in colouring petroleum products and polymeric materials. Attempts are being made to improve the solubility of known solvent dyes for wider applications. It has been found that by suitably substituting the aromatic molecule of the different dyes, new solvent dyes with improved solubility, can be synthesised.

Waxoline Red OS has been recently<sup>7</sup> characterised (Chart 2-A). This is structurally comparable to Waxoline Red O (Chart 2-D). Waxoline Red O is o-toluidine derivative whereas Waxoline Red OS is xylidine derivative. It was felt that o-cumidine [benzenamine-2(1-methylethyl)] having isopropyl group attached to benzene moiety can give dyes similar to Waxoline Red OS. Waxoline Red OS is reported to have better solubility<sup>7</sup> than Waxoline Red O. Thus, dyes derived from o-cumidine may also show improved properties than the corresponding o-toluidine derivatives.

The work was thus taken up to synthesize new solvent dyes from o-cumidine.

4-o-Tolylazo-o-toluidine made by self coupling of diazotized o-toluidine finds application as a solvent dye and also as an intermediate for solvent dyes. However, no such derivatives of o-cumidine are reported in the literature. Although cumene has been known for some time derivatives of cumene as dyestuff intermediates are not known.

Cumene has been known to undergo electrophilic nitration<sup>8,9,10</sup> to give mixture of o-nitrocumene, m-nitrocumene and p-nitrocumene. However, this reaction leads to ortho para ratio of 1:2 (approx.) in comparison with toluene which gives ortho-para ratio 2:1 (approx.)<sup>11,12,13</sup>. Formation of increased p-isomer has been explained due to steric effect<sup>14,15</sup>.

Ortho-nitrocumene and p-nitrocumene are reduced to corresponding o-cumidine<sup>13,14</sup> and p-cumidine<sup>8,14,15</sup>.

#### Synthesis of ortho-nitrocumene

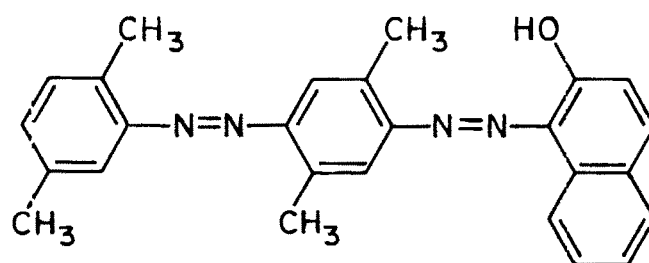
The nitration of cumene has been carried out following the procedure described by Haun and Kobe<sup>1</sup>. The nitration products have been shown in Chart 2-B. The GLC analysis of mixed nitrocumene as analysed by Perkin-Elmer Gas Chromatograph (FID) using 5% XE 66 on chromosorb-G as column material and nitrogen as carrier gas showed it to be 63.6% para-nitrocumene (1), 6.4% meta-nitrocumene (2) and 25-26% ortho-nitrocumene (3) and remaining unreacted cumene and higher nitrocumene.

#### Separation of ortho-nitrocumene

The separation of individual isomers has been carried out by Scheuzger, Karl<sup>15a</sup> after reduction of mixed nitrocumenes. This separation is achieved by azeotropic distillation of a mixture of p-cumidine, m-cumidine and o-cumidine. The separation of individual isomers was tried after reduction of mixed nitrocumene. This separation of individual isomer is achieved by making use of difference in solubility of hydrochloride salts. Hydrochloride of para-cumidine is less soluble than the hydrochloride of ortho and meta isomer.

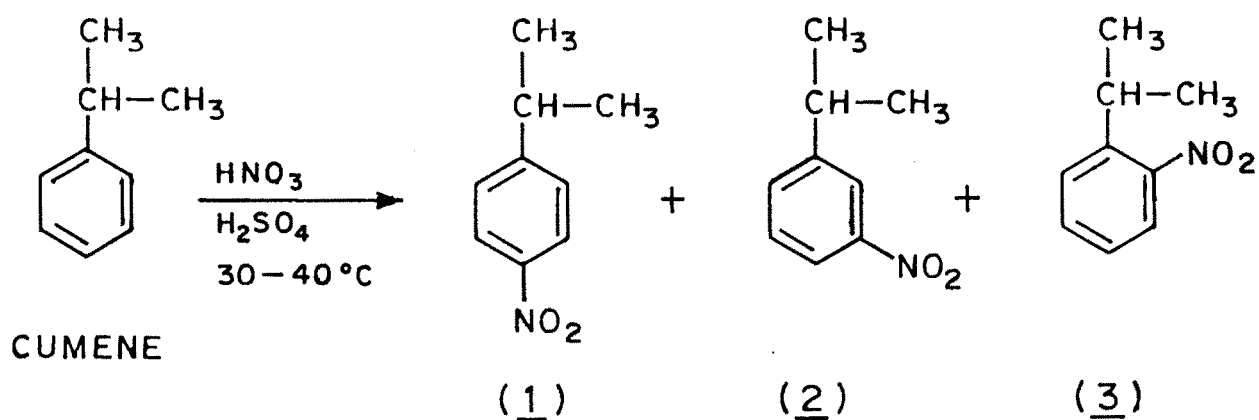
We carried out separation of nitrocumene isomers by distillation using "Hyflux" column packings of 2.5 cms. diameter. These packings are made up of S.S. 316 and have advantage over conventional packings, such as lower HETP (height equivalent to theoretical plate), low pressure drop etc. Because of lower HETP, these packings give highly pure isomers at lower reflux ratio. The boiling points of individual isomers are represented in Table 2.

A:

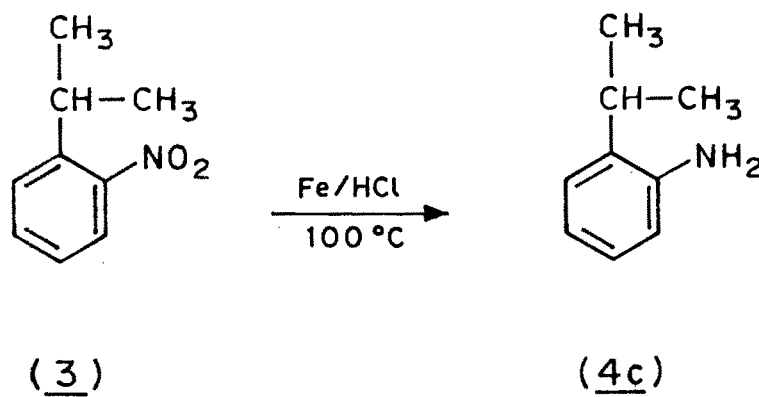


WAXOLINE RED OS

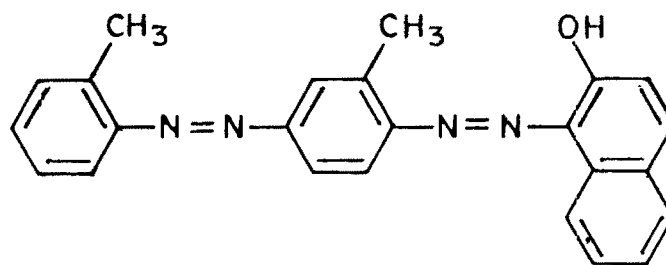
B:



C:



D:



SOLVENT RED 24 (C.I. 26105)  
(WAXOLINE RED O)

TABLE 2  
Boiling Point data of Nitrocumene Isomers<sup>8</sup>

Name of the isomer	B.p./Pr.	B.p./Pr
<u>Ortho</u> -nitrocumene	115°C/13 mm	111°C/9 mm
<u>Meta</u> -nitrocumene	125°C/13 mm	-
<u>Para</u> -nitrocumene	132°C/13 mm	129°C/12 mm

The separation of ortho-nitrocumene from mixed nitrocumenes was carried out under reduced pressure (13 mm) in a 3 litre distillation flask using 2.5 cm I.D. column packed with "Hyflux" packing of total height 60 cms. After initial distillation of cumene fraction which accounts for 0.4% of total charge, ortho-nitrocumene distilled over at 110°C/10 mm. The product, thus obtained, analysed as 99.8% pure by GLC using same column material described above.

#### Reduction of ortho-nitrocumene to ortho-cumidine

Reduction of o-nitrocumene to o-cumidine has been reported in literature using different procedures such as hydrogenation using different catalysts such as Raney Ni, Pd, Pt, etc. The reduction of o-nitrocumene (Chart 2-C) has been carried out by iron acid as described for ortho-nitro chlorobenzene in BIOS-986. This pure (99.8%) o-cumidine (4c) was used to prepare different dyes.

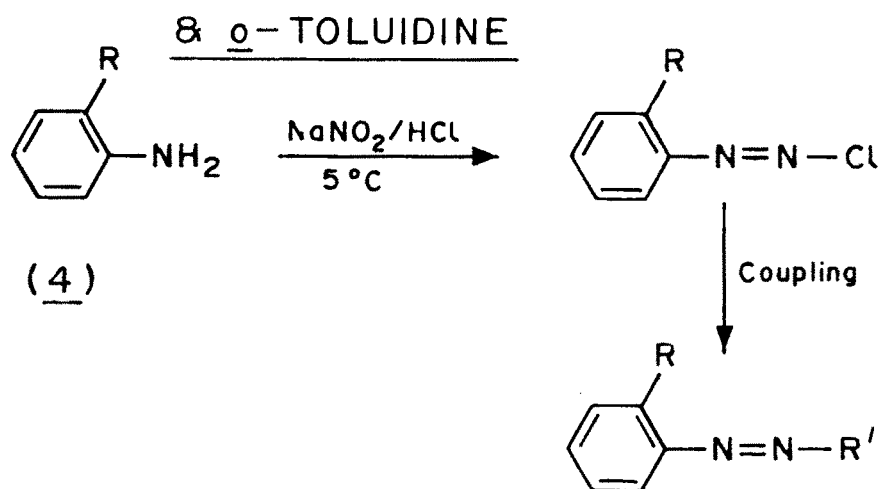
#### Monoazo Solvent Dyes from o-Cumidine

Ortho-toluidine has been widely used as a diazo component in the preparation of commercial monoazo solvent dyes. A few examples of such commercial solvent dyes (5a, 6a and 7a) which have been taken

A: COMMERCIAL MONO AZO SOLVENT DYES FROM o-TOLUIDINE

COMPOUND No	NAME OF THE SOLVENT DYE	C.I. NUMBER	CHEMICAL STRUCTURE
(5a)	SOLVENT ORANGE 2	12100	
(6a)	SOLVENT RED 2	12005	
(7a)	SOLVENT YELLOW 12	11860	

B: MONOAZO SOLVENT DYES FROM o-CUMIDINE



(5a) R = CH<sub>3</sub>, R' 2-NAPHTHOL

(5b) R = CH(CH<sub>3</sub>)<sub>2</sub>, R' 2'-NAPHTHOL

(6a) R = CH<sub>3</sub>, R' 1-NAPHTHOL

(6b) R = CH(CH<sub>3</sub>)<sub>2</sub>, R' 1-NAPHTHOL

(7a) R = CH<sub>3</sub>, R' PARA-CRESOL

(7b) R = CH(CH<sub>3</sub>)<sub>2</sub>, R PARA-CRESOL

for comparison with the corresponding o-cumidine based monoazo dyes are shown in Chart 3-A. These monoazo solvent dyes are used in the colouration of alcoholic ester and hydrocarbons, oils, fats and waxes. shoe creams and polishes, candles, spirit, cellulose and synthetic resin lacquers.

Ortho-cumidine (4c) was diazotized and coupled with 2-naphthol, 1-naphthol and p-cresol to give the new monoazo solvent dyes (5b), (6b) and (7b) (Chart 3-B). The performance of the new solvent dyes were compared with that of the commercial dyes based on o-toluidine.

#### **Solubility Study of Monoazo Solvent Dyes (5), (6) and (7)**

The solubility of the purified dyes in different solvents were studied by the method described in experimental section. The solubility of (5b), (6b) and (7b) were compared with the similar commercial solvent dyes (5a), (6a) and (7a) derived from o-toluidine.

It has been found that the solubility of dye (5b) derived from o-cumidine and 2-naphthol is about 5% to 135% more in polar solvents like methanol, ethanol, ethyl acetate butyl acetate etc. Similarly, solubility in nonpolar solvents like benzene, toluene, xylene etc. is between 15% to 182% more (Table 3).

The dye (6b) was compared with solvent red 2 (C.I. 12005) which was prepared from o-toluidine and 1-naphthol. It showed that solubility of dye (6b), in polar solvents is about 31% to 100% more and 17% to 300% more in non-polar solvents (Table 4).

TABLE 3  
COMPARISON OF SOLUBILITY DATA OF COMPOUND (5a) AND (5b)

Sl.No.	Solvents used	Solubility Grams/100 gms of solvent			Percentage increase of (5b) over (5a)
		Solvent Orange 2 (5a)		Compound (5b)	
		Reported <sup>16</sup>	Found	Found	
1	Ethanol	1	0.89	1.30	46
2	Acetone	2.8	2.60	2.83	9
3	Stearic acid	2.4	3.00	4.66	53
4	Cellosolve	-	1.01	2.38	135
5	Ethyl acetate	2	2.30	3.63	59
6	Butyl acetate	3	3.10	3.33	7
7	Methanol	-	0.19	0.18	5
8	Toluene	4	5.00	12.50	150
9	p-xylene	-	9.00	9.00	-
10	Kerosene	-	1.08	1.80	66
11	Paraffin Wax	0.6	0.70	1.98	182
12	Carbon tetra- chloride	-	4.76	5.5	15
13	Benzene	2.8	3.00	6.00	50



**TABLE 4**  
**COMPARISON OF SOLUBILITY DATA OF COMPOUND (6a) AND (6b)**

Sl.No.	Solvents used	Solubility Gms/100 gms of solvent			Percentage increase of (6b) over (6a)
		Solvent red 2 (6a)		Compound (6b)	
		Reported <sup>16</sup>	Found	Found	
1	Ethanol	S	4.80	6.3	31
2	Acetone	VS	12.30	15.90	29.2
3	Stearic acid	S	10.30	20.80	101
4	Cellosolve	-	12.50	25.00	100
5	Ethyl acetate	VS	10.8	18.30	69
6	Butyl acetate	-	12.50	25.00	100
7	Methanol	-	12.80	20.30	58
8	Toluene	VS	20.00	26.40	32
9	p-Xylene	VS	25.80	31.30	17
10	Kerosene	-	1.20	4.80	300
11	Paraffin Wax	S	8.20	15.07	83
12	Carbon tetra- chloride	-	8.20	10.30	22.7
13	Benzene	VS	15.00	20.00	33.3

The commercial solvent dye, solvent yellow 12 (C.I. 11860) (7a) was compared with dye (7b) which was prepared from o-cumidine and p-cresol. It was observed that dye (7b) is 82% to 110% more soluble in polar solvents and 7% to 203% were soluble in non-polar solvents (Table 5).

These observations clearly indicate that the dyes derived from o-cumidine have more solubility than corresponding commercial solvent dyes derived from o-toluidine. These dyes are structurally similar except the electron donor group (isopropyl) introduced in the benzene moiety.

#### **Electronic Spectra of compounds (5), (6) and (7) in chloroform.**

The dyes (5b) and (6b) showed wavelength maxima comparable to those of corresponding commercial dyes (5a) and (6a). The dye (7b) however showed a bathochromic shift ranging from 37 to 60 nm. All the new mono azo dyes derived from o-cumidine had lower tinctorial strength compared to the commercial dyes (Table 6) (Figure 1,2).

TABLE 5  
COMPARISON OF SOLUBILITY DATA OF COMPOUNDS (7a) AND (7b)

Sl.No.	Solvents used	Solubility Gms/100 gms of solvent			Percentage increase of (7b) over (7a)
		Solvent Yellow 12 (7a)		Compound (7b)	
		Reported <sup>16</sup>	Found	Found	
1	Ethanol	S	12.80	15.70	22
2	Acetone	S	10.30	12.80	24
3	Stearic acid	S	12.70	18.3	44
4	Cellosolve	-	2.20	2.80	27
5	Ethyl acetate	S	10.80	18.70	73
6	Butyl acetate	-	11.00	20.00	81
7	Methanol	-	8.7	18.3	110
8	Toluene	S	18.3	28.4	55
9	p-Xylene	S	20.9	35.0	67
10	Kerosene	-	3.30	10.00	203
11	Paraffin Wax	S	6.80	7.30	7
12	Carbon tetrachloride	-	8.2	12.70	54
13	Benzene	S	15.80	25.3	60

TABLE 6  
ELECTRONIC SPECTRA OF COMPOUNDS (5),(6) AND (7) IN CHLOROFORM

Compound	$\lambda_{\max}$ (nm)	Log $\epsilon$	$\lambda_{\max}$ (nm)	Log $\epsilon$
(5a)	490	4.356	510	4.333
(5b)	492	4.235	520	4.185
(6a)	413	4.135	462	4.796
(6b)	398	4.054	460	3.760
(7a)	335	4.334	383	4.000
(7b)	395	4.149	420	3.728

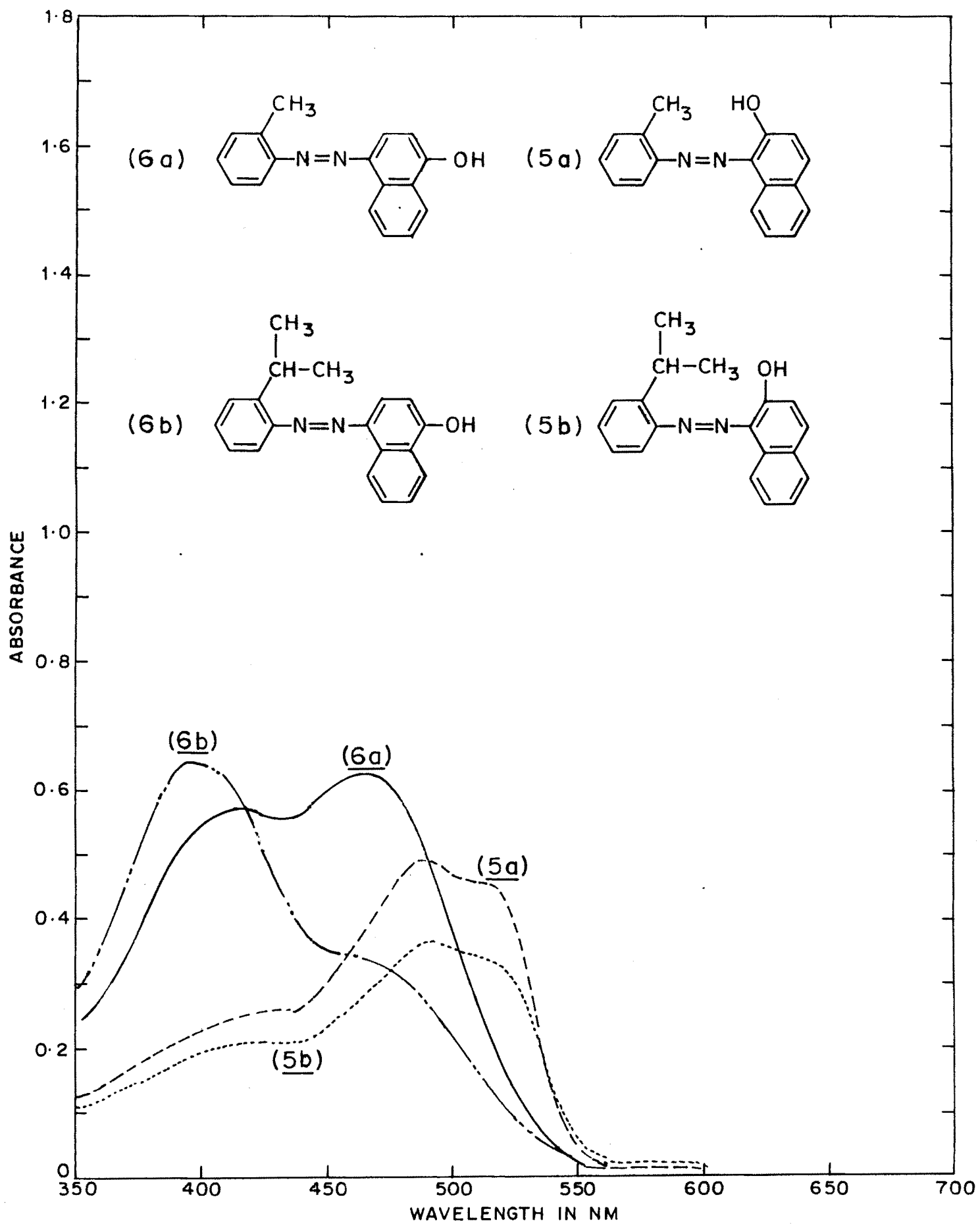


FIGURE 1

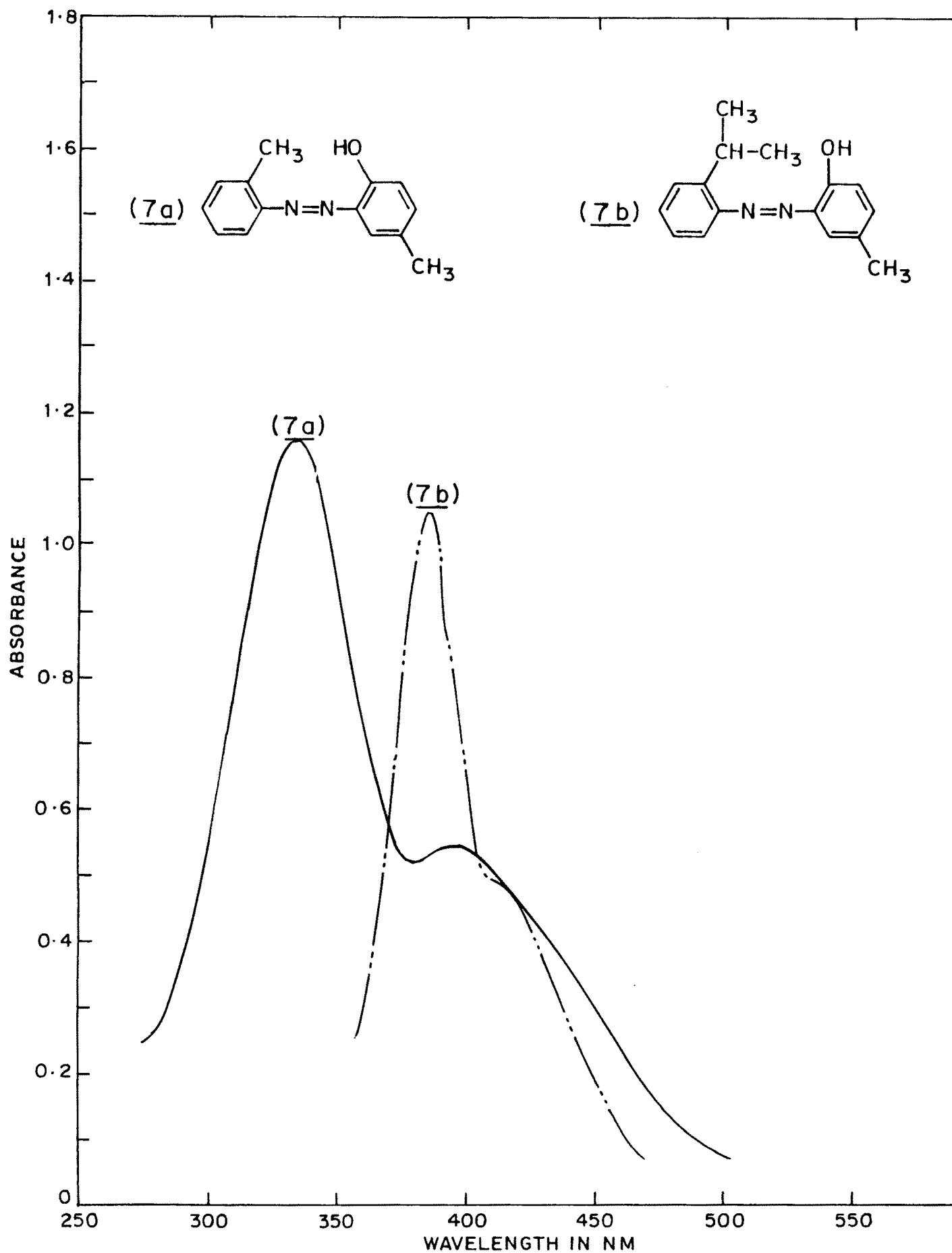
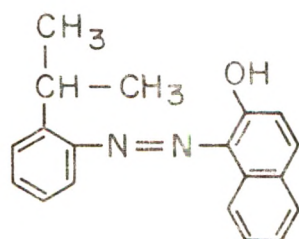
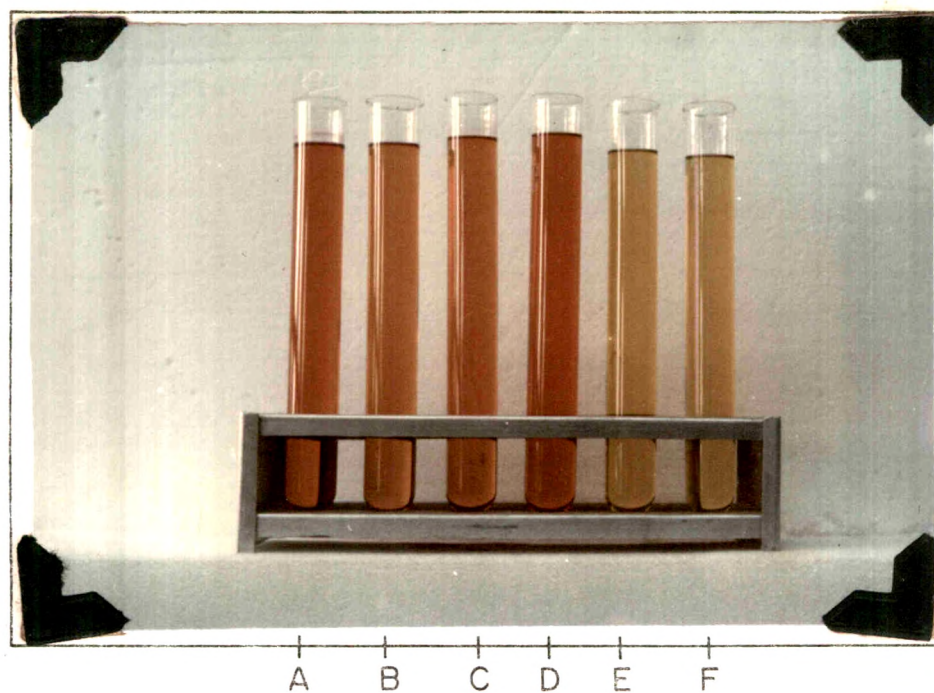
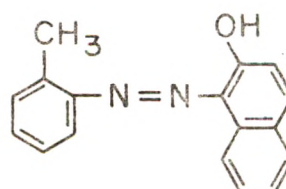
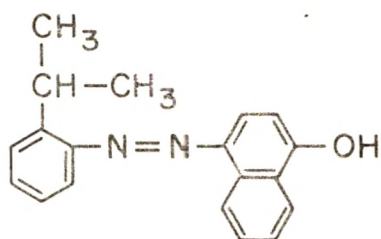
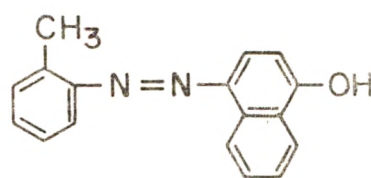
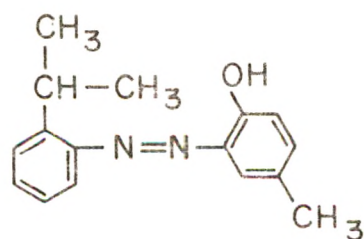
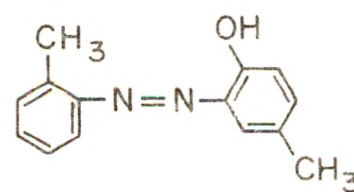


FIGURE 1(contd.)

A - Compound (5b)B - Solvent orange 2 (5a)C - Compound (6b)D - Solvent red 2 (6a)E - Compound (7b)F - Solvent yellow 12 (7a)

### DISAZO DYES FROM O-CUMIDINE

#### Synthesis of 4-o-cumyl azo-o-cumidine and its application as solvent dyes intermediates.

Aniline (4a) is known<sup>18</sup> to undergo diazotization and self coupling to give diazoaminobenzene (10). This compound in presence of aniline hydrochloride undergoes intermolecular rearrangement to give 4-amino azobenzene (11a).

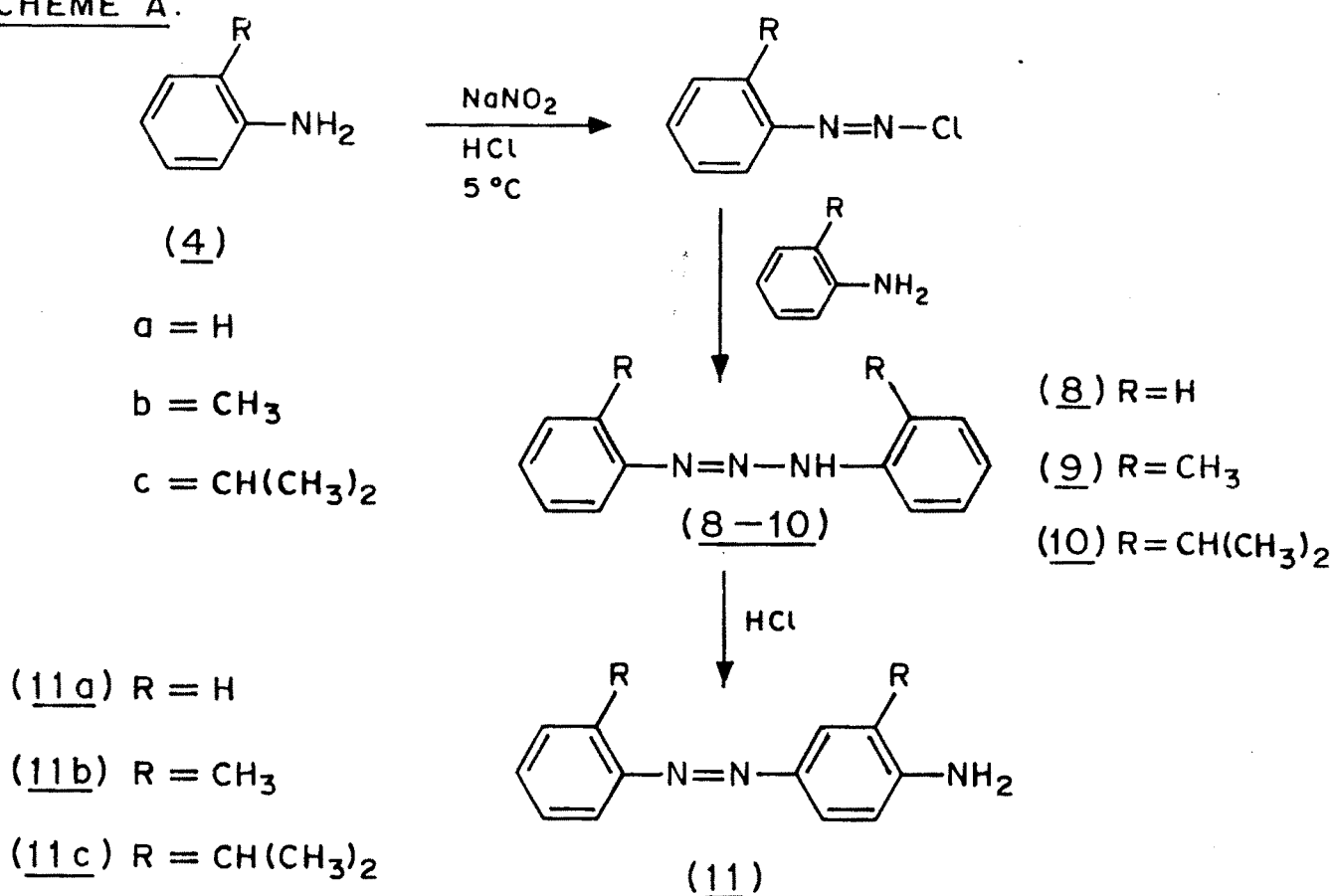
Ortho-toluidine (4b) undergoes similar reaction to give o-tolylazo-o-toluidine (11b). The hydrochloride of this compound is used as azoic diazo component under the commercial name Fast Garnet GBC Base (C.I.37210). The sequence of these reactions are represented in Chart 4, Scheme A.

Ortho-cumidine (4c)(Chart 2-B) synthesized by us, (see experimental), was diazotized with sodium nitrite and dil.hydrochloric acid at 5°C and self-coupled to give corresponding aminoazo derivative (10c) where  $R = CH(CH_3)_2$ , which rearranged in presence of small amount of hydrochloric acid to give 4-o-cumylazo-o-cumidine (11c).

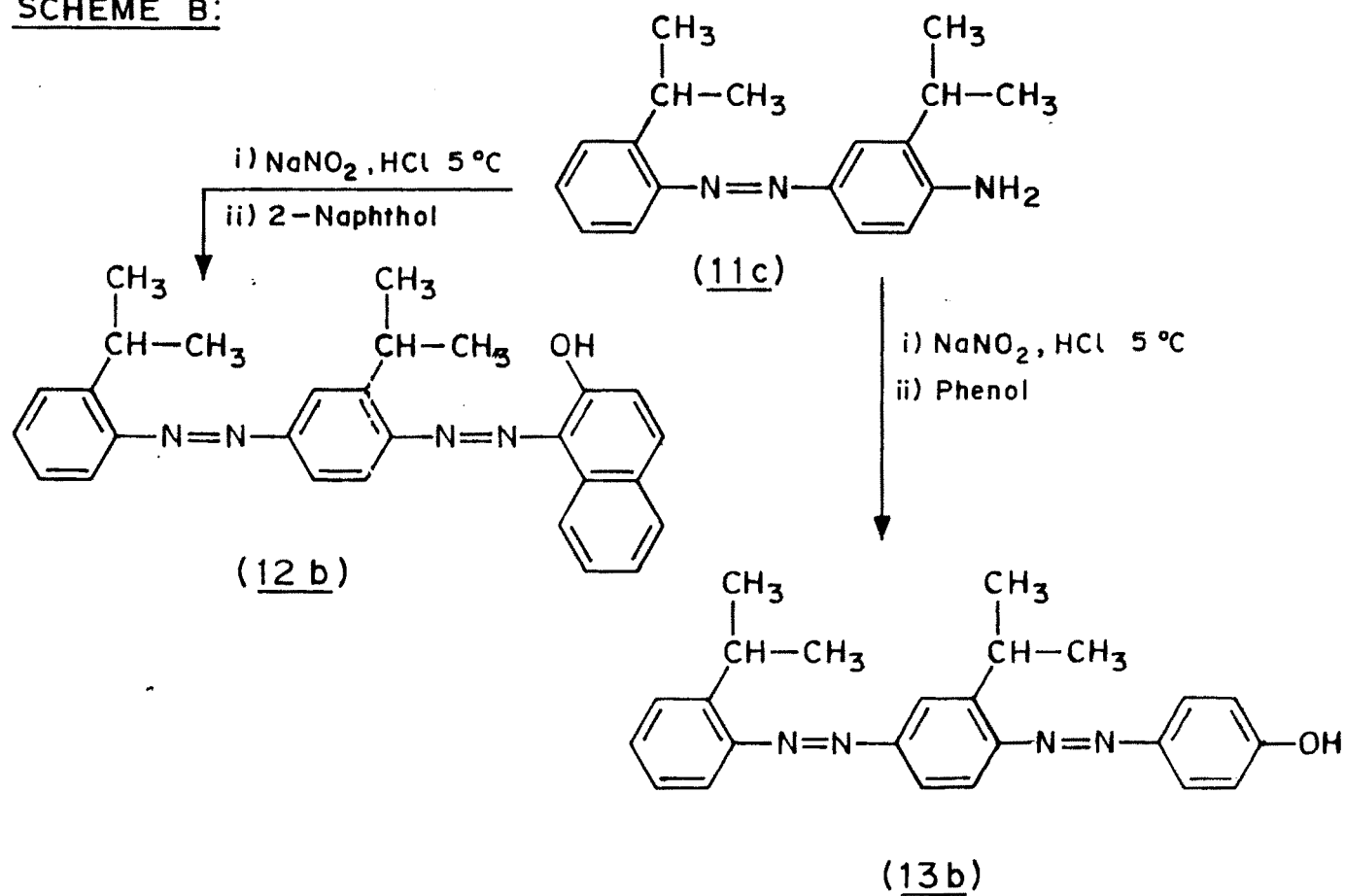
The aminoazo benzene derivatives (11a) and (11b) are known commercial solvent dyes. The compound (11a) is known as solvent yellow 2 (C.I.11020) and (11b) as solvent yellow 3 (C.I. 11160). The corresponding derivative (11c) synthesized from o-cumidine (4c) (Chart 4-A) was found to be a better solvent dye as it has better solubility than corresponding aniline and o-toluidine derivatives (11a) and (11b). The solubility data of these dyes are reported in Table 6.



SCHEME A:



SCHEME B:



### Solubility Study of Compounds (IIa), (IIb) and (IIc)

It was found that the dye (IIc) derived from *o*-cumidine (4c) has better solubility as compared to that of commercial solvent yellow 2 (IIa). In polar solvents such as ethanol, methanol, butyl acetate, ethyl acetate, cellosolve, stearic acid, acetone, the percentage increase in solubility ranged from 36 to 519. In non-polar solvents like toluene, xylene, kerosene, paraffin wax, carbon tetrachloride, benzene, chloroform, the solubilities ranged from 11 to 566 (Table 6).

Similarly the dye (IIc) has better solubility as compared to that of commercial solvent yellow 3 (IIb). In the polar solvents such as ethanol, methanol, butylacetate, ethyl acetate, cellosolve stearic acid, acetone, the percentage increase in the solubility ranged from 21 to 60, whereas in the non-polar solvent it ranged from 8 to 295. Overall, the percentage increase of (IIc) over solvent yellow 2 (IIa) is much better than the percentage increase over (IIb). Incorporating the isopropyl group in the place of methyl group has resulted in better solvent dyes.

### R<sub>f</sub> values of compound (IIa), (IIb) and (IIc)

The compounds (IIa), (IIb) and (IIc) were purified by using column chromatography on silica gel using petroleum-ether (60-80°) as eluent. The R<sub>f</sub> values have been measured by thin layer chromatography on silica gel coated glass plates and compared with the known commercial solvent dyes (IIa) and (IIb) using benzene as eluent. It is observed that by increasing the side chain viz. R=H, CH<sub>3</sub> and

TABLE 6 - SOLUBILITY DATA OF COMPOUNDS (IIa), (IIb) AND (IIc)

Sl.No.	Solvents used	Solubility, Gms/100gms of solvent				4-o-Cumyl- azo-o-cumidine (IIc) <sup>17</sup>	% increase of (IIc) over solvent yellow 2 (IIa)	% increase of (IIc) over (IIb)
		Solvent Yellow 2 (IIa) Reported <sup>16</sup>	Solvent Yellow 3 (IIb) Reported	Found	Found			
1	Ethanol	0.5-1.00	1.02	5.0 <sup>16</sup> 4.5 <sup>17</sup>	4.23	5.12	502	21
2	Acetone	3.50	3.20	8.0 <sup>16</sup> 25.00 <sup>17</sup>	10.00	15.00	368	50
3	Stearic Acid	1.5-10.00	5.00	8.00 <sup>16</sup> 6.00 <sup>17</sup>	7.00	11.50	130	60
4	Cellosolve	5.00	6.00	V.S. <sup>16</sup> 13.00 <sup>17</sup>	14.00	18.00	200	28
5	Ethyl acetate	2.00	2.10	8.00 <sup>16</sup> 20.00 <sup>17</sup>	10.00	13.00	519	30
6	Butyl acetate	-	11.00	-	12.00	15.00	36	25
7	Methanol	-	4.60	-	7.00	10.00	112	42
8	Toluene	1.2-3.0	3.00	6.00 <sup>17</sup> 3.60 <sup>16</sup>	3.70	4.00	33	8
9	Xylene	0.75-1.65	1.50	4.6 <sup>16</sup>	5.00	10.00	566	100
10	Kerosene	-	1.40	1.80 <sup>17</sup>	0.70	1.60	14	1280
11	Paraffin Wax	0.5-2.0	1.80	0.50 <sup>16</sup>	0.51	2.00	11	292
12	Carbon tetra- chloride	2.73	2.73	-	4.43	6.43	135	45
13	Benzene	2.80	2.90	5.8 <sup>16</sup>	5.70	12.00	315	110
14	Chloroform	-	25.00	-	30.00	40.00	60	33

$\text{CH}(\text{CH}_3)_2$  the polarity decreases as shown by the  $R_f$  values of (IIa), (IIb) and (IIc), recorded in Table 7.

**TABLE 7**  
 **$R_f$  VALUES OF COMPOUND (IIa), (IIb) and (IIc) IN BENZENE**

Compound No.	Name of the solventdye	$R_f$ values
<u>(IIa)</u>	Solvent yellow 2	0.37
<u>(IIb)</u>	Solvent yellow 3	0.4
<u>(IIc)</u>	<u>4- o-Cumylazo-o-cumidine</u>	0.55

**UV-Visible Spectra of Compounds (IIa), (IIb), (IIc)**

The wave length maxima ( $\lambda_{\text{max}}$ ) and molar extinction coefficients ( $\log \epsilon$ ) of the dyes (IIa), (IIb) and (IIc) are recorded in Table 8. The  $\lambda_{\text{max}}$  value of (IIc) is comparable with those of the commercial solvent dyes (IIa) and (IIb). However, the dye synthesized by us i.e. the o-cumidine derivative (IIc) has a marginally better tinctorial strength as shown by the increased  $\log \epsilon$  value. The electronic spectra of the dyes are represented in Figure 3 and Table 8.

**TABLE 8**  
**ELECTRONIC SPECTRA OF COMPOUNDS (IIa), (IIb) and (IIc)**

Compound No.	Name of the dye	$\lambda_{\text{max}}$	$\log \epsilon$
<u>(IIa)</u>	Solvent yellow 2	372	4.520
<u>(IIb)</u>	Solvent yellow 3	376	4.608
<u>(IIc)</u>	<u>4-o-Cumylazo-o-cumidine</u>	375	4.681

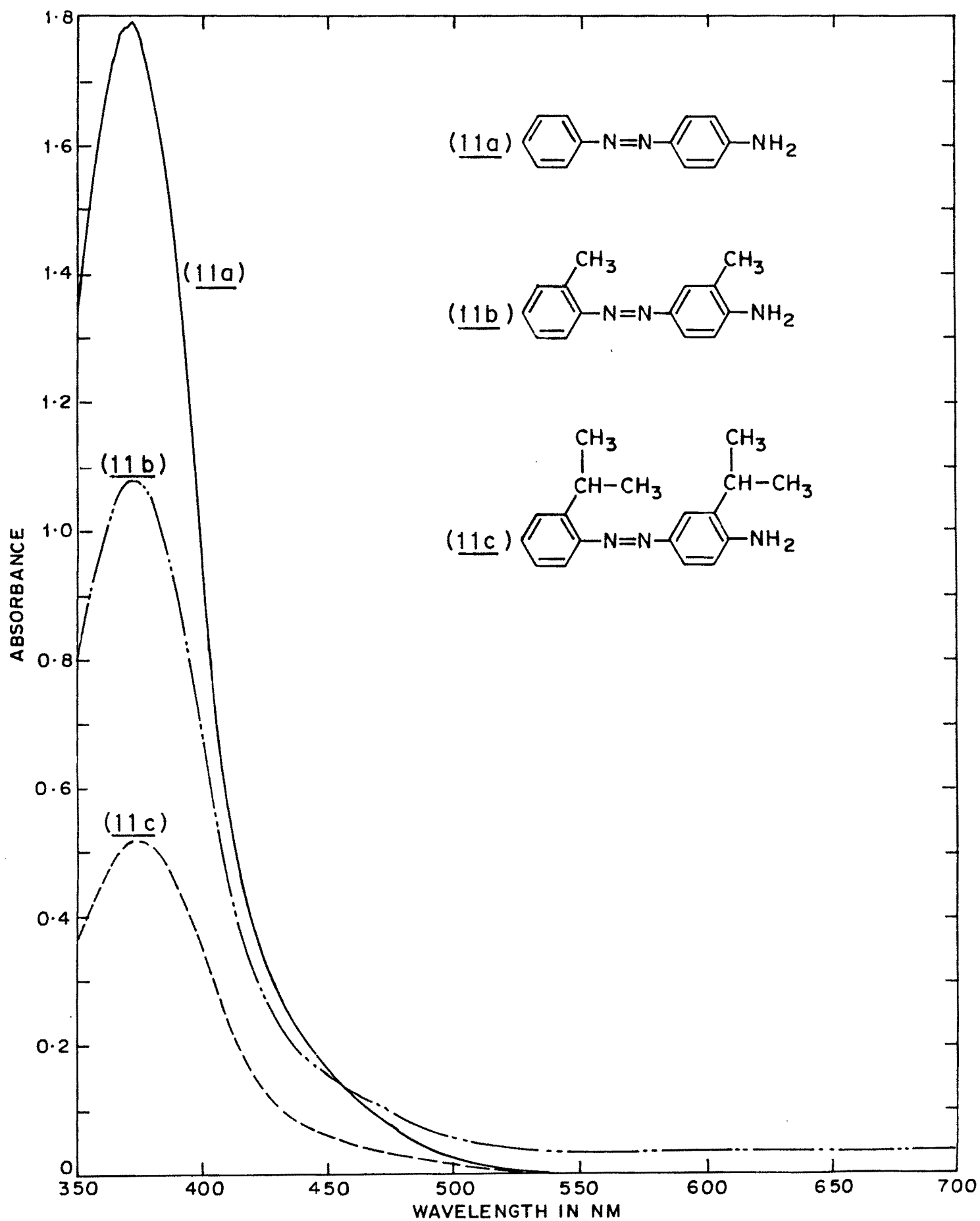


FIGURE 3

### Disazo Solvent Dyes - from 4-o-Cumylazo-o-Cumidine (I1c)

Disazo solvent dyes derived from 4-aminoazobenzene (I1a) and 4-o-tolylazo-o-toluidine (I1b) are widely used as commercial solvent dyes for colouration of soaps, waxes, petroleum products, fats, oils etc.

The 4-o-cumylazo-o-cumidine (I1c) as synthesized above was coupled with 2-naphthol and phenol to give the red and orange dyes (I2b) and (I3b) respectively as shown in Chart 4, Scheme B. The thin layer chromatography of the dyes (I2b) and (I3b) on silica gel glass plates with petroleum-ether:benzene (9:1) as eluent showed traces of unreacted starting material. The compounds (I2b) and (I3b) are purified by column chromatography on silica gel using petroleum ether:benzene as eluent.

### Solubility Study of Disazo Solvent Dyes (I2a,I2b) and (I3a, I3b)

The solubilities of purified dyes in different solvents were studied by the method described in experimental part. This was compared with similar dyes derived from 4-o-tolylazo-o-toluidine (I1b) viz. solvent red 24 (Table 9) and solvent orange 13 (Table 10). The solubility data are recorded in Tables 9 and 10.

It was found that the dye (I2b) Chart 4, Scheme B derived from (I1c) using 2-naphthol as coupling component had much better solubilities as compared to that of commercial solvent red 24 (I2a). In polar solvents like methanol, ethanol, acetone, stearic acid, cellosolve, ethylacetate, butyl acetate, the percentage increase in solubility ranged from 50 to 320 whereas that, in non-polar solvents such as

TABLE 9  
COMPARISON OF SOLUBILITY DATA OF COMPOUNDS (12a) AND (12b)

Sl.No.	Solvent used	Solubility gms/100 gms of solvent			Percentage increase of (12) over (12a)
		Solvent red 24 (12a)		Compound (12b)	
		Reported	Found	Found	
1	Ethanol	0.02-1 <sup>16</sup> 0.2 <sup>17</sup>	0.007	0.018	157
2	Acetone	0.15-3 <sup>16</sup> 3.4 <sup>17</sup>	0.07	0.49	64
3	Stearic acid	0.2-5 <sup>16</sup> 3 <sup>17</sup>	0.2	0.325	62.5
4	Cellosolve	S.S. <sup>16</sup> 0.7 <sup>17</sup>	0.022	0.028	27
5	Ethylacetate	2.5 <sup>17</sup>	0.17	0.42	147
6	Butyl acetate	0.12-3 <sup>16</sup>	0.14	0.59	320
7	Methanol	2 <sup>17</sup>	0.003	0.006	100
8	Toluene	V.S. <sup>16</sup>	0.64	2.14	86
9	p-Xylene	-	0.8	1.72	115
10	Kerosene	- 0.8 <sup>17</sup>	0.03	0.155	416
11	Paraffin Wax	-	0.27	0.59	118
12	Carbon tetra- chloride	-	0.4	2.98	645
13	Benzene	0.06-5 <sup>16</sup>	1.72	4.56	165

TABLE 10  
COMPARISON OF SOLUBILITY DATA OF COMPOUNDS (13a) AND (13b)

Sl.No.	Solvents used	Solubility gms/100 gms of solvent			Percentage increase of (13b) over (13a)
		Solvent Orangel3 (13a)		Compound (13b)	
		Reported <sup>16</sup>	Found	Found	
1	Ethanol	0.9	1.0	1.5	50
2	Acetone	2.8	2.7	3.52	30
3	Stearic Acid	6.0	5.6	8.1	45
4	Cellosolve	-	2.0	4.1	105
5	Ethyl acetate	1.5	1.3	2.2	69
6	Butyl acetate	2.9	3.01	5.1	69
7	Methanol	-	0.6	1.1	83
8	Toluene	2.0	1.8	4.1	127
9	p-Xylene	-	3.0	6.2	107
10	Kerosene	1.0	0.8	1.2	50
11	Paraffin Wax	2.0	1.8	3.1	72
12	Carbon tetra- chloride	-	2.0	2.5	25
13	Benzene	1.5	1.4	4.1	192



toluene, *p*-xylene, kerosene, paraffin wax, carbon tetrachloride, benzene, ranged from 80 to 640 (Table 9).

Similarly, the dye (13b) derived from (11c) and coupled with phenol, Chart 4, Scheme B, also had much better solubilities than the commercial solvent orange 13 (13a). In polar solvents, like methanol, ethanol, acetone, stearic acid, cellosolve, ethyl acetate, butyl acetate the percentage increase in solubility ranged from 30 to 105, whereas that in non-polar solvents ranged from 25 to 107 (Table 10).

#### UV-Visible Spectra of Disazo dyes (12) and (13) in chloroform

The wavelength maxima and molar extinction coefficient are recorded in Table II. As compared to the commercial solvent red 24 (12a),  $\lambda_{\max}$  523, the dye derived from *o*-cumidine (11c) showed bathochromic shift of the order of 3 nm with the better tinctorial strength. In comparison with solvent orange 13, the new dye (13b) shows considerable bathochromic shift of the order of 50 nm and 56 nm with marginal better tinctorial power. The electronic spectrum of the dyes are shown in Figure 4.

The photographic view of the solution of the dyes (12a), (12b), (13a), (13b) in chloroform at equivalent concentration is shown in Figure 5.

TABLE II  
ELECTRONIC SPECTRA OF COMPOUNDS (12) AND (13) IN  
CHLOROFORM

Compd.No.	$\lambda_{\max}$ (nm)	$\text{Log } \epsilon$	$\lambda_{\max}$ (nm)	$\text{Log } \epsilon$
(12a)	354	3.964	520	4.255
(12b)	355	4.169	523	4.192
(13a)	384	4.544	475	4.1272
(13b)	440	4.586	525	4.1317

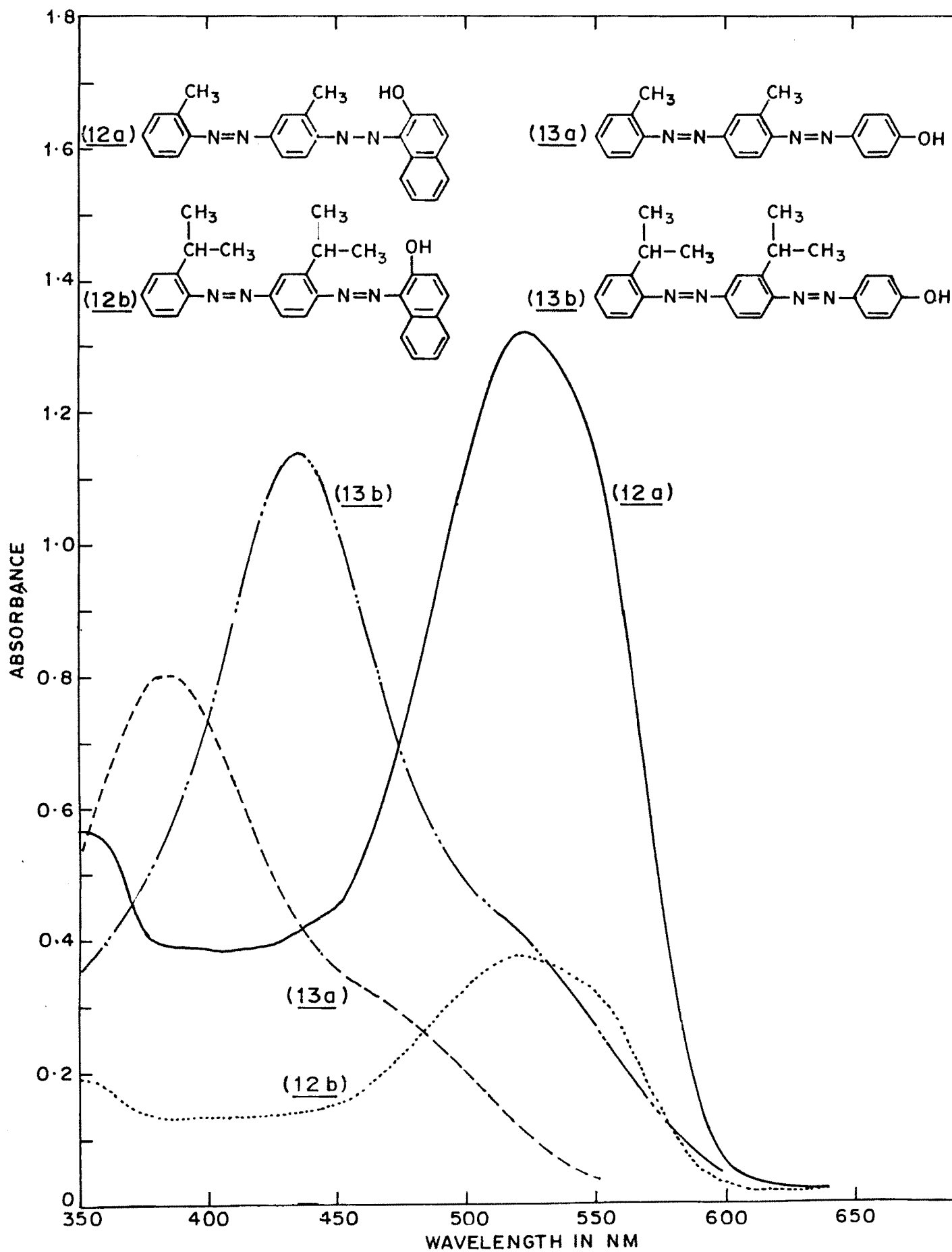
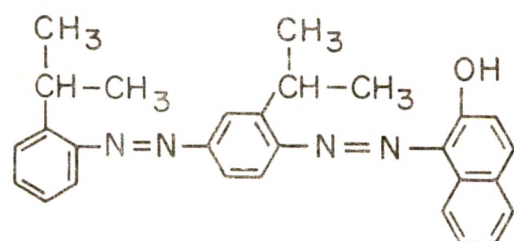
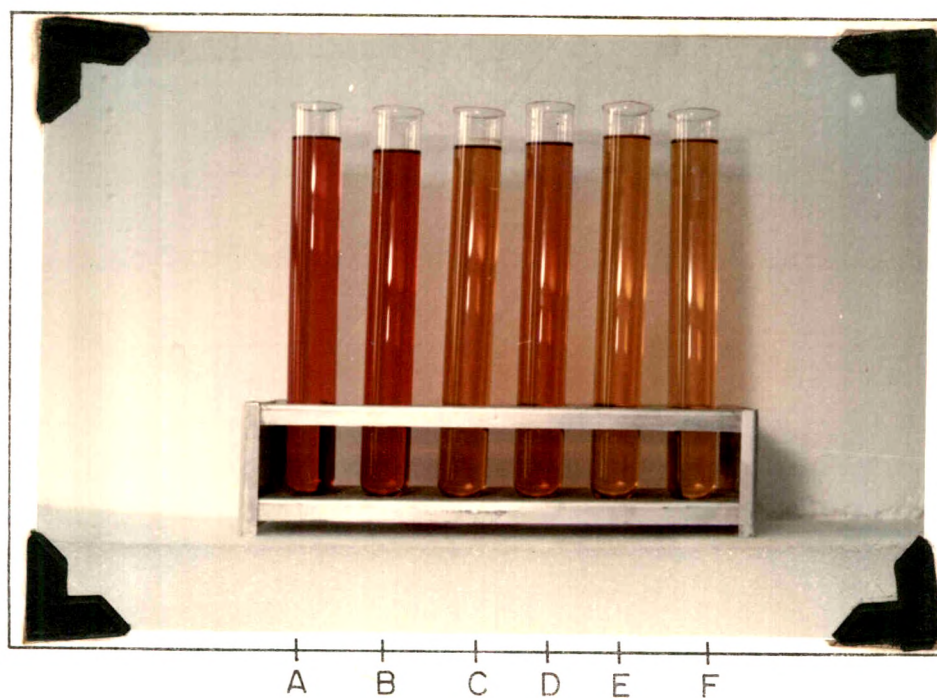
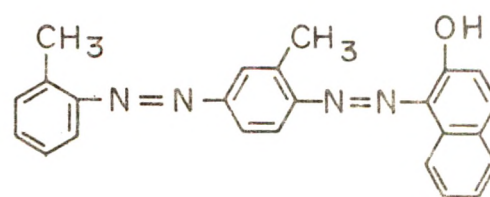


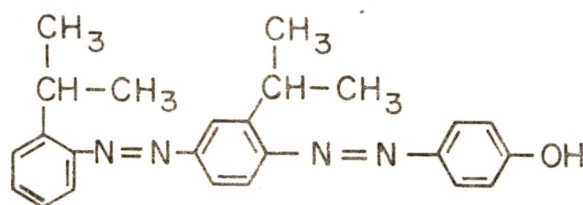
FIGURE 4



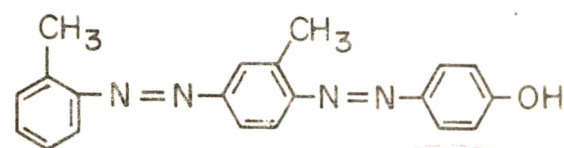
A - Compound (12b)



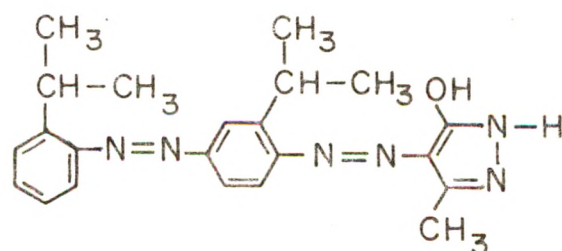
B - Solvent red 24 (12a)



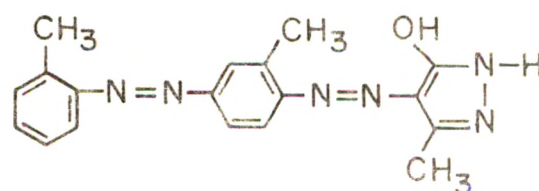
C - Compound (13b)



D - Solvent orange 13 (13a)



E - Compound (17c)



F - Compound (17b)

FIGURE-5

### Disazo Dyes from 4-o-cumylazo-o-cumidine (11c) with commercial naphthols as coupling component

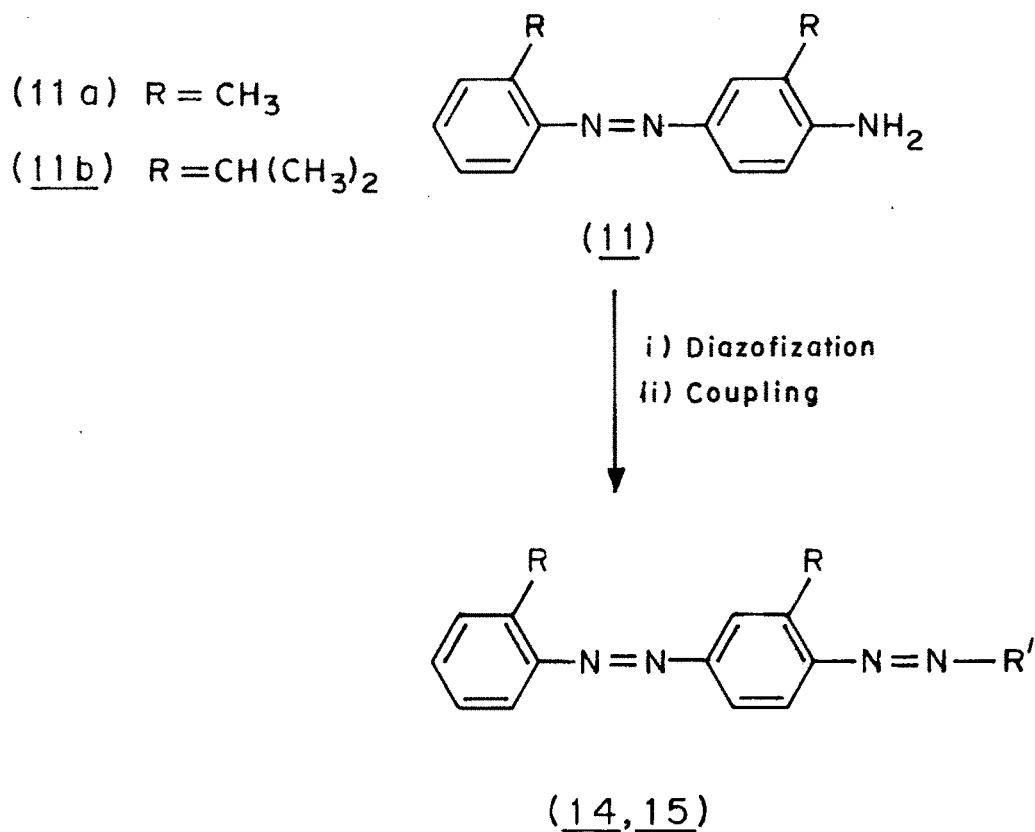
The disazo dyes have been synthesized from 4-o-cumylazo-o-cumidine (11c) as a disazo component and commercial naphthols as coupling component. These dyes were compared with the dyes derived from compound (11b) using same series of commercial naphthols. All these disazo dyes showed red colour and were comparable with the dyes derived from (11b). (Chart 7) shows the preparation of such disazo dyes from commercial naphthols.

### Electronic Spectra of the compounds (14) and (15) in Chloroform and $R_f$ values in Benzene

The electronic spectra of disazo dyes (15a), (15b), (15c) and (15d) were compared with those of the commercial disazo dyes (14a), (14b), (14c) and (14d) derived from o-toluidine derivative (11b) and commercial naphthols. The spectral data are recorded in Table 12, Figure 6. Also, the  $R_f$  values in benzene of the corresponding disazo dyes are recorded in Table 12.

### Dyes derived from o-cumidine using 3-methyl-5-pyrazolone as coupling component

3-Methyl 1-phenyl-5-pyrazolone had been used as coupling component for the synthesis of solvent yellow dyes and solvent orange dyes. A few examples of the solvent dyes are given in Chart 8. The only example of a monoazo dye incorporating o-toluidine as a diazo component and 3-methyl-1-phenyl-5-pyrazolone as a coupling component is a pigment (C.I. 12720) for wall papers. However, we found that the monoazo dye prepared by coupling diazo-o-cumidine

CHART - 7

- (14 a)  $R = CH_3$ ,  $R' = \text{NAPHTHOL} - \text{AS}$   
 (15 a)  $R = CH(CH_3)_2$ ,  $R' = \text{NAPHTHOL} - \text{AS}$   
 (14 b)  $R = CH_3$ ,  $R' = \text{NAPHTHOL} - \text{ASD}$   
 (15 b)  $R = CH(CH_3)_2$ ,  $R' = \text{NAPHTHOL} - \text{ASD}$   
 (14 c)  $R = CH_3$ ,  $R' = \text{NAPHTHOL} - \text{ASE}$   
 (15 c)  $R = CH(CH_3)_2$ ,  $R' = \text{NAPHTHOL} - \text{ASE}$   
 (14 d)  $R = CH_3$ ,  $R' = \text{NAPHTHOL} - \text{ASTR}$   
 (15 d)  $R = CH(CH_3)_2$ ,  $R' = \text{NAPHTHOL} - \text{ASTR}$

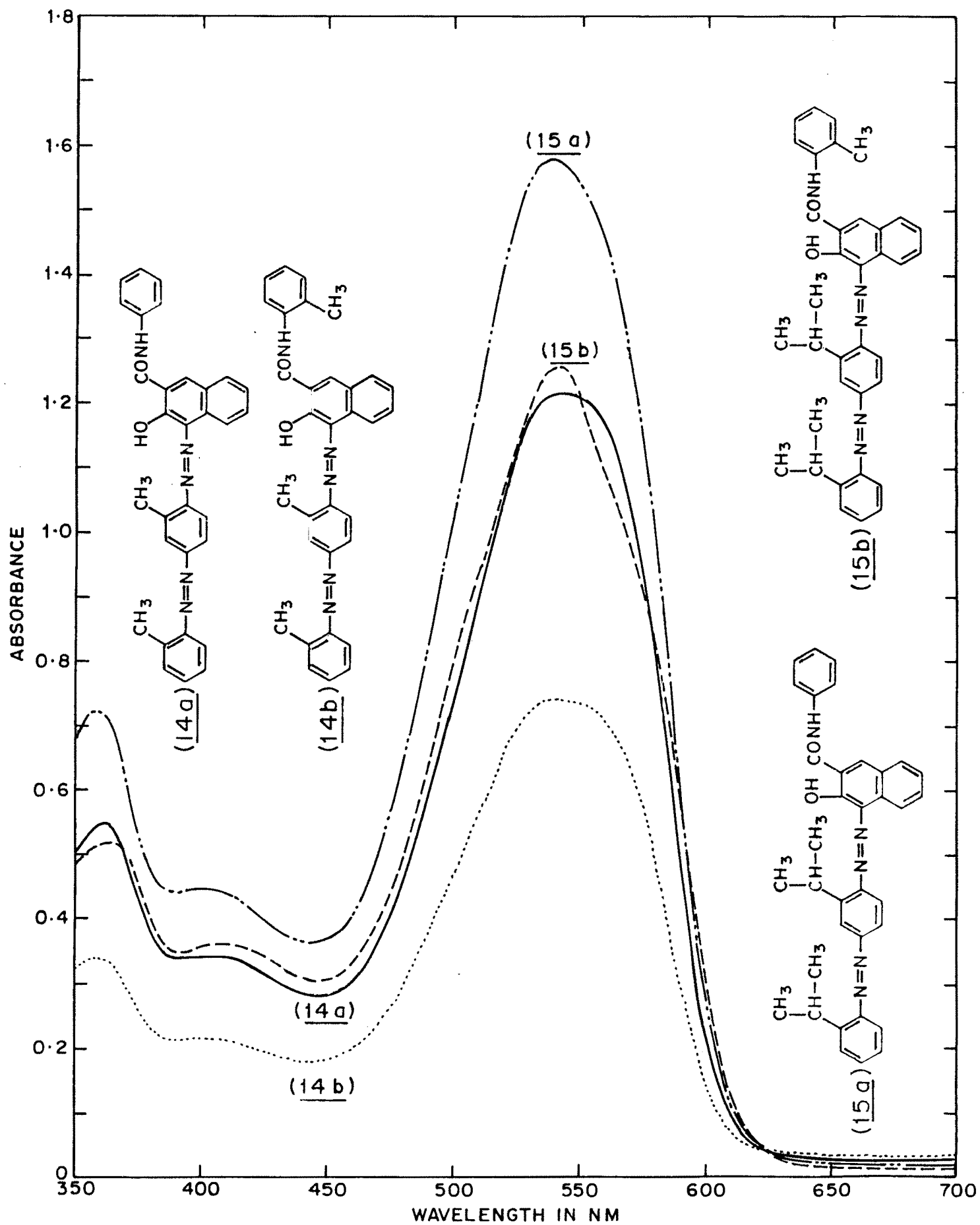


FIGURE 6

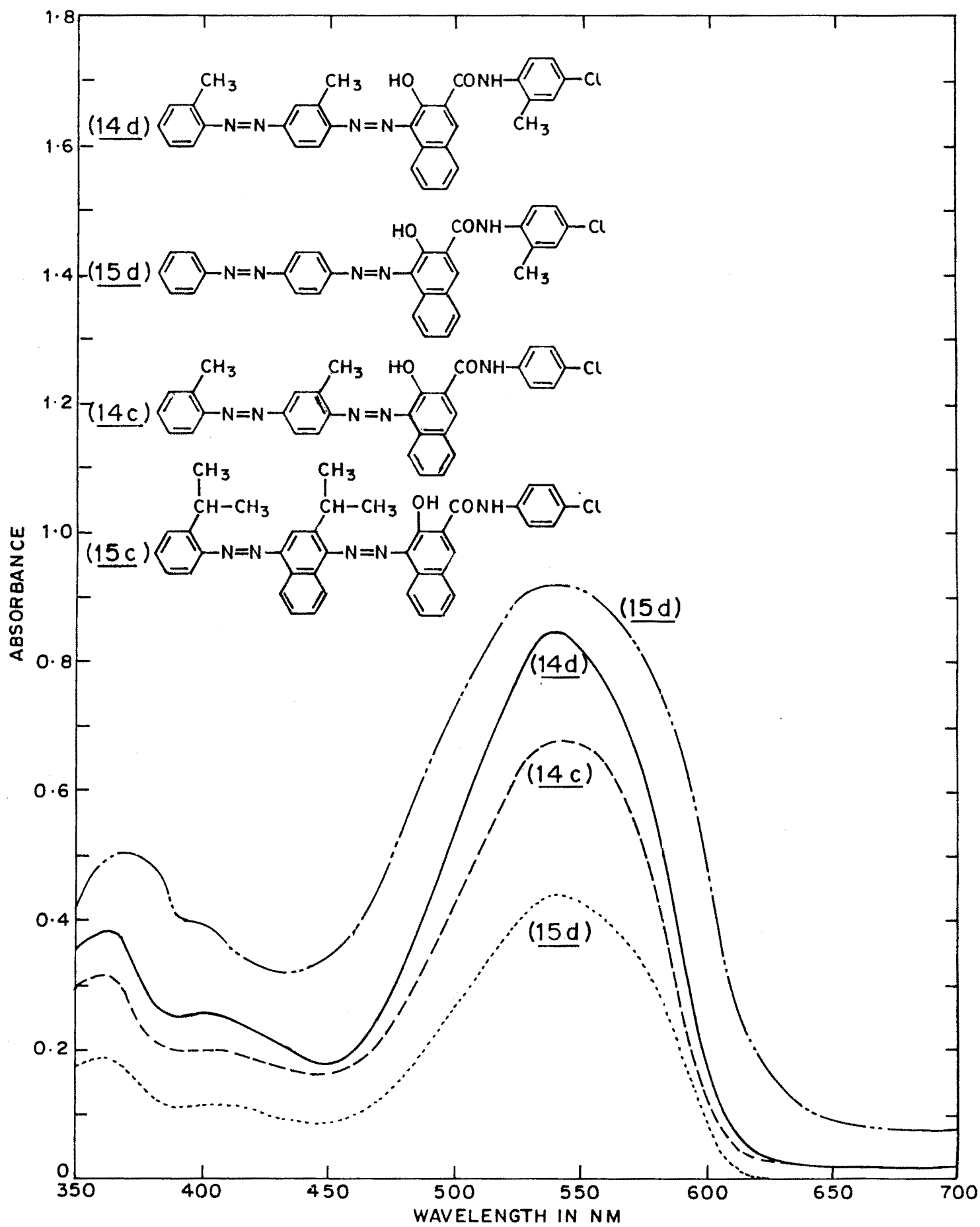


FIGURE 6 (contd.)

TABLE 12  
ELECTRONIC SPECTRA IN CHLOROFORM AND  $R_f$  VALUES IN BENZENE OF  
COMPOUNDS (14a to 14d) AND (15a to 15d)

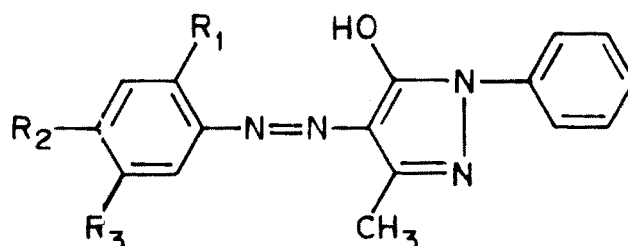
Compound	$\lambda_{\text{max}}$ (nm)	$\log \epsilon$	$R_f$ values in benzene
<u>(14a)</u>	543	4.5412	0.48
<u>(15a)</u>	542	4.5540	0.47
<u>(14b)</u>	537	4.5572	0.40
<u>(15b)</u>	539	4.5440	0.43
<u>(14c)</u>	545	4.6410	0.47
<u>(15c)</u>	540	4.890	0.49
<u>(14d)</u>	540	4.493	0.44
<u>(15d)</u>	540	4.5607	0.46



CHART-8

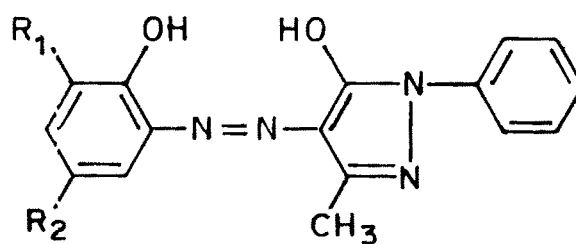
SOLVENT DYES FROM PYRAZOLONE

A: SOLVENT YELLOW DYES



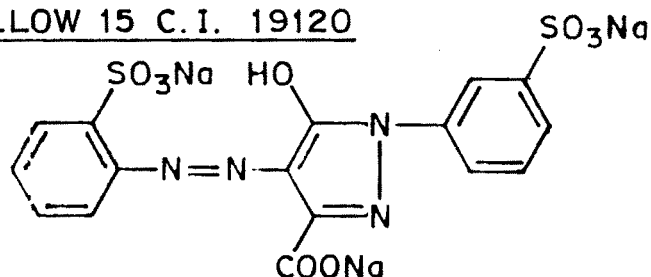
		R <sub>1</sub>	R <sub>2</sub>	R <sub>3</sub>
SOLVENT YELLOW 12	C.I. 12700	H	H	H
SOLVENT YELLOW 18	C.I. 12740	CH <sub>3</sub>	CH <sub>3</sub>	H
SOLVENT YELLOW 21	C.I. 18690	COOH	H	H Cr-Complex
SOLVENT YELLOW 23	C.I. 12731	H	CH <sub>3</sub>	NO <sub>2</sub>

B: SOLVENT ORANGE DYES

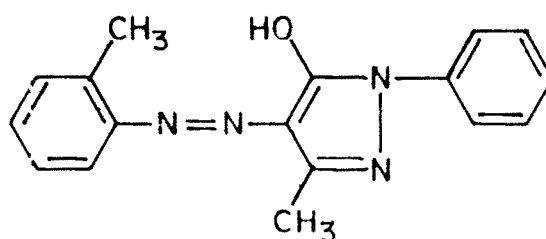


		R <sub>1</sub>	R <sub>2</sub>
SOLVENT ORANGE 5	C.I. 18745:1	SO <sub>3</sub> H	NO <sub>2</sub>
SOLVENT ORANGE 6	C.I. 18736:1	SO <sub>3</sub> H	Cl
SOLVENT ORANGE 62	C.I. 12214	H	NO <sub>2</sub>

C: SOLVENT YELLOW 15 C.I. 19120



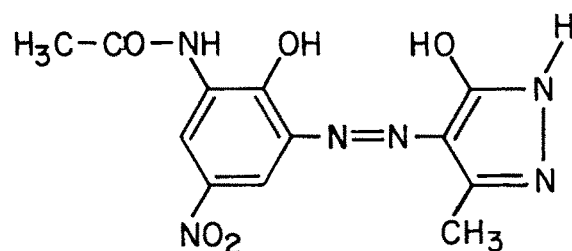
PIGMENT C. I. 19720



DYES FROM 3-METHYL-5-PYRAZOLONE

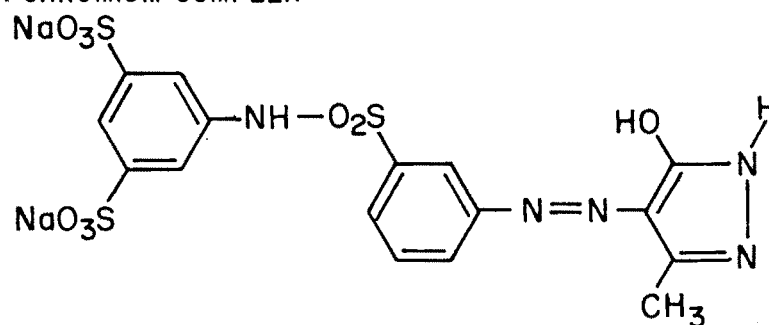
D:

ACID ORANGE 99 C.I. 12696

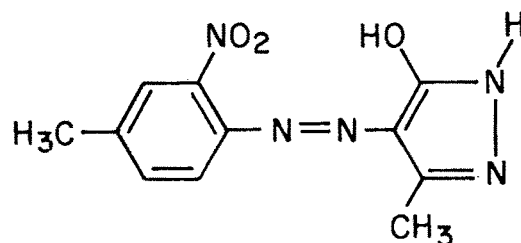


ACID ORANGE 106 C.I. 18680

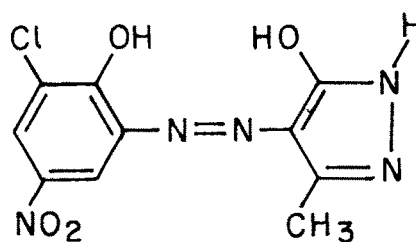
A CHROMIUM COMPLEX



DESPERSE YELLOW 8 C.I. 12695



ACID ORANGE 98 C.I. 12695



with 3-methyl-5-pyrazolone gives rise to yellow solvent dye having very good solubility in both polar and non-polar solvents. The survey of recent Colour Index Volumes also did not reveal any disazo commercial solvent dyes based on 3-methyl-5-pyrazolone.

Therefore, we synthesized monoazo disazo dyes based on o-cumidine, p-aminoazobenzene, p-tolylazo-o-toluidine, p-o-cumylazo-o-cumidine as diazo component and 3-methyl-5-pyrazolone as coupling component as shown in Chart 9. The performance of these new dyes were evaluated as solvent dyes.

#### Solubility Study of 3-methyl-5-pyrazolone dyes (16a,16b) and (17b,17c)

The solubilities of purified 3-methyl-5-pyrazolone dyes (16a,16b) and (17b,17c) were studied using polar and non-polar solvents. The dyes (16b) and (17c) were compared with similar dyes (16a) and (17b) derived from o-toluidine and 4-o-tolylazo-o-toluidine (11b).

It was observed that the dye (16b) derived from o-cumidine has higher solubilities as compared to the dye (16a) derived from o-toluidine. In polar solvents the percentage increase ranged from 66 to 808 and non-polar solvents ranged from 50 to 900 (Table 13).

Similarly, the dye (17c) derived from (11c) and coupled with 3-methyl-5-pyrazolone also had much higher solubilities as compared to the dye (17b). Table 14 shows the percentage increase of (17c) ranged from 677 to 2000 in polar solvents and 184 to 900 in non-polar solvents over (17b).

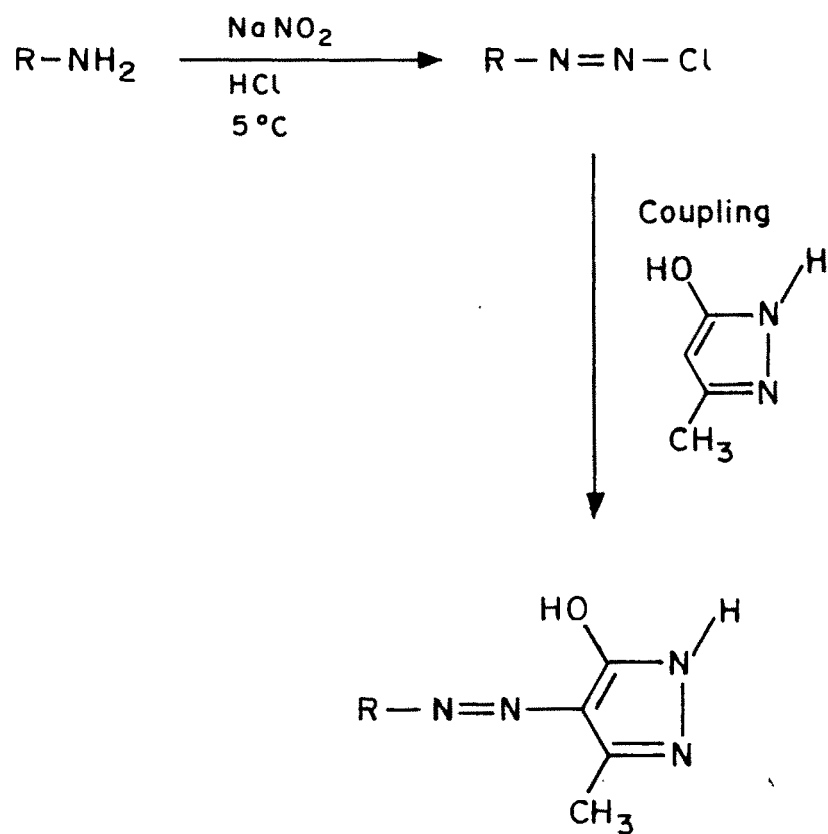
CHART-9(16a) R = o-Tolyl(16b) R = o-Cumyl(17a) R = p-Aminoazobenzene(17b) R = (p-Tolylazo)-o-toluidine(17c) R = (p-Cumylazo)-o-cumidine

TABLE 13  
COMPARISON OF SOLUBILITY DATA OF COMPOUNDS (16a) AND (16b)

Sl.No.	Solvents used	Solubility gms/100 gms of solvent		Percentage increase of compound (16b) over (16a)
		Compound (16a)	Compound (16b)	
1	Ethanol	0.13	1.2	823
2	Acetone	0.30	0.50	66
3	Stearic acid	0.30	0.83	176
4	Cellosolve	0.30	2.50	733
5	Ethyl acetate	0.15	1.20	700
6	Butyl acetate	0.25	1.80	620
7	Methanol	0.62	1.09	808
8	Toluene	0.21	2.10	900
9	p-Xylene	0.23	2.5986	
10	Kerosene	0.02	0.12	525
11	Paraffin Wax	0.80	1.20	50
12	Carbon tetra- chloride	0.20	0.30	50
13	Benzene	0.12	1.1	816

TABLE 14  
SOLUBILITY DATA OF COMPOUND (17a) AND (17c)

Sl.No.	Solvents used	Solubility Gms/100gms of solvent		Percentage increase of (17c) over (17b)
		Compound (17b)	Compound(17c)	
1	Ethanol	0.16	0.23	1000
2	Stearic acid	0.09	0.7	677
3	Butyl acetate	0.031	0.83	2000
4	Kerosene	0.046	0.13	184
5	Paraffin Wax	0.13	0.4	200
6	Chloroform	2.4	6.9	187

**Electronic Spectra (in chloroform) and  $R_f$  values (in benzene) of  
3-Methyl-5-pyrazolone dyes (16a, 16b) and (17a, 17b, 17c)**

The wave length maxima and molar extinction coefficient are recorded in Table 15. The dyes (17b) and (17c) derived from 4-o-tolylazo-o-toluidine (11b) and 4-o-cumylazo-o-cumidine (11c) respectively showed bathochromic shift of the order of 9 to 10 nm with better tinctorial strength as compared to the dye (17a) derived from aminoazobenzene (11a) (Table 15, Fig. 7). The photographic view of the solution of the dyes (17b) and (17c) in chloroform at equivalent concentration is shown in Figure 5.

**Light Fastness of Monoazo and Disazo Dyes (5a), (5b), (12a), (12b), (17b) and (17c)**

The comparative light fastness of monoazo and disazo dyes derived from o-cumidine and o-toluidine as diazo components respectively have been evaluated by recording their electronic spectra in butyl acetate at different intervals after exposing the solution of dyes in sunlight over a period of 120 hours. The data is recorded in Table 17.

The dye (5b) derived from o-cumidine showed greater reduction (0.1878) in molar extraction coefficient (log absilon) as compared to the dye commercial solvent orange 2 (C.I. 12100) (5a) (0.0379) over the same period of time. However, the performance of (12b) was comparable ( $\lambda_{\max} 517 = 0.0788$ ,  $\lambda_{\max} 355 = 0.0415$ ) to that of commercial solvent red 24 C.I. 26105 ( $\lambda_{\max} 517 = 0.05989$ ,  $\lambda_{\max} 365 = 0.01675$ ). The 3-methyl-5-pyrazolone dyes (17c) and (17b) also showed the comparable reduction of absilon values (0.0336 and 0.710 respectively).

TABLE 15

ELECTRONIC SPECTRA AND  $R_f$  VALUES OF 3-METHYL-5-PYRAZOLONE  
DYES (16a - 16b) AND (17a,17b,17c)

Compound No.	$\lambda_{\max}$ (chloroform) (nm)	log $\epsilon$	$R_f$ values in benzene
(16a)	444	4.54340	0.021
(16b)	443	4.5340	0.025
(17a)	440	4.5125	0.028
(17b)	450	4.6924	0.048
(17c)	449	4.6998	0.085



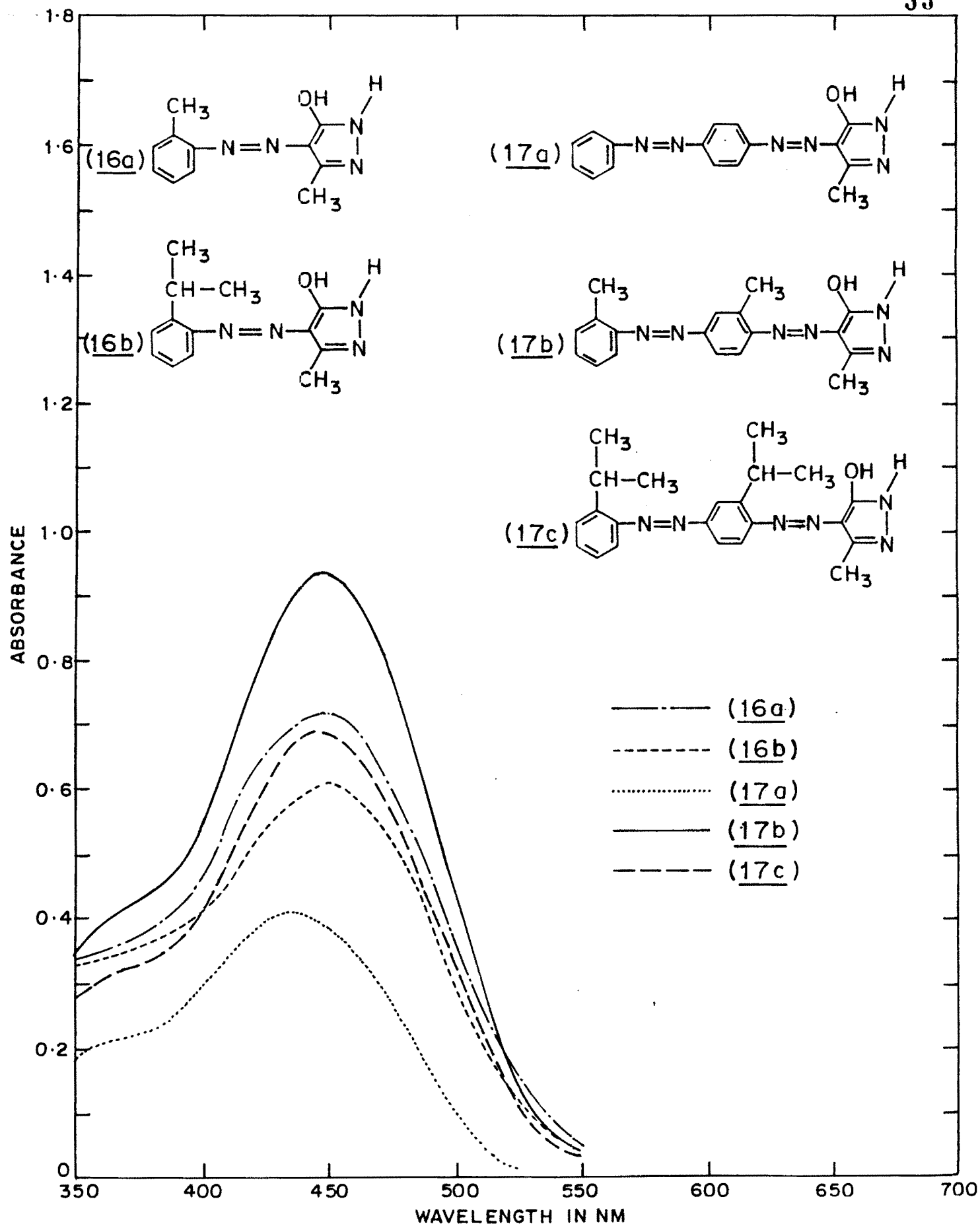


FIGURE - 7

TABLE 17 - LIGHT FASTNESS OF MONO,DISAZO AND PYRAZOLONE DYES (5a), (5b),(12a), (12b), (17b) and (17c)  
(ELECTRONIC SPECTRA IN BUTYL ACETATE)

Hrs of sunlight	Monoazo dyes (5a)		Disazo dyes (12a)		Pyrazolone dyes (17b)		Pyrazolone dyes (17c)					
	$\lambda_{\text{max}}(\text{nm})$	Log $\epsilon$	$\lambda_{\text{max}}(\text{nm})$	Log $\epsilon$	$\lambda_{\text{max}}(\text{nm})$	Log $\epsilon$	$\lambda_{\text{max}}(\text{nm})$	Log $\epsilon$				
0	481	4.1467	483	4.14327	517	4.43971	517	4.43585	444	4.51559	443	4.46790
24	481	4.14608	483	4.12892	365	4.08495	355	4.13280	444	4.51979	443	4.45680
72	481	4.12984	483	4.05171	365	4.088004	355	4.13209	444	4.46665	443	4.44860
96	481	4.12653	483	3.96700	365	4.09103	355	4.12662	444	4.45990	443	4.44486
120	481	4.10884	483	3.95540	365	4.06938	355	4.08730	444	4.44450	443	4.4343
					365	4.06920	355	4.08730				

### Pigments prepared from ortho-cumidine derivative (5-nitro-o-cumidine)

The nitration of o-toluidine is normally associated with simultaneous formation of small quantity of 6-nitro-o-toluidine with 4-nitro-o-toluidine as major product. This small quantity (2-4%) of 6-nitro-o-toluidine in commercial 5-nitro-o-toluidine gives inferior dyeing when applied as azoic diazo component. The nitration of o-cumidine with conc.  $H_2SO_4$  and  $HNO_3$  gives only 5-nitro isomer viz. 5-nitro-o-cumidine (18) and no formation of other isomer was observed. The nitration of o-cumidine (4c) is represented in (Chart 10-A). This nitro derivative of o-cumidine when applied as azoic diazo component gave dyeing similar to 5-nitro-o-toluidine. The structure of 5-nitro-o-cumidine was confirmed by IR and PMR spectra.

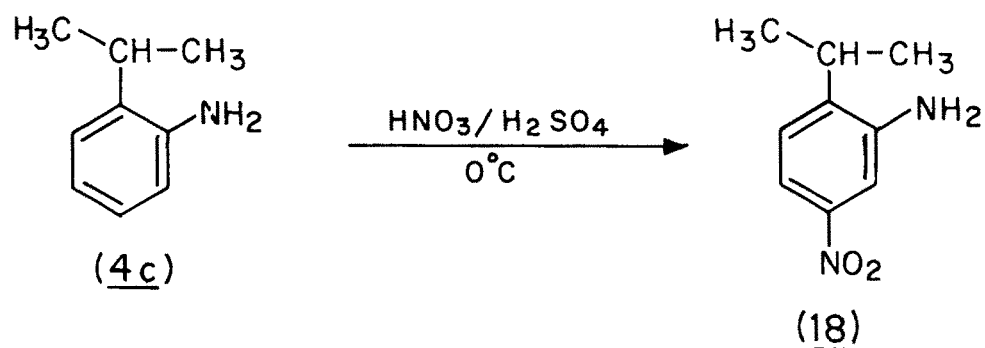
Derivatives of o-toluidine, such as 5-nitro-o-toluidine (Fast Scarlet G-Base), 4-nitro-o-toluidine, 4-chloro-o-toluidine (Fast Red K.B. Base) and 5-chloro-o-toluidine (Fast Red TR Base) are used as azoic diazo components listed in Chart II. Ortho-cumidine (4c) is structurally similar to o-toluidine with a large electron donating isopropyl group.

Therefore, it was felt that the derivatives of o-cumidine such as 5-nitro-o-cumidine can also give rise to pigments comparable with those derived from 5-nitro-o-toluidine.

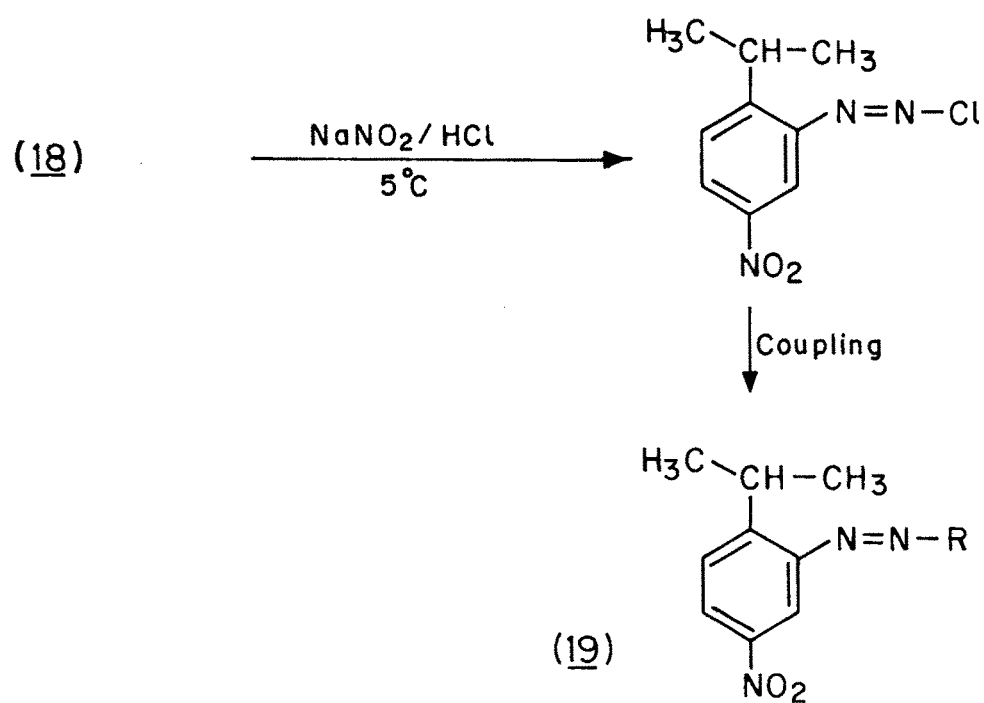
### Preparation of Pigments from 5-Nitro-o-cumidine (18)

5-Nitro-o-toluidine (Scarlet G Base (C.I. 37105) is used as diazo component to prepare major commercial pigments such as pigment orange 3 (C.I. 12105), pigment red 22 (C.I. 12315), pigment red 162 (C.I. 12390), pigment red 8 (C.I. 12335) and pigment red 114 (C.I. 12351) (Chart 11).

A:



B:



- (19a) R = 2-NAPHTHOL
- (19b) R = NAPHTHOL-AS
- (19c) R = NAPHTHOL-ASD
- (19d) R = NAPHTHOL-ASE
- (19e) R = NAPHTHOL-ASBS

C:

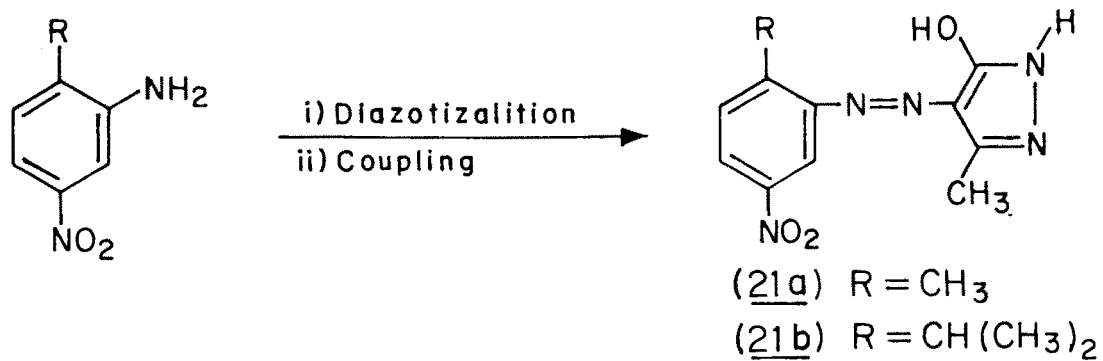


CHART 11  
AZOIC DIAZO COMPONENTS OF o-TOLUIDINE

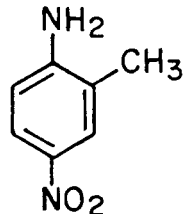
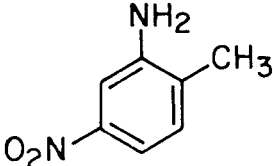
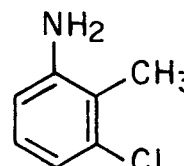
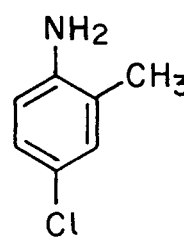
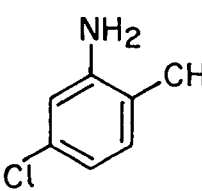
NAME OF THE AZOIC DIAZO COMPONENT	C.I. NUMBER	COMMERCIAL NAME	CHEMICAL NAME	CHEMICAL STRUCTURE
AZOIC DIAZO COMPONENT 34	37100	RED RL BASE	4-NITRO- <u>o</u> -TOLUIDINE	
AZOIC DIAZO COMPONENT 12	37105	SCARLET G. BASE	5-NITRO- <u>o</u> -TOLUIDINE	
AZOIC DIAZO COMPONENT 46	37080	—	3-CHLORO- <u>o</u> -TOLUIDINE	
AZOIC DIAZO COMPONENT 11	37085	FAST RED K B BASE	4-CHLORO- <u>o</u> -TOLUIDINE	
AZOIC DIAZO COMPONENT 32	37090	FAST RED T R BASE	5-CHLORO- <u>o</u> -TOLUIDINE	

Chart 10B represents pigments derived from 5-nitro-o-cumidine (18). The compound (18) was diazotized and coupled with corresponding commercial naphthols and 3-methyl-5-pyrazolone to get the pigments (19a-19c) and (21a,21b) respectively (Chart 10-B,C).

#### **R<sub>f</sub> Values of compounds (19a to 19c) and (21a, 21b) in benzene**

The compounds (19a), (19b), (19c), (19d), (19e) and (21b) were purified by column chromatography using silica gel and benzene as eluent. All the above dyes derived from 5-nitro-o-cumidine were compared with the known commercial pigments (20a), (20b), (20c), (20d), (20e) and (21a). The dye (21a) is not commercialised and not reported in Colour Index<sup>3</sup>. It is observed that by increasing the electron donating nature of the side chain  $-\text{CH}_3$  to  $-\text{CH}(\text{CH}_3)_2$ , the polarity decreases as shown by the  $R_f$  values of compounds (19a to 19e) and (21a, 21b) recorded in Table 16.

#### **The Electronic Spectra of Compounds (19a - 19e) and (21a, 21b)**

The wave length maxima in nm and molar extinction coefficient are recorded in Table 16. The pigments (19a), (19b), (19c), (19d), (19e) and (21b) derived from 5-nitro-o-cumidine (18) showed the comparable  $\lambda_{\text{max}}$  and tinctorial strength with the pigments (20a), (20b), (20c), (20d), (20e) and (21a) derived from 5-nitro-o-toluidine (Chart 12, Figure 8).

The photographic view of the solution of the pigment orange 3 (20a), pigment red 22 (20b), pigment red 162 (20c), pigment red 8 (20d), pigment red 114 (20e), (21a) and (19a to 19e,21b) in chloroform at equivalent concentration is shown in Figure 9.

TABLE 16 - ELECTRONIC SPECTRA (IN CHLOROFORM) AND  $R_f$  VALUES (IN BENZENE)  
OF COMPOUNDS (17), (18) AND (19)

Compound	$\lambda_{\max}$ (nm)	Log $\epsilon$	$\lambda_{\max}$ (nm)	Log $\epsilon$	$\lambda_{\max}$ (nm)	Log $\epsilon$	$R_f$ Values
(18a)	-	-	480	4.2796	-	-	0.47
(18a)	-	-	480	4.3208	-	-	0.68
(18b)	410	3.9700	498	4.3406	515	4.5414	0.20
(18b)	410	2.9132	498	3.2909	515	3.29092	0.25
(18c)	415	3.8356	495	3.1661	520	3.1604	0.19
(18c)	415	4.0925	495	4.466	520	4.458	0.21
(18d)	410	3.8638	490	4.2111	520	4.2087	0.30
(18d)	410	3.7576	490	3.7308	520	3.6599	0.35
(18e)	415	3.7072	495	3.9852	520	4.0228	0.26
(18e)	415	3.8103	495	4.0577	520	4.62948	3.30
(19a)	398	4.3040	405	4.2891	-	-	0.02
(19b)	398	4.1944	405	4.1953	-	-	0.02

## CHART 12

COMMERCIAL PIGMENTS FROM 5-NITRO-*o*-TOLUIDINE

COM. NO.	NAME OF THE PIGMENT	C. I. NUMBER	COUPLING COMPONENT	STRUCTURE OF THE PIGMENT
(20a)	PIGMENT ORANGE 3	12105	2-NAPHTHOL	
(20b)	PIGMENT RED 22	12315	NAPHTHOL-AS	
(20c)	PIGMENT RED 162	12390	NAPHTHOL-ASD	
(20d)	PIGMENT RED 8	12335	NAPHTHOL-ASE	
(20e)	PIGMENT RED 114	12351	NAPHTHOL-ASBS	



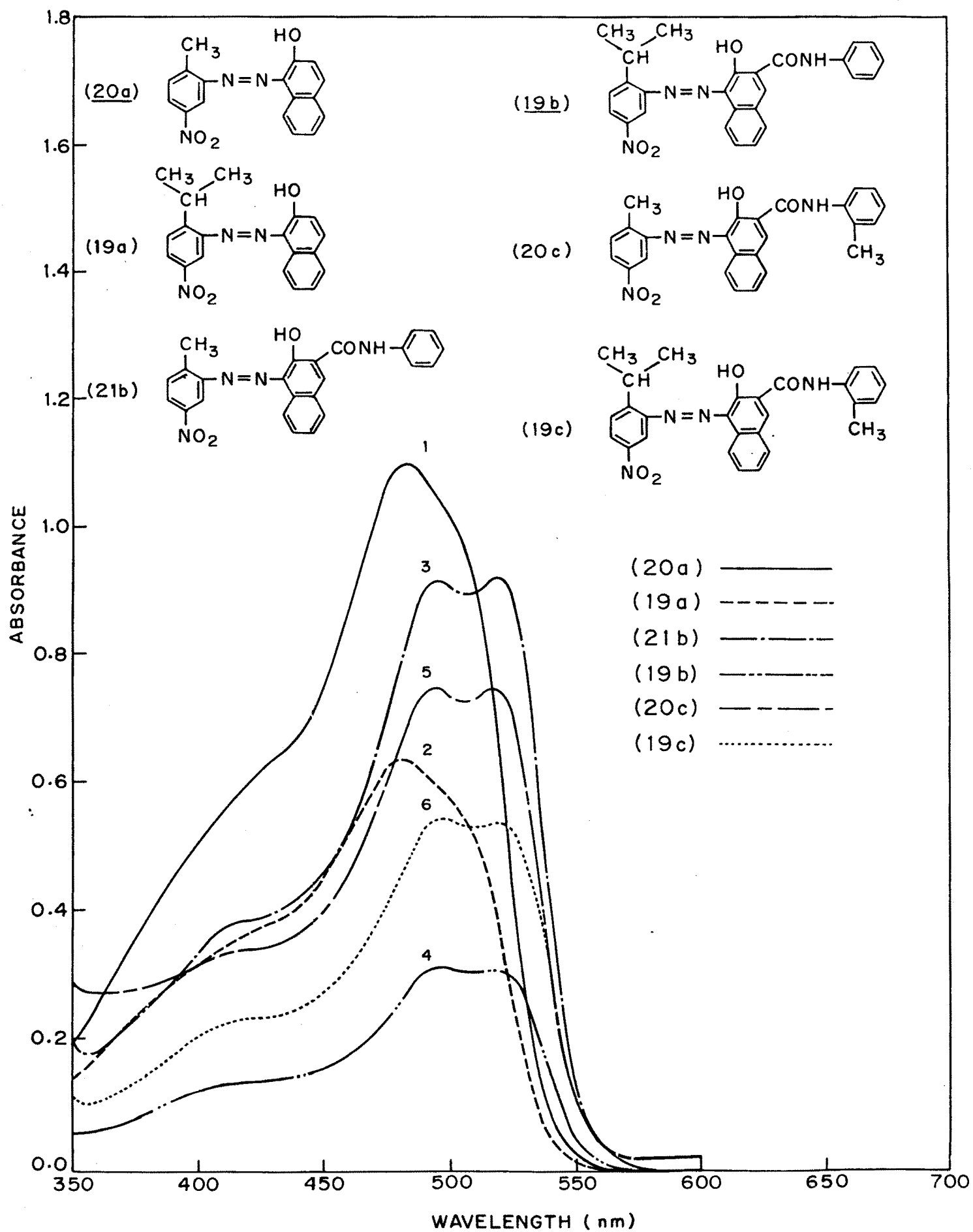


FIGURE - 8

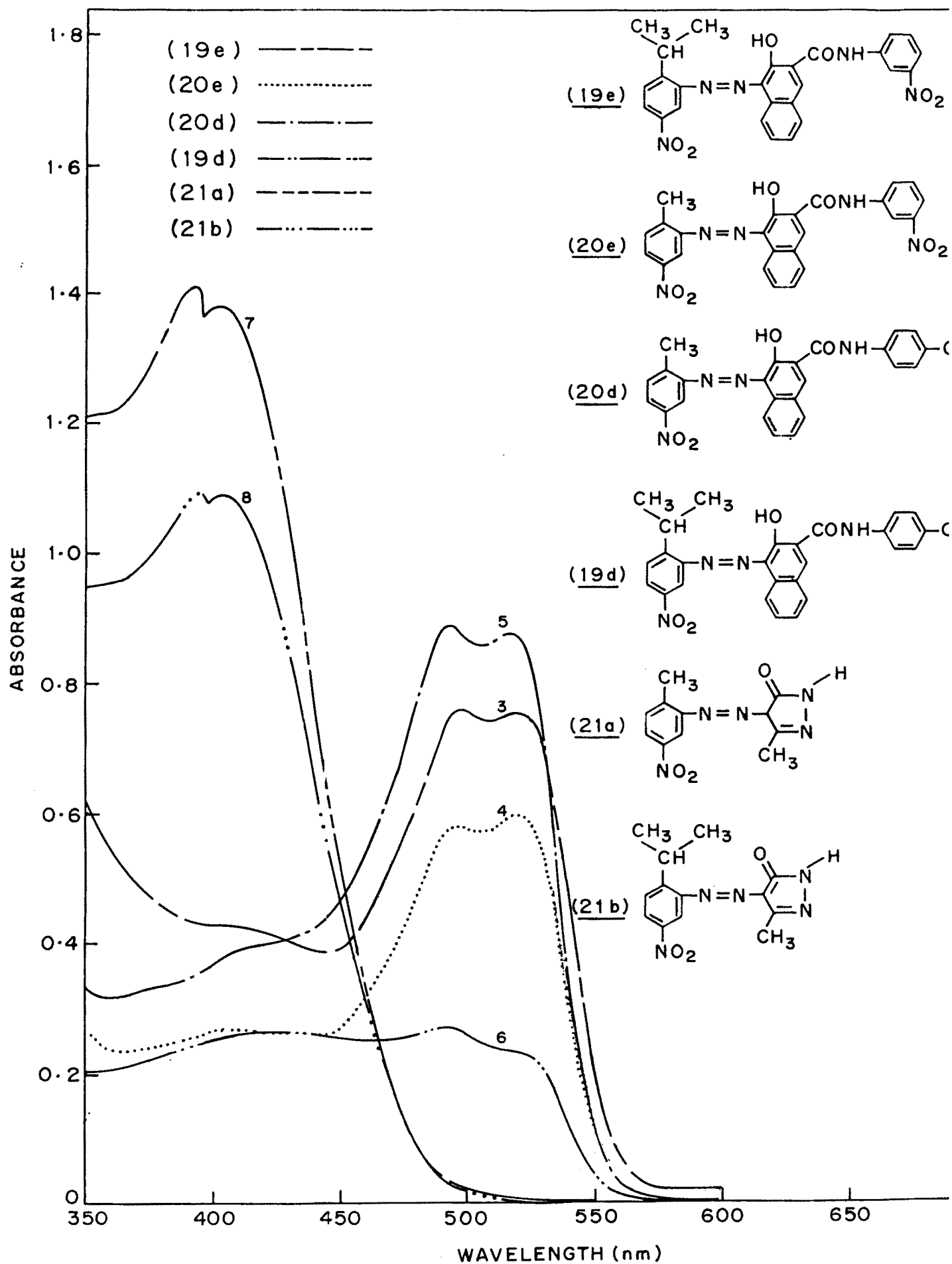
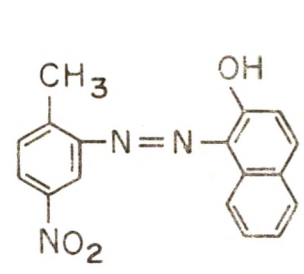
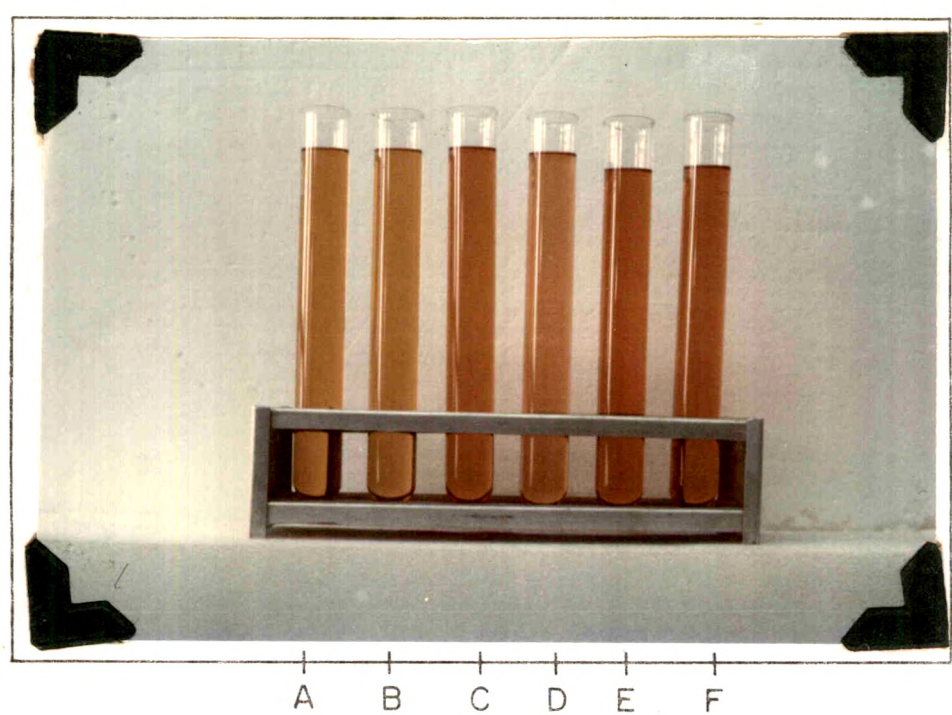
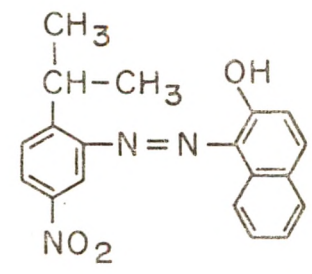


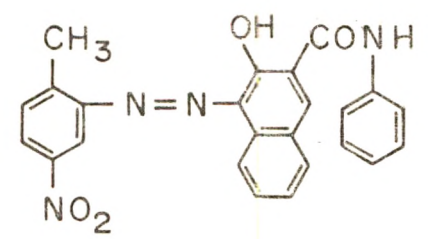
FIGURE-8 (Continued)



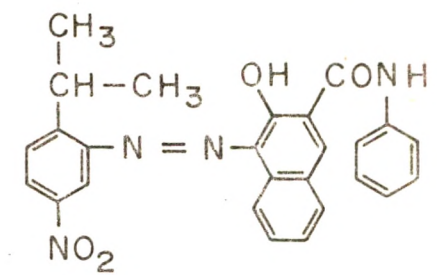
A - Pigment orange 3 (20a)



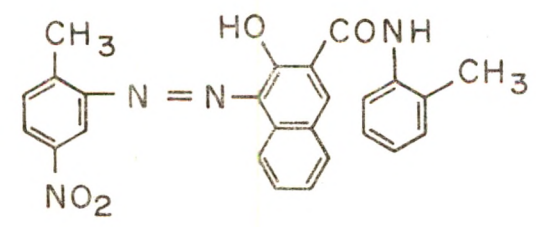
B - Compound (19a)



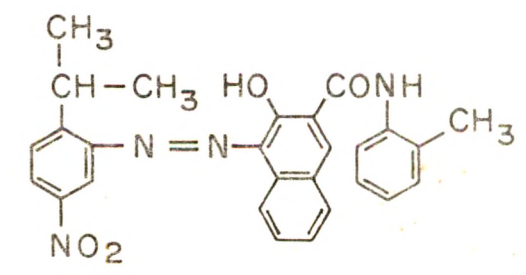
C - Pigment red 22 (20b)



D - Compound (19b)

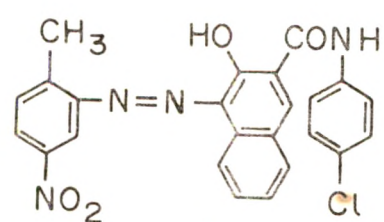
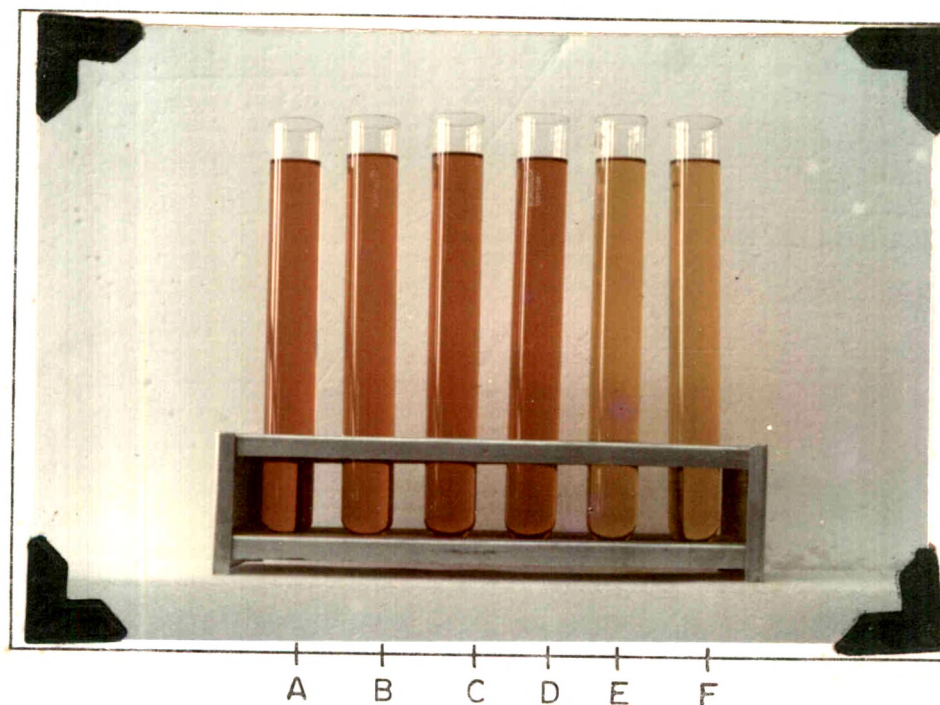


E - Pigment red 162 (20c)

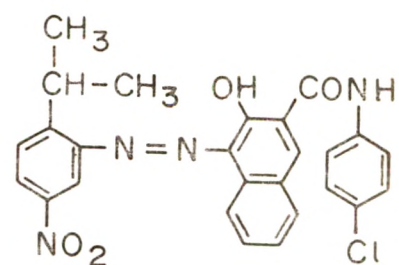


F - Compound (19c)

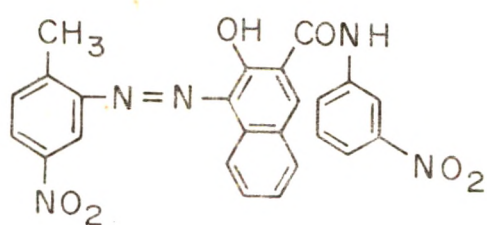
FIGURE-9



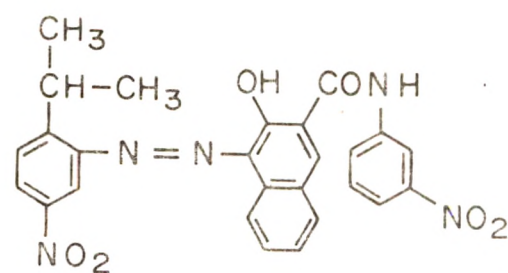
A - Pigment red 8 (20d)



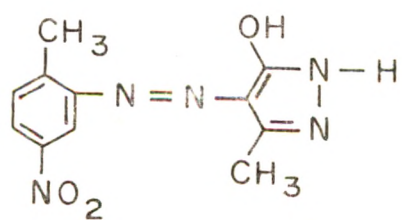
B - Compound (19d)



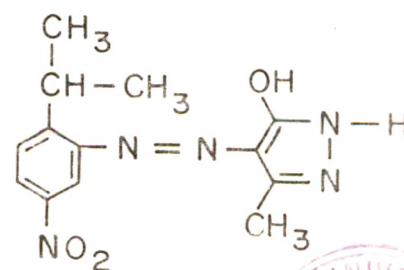
C - Pigment red 114 (20e)



D - Compound (19e)



E - Compound (21a)



F - Compound (21b)



WITH 5-NITRO-o-TOLUIDINE









COUPLING COMPONENTS USED	1% SHADE SCARLET G BASE C.I. 37105	1% SHADE 5-NITRO-o-CUMIDINE (18)
NAPHTHOL-ASG		
NAPHTHOL-ASBO		
NAPHTHOL-AS		
NAPHTHOL-ASBS		

FIGURE 10

**Comparison of dyeing behaviour of 5-nitro-o-cumidine hydrochloride with 5-nitro-o-toluidine**

5-Nitro-o-cumidine was dyed as azoic diazo component with different naphthols such as Naphthol AS-G Naphthol AS-BS, Naphthol AS-BS and Naphthol ASBO.

In case of Naphthol AS-G, dyeing obtained from 5-nitro-o-cumidine is greener than the corresponding o-toluidine derivative (Fast Scarlet G Base). Similarly dyeing with Naphthol AS-BO cumidine derivative is stronger and redder, as compared with toluidine derivative. The dyeings with Naphthol AS and Naphthol AS-BS are comparable (Figure 10).

---

SECTION-C

---

**Preparation of o-nitrocumene (3)**

The nitration of cumene has been carried out following the procedure described by Haun and Kobe<sup>1</sup>. The separation of o-nitrocumene isomer from the crude reaction mixture (3 kgs) was achieved by fractional distillation under reduced pressure (13 mm/Hg) in 5 lit. distillation flask using 2.5 cms I.D. glass column of height 60 cms and packed with "Hyflux" s.s. packings. Unreacted cumene (8 g) was removed as first fraction at 50 to 60°C. After all the unreacted cumene has been removed, o-nitrocumene started coming out at 110°C. Reflux ratio was maintained at about 10:1 by adjusting the drops in the reflux head. In this way, 400 g of o-nitrocumene was collected. GLC analysis of the product revealed purity of 99.5%, b.p. 115°C/13 mm, reported<sup>1</sup> 111.5°C/9mm.

**Synthesis of o-Cumidine (4c)**

A mixture of iron powder (100 g) and water (150 ml) was heated to reflux (100°C). o-Nitrocumene (3) (85.5 g, 0.5 mole) was added slowly to the mixture over a period of 3 to 4 hrs. Simultaneously additional iron powder (100 g) was also added in the flask. The completion of the reduction was tested by dropping the reaction mixture on a filter paper containing a drop of aqueous sodium hydroxide solution, when no yellow colour due to unreacted o-nitrocumene was detected. This was further confirmed by GLC analysis of an aliquot of the reaction mixture after suitable extraction. The reaction mixture was steam-distilled. The crude o-cumidine collected from the distillate was subjected to distillation under reduced pressure (13 mm/Hg) to yield the o-cumidine (60.7 g, 80% yield) b.p. 214°/732 mm; 95°C/13 mm; reported 214°C/732 mm, 95°C/13 mm.



The purity of the product was ascertained by GLC analysis.

**General procedure for the synthesis of monoazo dyes**

**Synthesis of o-cumidine-2-naphthol (5b)**

Ortho-cumidine (1.35 g, 0.01 mole) was dissolved in concentrated hydrochloric acid (10 ml) and 60 ml water and cooled to 0 to 5°C. Sodium nitrite (0.6 g, 0.01 mole) dissolved in 20 ml water was added dropwise with stirring at 0-5°C. After diazotization was complete, excess sodium nitrite was destroyed by using sulfamic acid.

In another beaker, 2-naphthol (1.44 g, 0.01 mole) was dissolved in sodium hydroxide solution and cooled to 0-5°C. The above chilled diazo solution was added dropwise with stirring to the naphthol solution. The pH was adjusted to 7 to 7.5.

The coloured precipitate was filtered and washed with water thrice and dried. Crude dye was purified by column chromatography on silica gel using benzene-pet.ether (80:20) as eluent and crystallized from benzene and petroleum ether in orange red crystals (2.3 g, 80%) m.p. 140°C.

**Reddish orange dye (5b)**

Crystallized from benzene and petroleum ether, m.p. 140°C.

Found: C, 78.52; H, 6.10; N, 9.61;

$C_{19}H_{18}N_2O$  requires: C, 78.64; H, 6.2; N, 9.66%.

UV-Vis:  $CHCl_3$   
 $\lambda_{max}$  492 nm (log  $\epsilon$  4.235)  
 520nm (log  $\epsilon$  4.185)

IR (Nujol): 1600, 1550, 1425, 1350, 1300, 1250, 1200, 1125, 1040, 800, 750 (Hydroxyl

is strongly chelated and was not seen in IR spectra).

$^1H$ -NMR ( $CDCl_3$ ):

1.25 - 1.3 (3H, s,  $-CH_3$  group on the benzene ring at C-1 3H, s,  $-CH_3$  group on the benzene ring on the same carbon).

3.3 - 3.4 (1H, m, proton of the  $-CH$  group attached to the benzene ring)

6.5 - 8.8 (10H, m, protons of the aromatic ring).

16.5 (1H, s, OH group of the naphthalene ring, exchangeable with D<sub>2</sub>O) (Figure 11).

Mass: M<sup>+</sup> 290

Fragments at 275(52%), 183(27%), 158(23%), 143(23%), 133(100%), 115 (51%), 91 (37%), 77(28%), 69(94%), (Figure 12).

#### Synthesis of o-cumidine → 1-naphthol (6b)

The dye (6b) was synthesized by the general procedure described above. The crude dye (6b) was purified by column chromatography on silica gel using petroleum ether, benzene (60:40) as eluent. The dye separates out as red crystals (2.3 g, 80%) m.p. 100°C.

Red dye (6b):

Crystallized from petroleum ether and benzene, m.p. 100°C.  
(Found: C, 78.45; H, 6.13; N, 9.56; C<sub>19</sub>H<sub>18</sub>N<sub>2</sub>O requires: C, 78.64; H, 6.2; N, 9.66%).

IR and <sup>1</sup>H-NMR showed similar pattern.

UV-Vis: CHCl<sub>3</sub> max 398 nm (log ε 4.054), 460 nm (log ε 3.760).

Mass: M<sup>+</sup> 290.

#### Synthesis of o-cumidine → p-cresol (7b)

Similar method of diazotization and coupling was followed as described above in general procedure. The yellow crude dye was purified by column chromatography on silica gel using petroleum ether and benzene (60:40) as eluent in yellowish red crystals m.p. 50-54°C.

Yellowish red dye (7b)

Crystallized from petroleum ether and benzene m.p. 53-55°C.  
(Found: C, 75.41; H, 6.92; N, 11.3; C<sub>16</sub>H<sub>18</sub>N<sub>2</sub>O requires: C, 75.59; H, 7.09; N, 11.02%).

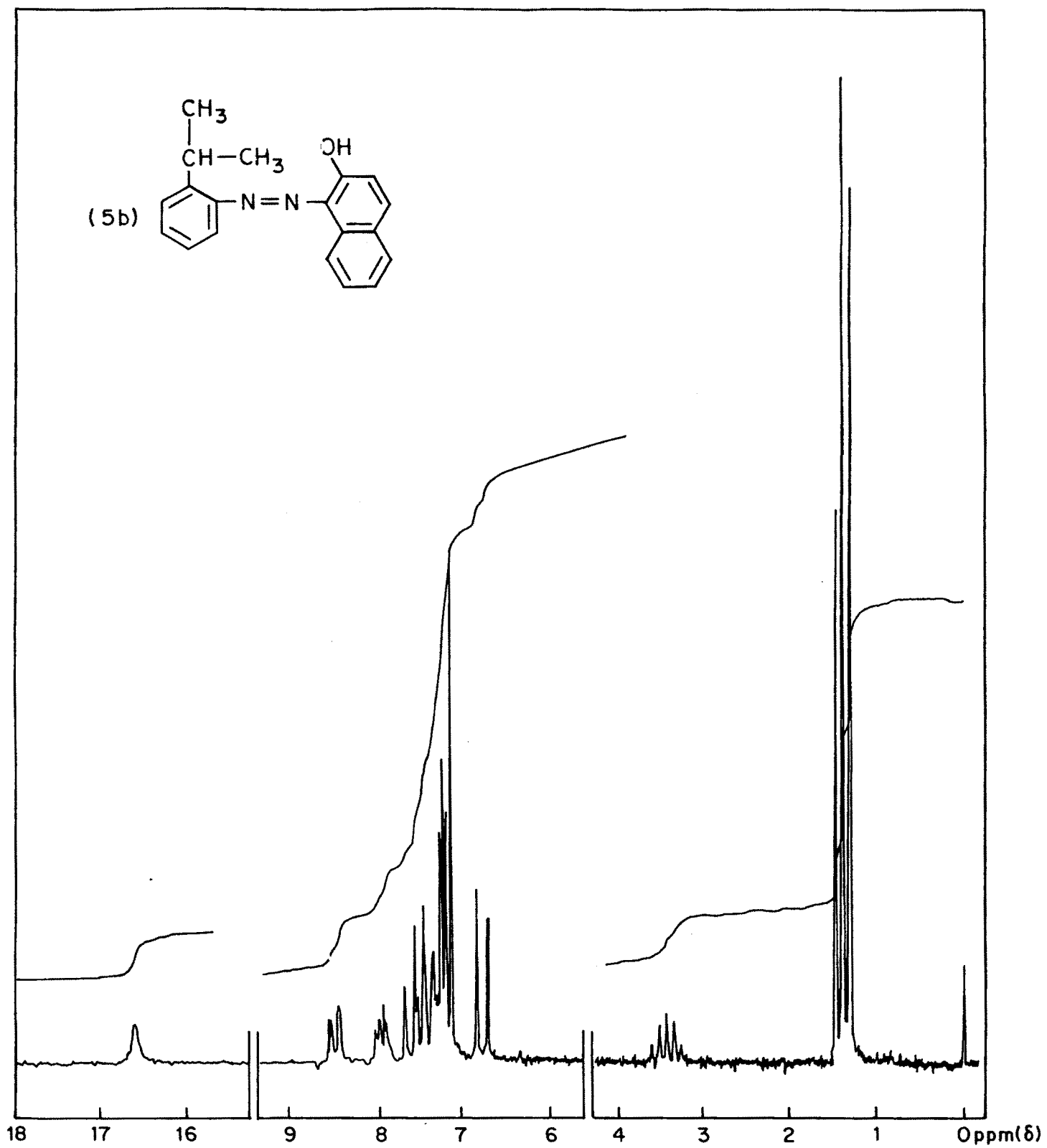


FIGURE 11

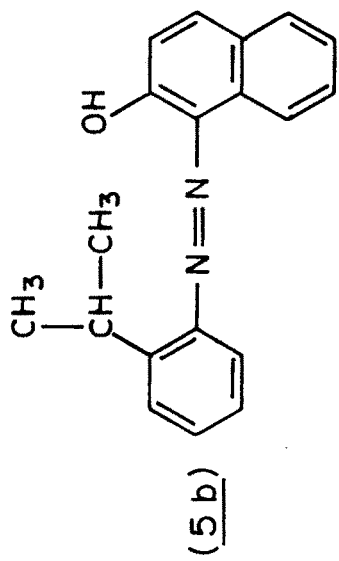
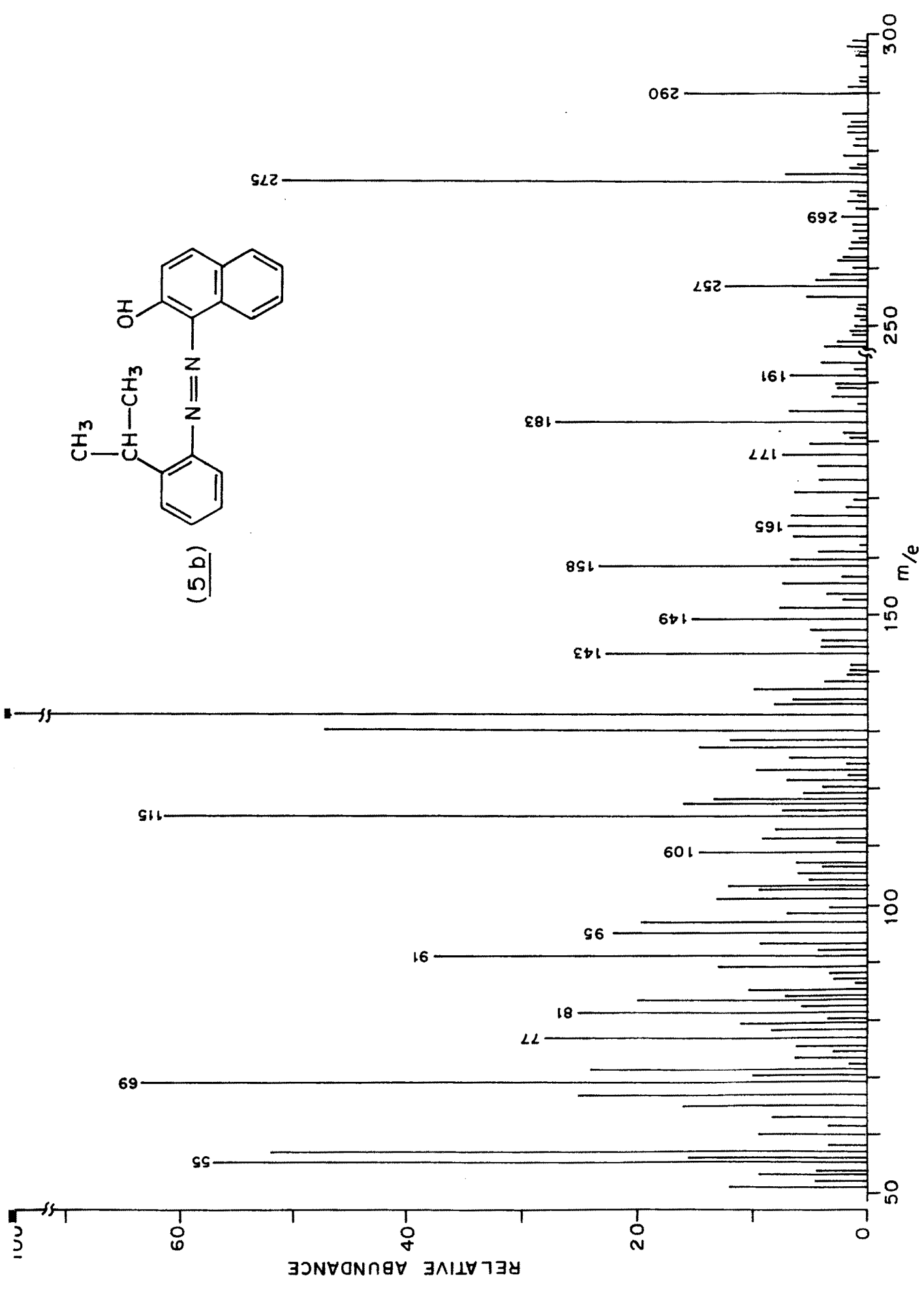


FIGURE 12

UV-Vis:  $\text{CHCl}_3$   $\lambda_{3\text{max}}$  420 nm (log  $\epsilon$  3.728), 395 nm (log 4.149).

Mass:  $M^+$  254

IR and  $^1\text{H-NMR}$  showed similar pattern.

#### Synthesis of commercial solvent dyes (5a), (6a) and (7a)

The commercial solvent dyes, solvent orange 2 (5a), solvent red 2 (6a) and solvent yellow 12 (7a) were prepared by following the general method using o-toluidine as diazo component. All the dyes were purified by crystallization.

Dye	Melting points obtained	Melting points reported <sup>3</sup>
(5a)	131°C	131°C
(6a)	144°C	144-46°C
(7a)	96.5°C	97°C

All these commercial solvent dyes (5a), (6a) and (7a) were taken for comparison of solubility study.

#### Synthesis of 4-o-cumylazo-o-cumidine (IIc)

Ortho-cumidine (13.5 g, 0.1 mole) was dissolved in 20 ml water and concentrated hydrochloric acid (6 ml, 0.05 mole) and cooled to 0 to 5°C. Sodium nitrite (3.45 g, 0.05 mole) dissolved in 2 ml of water, was added dropwise with stirring at 0-5°C in 3 to 4 hrs. Sodium chloride (5 g) was added in the diazo solution by lots, when a yellow precipitate separated out. It was filtered and suck dried. Crude yellow compound was suspended in 20 ml of water to which 1 ml of conc. hydrochloric acid has been added. The solution was stirred for 40-50 hrs. Then it was heated to 40-45°C for 4-5 hrs. Brownish red solid which separates out was filtered and dried. It was crystallized from petroleum ether as reddish yellow crystals (16.86 g; 60%) m.p. 111 to 112°C.

The crystallized compound (2 g) was again purified by column chromatography on silica gel using petroleum ether and benzene as eluent as reddish yellow crystals (1.6 g, 80%).

**Reddish yellow dye (IIc):**

Crystallised from petroleum ether and benzene (60:40),  
m.p. 111-112°C.

(Found: C, 76.67; H, 8.02; N, 14.88;  $C_{18}H_{23}N_3$  requires: C, 76.87; H, 8.19; N, 14.93%).

UV-Vis:  $\lambda_{max}^{CHCl_3}$  375 nm (log  $\epsilon$  4.681).

IR(Nujol): 31-3240 ( $NH_2$ ), 1650, 1620, 1580, 1510, 1470, 1430, 1390, 1305, 1290, 1240, 1190, 1150, 1100, 850, 780 (Figure 13).

$^1H$ -NMR ( $CDCl_3$ ):

- 1.25 (3H, s,  $-CH_3$  group of the 1st benzene ring)
- 1.25 (3H, s,  $-CH_3$  group of the same benzene ring)
- 1.32 (3H, s,  $-CH_3$  group at the 2nd benzene ring)
- 1.32 (3H,s, $-CH_3$  group at the 2nd benzene ring)
- 2.8-3.2 (1H, m, proton of the  $-CH$  group attached to the two  $-CH_3$  groups in the 1st benzene ring).
- 3.8-4.2 (1H, m, protons of the  $-CH$  group attached to the two  $-CH_3$  groups in the 2nd benzene ring).
- 4 ( $NH_2$  group, exchangeable with  $D_2O$ ) (Figure 14).
- 6.8-8 (7H, m, aromatic protons).

Mass:  $M^+$  281,

Fragments at 266 (61%), 224 (20%), 149 (78%),133 (100%), 125(22%), 119 (37%), 106 (52%), 91 (33%), 77(9%) (Figure 15).

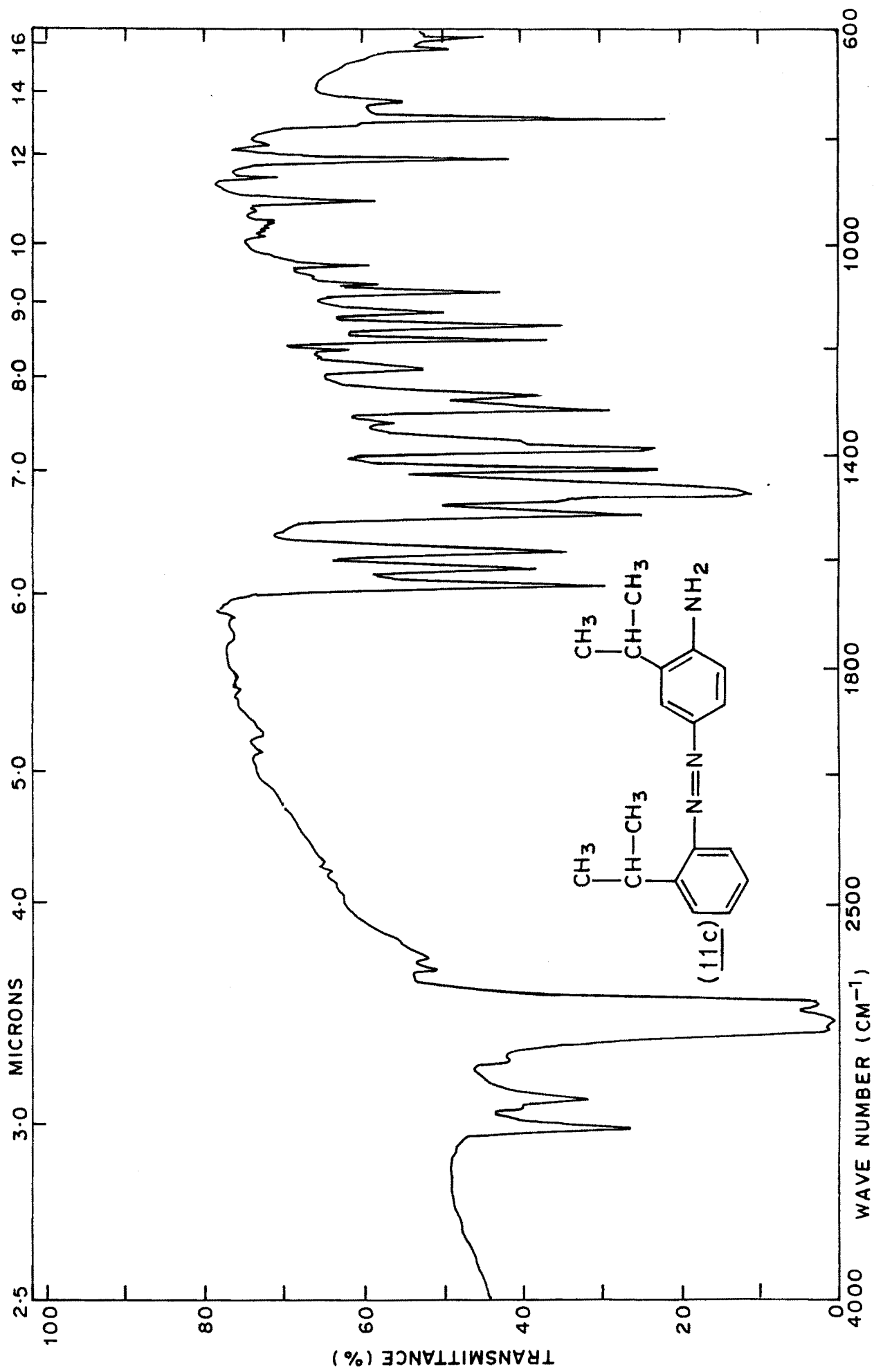


FIGURE 13

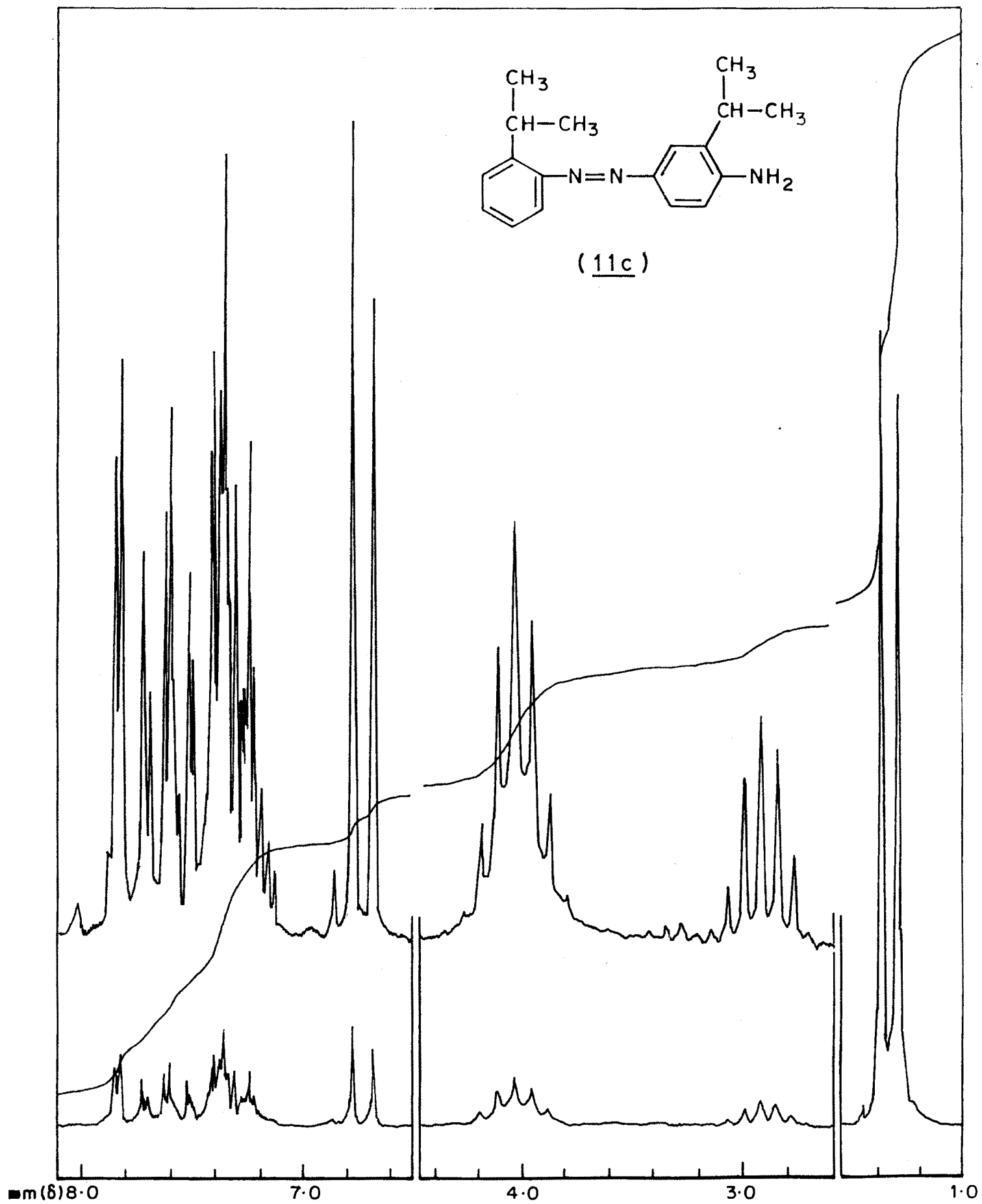


FIGURE 14



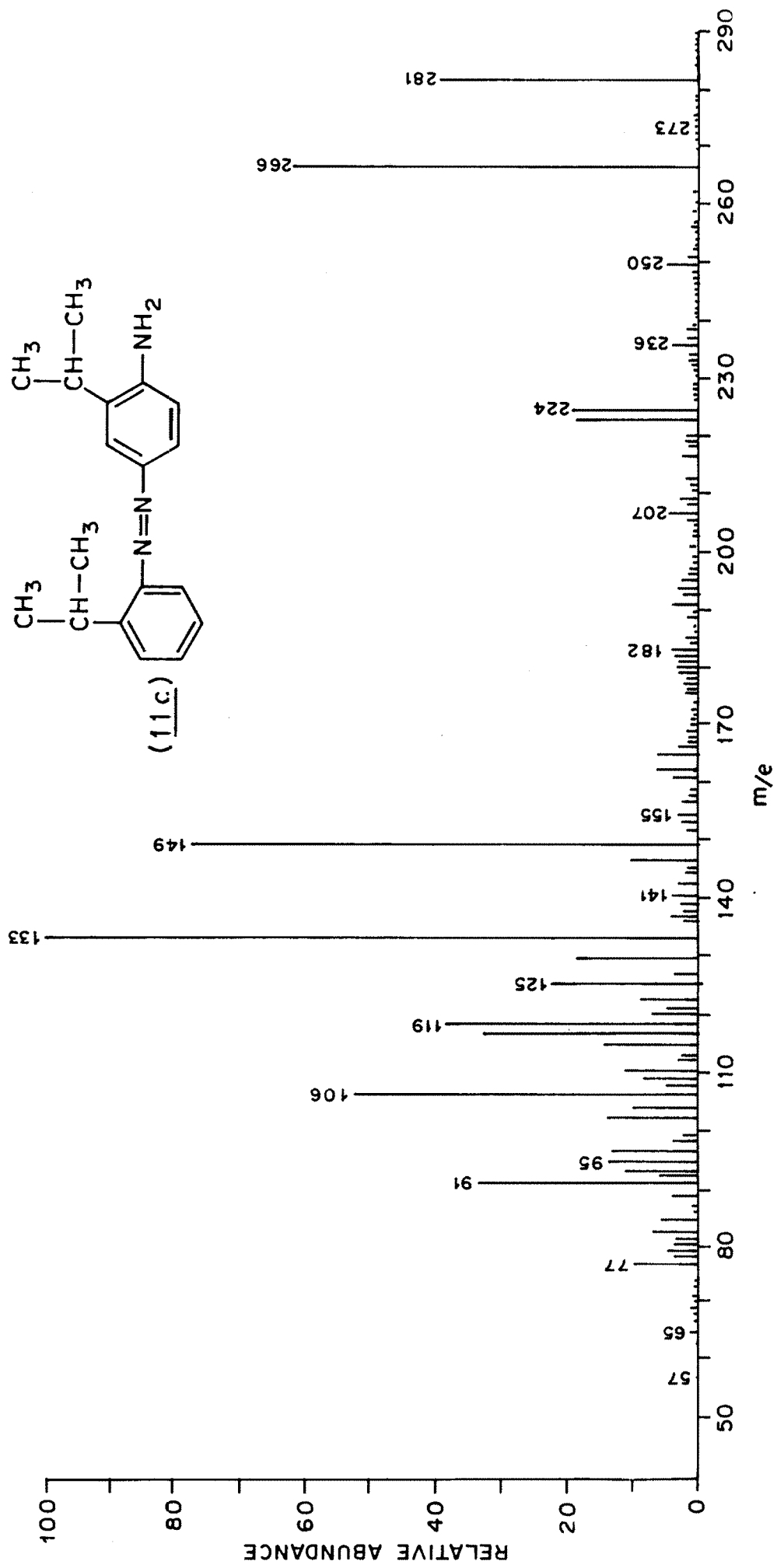


FIGURE 15

### Synthesis of commercial dye, solvent yellow 2 (IIa)

This commercial dye, solvent yellow 2, aminoazobenzene (IIa) was synthesized by the process given in the literature<sup>18</sup>, m.p. obtained 124.5°C, m.p. reported<sup>18</sup> 125°C.

### Synthesis of commercial dye, solvent yellow 2, 4-o-tolylazo-o-toluidine (IIb)

The dye (IIb) was prepared by the process given in the literature (Colour Index)<sup>3</sup> m.p. obtained 100°C, m.p. reported<sup>3</sup> 100°C. These dyes (IIa) and (IIb) were taken for solubility study to compare the new dye (IIc).

### General procedure for the synthesis of disazo dyes

#### Synthesis of 4-o-cumylazo-o-cumidine $\rightarrow$ 2-naphthol (IIb)

4-Ortho-cumylazo-o-cumidine (IIc) (2.81 g, 0.01 mole) was dissolved in a mixture of acetic acid (70 g), water (30 ml) and conc. hydrochloric acid (20 ml). The solution was cooled to 0-5°C. Sodium nitrite (0.79 g, 0.01 mole) dissolved in 20 ml water was added dropwise under stirring, maintaining the temperature between 0-5°C. After diazotization is over, excess nitrite was destroyed by adding sulfamic acid.

In another beaker, 2-naphthol (1.44 g, 0.01 mole) was dissolved in sodium hydroxide solution and cooled to 0-5°C. The diazo solution prepared above was added dropwise at 0-5°C under stirring maintaining the pH 7 to 7.5 by adding cold sodium hydroxide solution. Sodium acetate (5 g) was added in the mass. The violet red dye was filtered and washed with water. It was crystallised from petroleum ether and benzene mixture (60:40) in violet red crystals (3.59 g, 79.9%) m.p. 177-178°C.

The dye obtained (1 g) was purified by column chromatography on silica gel using benzene:petroleum ether (70:30) as eluent in violet red crystals (0.89 g; 80%) m.p. 178°C.

**Violet red dye (12b)**

Crystallized from benzene in red crystals m.p. 178°.

(Found: C, 77.12; H, 6.40; N, 12.71;  $C_{28}H_{28}N_4O$  requires: C, 77.06; H, 6.42; N, 12.84%).

UV-Vis ( $CHCl_3$ ):  $\lambda_{max}^{CHCl_3}$  355 nm ( $\log \epsilon$  4.169), 523 nm ( $\log \epsilon$  4.192).

IR (Nujol): 1620, 1440, 1360, 1310, 1280, 1260, 1240, 1200, 1150, 1060, 960, 940, 840, 750 (OH group is strongly chelated and is not observed in IR).

$^1H$ -NMR ( $CDCl_3$ ):

1.4 (3H, s,  $-CH_3$  group of the 1st benzene ring)

1.50 (3H, s,  $-CH_3$  gr. of the 1st benzene ring).

1.56 (3H, s,  $-CH_3$  gr. of the 2nd benzene ring).

1.62 (3H, s,  $-CH_3$  gr. of the 2nd benzene ring).

3.2 to 3.5 (1H, m, proton of the  $-CH$  gr. attached to the two  $-CH_3$  grs. in the 1st benzene ring).

3.8 to 4.8 (1H, m, proton of the  $-CH$  gr. attached to the two  $-CH_3$  groups in the 2nd benzene ring).

6.8 to 8.2 (13H, m, aromatic protons)

16.8 (1H, s, OH gr. of the naphthalene ring exchangeable to  $D_2O$ ) (Figure 16).

Mass:  $M^+$  436 (Figure 17).

**Synthesis of red dye, 4-o-cumylazo-o-cumidine  $\rightarrow$  phenol (13b)**

Similar method of diazotization and coupling was followed as described above in general procedure. Red crude dye was purified

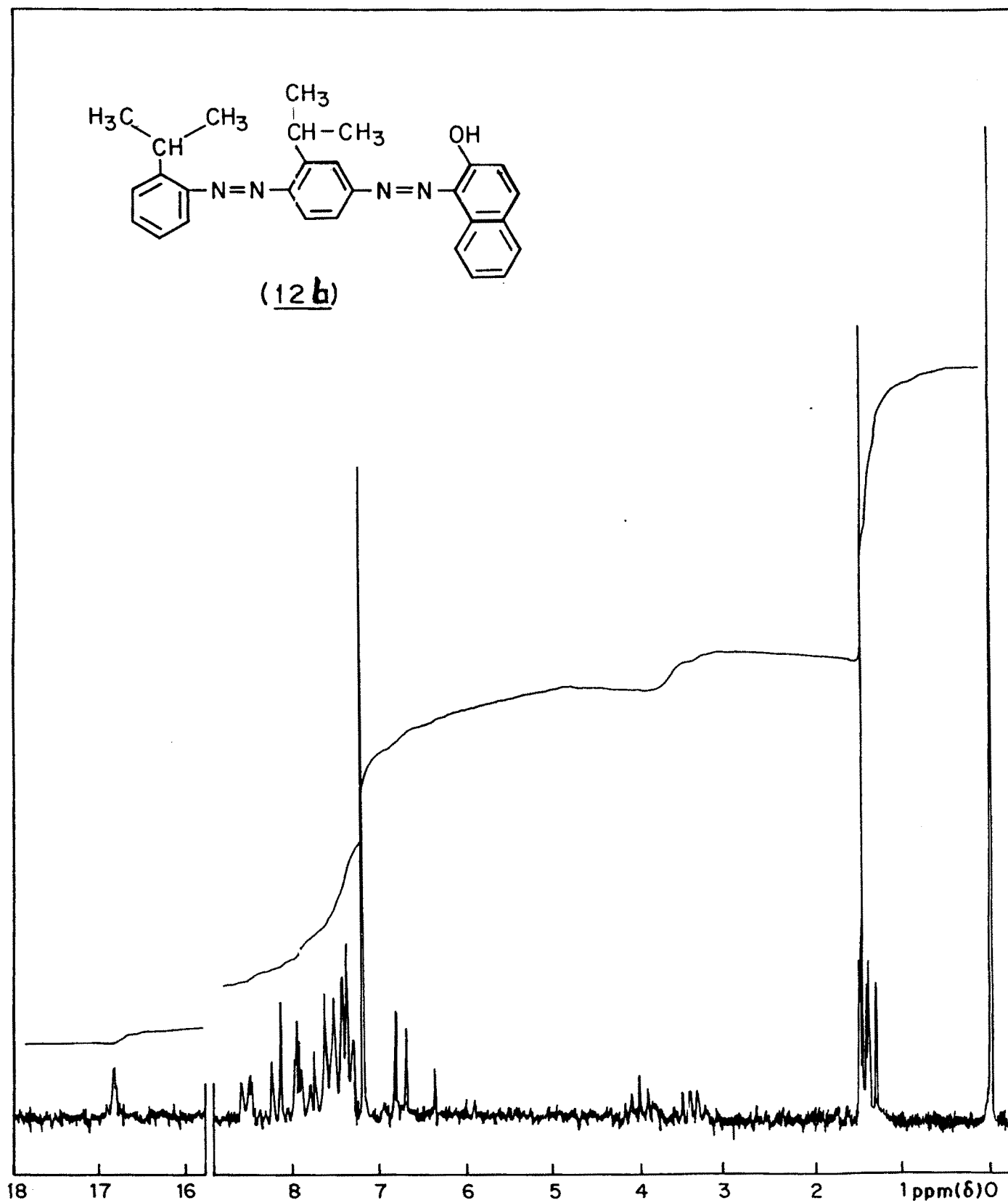
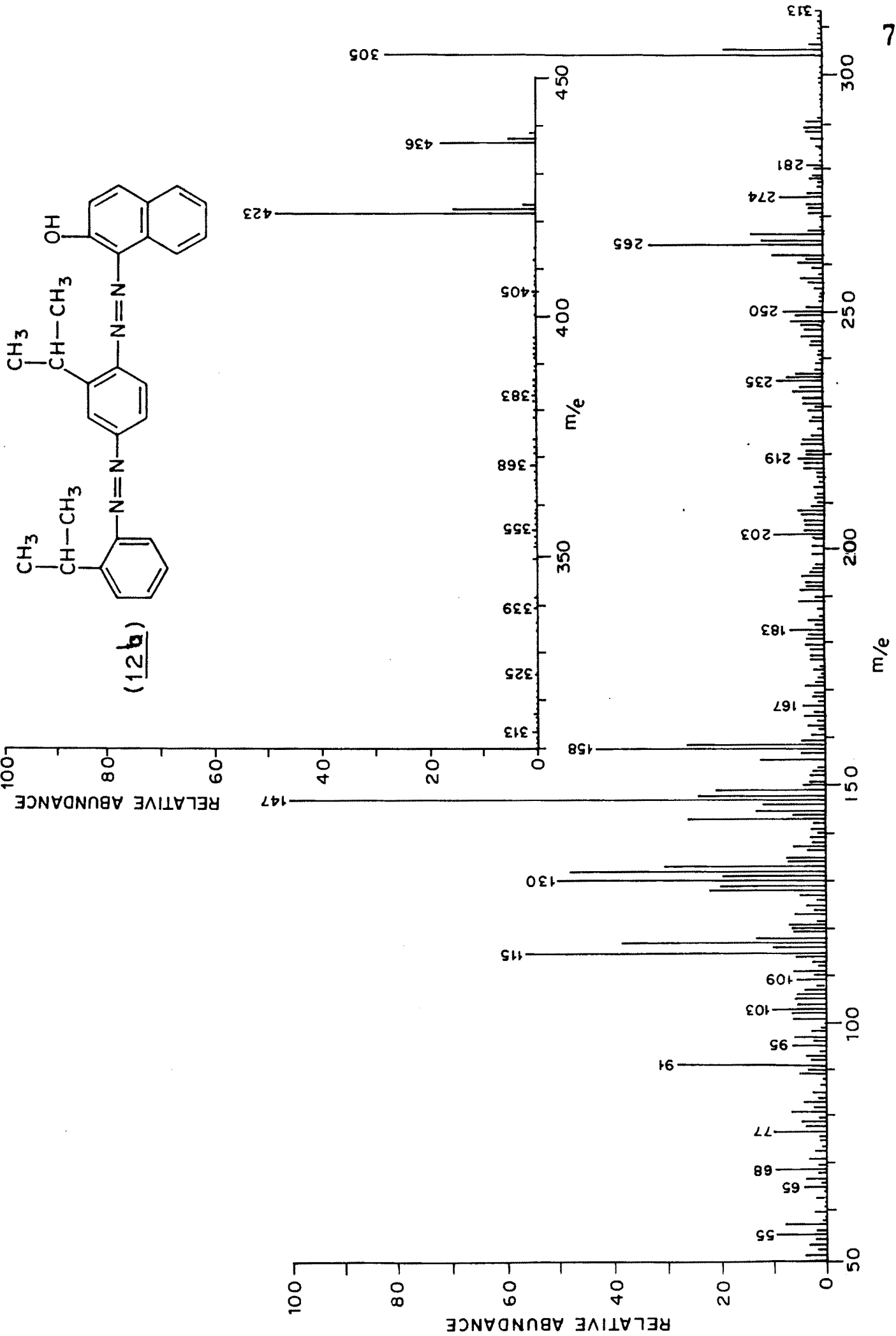


FIGURE 16

FIGURE 17



by column chromatography on silica gel using petroleum ether, benzene (60:40) as eluent. The dye was obtained as red crystals (2.5 g, 65%) m.p. 52-53°C.

IR (Nujol) and  $^1\text{H-NMR}$  ( $\text{CDCl}_3$ ) showed similar pattern described above.

(Found: C, 74.80; H, 6.6; N, 14.58;  $\text{C}_{24}\text{H}_{26}\text{H}_4\text{O}$  requires: C, 74.61; H, 6.74; N, 14.51%).

Mass:  $\text{M}^+$  386

#### Synthesis of disazo dyes (15a-15d)

The disazo dyes (15a to 15d) were prepared by the general procedure described above. Here, the series of different naphthols such as, naphthol-AS, naphthol ASD, naphthol ASE, naphthol ASTR were used as coupling components and p-cumylazo-o-cumidine as diazo component.

#### Disazo dye, 4-o-cumylazo-o-cumidine $\rightarrow$ 3-hydroxy-2-naphthanilide (15a)

The dye was purified by column chromatography on silica gel using benzene as eluent. It was crystallized from benzene in red crystals (4.5 g, 81%), M.P. 201°.

(Found: C, 75.71; H, 5.82; N, 12.40;  $\text{C}_{35}\text{H}_{33}\text{N}_5\text{O}_2$  requires: C, 75.68; H, 5.95; N, 12.61%).

UV-Vis:  $\lambda_{\text{max}}^{\text{CHCl}_3}$  542 nm (log  $\epsilon$  4.5540)

IR (Nujol): 1680 (C=O), 1600, 1540, 1480, 1445, 1370, 1340, 1300, 1260, 1200, 1160, 1080, 1040, 1020, 980, 960, 900, 850, 750.

$^1\text{H-NMR}$  ( $\text{CDCl}_3$ ):

1.41 (3H, s,  $-\text{CH}_3$  gr. of the 1st benzene ring).

- 1.48 (3H,s, -CH<sub>3</sub> gr. of the 1st benzene ring)  
 1.55 (3H,s, -CH<sub>3</sub> gr. of the 2nd benzene ring).  
 1.62 (3H, s, -CH<sub>3</sub>gr. of the 2nd benzene ring).  
 3.6 to 3.8 (1H, m, proton of the CH gr. attached to the  
 two -CH<sub>3</sub> grs in the 1st benzene ring).  
 3.8 to 4.8 (1H,m, proton of the -CH gr. attached to the  
 two -CH<sub>3</sub> grs. in the 2nd benzene ring).  
 6.8 to 8.4 (17H, m,aromatic protons)  
 11.9 (1H,s, NH gr.attached to CO gr.)  
 15.9 (1H, s, OH gr. of the naphthalene ring).

Mass: M<sup>+</sup> 555

**Red dye, 4-o-cumylazo-o-cumidine → 3-hydroxy-2-naphtho-o-toluidine  
 (15b)**

The dye is purified by the same method described above and crystallized from benzene in red crystals (4 g, 70%) m.p.192-93°C. (Found:C, 75.8;H, 6.3; N,12.08;C<sub>36</sub>H<sub>35</sub>N<sub>5</sub>O<sub>2</sub> requires: C, 75.92; H, 6.15; N,12.30%).

UV-Vis:  $\lambda_{\text{max}}^{\text{CHCl}_3}$  539 nm (log  $\epsilon$  4.5440).

IR(Nujol)and <sup>1</sup>H-NMR (CDCl<sub>3</sub>) showed same pattern as described in (15a)

Mass: M<sup>+</sup> 569.

**Red dye, 4-o-cumylazo-o-cumidine → 3-hydroxy-4-chloro-2-naphtho-nilide  
 (15c)**

The dye is crystallized from benzene in red crystals (4.5 g, 76%) m.p. 230°C. (Found: C, 71.10; H, 5.53; N, 11.6; C<sub>35</sub>H<sub>32</sub>N<sub>5</sub>O<sub>2</sub>Cl requires: C, 71.25; H, 5.43; N, 11.88%).

UV-VIS:  $\lambda_{\text{max}}^{\text{CHCl}_3}$  540 nm (log  $\epsilon$  4.890)

IR (Nujol) and  $^1\text{H-NMR}$  ( $\text{CDCl}_3$ ) showed same pattern described in (15a).

Mass:  $\text{M}^+$  589

**Red dye, 4-o-cumylazo-o-cumidine  $\rightarrow$  3-hydroxy-4-chloro-2-methyl-2-naphthanilide (15d)**

The dye (15d) is crystallized from benzene in red crystals (4 g, 66%) m.p. 210°C.

(Found: C, 71.62; H, 5.42; N, 11.51;  $\text{C}_{36}\text{H}_{34}\text{N}_5\text{O}_2\text{Cl}$  requires: C, 71.54; H, 5.63; N, 11.59%).

UV-VIS:  $\lambda_{\text{max}}^{\text{CHCl}_3}$  540 nm (log  $\epsilon$  4.5607)

IR (Nujol) and NMR ( $\text{CDCl}_3$ ) showed same pattern as described in (15a).

Mass:  $\text{M}^+$  603.

**Synthesis of o-cumidine  $\rightarrow$  3-methyl-5-pyrazolone dyes**

**The dye (16a), (16b)**

Dyes (16a), (16b) were prepared by the general procedure described for mono azo dyes except that o-toluidine and o-cumidine were used as diazo component respectively.

**Yellow dye (16b)**

Crystallized from benzene in yellow powder m.p. 182-84°C.  
(Found: C, 63.81; H, 6.61; N, 22.81;  $\text{C}_{13}\text{H}_{16}\text{N}_4\text{O}$  requires: C, 63.93; H, 6.55; N, 22.95%.)

UV-VIS:  $\lambda_{\text{max}}^{\text{CHCl}_3}$  443nm (log  $\epsilon$  4.5340)

IR(Nujol): 3250, 1670, 1550, 1440, 1345, 1360, 1280, 1240, 1060, 960, 870.



$^1\text{H-NMR}$  ( $\text{CDCl}_3$ ):

1.25 (3H, s,  $-\text{CH}_3$  gr. on benzene ring at  $\text{C}_1$ )

1.37 (3H, s,  $-\text{CH}_3$  gr. on the benzene ring at  $\text{C}_1$ )

2.3 (3H, s,  $\text{CH}_3$  gr. on the pyrazolone ring at  $\text{C}_3$ )

3 - 3.75 (1H, m, CH gr. on benzene ring attached to two methyl grs.)

7.70 - 7.9 (4H, m, aromatic protons)

9.02 (1H, s, NH gr. on the pyrazolone ring at  $\text{C}_4$ ) (Figure 18).

Mass:  $\text{M}^+$  244

229(35%), 216(14%), 201(12%), 133(100%), 118(68%), 106(14%),  
91(32%), 77(13%) (Figure 19).

#### Synthesis of yellow dye (16a)

The yellow dye (16a) was prepared by the same process described in general procedure for monoazo dyes using *o*-toluidine as diazo compound and *3*-methyl-5-pyrazolone as coupling component. Crystallized from benzene, m.p.  $232^\circ\text{C}$ .

(Found: C, 60.40; H, 6.01; N, 25.62;  $\text{C}_{11}\text{H}_{13}\text{N}_4\text{O}$  requires: C, 60.83; H, 5.99; N, 25.81%).

IR, NMR showed same pattern as for the other dyes (Figure 20)

Mass:  $\text{M}^+$  217.

#### Synthesis of *4-o-cumylazo-o-cumidine* (*3*-methyl-5-pyrazolone) (17c)

The yellow dye (16c) was also synthesized with the procedure described in the general procedure for disazo dyes using *4-o-cumylazo-o-cumidine* as diazo component and *3*-methyl-5-pyrazolone as coupling component.

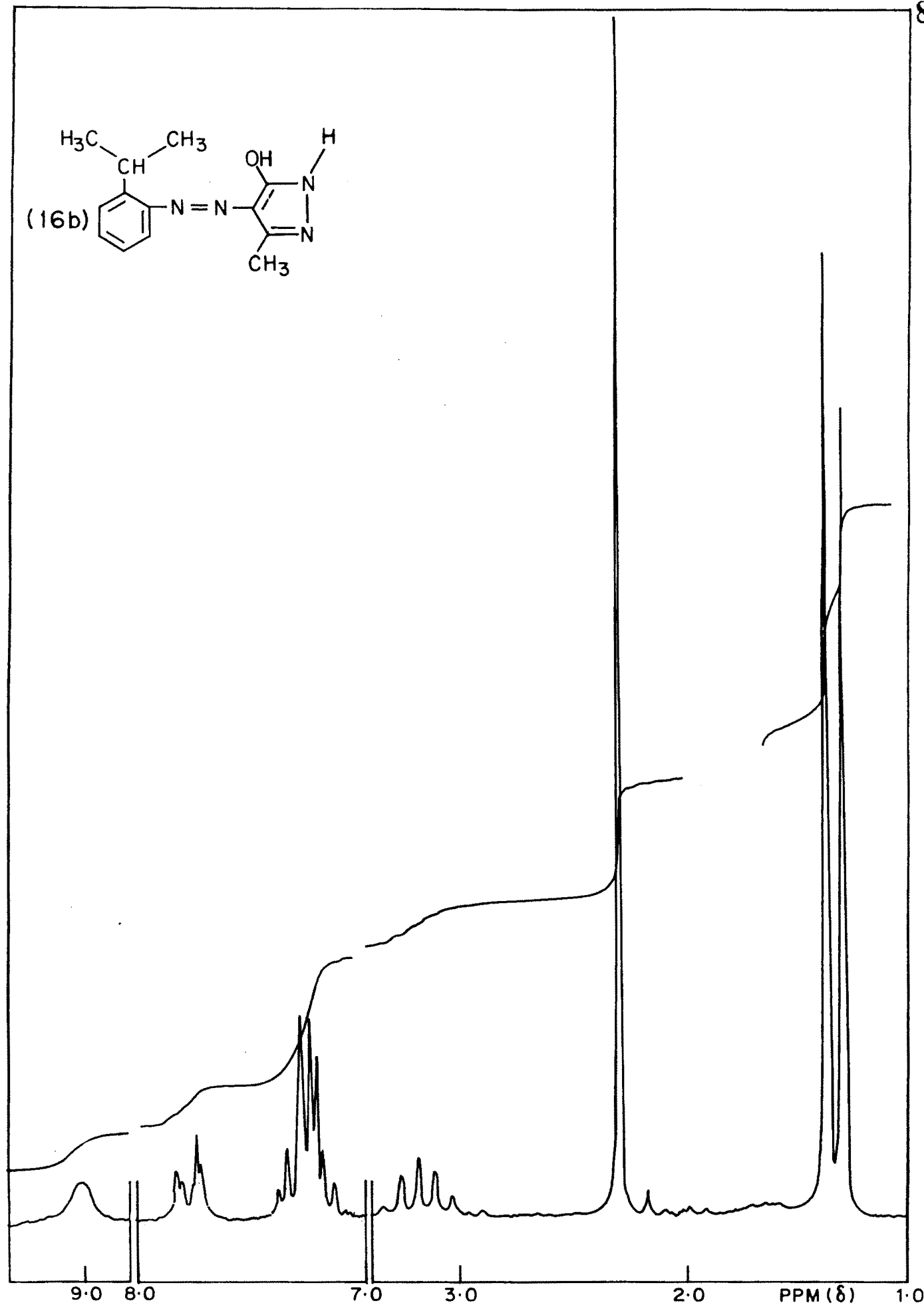
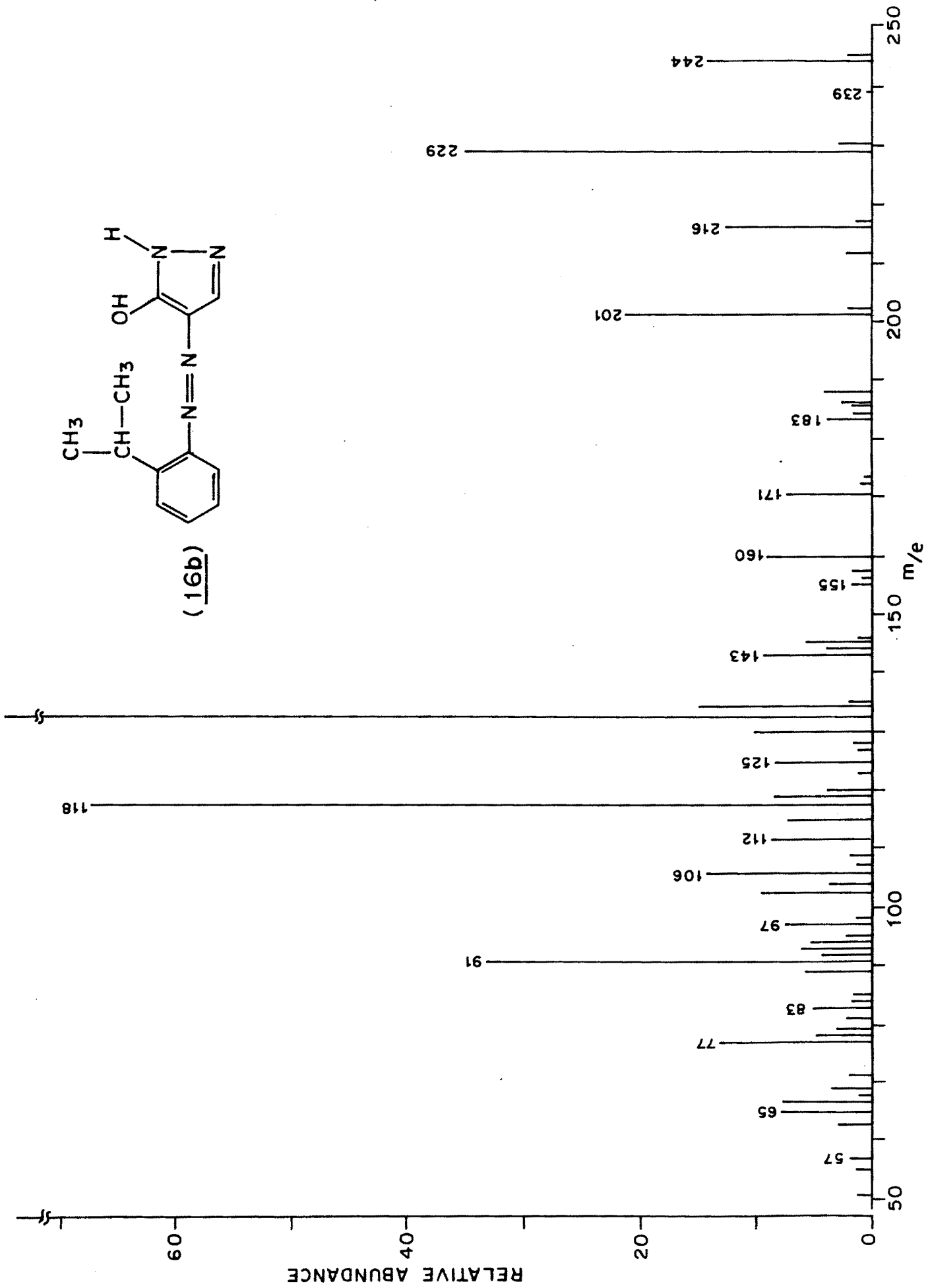
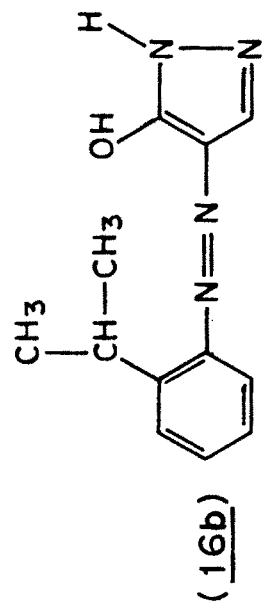


FIGURE 18

FIGURE 19



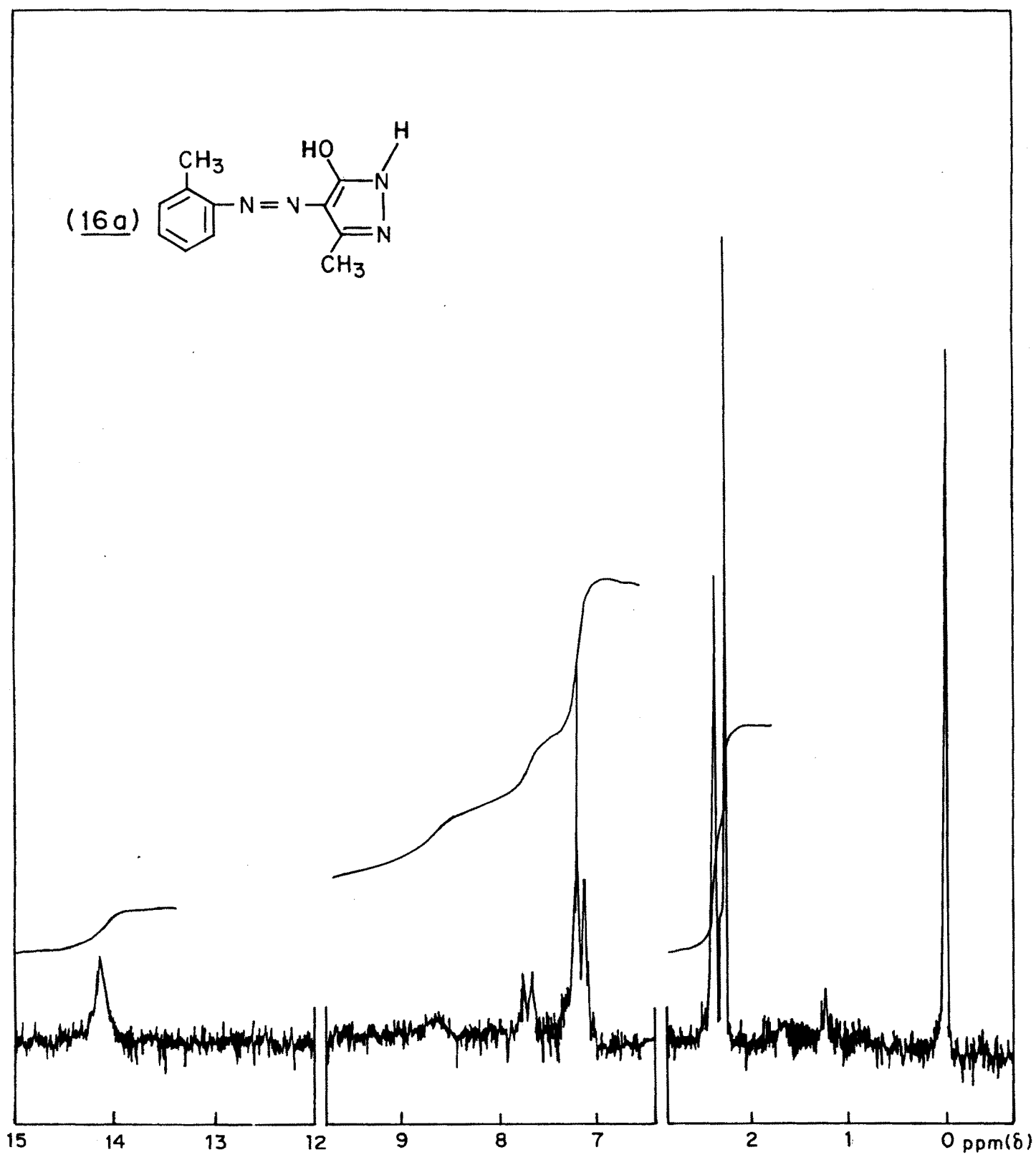


FIGURE 20

Crystallized from benzene, yielded a yellow powder m.p.190°C.  
 (Found: C, 67.48; H, 6.68; N, 21.41;  $C_{22}H_{26}N_6O$  requires: C, 67.69;  
 H, 6.67; N, 21.54%).

UV-VIS:  $\lambda_{\text{max}}^{CHCl_3}$  440 nm (log  $\epsilon$  4.6998)

IR (Nujol): 3150 ( $NH_2$ ), 1670 (C=O), 1550, 1440, 1360, 1310, 1280, 1240,  
 1430, 1180, 1170, 1050, 960, 900.

$^1H$ -NMR:

- 1.42 (3H, s,  $-CH_3$  gr. of the 1st benzene ring).
- 1.50 (3H, s,  $-CH_3$  gr. of the 1st benzene ring)
- 1.56 (3H, s,  $-CH_3$  gr. of the 2nd benzene ring).
- 1.62 (3H, s,  $-CH_3$  gr. of the 2nd benzene ring).
- 2.3 (3H, s,  $CH_3$  gr. on pyrazolone ring.
- 3.2 to 3.56 (1H, m, proton of the CH gr. attached to the  
 two  $CH_3$  grs. in 1st benzene ring).
- 3.8 to 4.8 (1H, m, proton of the CH gr. attached to two  
 $-CH_3$  grs. in the 2nd benzene ring.
- 7.60 to 7.9 (7H, m, aromatic protons).
- 9.02 (1H, s, OH gr. on the pyrazolone ring)

Mass:  $M^+$  390

375(100%), 258(61%), 147(70%), 132(70%), 117(53%), 91(31%)

Figure 21.

**Synthesis of yellow dye (17b), 4-o-tolylazo-o-toluidine  $\rightarrow$  3-methyl-5-pyrazolone**

Crystallized from benzene to yield a yellow powder m.p. 260°C.  
 (Found: C, 64.41; H, 5.12; N, 25.3;  $C_{18}H_{18}N_6O$  requires: C, 64.67;

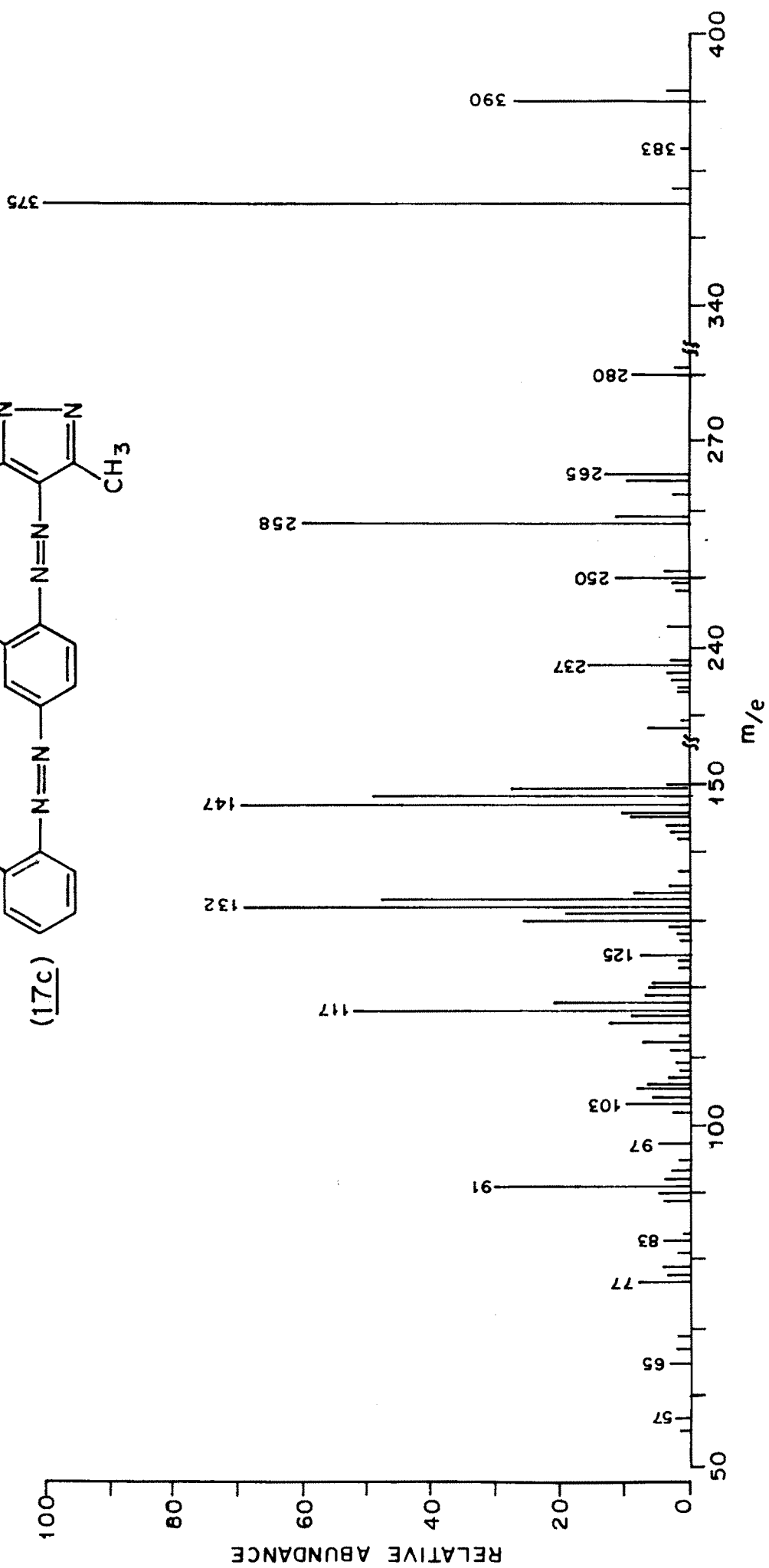
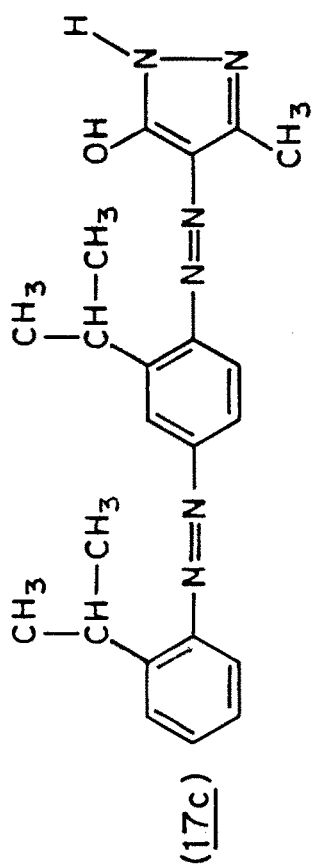


FIGURE 21

H, 5.39; N, 25.15%).

UV-VIS:  $\lambda_{\text{max}}^{\text{CHCl}_3}$  450 nm (log  $\epsilon$  4.6924)

IR (Nujol) and  $^1\text{H-NMR}$  ( $\text{CDCl}_3$ ) showed same pattern as described in compound (17c).

Mass:  $\text{M}^+$  334.

### Synthesis of 5-nitro-o-cumidine (18)

Ortho-cumidine (13.5 g, 0.1 mole, conc. sulphuric acid (150 g) were taken in three-necked flask and cooled to 0 to  $-3^\circ\text{C}$ .

In another beaker a mixture of conc.  $\text{HNO}_3$  (6.3 g, 99.8%), conc. sulphuric acid (30 g) and water (56 ml) was prepared by cooling. This mixed acid was added to the above three-necked flask with stirring in 3 hrs. The mass becomes semisolid at the end. The reaction was kept under stirring for further 2-3 hrs to complete the nitration. Solid paste was filtered and suck dried. The brownish white solid was taken in water and neutralised with sodium carbonate to obtain the free base. The free base was distilled under vacuum at  $156-158^\circ/5-8$  mm to yield 18 (15 g, 83%). 2 g of above liquid was purified by column chromatography on silica gel for spectral analysis (1.8 g).

IR (Nujol): 3490, 3400, 3200, 3090, 2980, 1630, 1500, 1420, 1320, 1300, 1200, 1100, 1070, 9a50, 870, 810, 740 (Figure 22).

$^1\text{H-NMR}$  ( $\text{CDCl}_3$ ):

1.1 (3H, s,  $-\text{CH}_3$  gr. on the benzene ring).

1.2 (3H, s,  $\text{CH}_3$  gr. on the benzene ring)

2.5 - 2.9 (1H, m, CH gr. on the  $\text{C}_1$  of benzene ring).

3.9 - 4.1 (2H, s,  $\text{NH}_2$  group on the benzene ring).

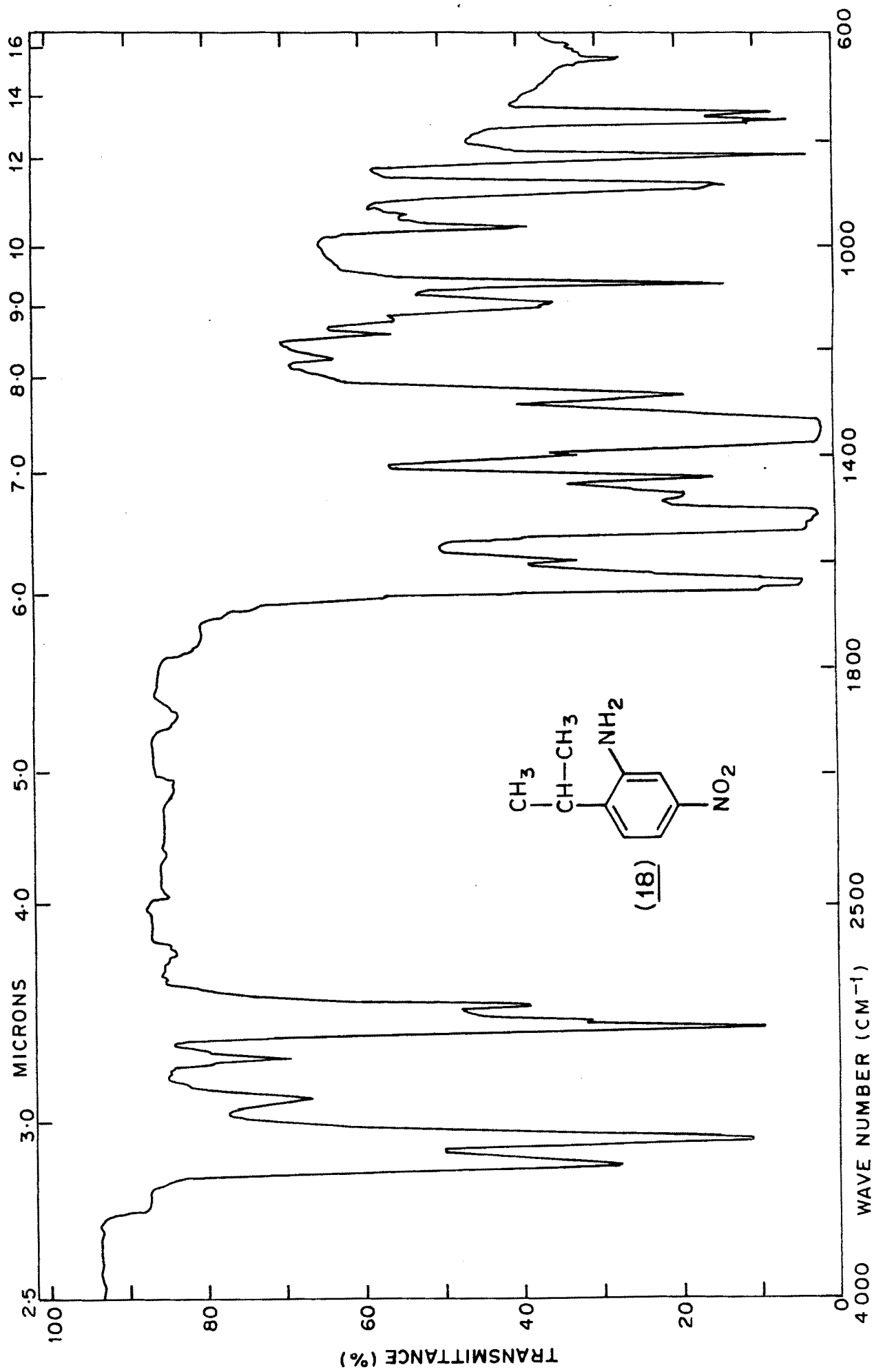


FIGURE 22



6.8 - 7.3 (3H, m, aromatic protons) (Figure 23).

Mass:  $M^+$  180

165(70%), 119(100%), 107(60%), 91(45%), 77(19%) (Figure 24).

**General procedure for the synthesis of pigments from 5-nitro-o-cumidine and naphthols (19a to 19e) and (21b)**

**Synthesis of 5-nitro-o-cumidine- $\rightarrow$ 2-naphthol (19a)**

5-nitro-o-cumidine (18) (1.8 g, 0.01 mole) was dissolved in a mixture of conc. hydrochloric acid (10 ml) and water (30 ml). The solution was cooled to 0-5°C. Sodium nitrite (0.69 g, 0.01 mole) dissolved in 20 ml water was added dropwise with stirring at 0-5°C. After diazotization was complete excess sodium nitrite was destroyed by sulfamic acid. In another beaker 2-naphthol (1.44 g, .01 mole) was dissolved in sodium hydroxide solution and cooled to 0-5°C. The above chilled diazo solution was added dropwise with stirring to the naphtholic solution. The pH was adjusted upto 7 to 7.5 by adding sodium acetate. The red coloured precipitate was filtered and washed with water. Crude red pigment was purified by column chromatography on silica gel by using petroleum-ether benzene mixture (80:20) as eluent. Further crystallisation from the same solvent yielded the pigment as red crystals (2.5 g, 70%), m.p.214°C. Similarly pigments (19b), (19c), (19d), (19e) were synthesized taking corresponding naphthols.

**Red pigment (19a)**

Crystallized from petroleum-ether and benzene mixture (80:20), m.p. 214°C.

Found:C, 67.2; H, 5.2; N,12.50;  $C_{19}H_{17}N_3O_3$  requires: C, 68.06;

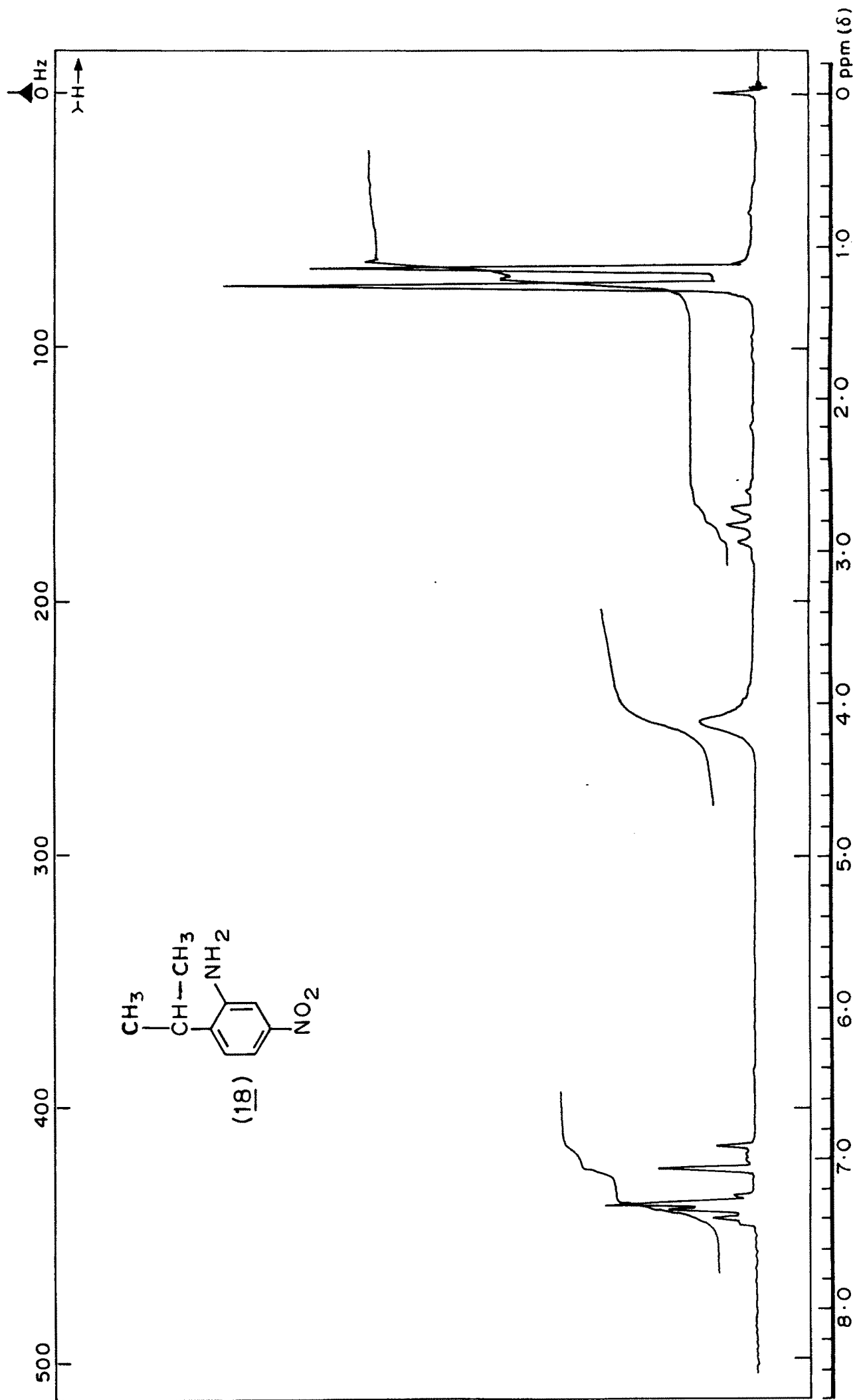


FIGURE 23

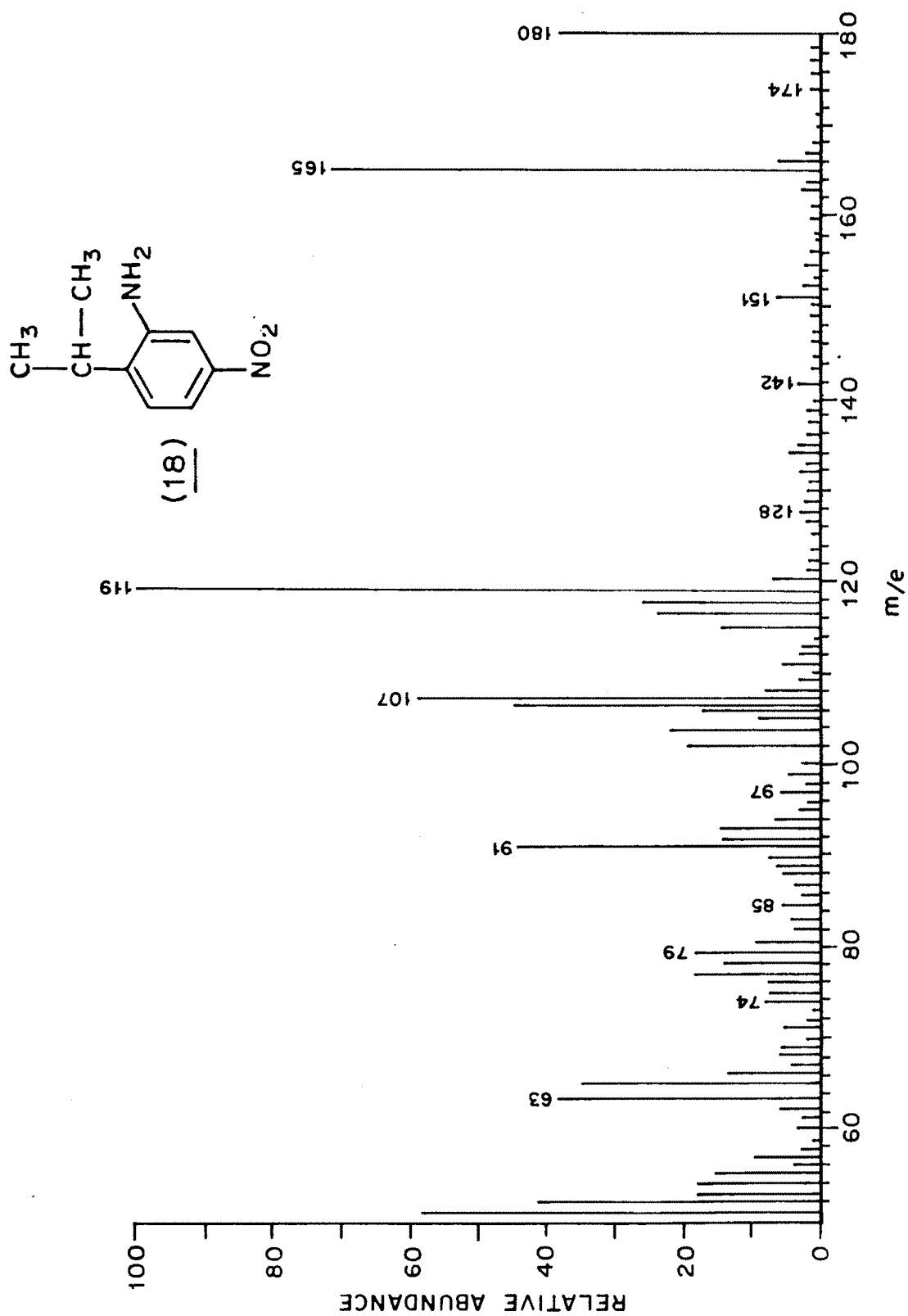


FIGURE 24

H, 5.07; N, 12.56%.

UV-VIS:  $\lambda_{\text{max}}^{\text{CHCl}_3}$  480 nm (log  $\epsilon$  4.3208).

IR (Nujol): 1530, 1490, 1390, 1370, 1280, 1250, 1210, 1160, 1140, 1130, 1060, 1040, 900, 850, 750. OH is chelated, hence not observed in IR.

$^1\text{H-NMR}$  ( $\text{CDCl}_3$ ):

1.2 (3H, s,  $-\text{CH}_3$  gr. on the benzene ring).

1.45 (3H, s,  $-\text{CH}_3$  gr. on the benzene ring).

3.3-3.6 (1H, m, CH group attached to two  $-\text{CH}_3$  grs. on the benzene ring).

6.7-8.5 (8H, m, aromatic protons) (Figure 25).

Mass:  $M^+$  335.

**Pigment 5-nitro-o-cumidine  $\rightarrow$  3-hydroxy 2-naphthanilide (19b)**

Crystallized from petroleum-ether:benzene (10:90) as red crystals, m.p. 205°C.

(Found: C, 68.51; H, 4.70; N, 12.68;  $\text{C}_{26}\text{H}_{22}\text{N}_4\text{O}_4$  requires: C, 68.72; H, 4.85; N, 12.83%).

UV-VIS:  $\lambda_{\text{max}}^{\text{CHCl}_3}$  3410 nm (log  $\epsilon$  2.9132); 498 nm (log  $\epsilon$  3.2909); 515

nm (log  $\epsilon$  3.29092).

Mass:  $M^+$  454.

**Pigment 5-nitro-o-cumidine  $\rightarrow$  3-hydroxy 2-naphtho-o-toluidine (19c)**

Crystallized from petroleum ether-benzene (10:90) as red crystals m.p. 213°C.

(Found: C, 69.01; H, 5.21; N, 12.1;  $\text{C}_{27}\text{H}_{24}\text{N}_4\text{O}_4$  requires: C, 69.23; H, 5.13; N, 12.00%).

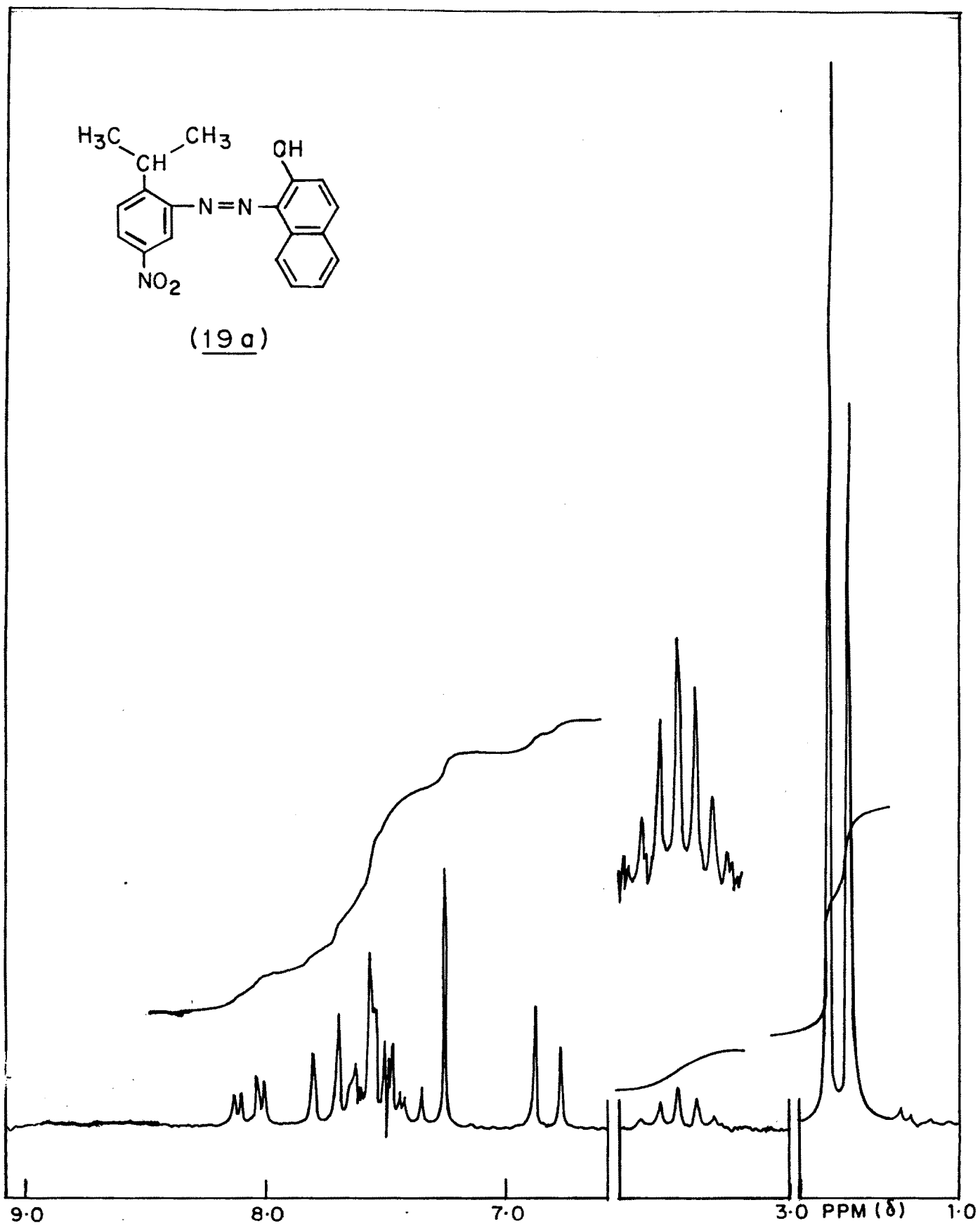


FIGURE 25

UV-VIS:  $\lambda_{\text{max}}^{\text{CHCl}_3}$  415 nm (log  $\epsilon$  4.0929), 495 nm (log  $\epsilon$  4.466); 520 nm (log  $\epsilon$  4.458).

Mass:  $M^+$  468.

**Pigment** 5-nitro-o-cumidine  $\rightarrow$  3-hydroxy-4-chloro-2-naphthanilide

Crystallized from petroleum-ether benzene mixture (10:90) in red crystals, 214-15°C.

(Found: C, 63.71; H, 4.41; N, 11.31;  $C_{26}H_{21}N_4O_4Cl$  requires: C, 63.88; H, 4.30; N, 11.46%).

UV-VIS:  $\lambda_{\text{max}}^{\text{CHCl}_3}$  410 nm (log  $\epsilon$  3.7576), 490 (log  $\epsilon$  3.7308), 520 nm (log  $\epsilon$  3.6599).

Mass:  $M^+$  488.

5-nitro-o-cumidine  $\rightarrow$  3-hydroxy-3-nitro-2-naphthanilide (19e)

Crystallized from petroleum-ether:benzene mixture (10:90) in red crystals, m.p. 240-42°C.

(Found: C, 62.61; H, 4.11; N, 14.02;  $C_{26}H_{21}N_5O_6$  requires: C, 62.53; H, 4.21; N, 14.03%).

UV-VIS:  $\lambda_{\text{max}}^{\text{CHCl}_3}$  415 nm (log  $\epsilon$  3.8103), 495 nm (log  $\epsilon$  4.0577); 520 nm (log  $\epsilon$  4.52948).

Mass:  $M^+$  499.

#### Synthesis of pigments (20a) and (20b)

The pigments (21a) and (21b) were prepared by the general procedure described above by taking 5-nitro-o-cumidine as diazo component and 3-methyl-5-pyrazolone as coupling component. Compounds (19a to 19e) showed same pattern of NMR and IR.

**Pigment ~~5-nitro-o-tolidine~~ → 3-methyl-5-pyrazolone (21a)**

Crystallized from benzene in yellow crystals, m.p. 299

(Found: C, 50.28; H, 4.20; N, 26.68;  $C_{11}H_{11}N_5O_3$  requires: C, 50.57; H, 4.21; N, 26.82%).

Mass:  $M^+$  261.

**Pigment 5-nitro-o-cumidine → 3-methyl-5-pyrazolone (21b)**

Crystallized from benzene in yellow crystals, m.p. 232-33°C.

(Found: C, 53.89; H, 5.11; N, 24.20;  $C_{13}H_{15}N_5O_3$  requires: C, 53.98; H, 5.19; N, 24.22%).

UV-VIS:  $\lambda_{\max}^{CHCl_3}$  (Table 16)

Mass:  $M^+$  289

Compounds (21a) and (21b) showed same pattern of NMR and IR.

**Dyeing Method (General Procedure)**

The dye baths containing naphthol solution and diazo solution so as to obtain 1% shade on the cotton hanks were prepared according to following recipe.

**Naphthol ASG**

Naphthol ASG .....1 g (pasted with TRO)

Sodium hydroxide solution (70%) .. 1.5 g

Water ... .. 20ml

mixed together and volume was made to 500 ml by adding water.

Glauber salt (7.5 g) was added to above solution.

**Diazo solution**

Fast base .. .. 1 g

conc. hydrochloric acid .. .. 2 ml

Boiling water .. .. 100 ml

were mixed together and cooled to 0-5°C by adding ice. Sodium nitrite (10%, w/v, 5 ml) was added by vigorous stirring. After 0.5 hrs the solution was neutralized with 10 cc of 10% sodium acetate. After addition of 0.5 to 1 ml of HAc and 10% glauber salt, the solution is made upto 500 ml by adding water.

### **Dyeing**

The hank is entered into the bath containing the naphthol solution and naphthalated for 30 min. The hank is then squeezed and then azoic dye is developed on the hank by dipping it into the dye bath containing the diazo solution for 15 min. with constant shaking. The hank is then taken out washed and rinsed with cold water. The dyed hank is soaped at boiling for 10-15 min. with a soap solution containing 20 g/l of soap and 20 g/l of soda ash to remove the surplus dye and dried.

### **Method for evaluation of solubilities**

About 1.5 g to 2.5 g of the dye accurately weighed was dissolved in 10 ml of the solvent. The mixture was stirred for 30 min. by using magnetic stirrer. The undissolved dye from the saturated solution at 30°C was filtered through previously weighed sintered glass funnel. The undissolved dye was weighed. Solubility of the dye was then calculated from the amount of the dye dissolved and expressed as gms/100 g of solvent.



## REFERENCES

1. J.W. Haun and K.A. Kobe  
Ind. Eng.Chem., **43**, 2355 (1951).
2. Chi-Kang Dien  
The Chemistry of Synthetic Dyes edited by K. Venkataraman  
(Academic Press Inc.),Vol.8, 81 (1978).
3. The Society of Dyes and Colourists  
American Association of Textile Chemists and Colourists  
Colour Index, 3rd Edn., 4(1971) and revised Edn. 7(1982).
4. J. Koerner  
Plast. Mod. Elastomers, **26**, 139 (1974).
5. S. Bonnie  
Plast. Technol. **3**, 633 (1957).
6. C.Musgrave  
Plastics (London), **31**, 1129 (1966).
7. H.K.Venkataramaiah  
Ph.D Thesis, Bombay University (1985).
8. G. Hanech and George  
J. Am.Chem.Soc., **73**,3080 (1951).
9. G. Vanon and A.Callier  
~~the~~ Bull.Soc.Chim. (4)41, 357 (1927).
10. E.D.Sterling and M.T. Bogert  
J. Org.Chem., **4**,20 (1939).
11. K.L. Nelson and H.C. Brown  
J. Am.Chem.Soc., **73**, 5605 (1951).
12. K.L.Nelson and H.C. Brown  
Chemistry of Petroleum Hydrocarbon, Reinhold Publishing  
Corp. (N.Y.),Vol.3, 465 (1955).
13. M. Kanhere and S.B. Chandalia  
(Dept. Chem.Technol.) Univ.of Bombay,  
Indian J. Technol.,**8**, 19, 319 (1981).
14. A.A. Kolpakchhi, E.P. Babin (USSR)  
Metody. Poluch. Khim.Reaktiv Prep. **22**, 112 (1970).
15. P.A.S.Smith and E.P. Anoniddes  
Tetrahedron **9**, 210 (1960).

- 15a Scheuzev, Karl (CIBA-Geigy A.G.),  
Ger. Offen.2,640,04g Mar.17 (1977);  
U.S. Patent 610,965, Sept.8 (1975).
16. The Society of Dyes and Colourists,  
American Association of Textile Chemists and Colourists  
Colour Index, 3rd edn.,Vol.3 (1971).
17. Chi-Kang Dien  
The Chemistry of Synthetic Dyes edited by  
K.Venkataraman (Academic Press Inc.) Vol.8, 126 (1978).
18. V.S. Furniss, A.J. Hannaford, V.Rogers, P.W.G.Smith and  
A.R.Tatchell  
Vogel's Textbook of Practical Organic Chemistry, p.720  
(1980).

---

CHAPTER II  
BIOLOGICALLY ACTIVE 4-THIAZOLIDINONES  
FROM SCHIFF BASES

---

---

---

SECTION - A

---

---

## INTRODUCTION

In order to ensure health to all after 2000 A.D. it is proposed that a new generation of drugs will aim at preventing and curing the diseases rather than treating the symptoms. Now a days biologists, chemists and computer scientists have joined together and formed a group for drug designing. Such drugs will be cloned from bodies own genes, hormones and enzymes and they will mimic nature to cure patient. Therefore, it is believed that the next century will see a new wave of vaccines to prevent number of diseases like cancer, malarial, typhoid, tuberculosis and hepatitis. Organic chemists will render their part by synthesizing these natural compounds in order to produce them in large quantities. This role along with the another approach to cure diseases by using the inhibitors of particular enzymes have been reported.

Recently, an antihypertensive drug Captopril has been introduced in the market as it was found to be an inhibitor of ACE (angiotensin converting enzyme). Similarly number of drug companies abroad have taken up drug designing in order to cure the diseases caused by these enzyme reactions.

If one looks at the history of drug development number of chemotherapeutics were in use since fifteenth century or even before. After second World War various schemes came into existence in the developed countries.

Earlier Alexander Flemming discovered penicillin which has been found to be extremely useful in saving the life of thousands of people. Similarly, an American team headed by Solman Walksman discovered streptomycin, finest antibiotic effective against antituberculosis in 1944.

Since then, various multinational companies have been doing worthwhile research in drug designing. Most of the organic compounds have chemotherapeutic activity due to the presence of specific structural unit. The different groups which are necessary for biological activity have been identified<sup>1</sup> and Table I is presented with data in order to find out the structure and activity relationship in number of drugs.

Now, it is established that tuberculosis can be cured in almost 100% reliability with an antibacterial Rifamycin, INH (Isonicotinic acid hydrazide), Viomycin, Pyrazinamide etc. According to the latest estimate available for whole world 2.5 million people are infected by tuberculosis each year and more than half of million die from it<sup>1a</sup>. In India, about 1.5 million i.e. nearly one half of the world tuberculosis patients are affected. A survey carried out in Greater Bombay in recent past indicated that about 5000 people die because of tuberculosis while about 30,000 are affected by disease every year. Therefore, a massive programme to eradicate tuberculosis from our country is necessary.

TABLE I  
Biological Activities Associated with Structural Units<sup>1</sup>

Chemical group	Type of structure	Name of the drug	Biological activity
Acetals	$R_2C(OCH_2CH_2)NR_2$	Paraldehyde Febrifungine Glyketal.	Antimalarial hypnotic
Acids	$RCOOH$	Propionic acid chautmogric acid	Fungistatic Mycobacteriostatic
	$RCHOHCOOH$	Mandelic acid	Bacteriostatic
	$HO-Ar-COOH$	Salicylic acid	Microbiostatic antipyretic
	$RCH(NH_2)COOH$	Amino acids	Nutritional Antimitotic
Alcohols	ROH where R is simple or complex	Benzyl alcohol Ethanol	Local anesthetics Sedative Anticonvulsant
		choline	Transmethylation
		5HTF Serotonin	CNS stimulant
Amides	$RCONH_2$	Acetophenetidine	Analgesic
	$RCONR_2$		
Amines	$Ar-CH(OH)CH_2NHR$	Phenethylamine Amphetamine	Pressor CNS stimulant
Amino-alcohols	$ArCHOH(CH_2)_n-NR_2$	Ephedrine	CNS stimulant
Esters	$ArCOO(CH_2)_n-NR_2$	Cocaine Scopolamine	CNS stimulant CNS depressant
Ethers	$R_2O$ $ArOR$	Morphine Diphenhydramine	Analgesic Sedative
Guanidine	$RNHC(=NH)-NHR'$	Chlorguanide Streptomycin	Antimalarial Antibacterial

TABLE I (Contd.)

Chemical group	Type of structure	Name of the drug	Biological activity
Halogenated compounds	$\text{CHCl}_3$	Chloroform	Anesthetic
	$\text{RCl}_3$	Idoform	Antiseptic
	$\text{RNHCl}$	DDT	Neurotoxic
	$\text{RSO}_2\text{NHCl}$	Chloral	Hypnotic
		Flurocorticoils	Antiinflammatory
Hydro-carbons	$\text{RH}$	Cyclopropane	Anesthetic
Ketones	$(\text{OH})\text{ArCOR}$	Acetophenone	Sedative
		Camphor	Analeptic
		Ketonic steroids	Hormonal
Mercurials	Containing Hg		Antiseptic
Nitro-compounds	$\text{ArNC}_2$	Chloromphenicol	Antibiotic
		Nitrofurans	Bacteriocidal
		Nitrocresols	Weight reducing
Phenols	$\text{ArOH}$	Cresols	Antiseptic
Thiosemi-carbazones	$\text{ArCH=NNHCSNH}_2$		Antituberculosis
Sulphones	$\text{R}_2\text{SO}_2$	Sulphonal	Hypnotic
		Sulphone derivatives	Analgesic
Thiourea	$\text{RNHCSNHR}$	Thiourea	Antithyroidal
		$\alpha$ -Naphthylthiourea	Anticoagulant
Urethones (carbarnates)	$\text{RCOCONH}_2$	Dithiocarbarnates	Fungistatic
Hydrazide	$\text{RCONHNH}_2$	INH	Anitubercular



### History of Tuberculosis

*Mycobacterium tuberculosis* was isolated by Robert Kóch in 1882 which is the principal cause of tuberculosis in human beings. The germs mycobacterium include both saprophytic and pathophytic species. The saprophytic mycobacteria are widely distributed in nature, in soil, in water, in grains, grasses, in butter, upon the skin of the man and other animals. The pathogenic species may produce diseases in a variety of mammals, birds, fish and other cold blooded animals. Many mycobacteria are potentially pathogenic for man e.g. *M. kanaassi* and *M. avim*. Man is also susceptible to infection with *M. boxis*.

### Morphology and Staining of Tuberculosis

*M. tuberculosis* is a thin rod shaped organism which may be either straight or slightly curved. The average length of bacillus is  $1.5\mu$  with a breadth  $0.3$  to  $0.6\mu$ . The organism may be found either single or in small groups. The waxy lipid content of the bacilli consist of phosphatides, acetone soluble fats and chloroform soluble wax. The rods are nonmotile and nonspongenous. Tuberculosis bacilli are aerobic in nature and moisture is necessary for their growth.

### Role of Antibacterial Activity

The present antitubercular drugs have failed to achieve the ultimate goal of relieving completely the suffering human races from tuberculosis. The main reasons may be high order of toxicity of drugs, inefficiency in interfering the normal metabolism of the

infective organisms, inability of the drug in penetration due to the nature of tubercle bacilli, concentration of the drug in bacillus cell and surrounding environment of the tissues. Therefore, it is necessary to invent new drugs which contain activity against tuberculosis but have less toxicity to the human body. Such type of drugs can be used successfully in combating tuberculosis in human beings. Such type of problems remain for investigation to the organic chemists. Some of the important drugs used to cure the tuberculosis and leprosy are tabulated in Table 2.

#### **Inventions on Antitubercular Active Drugs**

Number of published reviews<sup>2-5</sup> and literature is available in chemotherapy on tuberculosis. These reviews show that there is still scope for designing of new chemicals without side effects.

The common therapeutic agents are classified into three categories:

- A. Sulphur containing compounds
- B. Non-sulphur containing compounds
- C. Antibiotics

Different antitubercular active drugs are tabulated in Chart I as per their classification.

#### **4-Thiazolidinones**

##### **Introduction**

Thiazolidinones are the derivatives of thiazoline which belongs to an important group of heterocyclic compounds. The penicillin antibiotic structure has a thiazoline ring along with  $\beta$ -lactam attached to it. Numerous reports have appeared in the

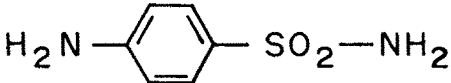
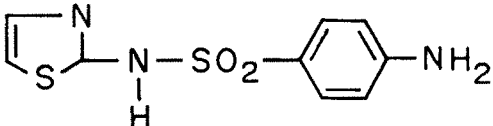
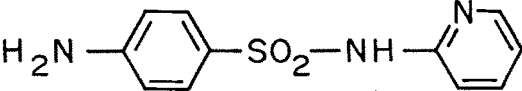
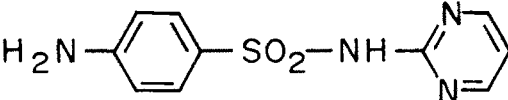
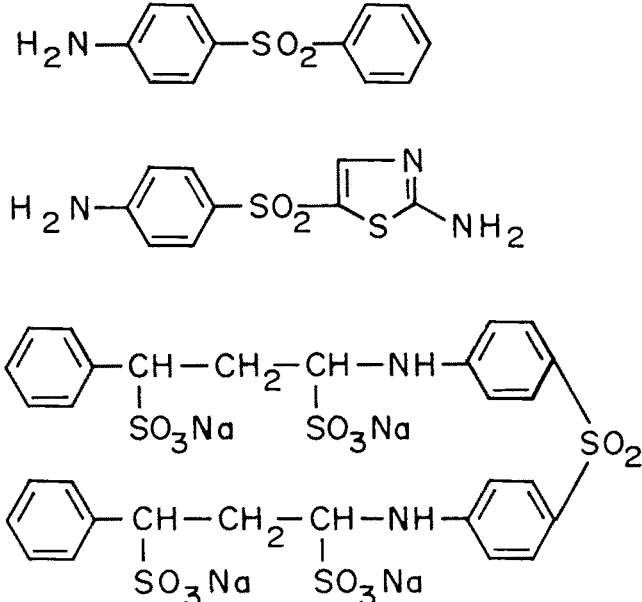
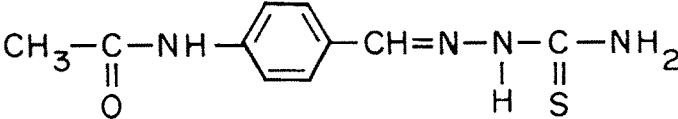
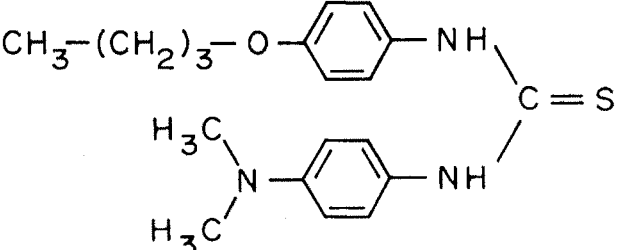
TABLE 2

Sl.No.	Drug	Year of discovery	Used for
1	Dapsone	1939	Leprosy
2	Streptomycin	1944	Tuberculosis
3	p- Aminosalicyclic acid (P AS)	1946	Tuberculosis
4	Thioacetazone	1946	Tuberculosis
5	Viomycin	1951	Tuberculosis
6	Pyrazinamide	1952	Tuberculosis
7	Isoniazide	1952	Tuberculosis
8	Thiambutosine	1953	Tuberculosis
9	Cycloserine	1955	Leprosy
10	Ethionamide	1957	Tuberculosis
11	Kanamycin	1957	Tuberculosis
12	Clofazimine	1957	Leprosy
13	Ethambutal	1961	Tuberculosis
14	Rifampicin	1965	Leprosy
15	Capreomycin	1966	Tuberculosis

CHART - 1

108

A: SULPHUR CONTAINING DRUGS

SR. NO.	NAME OF THE DRUG	BASIC CHEMICAL STRUCTURES
1.	SULPHONILAMIDE <sup>6-9</sup>	
2.	SULPHATHIAZOLE <sup>10</sup>	
3.	SULPHAPYRIDINE	
4.	SULPHADIAZINE <sup>11</sup>	
5.	SULPHONE <sup>12-17</sup>	
6.	THIACETAZONE <sup>18</sup>	
7.	DIPHENYLTHIOUREA <sup>19-20</sup>	

B : NON SULPHUR CONTAINING DRUGS

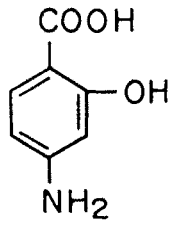
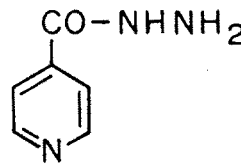
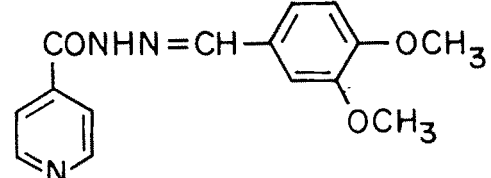
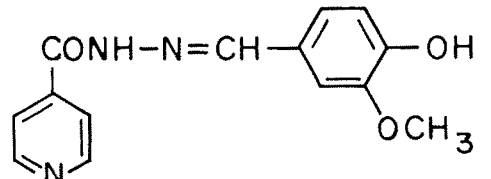
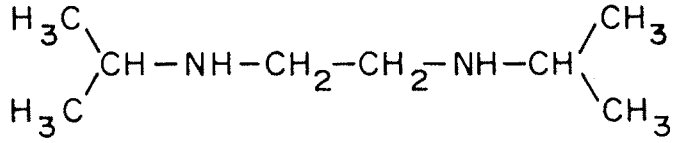
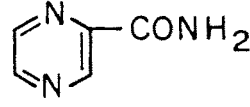
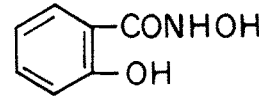
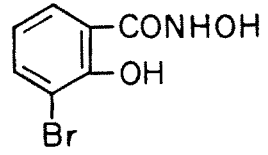
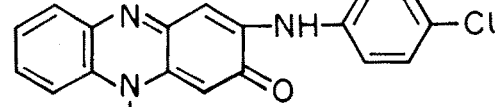
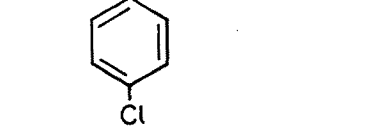
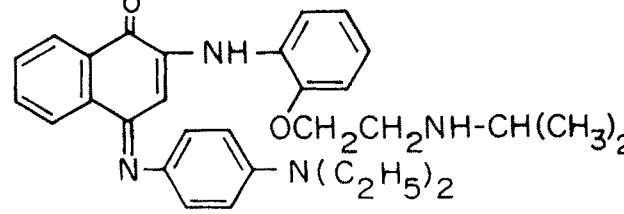
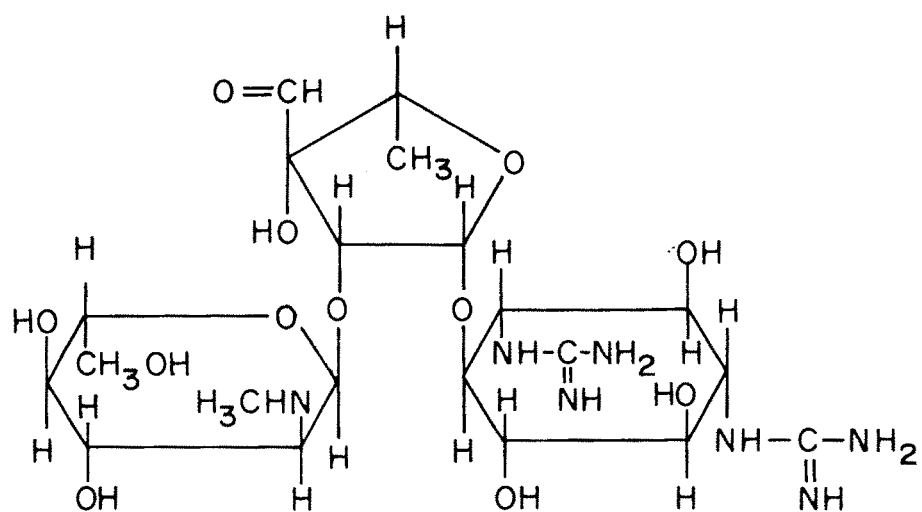
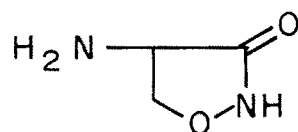
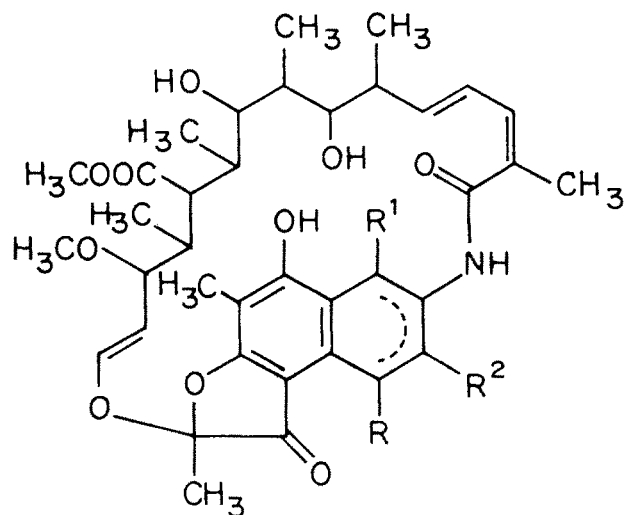
SR. NO.	NAME OF THE DRUG	BASIC CHEMICAL STRUCTURES
8.	PARA-AMINOSALICYLIC ACID (PAS) <sup>21-25</sup>	
9.	ISONICOTINIC ACID-HYDRAZIDE (INH) AND ITS DERIVATIVES <sup>26-27</sup>	  
10.	ETHAMBUTOL <sup>28</sup>	
11.	PYRAZINAMIDE	
12.	HYDROXAMIC ACID <sup>29</sup>	 
13.	BASIC DYES <sup>30-31</sup> PHENAZINE  NAPHTHOQUINONIMINE	  

CHART -1 Continued .....C : ANTIBIOTICS14. STREPTOMYCIN<sup>32,33.</sup>

## 15. CYCLOSERINE

16. RAFIMYCIN<sup>34</sup>

literature which highlights their chemistry. Excellent reviews<sup>35-38</sup> have been written on 4-thiazolidinones. Zoloterova and coworkers<sup>36</sup> reviewed the article which deals with the use of thiazolidinone derivatives as stabilizer for polymeric materials.

Over the years 4-thiazolidinones have been synthesized for a wide range of industrial pharmaceutical and biological purposes.

The thiazolidinone derivatives have been shown to exhibit fungicidal<sup>39-54</sup>, pesticidal<sup>39,55-57</sup>, antitubercular<sup>44,58-60</sup>, anticonvulsant<sup>58,61-65</sup>, hypnotic<sup>66</sup>, nematocidal<sup>39</sup>, bactericidal<sup>40-45,53,57,67-71</sup>, antiviral<sup>54,72</sup>, herbicidal<sup>73</sup>, antiprotozoal<sup>53</sup> and hypoglycemic activity<sup>74</sup> and possible antimutagenic properties<sup>75</sup>, they may also act as potential antiradiation<sup>76</sup> and chemotherapeutic<sup>70</sup> agents. Recently, substituted thiazolidines reported to have aldose reductase inhibitory activity<sup>77</sup>.

### Synthesis of 4-thiazolidinones

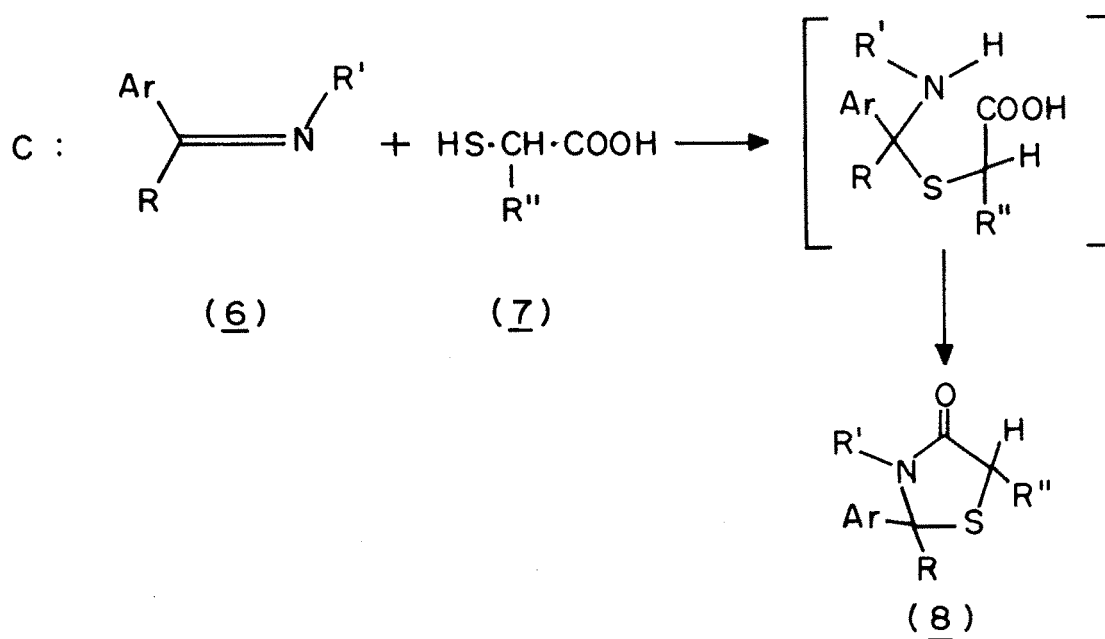
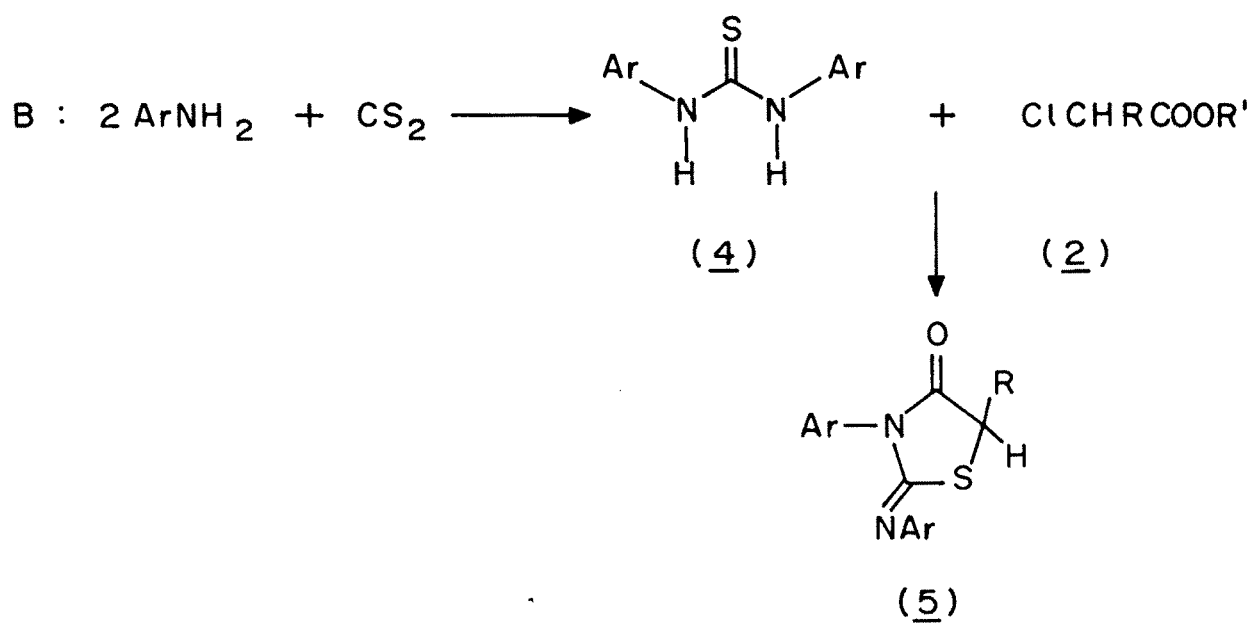
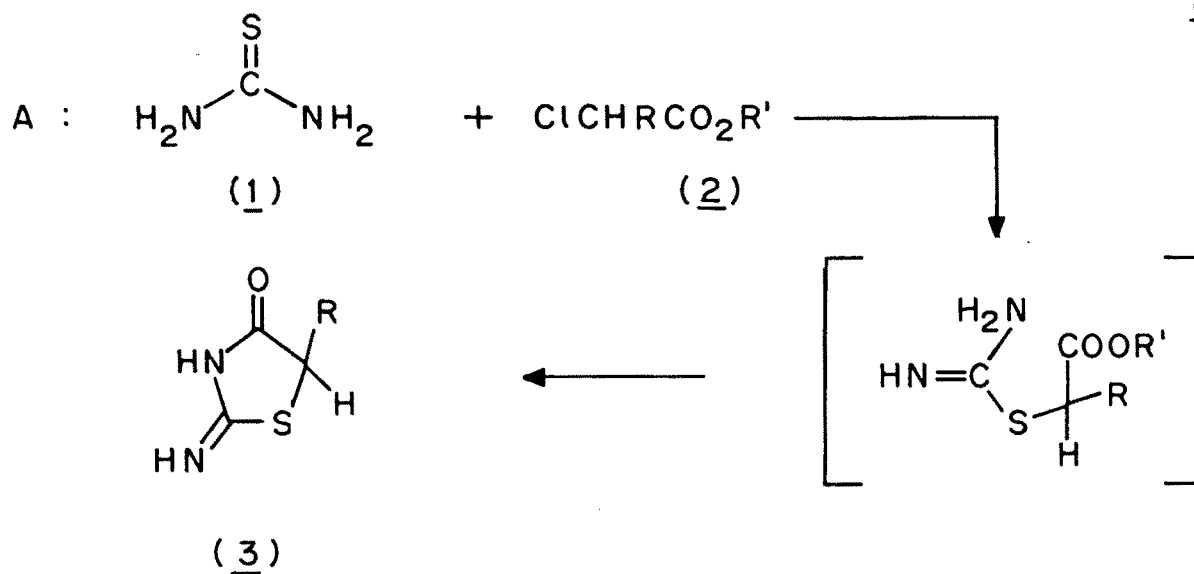
General procedures for the preparation of 4-thiazolidinones describe the formation of the 3-4 bond via cyclization of an appropriately substituted acyclic compounds which had been generally prepared from either thiourea or thioglycolic acid derivative.

### Formation of the 3,4-bond

The simplest synthesis of pseudothiohydantoins(3) (Chart 2-A) is by condensation of (1) with substituted  $\alpha$ -chloroacetates (2)<sup>78-80</sup>. Synthons<sup>81</sup> of  $\alpha$ -chloroacetates, epoxyacides<sup>82</sup>,  $\alpha$ -chloroacetic anhydrides<sup>83</sup> and dialkylacetylene dicarboxylate<sup>84</sup> have been successfully substituted for (2). Symmetrical diarylthioureas (4), conveniently synthesized from the corresponding arylamine and carbondisulphide, react with  $\alpha$ -haloacetic acid derivatives to give

CHART - 2

112





a single thiazolidinone (5)<sup>39,55,83</sup> (Chart 2-B).

Aromatic Schiff bases (6) from the corresponding aldehyde and ketone and primary amine undergo reaction with  $\alpha$ -mercaptoalkanoic acids (7) or their derivatives to give 4-thiazolidinones (8)<sup>64,85-90</sup> (Chart 2-C).

A convenient synthesis of 2-arylidene hydrazono-4-thiazolidinone (11) from ethylcyanoacetate (9) arylidenazines (10) and hydrazine hydrate has been reported<sup>91</sup>. Probably the reaction proceeds via the intermediary hydrazone which condenses with (9) to give (11) (Chart 3-A).

The reaction of thiobenzanilide (12) with bromoacetic acid in the presence of triethylamine affords S-carboxymethylthiobenzanilide (13). Compound (13) on treatment with acetic anhydride and triethylamine gives pseudobase (14)<sup>92</sup> (Chart 3-B).

#### Formation of 2,3-Bond

2-Haloacetamides (15) react with potassium thiocyanate (16) to give 2-thiocyanatoacetamides(17) which cyclize in proton donor solvents to the 2-imino-4-thiazolidinones (18)<sup>93</sup> (Chart 3-C).

Substituted thioglycolamide (19) on treatment with ethylchloroformate gives corresponding thiazoldine 2,4-diones (21) via an intermediate carbonate (20)<sup>94</sup> (Chart 3-D).

#### Formation of 1,5-Bond

Allyl chloride (22) when treated with ammoniumthiocyanate in refluxing n-butanol gave thiourethan (23). This thiourethan which



reacted with  $\alpha$ -chloroacetylchloride and benzaldehyde gave 5-arylidene dione (24)<sup>95</sup> (Chart 4-A).

#### Formation of 1,2- and 3,4-Bonds

Imines (25) on treatment with ketene (26) in sulphurdioxide afforded substituted thiazolidine-4-one 1:1-dioxide (27)<sup>96</sup> (Chart 4-B). To support the results, it was suggested that this (3+2) cyclo-addition proceeded via 1,3-dipolar intermediate<sup>97</sup> (29) (Chart 3-B). This ketene-sulphurdioxide adduct(29) reacts cleanly with aromatic amines<sup>98</sup> and imines<sup>99</sup> and carbon nitrogen double bonds<sup>100,101</sup>.

#### Formation of 1,2-and 1,5-Bonds

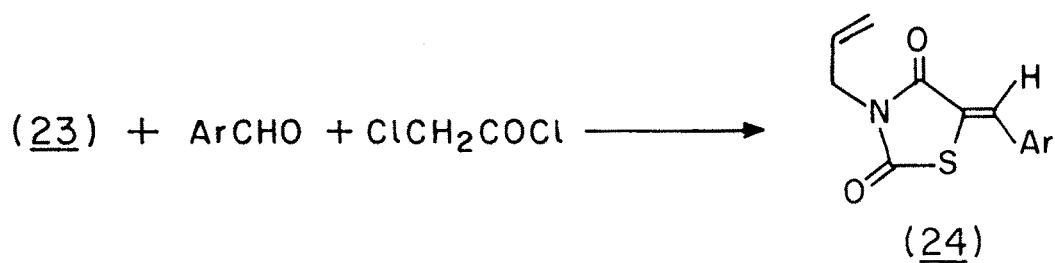
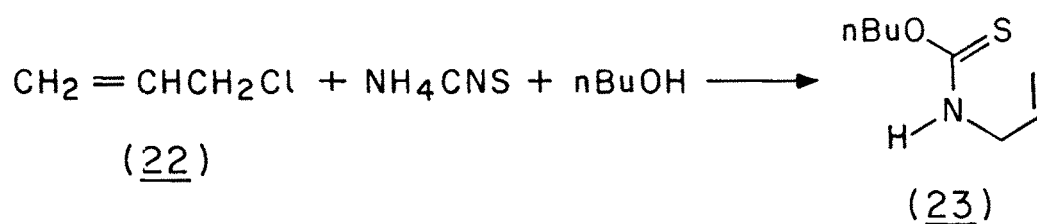
Diphenylketene (30) undergoes reaction with diisopropylcarbodiimide in liquid sulphurdioxide to give (31). It was suggested to be two step process via a 1,4-dipolar intermediate similar to (28)<sup>102</sup>. Phenylalkylketenes similarly react with Schiff bases in liquid sulphurdioxide to give only transthiazolidinone 1,1-dioxide (32) (Chart 4-C).

#### Ring Interconversion

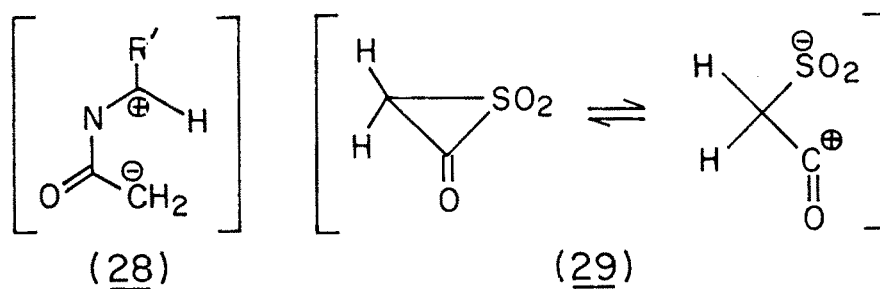
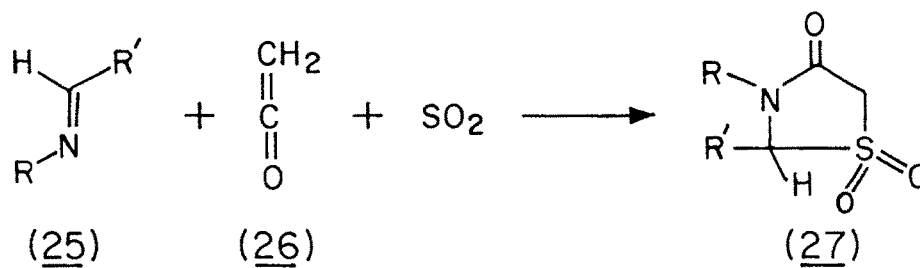
Tetrahydro-1-H-1,3-diazepine-2-thiol (33) when heated with ethylchloroacetate gives (34). While the reaction of (33) with chloroacetic acid in aqueous medium affords 3-( $\delta$ -aminobutyl)-thiazolidine-2,4-dione (35) via initial generation of (34) followed by hydrolysis<sup>103</sup> (Chart 5-A).

5-Aryl-3-N-phenyl-imino 1,2-dithiol (35A) condenses with ketenes to give (36)<sup>104</sup>. Substituted ketenes with (35A) give corres-

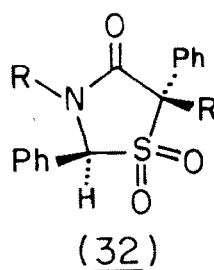
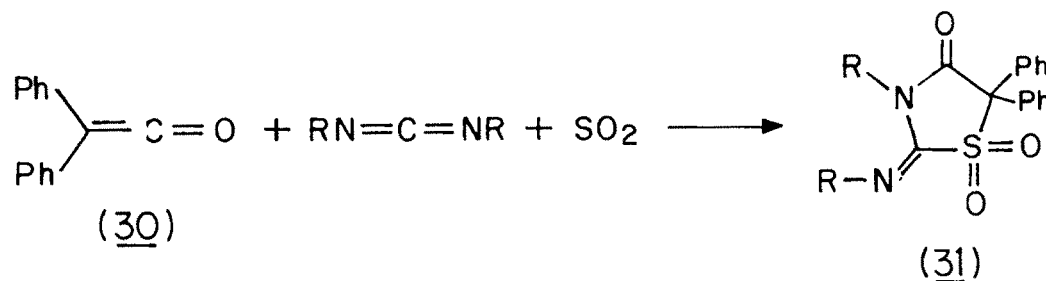
A:



B:



C:



ponding 5-substituted (36) (Chart 5-B).

### Reactions of 4-thiazolidinones

All the five positions of 4-thiazolidinones show some substitution reactions which are summarised as below:

#### Substitution at Position 1

3-Substituted-4-thiazolidinones (37) on oxidation with permanganate in acetic acid give the corresponding sulphone (39)<sup>65,71,87,99,105-109</sup> via the sulphoxide intermediate (38) (Chart 6-A). With peracetic acid<sup>65</sup> 3-substituted-4-thiazolidinones generate either the sulphoxide<sup>68,110</sup> or with acetic anhydride<sup>111</sup> or more severe conditions<sup>65</sup> the corresponding sulphone.

#### Substitution at Position 2

Iminothiazolidinones (5) easily undergo acid base hydrolysis under mild conditions to give the corresponding diones (40)<sup>39,47,74,81,82,96,97,103,107</sup>.

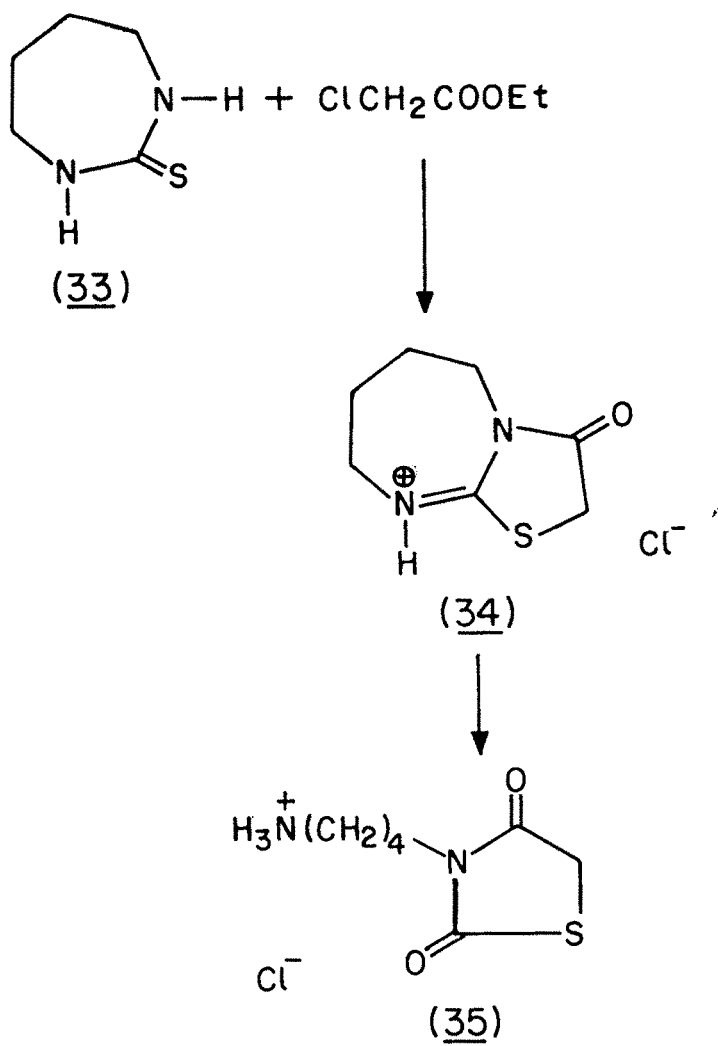
The thiazolidine ring is cleaved at the  $N_3-C_4$  bond on prolonged heating with hydrochloric acid in ethanol with formation of an N-substituted pseudohydantoic acid (Chart 6-B).

When rhodanine (41) is reacted with methyl iodide and equal molar quantity of triethylamine in chloroform, the corresponding dione (42) is isolated in high yields<sup>112,113</sup> (Chart 6-C).

#### Substitution at Position 3

2,4-Thiazolidinone (42) is readily alkylated at 3-position when treated with alkyl chloride for 5 minutes at 142 to 145°C in DMF

A:



B:

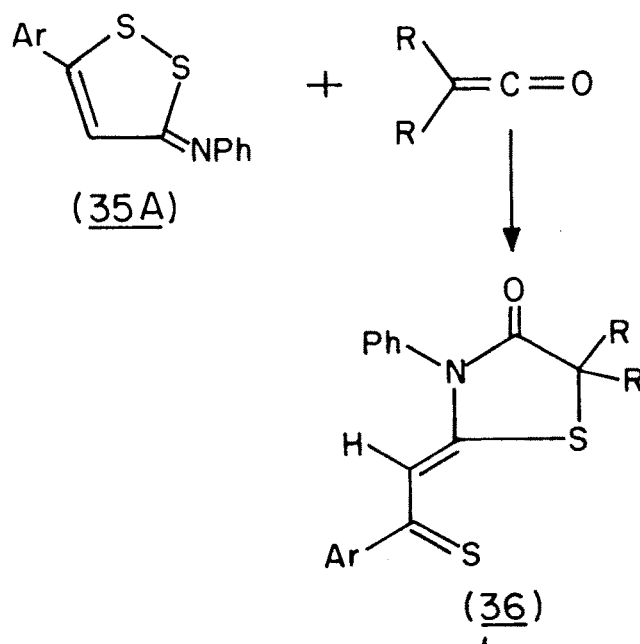
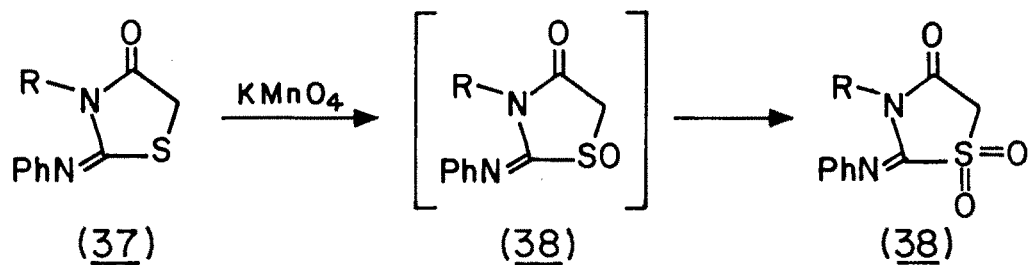


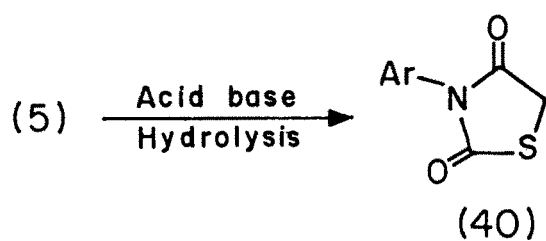
CHART 6

119

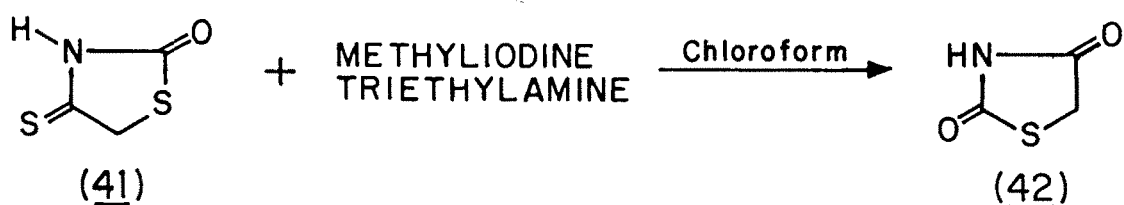
A:



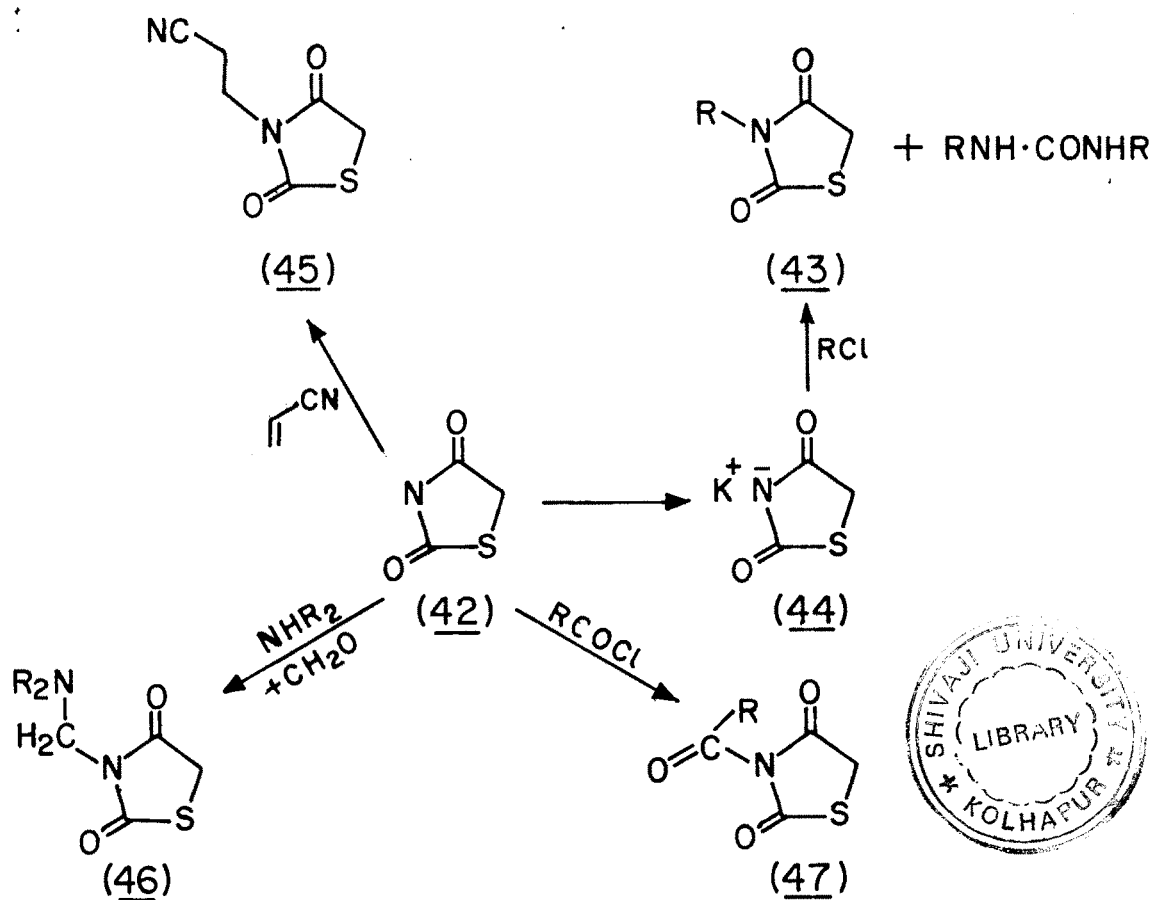
B:



C:



D:



with potassium carbonate (Chart 6-D)<sup>101</sup>. Chizhevskaya et al.<sup>114</sup> have reported Mannich reaction at nitrogen at position 3 of 2-(arylimino)-4-thiazolidinones with formaldehyde and secondary amines. Treatment of potassium salt of 42(43) with primary alkyl halide give N-alkylated product<sup>115</sup>. By this procedure<sup>53,116-118</sup> a wide range of functionalised side chains have been attached to the 3-position. Similarly different substitution reactions at position 3 have been summarised in Chart 6-D by using different reagents to get the compounds (45),(46),(47).

#### Substitution at Position 4

Treatment of (48) with phosphorous pentasulphide in dioxane affords isorhodanine (49) (Chart 7-A) which is an isomer of rhodanine<sup>119-122</sup>. This isorhodanine being highly reactive, it reacts with hydroxylamine<sup>123</sup> amines<sup>119-123</sup> and substituted hydrazines<sup>120-123</sup> to give different compounds.

#### Substitution at Position 5

##### Condensation reactions

4-Thiazolidinones are condensed with aromatic aldehydes usually by refluxing in glacial acetic acid with fused sodium acetate for lengths of time dependent upon ring substituents<sup>124</sup>. Thus (50) with benzaldehyde yields 73% (51) (Chart 7-B) after 2 hrs of refluxing<sup>125</sup>.

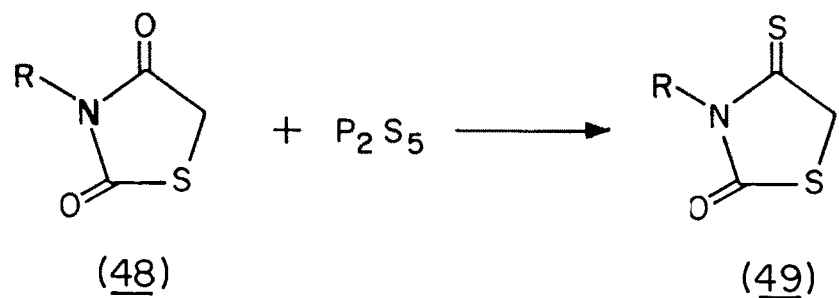
This general procedure has been used to condense 2-iminothiazolidinones (52)<sup>40-45,74,77,125</sup>, diones (53)<sup>53,57,117,118,126,127</sup>, 4-imino-2-ones (54)<sup>128,129</sup> 2-ones-4-thiones (49)<sup>119,122</sup> and substituted (53)<sup>130</sup> with aromatic aldehydes.

##### Halogenation

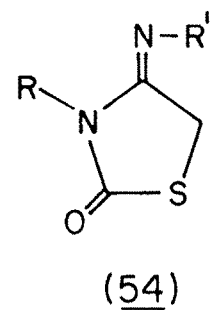
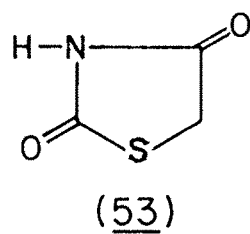
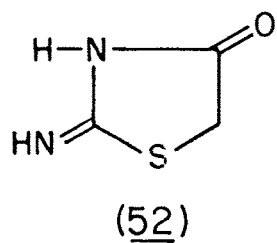
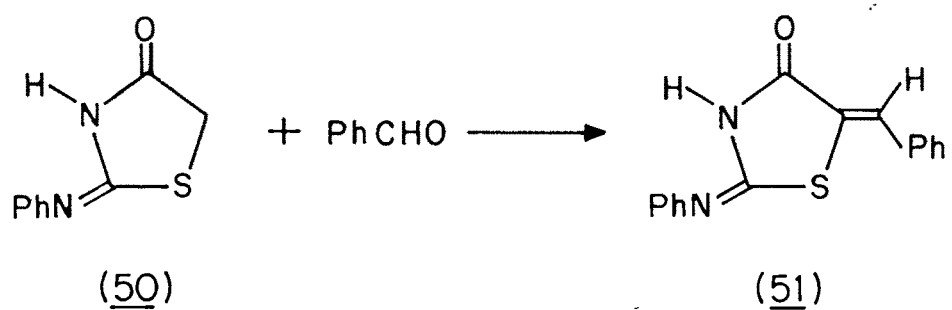
When 3-phenyl-2-4-thiazolidinone(55) is brominated in acetic acid gives 5-bromo derivative (56) which upon further bromination forms the 5-5 dibromoderivative (57)<sup>131</sup> (Chart 7-C).



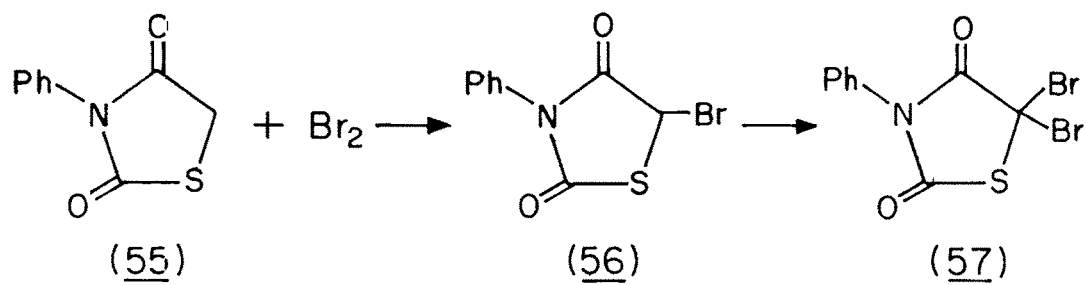
A:



B:



C:



### Coupling Reactions

The thiazolidinone (58) on coupling with benzene diazonium chloride at 0-5°C affords (59) which on further reduction with sodium hydrosulphite gives (60)<sup>133</sup> (Chart 8-A).

### Heteroarylation

The heteroarylation of thiazolidinones has been accomplished with N-acyl pyridinium-quinolinium, -isoquinolinium and acridinium salts<sup>132</sup>. Alkaline hydrolysis of (61) serves as convenient source of heterocyclic thioglycolic acid (Chart 8-B).

### Ring Opening Reactions

Under crastic acidic hydrolysis<sup>134</sup> or treatment with hydroxide or alkoxide<sup>135</sup> 4-thiazolidinones are cleaved at N<sub>3</sub>C<sub>4</sub> bond. The reaction of (53) with hydrazine at below 0°C affords an adduct (62) (Chart 8-C).

### Ring Formation Reactions

#### Cyclization between the 2,3-position

2-Phenylhydrazono-4-thiazolidinone (63) and their 5-substituted derivatives are cyclized upon treatment with formaldehyde or aromatic aldehydes to give the bicyclic structure (64)<sup>136</sup> (Chart 9-A).

#### Cyclization between 3,4-positions

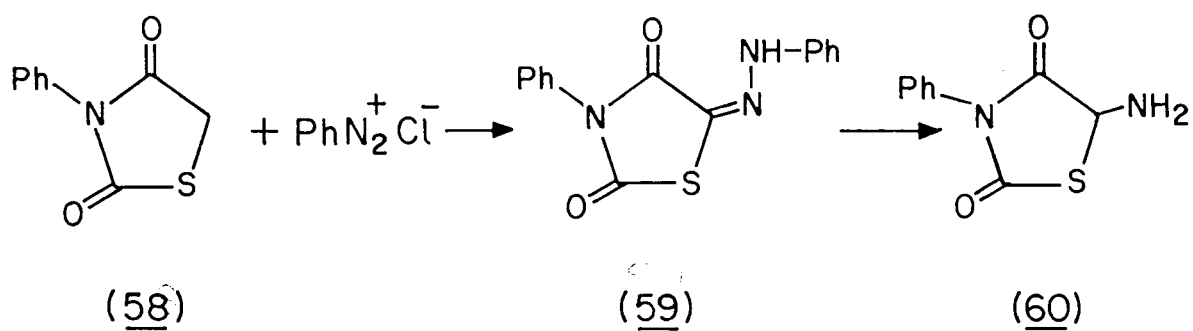
Cyclization of 4-phenylhydrazono derivative of 2-thiazolidinone (65) with formaldehyde or aromatic aldehydes gives 2-phenyl-2,3-dihydrothiazolo[4,3-C],2,4-triazol-5-ones (66)<sup>137</sup> (Chart 9-B).

#### Cyclization between 4,5-positions

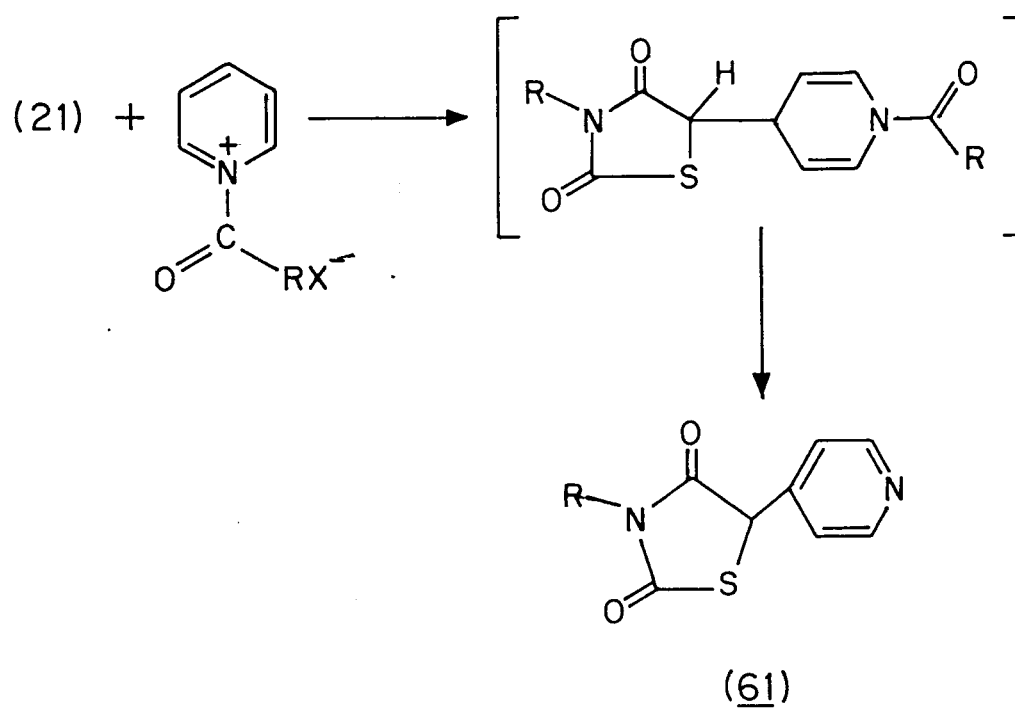
4-Imino-2-thiazolidinone (67) on treatment with formylhydrazine

CHART 8

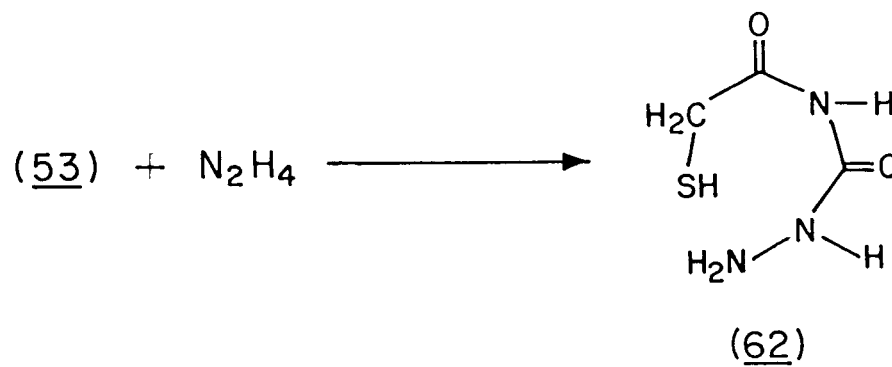
A:



B:



C:



gives pyrazolo derivative of 2-thiazolidinone (68)<sup>138</sup> (Chart 9-C).

#### Metal Complexes of 4-thiazolidinones

Co-ordination complexes of rhodanine (2-thiano-4-thiazolidinone) and its 3-substituted derivatives as ligand have been studied with copper (I), silver (I), gold (I), palladium (II) and platinum (II). On the basis of the spectral data it is believed that the coordination in these complexes takes place through the thiocarbonyl group of the ligand.

Gold forms a 1:1 complex with 2-thiano 5,5-dimethyl-4-thiazolidinone. Analytical and spectral data indicated that the structure of gold complex with 2-thiano-5,5-dimethyl-4-thiazolidinone is proposed as (69)(Chart 9-D).

#### Miscellaneous applications of 4-thiazolidinones

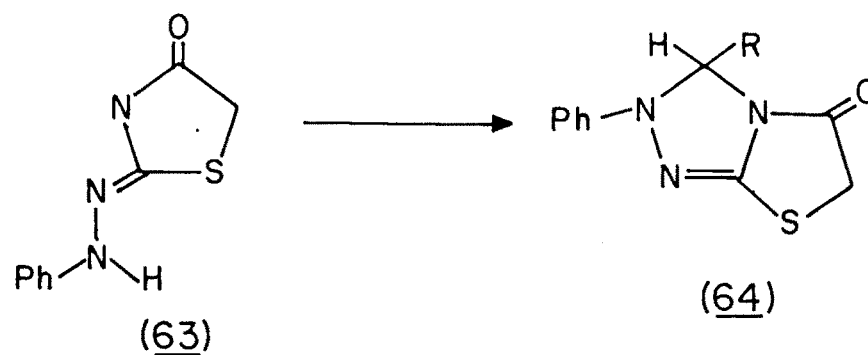
A colourimetric procedure using substituted-4-thiazolidinones is available for the quantitative determination of extremely small quantities of gold<sup>139</sup>. The same reagent and general procedure is useful for the quantitative determination of silver and can detect 0.05 - 0.1 ppm in 10 ml sample<sup>140</sup>.

Several 3-substituted-5-arylidene-2-phenylimino-4-thiazolidinones protect light sensitive photographic film from harmful effects of ultraviolet radiation<sup>141,142</sup>. The formation of a polymeric acetal by the addition of 3-(2-2-diethoxyethyl)-2-phenyl-5-(O-sulphobenzylidene)-4-2-thiazolidinone to polyvinyl alcohol gives a compound which absorbs ultraviolet radiation<sup>143</sup>.

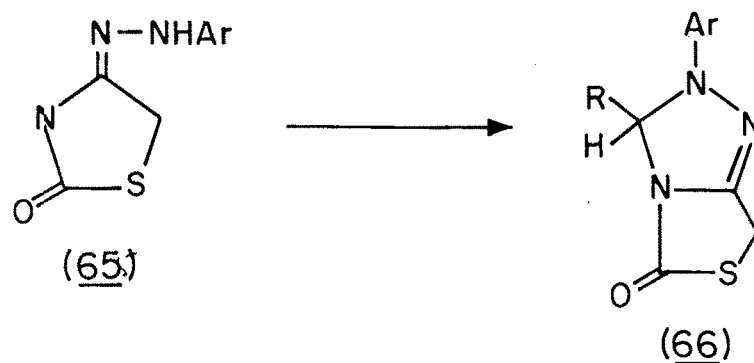
CHART 9

125

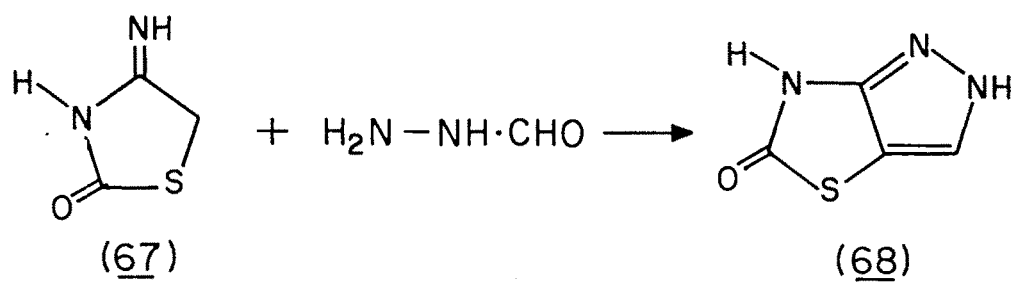
A:



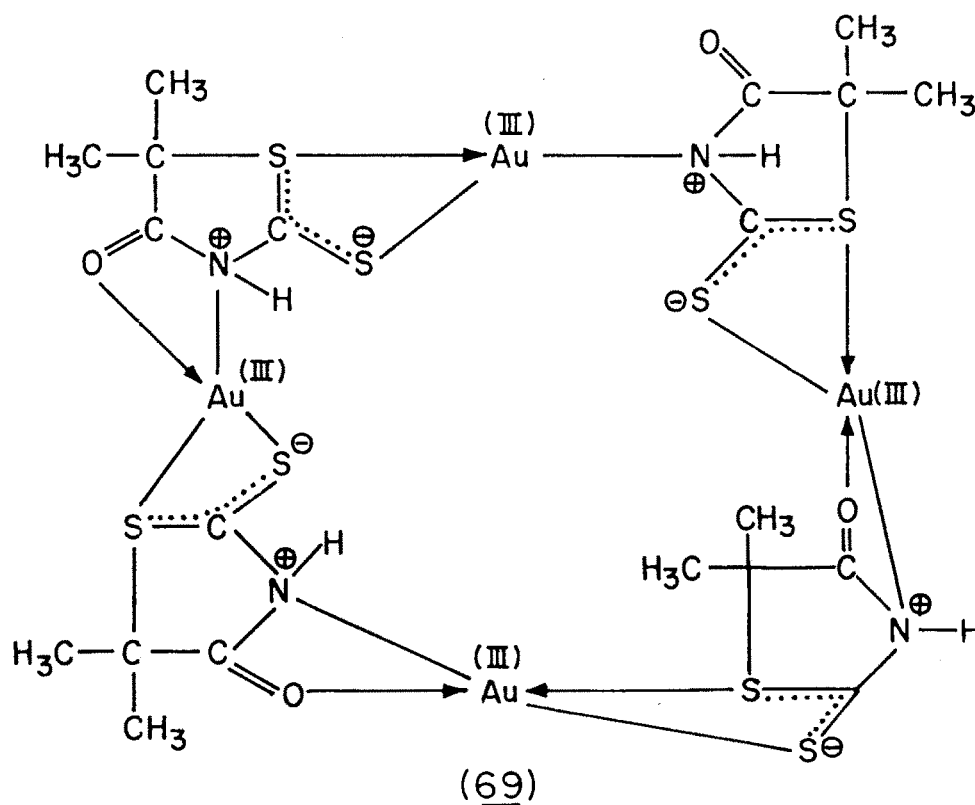
B:



C:



D:



The indigo like oxidation product of rhodanine and the 5-arylidene (or 5-arylimino)3-phenyl-2-phenylimino-4-thiazolidinones are reported to give fast colours on wool<sup>144</sup>. Rhodanine has been considered as a possible source of mercaptoacetic acid in cold-wave preparation<sup>145</sup>.

Polymeric substances containing a 4-thiazolidinone unit include a thermosetting polymer formed by the condensation of rhodanine and formaldehyde<sup>146</sup>. The latter may be condensed with phenol formaldehyde giving products which vary from thermoplastic solids to viscous fluid at high temperature<sup>147</sup> and with anhydride of dibasic acids<sup>148</sup>.

## PRESENT WORK

## AIM, OBJECTIVE AND SCOPE

4-Thiazolidinone derivatives exhibit a variety of pharmacological activities. The presence of N-C-S linkages in the 4-thiazolidinones have been postulated as the moiety for different biological activities like antibacterial, antifungal, antitubercular activities.

Attempts also have been made earlier to enhance the biological activity by introducing different substituents at 2,3,5 positions of 4-thiazolidinone ring. These 4-thiazolidinones have drawn the attention of researchers in the last three decades due to wide spectrum of biological activities associated with them.

These observations prompted us to synthesize the different thiazolidinones. The literature survey of 4-thiazolidinones indicated that there are four different methods to prepare them which are summarised:

- a) In one method, aldehyde, hydrazine hydrate and thioglycolic acid are taken together and refluxed in benzene for 6 hrs to get corresponding substituted 4-thiazolidinones<sup>149</sup>.
- b) The second method, Schiff bases are prepared first and then condensed with thioglycolic acid in presence of catalyst (anhydrous zinc chloride) at 160 to 180° for about 2 hrs<sup>150</sup>.
- c) The third method, a mixture of Schiff base and thioglycolic acid is refluxed in benzene for 4 hrs and the product is isolated<sup>151</sup>.
- d) The last method, a mixture of Schiff base and thioglycolic acid in dry benzene was refluxed for 8 hrs using Dean and Stark apparatus to remove water azeotropically.

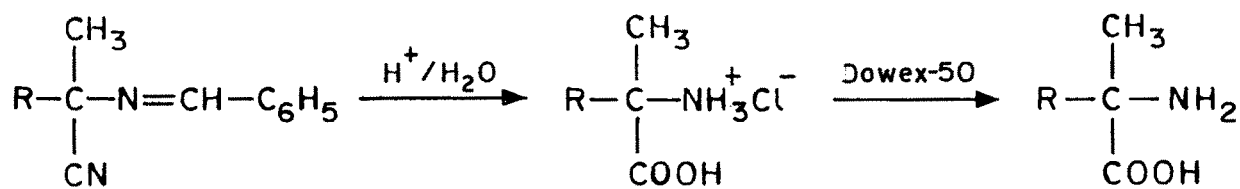
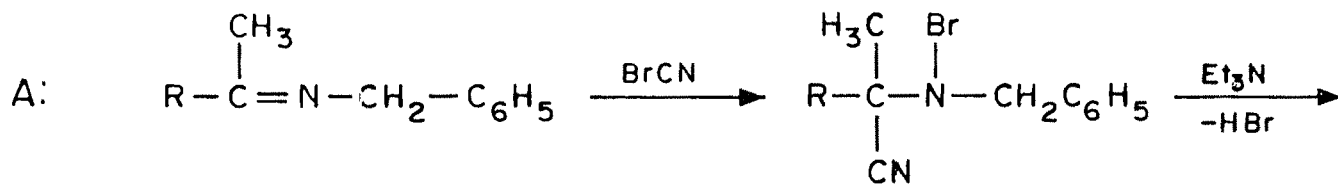
In order to synthesize thiazolidinones we start with Schiff bases, a compound formed by a condensation reaction between an aldehyde or ketone with an amine is known as Schiff base. This name is given after Hugo Schiff. The inventor of the reaction mechanism can be visualized in two steps. The first is addition of amine to the double bond of the carbonyl and the second is the elimination of water to form a new double bond.

This reaction is an important reaction because the Schiff bases can be used to prepare thiazolidinones,  $\beta$ -lactams, heterocyclic compounds, dyes, metal complexes etc. This can be illustrated by few examples.

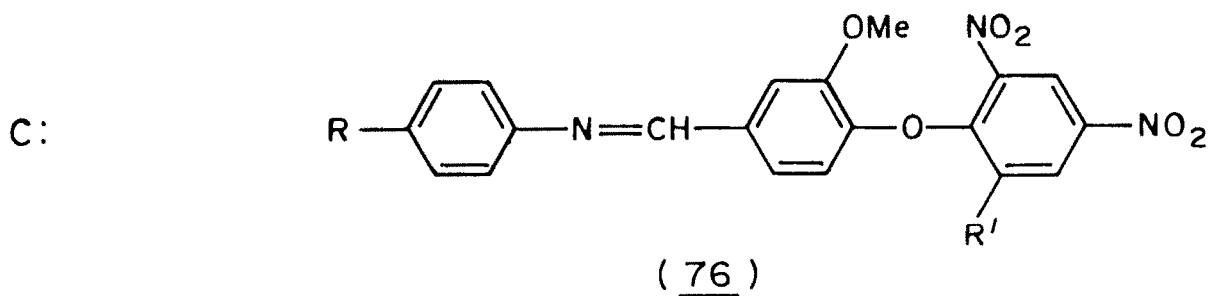
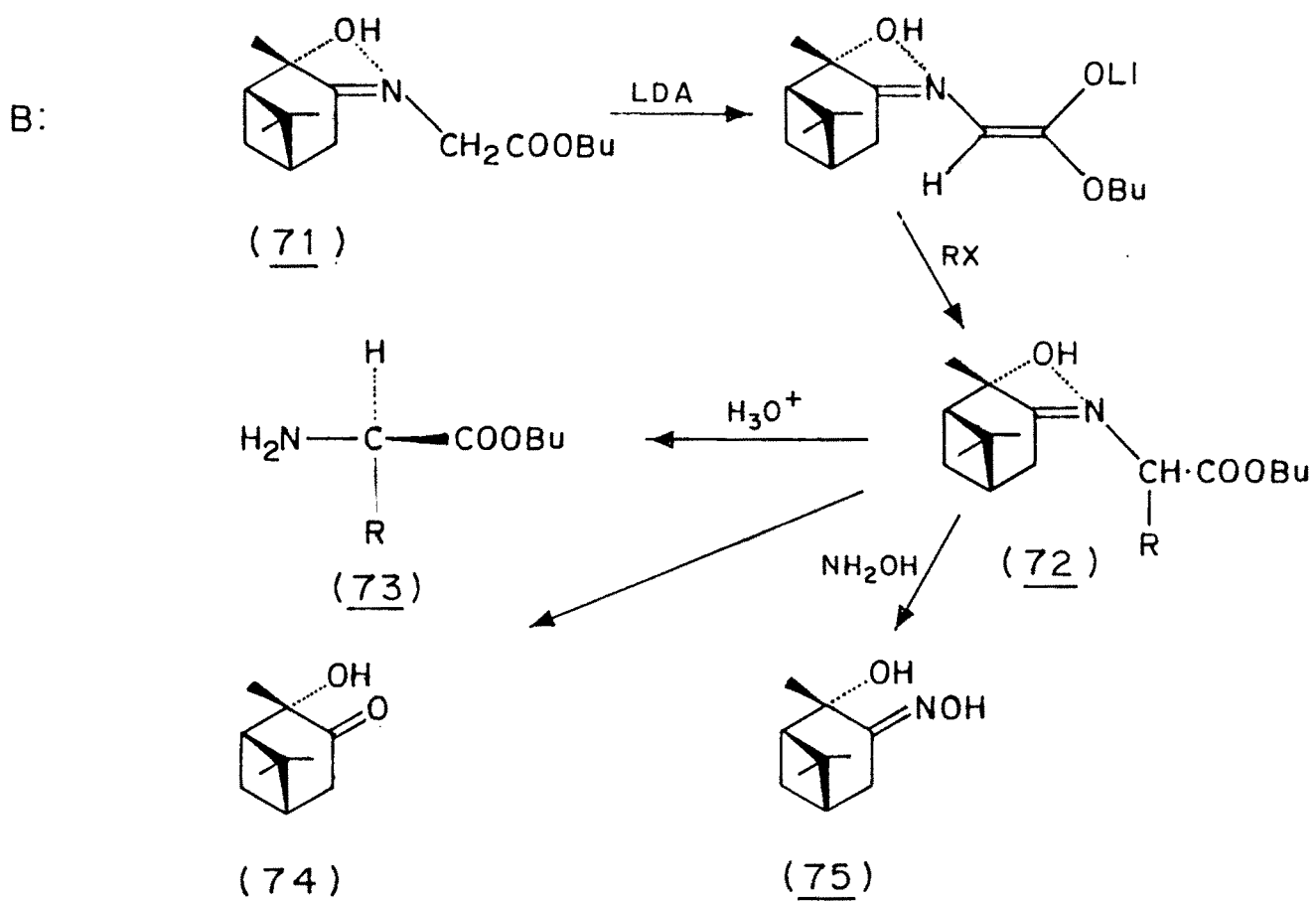
#### Applications of Schiff bases

1.  $\alpha$ -Amino acid (70) can be prepared from Schiff bases<sup>153</sup> (Chart 10A). An efficient asymmetric synthesis of D- $\alpha$ -amino acid derivatives (73) has been achieved by alkylation of Schiff base (71) (Chart 10B). The compounds (73), (74), (75) were formed from Schiff base (72)<sup>154</sup>.
2. Some of the Schiff bases (76) (Chart 10C) have been studied for the biological activity<sup>155</sup> such as antifungal.
3. Substituted aziridines (77)<sup>156</sup> are prepared by using substituted Schiff bases (Chart 11A). Cyclization of (o-nitro-benzylidene)-o-phenylenediamine with KCN/MeOH gave heterocyclic compound<sup>157</sup> (78) (Chart 11B). Some of the Schiff bases derived from the reaction





(70)



of cyclohexanone hydrazones with mercaptoacetic acid gave spiro compound 4-thiazolidinones (79)<sup>158</sup> (Chart 11C).

4. Syntheses of biologically active  $\beta$ -lactams containing heterocyclic moiety (80) have been achieved. (Chart 11D)<sup>159</sup>. Kamdur et al. have prepared new  $\beta$ -lactams (81) from Schiff bases containing two azomethine -N=CH- groups<sup>160</sup> (Chart 11D).

5. Schiff bases derived from different aromatic nucleus are also used to prepare substituted thiazolidinones (82) (Chart 12A)<sup>161</sup>.

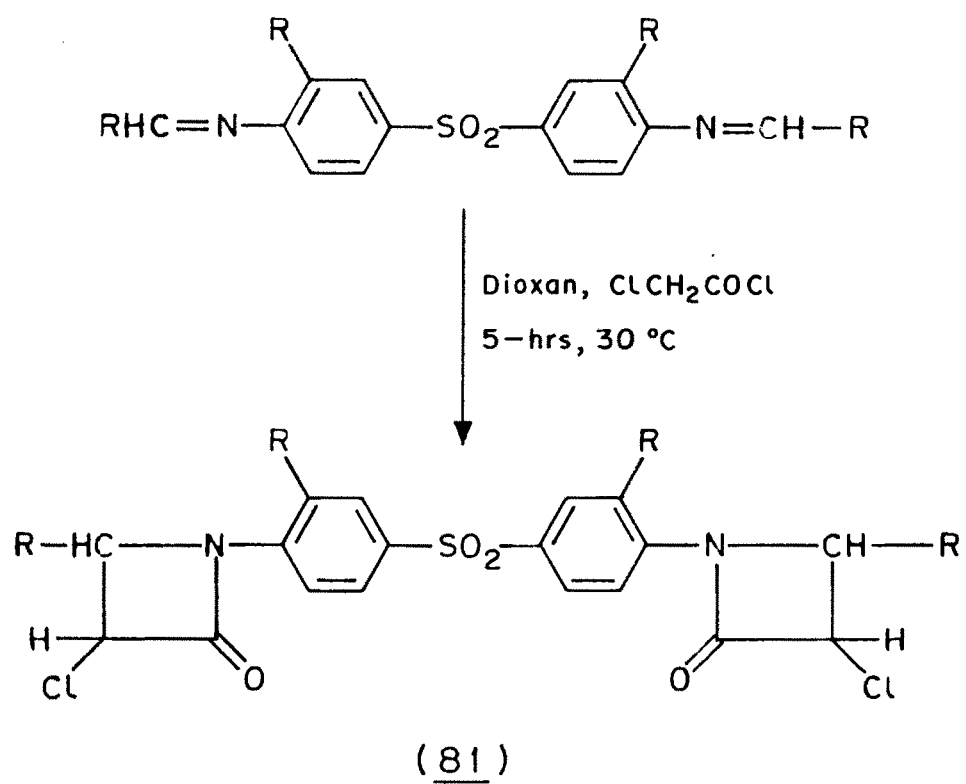
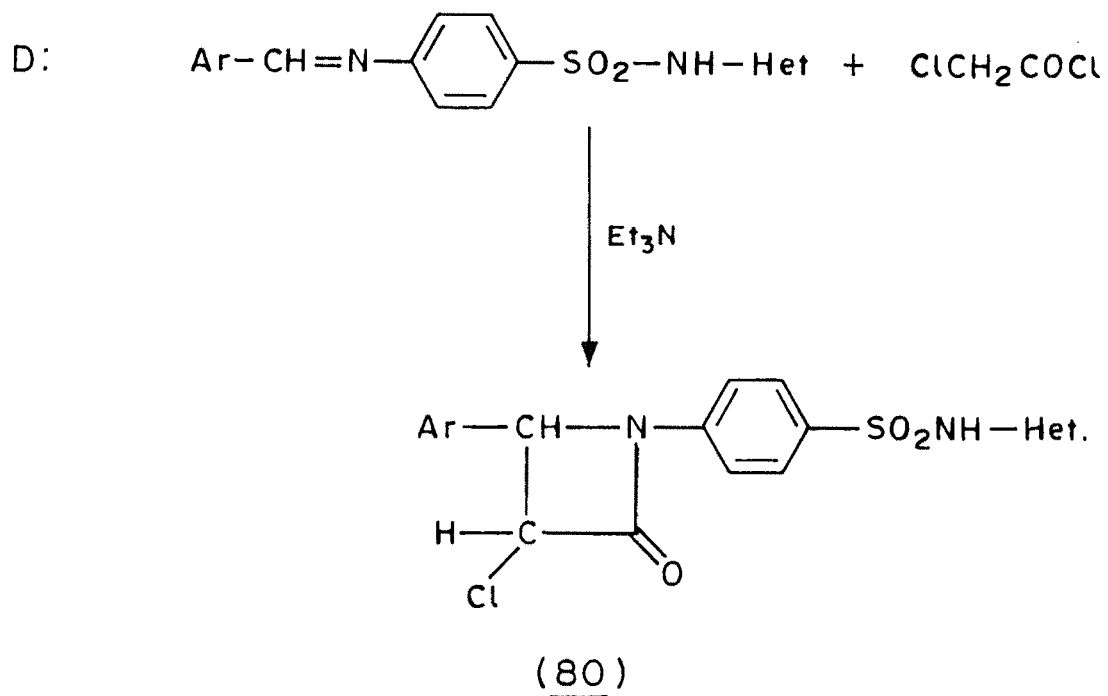
6. Optically active amino acids (83) are prepared by using optically active Schiff bases (Chart 12B)<sup>162</sup>.

7. Electrochemistry performs a broad array of chemical transformations. One of them is carboxylation of Schiff bases to give  $\alpha$ -amino acids (84) (Chart 12C)<sup>163</sup>.

8. A series of Schiff bases are prepared by condensing 5-formyl-3-cyano-6-hydroxy-4-methyl-pyrid-2-ones with aryl amines such as aniline, *o*-chloroaniline, *m*-toluidine, *m*-aminophenol, *p*-aminophenol, *m*-chloroaniline, and 2-aminoanthraquinone in presence of glacial acetic acid containing acetic anhydride are used as dyes. By using above amines, crystalline solids (85) having reddish to greenish yellow colour were obtained (Chart 12D)<sup>164</sup>.

9. The Schiff bases are also used in the formation of metal complexes. Patil et al.<sup>165</sup> reported the synthesis of number of ferrocenyl hydrazones (Chart 13). The study of keto enol tautomerism of such type of hydrazones have been reported (Chart 13).

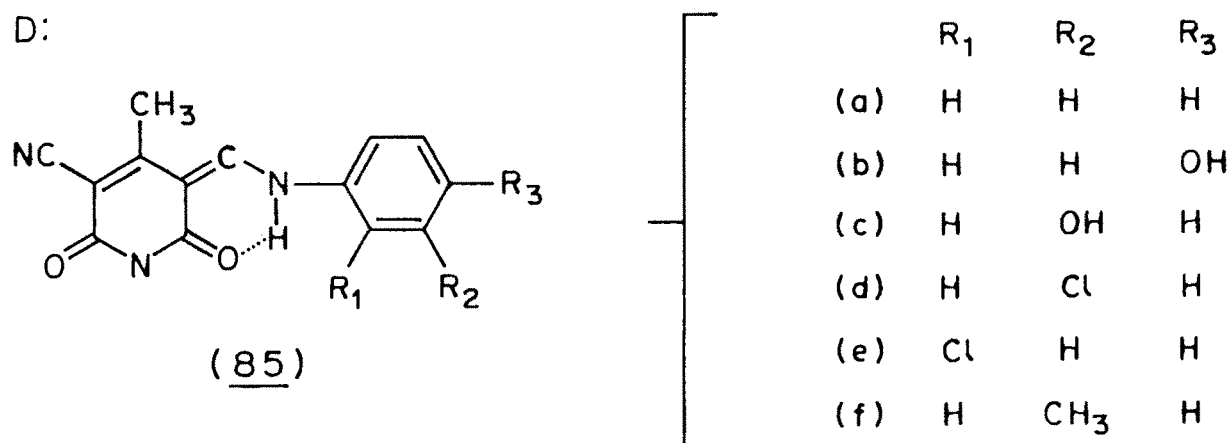
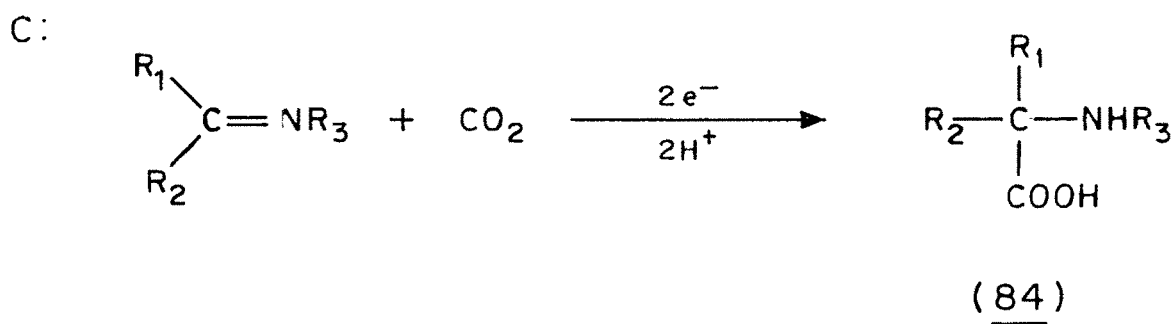
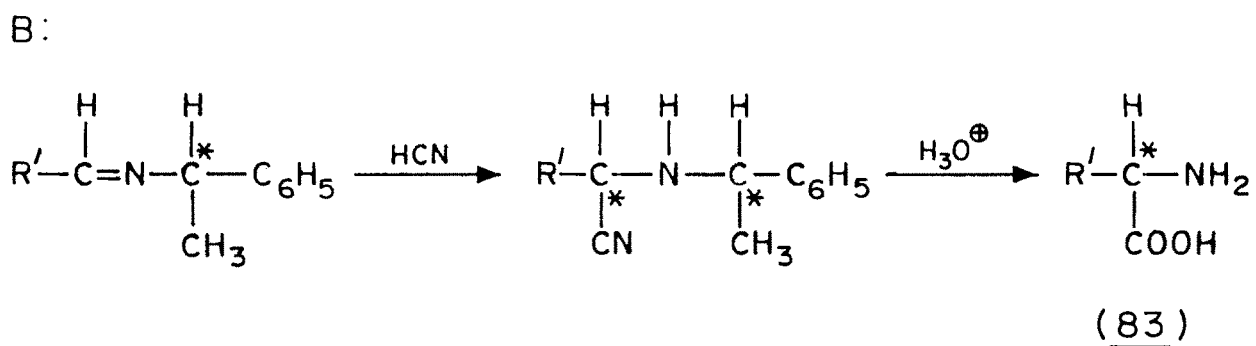
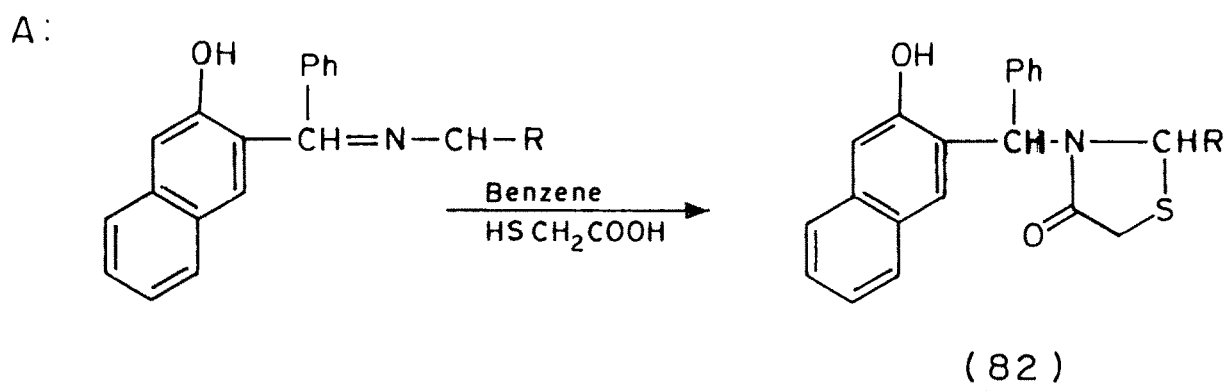




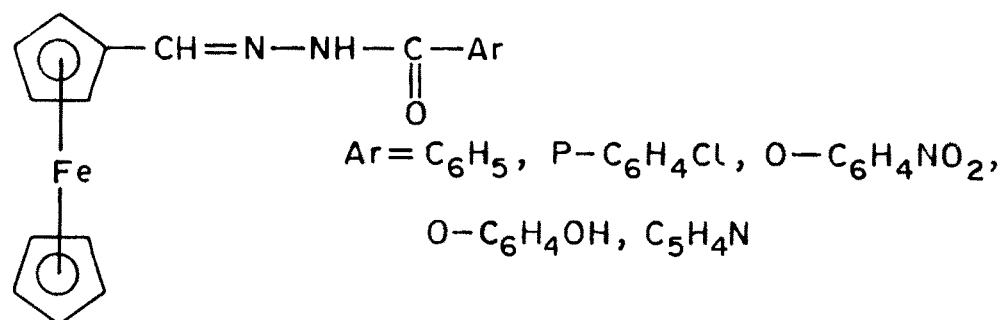
(a) R = H

(b) R = CH<sub>3</sub>

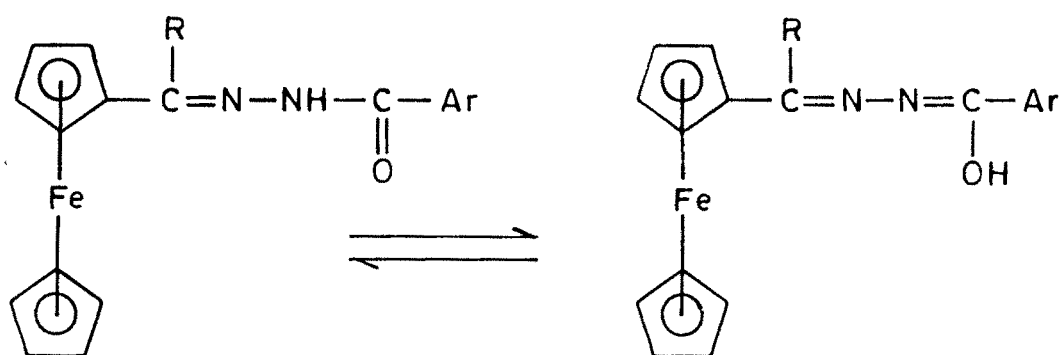
## CHART - 12



## CHART - 13



(86)



(87) keto

enol

	R	Ar
(a)	H	$\text{C}_6\text{H}_5$
(b)	H	$\text{p-C}_6\text{H}_4\text{Cl}$
(c)	H	$\text{o-C}_6\text{H}_4\text{NO}_2$
(d)	H	$\text{C}_5\text{H}_4\text{N}$
(e)	$\text{CH}_3$	$\text{C}_6\text{H}_5$
(f)	$\text{CH}_3$	$\text{C}_5\text{H}_4\text{N}$
(g)	$\text{CH}_3$	$\text{o-C}_6\text{H}_4\text{OH}$

---

---

SECTION-B

---

---

## PRESENT WORK (DISCUSSION)

We have prepared Schiff bases from differently substituted benzoic acid hydrazides and substituted aromatic aldehydes. Benzoic acid derivatives (88) were converted to their esters (89) which on treatment with hydrazine hydrate yielded corresponding hydrazides (90). These hydrazides (90) were then reacted with benzaldehyde derivatives by refluxing in ethanol to give differently substituted Schiffbases (91) (Chart 14). These Schiff bases are characterised by IR, NMR and analytical data. Their analytical data and melting points are summarized in Table 1.

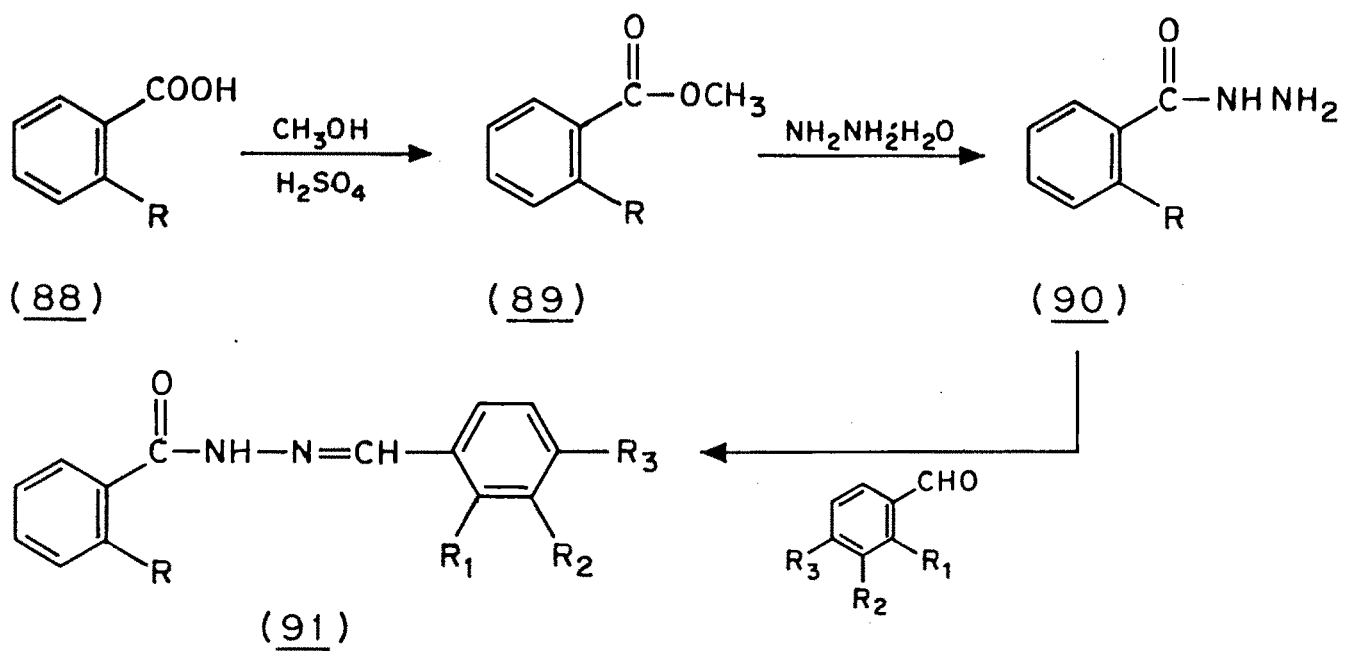
The IR spectra of all the Schiff bases (91) have shown the presence of amidic (CO- NH) and azomethine (C=N) groups. The values of these groups in the individual compounds have been shown in Table 2. The amide keto in the benzoic acid hydrazide appears at  $1670\text{ cm}^{-1}$ ; while Schiff base obtained by treating benzaldehyde with benzoic acid the carbonyl hydrazide showed stretching at  $1650\text{ cm}^{-1}$  i.e. shift of about  $20\text{ cm}^{-1}$ . Similar shift has been observed in all the cases.

The appearance of absorption band at  $1620\text{ cm}^{-1}$  in the Schiff bases formed, clearly indicated that C=N bond has been formed. Similarly disappearance of  $\text{NH}_2$  band at  $3300\text{ cm}^{-1}$  in the Schiff bases also indirectly indicated the formation of azomethine bond.

The formation of Schiff bases is shown in the NMR data.



## CHART - 14

R=H

	R <sub>1</sub>	R <sub>2</sub>	R <sub>3</sub>
(a)	H	H	H
(b)	H	H	OCH <sub>3</sub>
(c)	H	H	N(CH <sub>3</sub> ) <sub>2</sub>
(d)	H	OCH <sub>3</sub>	OH
(e)	OCH <sub>3</sub>	H	H

R=NO<sub>2</sub>

	R <sub>1</sub>	R <sub>2</sub>	R <sub>3</sub>
(f)	H	H	H
(g)	H	H	OCH <sub>3</sub>
(h)	H	H	N(CH <sub>3</sub> ) <sub>2</sub>
(i)	H	OCH <sub>3</sub>	OH
(j)	OCH <sub>3</sub>	H	H

R=Cl

	R <sub>1</sub>	R <sub>2</sub>	R <sub>3</sub>
(k)	H	H	H
(l)	H	H	OCH <sub>3</sub>
(m)	OCH <sub>3</sub>	H	H
(n)	OH	H	H

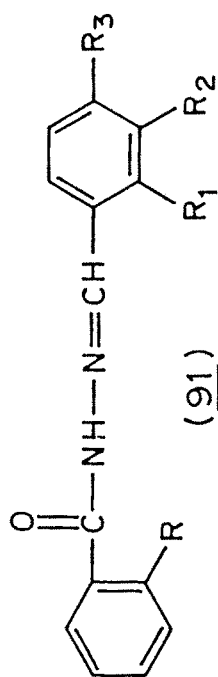
R=OH

	R <sub>1</sub>	R <sub>2</sub>	R <sub>3</sub>
(o)	H	H	H
(p)	OH	H	H
(q)	OCH <sub>3</sub>	H	H
(r)	H	H	OCH <sub>3</sub>
(s)	NO <sub>2</sub>	H	H

R=OCH<sub>3</sub>

	R <sub>1</sub>	R <sub>2</sub>	R <sub>3</sub>
(t)	H	H	H
(u)	OH	H	H
(v)	OCH <sub>3</sub>	H	H
(w)	H	H	OCH <sub>3</sub>
(x)	NO <sub>2</sub>	H	H

TABLE I - ANALYTICAL DATA, MELTING POINTS AND YIELDS OF SCHIFF BASES (9I)



Compd. No.	R	R <sub>1</sub>	R <sub>2</sub>	R <sub>3</sub>	Elemental Analysis* % C	H	N	Melting points °C	Yields %
(9Ia)	H	H	H	H	75.24 (75.00)	5.50 (5.35)	12.80 (12.5)	206-7 <sup>169</sup> 204-5 <sup>169</sup>	65
(9Ib)	H	H	H	OCH <sub>3</sub>	71.18 (70.88)	5.88 (5.5)	12.00 (11.70)	154.5 <sup>5</sup> 154 <sup>16</sup>	60
(9Ic)	H	H	H	H(CH <sub>3</sub> ) <sub>2</sub>	70.7 (71.9)	6.6 (6.37)	15.4 (15.7)	189.9 <sup>169</sup> (190) <sup>169</sup>	53
(9Id)	H	H	OCH <sub>3</sub>	OH	66.4 (66.67)	5.56 (5.19)	9.99 (10.37)	189 <sup>169</sup> (208) <sup>169</sup>	49
(9Ie)	H	OCH <sub>3</sub>	H	H	70.79 (70.86)	5.61 (5.5)	12.3 (11.02)	188.189 <sup>169</sup> (188.89) <sup>169</sup>	90
(9If)	NO <sub>2</sub>	H	H	H	62.1 (62.45)	4.3 (4.09)	15.5 (15.61)	151.152	53
(9Ig)	NO <sub>2</sub>	H	H	CH <sub>3</sub>	60.48 (60.2)	4.58 (4.34)	14.43 (14.04)	159.60	60
(9Ih)	NO <sub>2</sub>	H	H	N(CH <sub>3</sub> ) <sub>2</sub>	61.56 (61.53)	5.42 (5.13)	17.86 (17.94)	177	55
(9Ii)	NO <sub>2</sub>	H	OCH <sub>3</sub>	OH	63.34 (63.6)	4.41 (4.59)	14.68 (14.8)	125.127	51
(9Ij)	NO <sub>2</sub>	OCH <sub>3</sub>	H	H	60.5 (60.2)	4.36 (4.34)	14.3 (14.04)	160.62	62
(9Ik)	Cl	H	H	H	65.12 (65.00)	4.2 (4.26)	10.53 (10.83)	180.83	64
(9Il)	Cl	H	H	OCH <sub>3</sub>	62.15 (62.4)	4.50 (4.51)	9.68 (9.71)	170.72	61

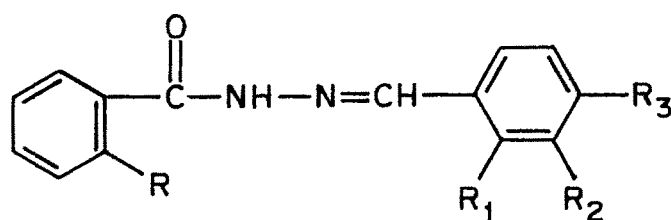
.....Contd.

TABLE I (Contd.)

(9Im)	Cl	OCH <sub>3</sub>	H	H	62.35 (62.4)	4.52 (4.51)	9.68 (9.71)	160.61	63
(9In)	Cl	OH	H	H	61.32 (61.21)	4.08 (4.01)	10.10 (10.20)	156.57	65
(9Io)	OH	H	H	H	69.82 (70.00)	5.1 (5.0)	11.3 (11.67)	248-49 (249-50) <sup>169</sup>	70
(9Ip)	OH	OH	H	H	65.39 (65.63)	4.7 (4.69)	10.81 (10.94)	280-81 (282-83) <sup>169</sup>	61
(9Iq)	OH	OCH <sub>3</sub>	H	H	66.38 (66.67)	5.25 (5.19)	10.28 (10.37)	265	53
(9Ir)	OH	H	H	OCH <sub>3</sub>	66.59 (66.67)	5.23 (5.18)	10.17 (10.37)	221	62
(9Is)	OH	NO <sub>2</sub>	H	H	58.6 (58.45)	3.85 (3.86)	14.68 (14.73)	232	51
(9It)	OCH <sub>3</sub>	H	H	H	70-71 (70.86)	5.52 (5.5)	11.10 (11.02)	245-46	58.2
(9Iu)	OCH <sub>3</sub>	OH	H	H	66.52 (66.67)	5.2 (5.18)	10.2 (10.37)	271-272	55.1
(9Iv)	OCH <sub>3</sub>	OCH <sub>3</sub>	H	H	67.5 (67.6)	5.4 (5.6)	16.69 (16.9)	270	48.2
(9Iw)	OCH <sub>3</sub>	H	H	OCH <sub>3</sub>	67.51 (67.6)	15.50 (15.6)	16.82 (16.9)	265-68	40
(9Ix)	OCH <sub>3</sub>	NO <sub>2</sub>	H	H	60.21 (60.2)	4.21 (4.34)	14.12 (14.04)	280-83	43
(93a)					81.58 (81.63)	8.68 (8.89)	9.41 (9.52)	100-125/ 15 mm	80
(93b)					86.18 (86.15)	6.55 (6.66)	7.38 (7.17)	125-140/ 15 mm	85
(99)	-	-	-	-	72.13 72.28	4.38 4.41	16.68 16.86	121-21	60

\*Figures in the bracket indicate the % required analysis.

TABLE 2  
IR DATA OF SCHIFF BASES (9I) IN NUJOL



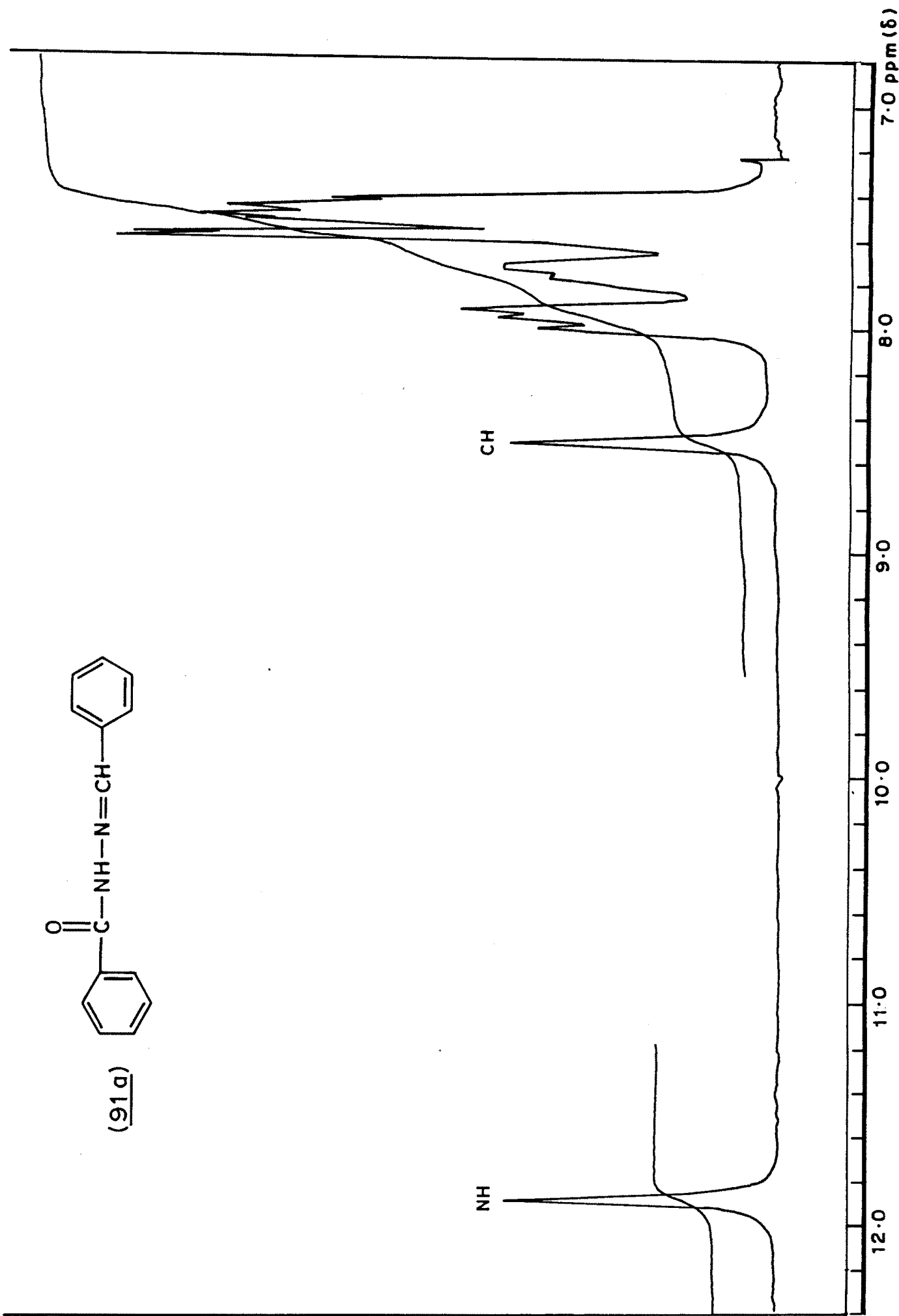
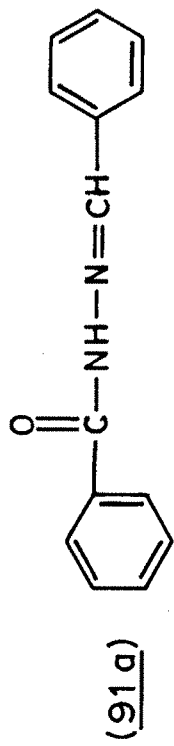
(9I)

Compound No.	R	R <sub>1</sub>	R <sub>2</sub>	R <sub>3</sub>	C=O cm <sup>-1</sup>	N=C cm <sup>-1</sup>	NH cm <sup>-1</sup>
(9Ia)	H	H	H	H	1052	1670	3275
(9Ib)	H	H	H	OCH <sub>3</sub>	1650	1620	3200
(9Ic)	H	H	H	N(CH <sub>3</sub> ) <sub>2</sub>	1652	1620	3250
(9Id)	H	H	OCH <sub>3</sub>	OH	1655	1620	3200
(9Ie)	H	OCH <sub>3</sub>	H	H	1653	1620	3280
(9If)	NO <sub>2</sub>	H	H	H	1660	1620	3270
(9Ig)	NO <sub>2</sub>	H	H	OCH <sub>3</sub>	1680	1620	3170
(9Ih)	NO <sub>2</sub>	H	H	N(CH <sub>3</sub> ) <sub>2</sub>	1645	1600	3200
(9Ii)	NO <sub>2</sub>	H	OCH <sub>3</sub>	OH	1650	1620	3170
(9Ij)	NO <sub>2</sub>	OCH <sub>3</sub>	H	H	1650	1625	3280
(9In)	Cl	OH	H	H	1640	1620	3170
(9Io)	OH	H	H	H	1640	1620	3250
(9Ip)	OH	OH	H	H	1640	1620	3250
(9Iq)	OH	OCH <sub>3</sub>	H	H	1640	1620	3200
(9Is)	OH	NO <sub>2</sub>	H	H	1640	1620	3200
(9It)	OCH <sub>3</sub>	H	H	H	1640	1620	3240
(9Iu)	OCH <sub>3</sub>	OH	H	H	1640	1620	3250
(9Iv)	OCH <sub>3</sub>	OCH <sub>3</sub>	H	H	1640	1620	3250

The NMRs of all the Schiff bases (91) show a sharp singlet in the range of 8.4 to 8.5  $\delta$ . This singlet is of the proton on the carbon atom attached to the nitrogen atom. Again the disappearance of  $\text{NH}_2$  signal in the Schiff base (91) at 4.5  $\delta$  which is present in the hydrazides (90) also shows that  $-\text{NH}_2$  in hydrazides has been completely transformed to azomethine (C=N). The NH in hydrazide appears at about 9.5  $\delta$ . But when the hydrazide is converted to corresponding Schiff base, the same -NH appears at 11.8 to 11.9  $\delta$ . All these spectral data and the analytical data confirm that the Schiff bases have been formed. The representative NMR spectrum of Schiff base (91a) is shown in Figure 1.

In order to compare the Schiff bases of hydrazides with those of Schiff bases of amines, we have prepared the Schiff bases (93) of benzaldehyde and propanaldehyde with benzyl amine (92) (Chart 15A) and a Schiff base (99) of benzaldehyde with N-amino quinazolinone (98). The Schiff bases of benzaldehyde and amines showed the presence of C=N at  $1640 \text{ cm}^{-1}$ . This is in the little higher frequency region (about  $20 \text{ cm}^{-1}$ ) as compared to the Schiff bases of hydrazides. The Schiff base of N-amino quinazolinone showed the presence of C= at  $1630 \text{ cm}^{-1}$  and CO at  $1670 \text{ cm}^{-1}$ .

The NMR of the Schiff base (93a) shows methyl and methylene protons at 1  $\delta$  (t) and 2.33  $\delta$  (q) benzylic proton at 4.5  $\delta$ . CH=N at 7.7  $\delta$  and aromatic protons 7.5  $\delta$  (Table 3). The NMR of the Schiff base (93b) Figure 2, shows the presence of benzylic proton at 4.8  $\delta$  (singlet) while Ph-CH at 8.3  $\delta$  (singlet) and aromatic protons in the range of 7.23 to 7.8  $\delta$ .



141

FIGURE 1

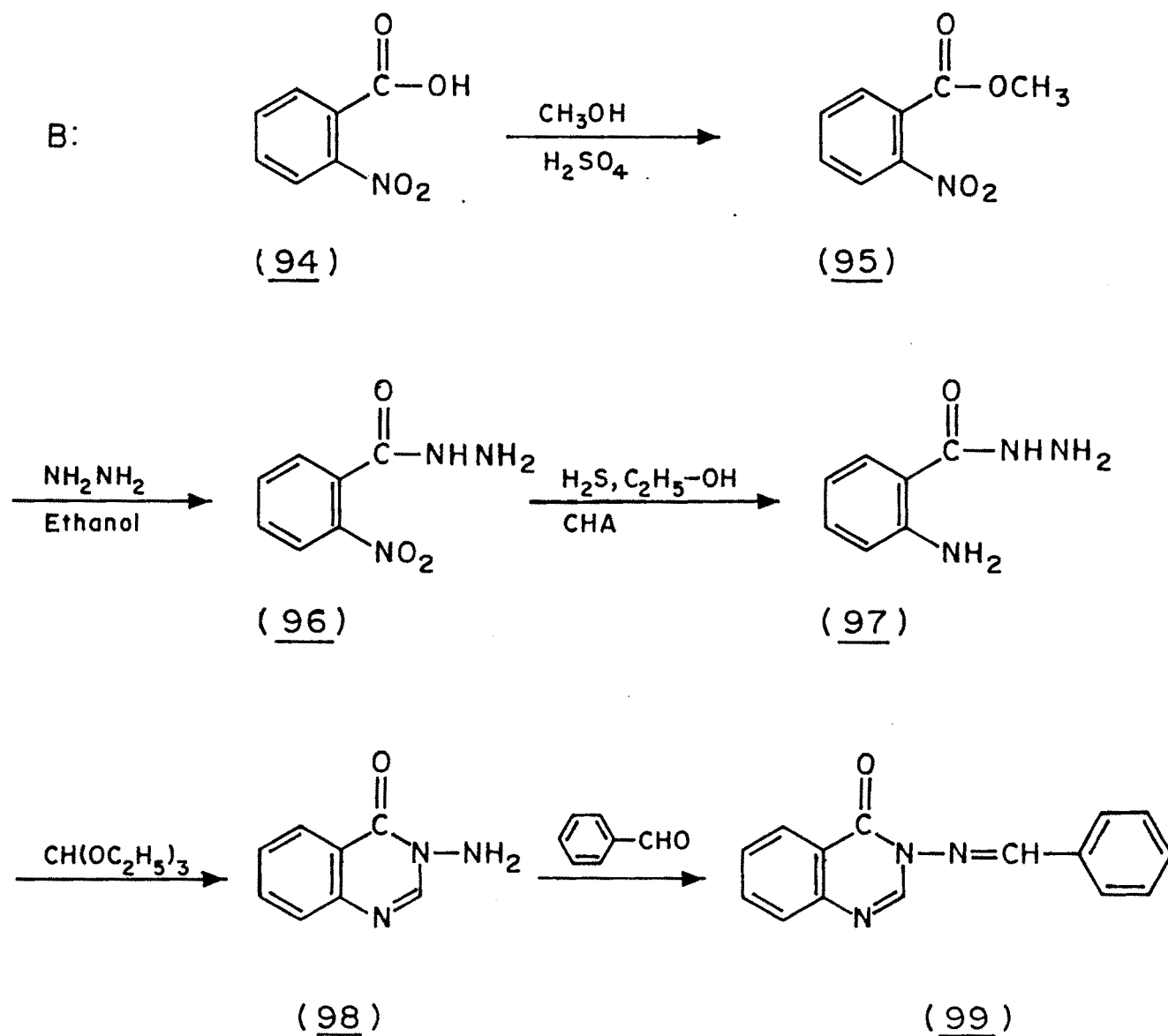
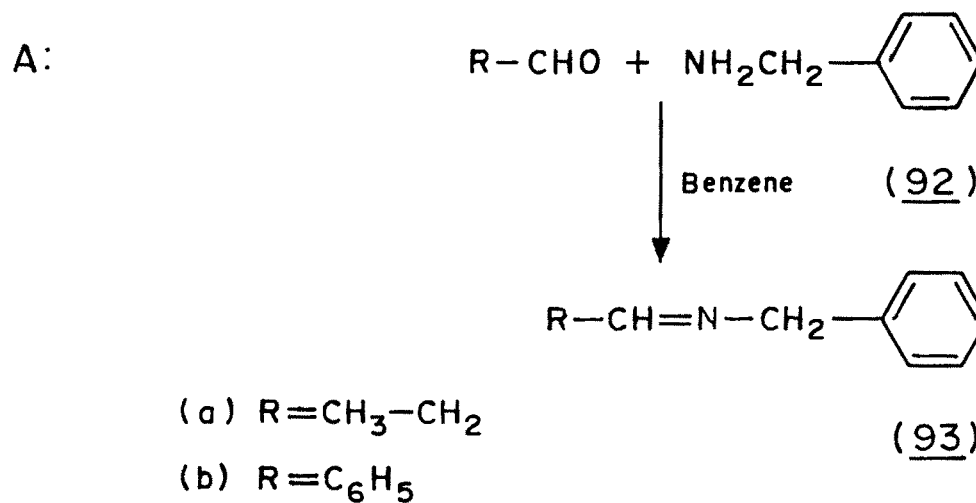
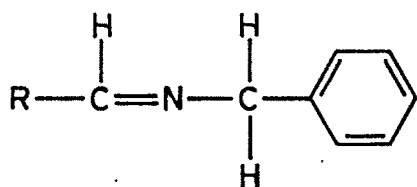


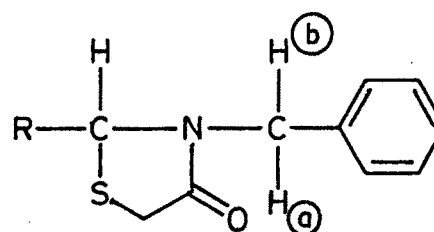
TABLE 3  
 NMR DATA OF SCHIFF BASES AND SUBSTITUTED 4-THIAZOLIDINONES (93) AND  
 (101) IN  $\text{CDCl}_3$



(93)

a)  $\text{R} = \text{CH}_3\text{CH}_2-$

b)  $\text{R} = -\text{Ph}$



(101)

a)  $\text{R} = \text{CH}_3-\text{CH}_2-$

b)  $\text{R} = -\text{Ph}$

Compound No.	R	Benzylic $\text{CH}_2$ ( $\delta$ ) <sup>2</sup>	Aromatic protons ( $\delta$ )	Methine $\text{CH}$ ( $\delta$ )	$\text{CH}_3$ ( $\delta$ )	$\text{CH}_2$ ( $\delta$ )	$\text{SCH}_2$ ( $\delta$ )
( <u>93a</u> )	$\text{CH}_3\text{CH}_2$	4.5	7.5	7.7	1(t)	2.33 (q)	-
( <u>93b</u> )	$\text{C}_6\text{H}_5$	4.8	7.3 - 7.8	8.3	-	-	-
( <u>101a</u> )	$\text{CH}_3\text{CH}_2$	$\text{H}_b$ 3.33 $\text{H}_a$ 5.13	6.96 - 7.44	5.33	-	-	3.8
( <u>101b</u> )	$\text{C}_6\text{H}_5$	$\text{H}_b$ 4 $\text{H}_a$ 5.13	7	4.5(t)	Org(t)	1.77 (q)	3.7



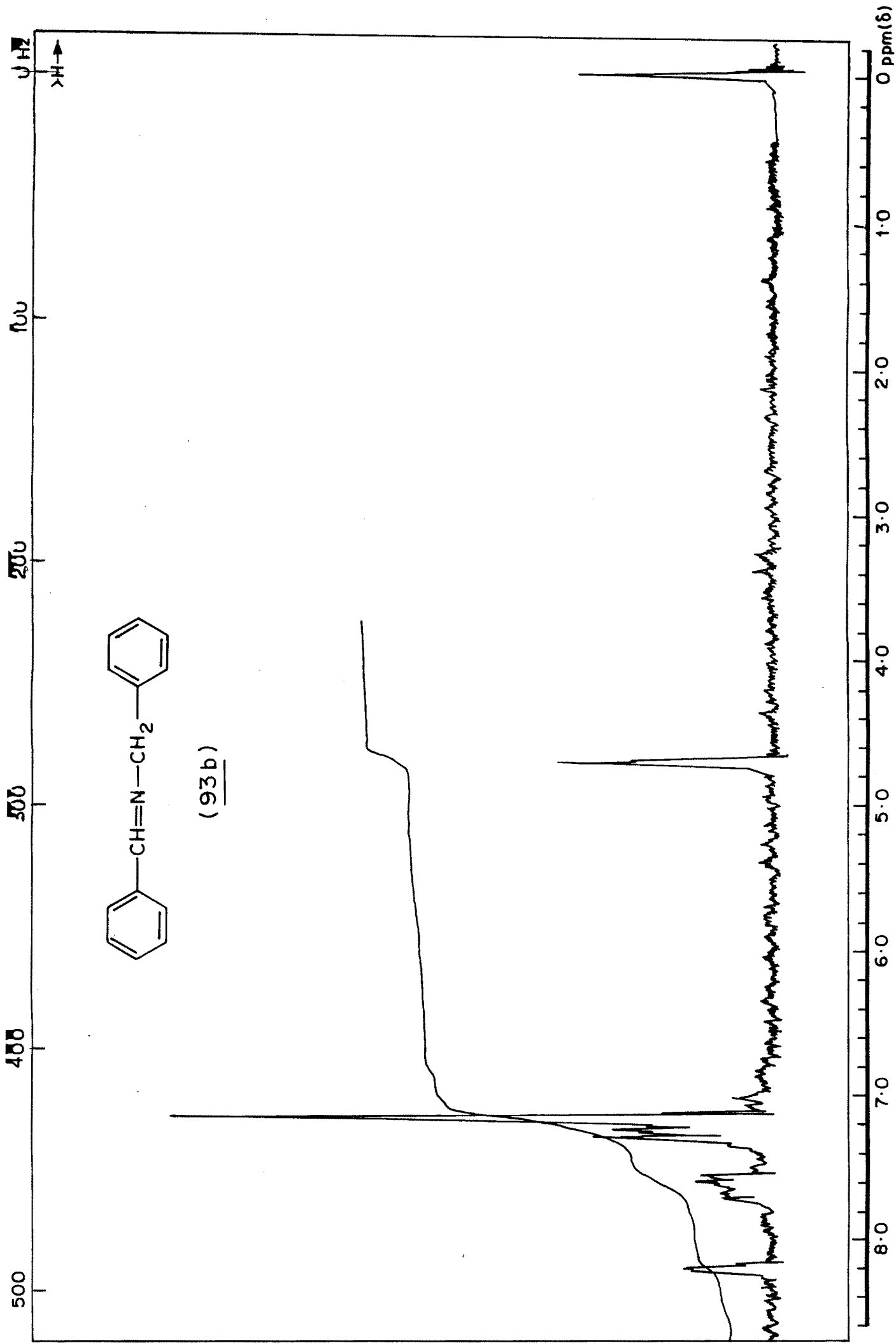
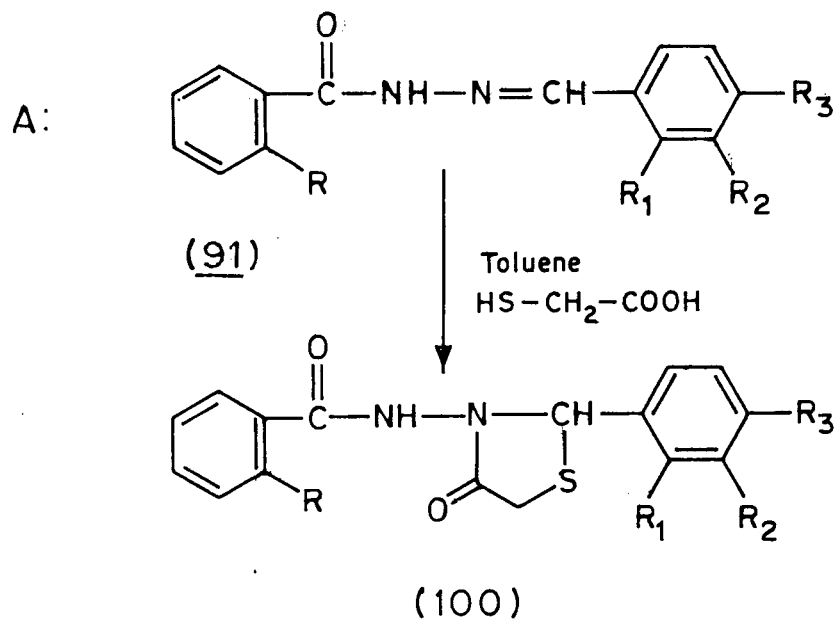


FIGURE 2

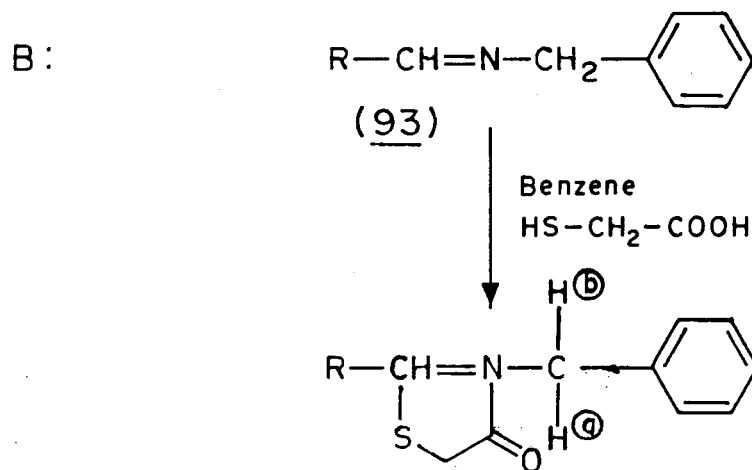
Schiff base (99) was obtained from *o*-nitrobenzoic acid (94) which was converted to its corresponding ester (95) by treatment with methanol and sulphuric acid. The ester (95) was then on treatment with hydrazine hydrate afforded corresponding hydrazide (96) which in turn on treatment with hydrogen sulphide in methanol using cyclohexyl amine as a catalyst gave hydrazide (97). N-amino-quinazoline (98) was then obtained by reacting hydrazide (97) with ethyl ortho formate. N-aminoquinazoline (98) on condensation with benzaldehyde afforded corresponding Schiff base (99).

Our aim was to study the antitubercular activity of the 4-thiazolidinones and study the structure function activity relationship and hence we converted about 16 Schiff bases to the corresponding 4-thiazolidinones (101) (Chart 16) by refluxing a mixture of Schiff bases (91) and thioglycolic acid either in benzene or in toluene for 8 hrs using Dean-Stark apparatus to remove water formed during the reaction azeotropically. Use of water separator (Dean-Stark) is advantageous to follow the rate of reaction by the volume of water collected.

The reaction is believed to take place by the intermediate formation of an aldimine or . . . . . The reaction proceeds by the attack of mercaptoacetic acid upon the C=N group with the -S-CH<sub>2</sub>COOH adding to the carbon atom, followed by the capture of a proton by nitrogen and subsequent cyclization. The effects of electrophilic and nucleophilic substituents on the positive character of the carbon atom or the -ve character / of the nitrogen atom of the azomethine linkage and therefore on the susceptibility of the carbon to nucleophilic attack by the anion



<u>R=H</u>			<u>R=NO<sub>2</sub></u>			<u>R=Cl</u>		
R <sub>1</sub>	R <sub>2</sub>	R <sub>3</sub>	R <sub>1</sub>	R <sub>2</sub>	R <sub>3</sub>	R <sub>1</sub>	R <sub>2</sub>	R <sub>3</sub>
(a) H	H	H	(f) H	H	H	(k) H	H	H
(b) H	H	OCH <sub>3</sub>	(g) H	H	OCH <sub>3</sub>	(l) H	H	OCH <sub>3</sub>
(c) H	H	N(CH <sub>3</sub> ) <sub>2</sub>	(h) H	H	N(CH <sub>3</sub> ) <sub>2</sub>	(m) OCH <sub>3</sub>	H	H
(d) H	OCH <sub>3</sub>	OH	(i) H	OCH <sub>3</sub>	OH	(n) OH	H	H
(e) OCH <sub>3</sub>	H	H	(j) OCH <sub>3</sub>	H	H			



- (a) R=Ph  
(b) R=CH<sub>3</sub>CH<sub>2</sub>

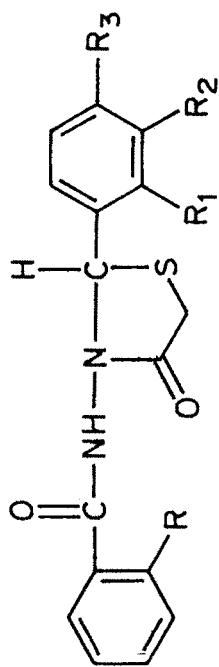
of mercaptoacetic acid are evident in the yield of the 4-thiazolidinones<sup>167,168</sup>.

The analytical data, m.ps and yield of the thiazolidinones prepared are summarised in Table 4.

The IR of all the 4-thiazolidinones (Table 5) have shown the absence of absorption band at  $1620\text{ cm}^{-1}$  corresponding to C=N. This clearly has shown that addition of thioglycolic acid has taken place. Similarly there are two absorption bands in the range of  $1640\text{-}50\text{ cm}^{-1}$  and  $1690\text{-}1710\text{ cm}^{-1}$ . After comparing the IR with corresponding Schiff bases one can assign the absorption band in the range of  $1640\text{-}1650\text{ cm}^{-1}$  to the amide -NH and the peak in the range  $1690\text{ - }1710\text{ cm}^{-1}$  to the carbonyl group of 4-thiazolidinone ring. All the 4-thiazolidinones have shown the presence of -NH also. The 4-thiazolidinones (101) (Chart 16B) obtained from Schiff bases (93) showed the presence of keto in 4-thiazolidinone ring at  $1670\text{ cm}^{-1}$ . This absorption band is at lower frequency region (about  $30\text{ cm}^{-1}$ ) as compared with the 4-thiazolidinones (100). All the 4-thiazolidinones have shown their characteristic peaks of S-CH<sub>2</sub>, S-CH and -NH in the NMR spectrum (Table 6). S-CH<sub>2</sub> has appeared at 3.6-3.8. But this is not a sharp singlet. This may be due to the non-equivalence of two protons of CH<sub>2</sub> in the 4-thiazolidinone ring and they are coupling each other. S-CH has appeared in the range of 5.7 to 5.9 only in the case of (100k) and (100l) (where there is chlorine in the ortho position in the benzoic acid moiety) this S-CH has appeared at 6.1 and 6.2.

All the NH have appeared in the range of 10.7 to 10.9

TABLE 4 - ANALYTICAL DATA, MELTING POINTS AND YIELDS OF THE SUBSTITUTED 4-THIAZOLIDINONES (100)



(100)

Compd. No.	R	R <sub>1</sub>	R <sub>2</sub>	R <sub>3</sub>	Elemental Analysis* %	Melting points °C	Yields %		
					C H N				
(100a)	H	H	H	H	66.68 (64.42)	4.69 (4.62)	9.15 (9.39)	177	51.2
(100b)	H	H	H	OCH <sub>3</sub>	62.02 (62.19)	5.17 (4.87)	8.83 (9.25)	160	50
(100c)	H	H	H	H(CH <sub>3</sub> ) <sub>2</sub>	63.25 (63.34)	5.89 (5.57)	11.33 (12.3)	198-99	41.2
(100d)	H	H	OCH <sub>3</sub>	OH	58.65 (59.3)	5.06 (4.65)	8.33 (8.14)	183-184	43.3
(100e)	H	OCH <sub>3</sub>	H	H	62.2 (62.19)	4.61 (4.87)	8.66 (8.51)	167-168	35.4
(100f)	NO <sub>2</sub>	H	H	H	55.98 (55.97)	3.6 (3.24)	12.63 (12.24)	245	61.0
(100g)	NO <sub>2</sub>	H	H	OCH <sub>3</sub>	54.38 (54.69)	4.2 (4.02)	11.01 (11.26)	176-77	55.0
(100h)	NO <sub>2</sub>	H	H	N(CH <sub>3</sub> ) <sub>2</sub>	55.95 (55.95)	4.68 (4.66)	14.98 (14.58)	195	38.3
(100i)	NO <sub>2</sub>	H	OCH <sub>3</sub>	OH	52.11 (52.44)	3.68 (3.85)	10.6 (10.8)	211-33	40.2
(100j)	NO <sub>2</sub>	OCH <sub>3</sub>	H	H	55.01 (54.8)	3.9 (4.02)	11.4 (11.26)	220	35.1
(100k)	Cl	H	H	H	58.19 (58.09)	4.2 (4.25)	8.89 (8.8)	208-10	49.5

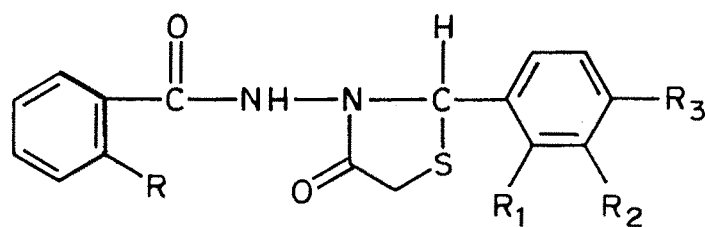
.....Contd.

TABLE 4(Contd.)

(100l)	Cl	H	H	H	OCH <sub>3</sub>	56.25 (56.35)	4.10 (4.14)	7.68 (7.73)	202-3	50.0
(100m)	Cl	OCH <sub>3</sub>	H	H	H	56.72 (56.35)	4.2 (4.14)	7.5 (7.73)	207-8	35.30
(100n)	Cl	OH	H	H	H	55.2 (55.09)	3.60 (3.73)	7.08 (8.03)	215-16	38.1
(100o)	OH	H	H	H	H	61.12 (61.14)	4.69 (4.46)	8.81 (8.91)	204-5	38
(100p)	OH	H	H	H	OCH <sub>3</sub>	59.15 (59.47)	4.21 (4.37)	18.32 18.16	250	40

\*Figures in the bracket indicate the % required analysis.

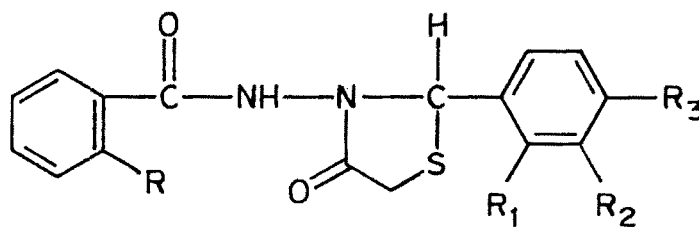
TABLE 5  
IR DATA OF SUBSTITUTED 4-THIAZOLIDINONES (100)



(100)

Compound No.	R	R <sub>1</sub>	R <sub>2</sub>	R <sub>3</sub>	C=O cm <sup>-1</sup>	C=O cm <sup>-1</sup>	NH cm <sup>-1</sup>
(100a)	H	H	H	H	1650	1710	3250
(100b)	H	H	H	OCH <sub>3</sub>	1640	1710	3200
(100c)	H	H	H	N(CH <sub>3</sub> ) <sub>2</sub>	1640	1710	3200
(100d)	H	H	OCH <sub>3</sub>	OH	1650	1680	3100
(100e)	H	OCH <sub>3</sub>	H	H	1650	1710	3250
(100f)	NO <sub>2</sub>	H	H	H	1630	1690	3240
(100g)	NO <sub>2</sub>	H	H	OCH <sub>3</sub>	1650	1720	3370
(100h)	NO <sub>2</sub>	H	H	N(CH <sub>3</sub> ) <sub>2</sub>	1650	1700	3140
(100i)	NO <sub>2</sub>	H	OCH <sub>3</sub>	OH	1650	1700	3100
(100j)	NO <sub>2</sub>	OCH <sub>3</sub>	H	H	1660	1690	3170
(100k)	Cl	H	H	H	1640	1710	3200
(100l)	Cl	H	H	OCH <sub>3</sub>	1645	1720	3250

TABLE 6  
NMR DATA OF SUBSTITUTED 4-THIAZOLIDINONES (100) IN DMSO(D<sub>6</sub>)



(100)

Compound No.	R	R <sub>1</sub>	R <sub>2</sub>	R <sub>3</sub>	SCH <sub>2</sub> (δ)	S-CH (δ)	OCH <sub>3</sub> (δ)	Aromatic protons (δ)	NH (δ)
(100a)	H	H	H	H	3.84	5.76	-	7.2 - 7.8	10.65
(100b)	H	H	H	OCH <sub>3</sub>	3.8	5.9	3.7	6.8-7.86	10.56
(100d)	H	H	OCH <sub>3</sub>	OH	3.6	5.7	3.7	6.6-7.7	10.5
(100e)	H	OCH <sub>3</sub>	H	H	3.63	5.68	3.76	6.7-7.8	10.3
(100f)	NO <sub>2</sub>	H	H	H	3.9	5.9	-	7.3-8.18	10.98
(100g)	NO <sub>2</sub>	H	H	OCH <sub>3</sub>	3.85	5.76	3.75	6.75-8.12	10.9
(100j)	NO <sub>2</sub>	OCH <sub>3</sub>	H	H	3.5	5.7	3.72	6.7-7.75	10.5
(100k)	Cl	H	H	H	3.8	6.2	-	6.9-7.56	10.8
(100l)	Cl	H	H	OCH <sub>3</sub>	3.7	6.1	3.73	6.78-7.6	10.9



The representative NMRs of 4-thiazolidinones are shown in Figures 3,4 and 5 respectively. The 4-thiazolidinones (101) showed little abnormal NMR spectra. S-CH<sub>2</sub> showed its appearance at 3.7 and 3.8 respectively (Table 3).

Here also S-CH<sub>2</sub> is not sharp singlet because of non-equivalence of 2 protons in methylene in the thiazolidinone ring. All other peaks are in the appropriate form in the appropriate positions, but in case of benzylic -CH<sub>2</sub> it is not showing singlet. In case of compound (101a) (Figure 6) NMR has shown two sets of doublets at 3.33 and 5.13. The J-value for these two sets is 14 cps. This indicates that two benzylic protons are non-equivalent and they are coupling with each other. This non-equivalence arises due to the asymmetric carbon present in the system. The large shift observed for these protons can be explained on the basis of magnetic anisotropy of C=O group present at  $\beta$ -position. A careful observation indicates that the inner lines in each doublet are more intense than the outer-ones. This clearly shows that these two doublets have their origin in two protons which are mutually coupled. The geminal coupling observed (J = 14 cps) confirm this finding.

Similar case has been also observed in case of (101b) (Figure 7). There also benzylic protons show two sets of doublets at 4.0 and 5.13 . All other peaks are at appropriate positions.

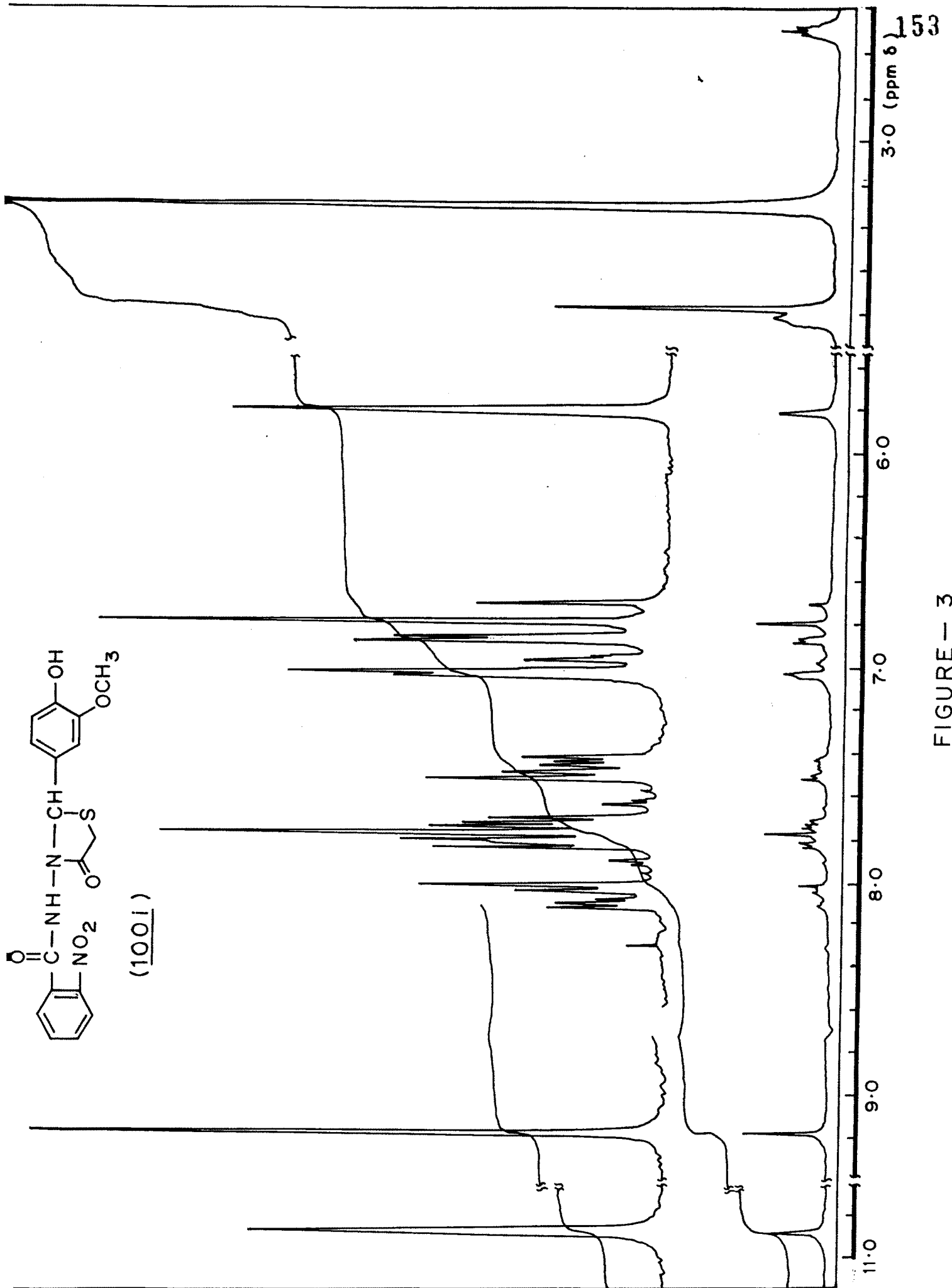


FIGURE - 3

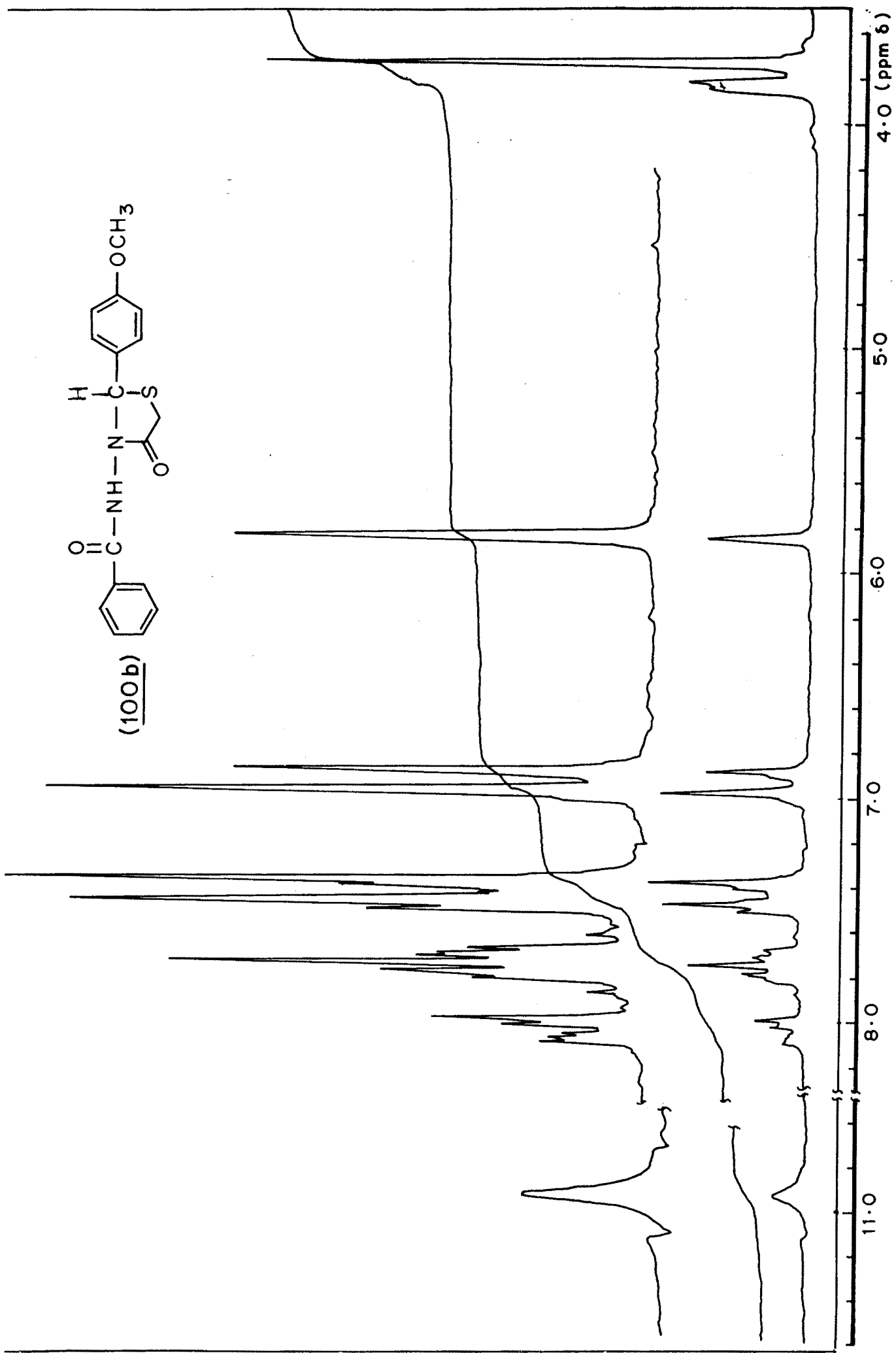


FIGURE - 4

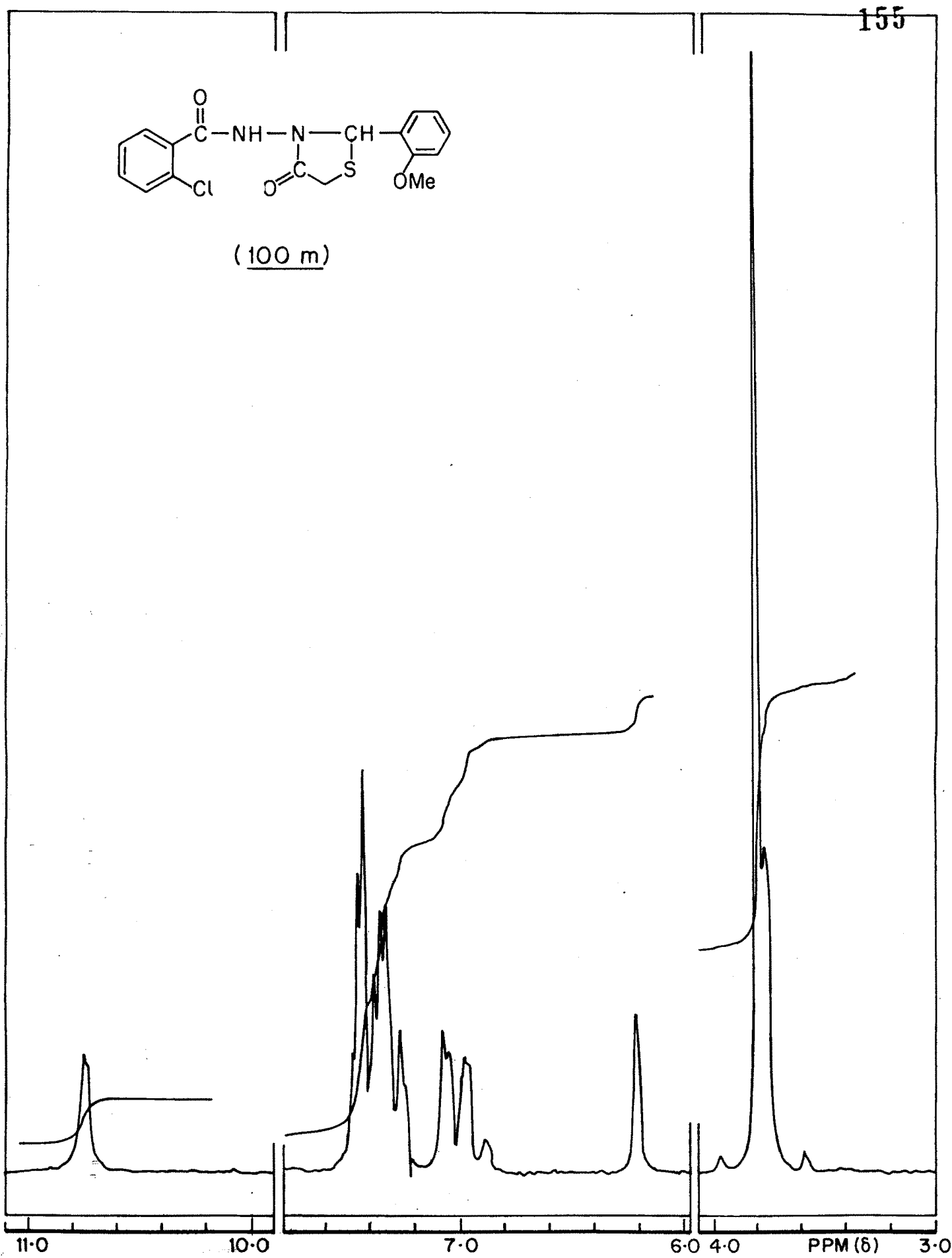


FIGURE 5

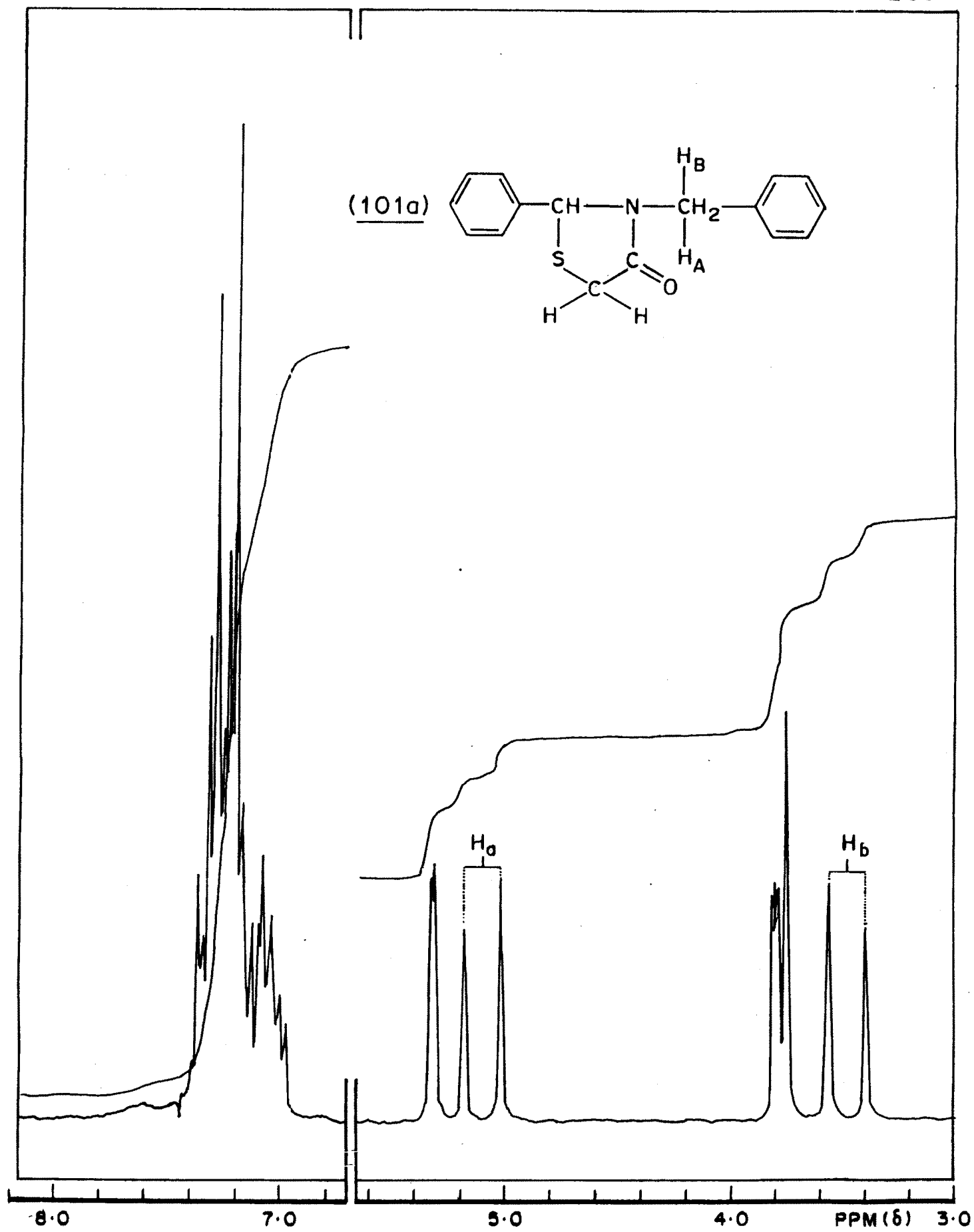


FIGURE 6



## BIOLOGICAL RESULTS AND DISCUSSION

### Method of in vitro antituberculosis screening

In vitro antitubercular testing was carried out against human virulent strain of Mycobacterium tuberculosis (H<sub>37</sub>Rv) by the method of Doubt and Youmans. To sterile Youman's basal medium (3.9 to 4.35 ml as required to give a final volume of 5.0 ml) dispensed in borosilicate test-tubes (150 x 20 mm), was added 0.5 ml of sterile normal horse serum inactivated by heating at 56°C for 30 minutes.

The compounds under test were dissolved in suitable solvents such as dilute HCl, EtOH, etc. and added in the form of solution in such a way as to give final concentrations of 200, 100, 50, 25, 12.5 etc.

The inoculum consisted of 0.1 ml of standardized suspension of M.tuberculosis (H<sub>37</sub>Rv) containing 10<sup>6</sup> viable bacilli/ml. The tubes were incubated at 37°C for 21 days and then examined for the presence or absence of the growth of the test organism. The lowest concentration which showed no visible growth was taken as the end point.

### Discussion on Anti-tubercular Activity of Substituted 4-Thiazolidinones

Ten compounds were synthesised and screened for their in vitro antituberculosis activity against M.tuberculosis (H<sub>37</sub>Rv strain).

Schiff base (99) of benzaldehyde and N-aminoquinazolone (98) has shown antitubercular activity at 200 g/ml, below this concentration it does not show any activity (Table 7).

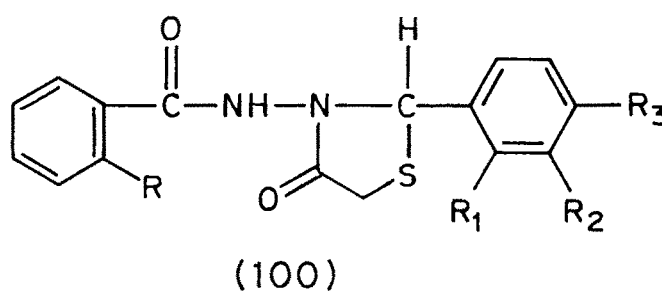
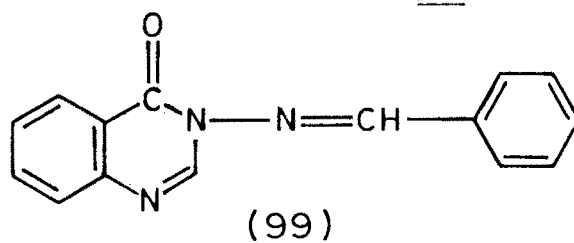
Out of nine remaining substituted 4-thiazolidinones (100a), (100b), (100k) and (100p) have shown no activity at 200  $\mu\text{g/ml}$ . (100r) has shown antitubercular activity at 200  $\mu\text{g/ml}$  but it does not show any activity below 200  $\mu\text{g/ml}$ . Compounds (100f), (100i), (100o) have shown anti-T.B. activity against M. Tuberculosis at 100  $\mu\text{g/ml}$ , below this concentration they did not show any activity. Only compound (100c) which has methoxy group on the ortho position of aldehyde moiety has shown anti-T.B. activity at 50  $\mu\text{g/ml}$ .

By comparing (100a), (100b) and (100c) one can say that when there is no substituent in either benzamide moiety or in the benzaldehyde moiety it shows no activity upto 200  $\mu\text{g/ml}$ . But the insertion of methoxy group in the ortho position in the benzaldehyde group has shown better activity.

Observations of (100b), (100l) and (100p) showed that when methoxy group is in the para position in the benzaldehyde moiety activity is less. Table 7 has represented the anti-tubercular activity of Schiff base (99) and substituted 4-thiazolidinones (100).



TABLE 7 - ANTITUBERCULAR ACTIVITY OF SCHIFF BASE (99) AND SUBSTITUTED 4-THIAZOLIDINONES (100)



Compound No.	R	R <sub>1</sub>	R <sub>2</sub>	R <sub>3</sub>	Anti-T.B. activity in /g/ml	Solvent	Remarks
(99)	-	-	-	-	200	DMF	Below 200 $\mu$ g/ml. No activity
(100a)	H	H	H	H	-	DMF	Inactive at 200 $\mu$ g/ml
(100b)	H	H	H	OCH <sub>3</sub>	-	DMF	Inactive at 200 $\mu$ g/ml
(100e)	H	OCH <sub>3</sub>	H	H	50	DMF	Below this concentration, no activity
(100f)	NO <sub>2</sub>	H	H	H	100	DMF	Below this concentration, no activity
(100i)	NO <sub>2</sub>	H	OCH <sub>3</sub>	OH	100	DMF	Below this concentration, no activity.
(100k)	Cl	H	H	H	-	DMF	Inactive at 200 $\mu$ g/ml
(100l)	Cl	H	H	OCH <sub>3</sub>	200	DMF	Below 200 $\mu$ g/ml, no activity.
(100o)	OH	H	H	H	100	DMF	Below this concentration, no activity.
(100p)	OH	H	H	OCH <sub>3</sub>	-	DMF	Inactive at 200 $\mu$ g/ml

---

SECTION-C

---

## EXPERIMENTAL

General procedures for the syntheses of esters, hydrazides, Schiff bases and 4-thiazolidinones are given below. The data of individual compound is summarised in Tables 1 to 6.

### Syntheses of Substituted benzoic acid esters (89,95)

Ortho-substituted benzoic acid (88) (0.02 mole) was dissolved in methanol (125 ml) and sulphuric acid (25 ml) was added dropwise through the dropping funnel at room temperature in half an hour.

The reaction mixture was refluxed on water bath for six hrs. The solvent, methanol, was distilled off and poured in water (200 ml).

The reaction mixture was then neutralized by sodium carbonate solution (10%). The separated product was then extracted with ethyl acetate three times. The combined ethyl acetate solution was dried over sodium sulphate and solvent was distilled off. Obtained product was purified by distillation under vacuum.

### Syntheses of hydrazides (90,96)

A mixture of *o*-substituted methylbenzoate (89) (0.02 mole) and hydrazine hydrate (80) (3 ml per g. of the ester) was refluxed in methanol (200 ml) for 2-3 hrs. Solvent was concentrated and cooled.

Crude solid obtained was filtered, dried and crystallized from methanol.

### Syntheses of substituted Schiff bases (91)

A mixture of *o*-substituted benzoic acid hydrazide (0.02 mole) and substituted benzaldehyde (0.02 mole) was refluxed together in ethanol for 5-6 hrs. Ethanol was distilled off and residual solid was crystallized from ethanol. Yields, m.ps and analytical data are given

in Table I and IR data are summarised in Table 2.

#### **Synthesis of Schiff bases (93)**

A mixture of aldehyde (0.02 mole) and benzylamine (0.02 mole) was refluxed in benzene (150 ml) for 8 hrs using Dean-Stark apparatus for the removal of water formed during the reaction. The reaction mixture was cooled and dried over sodium sulphate. Benzene was removed under vacuum. The residual liquid was purified by bulb-tube distillation under vacuum. The first fraction which distilled out at 80-100°C/15 mm was found to be a mixture of unreacted aldehyde and amine. Second fraction distilled out in the range of 130-150°/15mm. This fraction was the required schiff base. The analytical data, b.ps. and yield of individual compound are given in Table I and NMR data is summarised in Table 3 and IR data is discussed on page 140.

#### **Reduction of o-nitrobenzoyl hydrazide (96) with hydrogen sulphide**

Ortho-nitrobenzoyl hydrazide (96) (1.81 g, 0.01 mole) was dissolved in ethyl alcohol and cyclohexylamine (0.98 g slight excess than 0.01 mole) was added as a catalyst. Hydrogen sulphide was bubbled through the reaction mixture for 8-10 hrs at 40-50°. The completion of the reaction was followed by polarographic method for the absence of o-nitrobenzoyl hydrazide in the reaction mixture. The reaction mixture was cooled and the side product sulphur (2.0 g) formed during the reaction was filtered. The solvent from the mother liquor was distilled off. The semisolid mass obtained was purified by column chromatography on silica gel using benzene:methanol (80:20) as an eluent. Crude anthranilic acid hydrazide obtained by column chromatography was crystallized

from benzene-methanol mixture (80:20) to yield brownish white crystals (0.75 g, 41.4%) m.p. 120-21°.

#### Synthesis of 3-amino-4(3H)quinazolone (98)

3-Amino-4(3H)quinazolone (98) was prepared by the condensation of anthranilic acid hydrazide with ethyl orthoformate by following the procedure described in the literature. m.p. 203-204° (reported 204°).

#### Synthesis of Schiff base (99)

3-Amino-4(3H)quinazolone (98) (1.67 g, 0.01 mole) and benzaldehyde (0.94 g, 0.01 mole) were dissolved in ethyl alcohol (150 ml) and refluxed on water bath for 4 hrs. Ethanol was distilled off. The residual solid was then crystallized from ethanol to give white crystals. Analytical data, m.p., yield are represented in Table 1.

#### Synthesis of substituted 4-thiazolidinones (101)

A mixture of Schiff base (93) (0.01 mole) and thioglycolic acid (0.011 mole) was refluxed in benzene for 8 hrs. using Dean-Stark apparatus. The reaction mixture was cooled and washed with sodium bicarbonate and water to remove excess of thioglycolic acid. The solution was distilled off. The residual compound was then purified by distillation under vacuum or by crystallization. NMR data is described in Table 3.

(101a) was crystallized from ethanol. White needle-shaped crystals, m.p. 136-137°C, yield 75.4%. (Found: C, 71.21; H, 5.41; N, 5.23;  $C_{16}H_{15}NOS$  requires: C, 71.37; H, 5.57; N, 5.2%).

(101b) b.p. 135-150°/10 mm, yield 70%. (Found: C, 63.21; H, 7.01; N, 6.53;  $C_{12}H_{15}NOS$  requires: C, 63.15; H, 7.17; N, 6.69%).

**Synthesis of substituted 4-thiazolidinones (100)**

A mixture of Schiff base (91) (0.01 mole) and thioglycolic acid (0.011 mole) was refluxed in toluene for 8 hrs using Dean-Stark apparatus. The solvent, toluene was distilled completely and the solid mass was washed with sodium bicarbonate (10% soln.) and water to remove unreacted thioglycolic acid. The residual solid was then crystallized from ethylacetate-methanol mixture (20:80) to obtain white crystalline compound (100). The analytical data is represented in Table 4 and IR, NMR data are given in Table 5 and 6 respectively.

## REFERENCES

1. "Medicinal Chemistry", 2nd edn. (1960), Interscience Publications Inc., New York, London.
- 1a. A. Bulla  
W.H.O. Chronicle 31, 281 (1977).
2. R.S. Mitchell and J.G. Bell  
"Modern Chemotherapy of tuberculosis antibiotics", 1977.
3. R.R. Long  
Chemistry and Chemotherapy of Tuberculosis,  
The Williams and Wilkins Co. Baltimore (1958).
4. G. Canetti and H. Birkhaner  
Advances in T.B. Research, 12, 420 (1963).
5. J.M. Robson and F.M. Sullivan  
Pharmacol. Reviews, 15, 169 (1963).
6. Rich and Ellis  
Bull. Johns. Hopkins Hosp., 62, 77 (1938).
7. V. Chorine  
Bull. Soc. Path. Expt., 36, 46 (1943).
8. C.R. Smith  
Amer. Rev. Tuberc. 50, 163 (1944).
9. J.A. Kolmer  
Amer. Rev. Tuberc. 57, 25 (1948).
10. H.C. Ballou and A. Guernon  
Amer. Rev. Tuberc. 45, 212 (1942).
11. M.I. Smith, E.W. Emmart and B.B. Westfall  
J. Pharmacol. and Expt. Therap. 74, 163 (1942).
12. M. Rist, I. Blochand V. Hamon  
Ann. Inst. Pasteur, 64, 203 (1940).
13. E.M. Lincoln  
Amer. J. Med., 9, 623 (1950).
14. E.M. Lincoln  
Amer. Rev. Tuberc., 61, 159 (1950).
15. G. Domagk  
Thieme-Stuttgart, 405 (1950).
16. R. Behnisch, J. Mietzsch, H. Schmidt  
Amer. Rev. Tuberc., 61, 1 (1950).

17. G.Domagk,R.Becanisch,F.Mietzsch and H.Schmidt  
Naturroissenschaffen, **33**,317 (1946).
18. G.Domagk  
Amer.Rev.Tuberc., **61**, 8 (1950).
19. R.L.Mayer, P.C. Hisman and H.A. Kanopka  
Int.J.Leprosy, **27**, 8 (1959).
20. R.L.mayer, P.C. Hisman and H.A. Kanopka  
Amer.Rev.Tuberc.,**70**, 121 (1954).
21. J. Lehmann  
Lancet, **1**,1<sup>4</sup> (1946).
22. E. Bogen,R.N. Loonis,D.W.Will  
Amer.Rev. Tuberc.,**66**,21 (1952).
23. G.P. Youman,G.N.Raleigh and A.S. Youman  
J. Bacterial.,**54**, 409 (1947).
24. J.G. Gow  
Brit.Med. J., **1**, 95 (1953).
25. M. Janowice and W. Kostrzoviski  
Cryzlica **33**, 571 (1965).
26. V.Chorin  
Crompt.Rend. **220**, 150 (1945).
27. Chemistry and medicines of pththivazide State Union Publication  
of Medical Literature,Min. of Health, Moscow (1954).
28. J.P. Thomas,C.O. Baughn, R.C.Wilkinson and R.G.Shepherd  
Amer.Rev. Resp.Dis., **83**, 891 (1961).
29. T. Urbanski,S.Tornug,S.Slopek and J. Venulet  
Nature (London), **170**, 753 (1952).
30. H.P.D' Arcy  
Brit.Med. J.,**2**,849 (1946).
31. M.L.Conalty  
Chemotherapy of Tuberculosis Ed. by V.C.Barry,  
London, 150 (1964).
32. S.A.Waksmman, A.Sehatx and E.Bugle  
Proc.Soc.Expt. Biol. Med., **55**, 66 (1944).
33. W.H.Feidman, A.G.Karlson, H. Hinshaw  
Amer.Rev.Tuberc.,**52**, 269 (1943).



34. P. Sensi, P. Morgalith, M.T.Timbai  
Fummaco. (Pavia) Ed. Sci., **14**, 146 (1959).
35. F.C. Brown  
Chem. Rev., **61**, 463(1961).
36. K.A.Zoloterova, I.P. Maslova,N.A. Glazunova, E.F.Burmistrov and  
L.A. Pugacheva  
Voronezh, 5(1964), Chem.Abstr.**65**, 1876 (1966).
37. S.P.Singh,S.S.Parmar, K.Raman and V.I.Stenberg  
Chem. Rev., **81**, 2(1981).
38. A.R.Katritzky and A.J. Boulton  
"Advances in Heterocyclic Chemistry" (Academic Press, N.Y.  
London), Vol.**25**, 83 (1979).
39. R.P.Rao  
J.Ind.Chem.Soc., **38**, 787 (1961).
40. P.N.Dhal,T.E.Achary and A. Nayak  
Indian J.Chem., **13**, 753 (1975).
41. H.K.Pujari  
J. Indian. Chem.Soc., **43**, 657 (1966), H.S.Chaudhari and H.K.Pujari,  
Indian J.Chem., **6**(468).
42. Yu. V.Svetkin,A.N. Minlibaeva and S.A.Vasil'eva  
Zh. Obshch Khim., **38**, 116 (1968).
43. T.E.Acharya, P.N. Dhal and A. Nayak  
J. Inst. Chem.Calcutta, **44**, 166 (1972).
44. O.V.Vlalizimirs'ka  
Farm.Zh. (Kiev), **18**, 7(1963); Chem.Abstr., **60**, 4126 (1963).
45. T.E.Acharya,A. Nayak  
Curr. Sci., **41**, 539 (1972).
46. K.S.L.Srivastava  
Indian J.Appl.Chem., **32**, 369 (1969); Curr.Sci., **37**, 315 (1968).
47. S.R.Singh  
J. Indian Chem.Soc., **52**, 734 (1975).
48. V.N. Choubey and H.Singh  
Bull.Chem.Soc. Japan, **43**, 2233 (1970).
49. P.N. Bhargava and G.C.Singh  
J. Indian Chem.Soc., **45**, 32 (1968).
50. P.Ram, K.S.L.Srivastava, R.Lakhan and M.R.Chaurasia  
Indian J.Appl.Chem., **32**, 279 (1969).

51. S.C.Sharma  
Bull.Chem.Soc.,Japan, **40**,2422 (1967).
52. I.I.Chizheevskaya and M.I.Zavadskaya  
Zh. Org. Khim.,**4**, 1116 (1968).
53. S.K.Mallik,A.R.Martin and R.G. Lingard  
J.Med.Chem., **14**, 528 (1971).
54. R.P. Rao and S.R.Singh  
J. Indian Chem.Soc., **50**, 600 (1973).
55. N.C.Misra and K.K. Patnaik  
Indian J. Appl.Chem., **34**, 148 (1971).
56. K.C. Joshi and S.C. Bahel  
J. Indian Chem.Soc., **39**, 121 (1962).
57. W.H. Burton,W.L.Budde and C.C.Cheng  
J. Med. Chem., **13**, 1009 (1970).
58. J.P.Trivedi and I.D.Shah  
J. Indian Chem.Soc., **43**, 275 (1966);  
I.D.Shah and J.P.Trivedi  
Ibid., **41**, 704 (1964); **40**, 889 (1963).
59. V.S.Misra and A.Saxena  
J. Prakt.Chem., **4**, 36,260 (1967).
60. I.D. Komaritsa and A.P. Grishchuk  
Khim.Geterotsik Soedin, p.706 (1968).
61. S.S.Parmar,C.Dwivedi,A.Chaudhari and T.K.Gupta  
J. med. Chem., **15**, 99 (1972).  
C.Trivedi,T.K.Gupta and S.S.Parmar  
Ibid. p.553.  
S.K.Chaudhari, M. Verma, A.K.Chaturvedi and S.S.Parmar  
J. Pharm.Sci., **64**, 614 (1975).
62. J.Chaudhary, S.S.Parmar,S.K.Chaudhari,A.K.Chaturvedi  
and B.V. Ramsastry  
J. Pharm.Sci., **65**, 443 (1976).
63. R. Kumar,T.K.Gupta,S.S.Parmar  
J. Prakt.Chem., **312**, 201 (1970).
64. R.R.Astik, G.B. Joshi, K.A.Thaker  
J. Indian Chem. Soc., **52**, 1071 (1975); **53**,272 (1976).

65. A.R.Surrey  
U.S.Patent 3,377,355 (1968); Chem.Abstr. **69**, 59227 (1968).
66. S.K. Chaudhary, M. Varma, A.K. Chaturvedi and S.S. Parmar  
J. Pharm.Sci., **64**, 614 (1975).
67. K.C. Joshi and J.S. Gupta  
Indian J.Chem., **5**, 139 (1967).
68. V.K. Chanda, H.S. Chaudhari and H.K. Pujari  
Indian J.Chem., **8**, 885 (1970);  
H.S. Chaudhari and H.K. Pujari  
Ibid., **10**, 766 (1972).
69. J. Mohan, V.K. Chanda, H.S. Chaudhary, B.D. Sharma, H.K. Pujari  
and L.N. Mahapatra  
Indian J. Expt. Biol., **10**, 37 (1972).
70. E.B. Akerbloom  
J. Med. Chem., **17**, 609 (1974).
71. B.C. Mahanta, A.K. Panigrahi and M.K. Raut  
J. Indian Chem.Soc., **47**, 707 (1970).
72. A. Andolsek, B. Stanovnik, M. Tisler, M. Likar and P. Schaur  
J. Med. Chem., **14**, 53 (1971).
73. A.F. Pavlenko and S.D. Moshchitskii  
Khim. Geterotsikl. Soedin., **3**, 259 (1967).
74. V.G. Zulenko and M.M. Turkevich  
Farm. Zh. (Kiev), **20**, 6 (1965).
75. L. Musial and J. Staniec  
Roez. Chem., **39**, 839 (1965); **38**, 1105 (1964).
76. A.R.A. Rauf, M.T. Omar and M.M.E. Attal  
Acta Chim. Acad. Sci. Hung, **83**, 367 (1974).
77. J.J. Ares and D.D. Miller  
J. Chem. Educ. **63** (3), 243 (1986).
78. M. Hauser  
J. Org. Chem., **27**, 43 (1962).
79. H. Najer, R. Giudicelli, C. Moreland J. Menin  
Bull. Soc. Chim. Fr., p.1022 (1963).
80. M.R. Udupa and M. Padmanabhan  
J. Inorg. Nucl. Chem., **37**, 1808 (1975).

81. W. Reeve and M.Nees  
J.Amer.Chem.Soc., **89**, 647 (1967).
82. A.S.U.Choughuley and M.S.Chanda  
Indian J.Chem., **1**, 437 (1963).
83. Yu. V.Svetkin, Kh.F.Bikbaeva, R.R. Faizulov and A.N.Glazev  
Zh. Obshch. Khim., **42**, 2055 (1972).
84. H.Nagase  
Chem. Pharm. Bull., **21**, 270 and 279 (1973).
85. B.K.Ravel and J.J.Trivedi  
J. Indian Chem.Soc., **37**, 353 (1960).
86. G.Fenech  
Ann.Chim. (Rome), **50**, 413 (1960).
87. J.C.Wilson, R.N.Downer and H.E. Sheffer  
J. Heterocycl.Chem., **7**, 955 (1970).
88. V. Belavita and A. Martani  
Gazz. Chim. Ital., **97**, 135 (1967).
89. A.A.Shaikh  
J. Inst.Chem.Calcutta, **45**, 207 (1973).
90. V.G.Barot, P.B. Patel and J.J.Trivedi  
J. Inst. Chem.Calcutta, **45**, 24 (1973);  
R.K.Shah and P.B.Patel  
Ibid., **46**, 34 (1974).
91. S. Kambe and T. Hayashi  
Bull. Chem. Soc., Japan, **45**, 952 (1972).
92. A. Shaikh, A.Chinone and M. Ohta  
Bull.Chem.Soc., Japan, **43**, 453 (1970).
93. E. Sctopl and R. Pohloudek-Fabin  
Pharmazie, **23**, 638 (1968); **24**, 96 (1969).
94. H. Kornowski and M.Trichot  
Bull.Soc.Chim.Fr., p.763 (1965).
95. L.I.Petlichna, M.M.Turkevich and V.M.Vvedeskii  
Ukr. Khim.Zh. **29**, 170 (1963).
96. S. Kambe, T. Hayashi, H. Yasuda and A.Sakuri  
Nippon Kagaku Zasshi **92**, 867 (1971);  
S. Kambe and T. Hayashi  
Bull. Chem. Soc. Japan, **45**, 3192 (1972).

97. Yu.V.Sveetkin, Kh.F.Bikbaeva, E.M. Tsyrlina and D. Ya. Mukhametova, *Zh. Obshch Khim.*, **46**, 2111 (1976).
98. A. Gomes and M.M. Joullie  
*Chim. Commun.*, p.935 (1967).
99. A.S.Gomes and M.M. Joullie  
*J. Heterocycl. Chem.*, **6**, 729 (1969).
100. Z. Takayanagi, H. Kato and M.Ohta  
*Bull.Chem.Soc.Japan*, **40**, 2930 (1967).
101. G. Irick  
*J.Heterocycl.Chem.*, **8**, 847 (1971).
102. W.T. Brady and E.D. Dorsey  
*J. Org.Chem.*, **35**, 2732 (1970).
103. V.K.Chadha, H.S.Chaudhary and H.K. Pujari  
*Austr. J. Chem.*, **22**, 2697 (1969).
104. G. Herrieu, P.Riout and J.Vialle  
*Bull.Soc.Chim.Fr.* P.4380 (1971).
105. H.N. Pandey and V.J.Ram  
*J. Indian Chem. Soc.*, **49**, 171 (1972);  
V.J.Ram, H.N.Pandey and S.N.Singh  
*Ibid*, p.181.
106. A.M.M.E.Omar  
*Pharmazide*, **28**, 110 (1973).
107. P.N. Bhargav and M.R.Chaurasia  
*J.Chem. U.A.R.* **12**, 149 (1969).
108. I.I. Chizhevskaya, A.Z. Malinnikova and N.N. Khovratovich  
*Khim.Geterotsikl., Soedin*, p.96 (1971).
109. I.I.Chizhevskaya, A.Z.Malinnikova and N.M. Pliss  
*Pliss.Vesti.Akad.Nauk.B.SSR, Ser.Khim Nauk*, p.97 (1969);  
*Chem.Abstr.* **73**, 3834 (1970).
110. G.Fenechand M.Basile  
*Ann.Chim. (Rome)*, **53**, 848(1963); *Gazz.Chim. Ital.* **91**, 1168 (1961);  
**95**, 1258 (1965).
111. M.Susse and H. Dehne  
*Z.Chem.*, **15**, 303 (1975).
112. A.I.Ginak, K.A.Vyynov and E.G.Sochilin  
*Zh. Prikl. Khim*, **45**, 460 (1972).

113. C.K. Bradsher, F.C. Brown and R.J. Grantham  
J. Amer. Chem. Soc., **73**, 5377 (1951).
114. I.I. Chzhevskaya and N.M. Yatsevich  
Izu. Akad. Nauk SSSR, Ser. Khim. Nauk **85** (1971).
115. C.P. Lo and E.Y. Shropshire  
J. Amer. Chem. Soc., **75**, 4853 (1953).
116. N.N. Turkevich and S.M. Bartylyak  
Farm. Zh. (Kiev), **28**, 18 (1973).
117. V.A. Zdenko and E.V. Vladzimirskaya  
Farm. Zh. (Kiev), **32**, 28 (1977).
118. M. Turkevich and S.A. Yurzhenko  
Khim. Geterotsikl, Soedin, Sb. **3**, 129 (1971).
119. A.P. Grishchuk, I.D. Komaritsa and S.N. Baranov  
Khim. Geterotsikl, Soedin p. 706 (1966); 664 (1967).
120. N.E. Plevachuk  
Farm. Zh. (Kiev) **25**, 28 (1970).
121. J.S. Davidson  
Chem. Ind. (London) p. 618 (1974).
122. R.O. Kocarknyan  
Khim. Geterotsikl, Soedin, Sb. **3**, 140 (1971).
123. O.P. Shvaika, S.N. Baranov and V.N. Artemov  
Zh. Org. Khim. **6**, 2353 (1970).
124. E. Koltal, J. Nyitrai and K. Lempert  
Tetrahedron, **29**, 278 (1973).
125. A. Mustafa, W. Asker, A.F. A.M. Shalaby, A.H. Harhash, R. Daguer  
Tetrahedron, **20**, 25 (1964).
126. E.V. Vladzimirskaya  
Zh. obshch. Khim., **32**, 2019 (1962).
127. J. Sawlewicz, K. Wisterowicz and H. Ciurash  
Acta Pol. Pharm., **33**, 681 (1976).
128. I.D. Komaritsa and N.E. Plevachuk  
Khim. Geterotsikl, Soedin, Sb. **3**, 150 (1971).

129. N.A.Kassab, M.H.E. Nagdy and H.A.R.Ead  
J. Prakt.Chem., **315**, 265 (1973).
130. A.H. Harhash, M.H. Elnagdi and S.O. Abdullah  
Indian J.Chem., **11**, 128 (1973).
131. N.C.Misra and K.K. Patnaik  
J. Inst. Chem. Calcutta, **44**, 12 (1972).
132. A.A. Deikalov, A.K. Scheinkman and S.N. Baranov  
Khim. Geterotsikl, Soedin pp. 1105 and 1359, 1972; **6**, 130 (1970).
133. P.N. Bhargava and S.C. Sharma  
Bull. Chem. Soc. Japan, **35**, 1926 (1962);  
P.N. Bhargava and P.R. Singh  
J. sci. industr. Res. Sec. C-20, 209 (1961).
134. L.I. Pethichna  
Farm. Zh. (Kiev), **23**, 3 (1968).
135. A.V. Shelud'ko  
Farm. Zh. (Kiev), **16**, 21 (1961).
136. N.A.E. Kassab, S.O.A. Alla and A.R. Ead  
Z. Naturforsch. Teil, B31, 380 (1976).
137. N.A.E. Kassab, S.O.A. Alla and H.A.R. Ead  
Z. Naturforsch. Teil, B31, 380 (1976).
138. P.G. Sekachev  
Khim. Geterotsikl, Soedin p. 1351 (1973).
139. E.B. Sandall  
Anal. Chem., **20**, 253 (1948).
140. E.B. Sandall and J.J. Neumyer  
Anal. Chem., **22**, 1863 (1951).
141. G.E. Sawdey  
U.S. Patent 2,808,330 (Oct. 1, 1957);  
Chem. Abstr., **52**, 2624 (1958).
142. G.W. Sawdey and J.A. Van Allen  
U.S. Patent, 2,739,971 (March 17, 1956).
143. J.A. Van Allen and J.L.R. Williams  
U.S. Patent 2,882,150 (April 14, 1959); Chem. Abstr., **54**, 135 (1960).
144. D.P. Ahuja and S. Dutt  
J. Indian Chem. Soc., **28**, 12 (1951).

145. R. Heillingotter  
Kosmetisch-Parfüm-DrogenRundschau 25 (1955);  
Chem. Abstr., **49**, 15181 (1955).
146. W. Zerweck and M. Schubert  
U.S. Patent 2,339,314 (Jan. 18, 1944).  
Chem. Abstr., **38**, 3753 (1944).
147. O. Huppert  
U.S. Patent 2,364,034 (Nov. 28, 1944);  
Chem. Abstr., **39**, 4259 (1945).
148. F. G. Mores and J. J. Steggerda  
J. Inorg. Ind. Chem., 3217 (1968).
149. Miss J. Sahu, T. K. Sahu, S. K. Naik and A. Nayak  
J. Indian Chem. Soc., **60**, 861 (1983).
150. S. J. Shah, S. R. Shah, N. C. Desai and K. A. Thaker  
J. Indian Chem. Soc., **61**, 648 (1984).
151. S. V. Patel, J. N. Vasavada and G. B. Joshi  
J. Indian Chem. Soc., **61**, 560 (1984).
152. N. C. Desai, H. K. Shukla, R. R. Astic and K. A. Thaker  
J. Indian Chem. Soc., **61**, 607 (1984).
153. M. Rai, A. Singh and P. S. Kalsi  
Indian J. Chem., **18B**, 273 (1979).
154. T. Oguri, N. Kawai, T. Shioori and S. Yamada  
Chem. Pharm. Bull., **26(3)**, 803 (1978).
155. P. C. Joshi and Puran Chandra Joshi  
J. Indian Chem. Soc., **55**, 12,1267 (1978).  
Chem. Abstract, **93**, 46096j.
156. D. Lucette and T. Francis  
J. Org. Metallic Chemistry, **280**, 1 (1985).
157. A. Ahmad, F. Brand, B. F. Anthony, J. David and D. M. Smith  
J. Chem. Res. Synop. **6**, 208 (1980);  
Chem. Abstr. **93**, 22068lh.
158. R. R. Reddy, D. S. Iyengar and U. T. Bhalerao  
J. Heterocyclic Chem. **22(2)**, 321 (1985).
159. K. M. Hassan, A. K. El-Shafei, H. S. El-Kashef and M. M. Mashaly  
J. Chem. Technol. Biotech., **32**, 416 (1982).
160. G. C. Kamdar, D. J. Bhatt and A. R. Parikh  
J. Indian Chem. Soc., **61**, 790 (1984).



161. N.C. Desai, H.K.Shukla, N. A. Langalla and K. A.Thaker  
J. Indian Chem.Soc., **61**, 8, 711 (1984).
162. S.K. Phadtare, S.K.Kamat and G.T. Panse  
Indian J. Chem., **24B**, 811 (1985).
163. R. Jansson  
Chem. & Engineering, **19**, 43 (1984).
164. H.K. Venkatramaiah  
Ph.D Thesis, Univ.of Bombay, 1985.
165. S.R.Patil, U.N. Kantak and D.N.Sen  
Inorganica Chemica Acta, **68** (1983).
166. S.R.Patil, U.N.Kantak and D.N.Sen  
Inorganica Chemica Acta, **63**, 261 (1982).
167. G. Fenech and P.Monforte  
Ann. Chim. (Rome) **48**, 975 (1958).
168. A.R.Surray  
U.S.Patent 2,647,905 ( Aug.4, 1933).  
Chem. Abs. **48**, 9408 (1954).
169. J.R.Dimmock, G.B. Baker and W.G. Taylor  
Canad. J.Pharm. Sci.,**7(4)**, 101 (1972).

---

---

CHAPTER III  
ASYMMETRIC SYNTHESIS OF 4-THIAZOLIDIDONES

---

---

---

---

SECTION - A

---

---

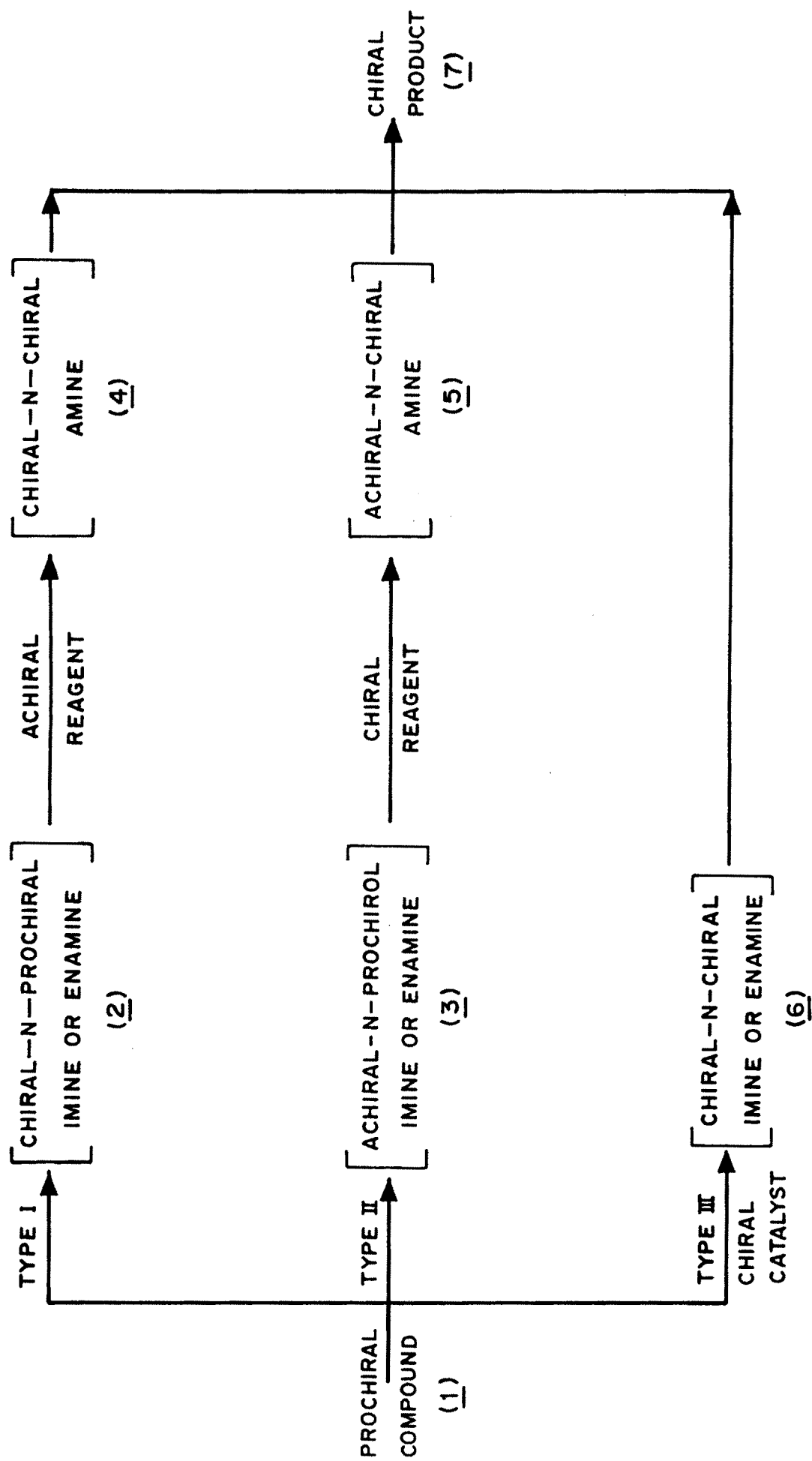
## INTRODUCTION

### Asymmetric Synthesis

The synthesis of complex molecules with asymmetric centres proposes a great challenge to chemists. It is well known that only one isomer either d or l has a specific biological activity and therefore asymmetric syntheses of such compounds have been devised. Thus number of drugs e.g. D(+) Naproxene, L(-)DOPA, M(-)DOPA have been commercialised. In normal synthetic methods, essentially, produce racemic mixtures of the drugs and then with the help of resolving agents separation of d and l-isomers has been achieved. However, one has to either discard or recycle the other isomer separated out in the resolution procedure and therefore it is economically worthwhile to exclude unwanted optical isomers at the earliest possible stage through asymmetric creation of chiral centres.

The essential feature of the asymmetric synthesis involves the generation of achiral compounds from the prochiral compound under the influence of asymmetric agent, so that unusual amounts of stereoisomeric products result with a definite steric configuration. The asymmetric agents mentioned can be chemical reagent, solvent, catalyst or a physical force as circularly polarized light.

Generally number of examples of asymmetric synthesis involve imine or enamine substrates. These reactions may be classified into three generic types (Chart 1). In type I, a prochiral compound (1) combined with a chiral substance to give a chiral-N-prochiral imine or enamine (2), subsequent reduction of (2) with an achiral reagent gives the chiral-N-chiral amine diastereomer (4) which



on removal of original chiral moiety gives the final chiral product (7). Many classical examples of asymmetric synthesis are of this type. Type II, sequences are more flexible, conversion of (1) to a chiral-N-prochiral imine or enamine (3) is followed by treatment with a chiral reagent to produce an achiral-N-chiral amine (5), which is then converted into final chiral product (7). The auxiliary chiral reagent may be used either catalytically or stoichiometrically.

In type III reactions, interacting of (1) with a chiral catalyst generates a chiral-N-chiral imine or enamine (6) as an intermediate which reacts further to form (7) and regenerate the catalyst. This is, in principle, the most efficient use of chiral reagent.

Many books and reviews have been published on asymmetric synthesis<sup>1-9</sup>. It is the intent of this introduction to highlight the recent advances related to asymmetric synthesis of  $\alpha$ -amino acids.

### Historical Developments

The concept of asymmetric synthesis was proposed in 1894 by Emil Fischer<sup>3</sup> stating that chlorophyll acting as an asymmetric catalyst was responsible for the production of optically active sugars from CO<sub>2</sub> and water in plants.

In the early part of the 20th Century asymmetric induction was thought of as some mysterious unsymmetrical force acting on molecules. Around forties first asymmetric Meerwein-Ponndorf-Verley and Grignard reactions were reported to state that asymmetric induction was rationalized in terms of steric interactions in the transition state. Prelog examined such interactions among various

conformations available to reactants and similar work by Cram and ElhaFaz established steric control as a major factor in asymmetric induction.

A wide variety of reactions can exhibit asymmetry, but only a few match the selectivity provided by enzymes. Non-racemic chiral products have been obtained from Grignard and Meerwein Ponderf-Verley reactions, hydride reductions, additions to carbonyls and olefins, cyclization reaction, alpha-alkylation of carbonyls, amino acid synthesis, Diels-Alder cycloadditions, hetero and homogenous hydrogenations as well as elimination reactions.

#### **Theoretical Aspects**

The most asymmetry is created upon conversion of trigonal carbons to tetragonal ones at the site of functionality such as carbonyl enamine, enol, imine and olefin<sup>9</sup>. This asymmetry at carbon is the major area of interest, as well as induction by, and creation of asymmetry at sulphur. Thus the transition state in which the conversion of a trigonal carbon to tetragonal one, is of theoretical point of interest.

In an asymmetric reaction, substrate and reagent combine to form diastereometric transition states. One of the two chiral reactions must have a chiral centre which can be carbon or configurationally stable tetracoordinate silicon arsenic, antimony, sulphur or phosphorous, where the electron pair is formally regarded as fourth substituent. In each case the chiral centre induces asymmetry at the reaction site.

The diastereomeric transition state so formed solvates<sup>10</sup> or other electrostatic complexes in addition to the bonded compounds. The difference in free energy between them ( $\Delta\Delta G^\ddagger$ ) determines the excess of one antipode over the other hence it is desirable to maximise  $\Delta\Delta G^\ddagger$ . This is accomplished by introducing steric hindrance in the considerable diastereomer or enhancing the lower energy pathway by some favourable interaction. The 'glove hand fit' analogy of Mislow<sup>11</sup> is appropriate here, where the excellence of fit of reagent and substrate is reflected ultimately in 'transition' state energy, but is manipulated or predicted by consideration of the steric/torsional factors.

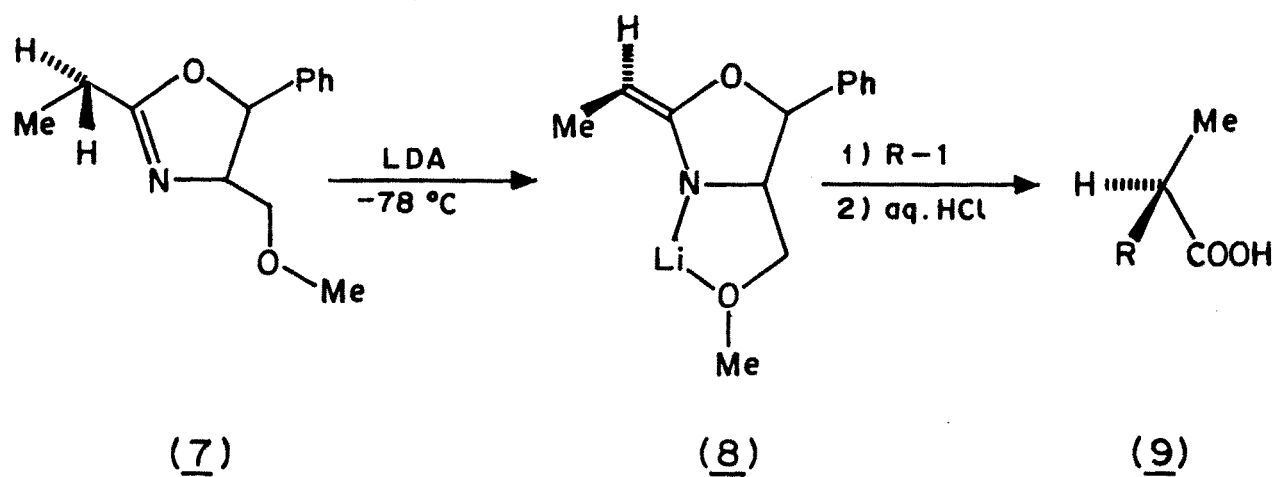
The methods for the most part, are empirical however, and must be used with caution as the enthalpy ( $\Delta\Delta H^\ddagger$ ) and entropy ( $\Delta\Delta S^\ddagger$ ) terms of the  $\Delta\Delta G^\ddagger$  function can change drastically with small changes in reaction parameters.

These concepts are practically exemplified in the use of lithiooxazolines in asymmetric synthesis<sup>12</sup>. Thus treatment of the chiral oxazoline (7(A)) with lithium diisopropylamide results in the selective removal of one of the enantiotopic methylene protons. Due to hindrance of the  $\beta$ -face of the phenyl substituent and chelation of R-X to Li on the  $\alpha$ -face, the lithio salt (8) is preferentially alkylated via bottom side attached to give a 60-67% enantiomeric excess of (S)- $\alpha$ -methyl carboxylic acid (9) with a new chiral centre (Chart 2-A).

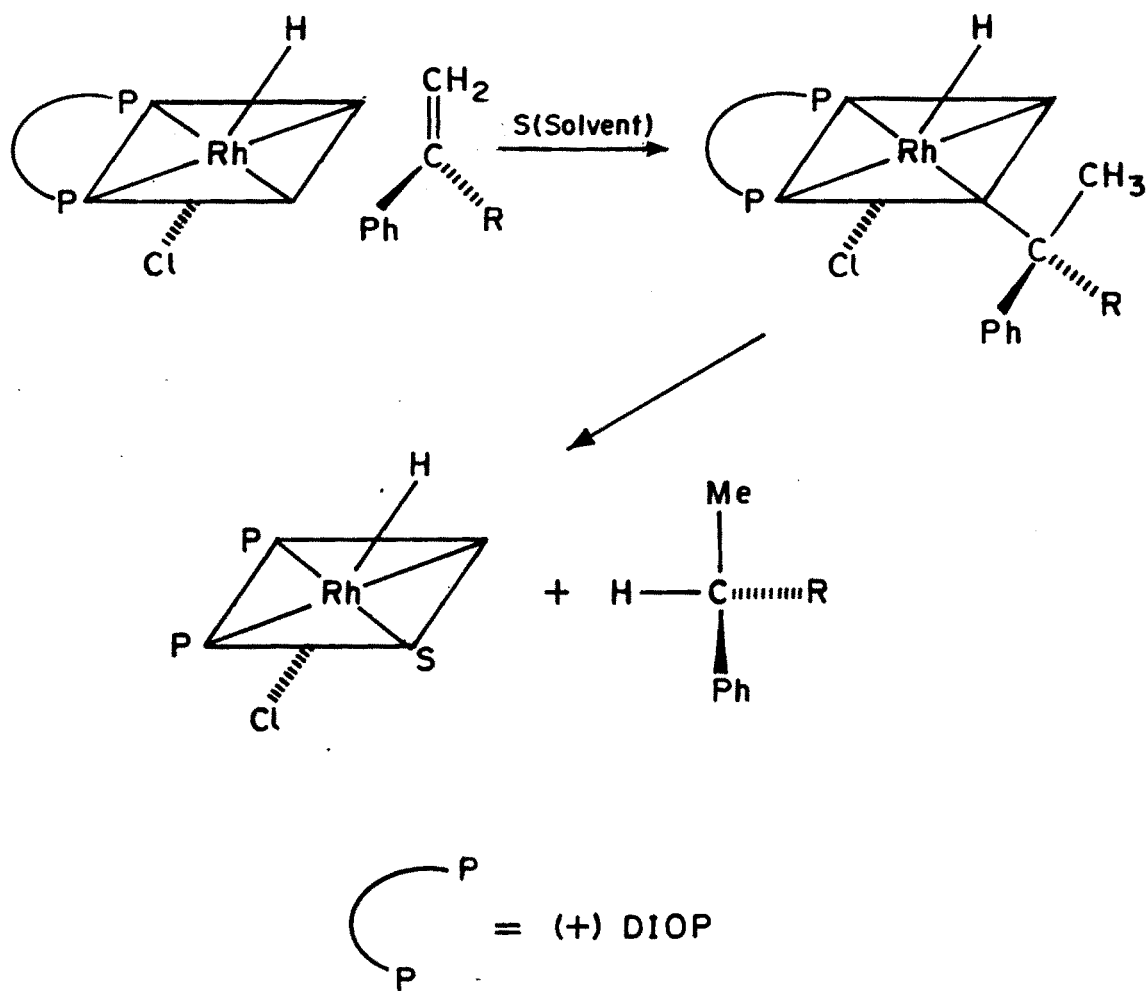


CHART-2

A:



B:



In kinetically controlled reactions, the free energies of the reactants for competing pathways are identical ( $\Delta G^\circ=0$ ). A diagram representing an idealized energy profile for such reactions is shown in Figure 1 showing differing energies of diastereomeric pathways leading to products.

### Chiral Reagents

In recent years the chemical literature has reflected the growing popularity of chiral starting materials and reagents for the construction of optically active molecules<sup>13</sup>. The chiral reagents used in the asymmetric synthesis can generally be classified into three types:

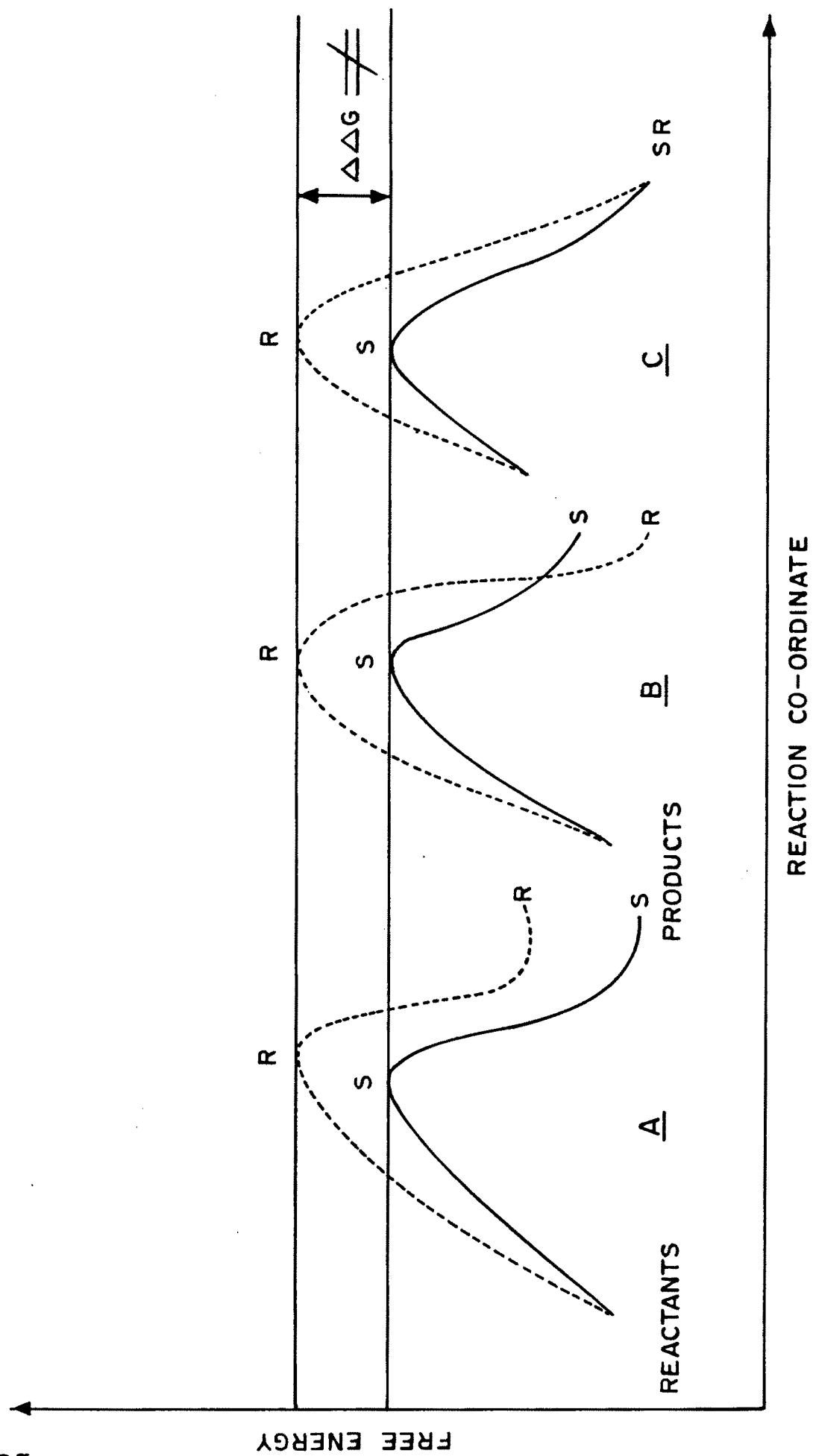
- i) Synthetic chiral reagents,
- ii) Naturally occurring chiral reagents,
- iii) Enzymes as chiral reagent.

### Synthetic Amines and Alcohols

$\alpha$ -Methyl benzyl amine has been extensively used for the preparation of azomethine<sup>10</sup> compounds (-)-2,2'-dihydroxy-1,1'-binaphthyl<sup>14</sup> and (+)-4-di-methyl-amino-3-methyl-1,2-diphenyl-2-butanol<sup>15</sup> have been used as chiral reagents in the reduction of ketones to alcohols.

### Synthetic Organometallic Reagents

The Rh(I) complexes are the most successful chiral catalysts<sup>16</sup>. Kagan et al.<sup>17</sup> reported hydrogenations of olefins, using dimethoxy diphosphine fused with dioxolan ring ((+)-DIOP) (10) to give optical yield of 63% (Chart 2-B).



ENERGY-REACTION CO-ORDINATE DIAGRAM FOR  
KINETICALLY CONTROLLED ASYMMETRIC TRANSFORMATION

FIGURE 1

Similarly silicon complex<sup>18</sup> nickel<sup>19</sup> and palladium<sup>20</sup> complexes, aluminium complex<sup>21</sup> are the other organometallic reagents used for the asymmetric synthesis.

### Naturally Occurring Chiral Reagents

Naturally occurring chiral compounds either alone or in the form of metal complex together play an important role in the asymmetric catalysis. Some of the naturally occurring chiral reagents are  $\alpha$ -amino acids,<sup>22,23</sup> (-)-ephedrine<sup>24</sup>, sugars<sup>25,26</sup>, terpenes<sup>27</sup>, (-)-menthol<sup>28</sup> and (+)-tartaric acid<sup>29</sup>.

### Enzymes as Chiral Reagents

The most effective catalyst by far are natural enzymes. A wide variety of asymmetric reactions are existing, but only a few match the selectivity provided by enzymes. Some of the enzymes such as horse liver alcohol dehydrogenase (HLADH),<sup>30</sup> NAD(P)H<sup>31</sup> (nicotinamide adenine dinucleotide, NAD) have been used successfully in the asymmetric synthesis.

### Methods for the Preparation of Asymmetric Synthesis

#### Alkylation of Hydrazone Derivatives

An asymmetric synthesis of (R)- $\alpha$ -phenylalkyl amines<sup>32</sup> using N-aminoephedrine, proceeds in extremely high e.e. Condensation of N-amino ephedrine (12) with various aryl aldehydes gave the chiral hydrazones (13) in almost quantitative yields. Treatment of hydrazones with Grignard reagent under N<sub>2</sub> afforded the hydrazines (14). Two diastereomeric forms of each compound could be formed owing to the newly created chiral centre but NMR, TLC and GLC comparisons established that these products contained only one isomer. Hydro-

genolysis of the hydrazines (14) using Pd/C catalyst under hydrogen in HCl/EtOH produced the  $\alpha$ -phenyl alkyl amines (15) (Chart 3) and ephedrine hydrochloride. The compound (15) were then converted into N-salicylidenes- $\alpha$ -phenyl alkyl amines whose optical purity and configuration were determined by comparison with data reported.

#### Synthesis of $\alpha$ -Amino acids

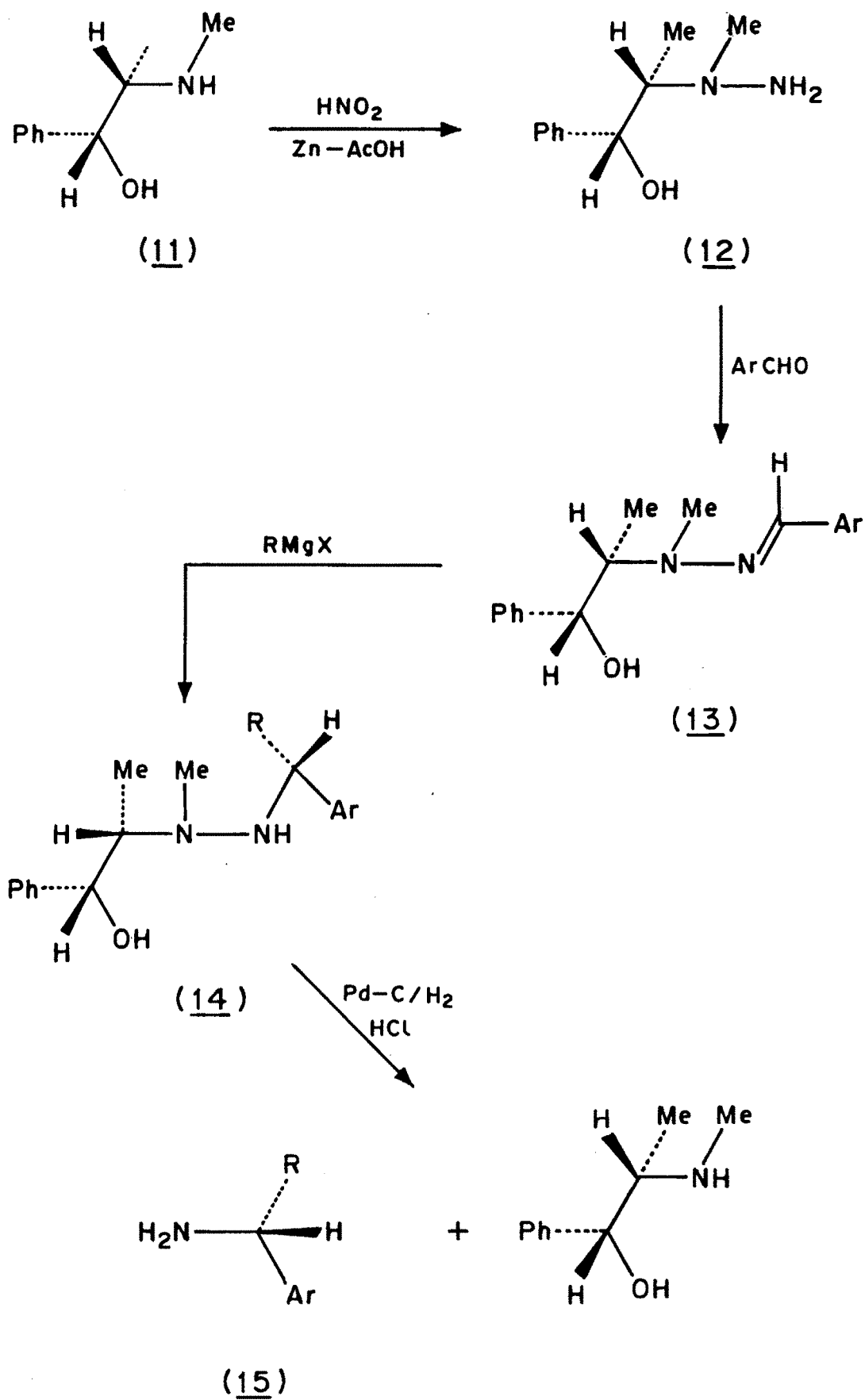
Owing to the immensely important role played by optically active amino acids asymmetric amino acid synthesis has attracted special interest. Thus 4-metalated-4-alkyl-1-[(5)-1-phenyl ethyl]-2-imidazoline-5-ones (19b) or their tautomers (20) are alkylated with R-halide and resulting 4-4-disubstituted imidazolinones (21)<sup>33</sup> hydrolysed to the amino acids (22). In the case of alkylating agent R-halide with large R<sup>2</sup> groups e.g. benzyl halides, the asymmetric induction at C-4 of (21) has almost decreased with decreasing size of R<sup>2</sup> (Chart 4).

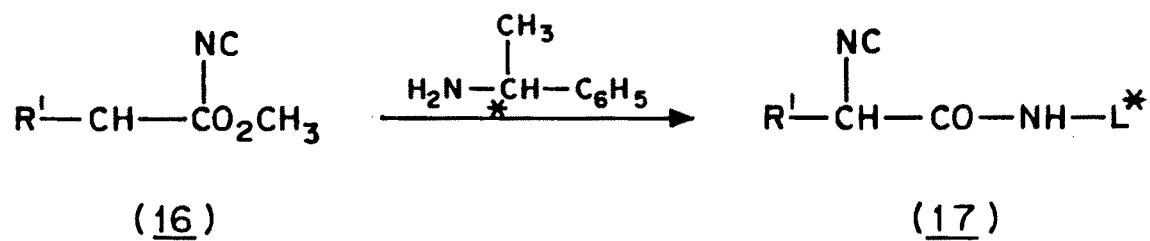
#### Asymmetric Alkylation of Esters with New Reagents

The base induced alkylation<sup>34</sup> of (3s,6s)-(+)-2,5-dimethoxy-3,6-dimethyl-3,6-dihydropyrazine (25) proceeds with high asymmetric induction (80-90% e.e.). 3,6-Dihydropyrazine (25) is obtained by the reaction of cyclo (L-Ala-L-Ala) with trimethyl oxonium tetrafluoroborate (Chart 5). This reaction proceed without racemization. The lithiation of (25) to (26) can be smoothly performed at -70°C in THF with butyl lithium or LDA.

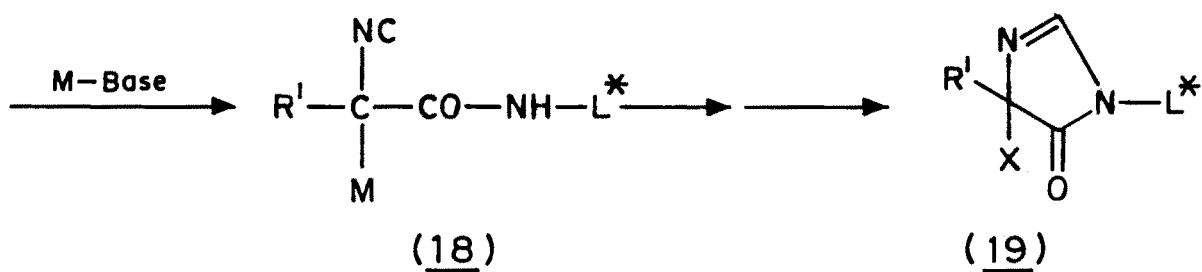
In the alkylation (26) $\rightarrow$ (27), the R<sub>1</sub> configuration is induced at C-6. The alkylation products (27) are hydrolysable with 0.5 N HCl even at room temperature. The esters (23) and (28) can be

## CHART-3

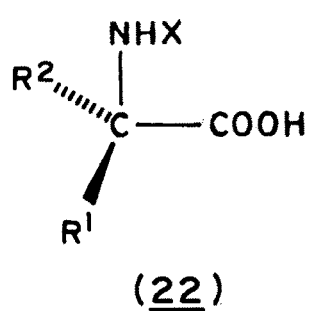
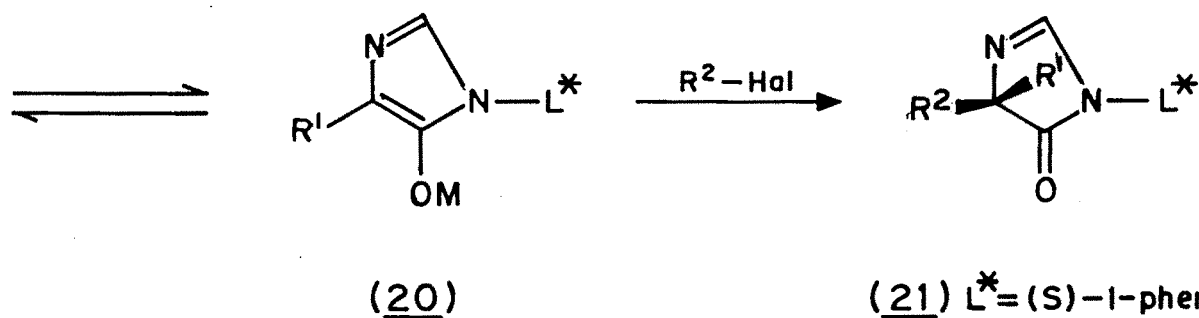




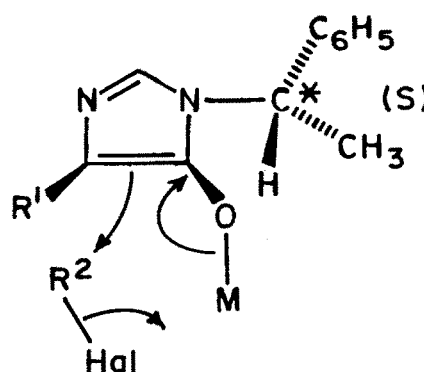
$\text{R}^1 = \text{CH}_3$   
 $\text{R}^1 = \text{CH}_2\text{C}_6\text{H}_5$   
 $\text{R}^1 = \text{H}$

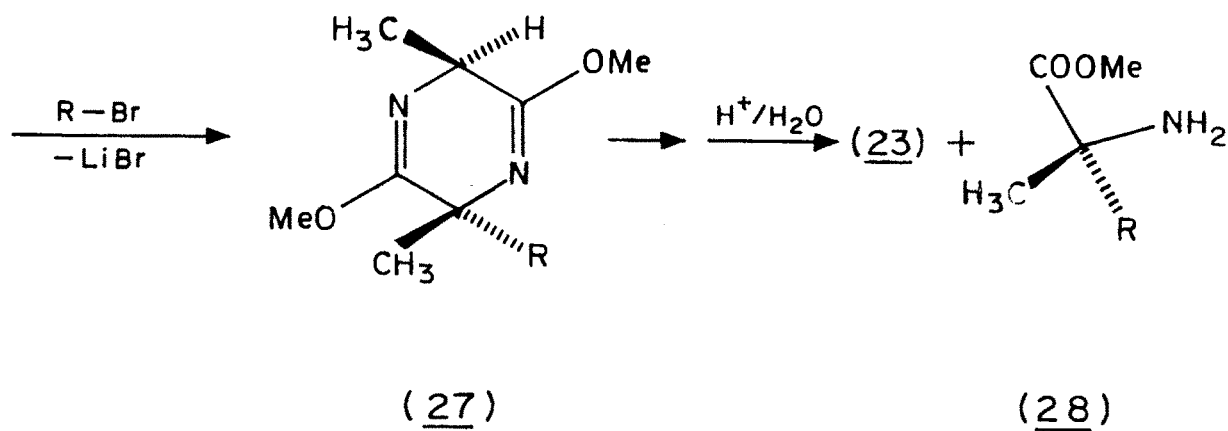
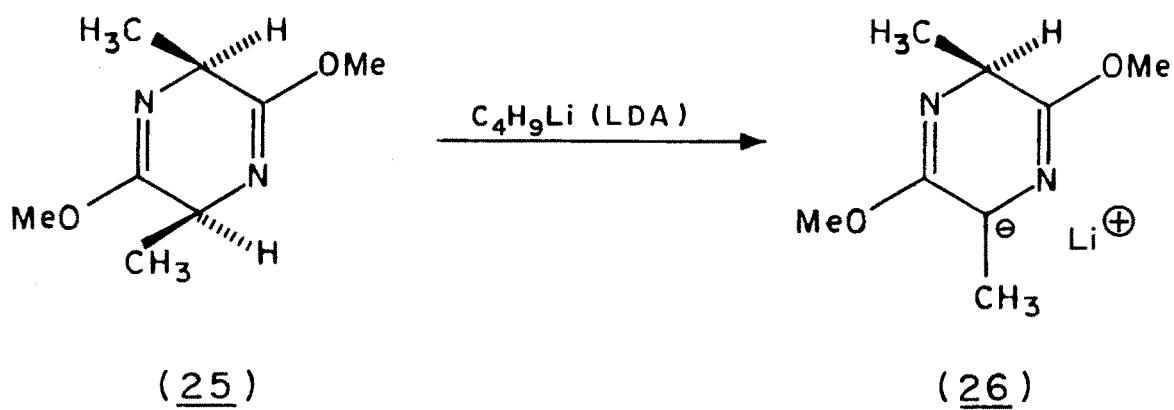
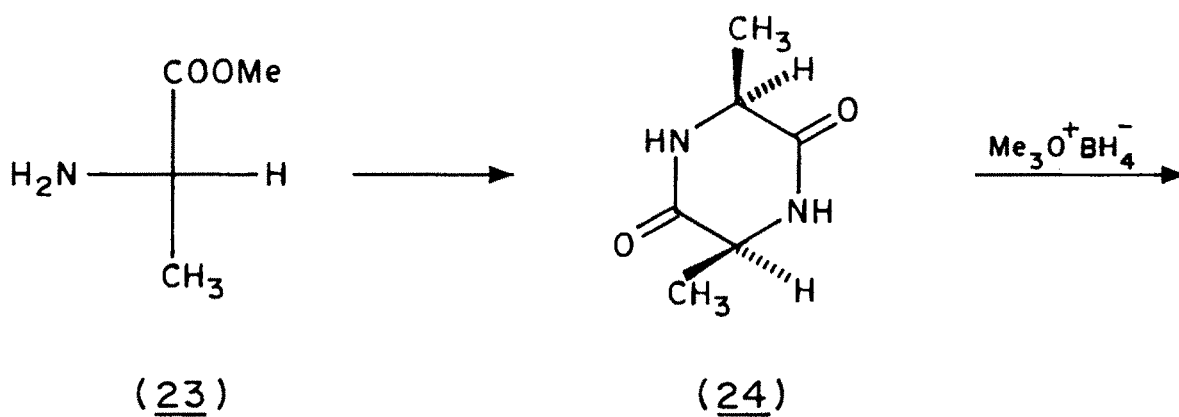


a)  $\text{X} = \text{H}$   
 b)  $\text{X} = \text{M}$



a)  $\text{X} = \text{H}$   
 b)  $\text{X} = \text{Ac}$







separated for instance by distillation.

#### **Asymmetric Catalytic Allylic Alkylation**

An asymmetric catalytic allylic alkylation has been developed which give chiral substituted succinic acids (30) in high optical yield. Allylic alkylations<sup>35</sup> were carried out homogeneously at 35°C. The solutions consisted of 5% [Pd(s,s-chiraphos) -allyl]ClO<sub>4</sub> as catalyst precursors, two equivalents of sodium dimethylmalonate (29) and one equivalent of the allylacetate substrate (Chart 6-A). Chemical yields were found to be quantitative and optical yields 84-86%.

#### **Asymmetric Catalytic Epoxidation**

The epoxide functional group is one of the most useful intermediates in organic synthesis. Recently a new metal catalysed asymmetric epoxidation procedure has been described which is far more selective than any of epoxidation described so far. Using this technique some of the key intermediates in the synthesis of methylmycine and erythromycin have been obtained in more than 95% e.e. Thus, this method is quite comparable to enzymic catalysis.

Thus, olefinic alcohols (31) have been epoxidized<sup>36</sup> to epoxy alcohols (32) using (+) or (-) diethyl tartrate, tert-butyl hydroperoxide in the presence of titanium tetraisopropoxide (Chart 6-B).

#### **Asymmetric Catalytic Hydrogenation**

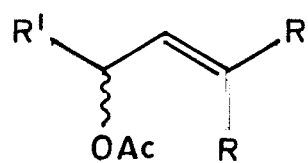
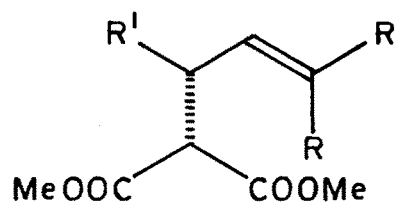
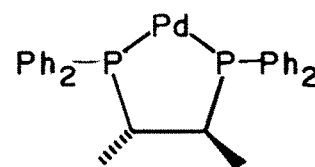
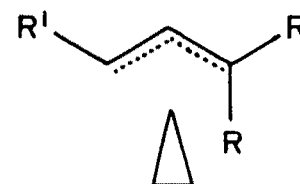
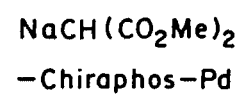
Homogeneous hydrogenation of  $\alpha$ -acetamido cinnamic acids (33) with hydrogen and soluble chiral rhodium complexes furnished 90% e.e. of N-acetyl phenyl alanine<sup>37</sup> (34) (Chart 7-A). Using Rh complex chiral reagent, the commercial synthesis of L-DOPA (36) in 84% optical purity has been achieved<sup>38</sup> (Chart 7-B).

#### **Optical Purity**

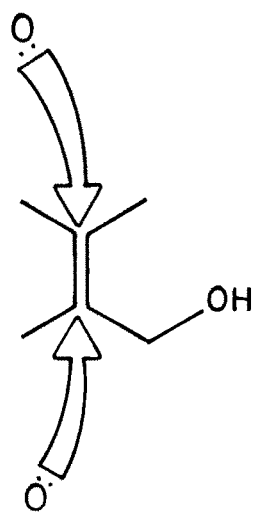
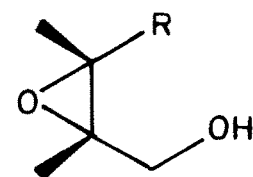
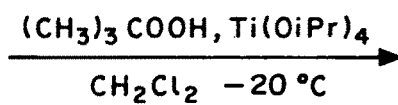
The extent of asymmetric synthesis is easily determined in the case of diastereomeric products which are in most cases easily separated and the ratio determined. Polarimetry is the most commonly used method to determine the enantiomeric ratios<sup>39</sup>.

CHART-6

A:

(29)(30)

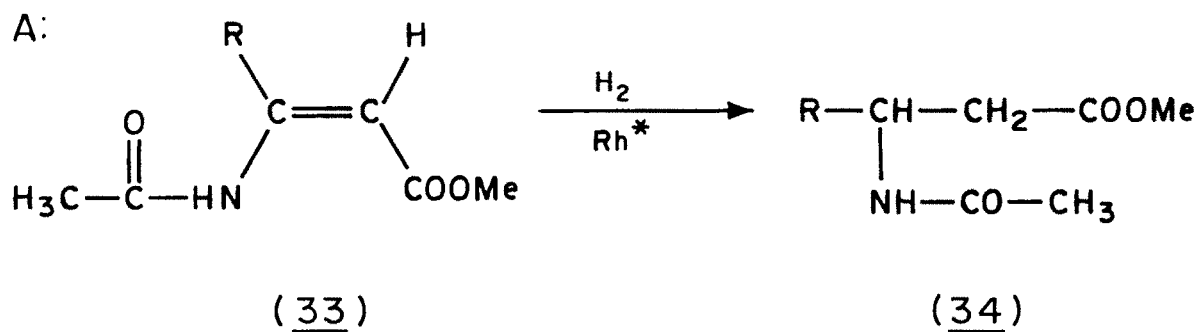
B:

(31)

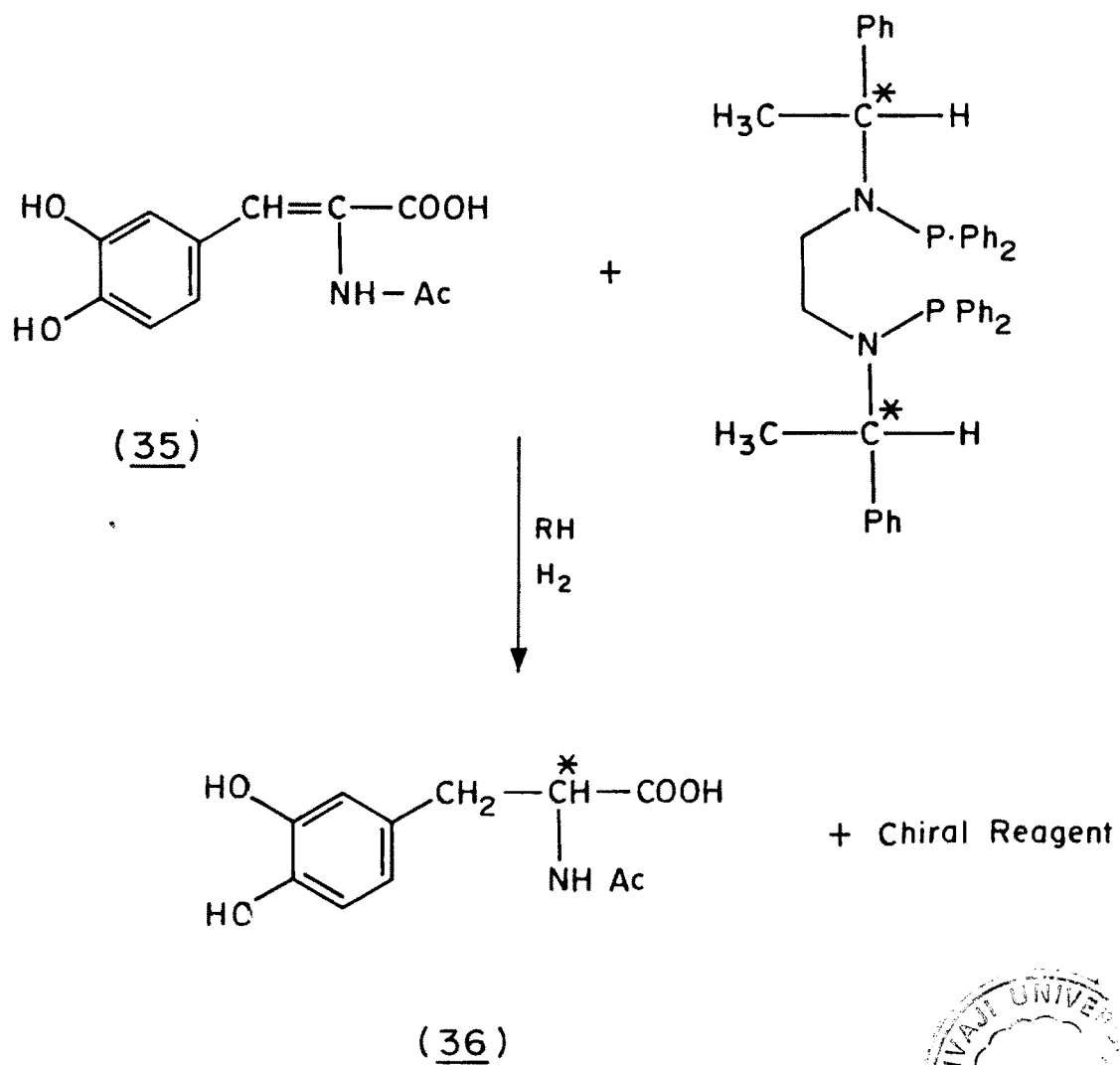
70-87% (90% ee)

(32)

CHART - 7



B:



Optical purity is determined by dividing the observed rotation of the product mixture by that of the pure enantiomer determined under identical conditions of temperature, concentration and wavelength. Assuming a linear plot of rotation versus composition;

$$\% \text{ optical purity} = \frac{(\alpha) \text{ OBS}}{(\alpha) \text{ MAX}} \times 100$$

Percent optical purity is identical to the percent enantiomeric excess, and direct measure of asymmetric induction.

#### **Spectral Methods for Determination of Optical Purity (<sup>1</sup>H-NMR method)**

In the diastereomeric mixture resulted during the asymmetric synthesis, each isomer is capable of giving individual peaks in the <sup>1</sup>H-NMR spectrum. The chemical shift and the integration for a particular group are two conventional parameters for the determination of optical purity<sup>40</sup>. The ratio of the integration of the particular group in the diastereomer will give the percent enantiomeric excess.

The percent optical purity of (R) and (S) alanine has been determined from the <sup>1</sup>H-NMR spectrum of the intermediate diastereomer prepared from optically active amine and acetonitrile, which was further alkylated<sup>41,42</sup>. Two sets of doublet signals were referred to (S-R) and (S-S) isomeric methyl protons of the reaction intermediates. The lower doublet with larger area was assigned to the methyl protons of (R) isomer, from which (R)-alanine was obtained by hydrolysis and hydrogenolysis. The optical yield was determined by the ratio of the doublet signals of diastereomers. The optical

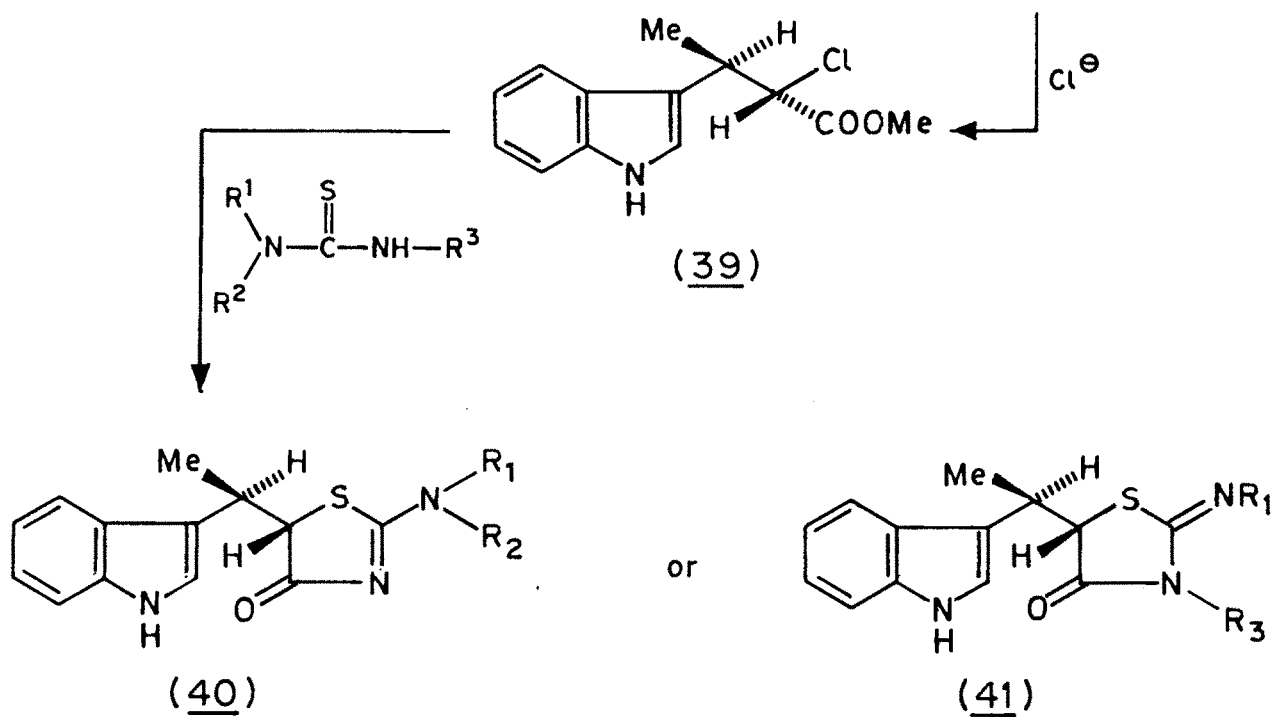
yield was determined by the  $^1\text{H-NMR}$  spectra agreed with those determined by specific rotation method<sup>43</sup>.

#### Aim and Scope of Work

Several antibiotic compounds such as penicillin and its derivatives have a thiazoline nucleus with adjacent  $\beta$ -lactam ring with chiral carbon atoms. A literature survey of some of the thiazoline and thiazolidine with chiral carbon atoms have shown that such compounds could be synthesised using methods involving asymmetric reagent and their structure-function studies have been reported e.g. Harnden M.R. et al.<sup>44</sup> have described the total synthesis of a series of thiazolinone and thiazolidinone analogues of the antibacterial oxazolinone antibiotic indolmycine. Here 2-amino thiazolinones (40a) to (40f) and 2-iminothiazolidinone (41) were prepared by nucleophilic displacement of 2-mesyloxy or chloro groups from methyl 3-(indol-3-yl)butyrate (39) with N-substituted thioureas (Chart 8-A). Butyrate (39) was derived from ( $\pm$ )- $\alpha$ -methyl indomycenate (37) which has (2R,3S) - (2S,3R) stereochemistry. Some of these compounds have shown antiviral activity.

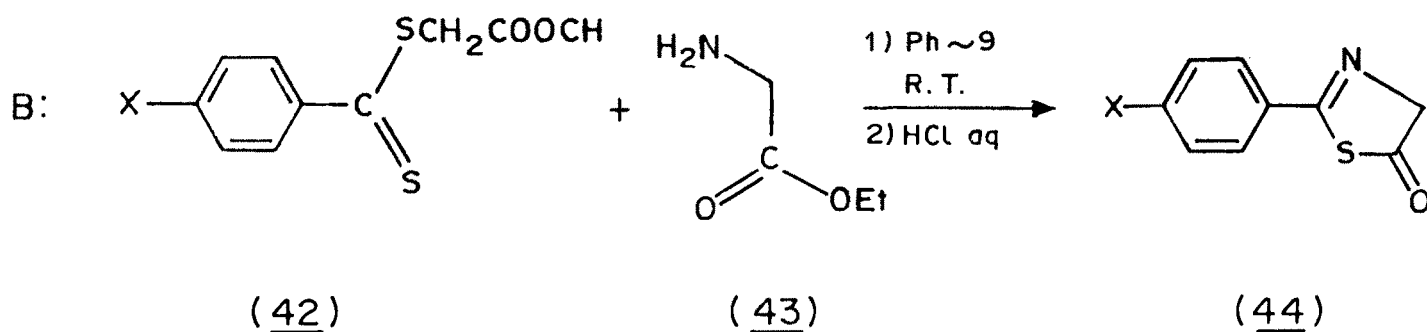
A convenient one step synthesis of 2-phenyl-2-thiazoline-5-ones (44) has been reported<sup>45</sup>. This compound is obtained by the treatment of carboxymethyl dithiobenzoate (42) with glycine ethyl ester (43) in weakly basic ethanol at room temperature (Chart 8-B).

By following this route and using optically active amino acids one can prepare optically active thiazolidinones. These examples of optically active thiazolidinones and thiazolinones prompted us



- a)  $R_1 = H; R_2 = H$
- b)  $R_1 = Me; R_2 = H$
- c)  $R_1 = Me; R_2 = Me$
- d)  $R_1 = Et; R_2 = H$
- e)  $R_1 = CH_2CH_2OH; R_2 = H$
- f)  $R_1 = CH_2CH_2N(Me)_2-HCl; R_2 = H$

$R_1 = Me; R_3 = Me$



to prepare optically active thiazolidinones and to test for biological activity.

---

---

SECTION-B

---

---



## PRESENT WORK (DISCUSSION)

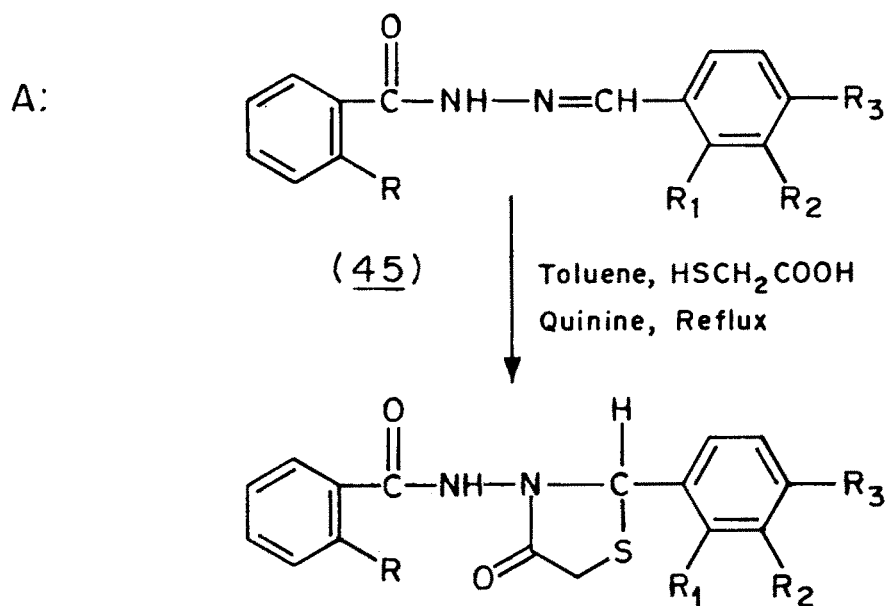
In thiazoline ring there are three carbon centres where asymmetry can be created and therefore  $2^3 = 8$  different stereoisomers can be formed of the same thiazoline. We have followed the simple route where SH-CH<sub>2</sub>COOH addition to the Schiff base gives the 4-thiazolidinone. As we selected thioglycolic acid for the addition only one asymmetric centre will be at the 2 position of the 4-thiazolidinone ring and hence only  $2^1 = 2$  isomers will be formed.

To get optically active thiazolidinones by asymmetric method, attempts are made to synthesize them by inducing the optical activity during the addition of thioglycolic acid to the optically inactive Schiff base in the presence of optically active catalyst such as quinine which acts as the optical activity inducing catalyst. By following this method number of optically active thiazolidinones were prepared (Chart 9A,B).

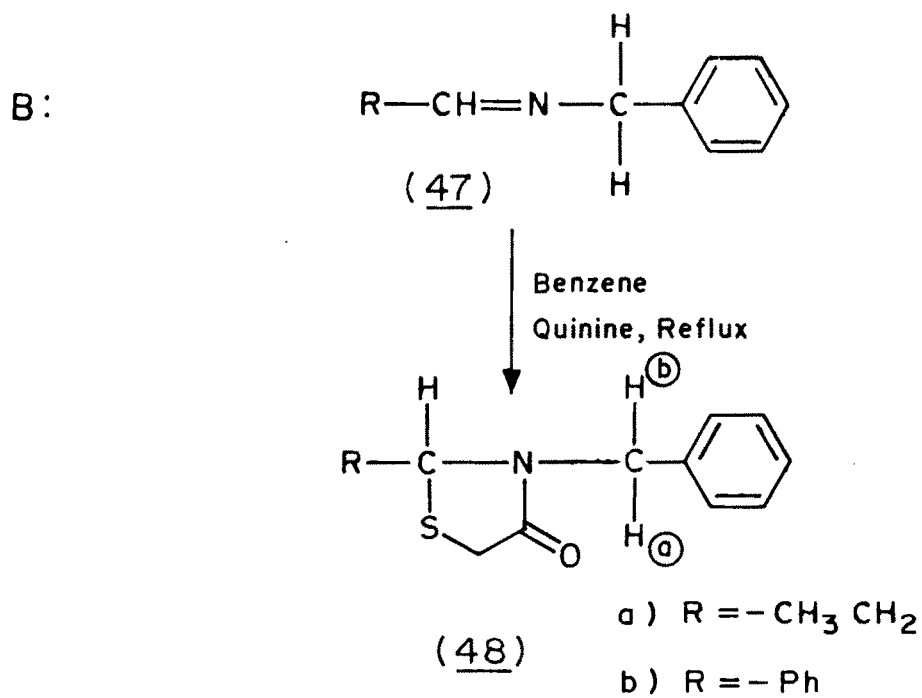
Here, a mixture of optically inactive Schiff base\* (45a-k) and thioglycolic acid in presence of 1/10th mole of quinine was refluxed in benzene/toluene for about 8 hrs and then worked up. In case of (46a-k) the solvent was distilled off and the obtained compound was extracted by benzene pet.ether (80:20) mixture to get rid of quinine. Then the compounds were purified by column chromatography on silica gel. In case of (48a-b) to remove quinine

---

\*Preparation and characterization of these Schiff bases has been discussed in Chapter II.



<u>R=H</u>			<u>R=NO<sub>2</sub></u>			
	R <sub>1</sub>	R <sub>2</sub>	R <sub>3</sub>	R <sub>1</sub>	R <sub>2</sub>	R <sub>3</sub>
(a)	H	H	H	(e)	H	H
(b)	H	H	OCH <sub>3</sub>	(f)	H	OCH <sub>3</sub>
(c)	H	OCH <sub>3</sub>	OH	(g)	OCH <sub>3</sub>	H
(d)	OCH <sub>3</sub>	H	H			
<u>R=Cl</u>			<u>R=OH</u>			
(h)	H	H	H	(j)	H	H
(i)	H	H	OCH <sub>3</sub>	(k)	H	OCH <sub>3</sub>



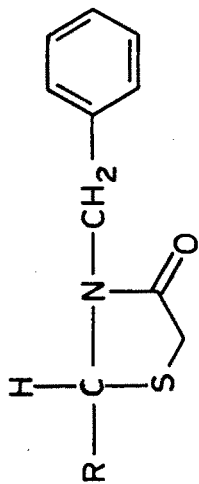
first benzene was removed from the reaction mixture and then compound was extracted with petroleum ether-benzene mixture (50:50). The quinine remained undissolved in the solvent mixture. Solvent was then removed and further purified by column chromatography. TLC showed the absence of quinine and single spot compound. These compounds were then characterised by spectral data and elemental data (Tables 1,2,3). Their optical rotations were taken (Table 1). We could not evaluate the percentage optical purity of these compounds with the help of NMR because of the low optical purity.

As we got low optical purity by the above mentioned route, we followed another route to prepare optically active thiazolidinones. We prepared optically active Schiff bases by condensing the aldehydes with dextro or levo methyl benzylamines. Schiff bases (49,50) (Chart 10) were then characterised by analytical and spectral data (Tables 4,5). NMRs of Schiff bases (49b) showed the doublet of methyl proton at  $1.5\delta$ , methine proton at  $4.4\delta$ , aromatic in the range of  $7.1$  to  $7.8\delta$  and benzylic proton (H-C=N) appeared at  $8.2\delta$ . IR showed the presence of C=N at  $1640\text{ cm}^{-1}$ . Similarly the Schiff base (49a) of propionaldehyde was prepared with d and l methyl benzylamine and characterized from its analytical and spectral data (Tables 4,5).

In order to compare Schiff bases of aldehydes and amines with those of aldehydes and  $\alpha$ -amino esters, we prepared the Schiff bases of propanaldehyde and benzaldehyde with l-phenyl-alanine methyl ester. These Schiff bases (50) were then characterised with

TABLE I - ANALYTICAL DATA, m.ps. YIELDS AND OPTICAL ROTATION OF SUBSTITUTED 4-THIAZOLIDINONES

Compd. No.	Chemical structure (46 a-k)			Elemental analysis*			M.p. °C	Yield %	Optical rotation **
	R	R <sub>1</sub>	R <sub>2</sub>	R <sub>3</sub>	Found	N			
(46a)	H	H	H	H	64.12 (64.42)	9.23 (9.39)	176	40.5	+2.2
(46b)	H	H	H	OCH <sub>3</sub>	62.21 (62.19)	9.35 (9.25)	158.5	45	+1.2
(46c)	H	H	OCH <sub>3</sub>	OH	59.2 (59.3)	8.11 (8.14)	184	35	+1.3
(46d)	H	OCH <sub>3</sub>	H	H	62.31 (62.19)	8.41 (8.5)	166-68	34	+1.1
(46e)	NO <sub>2</sub>	H	H	H	55.81 (55.97)	12.5 (12.24)	245	55	+1.9
(46f)	NO <sub>2</sub>	H	H	OCH <sub>3</sub>	54.41 (54.69)	11.34 (11.26)	175-77	52	+1.6
(46g)	NO <sub>2</sub>	OCH <sub>3</sub>	H	H	54.20 (54.69)	11.12 (11.26)	220-22	30	+0.6
(46h)	Cl	H	H	H	58.21 (58.09)	8.62 (8.8)	208-9	35	+1.5
(46i)	Cl	H	H	OCH <sub>3</sub>	56.32 (56.35)	7.89 (7.73)	202-3	43	+0.7
(46j)	OH	H	H	H	61.3 (61.14)	8.88 (8.91)	201-3	35	+0.7
(46k)	OH	H	H	OCH <sub>3</sub>	59.31 (59.47)	8.3 (8.16)	245-48	35	+0.4
(48a)	CH <sub>3</sub> CH <sub>2</sub>	-	-	-	63.31 (63.15)	6.48 (6.69)	-	-	+1.2



(48 a, b)

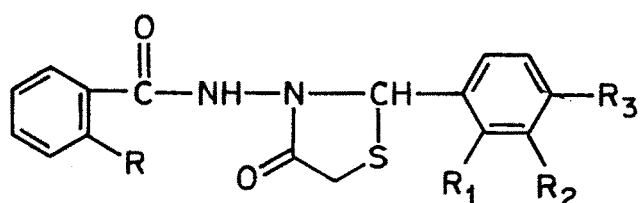
TABLE I (Contd.)

(48b)	Ph	-	-	70.21 (70.03)	5.98 (5.8)	5.32 (5.44)	136-138	-	-3.35
-------	----	---	---	------------------	---------------	----------------	---------	---	-------

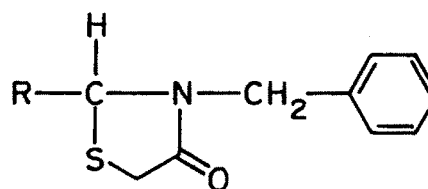
\*Figures in the brackets indicate analysis required.

\*\*Specific rotations of above compounds measured in methanol (conc. 0.1N).

TABLE 2 - IR DATA OF SUBSTITUTED 4-THIAZOLIDINONES (IN NUJOL)

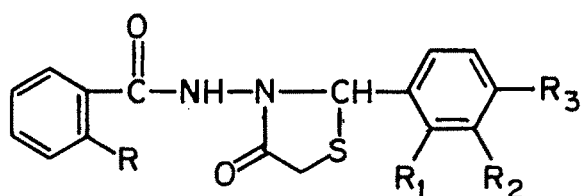


(46)

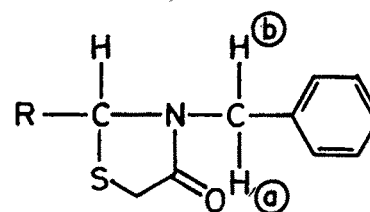


(48)

Compd. No.	R	R <sub>1</sub>	R <sub>2</sub>	R <sub>3</sub>	Amide C=O- cm <sup>-1</sup>	Ring C=O- cm <sup>-1</sup>	NH cm <sup>-1</sup>
(46a)	H	H	H	H	1645	1710	3225
(46b)	H	H	H	OCH <sub>3</sub>	1645	1720	3250
(46c)	H	H	OCH <sub>3</sub>	OH	1650	1670	3150
(46e)	NO <sub>2</sub>	H	H	H	1640	1700	3250
(46f)	NO <sub>2</sub>	H	H	OCH <sub>3</sub>	1650	1720	3280
(46g)	NO <sub>2</sub>	OCH <sub>3</sub>	H	H	1660	1690	3200
(46h)	Cl	H	H	H	1640	1710	3200
(46i)	Cl	H	H	OCH <sub>3</sub>	1645	1710	3245
(46j)	OH	H	H	H	1640	1720	3250
(48a)	CH <sub>3</sub> CH <sub>2</sub> -	-	-	-	-	1670	-
(48b)	Ph	-	-	-	-	1670	-

TABLE 3 - NMR DATA OF SUBSTITUTED 4-THIAZOLIDINONES\* IN DMSO (d<sub>6</sub>)

(46)



(48)

a) R=CH<sub>3</sub>CH<sub>2</sub>

b) R=Ph

Compd. No.	R	R <sub>1</sub>	R <sub>2</sub>	R <sub>3</sub>	SCH <sub>2</sub> (δ)	SCH (δ)	OCH <sub>3</sub> (δ)	Aromatic (δ)	NH (δ)
(46a)	H	H	H	H	3.88	5.75	-	7.5-8	10.60
(46b)	H	H	H	OCH <sub>3</sub>	3.85	5.83	3.7	6.8-7.9	10.60
(46c)	H	H	OCH <sub>3</sub>	OH	3.65	5.72	3.75	6.7-7.8	10.55
(46e)	NO <sub>2</sub>	H	H	H	3.9	5.85	-	7.3-8.5 to 8.2	10.81
(46f)	NO <sub>2</sub>	H	H	OCH <sub>3</sub>	3.85	5.72	3.75	6.7-8.21	10.95
(46g)	NO <sub>2</sub>	OCH <sub>3</sub>	H	H	3.6	5.7	3.73	6.68-7.8	10.5
(46j)	Cl	H	H	H	3.81	6.23	-	6.9-7.6	10.8
(46k)	Cl	H	H	OCH <sub>3</sub>	3.71	6.2	3.73	6.8-7.8	10.9

\*NMRs of (48a) and (48b) have been found identical to that of (10la) and (10lb) in the Chapter II and they have been discussed there thoroughly.

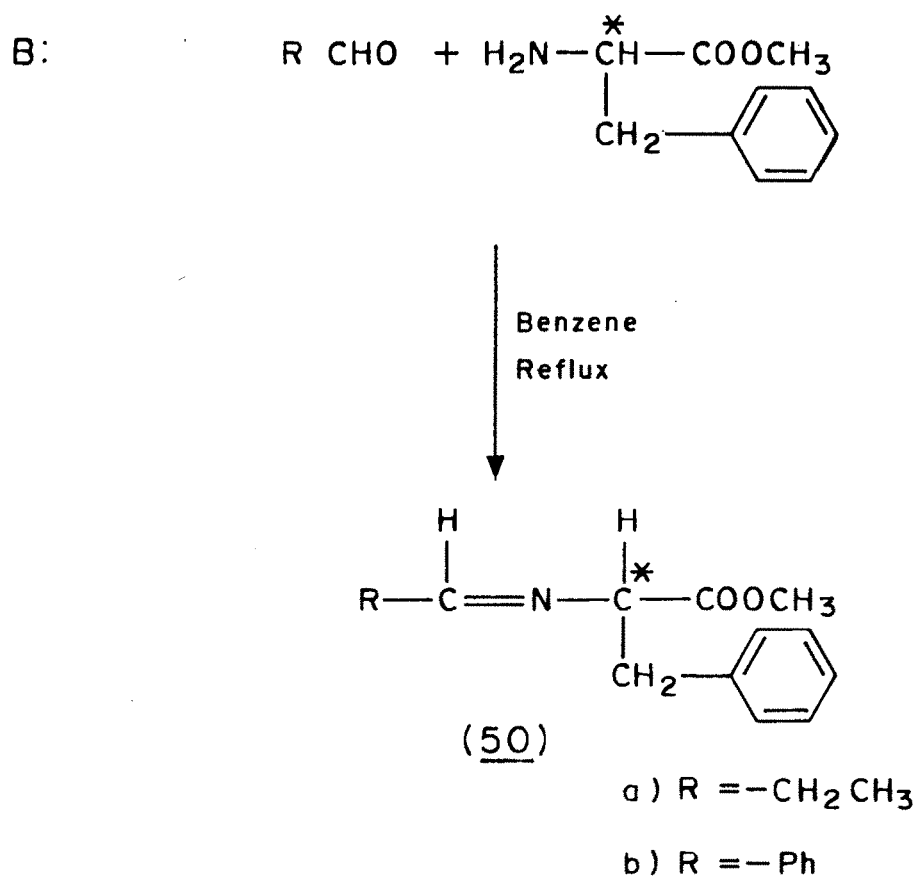
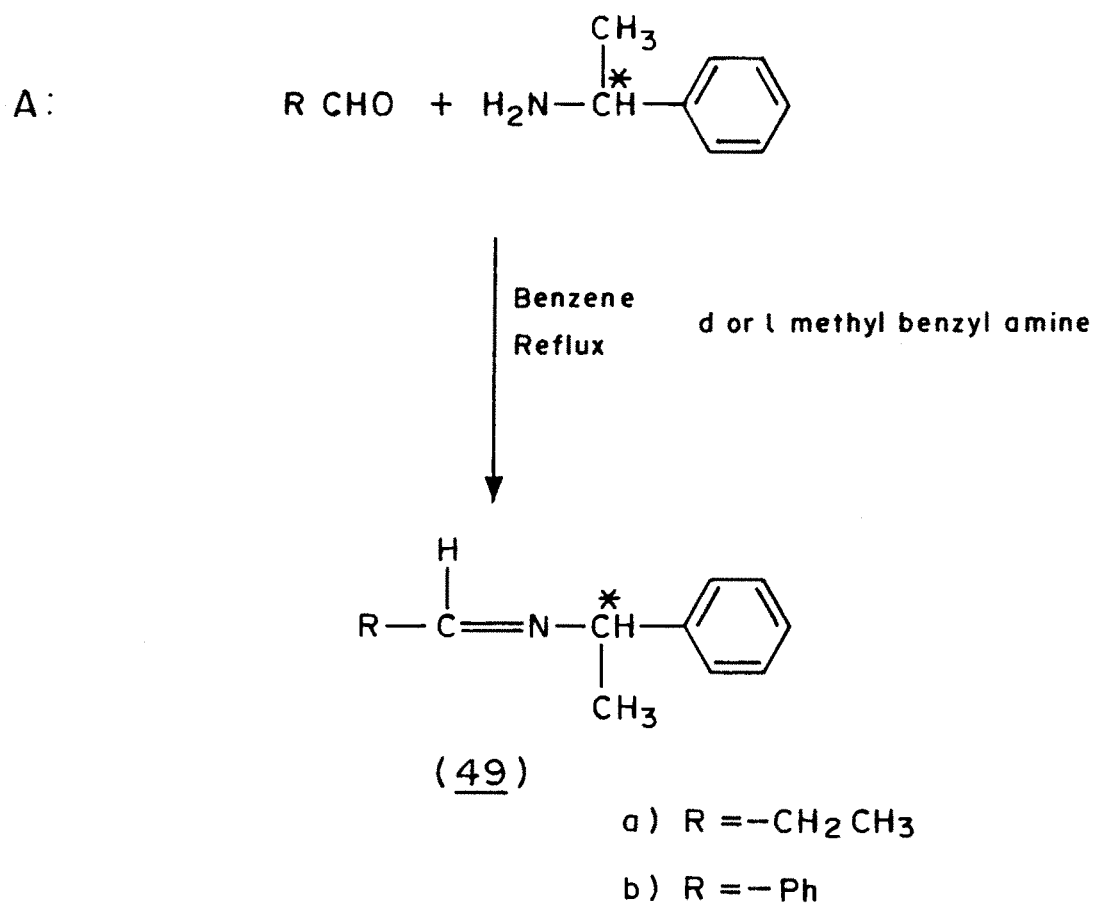
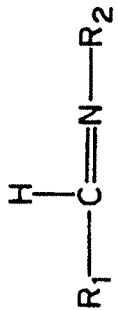




TABLE 4 - NMR (CDCl<sub>3</sub>) AND IR (NUJOL) OF OPTICALLY ACTIVE SCHIFF BASES (49) AND (50)



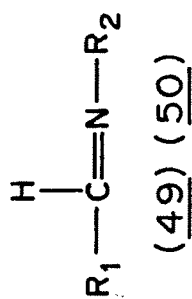
(49) (50)

Compd. No.	R <sub>1</sub>	R <sub>2</sub>	CH (δ)	CH <sub>3</sub> (δ)	R <sub>1</sub> CH <sub>2</sub> (δ)	Ph (δ)	CH <sub>3</sub> (δ)	R <sub>2</sub> CH <sub>2</sub> (δ)	CH (δ)	OCH <sub>3</sub> (δ)	Ph (δ)	IR <sup>-1</sup> cm <sup>-1</sup>
(40a)	CH <sub>3</sub> CH <sub>2</sub>	PhCHCH <sub>3</sub>	7.7	1.1	2.1	-	1.4	-	4.1	-	7.07	1645
(49b) <sub>d</sub>	Ph	PhCHCH <sub>3</sub>	8.2	-	-	7.1-7.8	1.5	-	4.4	-	7.1-7.8	1635
(49b) <sub>l</sub>	Ph	PhCHCH <sub>3</sub>	8.2	-	-	7.1-7.8	1.5	-	4.4	-	7.1-7.8	1640
(50a)	CH <sub>3</sub> CH <sub>2</sub>	PhCH <sub>2</sub> CHCOO CH <sub>3</sub>	7.48	1.0	2.17	-	-	3.1	3.9	3.57	7.0	1640(C=N) 1730 (Ester C=O)
(50b)	Ph	PhCH <sub>2</sub> CH COOCH <sub>3</sub>	7.9	-	-	7-7.5	-	3.25	4.125	3.7	7.775	1640(C=N) 1730 (Ester C=O)

\*<sub>d</sub>(49b) is the Schiff base of benzaldehyde and -d-methylbenzylamine.

\*<sub>l</sub>(49b) is the Schiff base of benzaldehyde and -l-methylbenzylamine.

TABLE 5 - ANALYTICAL DATA, YIELDS AND OPTICAL ROTATION OF OPTICALLY ACTIVE SCHIFF BASES (49) (50)



Compd. No.	R <sub>1</sub>	R <sub>2</sub>	Analytical data			Yield %	Optical rotation [α] <sup>*</sup>
			C%	H%	N%		
(49a)	CH <sub>3</sub> CH <sub>2</sub>	PhCH-CH <sub>3</sub>	80.32 (80.49)	9.01 (9.15)	10.21 (10.37)	70	+83.5
(49b) d	Ph	PhCHCH <sub>3</sub>	86.31 (86.12)	7.29 (7.17)	6.49 (6.69)	78	-52
(49b) l	Ph	PhCHCH <sub>3</sub>	86.18 (86.12)	7.28 (7.17)	6.75 (6.69)	80	+51.54
(50a)	CH <sub>3</sub> CH <sub>2</sub>	PhCH <sub>2</sub> CHCOOCH <sub>3</sub>	71.08 (71.23)	7.62 (7.76)	6.31 (6.39)	75	-1.3 (-31.7) 29.7 (-103.2)
(50b)	Ph	PhCH <sub>2</sub> CHCOOCH <sub>3</sub>	76.31 (76.4)	6.32 (6.37)	15.21 (5.24)	89	

\*Specific rotations of above compounds measured in methanol (conc. 0.1N).

their analytical and spectral data (Tables 4,5).

NMR of Schiff base (50b) (Figure 2) showed the presence of  $-OCH_3$  at  $3.7\delta$  (s), benzylic protons at  $3.25\delta$  (m),  $Ph-CH_2-\underline{CH}$  at  $4.125\delta$  (m) aromatic protons in the range of  $7 - 7.75\delta$  and  $Ph-\underline{CH}$  at  $7.9\delta$  (s).

Similarly the NMR of propanaldehyde with phenylalaninemethyl ester has given appropriate signals (Table 4).

As these Schiff bases gave comparatively low optical rotation, we prepared Schiff bases by other method. In this method a mixture of aldehyde and amine was stirred together at room temperature in benzene in presence of alumina for about 8 hrs. These Schiff bases have shown high optical rotation. Their analytical and spectral data are same as that of Schiff bases prepared in absence of alumina.

The Schiff bases (49,50) (Chart II) were then converted to corresponding 4-thiazolidinones (51,52) by refluxing them with thioglycolic acid in benzene using Dean-Stark apparatus to remove water formed during the reaction azeotropically.

Thiazolidinones obtained were then characterised by spectral data and analytical data (Table 6) & (Table 7) respectively. The NMR of (51a) (Figure 3) showed two sets of doublets for methyl proton at  $1.1$  and  $1.7\delta$ . Their proportion is 55:45. These two sets of doublets must be due to d-d and d-l products. As we started with d-methylbenzylamine, doublet at  $1.7\delta$  (55%) has been assigned to d-d isomer and doublet at  $1.1$  (45%) has been assigned to d-l isomer.

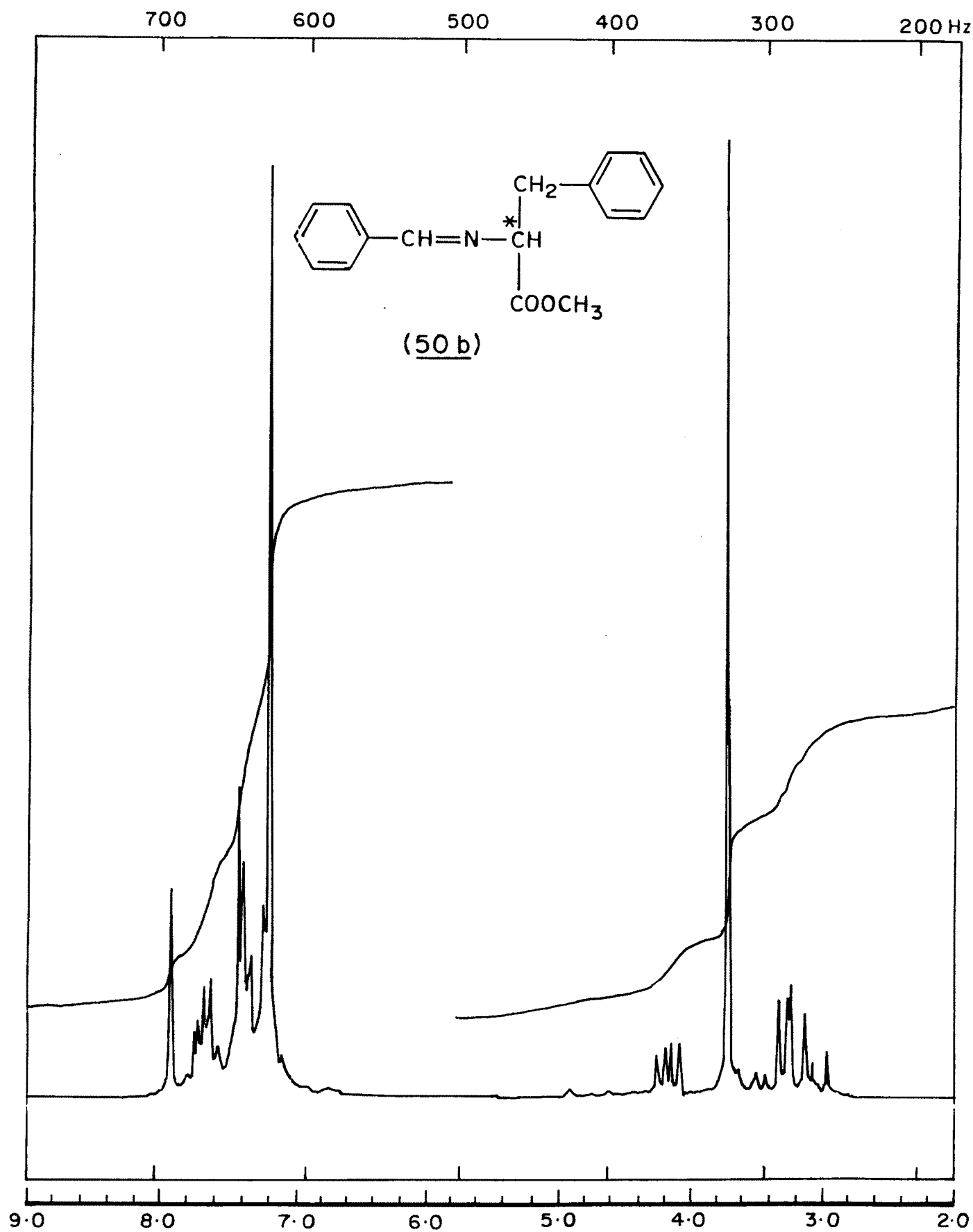


FIGURE 2

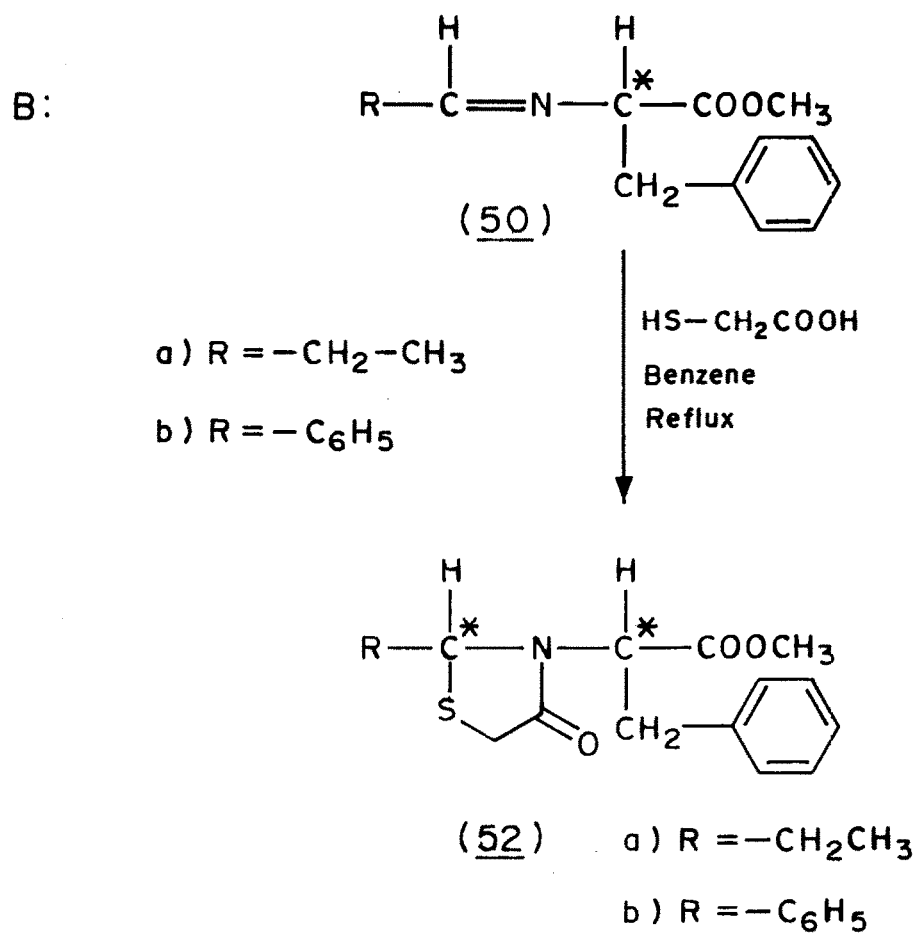
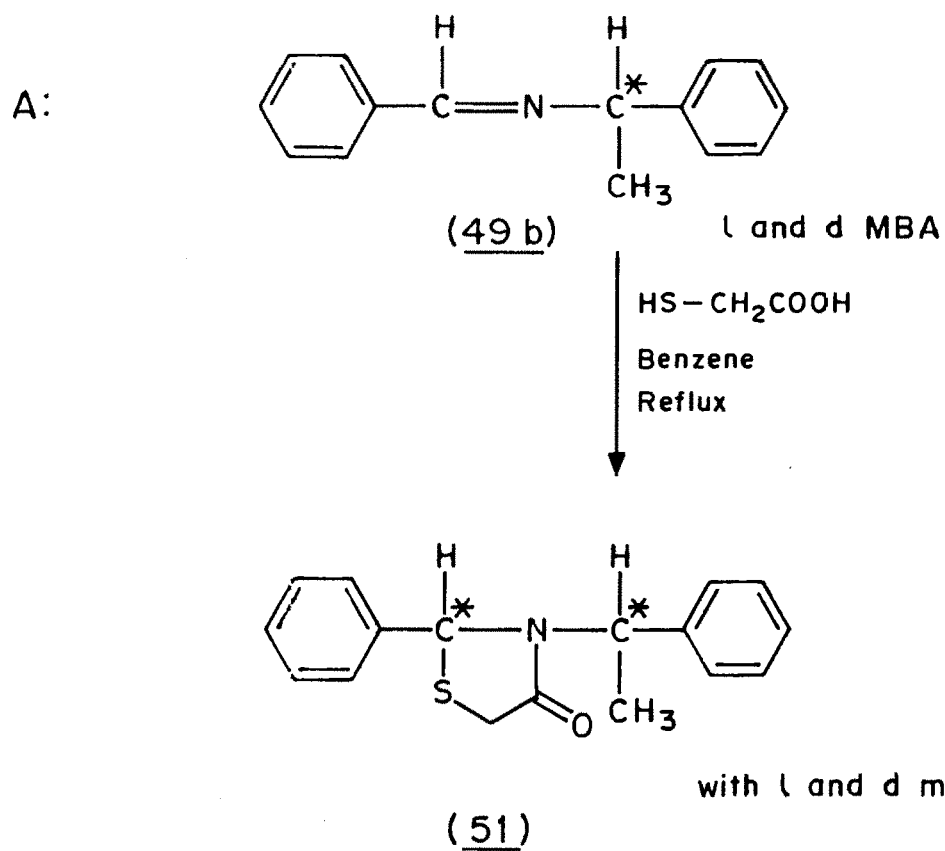
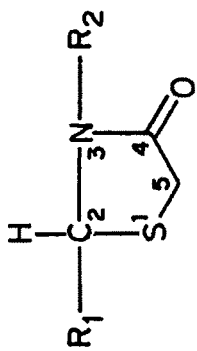


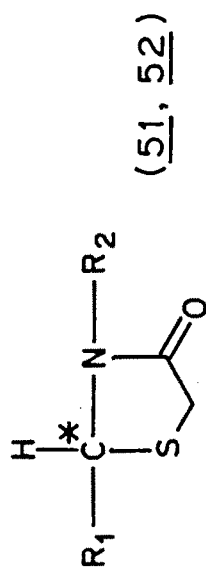
TABLE 6 - NMR DATA OF OPTICALLY ACTIVE SUBSTITUTED 4-THIAZOLIDINONES IN CDCl<sub>3</sub>



(51, 52)

Compd. No.	R <sub>1</sub>	R <sub>2</sub>	CH <sub>2</sub> 2 (δ)		CH <sub>2</sub> 5 (δ)		Aromatic (δ)	R <sub>1</sub>		R <sub>2</sub>		CH <sub>2</sub> (δ)	CH (δ)	IR in (Nujol)
			CH <sub>3</sub> (δ)	CH <sub>2</sub> (δ)	CH <sub>3</sub> (δ)	CH <sub>2</sub> (δ)		OCH <sub>3</sub> (δ)	CH <sub>3</sub> (δ)	CH <sub>2</sub> (δ)				
(51a) d	Ph	PhCHCH <sub>3</sub>	5.15 5.6	3.75	7 to 7.4	-	-	-	1.1 1.7	5 5.6	-	-	1670 (Ring C=O)	
(51b) I	Ph	PhCHCH <sub>3</sub>	5.1	3.4-3.7	7 to 7.5	-	-	1.25 1.6	5.1	-	-	-	1670 (Ring C=O)	
(52a)	CH <sub>3</sub> CH <sub>2</sub>	PhCH <sub>2</sub> CH-COOCH <sub>3</sub>	4.8 5.0	3.72	6.85-7.3	0.88 1.2	2.0 3.1	3.7	3.9 4.15	3.8	1675 (Ring C=O) 1730 (Ester CO)	-	-	
(52b)	Ph	PhCH <sub>2</sub> CH-COOCH <sub>3</sub>	4.4 5.6	3.56 3.7	6.87-7.4	-	-	3.74	3.94 4.16	3.2 3.4	1680 (Ring C=O) 1745 (Ester C=O)	-	-	

TABLE 7 - ANALYTICAL DATA, YIELD AND OPTICAL ROTATION OF OPTICALLY ACTIVE SUBSTITUTED 4-THIAZOLIDONES



Compd. No.	R <sub>1</sub>	R <sub>2</sub>	Analytical data*			Yield %	Optical rotation** [α]
			C	H	N		
(51a) d	Ph	PhCHCH <sub>3</sub>	72.18 (72.08)	6.38 (6.00)	4.70 (4.95)	71	-3.2
(51b) l	Ph	PhCHCH <sub>3</sub>	72.82 (72.8)	5.61 (6.00)	4.18 (4.95)	70	+29
(52a)	CH <sub>3</sub> CH <sub>2</sub>	PhCH <sub>2</sub> CH COOCH <sub>3</sub>	61.21 (61.43)	6.31 (6.48)	4.61 (4.78)	60	-4.8 (-7.76)
(52b)	Ph	PhCH <sub>2</sub> CHCOOCH <sub>3</sub>	66.67 (66.8)	5.37 (5.57)	4.23 (4.10)	75	-6.4 (-10.8)

\*Figures in the brackets indicate required analysis.

\*\*Figures in the brackets indicate the optical rotations of the 4-thiazolidones prepared from Schiff bases prepared in presence of alumina. Specific rotations of above compounds measured in methanol (conc. 0.1N).

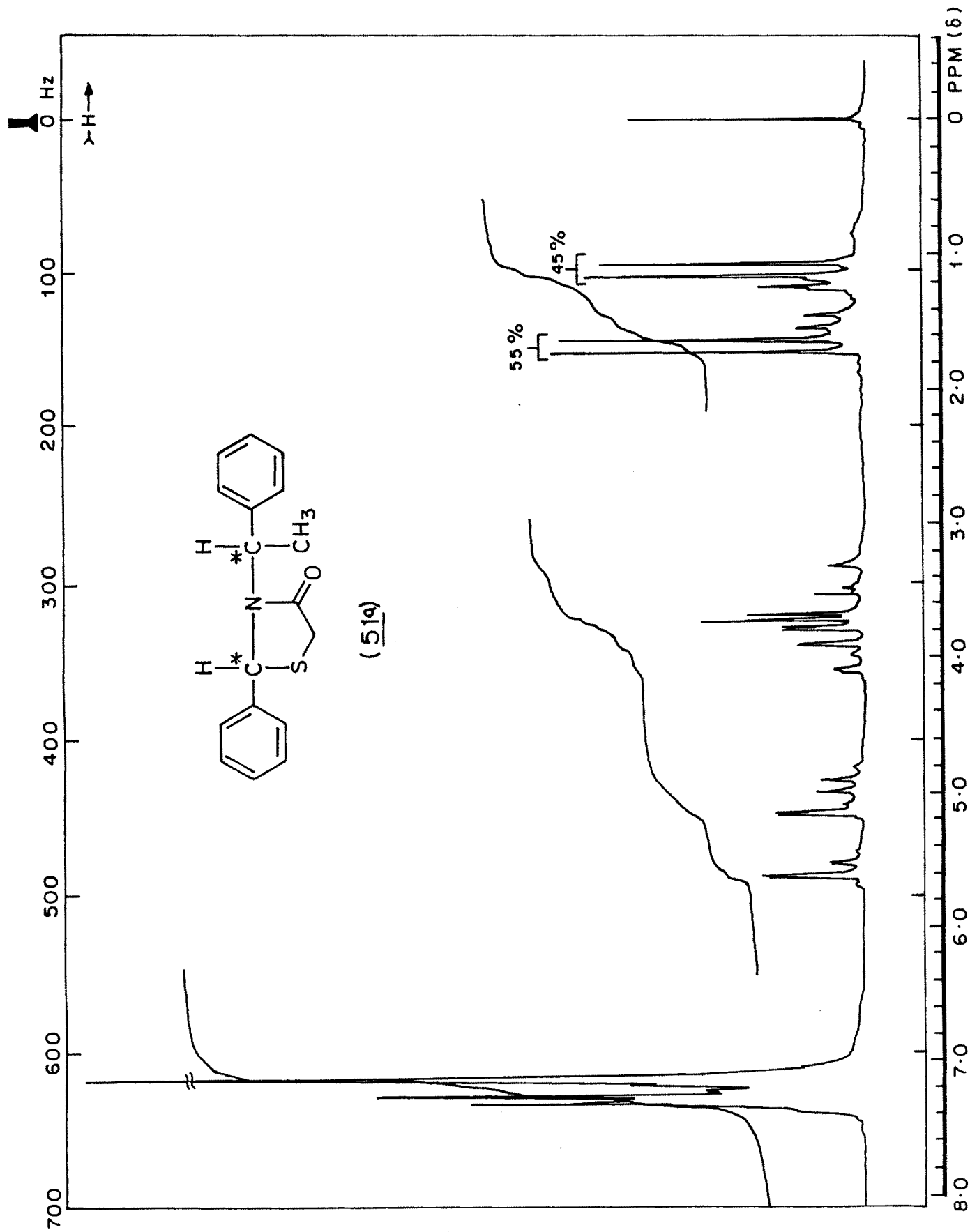


FIGURE 3



Similarly, S-CH proton also has shown two sets of doublets at 5.15 and 5.6  $\delta$ . Their ratio is also 55:45. They are also corresponding to d-d and d-l isomers. Methine proton from d-methylbenzylamine moiety has also shown two sets of quartets at 5  $\delta$  and 5.6  $\delta$ . They are also of d-d and d-l products. Thus from the NMR, it shows that d-d isomer has been formed in 10% excess. Thus here asymmetric addition has taken place where d-d isomer has 10% enantiomeric excess over the d-l isomer.

The thiazolidinone (51b) prepared from benzaldehyde and l-methylbenzylamine showed two sets of methyl doublets at 1.25  $\delta$  and 1.6  $\delta$  in the ratio of 55:45. These two sets must be due to l-l and l-d products. As we started with l-methylbenzylamine doublet at 1.25  $\delta$  (55%) has been assigned to l-l isomer and doublet at 1.6  $\delta$  (45%) has been assigned to l-d isomer.  $\underline{\text{S}}\text{CH}_2$  has appeared as multiplet in the range of 3.4 to 3.7  $\delta$ . But S-CH and methine in the methylbenzylamine have not resolved properly. Methine has shown only one quartet centered at 5.1  $\delta$  and S-CH has also shown its appearance in the same region (integration for 2 protons). Aromatic protons have appeared in the range of 7.0 to 7.5  $\delta$ .

Similarly the thiazolidinone (52b) (Figure 4) has shown the peaks in the NMR for two compounds l-land l-d. Benzylic proton has appeared as multiplet in the range of 3.2 to 3.4  $\delta$ . S-CH<sub>2</sub> has shown two peaks of doublets 3.56  $\delta$  and 3.67  $\delta$ , methoxy at 3.74  $\delta$ . Methine proton from phenylalanine moiety has shown two sets of triplets at 3.94  $\delta$  and 4.16  $\delta$  and S-CH proton has shown its

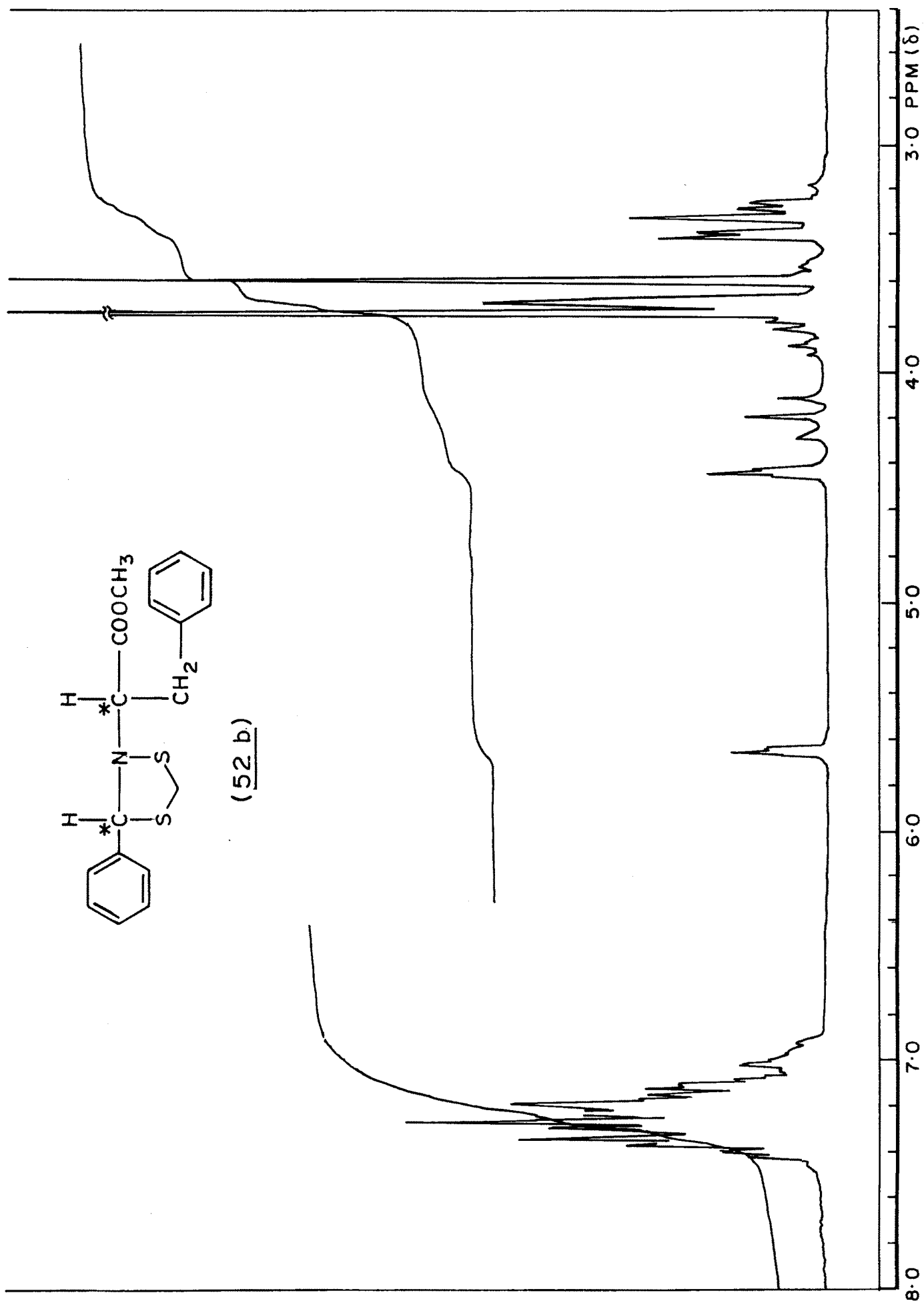


FIGURE 4

appearance at 4.4 $\delta$  and 5.6 $\delta$ . These two peaks of S-CH are in the proportion of 55:45. The peak at 4.5 $\delta$  (55%) must be due to l-l as we started with l-phenylalanine. Aromatic protons have shown their appearance in the range of 6.87 $\delta$  to 7.42 $\delta$ . Thus on the basis of NMR, we can state that the two diastereoisomers are in the proportion of 55:45 i.e. l-l isomer is in 10% excess over l-d isomer.

The thiazolidinone (52a) has shown two sets of triplets at 0.88 and 1.2 $\delta$ . Their proportion is 43:57 respectively. Triplet at 1.2 $\delta$  has been assigned to l-l isomer, while triplet at 0.88 $\delta$  has been assigned to l-d isomer. Benzylic proton appeared at 3.8 $\delta$  (multiplet), methylene proton at 2 $\delta$ , OCH<sub>3</sub> at 3.7 $\delta$ , S-CH<sub>2</sub> at 3.72 $\delta$ . Methine of phenylalanine appeared at 4.15 $\delta$  while S-CH at 4.8 $\delta$  and 5.0 $\delta$ . Aromatic protons appeared at 6.85 to 7.3 $\delta$ . On the basis of NMR it can be stated that l-l isomer has got 14% enantiomeric excess over l-d isomer.

---

SECTION-C

---

## EXPERIMENTAL

Experimental part of the schiff bases used for the syntheses of 4-thiazolidinones is given in Chapter II. General procedure for the synthesis of optically active 4-thiazolidinones is given below. The data of individual compound is summarised in Tables 1 to 7.

### Syntheses of optically active substituted 4-thiazolidinones (46)

A mixture of schiff bases (45) (0.01 mole), thioglycolic acid (0.011 mole) and quinine (0.001 mole) in toluene (150 ml) was refluxed for 8 hrs. Solvent was removed by distillation. Residual semisolid was suspended in benzene-pet.ether mixture (80:20) and stirred for 15 minutes to dissolve quinine in the solvent mixture. White solid obtained by filtration was then crystallized from methanol. The m.p. yield and specific rotation of individual compound are given in Table 1. IR and NMR data are reported in Tables 2 and 3 respectively.

### Syntheses of Optically active substituted 4-thiazolidinones (48)

A mixture of schiff base (47) (0.01 mole), thioglycolic acid (0.011 mole) and quinine (0.001 mole) in benzene (150 ml) was refluxed for 8 hrs. Solvent was removed by distillation. Residual thick liquid was extracted with benzene:pet.ether mixture (50:50) three times to get rid of quinine added. These extracts combined together were then washed with sodium bicarbonate solution (10%) and water. Dried over sodium sulphate and solvent was distilled off. TLC of the residue showed the absence of schiff base but some impurity at the bottom. Therefore, it was purified by column chromatography on silica gel using benzene as eluent.

Compound (48a) was further purified by distilling it in the bulb-tube under vacuum (b.p. 130-135°C/15 mm).

Compound (48b) crystallized from methanol gave white needle-shape crystals, m.p. 136-138°.

The analytical data, yield and specific rotation of individual compound is given in Table 1. IR and NMR data are reported in Tables 2 and 3 respectively.

#### **Synthesis of Optically active substituted Schiff bases (49,50)**

A mixture of aldehyde (0.02 mole) and  $\alpha$ -methylbenzylamine (0.02 mole) was refluxed in benzene for 10 hrs using Dean-Stark apparatus to remove water formed during the reaction azeotropically. Solvent was removed by distillation. TLC showed the presence of aldehyde and  $\alpha$ -methylbenzylamine. These schiff bases (49) were then purified by distillation in the bulb-tube under vacuum. First fraction which distilled out at 85-100°C/15 mm was the mixture of aldehyde and  $\alpha$ -methylbenzylamine. Second fraction was collected above 120°C/15mm. The analytical data, yield and optical rotation of individual compound are given in Table 5. IR and NMR data are reported in Table 4.

#### **Synthesis of Optically active 4-thiazolidinones (51,52)**

A mixture of schiff base (49) (0.02 mole) and thioglycolic acid (0.022 mole) was refluxed in benzene for 8 hrs. Reaction mixture was cooled and washed by sodium bicarbonate solution (10%). Dried over sodium sulphate and solvent was removed. Residual thick oil was purified by distillation in the bulb-tube under vacuum (b.p. in the range

of 135-150°C/3 mm). The analytical data, yield and optical rotation of individual compound are given in Table 7 and IR, NMR data are given in Table 6.

## REFERENCES

1. J.D. Morrison and H.S.Mosher  
Asymmetric Organic Reactions, Prentice Hall, Englewood-Cliffs  
N.J. (1972).
2. E.A.Bell and D.I.John  
Int. Rev.Sci.Org.Chem.Series II, 6 (1976).
3. J.W.Apsimon and R.P.Sequin, Rev.  
Tetrahedron **35**, 2797 (1979).
4. E.L.Eliel  
Rev. Tetrahedron **30**,1503 (1974).
5. D.Valentine, Jr. and J.W.Scott  
Rev. Synthesis,329 (1978).
6. Hans Wynberg  
Rev. Reuceil,**100**, 393 (1981).
7. K.K.Babievskii and V.L.Latov  
Russ. Chem.Rev., **38(6)**, 456 (1969).
8. T.D. Inch  
Rev. Synthesis, 466 (1970).
9. L.Velluz, J.Valls and J. Mathieu  
Rev. Angew.Chem. Int. Ed., **6**, 778 (1967).
10. A. Horeau and J.P.Guette  
Tetrahedron 1923 (1974).
11. K.Mislow  
Introduction to Stereochemistry, Benjamin N.Y. (1965).
12. A.I.Meyers,G.Khaus and K. Kamata  
J.Am.Chem.Soc., **96**, 368 (1974).
13. W.A.Szabo and H.T.Lee  
Aldrichima Acta, **13(1)**, 13 (1980) and references cited therein.
14. R.Noyori, I. Tomino and Y. Tanimoto  
J.Am.Chem.Soc., **101**, 3123 (1979).
15. R.S. Brinkmeyer and V.P. Kapoor  
J. Am. Chem. Soc., **99**, 8339 (1977).
16. L. Horner, H.Winkler, A.Ropp and A.Mentrup  
Tetrahedron Lett. 161 (1961).





17. H.B.Kagan et al.  
Pure and Appl.Chem.**43**, 401 (1975).
18. M. Kumuda, K. Yamamoto and T. Hayashi  
Pure and Appl.Chem., **112**, 253 (1976).
19. T. Isoda, A. Ichikawa and T.Shimamoto  
J. Sci.Res. Inst., **34**, 143 (1958).
20. S. Akabori and Y. Izumi  
Nature, **178**, 323 (1956).
21. H.S.Mosher and S. Yamaguchi  
J. Org.Chem., **38(10)**, 1870 (1973).
22. S.S. Jew,S.T.Tarashima and K. Koga  
Tetrahedron **35**, 2337 (1979).
23. B.W. Bycroft and G.P.Lee  
Chem.Comm., 998 (1975).
24. W.A. Blatter and J.R. Knowles  
J. Org.Chem., **38(10)**, 1870 (1973).
25. J.P.H.Verheyden et al.  
Pure and Appl.Chem., **50**, 1363 (1978).
26. M.M. Joullie, P.C.Wang and J.E.Semple  
J. Am.Chem.Soc., **102**, 881 (1980).
27. A.A.Bothner-By  
J. Am. Chem.Soc., **73**, 846 (1951).
28. R. Annunziata, M.Cinquini and F.Cozzi  
Synthesis, 535 (1979).
29. T. Ogura, M. Yamashita and G.Tsuchinashi  
Tetrahedron Lett., 759 (1976).
30. R.Bentley  
Molecular Asymmetry in Biology  
VJ, Academic Press, N.Y. (1970).
31. A.J. Irwin and G.B.Jones  
J. Am.Chem.Soc., **99**, 556 (1977).
32. H.Takahashi, K.Tomita and H. Otomasu  
J.Chem.Soc. Chem.Comm., p.668 (1979).
33. U.Schollkopf et al.  
Angew Chemie Int. Ed., **17**, 117 (1978).

34. U.Schollkopf et al.  
Angew.Chemie Int. Ed., **18**, 863 (1979).
35. B.Bosnich and P.B.Mackenzie  
Pure and Appl.Chem., **54**, 189 (1982).
36. K.B.Sharpless and T. Katsuki  
J. Am.Chem.Soc., **102**, 5974 (1980).
37. K.Achiwa and T.Soga  
Tetrahedron Lett., **13**, 1119 (1978).
38. Germ. Patent 27,18,533 (1977).  
Chem.Tech. p. 446 (1978).
39. M.Raban and K.Mislow  
Topics in Stereochemistry, Vol.2, Interscience Publishers, p.199 (1967).
40. M.Raban and K.Mislow  
Tetrahedron Lett. 4249 (1965).
41. H. Gerlach  
Helv. Chim. Acta, **49**, 2481 (1966).
42. K. Harada, M.Tamura and S.Suzuki  
Bull.Chem.Soc. Jap. **51**, 2171 (1978).
43. J.C.Fiaud and A. Horeace  
Tetrahedron Lett., **25**, 2565 (1972).
44. M.R.Harden, S. Bailey, M.R.Boyd, D.R.Taylor and N.D.Wright  
J.Med.Chem., **21(1)**, 82 (1978).
45. Org. Preparations and Proc. Int. **13(360)**, 1981.